

FAB RICA TE

 **UCLPRESS**

FABIO GRAMAZIO, MATTHIAS KOHLER, SILKE LANGENBERG (eds.)

FA
B
RICA
TE



**FABRICATE:
NEGOTIATING DESIGN & MAKING**

Fabio Gramazio, Matthias Kohler, Silke Langenberg (eds.)

6–7

FOREWORD BY THE EDITORS

Fabio Gramazio, Matthias Kohler, Silke Langenberg

8–9

**FOREWORD BY THE INITIATORS OF
THE FABRICATE CONFERENCE SERIES**

Bob Sheil, Ruairi Glynn

CHALLENGING THE THRESHOLDS

12–21

MARIO CARPO

IN CONVERSATION WITH MATTHIAS KOHLER

22–29

RIBBED TILE VAULTING:

**INNOVATION THROUGH TWO DESIGN-BUILD
WORKSHOPS**

Philippe Block, Melonie Bayl-Smith, Tim Schork,
James Bellamy, Dave Pigram

30–35

WHO'S AFRAID OF FABRICATION?

WHY TEACH DIGITAL FABRICATION NOW?

Brennan Buck

36–43

**TOPO-FAÇADE: ENVELOPE DESIGN AND
FABRICATION PLANNING USING TOPOLOGICAL
MESH REPRESENTATIONS**

Gustav Fagerström, Erik Verboon, Robert Aish

44–51

BALANCING COMPLEXITY AND SIMPLICITY

Jonathan Rabagliati, Clemens Huber, Dieter Linke

52–59

BRIDGING THE GAP FROM CAD TO CAM:

**CONCEPTS, CAVEATS AND A NEW GRASSHOPPER
PLUG-IN**

Hanno Stehling, Fabian Scheurer, Jean Roulier

60–67

BUILDING SIMPLEXITY:

**GOLDEN MOON, 2012 MID-AUTUMN FESTIVAL
LANTERN WONDERLAND**

Kristof Crolla

68–75

THE LEADENHALL BUILDING:

**DESIGN FOR FABRICATION-DIGITAL WORKFLOW
AND DOWNSTREAM FABRICATION SYSTEM**

Dirk Krolkowski, Damian Eley

76–83

FABRICATING ARCHITECTURAL VOLUME:

**STEREOTOMIC INVESTIGATIONS IN ROBOTIC
CRAFT**

Jelle Feringa, Asbjørn Søndergaard

MATERIAL EXUBERANCE

86–91

VIRGINIA SAN FRATELLO AND RONALD RAEI

IN CONVERSATION WITH NERI OXMAN

92–97

PRINTING ARCHITECTURE:

CASTLES MADE OF SAND

Benjamin Dillenburger, Michael Hansmeyer

98–103

BLOOM

Jose Sanchez, Alisa Andrasek

104–111

PLASTIC-CAST CONCRETE:

FABRICATION AS APPLIED RESEARCH

Kenneth Tracy, Brad Bell, Christine Yogiama,
Lavender Tessmer, Kevin McClellan, Andrew Vrana,
Erik Verboon

112–119

BUILDING BYTES:

3D-PRINTED BRICKS

Brian Peters

120–127

THE MOBILE ORCHARD:

**GROWING ERGONOMIC, EDIBLE, AERIAL
DATASCAPES**

Alex Haw

128–135

SEARCH FOR A ROOTED AESTHETIC:

STUDY IN SPIN-VALENCE

Emily Baker

136–145

THE RISE:

BUILDING WITH FIBROUS SYSTEMS

Martin Tamke, David Stasiuk, Mette Ramsgaard
Thomsen

146–153

LA VOÛTE DE LEFEVRE:

**A VARIABLE-VOLUME COMPRESSION-ONLY
VAULT**

Brandon Clifford, Wes McGee

FORMING MACHINES

156–165

ACHIM MENGES

IN CONVERSATION WITH PHILIP BEESLEY

166–173

PERFORMING:

EXPLORING INCREMENTAL SHEET METAL
FORMING METHODS FOR GENERATING
LOW-COST, HIGHLY CUSTOMISED COMPONENTS

Ammar Kalo, Michael Jake Newsum, Wes McGee

174–181

(FR)AGILE MATERIALITY:

APPROXIMATING UNCERTAIN FABRICATION
PROCESSES

Kadri Tamre, Marjan Colletti, Georg Grasser,
Allison Weiler

182–191

[R]EVOLVING BRICK:

GEOMETRY AND PERFORMANCE INNOVATION
IN CERAMIC BUILDING SYSTEMS THROUGH
DESIGN ROBOTICS

Stefano Andreani, Martin Bechthold

192–197

ANTI-GRAVITY ADDITIVE MANUFACTURING

Joris Laarman, Saša Jokić, Petr Novikov,
Luis E. Fraguada, Areti Markopoulou

198–205

THE DESIGN OF A LUNAR OUTPOST:
3D PRINTING REGOLITH AS A CONSTRUCTION
TECHNIQUE FOR ENVIRONMENTAL SHIELDING
ON THE MOON

Xavier De Kestelier, Enrico Dini, Giovanni Cesaretti,
Valentina Colla, Laurent Pambaguian

206–215

FABbots:

RESEARCH IN ADDITIVE MANUFACTURING
FOR ARCHITECTURE

Marta Malé-Aleman, Jordi Portell

216–223

AUGMENTED MATERIALITY:

MODELLING WITH MATERIAL INDETERMINACY

Ryan Luke Johns

224–231

MESH-MOULD:

ROBOTICALLY FABRICATED SPATIAL MESHES
AS CONCRETE FORMWORK AND REINFORCEMENT

Norman Hack, Willi Viktor Lauer, Fabio Gramazio,
Matthias Kohler, Silke Langenberg

LIVING ASSEMBLIES

234–241

NEIL GERSHENFELD

IN CONVERSATION WITH MARK BURRY

242–247

PERIPATETIC FABRICATION:

ARCHITECTURE, CO-ROBOTICS AND MACHINE
VISION

Mike Silver

248–255

SILK PAVILION:

A CASE STUDY IN FIBRE-BASED DIGITAL
FABRICATION

Neri Oxman, Jared Laucks, Markus Kayser,
Jorge Duro-Royo, Carlos Gonzales Uribe

256–265

MULTI-SCALAR SHAPE CHANGE IN
PNEUMATICALLY STEERED TENSEGRITIES:

A CROSS-DISCIPLINARY INTEREST IN USING
MATERIAL-SCALE MECHANISMS FOR DRIVING
SPATIAL TRANSFORMATIONS

Phil Ayres, Kasper Stoy, David Stasiuk, Hollie Gibbons

266–271

BUILDING WITH FLYING ROBOTS

Ammar Mirjan, Fabio Gramazio, Matthias Kohler

272–279

HYGROSKIN:

METEOROSENSITIVE PAVILION

Oliver David Krieg, Zachary Christian, David Correa,
Achim Menges, Steffen Reichert, Katja Rinderspacher,
Tobias Schwinn

280–287

FABRICATING BEHAVIOUR:

A PROBLEM, A SOLUTION, A PROTOTYPE
AND A PROPOSAL

William Bondin, Ruairi Glynn

288–295

FROZEN RELIC:

DIGITALLY REFABRICATED ARCTIC ICE FLOES

Matthew Shaw, William Trossell

296–303

FLUID CRYSTALLISATION:

HIERARCHICAL SELF-ORGANISATION

Skylar Tibbits

306–315

AUTHORS' BIOGRAPHIES

FOREWORD BY THE EDITORS

FABIO GRAMAZIO, MATTHIAS KOHLER, SILKE LANGENBERG

Three years ago, a seminal discussion on the decisive role of making in architecture was launched in a large international forum at the inaugural FABRICATE conference organised by the Bartlett School of Architecture, University College London. The main topics proposed by its Chairs, Bob Sheil and Ruairi Glynn, addressed prevailing shifts in the contemporary production of architecture: physical processes, material systems, machines and the bespoke as well as representation and manufacture.

Today's remarkable interest in intensifying the relationship between design and making in architecture seems to be driven more by research institutions and young start-up entrepreneurs than by an established architectural practice. In continuation of the profession's constructive tradition, entirely digital technologies and construction methods, such as robotic fabrication and architecture-scale 3D printing, are currently being tested with the help of prototypes, pavilions and smaller buildings. Here the question arises of if and how the innovations developed will become relevant at a larger scale of architecture. But an issue that may become even more important is whether the creative spirit originating from these digital-material explorations will lead to a change in sensibility and methods that will affect the design and building culture more fundamentally than might appear at a first glance.

While digital fabrication technologies are rapidly becoming common practice in architecture for prototyping as well as for ornamental effects, a profound knowledge of their full architectural operability and inherent capacities seems to be developing very slowly among architects. There are still experts needed who can 'solve the problems' of transforming designed digital models into built reality. However, to make the full spectrum of digital technologies in architecture accessible, to unfold it or even exhaust it, they have to be more than known techniques, they have to be considered conceptually in design from the very beginning. Therefore, the focus of the FABRICATE conference at ETH Zurich in 2014 is particularly set on contemporary research that does not just investigate the further development of technologies, but presents ways of integrating them in an early design phase in order to finally overcome the still prevalent separation of design and making and introduce new meaning and substance into the profession.

The publication includes contributions from leading research institutions such as the Bartlett School of Architecture at University College London, Harvard University, the Institute for Advanced Architecture of Catalonia, the Institute for Computational Design at the University of Stuttgart, the Institute of Technology in Architecture at ETH Zurich, Massachusetts

Institute of Technology, Princeton University, Yale University, as well as projects by Arup, Autodesk, Buro Happold, design-toproduction, Foster + Partners, Hyperbody and Scanlab. It is complemented by conversations between the keynote speakers at FABRICATE 2014 and 2011: Mario Carpo and Matthias Kohler, Neil Gershenfeld and Mark Burry, Achim Menges and Philip Beesley, Virginia San Fratello and Ronald Rael and Neri Oxman.

ACKNOWLEDGEMENTS

We owe our thanks to a large number of friends and colleagues. Firstly, to the Co-Chairs, Bob Sheil and Ruairi Glynn, for their valuable advice and continuous support, to Marilena Skavara and Orkun Kasap for their tireless and great help in organising the conference, as well as to our whole team at ETH Zurich.

We are indebted to our Chairs and numerous peer reviewers, without whose efforts, time and work it would have been impossible to manage the large number of contributions to FABRICATE 2014. So our sincere thanks go to Hubertus Adam, Philippe Block, Tobias Bonwetsch, Michael Budig, Xavier De Kestelier, Stylianos Dritsas, Yves Ebnoether, Sean Hanna, Volker Helm, Sawako Kaijima, Axel Kilian, Branko Kolarevic, Toni Kotnik, Dirk Krolikowski, George Legendre, Marta Malé-

Alemany, Wes McGee, Achim Menges, Philippe Morel, Shinya Okuda, Neri Oxman, Fabian Scheurer, Christoph Schindler, Michael Stacey, Martin Tamke, Yves Weinand and Jan Willmann.

For their support in finalising the publication, we would like to thank Veronika Darius for her management, Beverly Zumbühl for editing and especially Oliver Schmid for designing the book in a really narrow time frame. Thanks also go to all the authors for their diligence and patience.

For promotion and support, we want to thank our media partners archithese, uncube, Detail research, Architonic, world-architects.com, Stylepark and archello, as well as the Institute for the History and Theory of Architecture (gta) at ETH Zurich, ACADIA 2013 and the Fab lab Zurich for an inspiring exchange and much valued contributions.

And finally, we thank the Department of Architecture of ETH Zurich, Keller AG, NOE Formwork, Erne AG Holzbau, Bachmann Engineering AG and Computerworks for sponsoring the conference, and especially ABB and The Port Technology by Schindler for their generous financial support for this publication.

FOREWORD BY THE INITIATORS OF THE FABRICATE CONFERENCE SERIES

BOB SHEIL, RUAIRI GLYNN

FABRICATE was conceived as an international forum to address 'the big picture' surrounding the making of contemporary architecture, and the status and trajectory of an evolving discipline in changing times. Within this scope, the principles that underpin FABRICATE ask: how contemporary architecture is being conceived in relation to new production methodologies; how such methodologies are informing design strategies; how new technologies are altering relationships on the journey from idea to building; how designers are shifting their position in relation to production; and how design research and practice coexist as collaborative industries of creative and critical innovation.

Significantly, as co-founders, we approached this idea from different positions, different backgrounds, and to some extent different generations. One was trained in the era of drawing boards and manual workshops, the other in computational programming, electronics, and interaction. Despite this, the past decade has been a provocative and inspiring era for both of us. We've seen our origins converge, our trajectories shift, and our opportunities expand. We found ourselves looking at the same space from different positions, and agreed that the time was right to instigate an open dialogue on how such events were reshaping our discipline, its wider

potential, and its role as theatre between the real and the imagined.

We were prompted to co-found FABRICATE through the vibrant debate at Digital Architecture at London's Building Centre in 2009,¹ as well as being inspired by earlier events at FABRICATION (ACADIA²), hosted by the University of Waterloo, School of Architecture in 2004. Based on these two key experiences, we agreed FABRICATE should aim to attract both academia and practice in equal measure, and in 2011 we were delighted to inaugurate the first gathering at the Bartlett, UCL. Based on the overwhelmingly positive response before, during and after the event, we decided that FABRICATE should run again in a different venue, with different hosts, and decided a three-year cycle would best fit.

We were both delighted and honoured that Fabio Gramazio and Matthias Kohler of ETH immediately presented an enthusiastic bid, and as this publication clearly demonstrates, together with their extensive team, including Silke Langenberg, assisted by Marilana Skavara from UCL, they have delivered on the task of taking this format forward in spectacular fashion. Through their work, FABRICATE has been fully established as a robust and adaptable model in which to critically address the immense changes taking place in our industry.

And as the 2014 iteration illustrates, the horizon continues to expand. So many thanks to all who submitted works, congratulations to all who won a rigorous and tough selection process, and our deepest appreciation to all involved in making this happen again.

¹ A conference chaired by Ruairi Glynn, in which a panel on Fabrication was chaired by Bob Sheil.

² ACADIA: the Association for Computer-Aided Design in Architecture.

CHALLENGING THE THRESHOLDS

MARIO CARPO

IN CONVERSATION WITH MATTHIAS KOHLER

MATTHIAS
KOHLER

Mario, the Fabricate conference series was initiated on the idea that making is gaining renewed relevance in the design concept of architecture, particularly when viewed against the background of rapidly evolving digital fabrication technologies. Let's make a thought experiment and fast-forward to a near future. Imagine an architecture that is made by robotic agents 'mass collaborating' under architectural guidance. Even today, we can anticipate that the constructive vocabulary and material language is likely to transform vis-à-vis these new production conditions. But will this profound, operative re-conception of the materialisation of architecture also trigger a re-conception of space?

MARIO CARPO

Good question – because space has been the absentee protagonist of many of our conversations. When we talk about making, we talk about technical objects and until now most of the technical objects were digital design and fabrication technologies that have been put to task for evident reasons, most have been small

objects or the assembly of small objects. The best, the most persuasive, the most conspicuous results of the new fully integrated seamless file-to-factory technologies have happened on the scale of the teapot. The teapot is not relevant in the domain of the space it creates because no one lives inside a teapot, we are outside of them. In the history of digital design and fabrication, mainly at the end of the 1990s, attempts were made to make bigger teapots. For example, Greg Lynn expanded the teapot more or less at the same time as he was making the Alessi teapots and made the Embryological House, which is a big teapot. The Embryological House has been published and it is an important document, because we see that when you inflate, you say yes, we can make many small teapots and we know what it means and we can see all the implications of digital design and fabrication there, such as a new way of making form, a new way of making parametric design, implying digital mass customisation and potentially even a new form of authorship or agency.

Fig. 1: Greg Lynn, Embryological House, Venice Biennale, 2002.
(Image by courtesy of Greg Lynn FORM.)

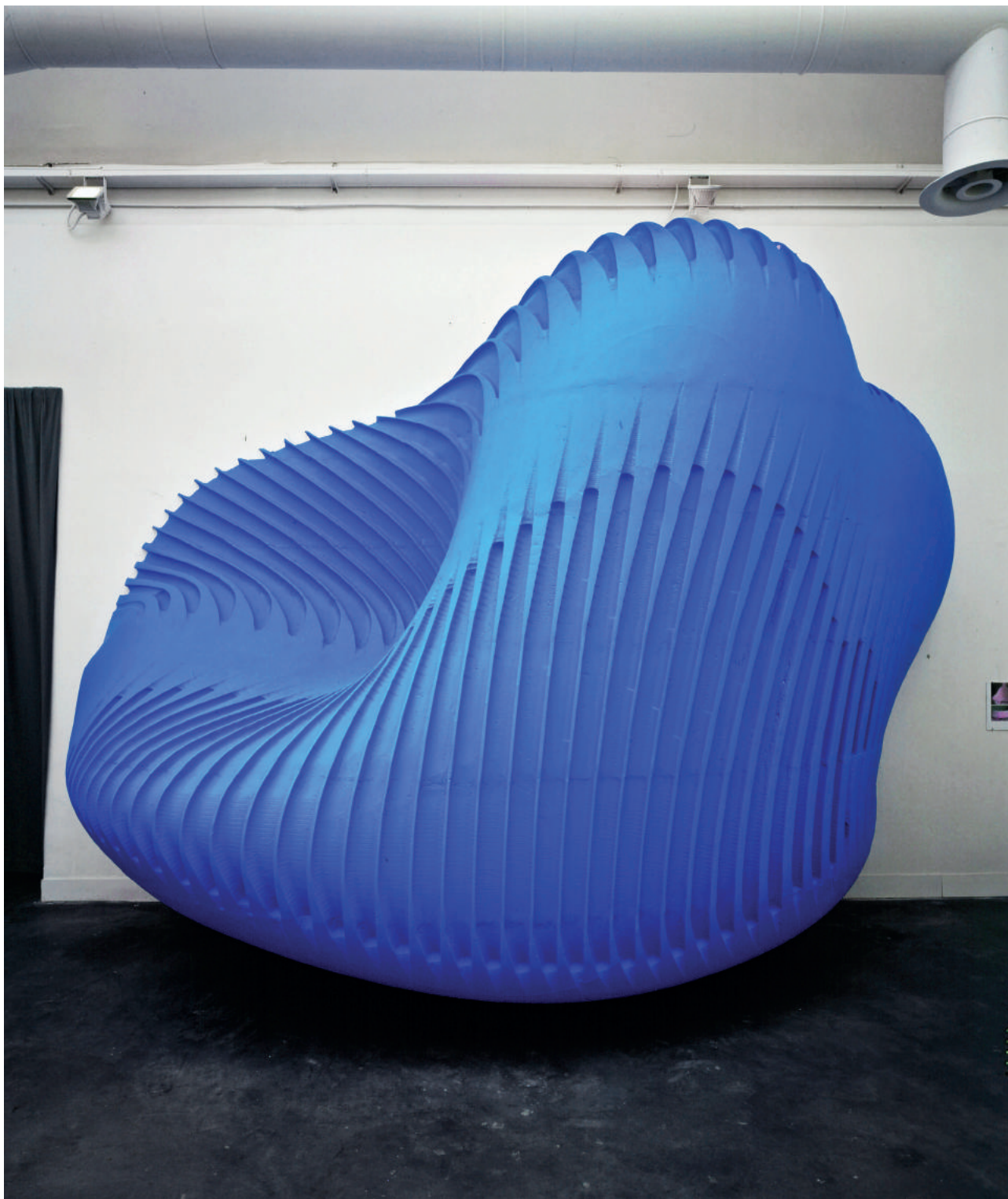

But the teapot is small. People were saying: 'At some point, we can make bigger 3D printers', which has not really happened. They were also saying: 'We can put many small pieces together and we can make a house made of small teapots'. But the technical problem of that time is that if you put all the small pieces together on a frame, it works for the first frame. If you want to make a different frame, you have to redesign all the nuts and bolts. And unless you automate the redesign of all the nuts and bolts of every piece and for every connection, then the digital economy of mass customisation does not apply any more. That proved to be a dead end with the technology available then. A younger generation, people like you, came back with a different solution to the problem. Instead of making the assembly of digitally fabricated pieces with

nuts and bolts to automate fabrication, they said: 'Let's think about robotics'. Historically speaking, this is the time when you started to think that an automatic machine could put together standard bricks.

KOHLER

Yes. Our decision came from understanding the limitation inherent in subtractive principles. The small-scale fabrication of intricate objects could not yield a fundamental and subsequently radical response to architecture's 'making' and design in a digital age. We therefore deliberately turned to additive techniques and bespoke modes of production that are thoroughly attuned to architecture's constructive nature. As a result, robots today build up artefacts on an architectural scale in manifold material processes and architects can even

Fig. 2: NOX/ Lars Spuybroek, HtwoOexpo Water Pavilion, Neeltje Jans Island, Netherlands, 1994–97. (Image by courtesy of NOX.)



'author' these processes throughout. At this point, we get curious to see how this new reality transforms concepts and perceptions of liveable space.

CARPO Yes. And that's a very important point to make, because space is staging a theoretical and critical comeback. If we actually go one step forward, we see a time when the paradigm of digital design and fabrication can actually conceive a way and start making actual buildings, not just blown-up teapots. Do we need a new theory of space? Because, most of the theory we have in the digital domain is about making surfaces or about making technical objects. Space is not a technical object. Space is a bodily perception. There is a theory on space that we somehow inherited from the 1990s that is about the messiness, the complexity, the disorienting experience of a digitally simulated space and sometimes of a physical space that is created on that basis. I am thinking of what was built in the 1990s. The water pavilion by Lars Spuybroek or even to some extent the Guggenheim Bilbao, which demonstrates the idea of the space that you are creating with the CAD programme Catia, which does not make space. Catia makes technical objects. It was meant to be used for designing aircraft. Not the cabin, just the wings, which do not have a physical space. What is the physical space we perceive when we create buildings that way? It is to some extent an almost neo-Expressionistic environment, which has a disorienting effect. It was still this hallucinatory notion of space that is so embedded into the digital history of the last 20 years. What does the digital make? Curves, as in the 1990s, and then space, where you lose the notion of up and down and left and right because there are no longer right angles and you move through this new environment almost in a state of disorientation and so on. This is part of our heritage.

To come back to your question about space, I am not certain if we need a new theory of

space, because many theories of space already exist. And do we really need another theory of embodied perceptual phenomenological space to make sense of the digital? Can we simply not use the many that already exist? We already have a theory of digital space. It was cyberspace, which is not physical, or something physical that looks like cyberspace or virtual reality.

KOHLER Let's discuss the emergence of digital craftsmanship. Today, we are witnessing a romantic and almost idealistic resurgence of the idea of traditional manual craftsmanship that seems to mask its drastic factual decline in most developed countries. Such craftsmanship is particularly prone to economic exploitation, such as the marketing of luxury mass products, like watches or sports cars. Notably, these craftsmen seldom leave traces on their products, nor does the design account for the capabilities of the craftsmen. These humans are 'the more perfect machine' that complements what the machine cannot do as well. Against such a perverted notion of craftsmanship, we are currently entering the age of bespoke machinic processes offering highly defined, carefully detailed and immensely varied material languages of expression. Do you imagine the cultural praise for manual craftsmanship transforming into one for robotically crafted artefacts?

CARPO Yes! Absolutely! I think it is already happening. This is the core of, for instance, what you are making, because this is exactly what the digital can provide. It is an answer to a demand that has been around in the industrialised world for many years. At the beginning, postmodernism was about denouncing industrial modernity. In the 1960s and 1970s, many architects who were so unsatisfied with industrial mass production said: 'This cannot work. This is against the human mind and body.' But if you made this statement in 1970s, there was no alternative to industrial mass production in economies of

scale. If you wanted to make something cheap, you had to use mass production. That was 1977. So, if you wanted to take a stance against mass production in the 1970s, the only alternative you could provide was to go back to real craftsmanship, which is making things by hand, and many postmodernists actually did just that. They confined themselves to a luxury niche or market. That's because craftsmanship in the West is expensive.

If you want a suit made by hand, you must go to Savile Row in London, where a suit costs £10,000 because it really is made by hand – or so they claim. In the domain of tailoring, for example, it is already evident that the digital is providing a technical answer to the post-modern demand for variation; because before the digital, there were only two choices: you could have a shirt made by hand, if you could pay for it, or you could buy a mass-produced standard shirt in just four sizes. Rem Koolhaas knows these sizes well: they are small, medium, large and x-large. If you don't fall into one of those four sizes, you will have a shirt that does not fit. This was the choice until a few years ago. Now there is a demonstration that shows it is possible to have the best of both worlds by using digital tools. You can mass-produce and hence produce it cheap. But now, you can mass-produce customised, bespoke objects at the same time because there is a 3D scanner. You go into a cabin, they take a scan of your body, you see all the measurements on the screen. Then you design your shirt on the screen and press a button and the shirt is printed out. Well, it doesn't really work that way yet. But at some point, it will. There is no reason why it shouldn't happen. It is the technical logic of digitality. Bespoke mass production. It will happen perhaps first for shirts, but it has already happened for teapots, for example. And it is already happening for many other things that can be 3D-printed or produced with the assembly of 3D-printed pieces.

KOHLER And exactly at this point I would like to extend our discussion beyond mass customisation and 3D printing. Because, in fact, architects today can design computational processes that run on robots, juxtaposed and embedded in physical reality. As an architect, therefore, you can have a machine interact with the environment in a way you imagine it or you can even design one to interact with the environment in a certain way.

CARPO Aha, so an automatic feedback on the material the machine is working on? Fantastic, it is exactly what the hand of a craftsman would always have done.

KOHLER Yes, this is one of the research strands we are pursuing. In a counterpoint to the AD magazine on 'drawing architecture', which was recently published, you argue that through massive computing, we no longer need to simplify the world to model it, but can deal directly with its unruliness. I quote: 'untidiness, messiness and slightly disturbing uncertainties'. If I relate this statement not only to computational complexity, but also to materialisation by architecturally guided robots, as I described it before, it could imply a seminal break away from the smooth, continuous and somewhat aseptic aesthetic of what was formerly termed digital architecture. How do you expect this untidiness to change the physical expression of architecture?

CARPO The topic you were talking about, automatic feedback between the machine and the material it's working with or an intelligent machine that can interpret the resistance of the material, is the next step of digital craftsmanship. From when I was a child living in the north of Italy, I do remember real craftsmen, bricklayers who had, as Richard Sennett would call it, the tacit knowledge of the artisan. These people didn't go to any school, but they had been working with timber or bricks for years. I remember when a carpenter was making the beams for

a roof and the timber came in. They didn't scan the timber to understand what the resistance was, instead, by working on it, they could understand timber as a natural material that is not equal throughout, homogeneous as is steel, which we can produce that way. We want it always to be the same because it must have the same elasticity at every point, so we can calculate it using modern mathematics. But we cannot calculate timber unless we make it look like or perform like steel. If we take even just the branch of a tree as a beam, there are so many 'accidents' happening, which is the way nature works. There are plenty of irregularities that you cannot foresee unless you scan the beam and you see that at some point, inside that beam, there was a little bug who made a little nest for himself. This creates a hole in that beam which will make that beam less resistant than the other ones. A good traditional expert craftsman could understand that by the touch of his hand. This is not a mystique of the craftsmen, they really knew how to do it. They could understand that there were 20 beams to put in that roof, but some were more solid than others. So they put some in parts of the roof where less resistance was required, others where they needed more resistance. They made a functional, non-standard structure regardless, without utilising any engineering calculations, just by tacit knowledge. Now I think we are getting to the point where intelligent machines can interact with the material they are working on in a somewhat similar way. They can produce feedback from a piece of non-standard, inhomogeneous, accidental and even dirty stuff they are manipulating. An engineer cannot manipulate dirty stuff because, in order to that, he or she would need to model it and then they would need to bring in an analysis with finite elements and make extremely complicated calculations. This is theoretically possible, but not cost-effective. At some point, the feedback loop between the machine and the material will be so fast that it will become almost analogous to the immediate bodily perception of a tradi-

tional craftsman. Is the stuff you are doing going in this direction?

KOHLER And there is another important point that should not get missed here. Technologically, you are absolutely right, the sensory abilities of robots are moving toward a direct response to their physical environment. But what is important here is that the architect can now program those abilities. Architects won't just design a form by predefining a geometry that will subsequently be built by a highly sophisticated machine, such as the one you have just described. Instead, they will design the behaviour and responsiveness of the machine itself. They design this ability up-front and then it is executed at the time when the building takes place. So, even when you as the architect are not on site, you can be virtually present through your robots.

CARPO Yes. If we extrapolate and generalise this, it would mean that the good old humanistic and modern notion of design, which is the imposition of an idea upon material, will be replaced by a timeless and probably ancient notion of craft where the result is born out of a dialogue-based interaction between the craftsman and the objects he's making or the material. It means that the notion of design, a blueprint that is the fruit of one mind, the flower of one intelligence, is no longer valid. And the material has to be applied and made or manipulated to work that way. Of course, engineers can include a lot of technical thinking in design, but at the end of the day, the design is as dead as a door nail. It is a piece of paper that has to be materialised. By the time the design is made, it is not possible to go back any more. It has to be made that way or the contractor will sue you because they made cost estimates based on your design. In a digital environment, this paradigm is probably no longer sustainable. When a machine, at some point, can make craft dominant again and craft means unpredictability, variability, improvisation and decisions that are made on

the fly, these are things that you cannot anticipate on a blueprint. And to your point, to some extent, you can design the intelligence of a machine.

The immaterial presence of the architect through the design of responsive robotic behaviour does not recreate the role of the architect in a humanistic, Albertian, modern sense of the term, but being a master builder, someone who has to be on site. And in a sense it would be building as making, not by making a drawing of the design of it, but by training your teams of technical agents or your crew of machines. But you would still need to be aware of the time, right? There are two analogies for that. One is that of a master builder who trains his workers, but has to be on site all the time to give instructions. The other analogy of the master builder is one who trains the builders so well that at some point he can say: 'Go ahead, you know what you have to do.'

KOHLER Exactly. And in such a scenario an architectural blueprint will become a dynamic, procedural one rather than a static, geometrical one. Instead of designing through the means of geometry, you design the characteristics of your building through skilful constructive 'coding'. This opens a breach in digital architecture where it steps out of a tight corset of complex geometries and stylistic formalisms into a radically materially embedded design practice. And it is exactly here where I was wondering whether your statement on untidiness, messiness and slightly disturbing uncertainties (of this world) would expose a different aesthetic agenda.

CARPO That's a good point. But to some extent this is the way many medieval builders built their buildings. They had certain geometrical rules. But these geometrical rules did not determine the visual aspect of the things they made, which is why in the end they looked all different even though there is always the same geometry

embedded in them. But this geometry was Euclidian geometry, a way of making. You make a square and then you make a square inscribed in that square and that relates the plan to the elevation. But this could never explain the final visual aspect of an object. In a sense it was process-based and not visually controlled.

We have to let go of the way objects finally look. But if you shift this to retail items such as shirts or shoes or anything that has a brand, the problem is that at some point variation becomes so uncontrollable that brand recognition will not exist anymore. For a market-based economy, that is a problem. And yet this idea of controlling brands is in itself not a timeless thing. It is a fairly recent technical and cultural invention. In the Middle Ages, urban guilds did control the quality of the product without controlling any brand and they could let the visual aspect of the product change all the time because they controlled the process through protocols. The problem now is that we in the West have lost that ancestral capacity to make sense of variations within the last five centuries because we have been living in a visually standardised environment. So we are capable and very good at recognising identicalities. We can say when two things are the same, they have the same meaning and they are made of the same brand or by someone plagiarising them. This is the basis of the technical world where we live. But this aesthetic paradigm is predicated upon a technology that is only good at making identical copies. And the digital does not work that way, which is why the digital is unmaking most of the pillars of the very same economy we live in. It has already happened in the domain of copyright or in the domain of digitally distributed music and this has already 'unmade' the music industry. So it's happening. Lawyers cannot make any sense of it because we cannot yet find a way to copyright stuff in the digital domain. But in the Middle Ages they didn't have copyrights because they didn't need them.

And yet in their own messy way, they did build stuff.

KOHLER However the currently evolving digital paradigm and the increasing complexity it entails seems to be also coupled to a continuously expanding professional specialisation. How do you see the role of the architect as 'author' evolving within this delicate balance? Can we witness a change in this trend toward specialisation with the emergence of a new kind of 'universal architect' equipped with powerful digital tools and collaborative networking capacities? Or is he, in contrast, increasingly imprisoned in a technological golden cage and overruled by the dominant logic of trade specialisation?

CARPO Well, this is a one million dollar question, because every school of architecture in every continent is asking it. But one thing is for certain: the idea of the architect who is in charge of making the blueprint, and all the practical, legal and cultural consequences of what I call 'the Albertian paradigm', are based on the complete separation of design and fabrication. This was the way the architectural profession was created in the West, separating it from making. In the Middle Ages, we were all 'makers', we were craftsman or master builders. We had to go to the building site, to climb on the scaffolding – and sometimes we fell out of the scaffolding, which was not good – and we had to work in all weather conditions. It was a difficult life. And then, this idea came up during the Renaissance that, over time, became the dominant paradigm in the West, claiming: 'We do not make stuff, we make drawings of stuff. We make notations, the blueprint.' We separated the blueprint from the building site with a huge scaffolding of building provisions.

These are actual legal firewalls that separate our profession from the liabilities of production. In the USA, for example, friends and colleagues explain to me that the separation between the idea of a blueprint and the materi-

alisation of the construction drawing is the bidding or tendering process. The contractor comes in and at that point there is an actual legal firewall separating the design intentions, which are manifested in a blueprint, and the construction drawings, which are often implemented without our control. But this also puts it outside our liabilities, which is convenient for us. We won't have to pay for the damages if something goes wrong. This firewall separating the design intention from the messiness of a building site is the legal embodiment of the humanistic idea of the last five centuries that says the accidents, unpredictable events, the messiness of the building site is none of our business. We make a drawing, we say: 'You, builder, contractor, make it happen in such a way that it will approximate our ideas. That's your job and you are paid to do that, we are paid to have an idea and put it into a drawing.' The entire economy of building in the West is predicated on this idea, and the fees we receive as architects are based on this paradigm.

However, in many parts of the world that did not have the Renaissance as we know it, this idea was never dominant and it is not thriving, as far as I understand it, in the big marketplace of building. Most of the building process in China, except for a few iconic buildings that end up on the front page of architectural magazines, is driven by a contractor or developer, and the humanistic architect as the inventor of a building simply does not exist. I suspect that in a non-Western culture where humanism and the Renaissance never occurred, there is no need for an inventor of a building, a scientist, a thinker or an artist who puts an idea into a drawing. Because the developer is a team of nameless designers paid by the hour or with a salary that collectively make a building. For this kind of business environment, BIM is just perfect. The combined forces of the global marketplace, of technology and of the economy seem to be going in that direction. China proves that you can build a huge amount

of buildings without an architect. This is a participatory process, not in the sense of creative collaboration, but in the sense of an environment of bureaucratic decision-making. This way, big corporations work. They call it design by committee. Architects do not like that. We have a right to be against that.

This is what the avant-garde always does. The humanists of the Renaissance were also avant-garde and tried to make some sense of a new notion of individual creation and they were quite successful in that. The historical avant-garde of the twentieth century successfully invented a notion of a new process of building made to measure for the industrial age and the arrière-garde or the rearguard of the time who claimed: 'You are a bunch of loonies, building will always be built by hand.' But they were wrong; because now buildings are made by machines. This is the historical function of the avant-garde.

KOHLER Let us address the larger question of the cultural role of architecture in the digital age. From a critical perspective of the prevailing discourse, specifically that on digital design and fabrication, it could appear as submerged in self-referential, sometimes positivist discussions without yet achieving a significant cultural meaning. As an easy conclusion, 'the end of the digital', has been prematurely proclaimed, while digital mechanisms still continue to persist, of course. I personally refer to this moment as the second digital age of architecture, as it is now – in contrast to the first digital age – the material understanding, conceptualising and leveraging the entire momentum of the digital in architecture. How do you see the role of architecture as a meaningful cultural discipline today?

CARPO I can answer this with only one example, which however is quite an adequate one. When architects in the 1990s started to think about digital mass customisation, they started to claim: 'Using digital tools, mass production, economy

of scale, standardisation, and centralisation are a thing of the past. We have to invent a new way of making things that would change everything.' This was based upon mass producing variations. They even mentioned Gilles Deleuze, possibly the most abstract, opaque and arcane philosopher of the twentieth century. People said: 'Your theories have no relevance, you are shutting yourself off from society and from politics, etc.' Last winter, in his speech on the State of the Union, which he holds every year in January, the President of the United States had a paragraph on 3D printing. He said: '3D printing is a revolutionary new technology that is going to change the way we make almost everything.' This idea came from Gilles Deleuze: the theory of the objectile. Bernard Cache, Greg Lynn and a few others in 1993 were making this idea as clear as possible. In 20 years, we went from Gilles Deleuze to the White House. And this was the idea of architects. It was our idea, we developed it and we were quite successful. Twenty years ago, we were a bunch of isolated lunatics, and last winter, it was Barack Obama speaking to the world. Just in 20 years. We're not so irrelevant after all.

KOHLER Correct. But to what degree has this achievement also a cultural impact? The theoretical discussion in the early ages of digital architecture was never directed towards Obama nor primarily interested in an economic shift in the manufacturing industry. It was rather an discussion.

CARPO Yes, but let's not be modest. A paradigm shift that, according to the President of the United States and his advisors, has the potential to change almost everything and probably also will change the way architecture looks – and maybe already has, since we have one digital style or two by now. We understand that the generation of Greg Lynn did not particularly have this in mind, if we read what we were writing in the 1990s. Yet, the idea of digital mass customisation from the beginning had huge political, technical and economic implications.

Let's be bluntly materialistic. If you are advocating a change of style that does not relate to a change in society, technology, or culture, it will not catch on. If we look at the last 20 years with some historical detachment, we may come to the conclusion that architectural forms did change and it might have appeared to be a flight of fancy. But at the same time, these ideas have disseminated through society, fermenting a process of change that is now changing almost everything. So, it was not just producing blobs; the blob is only what we see. But neither Obama nor the head of the Federal Reserve and other economists are interested in having round shapes or spline-dominated shapes or surfaces. It is already a fact that these ideas, which we investigated first and foremost because we are interested in making forms, we are architects after all, they are catching on, because it is not just about making different shapes, it is a new paradigm and it is everywhere. I would claim it is already changing almost everything and has the potential to do so further.

Historically speaking, Le Corbusier was so important not just because he built some buildings; his ideas visualised a machine-made environment. In a sense, this is the rhetorical power of architecture. We use technologies and we find forms that make these technologies perceivable. They embody, personify and visualise them. Le Corbusier's vision of a machine-made environment was one of the most powerful images of the twentieth century. To some extent, on a slightly smaller scale, the blob has already performed some of the same rhetorical functions by persuading the world that a new technology is on its way. If we go to Bilbao, we go to see the Guggenheim Museum in Bilbao because this visual element proves there is a change going on that is bigger than architecture itself, which is true. Historically speaking, it is already a historical fact.

KOHLER Thank you very much for this conversation, I look forward to continuing it twenty years from now!

Fig. 1: MADA vault, Melbourne, Australia, 2013. (Photo: Peter Bennetts.)



RIBBED TILE VAULTING: INNOVATION THROUGH TWO DESIGN-BUILD WORKSHOPS

PHILIPPE BLOCK (ETH ZURICH), MELONIE BAYL-SMITH (UTS, SYDNEY), TIM SCHORK (MADA, MELBOURNE),
JAMES BELLAMY (REVAULT), DAVE PIGRAM (UTS, SYDNEY)

Traditional tile vaults are typically constructed springing off from walls or straight arches built from support element to support element on falsework. From these, the vault's surface can be built in space with minimal or no guidework. Built on previous research and focusing on continuous surface expression and fully representing three-dimensional equilibrium surfaces in compression, this research explores the design potential of three-dimensional networks of structural ribs, made possible by new funicular form-finding approaches. This new structural typology for tile vaults was investigated and tested through two intensive, design-build workshops in Australia, the first at the University of Technology, Sydney (UTS) in October 2012, and the second at Monash Art Design & Architecture (MADA), Melbourne in May 2013.

INTRODUCTION

With indebtedness to projects such as the Mapungubwe Interpretive Centre in Limpopo, South Africa,¹ the 600-year-old Mediterranean construction technique known as tile or Catalan vaulting is undergoing an important revival and attracting increased interest. Tile vaults are unreinforced masonry vaults made of thin tiles, built in multiple layers, with the typical tile unit size approximately $24 \times 12 \times 2$ cm. Traditional tile vaults are constructed by building off of walls or from arches, straight in plan and built on falsework, from support element to support element. Taking a wall or these arches as boundary supports for the vault's surface, the first layer of tiles can be built in space using a fast-setting gypsum mortar, commonly known as plaster of Paris. By mortaring the tile units on two thin sides, the masonry is able to temporarily cantilever until stable sections are formed. When complete, this stable first layer serves as permanent or 'lost' formwork for a second, and typically also, a third layer of tiles in order to build up sufficient structural depth. These subsequent layers are laid using regular mortar and are placed at different angles to each other, and to the first, in order to create a good bond and avoid obvious hinge lines.

Unreinforced masonry has negligible tensile capacity, therefore the shapes of vaults need to result in a state of compression

only. These can be obtained through the process of form finding, recent developments of which allow a controlled exploration of funicular form. Thrust Network Analysis (TNA) uses geometrically linked form and force diagrams, representing the force flow and its force equilibrium, which give the designer explicit control over the distribution of forces in order to shape three-dimensional compression-only shells.² The concepts of TNA have been implemented in a free plug-in for the CAD software Rhinoceros, called RhinoVAULT.³

Previous research, such as the prototype vault built at ETH Zurich in 2011, focused on continuous, flowing tiled surface expressions that respond to the fully three-dimensional equilibrium solutions, possible due to these advances in form-finding approaches.⁴ A key objective of that earlier research was to avoid the subdivisions created by the arches in traditional tile vaults that emanated from a mainly two-dimensional design approach. These do not exist in a spatial network of forces, and can disturb the spatial continuity of the new compression shapes.

In comparison, this research explores the potential of a design approach that uses a spatial, interacting network of ribs as the form-driving element for tile vaults. Whilst the vaulted infills or 'patches' between the ribs are undertaken in a traditional manner, the structural ribs no longer only span linearly

between supports. The design possibilities of this new structural typology for tile vaults, combining the structural action of a Gothic net vault, the constructional logic of traditional tile vaulting, and novel TNA-generated equilibrium form, were investigated and tested in two intensive design-build workshops in Australia.

The first series of investigations was undertaken at UTS and explored fully spatial, interacting ribs, curving both in plan and elevation. Specifically, investigations were concerned with the fluidity of a hexagonal pattern and the aesthetic of non-intersecting (kissing) strips of ribs of greater structural depth. At MADA, a second set of investigations rationalised the network of ribs, constraining them to form straight segments in plan, forming quadrilateral subdivisions. These constraints resulted in simplified and more realistic, scalable falsework constructions for the ribs, reducing the logistical challenges of the UTS vault. The MADA prototype specifically aimed to demonstrate that a vault of complex geometry could be obtained from a simple underlying structural topology that respected construction sequencing.

FORM FINDING

To explore the new rib vault typology, in the first instance, the structural action of the vaults was abstracted to just the equilibrium of the ribs. The coarse subdivision allowed the controlled and fast exploration of different form diagrams, i.e. rib layouts in plan, using only few controls. Consequently, the distributions of internal force were represented in an agile, comprehensible manner by the simple force diagrams.

In the UTS vault, continuous undulating strips of hexagonal units were obtained with ribs that only just touched, with spacer links included in the network topology to maintain the necessary (rib) offset during the form finding. For the MADA vault, the explorations favoured intersecting ribs and thereby adopted a stretched grid strategy as the rib layout, resulting in pleasing intersections close to square angles. Further, to approximately model the arch and vault shapes in between those intersections, one subdivision was used, giving one mid-node per segment and a node in the middle of each quadrilateral patch.

In a second stage, the 'low-poly' designs were then refined. At UTS, a simple subdivision scheme was used to obtain a smoothly undulating and continuously arching solution. The shapes of the vaulted patches spanning the hexagonal units were obtained separately. These post-processing steps were enabled by the use of selected deep, wide structural ribs comprising stiffened U-channels (see below) in which the structural lines of ac-

tion could be nicely contained. For the MADA vault, the final geometry could be easily obtained by constructing interpolating curves through the nodes of the top-level form finding. The rib arches in between patches were straightened, made possible through the in-plane arch action achievable in the ribs' widths.

CONSTRUCTION

FALSEWORK

A key motivation for varying the design approach of the MADA vault from the UTS vault was the rationalisation of the falsework. For both vaults, falsework was only constructed to support the ribs, with infill surfaces subsequently built unsupported and in space in the traditional Catalan manner. The UTS project had ribs that curved in both plan and section, demanding a relatively complex curved falsework system. MADA rationalised the undulating ribs to a stretched quadrilateral grid, constrained to be straight in plan piece-wise. Both vaults employed printed templates and manual cutting to translate the computationally defined rib profiles into material reality.

The UTS falsework system was constructed from a mix of volumetric EPS foam blocks beneath a curved network of cardboard profiles with columns providing intermediate support. Forming something of a voxelated mountain, the foam blocks were positioned to create a low-resolution offset of the vault, minimising the amount of cardboard (and cutting) required. A second, more significant advantage was that the foam easily supported human weight and that this falsework foundation thus also became a terraced access structure during all subsequent stages of construction, eliminating the need for ladders or conventional scaffolding. The curved cardboard profiles were constructed from three layers of cardboard with discrete foam blocks acting as spacers. Their shapes were defined via vertical extrusion of the centre line and (offset) edge lines of each undulating rib.

For the MADA vault, the form diagram was manipulated to obtain planar ribs, allowing the falsework to be built as a simple grid of planar stud walls. These constraints resulted in simplified falsework constructions for the ribs, further reducing the logistical challenges. Although straight in plan, the rib profile twisted in space as ribs were aligned tangentially to the obtained compression surface. To control this, the two different profiles were cut out of masonite and screwed against the studs. To further accelerate and streamline the falsework fabrication, a Grasshopper software tool was developed to extract the required length of each timber stud from the digital model, and automatically generate the cutting sheets for the ribs.

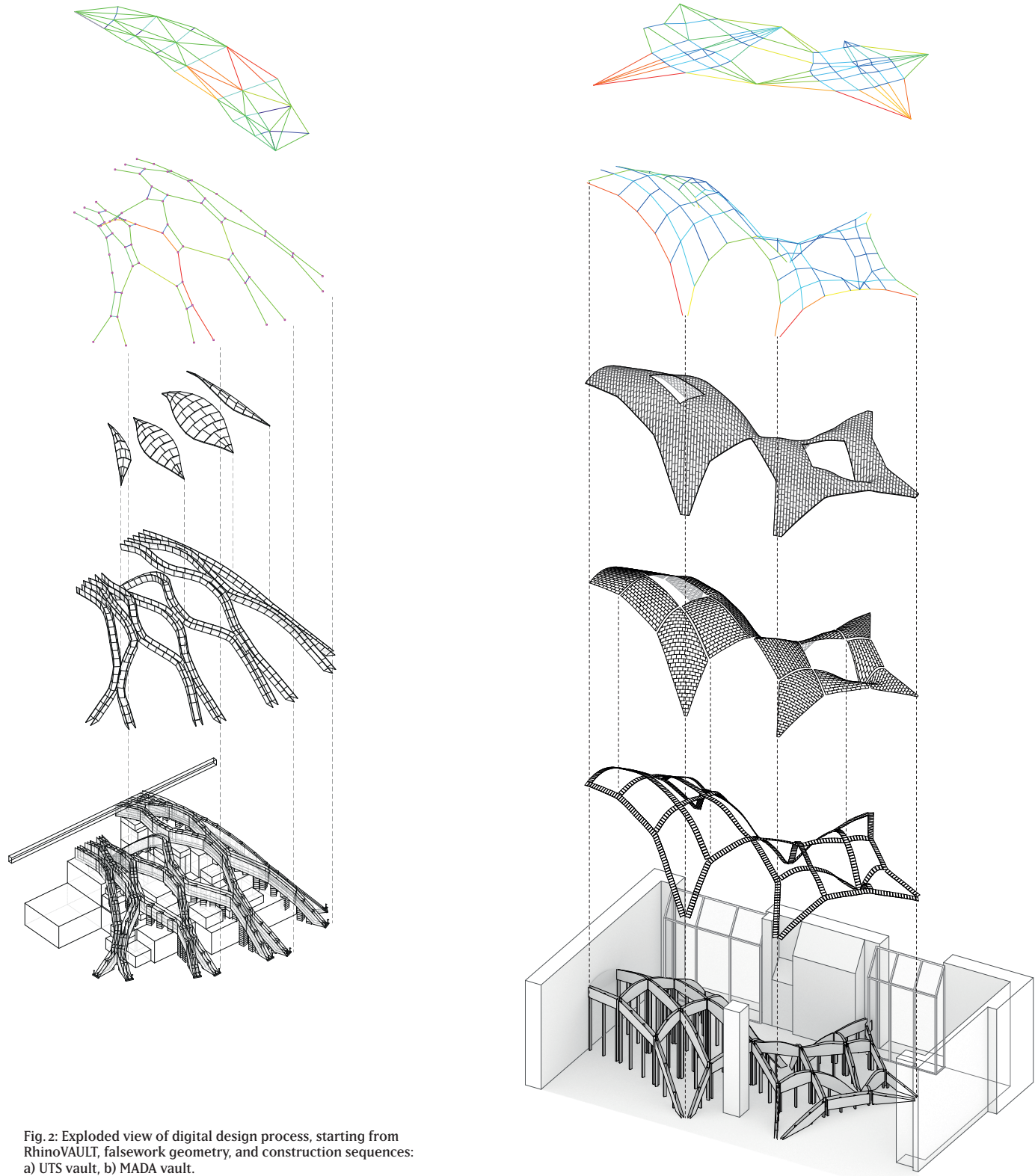

Fig. 2: Exploded view of digital design process, starting from RhinoVAULT, falsework geometry, and construction sequences: a) UTS vault, b) MADA vault.

SITE SET-UP

Because of the short timeframe for each workshop, the erection of the falsework was simplified by printing out 1:1 scale drawing sheets of the plan layout. These were positioned and taped on the floor of the respective spaces. These drawings included reference marks, element numbers and key dimensions, e.g. of the timber studs for the MADA falsework.

For the fabrication of the arch ribs, a similar strategy was employed with all fabrication information being extracted from the digital model and printed out at full-scale (1:1) for cutting templates.



Fig. 3: As-built drawings of UTS vault:
a) front, b) side, c) top view.

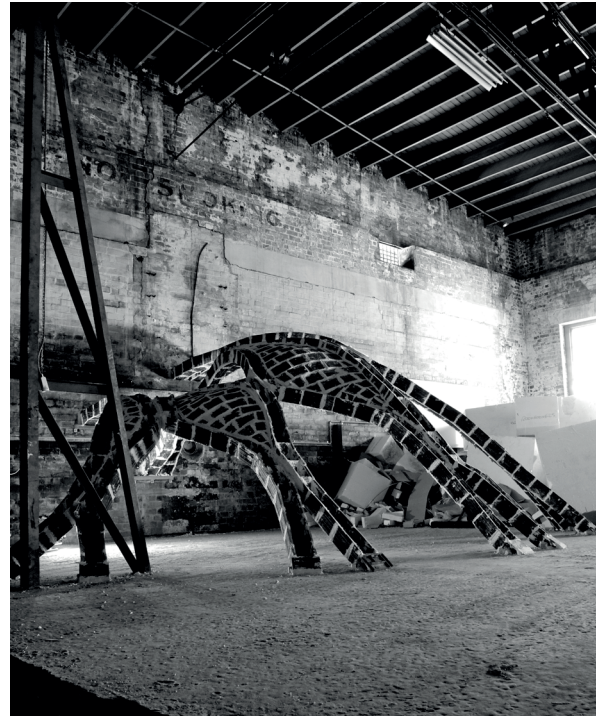

Figs. 4, 5: Finished UTS vault, Sydney, Australia, 2012.
(Photo: Michael Ford.)

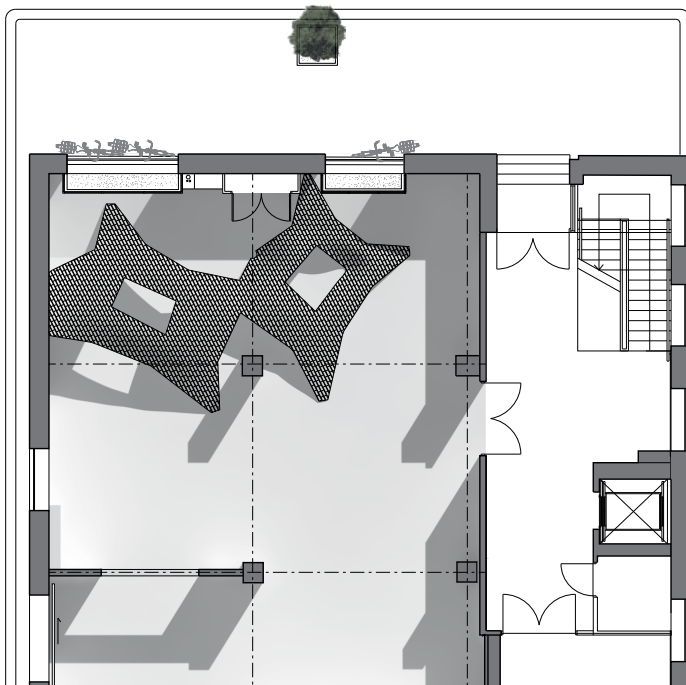
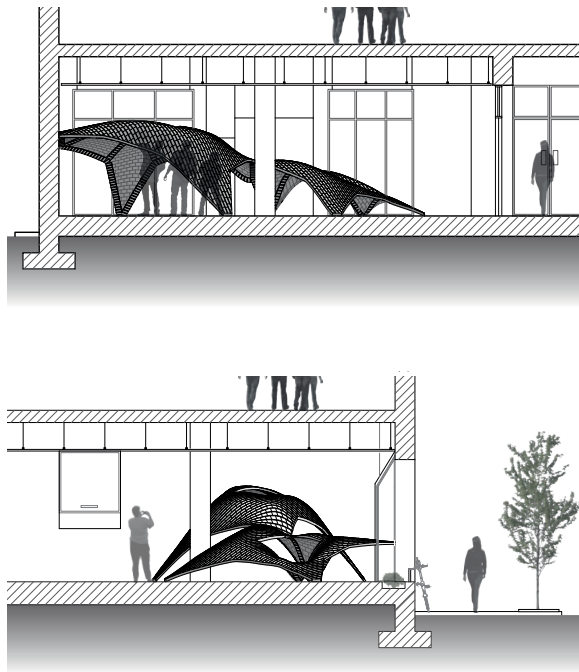

Fig. 6: As-built drawings of MADA vault:
a) front, b) side, c) top view.

MATERIALS

Tiles in the format typically used in Catalan vaulting are not readily available outside of Spain, and custom solutions needed to be found for both workshops. At UTS, concrete roofing tiles were selected for their relative flatness and thickness. These large tiles were then cut into quarters, enabling a sorting of the cut tile units according to the usefulness, or not, of the original lap features found on their underside. Whilst the tiles provided a highly divergent character to the inside and outside of the final vault, overall, they proved difficult to handle during the tile vaulting. For the MADA vault, non-profiled, hollow tiles (very similar to those used in note 4) were used. To provide clean tiles with continuous edge profiles, three cuts per tile were required. This ensured the cuts could avoid, and therefore not expose, the extruded hollows, which would give an uneven edge and thus be hard to work with.

For the fast-setting mortar, with a setting time of approximately 10 seconds, at UTS, a special high-strength gypsum-based mortar called Hydrocal®⁵ was used. For the MADA vault, a readily available and relatively inexpensive dental mortar was substituted, with favourable results.

ASSEMBLY AND DECENTRING

Due to their three-dimensional undulation, the ribs of the UTS vault were constructed with increased depth via a U-shaped profile consisting of one horizontal tile and two upstanding tiles. This three-tile profile was repeated along the length of all curved supports, beginning from the bottom, with all joints staggered to avoid continuous mortar joints. Particular attention to the 'kissing' points was needed to ensure adequate contact and connection at the bottom of the 'U' for future load transference. The result was a stable spatial net of ribs, which were decentred prior to the addition of the infill surfaces. These infills were constructed in the traditional Catalan manner, i.e. without formwork, as described above. The undulating rib pattern and consequent irregular form of the vaulted patches demanded considerable custom tile cutting.

The MADA vault was also constructed ribs first. Tiles were first laid with their long sides next to each other chasing the planar falsework. These ribs remain visible on the underside of the final vault and form a strong aspect of its final character. Here, the entire vault was constructed before decentring and construction with three layers along the ribs, transitioning to two layers for the fills. For the reasons described above, each layer was laid at an alignment that differed from those below it. The intentional constraint to use only quadrilateral



Fig. 7: Construction time lapse of MADA vault.
(Photo: Dean Lau Tim Ling.)

Figs. 8, 9: Finished MADA vault, Melbourne, Australia, 2013.
(Photo: Peter Bennetts.)



subdivisions meant that much less tile cutting was required for the vaulted infills.

CONCLUSION

The two case study projects demonstrate that the increasing contemporary interest in compression-only masonry vault construction is matched by increasing levels of control and formal possibility afforded by innovations in form-finding software paired with fabrication methodologies that expand upon traditional construction approaches. To the set of highly three-dimensional surface structures exemplified by the Block Research Group's earlier prototype at ETH Zurich is now added a new category of irregular and highly three-dimensional compression-only ribbed tile vaults as realised in two projects in Australia.

Significantly, these ribbed tile vaults retain the relatively sparse requirements for falsework enjoyed by their traditional tile vault ancestors without retreating to regularity of form or an increase in thickness. When taken as a pair, by displaying differing levels of rationalisation in the definition of the rib geometry, the two vaults clearly demonstrate the wide range of formal possibilities available as well as the ability to integrate fabrication concerns into the form-finding process.

The combination of computational form-finding approaches and traditional construction methods, as demonstrated via the design and construction of two ribbed tile vaults, can increase the links between design intent and materialisation, and as such is fertile ground for research and innovation.

WORKSHOP DETAILS / ACKNOWLEDGEMENTS

School of Architecture, University of Technology, Sydney (UTS):

INSTRUCTORS: Philippe Block, Melonie Bayl-Smith, David Pigram
STUDIO FUNDING: School of Architecture, University of Technology Sydney

MATERIALS AND SERVICES SPONSORS: Bijl Architecture, Lordell Trading P/L, Monier CSR Roofing, Hanania Quality Tiling Services

DATES: October 2–13, 2012

UTS STUDENTS (Master of Architecture): Amelia Pang, Domenico Ciccio, Francesco Bianchini, Hani Bafail, James Lauman, Jeah Loong Yeoh, Jordan Soriot, Laura Hinds, Natalie Ma, Philena Au Yeung, Sandra Mendonca, Sung Dae Chung, Timothy Cheung

AWARDS: 2013 Graduate & Student Awards of the Australian Institute of Architects NSW Chapter:

- Structural Innovation in Architecture Prize
- Digital Innovation in Architecture – Commendation

Department of Architecture, Monash Art Design & Architecture (MADA):

INSTRUCTORS: Philippe Block, James Bellamy, Tim Schork, Damon Van Horne

STUDIO FUNDING: MADA Department of Architecture in partnership with Grimshaw Architects, supported by the Victorian Endowment for Science, Knowledge and Innovation (veski)

Dates: May 27–June 4, 2013

MADA STUDENTS (Master of Architecture): Anna Black, Boden Davies, Chin Lien Anne-Lise Ip Sion Thoo, Damian Palamara, Dean Lau Tim Ling, Diego Arellano, Dinh Triet Nguyen, Gerard Turnbull, Mehrnoush Latifi Khorasgani, Michael Truong, Natalie Studdert, Radoslaw Buczek, Sara Sidari, Sheli Kuperman

NOTES

1 Michael Ramage, John Ochsendorf, Peter Rich, James Bellamy and Philippe Block, 'Design and Construction of the Mapungubwe National Park Interpretive Centre, South Africa', *Journal of the African Technology Development Forum*, 7/1–2 (2010), pp. 14–23.

2 Philippe Block and John Ochsendorf, 'Thrust Network Analysis: a New Methodology for Three-Dimensional Equilibrium', *Journal of the International Association for Shell and Spatial Structures*, 48/3 (2007), pp. 167–73.

3 Matthias Rippmann, Lorenz Lachauer and Philippe Block, 'Interactive Vault Design', *International Journal of Space Structures*, 27/4 (2012), pp. 219–30.

4 Lara Davis, Matthias Rippmann, Tom Pawlofsky and Philippe Block, 'Innovative Funicular Tile Vaulting: a Prototype in Switzerland', *The Structural Engineer*, 90/11 (2012), pp. 46–56.

5 Proprietary product of the U.S. Gypsum Corporation.

Fig. 1: Assembly One
Pavilion. Reflected light
at night.



WHO'S AFRAID OF FABRICATION? WHY TEACH DIGITAL FABRICATION NOW?

BRENNAN BUCK

Much of the intellect and capital invested in architectural education over the last ten years has gone into digital fabrication. Schools have acquired laser cutters, CNC mills, 3D printers, plasma cutters, water jets and robotic arms, and faculty and students have used them to produce experimental objects, surfaces, interiors and small structures. The arguments made by Bernard Cache, Greg Lynn and Mario Carpo that have inspired much of this work have become implicit for many instructors and some students. Always practice-driven, these ideas have seeped into the profession, enabling an expanding array of pavilion projects and fabrication competitions. In fact, CNC processes continue to revolutionise the building industry at all scales, but their potential in academia seems to have plateaued, isolated on the periphery as under-theorised electives and rarely playing a significant role in design studios.

There is always value for students in working with current technology at full scale with architectural materials, but is there still a relevant project to be found in teaching fabrication beyond the general benefits of craft? Is there a new argument to be made, following up on those about mass-customisation and consumer culture from Lynn or aesthetic notions of sameness and repetition from Carpo? Can or should fabrication play a more central role in design education?

The Assembly One pavilion, designed, fabricated and erected by Yale School of Architecture students in 2012, exposes some potential answers. The project evolved in the shadow of the Yale Building Project: a 40-year tradition in which first-year graduate students design and build a house using common residential construction techniques. But unlike the Building Project, which has always been defined through the lens of craft, the Assembly project was geared toward exploiting Yale's extensive CNC technology, and that focus on technology transformed not only the students' means of production, but redefined their approach to the project from the beginning. An alternate way of realising the project forced the students to rethink their roles as designers and ultimately uncovered an inversion of some basic assumptions about working digitally.

EXPLICIT, SEQUENTIAL PROCESS

Since nearly the initial introduction of digital techniques to architecture, they have been associated with Peter Eisenman's project of explicit process and indexical form. The autonomous programming languages that underlie software evoke Eisenman's vision of an intrinsic grammar for architecture's own internalised language. His strategic use of explicit, often sequential formal manipulations lent themselves to the distinct and numeric nature of digital transformations such as translation, rotation and scaling. As they proliferated, digital techniques have also been read repeatedly as a foreground process, indexicality, and the apparent 'difficulty' of design.¹ What the Assembly course revealed and made clear to the participating students, however, was the opposite – that the integral nature of the digital model absorbs individual design decisions and specific manipulations, rendering them indistinguishable. The integration of fabrication into the project forced the group of designers to work systematically rather than sequentially. In addition to larger scale factors like size and orientation on the site, a number of detail parameters were determined early on to suit the available fabrication technologies, including the use of sheet material, extruded geometry and applied colour. As a result, rather than moving down in scale from site to massing,



Fig. 2: Assembly One Pavilion on the New Haven Green during the International Festival of Arts & Ideas. (Photos: Chris Morgan Photography.)



Fig. 3: The structure is suited to a performance festival. Solid and massive from one angle, lightweight and almost entirely porous from another, it alternately hides and reveals its contents.

to structure, material and detail, responses had to be adapted to each constraint simultaneously and incorporated into a single design. The interdependence of each factor forced a process of trial-and-error integration and negotiation. The result was a completed project that cannot be easily read as indexical, i.e. as a record of a process or series of events.

But if the link between the architectural index and digital technique can indeed be broken, Eisenman's deeper interest in mediated authorship might still be preserved.

Explicit process gave Eisenman an alternative to architecture's humanist focus, dominant since the Renaissance, a way to challenge his own intuitive authorship. Alejandro Zaera-Polo, writing an introduction to Eisenman's work in *El Croquis* in 1997, describes this critical tactic: 'By replacing the origins, the presence and the author by arbitrariness, absence and machinic behaviour, he has found the recipe for a non-conservative resistance.'² Zaera-Polo cites the Arnoff Center in Cincinnati as the best example to date of this machinic process. Zaera-Polo's extensive description of each successive formal manipulation, sequential 'displacements', 're-orientations', 'asymptotic tilts' and 'exponential overlaps', is supplemented by a 'flow chart' placing each move in a rationalised, if still arbitrary sequence.³



Fig. 4: Constructed from thin aluminium sheets, the pavilion opens up on two sides for ventilation and security, focusing the view toward the festival's main stage. (Photo: Chris Morgan Photography.)



Fig. 5: From one particular point, the pavilion is entirely porous, nearly disappearing.

At the time, it appeared that emerging software would allow Eisenman to extend this trajectory, rendering each step in the sequence even more explicit and partitioned from the vagaries of intuition. A version of Zaera-Polo's flow chart can be seen in every published Grasshopper screenshot: a segmented and rationalised sequence of geometric and data translation. However, this sequence is an abstraction of the temporal process involved, one where input parameters, transformations and resulting geometry are constantly being adapted and re-linked. As Patrik Schumacher maintains, the digital model can now easily become so information-rich that it becomes circular, looping back to incorporate ever more constraints simultaneously. In fact, the digital design model may open up an alternate model of mediated authorship, one that 'produces results far beyond the architect's "natural" range.'⁴

SYNTHETIC AND SIMULTANEOUS PROCESS

At a small scale, the Yale Assembly project cast the differences between a project developed in models and drawings and one developed for fabrication in stark contrast. Both Assembly One and the Yale Building Project entail an elaborate design, mobilisation and construction process that involves both collaboration and delegation. In the case of the Building Project,

stick frame construction and some form of contextual deference are assumed, leaving the students to work out the massing and interior organisation first before developing strategies for windows and doors, materials and the landscape. Later, once a specific design is chosen, the class tackles the specifics of structure, detailing, furnishing and material sourcing. As they work, their models and drawings shift from small studies of masses on the site to larger iterations of rooms and details. The entire sequence is a cascade of development that generally moves from the large scale to the small, from the apparently important concerns of site and program to the less consequential questions of character and environment.

The group of 13 students designing the Assembly One pavilion was initially drawn to a similar sequence, diving into the site and potential massing shapes initially before realising that the potential of material, detail and structure were actually the central questions to consider. Their process jumped between considering the size and shape of the project on the Green, to the rigidity of multiple materials in different configurations, the visual and environmental effects of those forms and the limits of the project budget. Clearly, any design project rendered in any medium will incorporate at least this many decisions, but what became clear during assembly was a complete loss of scalar or temporal sequence. The massing of the project was reinvented countless times as the material, detailing or even the paint scheme changed.

This state of unstable interdependence was mandated by the digital model. This consisted of a two-dimensional structural pattern, a single point the pattern was extruded toward, and an inner and outer envelope used to trim away the extruded surfaces. Sketching or imagining any of the three in isolation was meaningless. What followed was a constant game of adaptation that took the students far from what they initially imagined.

DIGITAL DESIGN AUTHORSHIP

This synthetic structure affects the design process in several specific ways. First, the moment of inspiration is drawn out. Design conception no longer has the purity or immediacy of a momentary idea or quick sketch but emerges in unexpected ways over the course of the project. Second, the hierarchy of constraints is levelled. Fabrication projects privilege a different set of questions than building design projects that are developed through representation. Program and urban or site constraints are generally simplified in favour of material properties and perceptual effects, raising the elements of the

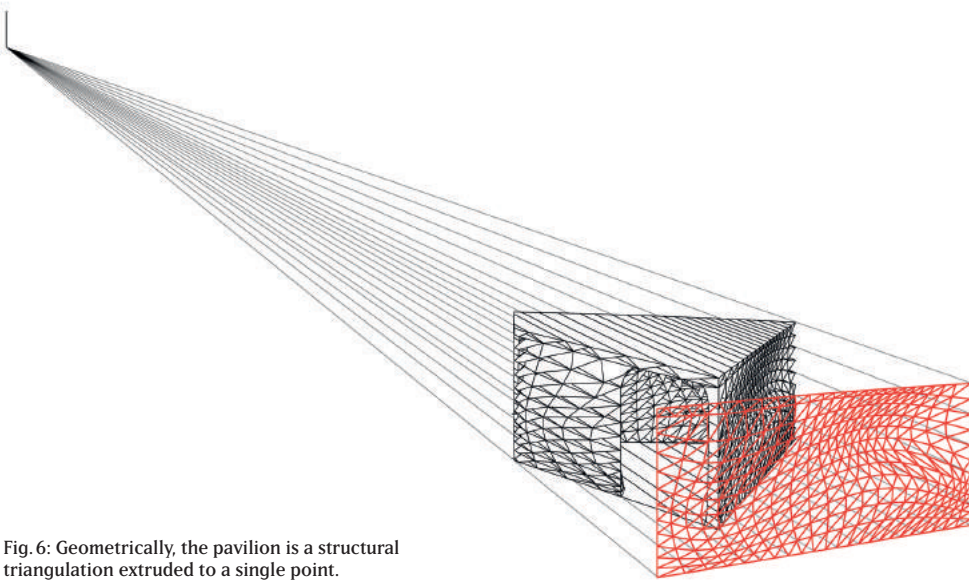

Fig. 6: Geometrically, the pavilion is a structural triangulation extruded to a single point.



Fig. 10: The aluminium was folded and riveted into corrugated layers.

Fig. 9: Twenty-three 'bricks' were fabricated at the architecture school and assembled on site.



Fig. 7: 300 sheets of aluminum were cut and painted at the Yale fabrication lab.

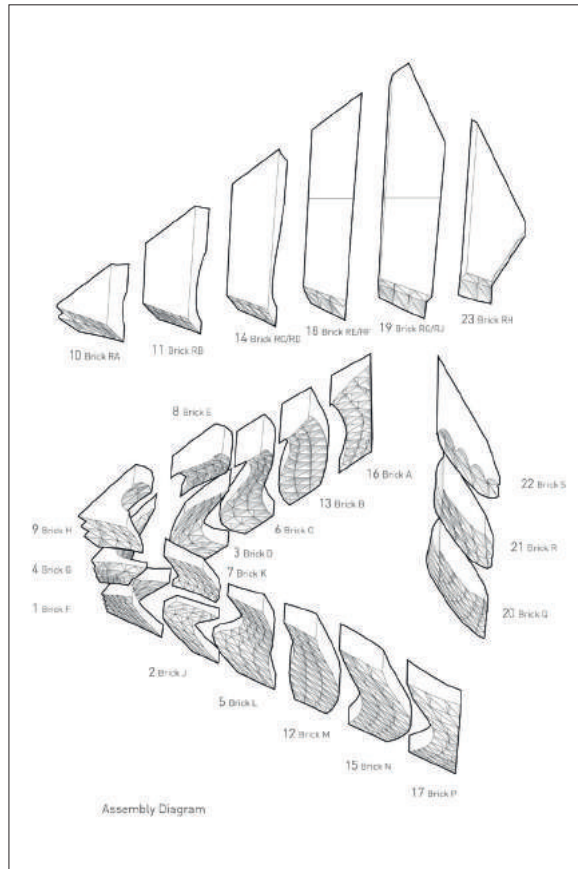

Fig. 8: Cut and painted sheets.



Fig. 11: One 'brick' partially completed.

Fig. 12: Despite the large scale of the structure, the pavilion remained very lightweight.



physical environment to the same status as site and program. Allowing this alternate structure for design to invade the design studio might raise alternatives to the still-prevalent sequence that begins with site analysis and massing sketches and ends with choices about material, detail and finish.

Eisenman posed mediated authorship as a way to free himself from his own intuition, but he also hoped to escape the constraints of dominant modes of production. The arbitrariness of the design process allowed him to temporarily ignore and potentially reinvent the way his own buildings are built.



Fig. 13: View through the structure on the New Haven central green.

Assembly suggested the reverse: that the imposed structure of digital fabrication enables its own form of mediated authorship. An expanded set of production techniques allows architects and students to transform the way they design. Even without rendering the design process explicit, digital modes of design and production may help students transcend the assumptions and brackets they bring to their work and reframe the way they make architecture.

CREDITS

The Assembly One pavilion was designed and built by Yale School of Architecture students.

PROJECT FOUNDERS: David Bench, Zac Heaps, Jacqueline Ho, Eric Zahn

PROJECT MANAGERS: Jacqueline Ho, Amy Mielke

DESIGN & FABRICATION: John Taylor Bachman, Nicholas Hunt, Seema Kairam, John Lacy, Veer Nanavatty

DESIGN: Rob Bundy, Raven Hardison, Matt Hettler

FACULTY ADVISOR: Brennan Buck

ASSISTANT: Teoman Ayas

CONSULTANT: Matthew Clark of Arup, New York

Photos by Chris Morgan Photography

NOTES

1 Greg Lynn's early experiments with alias software tracked the iterative deformation of primitive solids; Lars Spruybroek's vivisection structures, including his H₂O Pavilion, were defined by sequential ribs; Robert Somol has criticised digital technique for producing inaccessible, difficult architecture.

2 Alejandro Zaera-Polo, 'Eisenman's Machine of Infinite Resistance', *El Croquis*, 83 (1997), pp. 50–63.

3 Ibid.

4 Patrik Schumacher, *The Autopoiesis of Architecture. Volume II: A New Agenda for Architecture* (Chichester: Wiley, 2012), p. 338.

Fig.1: Carrier frame fabrication concept.

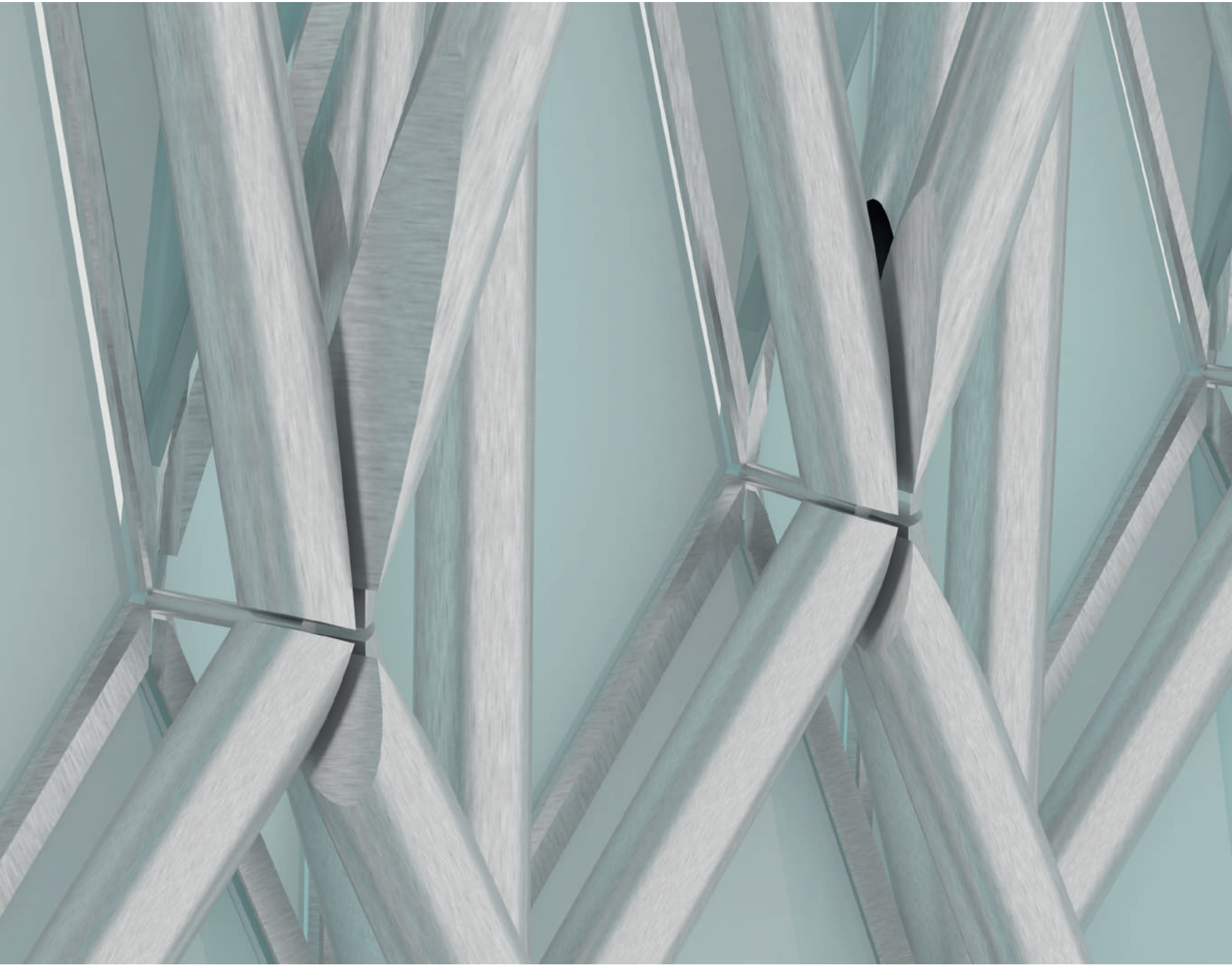

TOPO-FAÇADE: ENVELOPE DESIGN AND FABRICATION PLANNING USING TOPOLOGICAL MESH REPRESENTATIONS

GUSTAV FAGERSTRÖM, ERIK VERBOON (BURO HAPPOLD), ROBERT AISH (UNIVERSITY OF BATH)

Computational design tools based on Autodesk's DesignScript language have been used with geometry and topology modelling techniques in the design of a climatized free-form building envelope. This project involves structural and performance analysis tools applied to structural engineering, façade engineering and fabrication planning. The project has progressed from concept through tender phases. The particular geometry presented unique conditions that required non-standard solutions to be used; to this end DesignScript was introduced to allow the design and engineering team to build a number of scripted topological façade models that explored alternative façade configurations. This paper combines a discussion about the specific fabrication project with a more generalised discussion of the role of computational tools in design and fabrication. The main interest is to explore the two-way relationship between practice and tool building by considering how computation can contribute to a practical fabrication project and equally important, how computational tools can be tested and refined by being used in practice on demanding projects.

INTRODUCTION

FAÇADE ENGINEERING

The architectural concept used in this paper is based on a sculptural approach in which glass joints alternate between uniquely angled concave and convex relationships between adjacent panels (fig. 2).

The self-weight of the large insulated glass units (IGUs) demands a support strategy where the edge of each panel should be continuously supported. This requires that a strict geometric relationship be maintained between the glass and the support structure. Furthermore, the geometric conditions around each node are unique, being the simultaneous meeting point for both concave and convex glass panels. Consequently, each node, while based on a common topological principle, has a unique geometric configuration, and therefore requires the development of a unique fabrication geometry.

As a base constraint, the architect had instructed that a point-supported approach was undesirable and expressed a preference for the use of rectangular or plate primary structural elements as opposed to the more traditional round hollow section and spherical node approach often found in structures of this type. The subsequent studies looked at both structural approaches as a system that was offset from the glazing line.

The method for supporting the glass to the primary structure utilised continuous angles, or 'carrier frames' that followed and were structurally attached to the glass edges via structural silicone sealant. Periodic steel plates structurally linked the glass to the primary structure, while also addressing the



Fig. 2: Site context. (Image by courtesy of Robert A. M. Stern Architects.)

changing distance and angle between the two systems. The multiple angled relationships between glass panels required that the IGUs have stepping or cantilevered inner or outer lights in order to maintain a consistent external joint width.

DESIGNSCRIPT

DesignScript (as the integration of language, geometry, topology and plug-ins) allowed the engineering team to assess the geometric feasibility of the architectural concept by building a number of alternatively scripted topological façade models. This approach enables the team to model the correspondence between the façade topology and the physical components of the façade: glass panels as topological faces, structural members as topological edges and node connectors as topological vertices. DesignScript topology classes reveal the underlying functionality of the Autodesk Shape Managers (ASM) via its API.¹

The single topological mesh model allows each of the constituent components (face, edge or vertex) to make topological and geometric queries to the adjacent components – for example, the computation of average vertex normals and edge bisectors. Additionally, DesignScript is integrated with Robot Structural analysis and Performative Design and reveals user-oriented APIs directly to the engineers using DesignScript. This allows the single topological mesh model to be directly analysed both structurally and environmentally, while the mesh also forms the basis for related fabrication models.

APPLICATION: CASE STUDY

Typically, façades are modelled as meshes using the architect-established design surfaces (here represented by the front of glass). The structural support system is typically defined as an offset mesh from this defining mesh. The resulting structure is more easily realised if the defining mesh has ‘torsion-free’ nodes. This means that the vertex normals at the end of each edge are coplanar and the edge members are planar.

In some cases, a mesh with non-torsion-free nodes can be optimised by moving the vertex positions.² This approach is more appropriate where the mesh represents a smooth surface and the changes in vertex position (and hence the shape of the façade panels) is not visually apparent. However, the design intention for this façade is to create a very specific faceted configuration, which could not be optimised in this way.

In a non-torsion-free façade, the edge normal (as the bisector of the edge’s adjacent faces) and the vertex normals at either end of the edge are not coplanar. If the edge members

are planar and based on their respective edge normal, then the edge members meeting at a common vertex will not intersect along a common vector (fig. 3). Alternatively, if it is required that all edge members intersect at a common vector at each vertex, then the structural system has to resolve the twist along the edge members.

INITIAL STUDIES

A carrier frame and offset structure were considered. If the offset structure is based on a uniform offset from the face of the defining façade, then the edges of the offset may not lie on the face bisectors, and the relationship between the carrier frame and the offset structure may have to be designed to accommodate such deviations.

TOPOLOGICAL EXPLORATION

While these 2D studies were conceptually useful, a 3D approach was necessary to address the multiple unique conditions imposed by the geometry. Building on this exploratory work, a scripted approach was developed, harnessing mesh topology and allowing for the automated creation of panels from mesh faces, structural members from mesh edges and connector nodes from mesh vertices (fig. 4).

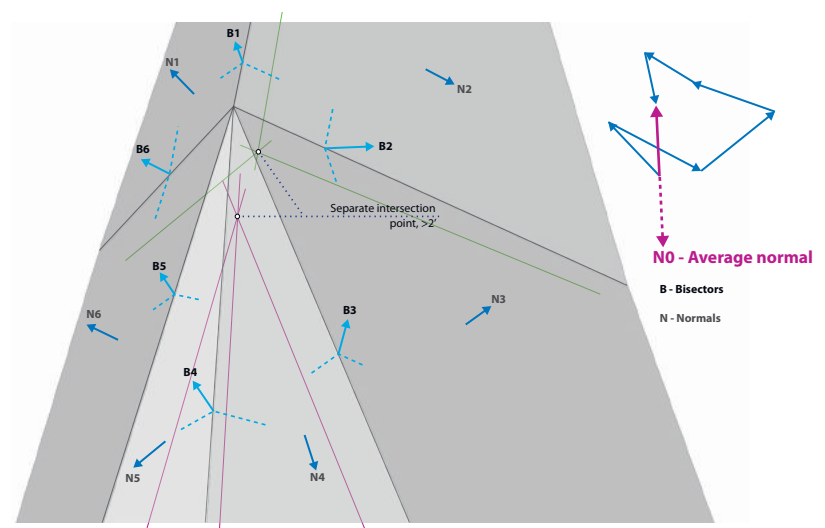
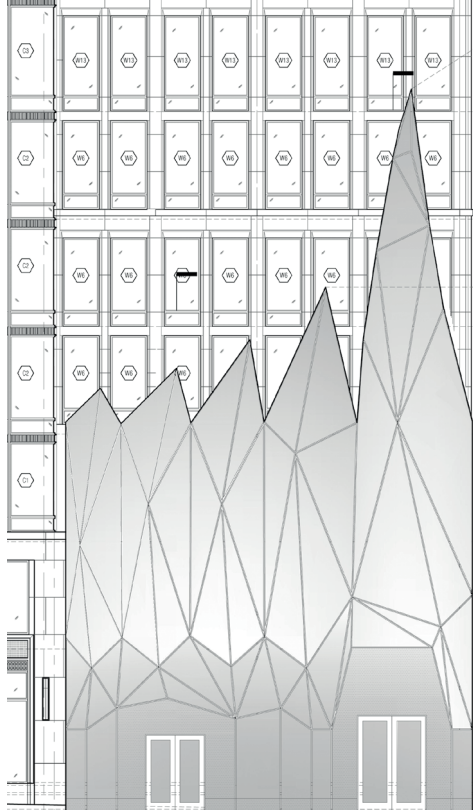

Fig. 3: Characteristics of non-torsion-free geometry, average node vertex normal principle and edge face bisectors.



label	X coord	Y coord	Z coord	label	vertex 0	vertex 1	vertex 2
0	1277.561	2037.24	168.453	0	0	1	74
1	1266.261	2102.74	240.453	1	74	62	0
2	1229.501	2068.74	82.953	2	1	4	74
3	1229.5	2042.74	82.953	3	5	6	0
4	1205.5	2102.74	168.453	4	6	1	0
5	1265.561	1996.74	216.453	5	7	8	9
6	1277.501	2035.41	411.729	6	8	10	9
7	1228.181	2137.73	770.118	7	10	11	9
8	1169.725	2141.8	712.322	8	11	7	9
9	1198.331	2142.56	799.371	9	12	7	11
10	1175.378	2187.31	718.136	10	10	12	11
11	1194.662	2150.74	848.706	11	13	14	15
12	1228.405	2163.63	776.349	12	15	16	17
13	1229.502	2242.75	239.081	13	16	18	17
14	1229.502	2242.75	82.953	14	8	19	20
15	1277.501	2207.06	180.453	15	21	8	20
16	1277.501	2155.55	438.638	16	19	22	20
17	1229.502	2242.75	240.453	17	23	21	20
18	1229.524	2242.75	447.953	18	24	25	26
19	1196.614	2115.48	556.077	19	22	24	26
20	1144.17	2155.55	447.953	20	27	28	29
21	1169.074	2203.48	627.055	21	25	27	29
22	1181.5	2102.74	447.953	22	30	31	32
23	1144.045	2242.75	447.953	23	28	30	32
24	1265.5	2053.29	616.57	24	33	34	35
25	1181.5	1996.74	447.953	25	31	33	35
26	1144.045	2038.57	447.953	26	16	36	18
27	1253.5	1974.92	550.893	27	36	21	18
28	1181.5	1915.74	447.953	28	23	18	21
29	1144.045	1961.4	447.953	29	37	38	28
30	1241.5	1897.72	515.382	30	38	39	31
31	1181.5	1834.74	447.953	31	38	30	28
32	1144.044	1886.3	447.953	32	38	31	30
33	1229.5	1827.5	500.346	33	25	6	5
34	1181.5	1776.69	447.953	34	5	40	25
35	1144.5	1815.88	447.953	35	40	37	28
36	1253.561	2193.52	634.082	36	39	41	31
37	1265.56	1915.74	216.453	37	6	22	1
38	1277.5	1862.67	308.453	38	16	1	22
39	1265.56	1834.74	216.453	39	6	24	22
40	1277.5	1948.67	351.003	40	19	16	22
41	1277.5	1783.5	301.964	41	6	25	24
42	1230.811	1762.7	321.634	42	40	27	25
43	1109.5	1776.65	447.953	43	40	28	27
44	1109.499	1762.73	321.634	44	41	33	31
45	1229.501	2216.75	82.953	45	41	34	33

Fig. 4: Design geometry expressed as topology mesh.

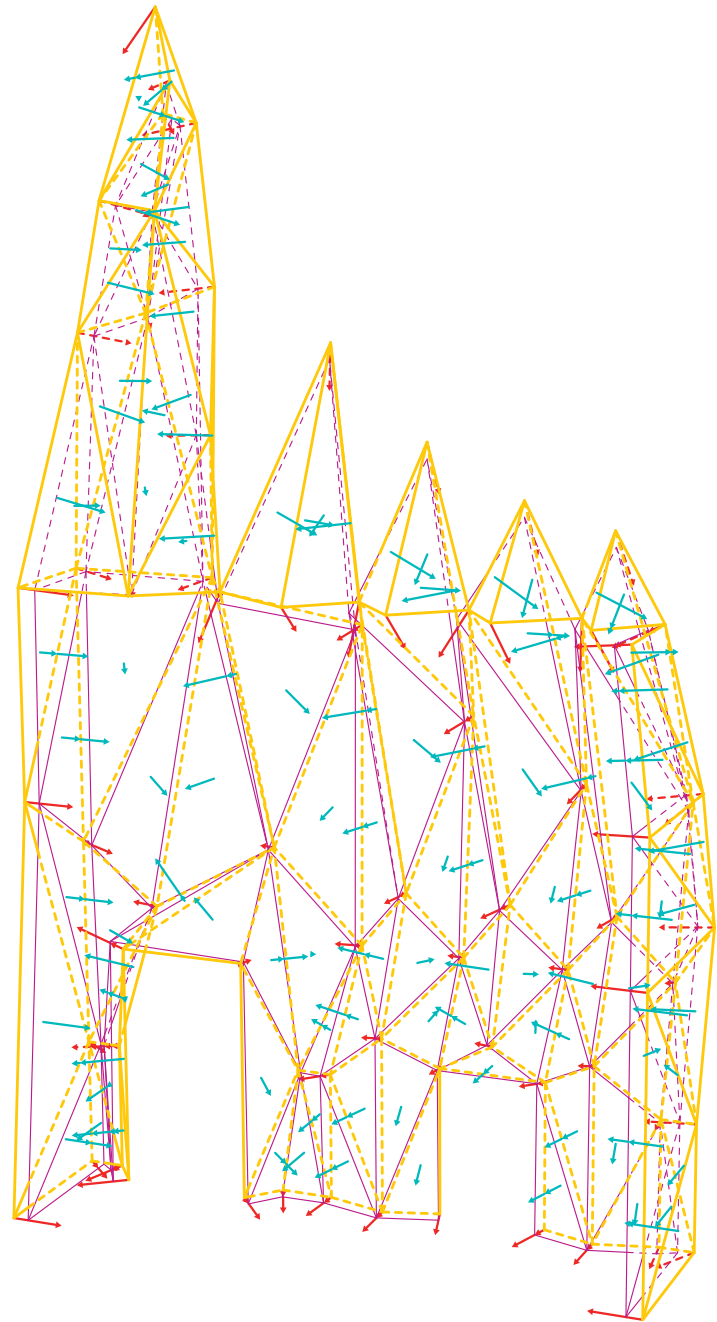

Fig. 5: The mesh topology used to define the façade.

Orange lines: the edges of the primary façade mesh (front of glass)

Red lines: the average vertex normals

Cyan lines: the weighted average vertex normals (weighed by the face areas)

Magenta lines: the offset mesh (used to define the offset structure; based on offsetting the vertices of the primary mesh along the weighted average vertex normals)

STRUCTURAL HYPOTHESES

The edge-based structural system has to support one or two planar sheets of glass and the twist between the vertices at its ends. The question remains: Should there be a single edge member that combines all these roles or a carrier frame to support the planar glass linked to a separate structural member to accommodate the twist?

Four structural hypotheses were considered:

- Carrier frame and plate oriented along the edge normal (fig. 6).
- Carrier frame and plate twisting to accommodate both end points' vertex normals (fig. 7).
- Chamfered tube with chamfer axis using the average vertex normal (fig. 8).
- Offset structure and carrier frame, with offset node connectors based on the average vertex normal (figs. 9, 10).

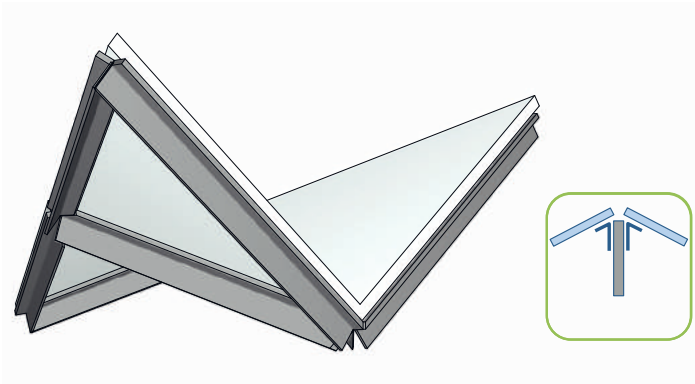

Fig. 6: Structural hypothesis 1 – carrier frame and plate, with the plate oriented along the edge normal.

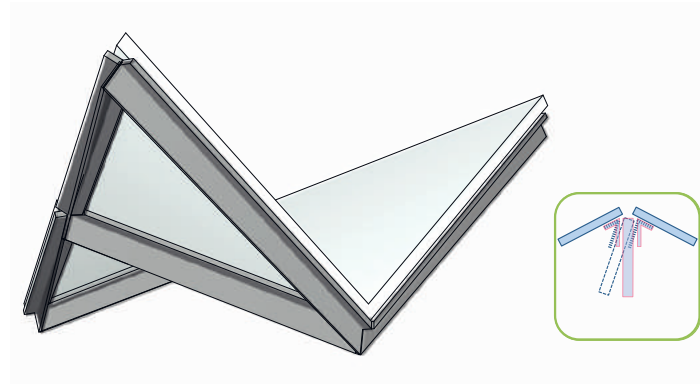

Fig. 7: Structural hypothesis 2 – carrier frame and Plate, with the plate twisted between the end points' non-coplanar vertex normals.

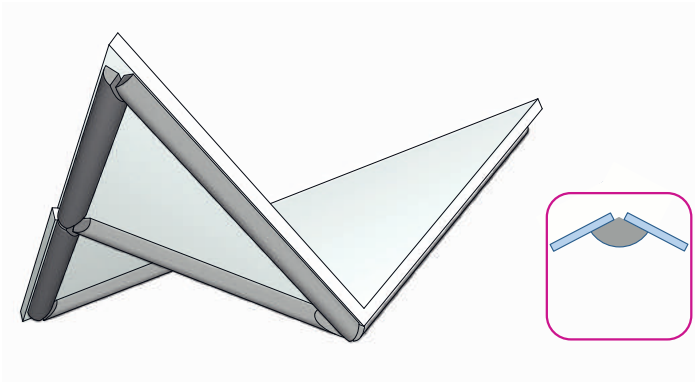

Fig. 8: Structural hypothesis 3 – chamfered tube with chamfer axis using the average vertex normal.

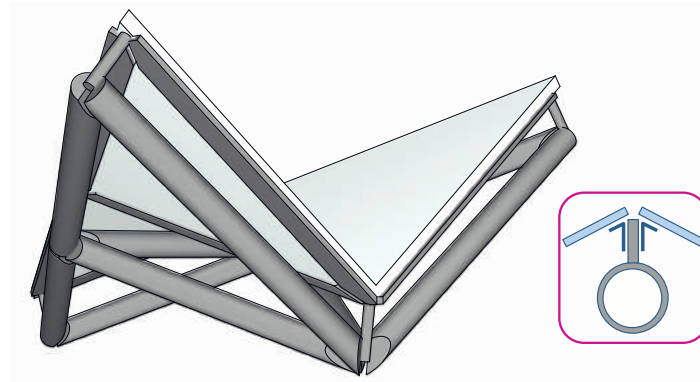
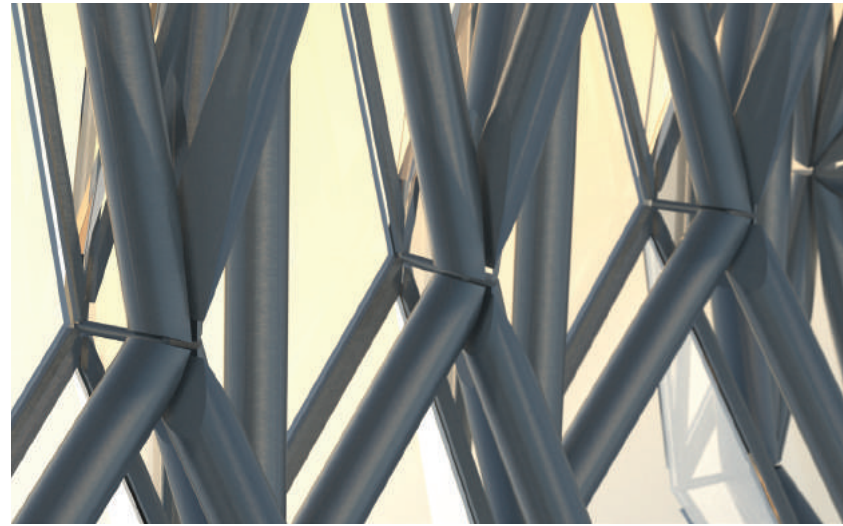
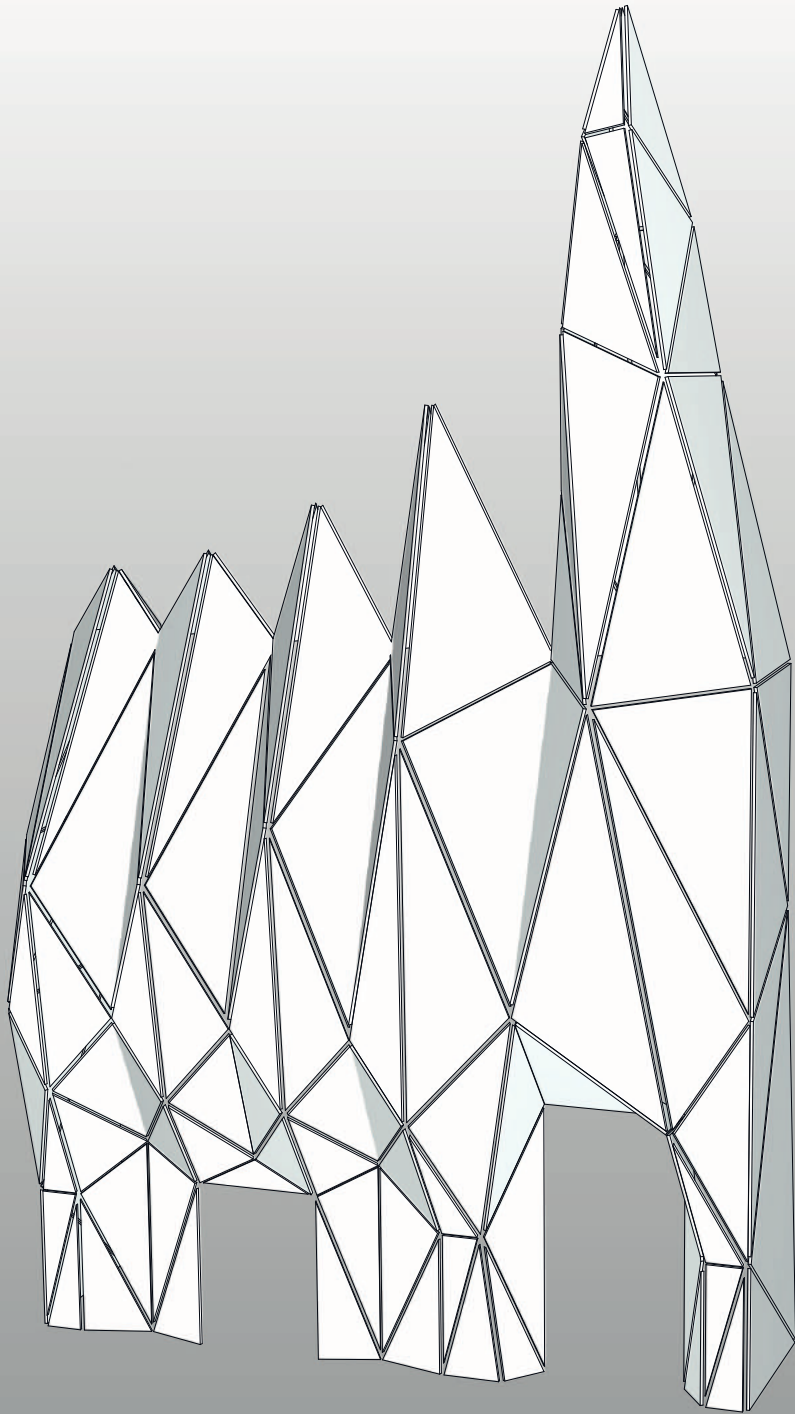

Fig. 9: Structural hypothesis 4 – offset structure and carrier frame, with the offset node connectors based on the average vertex normals.



Figs.10–12: Design development model with offset structure and carrier frame fabrication concept.

Bracket length	Carrier angle	Position
7.204577	112	A11-1
9.277795	114	A11-2
8.996179	140	A11-3
8.973133	52	B7-1
6.642246	83	B7-2
8.632262	22	B7-3
6.056679	85	B2-1
6.814823	154	B2-2
7.22186	40	B2-3
8.648544	131	A9-1
8.918658	71	A9-2
6.064782	47	A9-3
6.664838	152	A8-1
7.675841	37	A8-2
6.426951	102	A8-3
9.645642	48	T2-1
6.832239	26	T2-2
7.152264	133	T2-3
7.25188	126	T9-1
7.055309	43	T9-2
6.64823	27	T9-3
7.916496	46	T2-1
8.305637	40	T2-2
9.694806	18	T2-3
8.837067	52	C5-1
6.535089	78	C5-2
6.896258	133	C5-3
8.967901	42	D5-1
7.42581	114	D5-2
8.955504	141	D5-3

Fig. 13: Numerical output complementing or replacing traditional shop drawings.

FABRICATION PLANNING

Moving forward into fabrication planning with hypothesis 4 (above), the process was reversed with respect to that outlined in fig. 4. The topologically represented structure is now the source of an additional level of information describing the carrier brackets' length, shape, angle and position within the overall assembly. The resulting information package (fig. 13) can be used in conjunction with – or entirely in lieu of – traditional shop drawings.



Fig. 14: Diagram outlining DesignScript data flow graph used as a visual programming interface (top) as well as its 'node to code' functionality (bottom), allowing the designer to selectively replace all or part of a graph node diagram with the corresponding code, thus making it possible to reduce visual clutter and progress to a more succinct form of design computation.

THE ROLE OF DESIGNSCRIPT

DesignScript provides a familiar 'data flow' approach to design computation and makes the creation and execution of design logic accessible to designers with little or no programming experience. In this project, data from the input nodes in the top left part of the graph 'flows' via intermediate mesh modelling nodes to create the facade in the bottom right part of the graph (fig. 14).

The 'data flow' approach works well with simple models. However, usability issues begin to emerge when the problem being addressed gets more complex and there are many more nodes to consider. This issue is addressed through the 'node to code' functionality in DesignScript, which automatically translates the user's data flow diagram into an associative script (fig. 12). DesignScript also includes support for regular imperative scripting using conventional 'for' loops (for iteration) and 'if' statements (for conditionals).³

CONCLUSIONS

This project demonstrates that script-driven topology can be used as the central representation for geometric assessment, structural analysis, performative analysis, fabrication planning and component engineering, ultimately providing an effective way to realise a challenging façade.

More generally, it is recognised that computation is driving more aspects of contemporary architectural and engineering practice. The contribution of DesignScript is to unify computation, geometry and topology with alternative programming interfaces (both visual and textual) and thereby support different levels of computational skill.

It is important to reflect on the results of this work. At one level, it is the physical building. At another level, it is the opportunity this project provided to test and refine a new generation of computational design tools. But maybe the most important result is the acquisition of knowledge and skills made by the practitioners. All three results have the potential to contribute to even more challenging projects.

ACKNOWLEDGEMENTS

DesignScript Development Team, Autodesk Singapore Research & Development Centre

Andrew Marsh for the Performative Design plug-in for DesignScript

Al Fisher and Buro Happold Bath for the Autodesk Robot Structural Analysis plug-in for DesignScript

Buro Happold New York Structures and Façades groups

Robert A. M. Stern Architects

DesignScript is available at Autodesk Labs, <http://labs.autodesk.com/utilities/designscript/>

Additional information and plug-ins for DesignScript are available at <http://www.designscript.org/>

NOTES

¹ Robert Aish and Aparajit Pratap, 'Spatial Information Modeling of Buildings using Non-Manifold Topology with ASM and DesignScript', in *Proceedings of Advances in Architectural Geometry* (Paris: Springer, 2012), pp. 25–36.

² Johannes Wallner and Helmut Pottman, 'Geometric Computing for Freeform Architecture', *Journal of Mathematics in Industry* 1, no. 4 (2011).

³ Robert Aish, 'DesignScript: A Learning Environment for Design Computation', in Christoph Gengnagel, Axel Kilian, Julien Nembrini and Fabian Scheurer, eds. *Rethinking Prototyping: Proceedings of the Design Modelling Symposium, Berlin 2013* (Berlin: epubli, 2013) [e-book].

Fig. 1: Photograph showing timber grid shell structure over the central third of the roof. Construction progress mid November 2013. (Photo: Nigel Young / Foster + Partners.)



BALANCING COMPLEXITY AND SIMPLICITY

JONATHAN RABAGLIATI (FOSTER + PARTNERS, LONDON), CLEMENS HUBER (WIEHAG, AUSTRIA)
DIETER LINKE (SEELE, AUSTRIA)

Foster + Partners were commissioned in 2008 to design a mixed-use scheme encompassing the over-ground elements of a new station for the Crossrail project at Canary Wharf. This paper, co-authored by Foster + Partners, Wiehag and seele, explores the process of how the design of the overall geometry of the project and detailed design for fabrication and installation were a careful balancing of complexity and simplicity of form and logics, marrying sophisticated computational techniques with appreciation that inevitably realisation still needs human hands for machining and installation.

CONCEPT

In 2008, Foster + Partners were commissioned to design a mixed-use scheme encompassing the over-ground elements of a new station for the Crossrail project at Canary Wharf. The design ties together a number of elements: the station access and bridging connections, retail spaces and, above these, cafés and restaurants with, central to the whole space, a park open partially to the sky.

The most prominent feature of the design is the timber lattice roof, which arches 30 metres over the landscaped park and wraps down around the concrete substructure. The deep timber glulam (glued laminated timber) beams support large triangular ethylene tetrafluoroethylene (ETFE) cushions, which are inflated to give the building a dynamic appearance. The layer of ETFE is punctuated by openings, for bridges to the station entrance, views out from the cafés, to draw light into the park and rain for natural irrigation. Generating both rhythm and visual drama, the 310-metre long timber grid shell cantilevers out over the water at each end of the structure. A striking urban image is created of timber beams rising from the ripples of the dock with green foliage behind an ETFE canopy against a backdrop of steel and glass towers (figs. 2, 3).



Fig. 2: Rendering showing Foster + Partners design for roof enclosure cantilevering out over the water of the North Dock, Canary Wharf. (Photo: Methanoia / Foster + Partners.)



Fig. 3: Photograph of site showing construction progress mid-November 2013. The photograph shows the concrete substructure with end pavilion steelwork, station extractor cladding and the timber beams in the central section installed. (Photo: Nigel Young / Foster + Partners.)

DESIGN

This article explores how the project negotiates between simplicity and complexity through the process of design, right through from fabrication planning to installation. The form of the enclosure balanced the overall level of geometric complexity of nodes and timber with the ETFE material constraints and the architectural vision for a diagrid culminating in arching cantilevers at each end. The final form of the roof was arrived at by Foster + Partners in close dialogue with the ETFE cladding experts, se-austria, and the timber specialists, Wiehag, who partnered on the project to establish a joint venture. With the timber and the ETFE tendered as a single package, the geometry and detailing could be optimised to suit both systems.¹ By pushing the limit of maximum cushion sizes, a geometry was created by Foster + Partners whereby in the central section of the roof, the geometry of the nodes in each row is identical, but there is a seamless transition as the triangles accelerate outwards in length towards the cantilevers. This imperceptible transition was achieved using a relaxation exercise utilising the spring-based physics engine Kangaroo, developed by Daniel Piker.² The consequence of this design tuning is that when one reads the lines of the diagrid, they flow smoothly in curves around the barrel of the roof.

The realised geometry appears simple, but there is a degree of complexity that belies the simplicity of the overall form. The axis of each successive diagonal beam twists as it coils around the roof. As timbers extend in length towards the cantilever,

the incoming angles at nodes get successively more acute and asymmetric. Even in the central section where the geometry repeats, the configuration of holes in the roof means that nodes with two, three, four, or five connecting beams sit alongside the typical nodes with six. Figure 1 shows a node connecting six beams installed in position. Figure 4 shows the node chosen for a mock-up connecting five beams. What Foster + Partners issued as the defining centreline geometry became referred to as the architectural axis. From this, the precise logic of offsets for the ETFE and the timber were then agreed.

Due to the roof diagrid's triangular topology, the ETFE aluminium extrusions and timber beams have deviating axes. This deviation is determined by the distance from the architectural axis model. For simplicity of fabrication, se-austria proposed that support brackets for the ETFE aluminium extrusions be the same height across the entire building. To achieve this, the level of the horizontal timber beam's top surface was defined in accordance to the width of the ETFE aluminium extrusion. The boundary conditions needed to support the ETFE film were then the driving factor in determining tolerance allowances for ETFE aluminium extrusions, brackets and supporting timber structure.

Fig. 4: Photograph showing mock-up of single node (ID 28) with five connecting timber glulam beams. The mock-up shows the ETFE frames, ETFE cushion fabric, timber flashings, and air distribution system integrated into support brackets. Visible also is the deviation of the timber and ETFE frame axes along the diagonal beams. (Photo: Nigel Young / Foster + Partners.)



STRUCTURAL ANALYSIS

From a structural point of view, the analysis of the timber structure was extremely challenging. In simple structures, the load paths are very clear. For this structure with multiple degrees of indeterminacy, the stiffness of each element, especially of connection elements, influenced how the loads were distributed. If the stiffness is increased at one location, it attracts higher forces and simultaneously neighbouring areas will see reduced forces. The stiffer an element is, the more load it attracts and the more the connection element has to be reinforced. It is a dynamic process to reach a resolved model where everything is in balance with the right stiffness determined at each point, a process demanding many iterative loops.

For the timber screws that connect the timber beams to the steel nodes, determining stiffness parameters was an equally exacting process. The screw plates are loaded in all directions. In addition to the major axial forces (tension and compression), there are bending moments in all directions in major and minor axes and also torsion moments and shear in all directions. The timber has to support the forces created by the ETFE cushions, which create horizontal forces due to internal pressure. Furthermore, if a timber supports only one cushion, the offset horizontal loads generate torsion moments in the timber beams. The stiffness of the bearing structure also has an influence on the design of the roof element, and differences in stiffness across the supporting structures compounded the challenges for analysis.

To give an idea of the numbers: there are close to 1500 timber elements, each with two ends, which is roughly 3000 ends of timber members with connections. For each connection there are 12 different major load combinations that must be considered – derived from a total of 400 load combinations calculated for a single glulam element using an add-on of the structural analysis software Rstab.³ Multiply 3000 by 12 and there are 36,000 different checks to make each time the analysis is run (carried out in Excel). Furthermore, there are four different models for the entire structure because of different shrinkage possibilities for the concrete substructure.

With the continual analysis and design loop, Wiehag needed to work in a parametric way, linking CAD and structural analysis models. The approach used Excel as the central data hub. Macros in Excel were used to generate the geometric set-out. Wiehag's software providers, Bocad, were commissioned to develop an add-on that enabled the generation of members in the CAD programme directly from the Excel input. Wiehag could also take advantage of an existing link into the structur-



Fig. 5: Photograph showing computer monitoring of machined timber for grade evaluation and visual inspection, including numbers of knots and other defects. Wiehag Factory, Altheim, Austria. (Photo: Nigel Young / Foster + Partners.)

al analysis software Rstab. In the Excel sheets, information included everything from timber quality, strength, dimensions, etc., right through to which lorry the timber would be carried on when transported to the site.

TIMBER FABRICATION

At Wiehag's factory (fig. 6), the glulam process for straight beams is almost 100% automated. Figure 5 shows how every board is scanned and tested for timber strength and visual aspects, including number of knots and other defects.⁴ This is all checked by machine and stored digitally to guarantee the required strength class of the final glulam element.⁵ Timbers are planed, glue applied and then pressed, all in a fully automated process. A five-axis computer numerical control (CNC) robot is used (fig. 7) to cut the beams to length and machine all required workmanship, including blind holes and milling grooves. Wiehag built translators so the Excel information could drive the CNC machine directly when cutting all the standard dimension timbers to length. With so much of the process automated and the experience gathered from previous projects, in particular, the Ice Park project in Eilat, Israel, completed in 2013, Wiehag are very confident about achieving very tight tolerances.⁶ Even for curved beams, the process is largely automated. The shape of the reconfigurable mould is transferred from CAD so the curvature can be digitally controlled. The centreline issued by Foster + Partners goes directly from file to factory.



Fig. 6: Photograph showing machined glulam beams awaiting attachment of end plates. This process involves screwing in timber screws using a hand-held drill. Stacked in the background are timber planks that have arrived directly from the sawmill. Wiehag Factory, Altheim, Austria. (Photo: Mitterbauer.)



Fig. 7: Photograph showing five-axis computer numerical control (CNC) robot slotting machine used to cut the beams to length and machine all required workmanship, including blind holes and milling grooves. Wiehag Factory, Altheim, Austria. (Photo: Mitterbauer.)

COMPUTATIONAL TECHNIQUES

Foster + Partners used computational techniques from the outset in the design of the roof – the entire geometry was generated by code. The use of scripting, particularly as a design approach, provided many benefits. It facilitated design fluidity whilst maintaining a system of rigour capable of resolving thousands of complex geometric relationships. The approach promoted a much more systemic and algorithmic way of thinking. This design approach has been articulated by other authors, including Burry,⁷ Reas⁸ and Coates.⁹ Rather than framing worst-case or typical scenarios, it helped to synthesise designs into an overarching set of logics. Logics could then be prototyped and many different design instances instantaneously generated and assessed. These logics were then able to be codified and communicated via geometry method statements.¹⁰ With the fabricators also adopting the same approach, Foster + Partners and specialist ETFE/timber contractors were able to communicate at the level of logics. With design data easily shared via Excel spreadsheets and 3D models, designs were able to be refined to a high level.

ETFE DESIGN PROCESS

Having defined the setting-out logics for the horizontal timbers, se-austria's first design task was to prototype and test an aluminium extrusion that would be watertight in any orientation and would also allow quick and easy installation. To minimise the sealing jobs during the winter installation on site, the design of the aluminium extrusion had to be adaptable enough to produce 540 welded nodes of varying geometry. To optimise the first line of defence, se-austria designed a new watertight cover gasket and new cover plates with special joint elements, which also required a new concept for installing the ETFE cushion corners. In providing the watertight second line of defence, almost all the machining and assembly was designed to be completed within the factory. Only the rectangular joint between the extrusion elements is required to be sealed on site, using standard silicone flaps.

The performance of this system was proven to the client with a mock-up, which consisted of six small cushions orientated around the node with the most asymmetric geometry. The mock-up was exposed to rigorous watertightness tests with low pressure in the chamber and full wind deflection with an aircraft propeller simulated storm (fig. 8).

The computational approach was applied successfully to a number of fabrication planning tasks. All the 11,000 patterns for the 780 ETFE cushions' outer and inner layers and the 1560

shop drawings for the ETFE welding assembly were generated via scripts. se-austria commissioned scripts to generate the bracket positions connecting ETFE extrusions to the timber beams. With 1400 extrusions and great variations in length, the exercise allowed the calculation of 8500 bracket locations such that the positioning matched the varying steel node sizes of the timber structure. The code also batched the ETFE extrusions to give maximum numbers of same length sections to simplify cutting.

DESIGN FOR FABRICATION

Knowing where to focus the complexities and where to keep things simple is about astute design decision-making. With the option to use five-axis machines for fabrication of the extrusion node connections, se-austria moved all the complexities into the extrusion node arms, resulting in very simple shop works for all other parts. The machining of all 1400 node arms was programmed and .stp files delivered to the fabricator. The five-axis CNC machines completed all the complex milling, cutting and drilling in preparation for hand welding. The step files also contained data for assembly marks to be milled into each element's surface, which clearly indicated element ID, orientation and the position at which they had to be welded together. This eliminated any need for measurements during the assembly and welding process. Only checking dimensions were given for quality control. As a result, the welded node arm's ends deviate less than 1 mm from the theoretical positions, despite their complex three-dimensional shape and wide variation in angles.

The use of computation extends beyond the design and fabrication stage. The coordination of elements arriving at a site is a massive logistical exercise. Set-up of a consistent marking system was one of the first considerations at the commencement of the project. All suppliers were given listings to deliver their production elements in the right order and they received clear definitions about packing details to match the needs on site. Software supported the planning process as well as providing capability for of all sorts of volume surveys.

CONCLUSION

The dominant thought for most of the twentieth century was that only repetition could achieve economies of scale. With the development of advanced computation and digital fabrication, new possibilities have emerged to allow digital design to interface with digital manufacturing and to allow production to be coordinated from file to factory to site. This is opening up



Fig. 8: Performance test of node connection with six ETFE cushions with low negative pressure in the chamber and full wind deflection with an aircraft propeller simulated storm. (Photo: se-austria.)



Fig. 9: Photograph capturing an array of nodes stored on site awaiting installation. Clearly seen is the differentiation of node geometry and variation in number of connection arms. (Photo: Nigel Young / Foster + Partners.)

the possibility for the production of differentiated geometries more economically.¹¹ Yet when designing, we now find ourselves on a threshold when it is not always possible to predict which route will offer greatest benefits. Often, it is a combination of both. Indeed, this project straddles between these two paradigms with design continuously negotiating between repetition and differentiation in logics and form.

The conundrum is that to optimise designs for fabrication, installation and quality of construction, it is necessary to carefully and deeply think through each step of the project's full fabrication and installation process. For only with this insight is it possible to understand the full implications of the design and to determine the costs of production. Yet, at a time when digital fabrication technology is evolving fast and with each fabricator tuned in to different processes, it is often only once

tender or sub-tender packages are awarded that designs can be genuinely optimised (re-designed) to take advantage of fabricators' unique affordances. What is complex for one fabricator is routine for another and vice versa. Design must negotiate its way whilst remembering that inevitably realisation still needs human hands for machining and installation. The investment in procedures that minimise the potential for mistakes and help organise on-site processes is therefore a key component of the project's design thinking.

For Wiehag, on-site installation began on site on 5 August 2013 and the entire timber structure is scheduled to be completed by 14 February 2014, the time of the Fabricate Conference 2014. Installation of ETFE and other cladding elements by se-austria began at the end of September 2013 and will be completed ready for final handover scheduled for 4 April 2014.

Fig. 10: Photograph capturing on-site installation process for nodes using crane and cherry picker. (Photo: Nigel Young / Foster + Partners.)



PROJECT CREDITS

Canary Wharf Crossrail Station

LOCATION: Canary Wharf, London

PROJECT TIMELINE: 2008–2018

NUMBER OF STRUCTURAL STEEL NODES: 564 of which there are 348 types.
The maximum number of one type is 25.

NUMBER OF GLULAM TIMBER BEAMS: 1418 of which 4 are singly curved
LENGTH OF ROOF: 310 m

TIMBER SPECIES AND GRADE: Spruce, grade varies subject to degree
of exposure

Oversite Development Team

CLIENT/DEVELOPER: Canary Wharf Group plc

DESIGN ARCHITECT: Foster + Partners

EXECUTIVE ARCHITECT: Adamson Associates

Structural and MEP Engineer: Arup

LANDSCAPE ARCHITECT: Gillespies

SPECIALIST CONTRACTOR (Timber/ETFE): Wiehag/se-austria (seele)

MAIN CONTRACTOR: Canary Wharf Contractors Ltd

NOTES

1 For information detailing Foster + Partners' design approach up to the tender phase, see the following: Jonathan Rabagliati, 'Sculpting with the System, Retail and Park Development above Canary Wharf Crossrail Station', in *C3 Architecture-Landscape-Urbanism*, 313 (September 2010), pp. 120–7.

2 Daniel Piker, 'Kangaroo: Form Finding with Computational Physics', in *Architectural Design*, 83/2, (2013), pp. 136–7 (special issue: 'Computation Works: the Building of Algorithmic Thought').

3 BS EN 1995-1-1+A1:2008/NA:2006. Design of timber structures – Part 1-1: General – Common rules and rules for buildings.

4 Production codes:

BS EN 14080:2005. Timber structures – Glued laminated timber – Requirements.

BS EN 14081-1:2005+A1:2011. Timber structures. Strength graded structural timber with rectangular cross section. General requirements

BS EN 14081-2:2010+A1:2012. Timber structures. Strength-graded structural timber with rectangular cross section. Machine grading; additional requirements for initial type testing.

BS EN 14081-3:2012. Timber structures. Strength-graded structural timber with rectangular cross section. Machine grading; additional requirements for factory production control.

BS EN 14081-4:2009. Timber structures. Strength-graded structural timber with rectangular cross section. Machine grading. Grading machine settings for machine controlled systems.

5 Design code BS EN 1194:1999-09. Timber structures – Glued laminated timber – Strength classes and determination of characteristic values.

6 Angela Trinkert, 'Eiseskälte unterm Kuppeldach. Freizeitbau', *Bauen mit Holz*, 115/3, (2013), pp. 20–3.

7 Mark Burry, *Scripting Cultures: Architectural Design and Programming*, Ad Primers. (Chichester: Wiley, 2011).

8 Casey Reas, Chandler McWilliams, and Jeroen Barendsee eds., *Form + Code in Design, Art, and Architecture* (New York: Princeton Architectural Press, 2010).

9 Paul Coates, *Programming Architecture* (New York: Routledge, 2010).

10 For further description of geometry method statement, see: Brady Peters, 'The Copenhagen Elephant House: a Case Study of Digital Design Processes,' in Andrew Kudless, Neri Oxman and Marc Swackhamer, eds., *Silicon + Skin – Biological Processes and Computation: Proceedings of the 28th Annual Conference of the Association for Computer-Aided Design in Architecture, October 16–19, 2008, Minneapolis, Minnesota* (Morrisville, North Carolina: Lulu Press, 2008), pp. 134–41.

11 Greg Lynn, ed., *Archaeology of the Digital: Peter Eisenman, Frank Gehry, Chuck Hoberman, Shoji Yoh* (Montréal: Canadian Centre for Architecture; Berlin: Sternberg Press, 2013), p. 107.

Fig. 1: A single, intricately detailed timber segment of the D1 canopies (see note 8 and fig. 11). More than 600 individual segments were parametrically modelled in Rhinoceros and brought into Lignocam for fabrication using a predecessor of Woodpecker. (designtoproduction.)

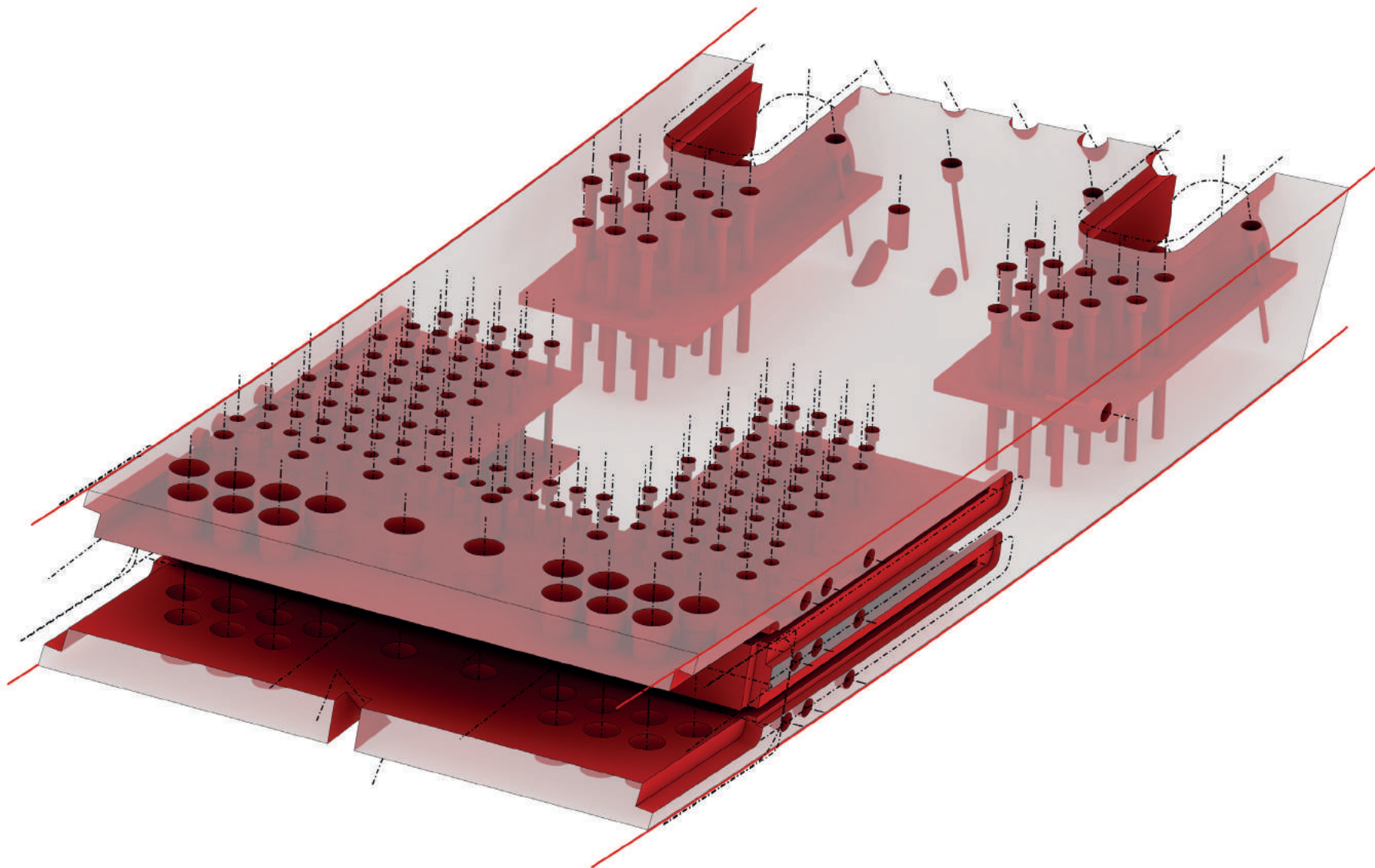

BRIDGING THE GAP FROM CAD TO CAM: CONCEPTS, CAVEATS AND A NEW GRASSHOPPER PLUG-IN

HANNO STEHLING, FABIAN SCHEURER (DESIGNTOPRODUCTION), JEAN ROULIER (LIGNOCAM)

The advent of parametric modelling in architecture has opened up a whole new world to designers. By defining geometric dependencies instead of final shapes, highly complex structures can be described with justifiable effort, and breaking them down into thousands of individual components has become a manageable task even with standard CAD software. At the other end of the workflow, the same can be said for fabrication, where computer-controlled (CNC) machines produce customized parts at the speed and cost of serial production. However, even in the digital age the transition from design to manufacturing still is a weak link, at least when more complex operations and large quantities of individual components are required. This paper discusses workflows from CAD to CAM and CNC fabrication based on the example of the timber building sector. In the second part, a newly developed timber fabrication plug-in for the popular parametric modelling environment Grasshopper is presented.

INTRODUCTION

The advent of parametric modelling in architecture has opened up a whole new world to designers. By defining geometric dependencies instead of final shapes, highly complex structures can be described with a justifiable effort, and breaking them down into thousands of individual components has become a manageable task even with standard CAD software.

At the other end of the workflow, the same can be said for fabrication, where computer-controlled (CNC) machines produce customised parts at the speed and cost of serial production. However, even in the Digital Age, the transition from design to manufacturing is still a weak link, at least when more complex operations and large quantities of individual components are required.

Uninterrupted digital chains from design models to machined parts are still largely limited to the academic field of research pavilions and the like, where the exact parameters of fabrication are known from the very beginning (or might even be the basis for the design), where tight feedback loops from fabrication back into design are unproblematic and where processes are allowed to be highly experimental. In large-scale real-world projects none of this usually is the case.

This paper discusses the workflows from CAD to CAM and CNC fabrication based on the example of the timber building sector. In the second part, a newly developed timber fabrication plug-in for the popular parametric modelling environment Grasshopper is presented.

DIGITAL WORKFLOWS IN TIMBER FABRICATION

The timber sector has been pioneering digital fabrication in the building industry for the last two decades. Today CNC manufacturing on three- and five-axis machines is very common, even in medium-scale carpentries, and specialised joinery machines are used to process beams. Due to their precision and efficiency, these machines have even managed to bring back traditional timber detailing like pegs, lap joints and dovetails, which had been almost completely replaced by fixing plates and other engineering solutions. Domain-specific CAD programs are tailored to support the traditional workflows and provide the necessary data for machining. While this works reasonably well for established timber construction systems, such as balloon and platform framing (and nowadays larger prefabricated wall elements), the step from geometric definition to execution on a CNC machine remains cumbersome when it comes to non-standard applications.

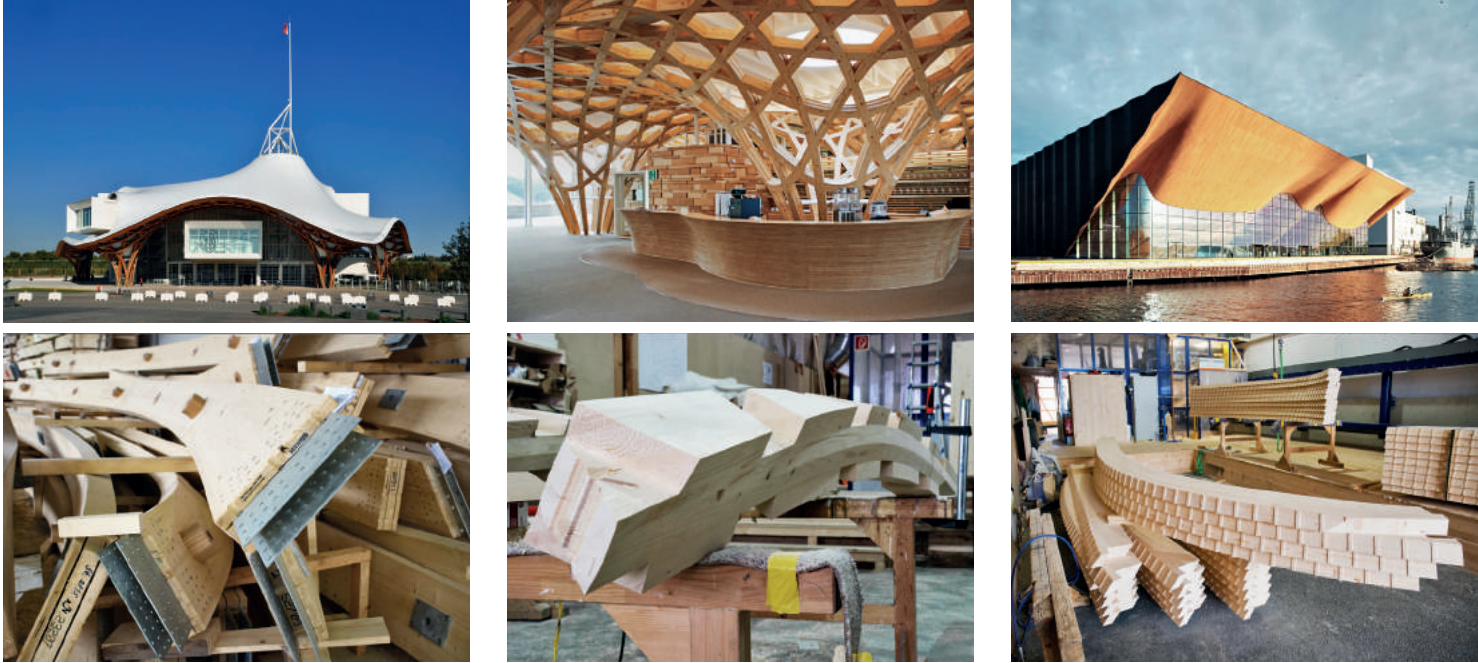

Fig. 2: Examples of large-scale timber structures realised by means of parametric modelling and digital fabrication. From left to right: Centre Pompidou Metz (Shigeru Ban and Jean de Gastines, Metz 2010); Heasley Nine Bridges Golf Club (Shigeru Ban and KACI International, Yeosu 2009); Kilden Performing Arts Centre (ALA Architects, Kristiansand 2012).

(Photos: top left: SJB Kempter Fitze, top center: Blumer-Lehmann, top right: Tuomas Uusheimo, bottom: designtoproduction.)

FEATURE RECOGNITION

The most common approach to bridging the gap from design to production is to define the final geometry of the parts to be produced in a CAD system and transfer it to the CAM software of choice; an undertaking that can be rather cumbersome by itself, depending on the geometry and the varying import/export capabilities of the software packages involved. The CAM system then uses feature recognition to generate machining data. During this procedure, the software automatically analyses the model and decides which machining operations to apply to the given raw material in order to arrive at the desired final shape. While this has been proven to work for rather simple geometries, like roof trusses, it quickly becomes unfeasible when things get more complex. The geometric information alone becomes insufficient to deduce meaningful results (fig. 3). As a consequence, the features, which were already defined as such in the CAD model, have to be respecified individually in a laborious manual process in the CAM model.

PROJECT-SPECIFIC INTERFACES

Where large quantities of individually shaped non-standard components are required, feature recognition is not reliable and manual job preparation is too laborious. However, when the components are the result of a parametric CAD model, chances are high that they all follow the same geometric rules and require similar sequences of machining operations for their production, even though they all look different. This opens the door to defining and implementing custom CAD-CAM interfaces on a per-project basis.

Possibilities range from simply organising the geometric model in an agreed way in order to streamline the import process up to programming custom post-processors that generate machine code directly from the CAD model. While the former can only reduce effort to a certain extent, as the interface

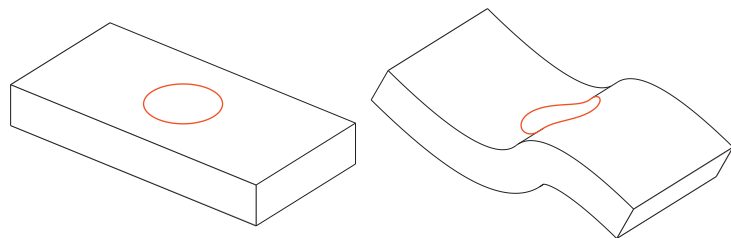

Fig. 3: A hole drilled through a straight beam can be easily recognised from its circular or elliptical edges. On a curved surface, however, the edges are distorted, making automatic recognition of the drilling much harder, not to mention more complex features like five-axis contours or situations with intersecting features. (Drawing by the authors.)

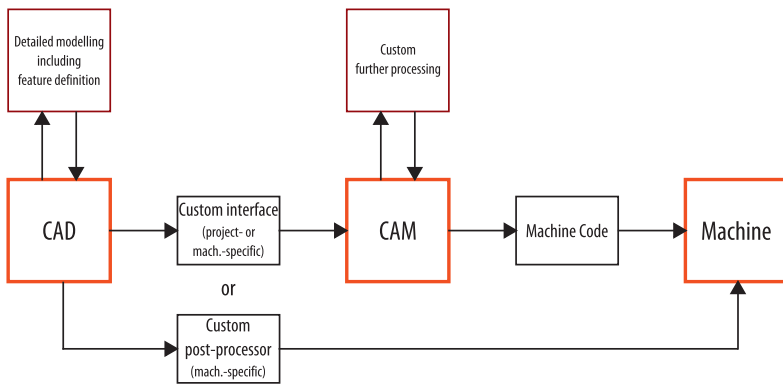

Fig. 4: Digital fabrication workflow using project-specific interfaces or custom post-processors. (Drawing by the authors.)

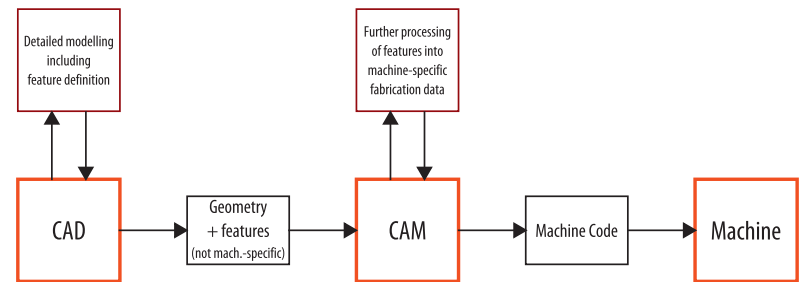

Fig. 6: Digital fabrication workflow using a machine-independent feature description. (Drawing by the authors.)

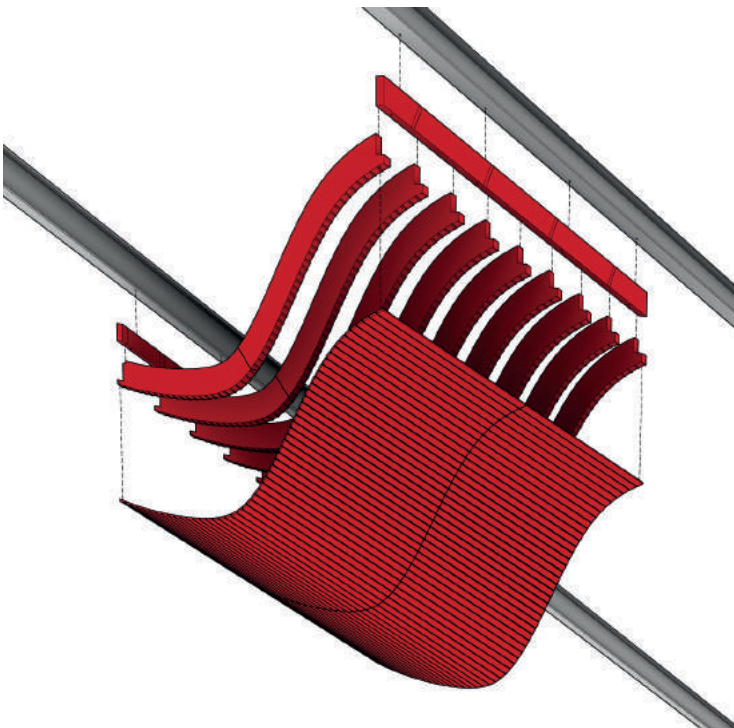

Fig. 5: The timber façade of the Kilden Performing Arts Centre comprises three different kinds of timber components. While feature recognition could be employed for the straight primary beams, the curved and extensively detailed secondary beams were transported as CAD models specifically conditioned for the timber fabricator. For the rather simple, but numerous oak cladding boards, machine code was directly exported from the CAD model, avoiding CAM software altogether.¹ (designtoproduction.)

is still a purely geometric model after all, the latter calls for extensive implementation and testing efforts per project and, most notably, requires that the exact fabrication machinery be known from the very beginning. In any case, this approach requires close collaboration among all the parties involved and only becomes feasible when high numbers of pieces are involved (fig. 5).

MACHINE-INDEPENDENT FEATURE DESCRIPTIONS

Concluding from the approaches presented above, two main requirements for the optimal CAD/CAM interface can be formulated: First, it must be able to transport feature definitions in addition to the geometry, so that no information is lost on the way, in contrast to the feature recognition approach, where the knowledge used to create the feature on the CAD side is only implicitly passed on by the resulting geometry. Second, the definition of those features must be abstracted to a generic level where little to no information about the actual machining parameters is needed on the CAD side and the translation into machine-specific code is completely left to the CAM side, ensuring both flexibility in the process and reusability between projects. In other words, it must be a machine-independent feature description.

When talking about feature or process descriptions in the AEC industry, Industry Foundation Classes (IFCs) spring to mind. They are an established ISO standard and, since the re-

lease of IFC4 in March 2013, are able to deal with NURBS geometry.² However, IFCs are centred on Building Information Modelling (BIM) and thus provide exchange format definitions for construction and facility management, but not for material-specific fabrication of individual parts. While it would probably be possible to build a timber fabrication interface on top of IFC, this effort would lead to severe overhead for software implementations and unnecessarily complex definitions within the files.

A second approach to generic fabrication information is STEP-NC. This extension of the STEP ISO standard was developed in 1999 with the goal of providing generic, machine-independent fabrication information.³ However, its scope still is heavy on the machining side of the process. The tool to use and the corresponding toolpaths have to be defined; 'machine-independent' in this context means that the format defines tool movement instead of machine axis movement.⁴ Furthermore, at least up to now, development has been focused on steel processing.

In order to be efficiently usable for timber fabrication, a data format must contain definitions for timber-specific features such as lap joints and be able to deal with timber-specific material parameters such as the notion of a fibre direction. Additionally, it should be machine-independent in the sense

of 'tool-independent', leaving the actual selection of a specific tool and the generation of appropriate tool paths to the CAM software in order to keep a clear distinction between CAD and CAM. This is all achieved by the Building Transfer Language (BTL) which will be described in more detail in the following section.

BUILDING TRANSFER LANGUAGE (BTL)

The Building Transfer Language (BTL) is a data exchange format specifically developed for timber fabrication. It is being developed and maintained through a consortium formed by timber construction software developers SEMA and cadwork. The format's origin goes back to a master's thesis initiated by SEMA in 1992. As of June 2013, BTL exists in version 10.6, featuring 46 individual machining operations or 'processings' from generic cuts and drillings to highly specific dovetail mortises or block house half-laps.

BTL is deliberately not machine-specific. The processings are defined through their results, not through the actual machining processes (fig. 7). Hence, the precise machining environment need not be known at the time of creation of the BTL file. Accordingly, BTL still needs a CAM processor to render it into machine-specific fabrication information.

It is precisely this position in the digital fabrication process that makes BTL a good match for the building industry, where detail development and CAD modelling are typically executed by a party other than job preparation for actual fabrication.

Though further development of BTL is maintained by the consortium, it is an open standard in terms of open (and free) use and implementation. The complete reference, including the file format description and detailed explanations of all defined processings, can be obtained online.⁵

WOODPECKER — BTL EXPORT FOR GRASSHOPPER

The BTL format has been adopted by numerous timber construction and CAM software packages. However, for the fabrication of geometrically complex structures with parametrically defined parts and details, the problem of how to transfer feature information from the parametric CAD model into the timber-specific digital chain remains.

And this is where Woodpecker comes into play: Woodpecker is a BTL export plug-in for the parametric modelling environment Grasshopper⁶ by McNeel, which itself is an extension of their CAD software Rhinoceros.⁷ It is being developed by the digital fabrication consultancy design2production on behalf of the CAM software developer Lignocam.

4-016-X

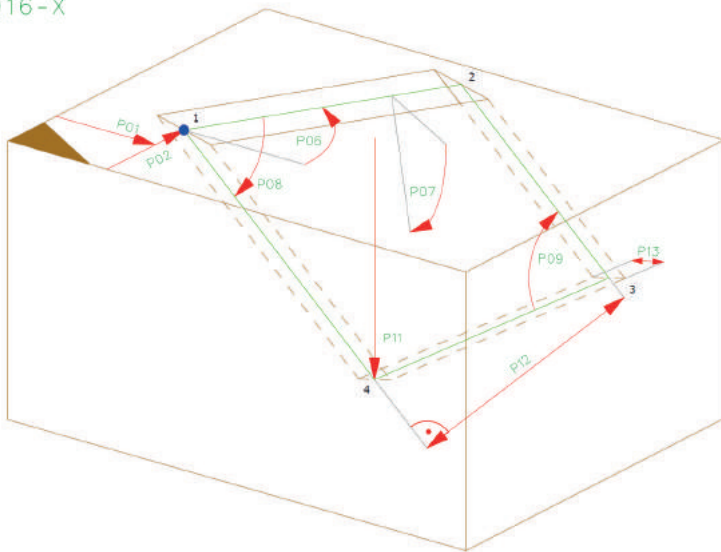

Fig. 7: BTL definition of a slot. While it is complete in terms of geometry, it is not machine-specific and does not contain information about which tool to use. (design2machine.)

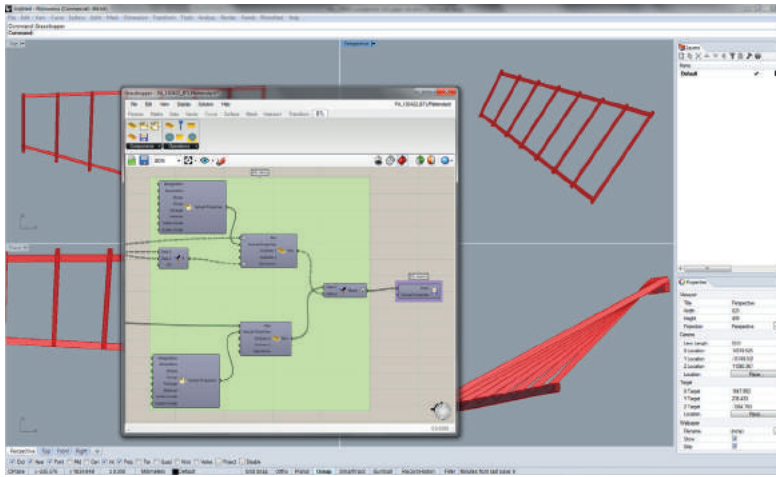

Fig. 8: The CAD application Rhinoceros (outer window) acts as host platform for the parametric modeller Grasshopper (inner window), which in turn is extended by the Woodpecker plug-in (visible as a tab page with tool icons in the upper part of the Grasshopper window). (Screenshot by the authors.)

Through Woodpecker, fabrication features can be defined directly in the CAD model, thereby combining the geometric and parametric capabilities of a powerful modelling environment with the timber-specific functionality usually found only in specialised timber fabrication software.

USE CASES

Two main use cases have been identified:

USE CASE I: EXPORTING AN EXISTING CAD MODEL

The first use case describes a situation where fabrication features are being defined for an existing CAD model of unspecified origin. The model is imported into Rhinoceros, whereupon Woodpecker is used to manually define features based on the geometry. In the end, a BTL file is exported.

This approach is admittedly not so different from the one described under 'Feature Recognition' above, to be more precise, from the case where automatic feature recognition fails and features have to be manually assigned, and indeed Rhinoceros/Woodpecker merely take on the role of timber fabrication software. Therefore, this use case should not be seen as an example of an optimal digital workflow, but as a solution for a situation in which 'dumb' (i.e. purely geometric) models already exist and have to be further processed. However, one major advantage remains: while most timber construction software packages are still not able to work with NURBS geometry, Woodpecker can resort to the geometric capabilities

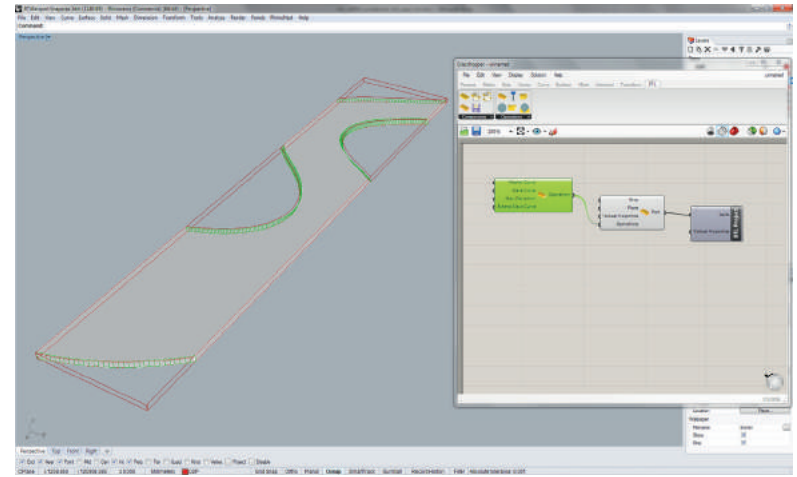

Fig. 9: A volumetric CAD model of a workpiece is being enriched with fabrication information through Woodpecker. (Screenshot by the authors.)

of the NURBS modeller Rhinoceros, making it the superior option when it comes to free-form geometry.

USE CASE II: EXTENDING A PARAMETRIC MODEL INTO FABRICATION

The second use case describes the export of BTL data from a parametric model built with Grasshopper. This is where Woodpecker can really play out its strength. Because all the operations in BTL are defined by reference geometry (e.g. drill axes, cutting planes, etc.) and the same holds true for most parametric models, it typically takes very little effort to extend a model

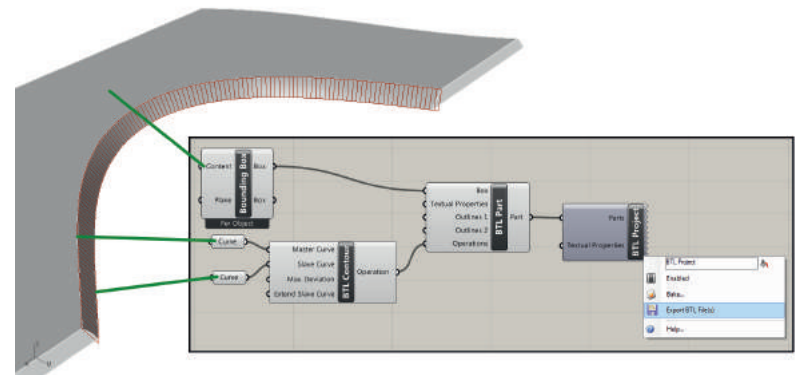

Fig. 10: For the definition of five-axis contours, edges can be taken directly from the final volume. Combined with the raw (bounding box) volume of the piece, a set of information sufficient for digital fabrication is formed. (Screenshot by the authors.)

into fabrication. All the features are basically already defined, only instead of creating volumetric representations and subtracting them from the work piece (as would be done in order to get a volumetric model of the resulting geometry) the reference geometry is fed into Woodpecker components rendering it into BTL data. Depending on data organisation within the Grasshopper model, Woodpecker can export single BTL files or whole folders with reasonably named files.

CURRENT STATUS AND OUTLOOK

In its first version, Woodpecker covers the most important and most generic BTL operations: Drilling, Cut, Slot, Pocket and – most notably – Free Contour (five-axis milling along a ruled surface). With these, almost all cases can already be covered. In future versions, more operations will be added.

As it is brand-new, there are as yet no built examples made with Woodpecker. However, the underlying BTL generation code has proven itself in large-scale timber projects (figs. 11–13).

Woodpecker can be obtained for free from food4rhino.com, the central platform for plug-ins for Rhinoceros and Grasshopper. A similarly free BTL Viewer can be installed in order to inspect generated BTL files with no timber construction or CAM software at hand.

With Woodpecker, designers can already reconcile their parametric models with the requirements of digital fabrication at early stages of the process (see use case II). Timber fabricators also have new ways of processing complex geometries (see use case I), along with the opportunity to become more familiar with the principles of parametric design and detailing. So ultimately, Woodpecker will hopefully aid in further converging the realms of digital design and professional timber fabrication.

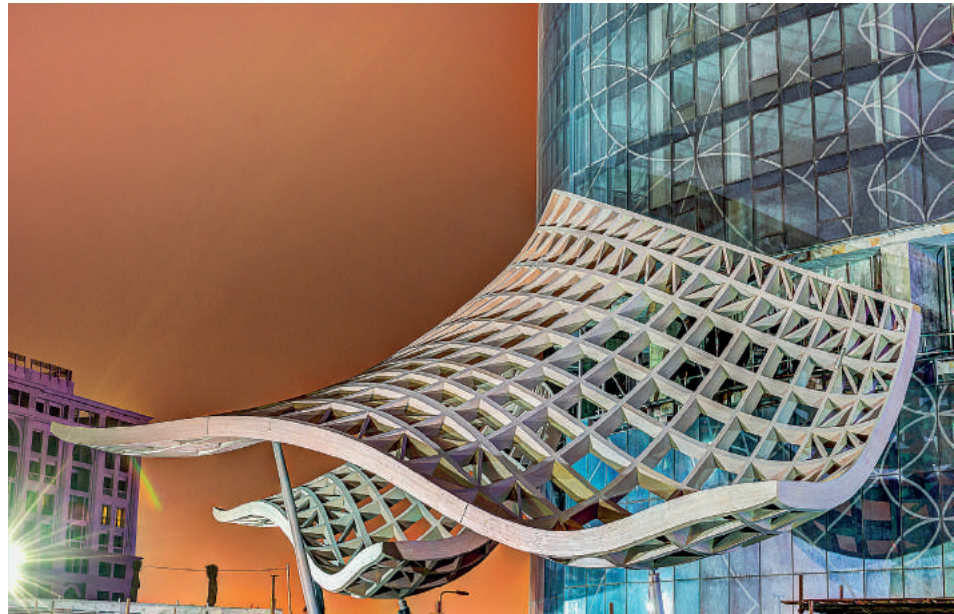

Fig. 11: The four timber canopies surrounding the D1 Tower⁸ were modelled in Rhinoceros and brought into Lignocam for fabrication using a predecessor of Woodpecker. (Hess Timber, Rensteph Thompson.)



Fig. 12: The single-curved beams feature five-axis contours and a wide variety of different drillings, slots and pockets. (Hess Timber.)

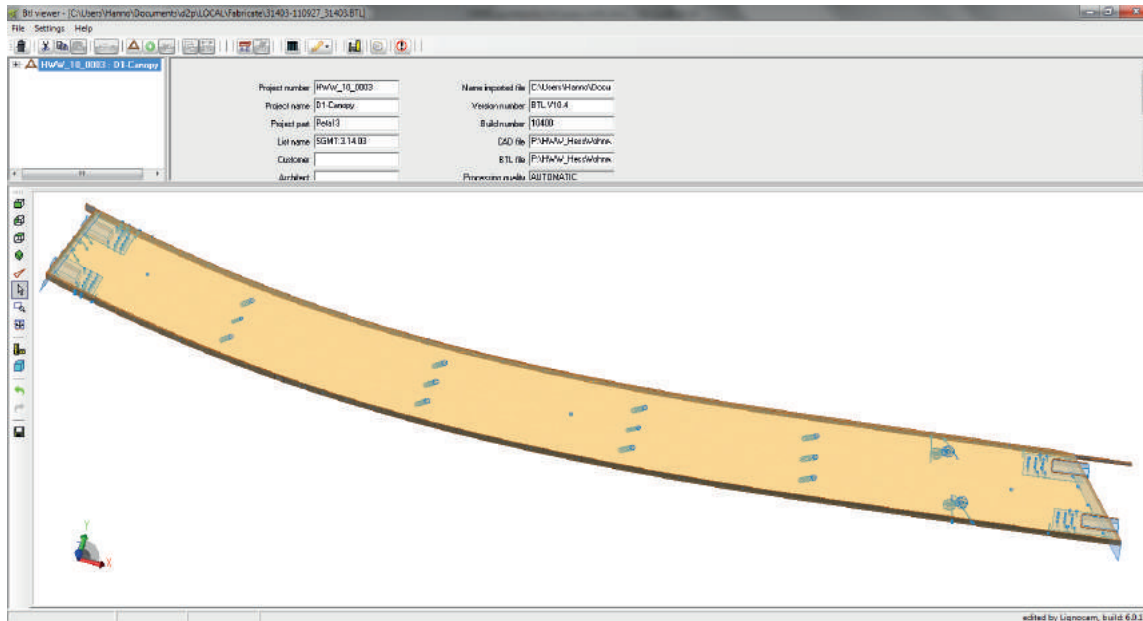

Fig. 13: The same beam in its BTL representation, shown in the BTL viewer. (Screenshot by the authors.)

NOTES

- 1 Hanno Stehling and Fabian Scheurer, 'Waved Wooden Wall', in Ruairi Glynn and Bob Sheil, eds. *Fabricate: Making Digital Architecture* (Cambridge, Ont.: Riverside Architectural Press, 2011), pp. 228–31.
- 2 Accessed 26 September 2013. <http://www.buildingsmart-tech.org/specifications/ifc-releases/ifc4-release>.
- 3 Accessed 26 September 2013. <http://www.step-nc.org>.
- 4 B. Kennedy, 'All Together Now: STEP-NC', *Cutting Tool Engineering* 59, no. 7 (July 2007).
- 5 Accessed 26 September 2013. <http://www.design2machine.com/btl>.
- 6 Accessed 26 September 2013. <http://www.grasshopper3d.com>.
- 7 Accessed 26 September 2013. <http://www.rhino3d.com>.
- 8 D1 Tower, Dubai 2007–2013, architects: Innovarchi; timber fabricator: Hess Timber.

Fig. 1: Entrance by night.
(Photo: Grandy Lui.)



BUILDING SIMPLEXITY: GOLDEN MOON, 2012 MID-AUTUMN FESTIVAL LANTERN WONDERLAND

KRISTOF CROLLA (THE CHINESE UNIVERSITY OF HONG KONG)

Golden Moon by the Laboratory for Explorative Architecture & Design Ltd. (LEAD) was a temporary architectural structure that explored how Hong Kong's unique building traditions can be combined with contemporary design techniques in the creation of a highly expressive and captivating public event space. It was the winning entry for the Lantern Wonderland Design Competition, organised by the Hong Kong Tourism Board for the 2012 Mid-Autumn Festival, and was on display for six days in Victoria Park. Built in eleven days, the project shows how, through a combination of digital design technology and traditional craftsmanship, complex geometry can be built at high speed and low cost with the simplest of means. In addition, it displays how opportunities arise for traditional craftsmanship to adapt productively to current competitive building environments, through the use of computational tools.

INTRODUCTION

Digital design techniques have radically expanded the design solution space available to architects. Not only have computational methods given access to geometries previously considered impractical to develop, control, or communicate, they have opened the door to an unprecedented exploration of architectural form, in addition to liberating virtual environments from trivial restrictions like gravity, material thickness, or fabrication limitations. However, as the architectural profession has been increasingly saturated with digital design proposals, a disjunction has appeared between the proliferation of digital design and fabrication technologies and their concrete application on site. Especially in China, the increasing pressure from limited on-site resources, skills, and time, has created a gap between the realities of the virtual and built environments.

This paper¹ uses the case study of the Golden Moon – 2012 Mid-Autumn Festival Lantern Wonderland in Hong Kong to advocate a grounding of the digital paradigm in the reality of the, in this case, South-East Asian contractor space.

CONTEXT

The Mid-Autumn Festival is one of the most important Chinese festivals for Hong Kong, as it is traditionally a time when families gather under the full moon to celebrate a good harvest. The Hong Kong Tourism Board has been organising a Mid-Autumn Festival for many years to promote this event to overseas visitors. The celebrations include an annual design competition to build a Lantern Wonderland as a highlight for this festival, aiming to showcase the uniqueness of the city as a world-class capital and to encourage local creativity.

The Golden Moon was proposed for the 2012 competition. Its concept revisits the notion of a Chinese lantern and makes a direct link to the legend of Chang'e (嫦娥), the Moon Goddess of Immortality, two elements strongly associated with the Mid-Autumn Festival. According to the very popular romantic story, Chang'e lives on the Moon, away from her husband Houyi (后羿) who lives on Earth. The couple can only meet on the night of the Mid-Autumn Festival when the moon is at its fullest and most beautiful. To symbolise the passionate love burning between the reunited couple that day, a six-storey-high, spherical moon lantern was proposed, clad with abstracted flames in fiery colours and patterns.²

Only three months before the opening date, the Golden Moon was announced as the competition winner. This imposed a nearly impossible schedule to realise the project: Three weeks were available to prepare the legally required, four-week-long public tender process, which led to the appointment of the main contractor five weeks before the festival opening date. Of these five weeks, three were available for prefabrication and only eleven days were allowed for on-site construction.

COMPONENTS

Due to limited time and budget, the construction of the Golden Moon appropriated craftsmanship and construction methodologies readily available within China's Pearl River Delta and Hong Kong. Traditional materials for making lanterns, such as translucent fabric, metal wire and bamboo, were translated to a large scale. A lightweight steel geodesic dome formed the pavilion's primary structure and was the basis for a computer-generated grid wrapped around it. This grid was materialised through a secondary bamboo structure, which was then clad with stretch fabric flames, lit up by animated LED lights.³

STEEL GEODESIC DOME

The primary structure was a steel geodesic dome with bent ribs and a twenty-metre diameter. This freestanding dome gave both form and stability to the installation and was mounted onto a steel base structure. On top of this base structure, a circular concrete slab was placed as ballast since no anchoring in the ground was allowed. This concrete slab forms the basis of the central viewing platform.

Procedural modelling tools were applied for both the calculation and optimisation of the structure, and for the quick and accurate generation of workshop drawings for all steel components. These were manufactured in the back of a shipyard in Guangzhou that usually churns out up to twenty 200-m long container ships per year. By using induction heaters, followed by manually calibrated rolls, over ninety steel pipes with a diameter of 150 mm, and measuring more than six metres in length, were gently bent into shape. Using nothing but cold water, a fan, a blowtorch and, as a template, an improvised support structure that followed some guide curves sketched on the ground, all bending inaccuracies were subsequently manually removed from the curved members.

All steel members and node plates were then labelled according to the computer model. Additionally, the hundreds of connection points between the steel structure and the second-

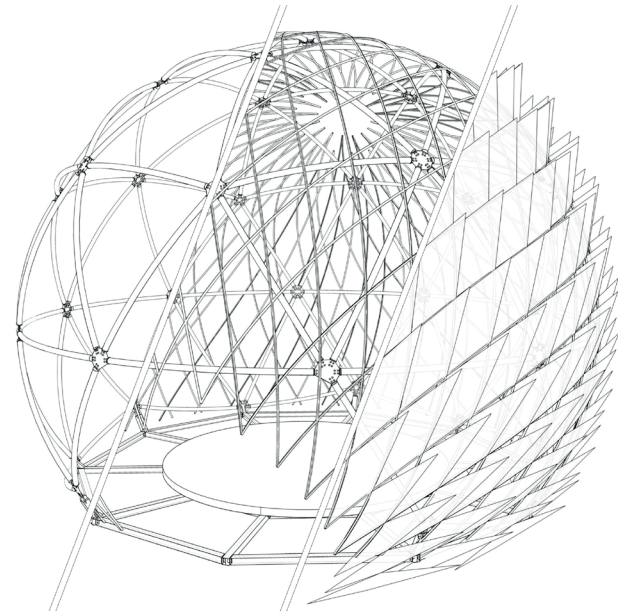

Fig. 2: Main components:
1) Steel geodesic dome,
2) Two kilometres of bent bamboo,
3) 475 stretch fabric flames.



Fig. 3: Installation of geodesic steel dome structure. (Photo: Laboratory for Explorative Architecture & Design Ltd.)

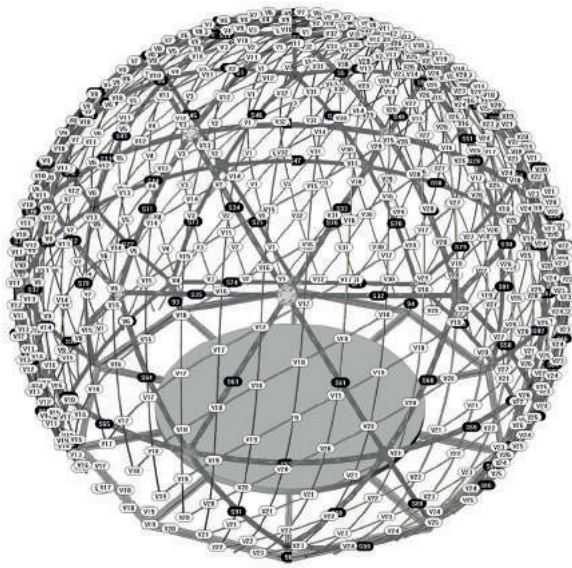

Fig. 4: Intersections between primary and secondary structure.



Fig. 5: Installation of secondary bamboo substructure. (Photo: Laboratory for Explorative Architecture & Design Ltd.)

ary bamboo diagrid were manually marked up and numbered, carefully following a simplified drawing set that was extracted from the digital file.

BAMBOO SUBSTRUCTURE

For the materialisation of the secondary structure, the project merged digital design techniques with a highly intuitive and centuries-old form of Cantonese craftsmanship: the building of bamboo scaffolding.

The bamboo structure follows a swooping diagrid that is based on algorithms that produce purity and repetition around the equator and imperfection and approximation at the poles. This gradual change in geometry creates a very dynamic space that draws spectators' views up towards the oculus of the dome. By putting the axis of this cladding grid at an angle, rather than vertical, the interior space gets an asymmetric directionality. This motion is reinforced by the entrance, which is placed at the bottom of this tilted axis to allow people into the sphere.

Traditionally, Hong Kong's bamboo scaffolding construction is never based on conventional plans or drawings. It is a high-speed, intuitive and imprecise construction method that follows a set of basic principles and rules, allowing the craftsmen to respond to the varying material properties of bamboo and to the differing site conditions. The challenge in this project was to create a flexible set-up that would allow the installation of an exact, abstract, digital design from bent bamboo sticks of varying lengths, thickness and flexibility, with a tolerance of up to ten to fifteen centimetres. This was done by creating a work flow that involved the labelling of interconnected bamboo sticks, which were joined together to create curves of up to forty metres in length. All intersection points with the steel structure and between the two directions of the grid were manually marked on the bamboo, following simplified drawings and data extracted from the computer models. Where possible, stick thicknesses were selected based on bending radii. Traditional scaffolding knots made from black plastic wires were used to tie the grid together and fix it onto the steel base structure.

STRETCH FABRIC FLAMES

For the stretch fabric flames, flexible connection details were designed in collaboration with fabric and bamboo specialists. These details use bamboo sticks as fabric straighteners, and cable binders as connectors, in order to allow a flexible connection to the bamboo diagrid. Combined with the fabric's

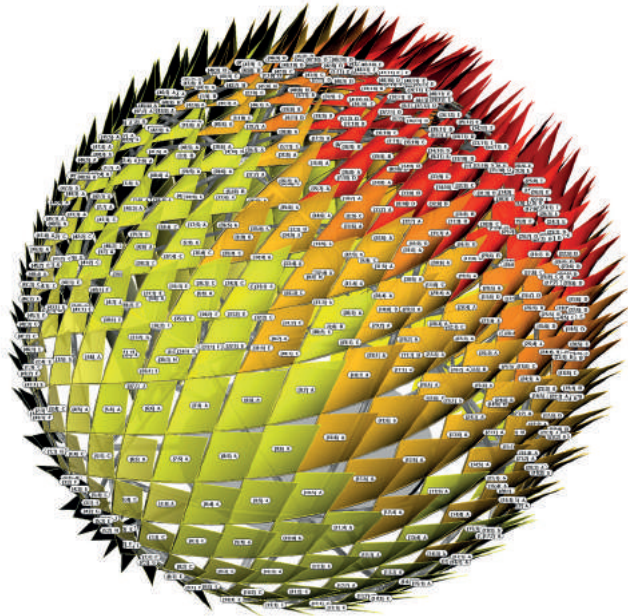

Fig. 6: 475 unique flames.



Fig. 7: Installation of stretch fabric flames.
(Photo: Kevin Ng.)

stretching properties, this method enabled the flames' hyperbolic paraboloidal shapes to absorb the aforementioned geometry deviations of the substructure, which became an on-site installation guide.

In response to this flexible detail, optimisation scripts were developed to reduce the 475 unique flame geometries into just ten different types, an amount deemed feasible for fabrication in the time available. These ten shapes were selected algorithmically to fit the total number of required flame geometries as closely as possible, while remaining within the stretch boundaries of the fabric.

All fabric flames had their tips connected to continuous metal wires that run from the base all the way to the top pole of the dome. With these wires, all the flames can quickly be folded open and tied to the bamboo substructure to reduce wind loads in case of typhoons.

Eight different, highly saturated colours were used for the flames.⁴ The colours ranged gradually from ivory and yellow to intense orange, red and deep Bordeaux. The brightest colours were used at the tilted base, whereas the darkest colours were applied at the top pole, where they, combined with the more scrambled geometry, made the geometric patterns disintegrate into the black night sky. Together with the lighting (see below), the colouration of the pavilion amplified the otherworldly experience of a Lantern Wonderland.

LED LIGHTING

Over 10,000 individually controllable LED lights were installed along the bamboo ribs of the diagrid, turning the lantern into a gigantic spherical screen. This screen played a dazzling light and sound spectacle, composed by a local LED artist. The show consisted of a main, fully pre-choreographed part of three minutes, alternated with a twelve-minute intermezzo. The three-minute part used large-scale patterns, designed specifically to be comprehensive from a distance where the dome can be seen as an isolated object. Inside the dome, these patterns became more abstract and submerged people into an alternative world of sound, light and colour. The twelve-minute intermezzo used non-linear, non-repeating colour patterns derived from virtual 'agents' or 'boids' that generated flocking patterns similar to those found in nature in schools of fish or flocks of birds. This gave the pavilion the impression of being 'alive' and created varied user experiences throughout the evening as the lantern became hyperactive around its peak times, and calmed down towards the end.

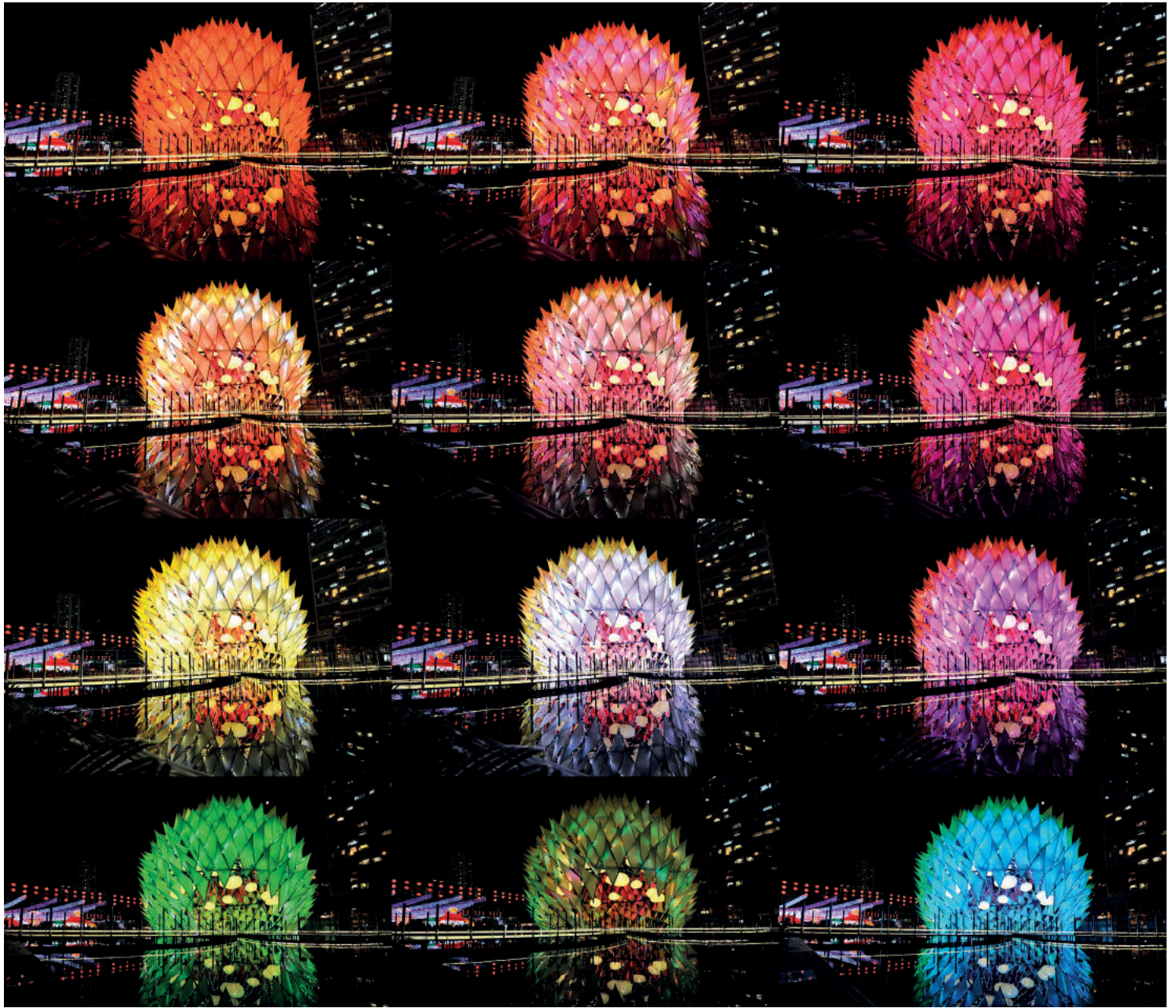

Fig. 8: LED light show. (Photo: Grandy Lui.)

CONCLUSION

In spite of automation and the prolific use of computer controlled fabrication methods and robotics, the act of constructing a building remains a largely human enterprise. This project shows how, through a combination of state-of-the-art digital design technology and traditional hand craftsmanship, complex geometry can be built at high speed and low cost with the simplest of means.

Built in a mere eleven days and on display for only six, the Golden Moon was visited by over 400,000 visitors. By using the hugely popular Mid-Autumn Festival to present an alternative spatial experience to the citizens of Hong Kong, the project introduced people to a culturally and ecologically sustainable architectural design approach that boldly contrasted with the generic concrete jungle of Hong Kong.

Moreover, the project demonstrated how traditional cultures and craftsmanship can adapt and re-invent themselves in order to overcome the pressure from contemporary alternatives – in this case, steel scaffolding. Rather than rendering the skilled building trades obsolete,⁵ computational power, if strategically integrated into the construction process, can be combined with serendipitous occurrences during construction, which can bring an unpredictable, yet unique added value to the final work. By using computational tools to expand the bamboo scaffolding, craftsmanship's role was allowed to evolve from being purely supportive to being integrated into the actual final architectural piece, and in a locally rooted and ecological tradition, possibly safeguarding its sustainable future.

KEY PROJECT DETAILS & CREDITS

DATES: 27 September 2012 to 2 October 2012

LOCATION: Victoria Park, Hong Kong

COMPETITION DESIGN TEAM: Kristof Crolla of LEAD and Adam Fingrut

PROJECT MANAGEMENT TEAM: Kristof Crolla, Sebastien Delagrangue, Dannes Kok, Kenneth Cheung and Yi Sa Chan of the Laboratory for Explorative Architecture & Design Ltd. (LEAD), with Nicholas Benner, Chris Lee (Anthropods Associates Ltd.), Paulina Lau (APT Engineering Consultant Ltd.)

CONSTRUCTION: Free Form Construction Co. Ltd. (main contractor), Fonkwang Development Ltd., and Guangzhou Shipyard Company Ltd. (steel), Wing Yick Scaffolders (bamboo), Wings Design Production Ltd. (fabric), LED Artist (LED)

LIGHT & SOUND DESIGN: LED Artist

PHOTOGRAPHY: Kevin Ng, Grandy Lui and Pano Kalogeropoulos

SPECIAL THANKS TO: Mason Hung, Helen Chiu, Joanne Poon, Rob May, Matthew Melnyk

NOTES

1 The Golden Moon was presented as a project paper at the CAADRIA 2013 conference: Kristof Crolla, 'Golden Moon – Hong Kong 2012 Mid-Autumn Festival Lantern Wonderland', in Rudi Stouffs, Patrick Janssen, Stanislav Roudavski, Bige Tunçer, eds., *Open Systems: Proceedings of the 18th International Conference on Computer-Aided Architectural Design Research in Asia (CAADRIA 2013)*, 2013, The Association for Computer-Aided Architectural Design Research in Asia (CAADRIA), Hong Kong, and Center for Advanced Studies in Architecture (CASA), Department of Architecture-NUS, Singapore, pp. 751–4. A previous version of this paper is included in the proceedings of the DADA2013 International Conference on Digital Architecture, held at Tsinghua University, Beijing, China. Kristof Crolla, 'Building Simplicity – The Expansion of Digital Design into "Contractor Space"', in Weixin Huang, Yanchuan Liu, Yanchuan Xu, eds., *Digital Infiltration & Parametricism: Proceedings of the DADA2013 International Conference on Digital Architecture*, 2013 (Beijing: Tsinghua University Publishing House, 2013), pp. 30–40.

2 The project was originally titled Burning Moon. Unlike in Western cultures, where fire and heat are related to passion and love, Eastern cultures see burning as either destructive or in the context of a religious offering. Therefore, upon the client's request, the name Burning Moon was changed to Golden Moon.

3 All materials were recycled upon demolition.

4 The original design was meant to use only white fabric. This was deemed impossible, as in Chinese cultures white lanterns are only used for funerals.

5 'The demise of the skilled craftsperson is one instance in the ongoing transfer of economic and political power from those who work with their hands to the privileged class of "symbolic analysts" who manipulate information.' Dan Willis and Todd Woodward, 'Diminishing Difficulty: Mass Customization and the Digital Production of Architecture', in Robert Corser, ed., *Fabricating Architecture: Selected Readings in Digital Design and Manufacturing* (New York: Princeton Architectural Press, 2010), p. 195.

Fig. 9: Golden Moon vs. Hong Kong.
(Photo: Kevin Ng.)



Fig. 1: The Leadenhall Building, currently under construction in London, viewed from Leadenhall Street.



THE LEADENHALL BUILDING: DESIGN FOR FABRICATION-DIGITAL WORKFLOW AND DOWNSTREAM FABRICATION SYSTEM

DIRK KROLIKOWSKI (ROGERS STIRK HARBOUR + PARTNERS / UNIVERSITY COLLEGE LONDON),
DAMIAN ELEY (ARUP GROUP LTD)

Through the introduction of advanced digital tools, such as sophisticated information modelling and robotic fabrication methods into the workflow, designers have gained increased control over the final fabrication of components and the interface definition of the assembly. The paper discusses the investigation and findings on the integration of digital tools into the project The Leadenhall Building, a 51-storey office building by Rogers Stirk Harbour + Partners with Krolikow as engineers. In particular, it discusses the implementation of digital tools throughout the advanced design workflow and digital fabrication of the Megaframe: a highly customised main stability system. The paper concludes with observations on downstream aspects, such as the way in which advanced CAD-CAM, including robotic milling, plays a key role in digital design and fabrication.

INTRODUCTION

The Leadenhall Building, designed by architects Rogers Stirk Harbour + Partners (Design Director: Graham Stirk) in cooperation with the engineering services group, Arup, is a 51-storey office building in the centre of the city of London currently under construction. With approximately 85% of the value of the building fabricated off site, it is an exemplary case of prefabrication supported by sophisticated interdisciplinary digital modelling processes. The structure reached full height in June 2013 and the building is due for completion in the summer of 2014. Due to the size of the project team, the number of software tools employed was vast and eclectic. The challenge was how to develop a digital workflow that would integrate a scattered software ecology in a multi-model environment. A major subject of practice-led research and innovation throughout the process was the exposed structural stability system: the Megaframe, a highly architectural and customised external main stability system, unprecedented at this scale for an occupied building. The desired level of interdisciplinary integration made it necessary to develop a digital prototype, capturing design team knowledge and serving as a means to test and develop the system to the highest comprehensive level achievable, thus facilitating the successful

integration of architecture and engineering throughout the advanced design workflow and the digital fabrication of the structure (figs. 1, 2).

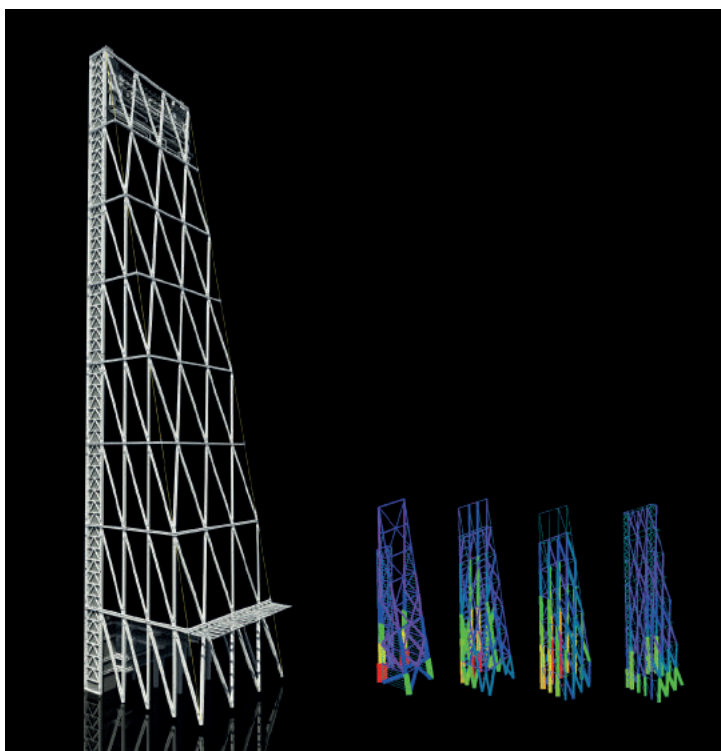

Fig. 2: Lifting operations take place 24/7. Most large elements are assembled during the night shift, as day traffic does not allow delivery of the 27 m long columns. Due to the high degree of prefabrication, the superstructure was erected in 16 months. The first superstructure elements arrived on site in January 2012.

THE DEVELOPMENT OF THE EXTERNAL STRUCTURAL STEELWORK SYSTEM (MEGAFRAME)

The main structural stability system of the Leadenhall Building is a tapered braced tube, referred to as the Megaframe. The external system is subdivided into eight 28 m high 'mega-levels', each consisting of seven storeys of office space, accumulating to an overall height of 224 m. The overall steel tonnage of the building is 18,000 metric tons, including substructure and temporary works. The design research was driven by the aim to integrate structural and architectural performance to the highest possible degree, something unprecedented at this scale. The fact that the structural system is not clad but external, forming an important part of the architecture, led to the attitude that 'architectural steelwork is structural steelwork and vice versa'. The resulting requirements not only triggered a high degree of research and pioneering for the development of the final geometry and its components, it was also dependent on the development of particularly integrated design team workflow methods.

Fig. 3: The base geometry of the Megaframe with analysis diagrams by Arup describing the development of the geometric layout; they illustrate that an introduction of columns to the flank and north elevations of the building reduced the eccentricity effects of the asymmetric geometry significantly, spreading the loads more equally.



BASE GEOMETRY

The Megaframe base geometry has undergone an extensive variant study. Architecturally, the geometry is driven by floor heights, footprint, cladding grid and planning requirements. The distinctive taper of the frame geometry derives from a view corridor restriction towards St. Paul's Cathedral, which was designed by Sir Christopher Wren. Tapering the building assures compliance with view corridor requirements, while allowing sufficient floor space at upper levels with higher lease returns. During an analysis of alternative geometry configurations, it became clear that the presence of vertical columns within the flank and north elevations of the building improved the overall efficiency of the structure, spreading the loads more equally. However, the south elevation, carrying much less load, remained without vertical columns, requiring the diagonals to act as vertical load-bearing elements and diagonal bracing members at the same time. As a strategy for the structural response to vertical load accumulation, structural member envelope sizes remain constant throughout the height of the building, but vary greatly in individual plate thicknesses of the individual subassemblies. This led to a highly differentiated and customised system (fig. 3).

DEVELOPMENT OF THE MEGA-NODES

A key driver for the component design of the Megaframe was the 'kit-of-parts' approach, whereby every element shares a developed overarching tectonic logic, which is brought about through an intensive dialogue amongst all participants, but mainly architect, engineer and fabricator. In order to help the architect and engineer understand downstream parameters such as fabrication limitations and constraints governed by actual assembly, fabricators were engaged through pre-construction service agreements (PCSA) from early scheme stage, which proved to be key to the development of the design. Overall, the perimeter Megaframe consists of approx. 575 individual parts encompassing varying plate thicknesses, incoming member angles, connection and façade interface requirements (figs. 4–7).

These elements vary in weight from 12 to 60 tons and incorporate plates with thicknesses from 25 mm to 180 mm. In particular, the 'mega node' connections have been the subject of many years of intensive research and development. There is no precedent known to the authors for this kind of external structural detailing system. In order to achieve a consistent, systemised approach to the highly differentiated and customised external frame, typological node connections have

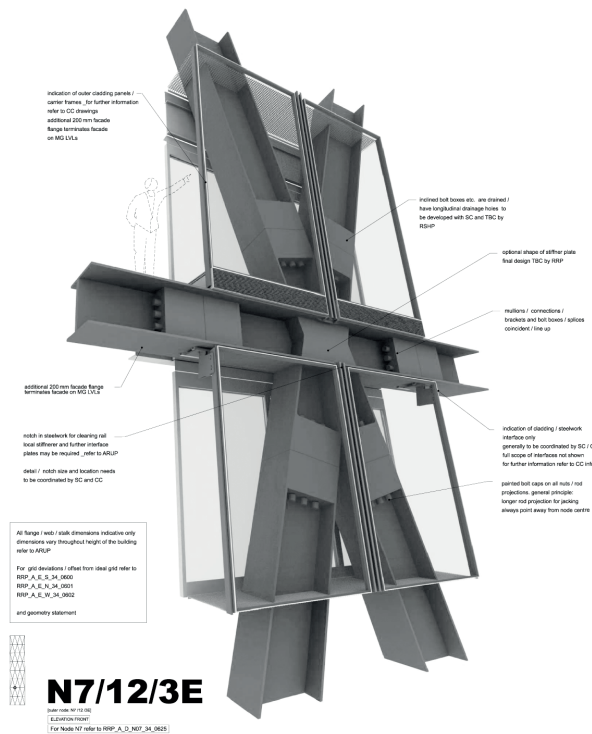

Fig. 4: Node type 7, which occurs on the inclined south façade; the complex façade interface had to be considered part of the architectural requirements.

Fig. 6: Node type 7 in fabrication. Node 7 incorporates the thickest plate sizes of the entire Megaframe (180 mm).

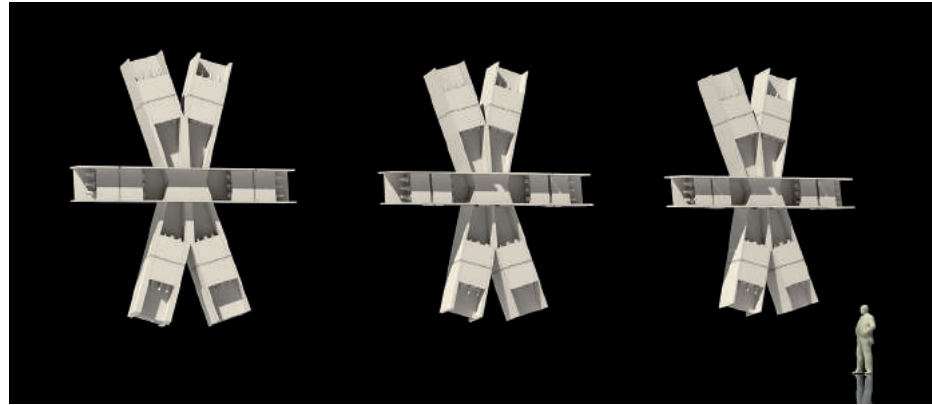
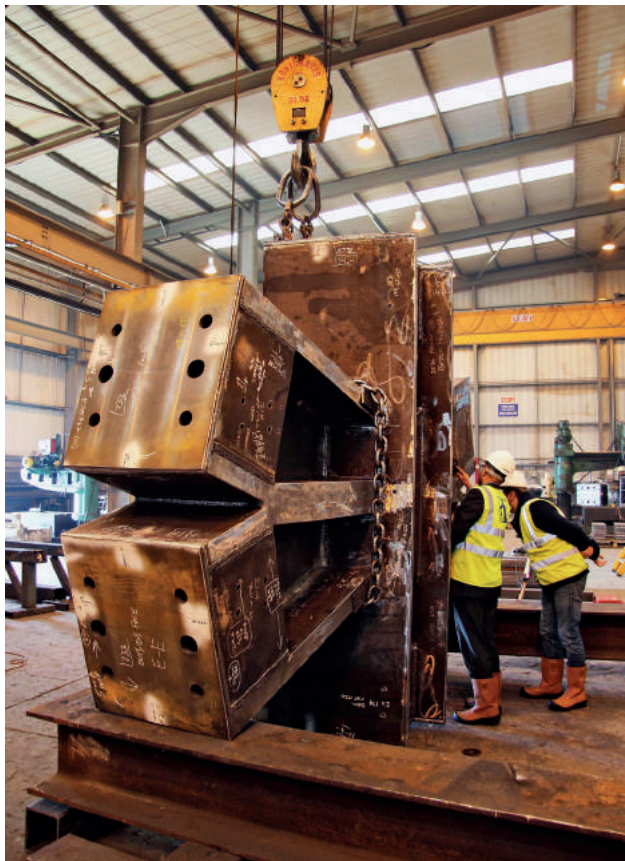

Fig. 5: All node types have sub-variants. The illustration shows the final fabrication models of node 7 types, which all incorporate varying plate thicknesses and bolt layout. Plate thicknesses typically decrease over the height of the building. This approach led to a large number of individually tailored components. The final model was used to automatically generate over 8000 drawings required for fabrication and assembly.



Fig. 7: Node type 7 assembled and forming part of the inclined south face.

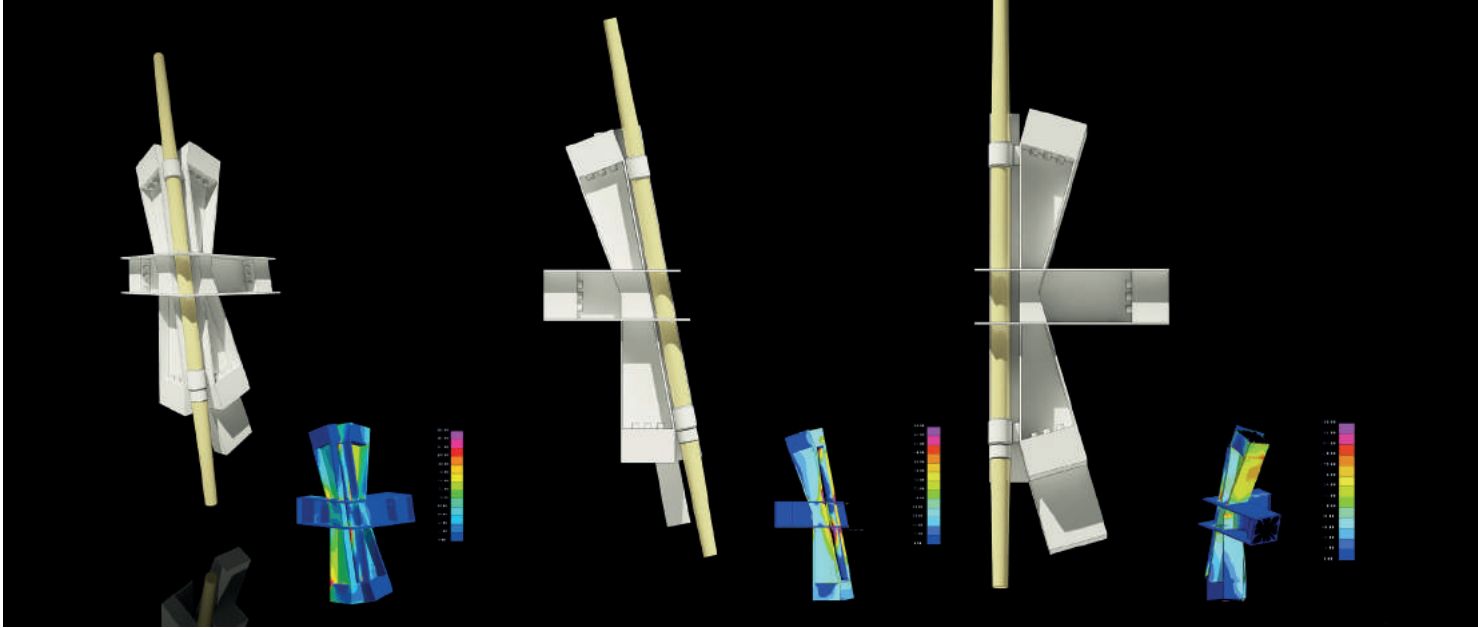

Fig. 8: Architectural model of node 6. The geometry is driven by concurrent analysis. GC was used to capture geometric logic and update the model with plate thicknesses that changed throughout the design process. The analysis, with gradually increasing levels of sophistication, defined the geometry in keeping with an emerged tectonic language.

been driving and informing the individual instances of a node. These node connections have been geometrically defined by rules that establish them as a family of components, sharing the same emerged tectonic language and logic. The component family has 11 node types with individual subtypes. These types do not vary in terms of member envelope sizes, but respond to varying structural requirements, due to vertical load accumulation, by varying the individual flange and web dimensions as well as the grade of steel. This strategy results in a large number of individually tailored components.

Innovative design team strategies, e.g. workflow, review procedures, have been key to facilitating the refinement and verification of design data. The achieved result, with a view to accuracy (elimination of error) and extremely short throughput time, highlights the importance of a digital prototype for robotic fabrication and assembly.

DIGITAL PROTOTYPING

Digital tools and the actual implementation thereof have been a key aspect and an area of investigation throughout the entire design process and fabrication. Early system design was carried out through the evaluation of prototype variants of the Megaframe system, which were tested globally with engineering analysis tools in an automated optimisation process. Different global arrangements were tested at first, and then various options for section shape within the preferred geometry.



Fig. 9: Node 6 after the application of finishes, ready for component sign-off.

A parametric approach was taken, in which different variables, such as overall column width, could be tested for relative structural efficiency. Each option was optimised through an iterative process in which the results of the structural analysis were processed through bespoke design routines in order to identify the minimum plate thickness requirements for every section. These were then fed back into the analysis model to generate a new set of design actions, and the process repeated

until convergence was reached. The output in turn was architecturally verified with an early-stage information model that finally, over many model generations, became a comprehensive digital prototype, which was required in order to develop the complex system (figs. 8, 9).

BEST OF BREED

Component design required a more refined, pioneering approach for model verification. Sophisticated system analysis suggested a 'Best of Breed' approach to the modelling tools employed in order to address the various data analysis needs of design team members. The 'Best of Breed' approach to digital tool choice has so far succeeded over integrated systems as individual systems offer broader functionality. To be able to use this approach, it has been observed that it is key to understanding the individual digital tools involved. As a consequence, large project teams generated an 'ecology' of software tools, each with individual outputs. To establish a consistent digital workflow, a comprehensive strategy must be developed to enable system verification to be undertaken in the multi-model environment generated by the aforementioned ecology of software tools. Therefore, the tools involved have been analysed and mapped in order to understand their compatibility and foresee potential workflow issues (fig. 10).

DIGITAL WORKFLOW

A comprehensive digital tool ecology requires a distilled and refined digital workflow amongst design team members to achieve a format-independent approach. Figure 11 captures a conceptual example of the design and digital workflow that has been developed that allows the re-evaluation and calibration of design team data in a multi-model environment. Basic parameters are a shared model space and data structures are conventions. Throughout the model's evolution, downstream aspects of fabrication and assembly could be considered during concurrent design activities. These aspects included design space considerations such as available robotic milling equipment, availability of thick plate material and weldability of overall node assemblies. This downstream knowledge was harvested and introduced into the workflow via the PCSA, which was in place to facilitate the designers' understanding of production system performance and the technologies involved.

Due to the nature of the Megaframe, it was clear that allowing interdisciplinary non-linear design exploration throughout the process was paramount. Parametric modelling of geo-

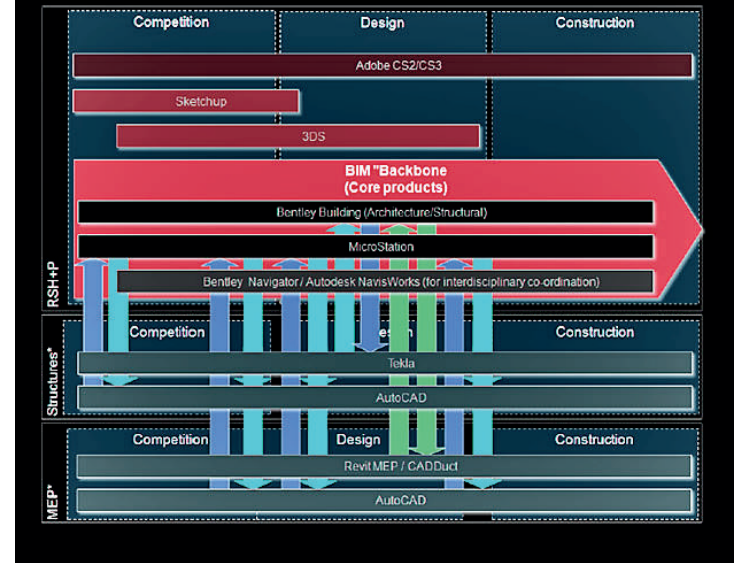

Fig. 10: An accurate map of the software technologies involved and their compatibility helps forecast workflow issues; this map is dynamic and changes throughout the design process.

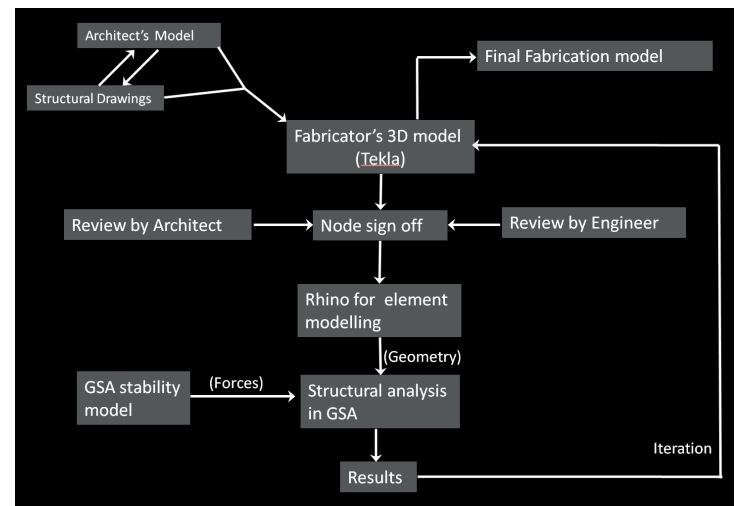

Fig. 11: Diagram of workflow for model sign-off.

metric as well as non-geometric data models allowed feedback loops. Furthermore, it increased flexibility in testing, prototyping and evaluating variants while capturing developed design logic. Several model generations enabled a refinement of data and analysis methods, which was key to accomplishing the best results (fig. 11).

FINAL FABRICATION-MODEL GENERATION AND FABRICATION

The final generation of information models was fabricator-led and underwent a two-stage sign-off procedure. The first stage entailed material take-off models with a defined geometry, while the second stage required a phased final fabrication model, including all secondary design connections. During approval, continuous geometry and interface checks were carried out. For sign-off, specialised finite element (FE) analysis software (Nastran) was employed, which linked to the Tekla fabrication model. Rhino and ANSYS facilitated the meshing process required for FE analysis.

At this stage, these tools were used, for example, to refine the weld design and evaluate decisions taken for the secondary connection design and their potential impact on the flow of forces through the Megaframe components. Exact assumptions of fabrication system performance in upstream design processes resulted in a minimal degree of model re-calibration. The information handling methods developed by the design team enabled a holistically informed, interdisciplinary design process leading to a comprehensive virtual prototype. The importance of upstream design activities, taking fabrication parameters into account, significantly reduced throughput time, realising value through minimising or even eliminating error. Amongst others, these parameters were the weldability of plate assemblies, availability of plate thicknesses, robotic milling design space and

crane capacities for assembly. The integration of robotic milling into the fabrication process decreased system complexity significantly by reducing fabrication tolerances (figs. 12–14).

‘ACTIVE ALIGNMENT’: AN OBSERVATIONAL FEEDBACK MECHANISM

The erection of the Megaframe had to take the movements of the structure under gravity into account, which included lateral sway. These movements were too large to be allowed to accumulate and suggested that some form of presetting was required. An innovative tracking method using digital laser plumbing methods was developed that allowed adjustments to the entire geometry to be made in direct response to the actual movements after the structure had been erected. Known as ‘active alignment’, this process involved the temporary fitting of hydraulic jacks to diagonal members of the east and west faces to open the connections and make adjustments that pulled the building to the south. This observational approach was facilitated by computational analysis tools predicting movement behaviour and achieved much greater precision in the presetting of the structure than would have been possible using a traditional presetting approach. The computational movement analysis data was regularly combined with actual movements observed on site in order to predict the final geometry of the yet unbuilt structure.

Fig. 12: Subassembly in finishing pass with robotic milled endplates. After the welding process, the complete node is offered up to a multi-axis milling robot and endplates are machined to exactly match the fabrication model. This eliminates the tolerances introduced by geometric distortions caused by induced heat.

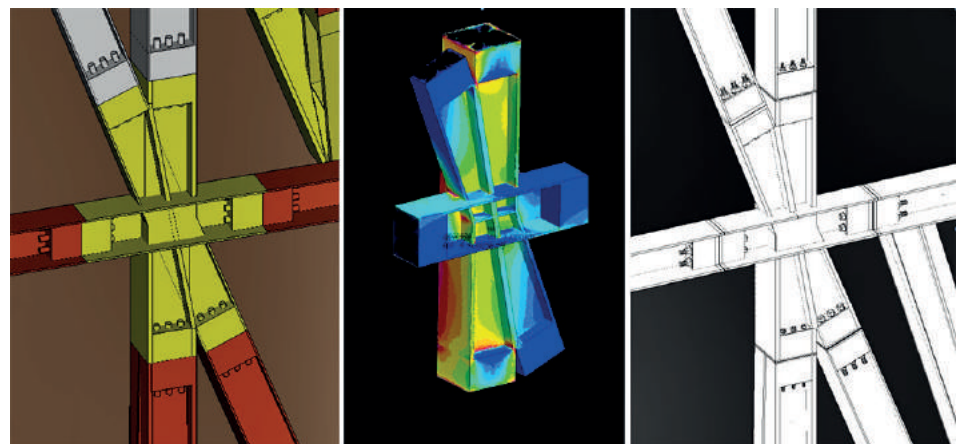

Fig. 13: Early architectural model, FE analysis model and final fabrication model of a flank node 5.



Fig. 14: Node 5 assembled on site.

PROJECT DETAILS AND CREDITS

BUILDING: The Leadenhall Building

FUNCTION: Office development

ARCHITECT: Rogers Stirk Harbour + Partners,

Design Director: Graham Stirk

STRUCTURAL ENGINEERS: Arup

CONTRACTOR: Watson Steel Structures (steelwork fabricator),

Laing O'Rourke (main contractor)

LOCATION: 122 Leadenhall Street, London, United Kingdom

CLIENT: British Land

PRACTICAL COMPLETION: June 2013: topping-out, mid-2014: practical completion

TONNAGE STEELWORK: overall ca. 18,000 metric tons (including substructure)

AREA: 55,740 m²

Fig. 1: RDM vault.



FABRICATING ARCHITECTURAL VOLUME: STEREOTOMIC INVESTIGATIONS IN ROBOTIC CRAFT

JELLE FERINGA, ASBJØRN SØNDERGAARD

The 2011 Fabricate conference inspired a number of collaborations; this article seeks to highlight three of these. There is a common thread amongst the projects presented: sharing the ambition to close the rift between design and fabrication while incorporating structural design aspects early on. The development of fabrication techniques in the work presented is considered an inherent part of architectural design and shares the aspiration of developing approaches to manufacturing architecture that are scalable to architectural proportions¹ and of practical relevance.

RDM VAULT

The RDM vault presents a collaboration between Matthias Rippmann² and Silvan Oesterle,³ initiated by Jelle Feringa.⁴ Earlier work⁵ suggested the necessity of dealing with structural design aspects early on in the design phase. An important constraint to building with expanded polystyrene (EPS) elements is their limited capacity to deal with tensile forces, while the material can cope with considerable compression forces. The project therefore sought to deal with both structural and fabrication constraints as the driving parameters of the design phase. RhinoVault, developed by the Block Research Group, provides powerful and intuitive design tools for the design of compression-only structures. Earlier work was built with a custom-built and fairly improvised machine specifically for hot-wire cutting. While that resulted in precise elements, both the software and design of the machine had a restrictive platform. Robotic hot-wire cutting⁶ (RHWC), coupled with the development of the PyRAPID CAM software dedicated to RHWC, allows the application of a truly voluminous approach to the production of the trait⁷ the RDM vault is comprised of (fig. 1). At the time of construction, deploying RHWC for the first time at Hyperbody's Robotics Lab for the production of very large and geometrically challenging elements, the tolerance of the

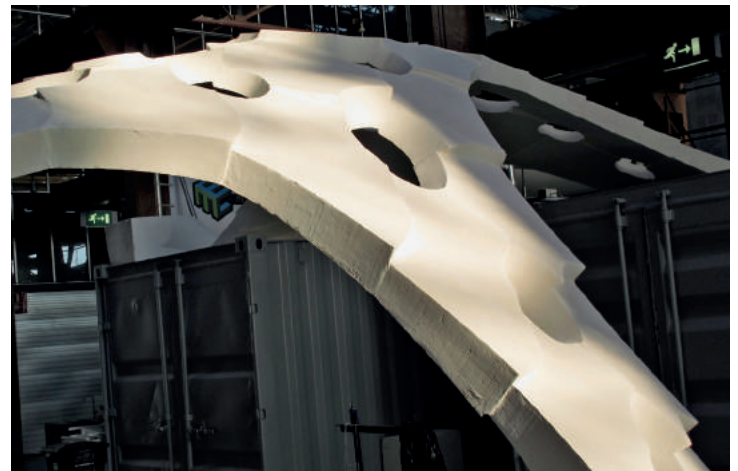

Fig. 2: Discrete components merge into a continuous shell, lacking tectonics.

cut elements was unknown and therefore the design's shingles were accommodated for the eventual tolerances. As such, fabrication constraints become design drivers. In hindsight, margins for assembly were greater than the cutting tolerances (ranging from 1–2 mm). The project was designed and ex-

ecuted in the course of a month, emphasising the importance of experts having the opportunity to collaborate. The EPS elements were rendered with Acrylic One, a gypsum/acrylic composite material, and glass fibre. Resulting in a structural shell, a rendered finish and a fireproofing layer were applied to the EPS structure, increasing the longevity of the fragile foam components. Though the approach has many practical merits, in the end, the project suffered from an architectural ambivalence that could be traced back to its materialisation. There is a precarious unease present whether one observes a 1:1 mock-up of an architectural intent (a representation) or the artefact as conceived. That apprehension extends to the inconclusiveness of whether the vault is an assembly of individual traits, or a monocoque glass fibre reinforced shell (fig. 2). While efficient, practical and economical, the materialisation of the RDM Vault lacked a tactile and tectonic quality.

STONECUTTING

The concern of tectonics pushed the volumetric approach to fabrication further towards stereotomic tradition and towards a more permanent materialisation, fuelled by the development of a diamond wire saw. The powerful abrasive wire saw is powered by a 40 KW hydromotor and allows the processing of stone at a very high speed. While stonecutting is a mechanical and time-intensive process, the effectiveness of abrasive diamond wire cutting, traditionally a demolition method, is easily proportionate to the speed-up (an order of two) achieved by RHWC.

This research has precedents in the work of Shutao Li, et al.,⁸ machining AAC slabs from BIM data and Mankouche et al.,⁹ where a spiral cutting wire was applied to process cured plaster, while the work presented here is focused on the lost art of stereotomy and processing hard mineral materials.

Test elements (fig. 3) were fabricated in 20 minutes per piece. These initial experiments were conducted with an inexpensive material, engineered limestone. This experiment was conducted at Hyperbody's workshop for the first edition of the Robots-in-Architecture conference, taught by Wes McGee, Jelle Feringa and Lauren Vasey. The diamond wire saw was engineered and built by Jelle Feringa and Frank van Brunschot with the support of the industry partner Husqvarna. Further research took place in the summer of 2013 at the marble quarry of Carrara, in cooperation with industry partner Marmi e Graniti d'Italia, one of Italy's largest quarries (figs. 4–6).

The work on robotic diamond wire sawing (RDWS) research is taking place right at the intersection between revis-

Fig. 3: Initial test cuts in engineered limestone.



Fig. 4: Experimental diamond wire saw set-up.

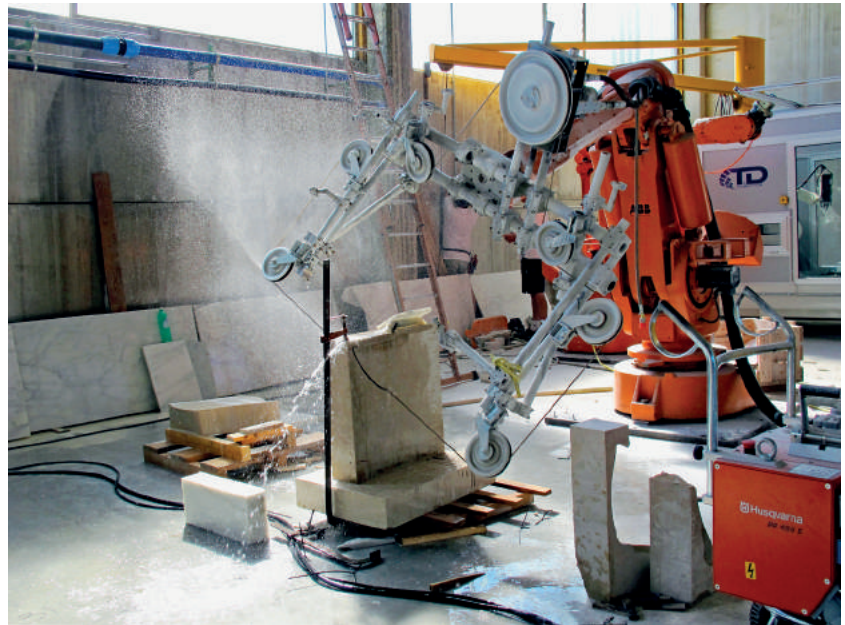

iting a long-lost ancient craft while employing state-of-the-art industry tools and bespoke software development. As such, the work is pleasantly equivocal; rooted in many centuries of a progressive architectural tradition while empowered by recent advances in industry and custom CAD software.

Stereotomy is resurfacing as a contemporary technique since Robin Evans's formative book *Projective Cast: Architecture and its Three Geometries*¹⁰ appeared in the early 1990s along with Bernard Cache's seminal work and writings in the late nineties.¹¹ Many recent projects, such as the MLK Jr. Park Stone Vault¹² in Austin, Texas, by the Block Research Group, Brandon Clifford's recent publication, *Volume – Bringing Surface into Question*, and Matterdesign's *Voûte de LeFevre*, as well as Giuseppe Fallacara's many publications and projects, emphasise the relevance of the line of inquiry.

Fig. 5: Application of abrasive wire swing at the quarries in Carrara, Italy.



Fig. 6: Experiments in Botticino marble. No further processing of the surface is required.



OPTICUT

During the Fabricate 2011 conference, the authors of this paper presented projects that dealt with topology optimisation (TO) and hot-wire cutting. It was instantly clear that while topology optimisation motivated the need for sophisticated formwork, hot-wire cutting could provide these in architectural proportions, at a modest cost, and, as such, offer substantial complementary advantages. With forces joined, the Opticut project set out to explore the architectural and performative potential for large-scale realisation of optimised spatial structures through the use of RHWC and casting concrete. A research partnership between Aarhus School of Architecture, TU Delft's Hyperbody's Robotics Lab, Odico Formwork Robotics and Hi-Con was mobilised.

Recent developments in topology optimisation of concrete structures has shown significant potential for form-finding and design of material-efficient structures, in which up to 70% of material consumption may be reduced in comparison to massive equivalents, while respecting normative performance requirements.¹³ This material economy is achieved

through the development of advanced structural morphologies, which minimise the required material volume to achieve structural performance through the densification of material in the trajectories of minimal deformation energy while maximising structural stiffness. As a consequence, new architectural shapes emerge, rendering the trajectories of structural force visible.

Topology optimisation induces a significant moment of morphological unpredictability, as topologies emerge freely within an unconstrained solution space.

The architectural specificity of these circumstances was initially investigated in the Unikabeton project, resulting in the realisation of a $12 \times 6 \times 3.3$ m concrete structure using robotic CNC milling of EPS moulds. The project produced two conclusions:

- Topology optimisation's resulting structures, though structurally feasible, overstrain challenges in in-situ casting and formwork production.
- CNC milling of EPS formwork is prohibitively time-consuming and therefore costly to scale up to architectural proportions.

Fig. 7: Post-rationalised prototype design.

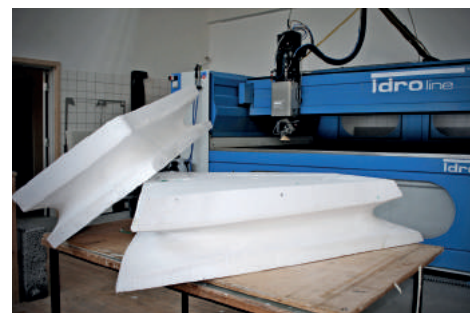
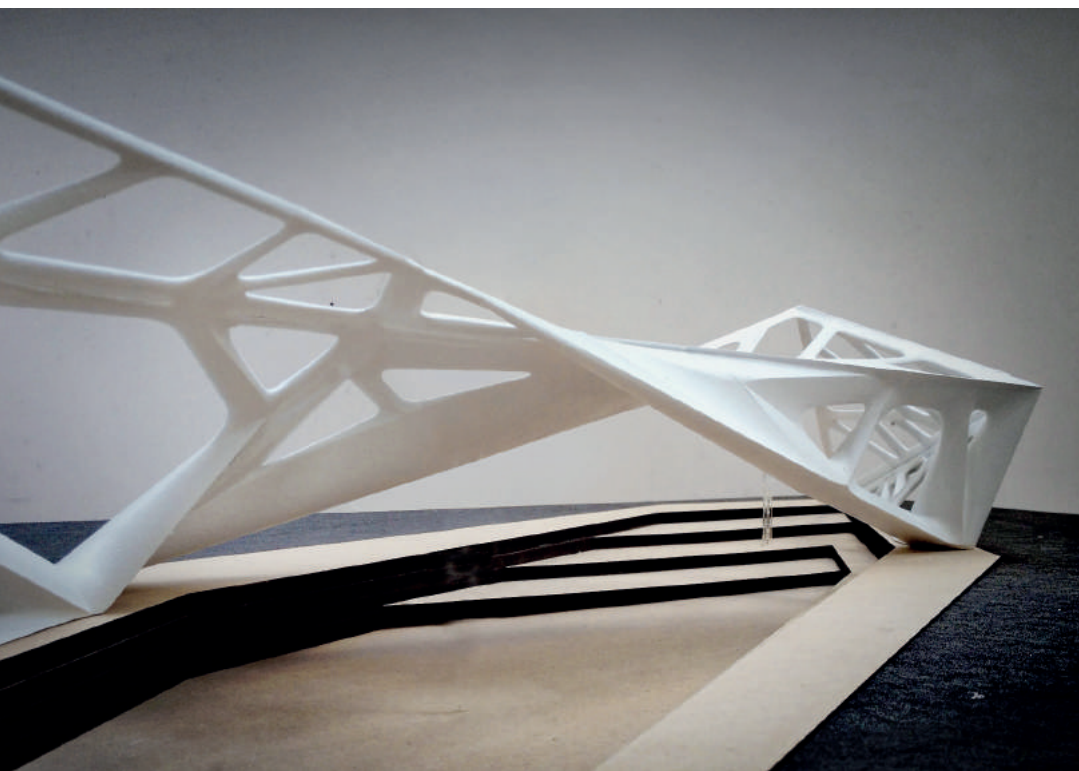

Fig. 8: Opticut sample moulds.



Fig. 9: Y-joint sample cast constructed from three intersecting hyperbolic paraboloidal surfaces and six single-ruled extrusions.

Concluding that a coupled design/fabrication process is key to achieving the merits and potential material savings offered by TO, Opticut initiated a dual investigation program to explore the capacity for economically efficient production of advanced formwork for topology-optimised spatial concrete structures using robotic hot-wire cutting (RHWC) of EPS formwork. The first part of the project investigated the geometrical post-rationalisation of the mesh resulting from the topology optimisation process, by composing single- and double-ruled surfaces. In the second part, the necessary production procedures and software were developed. Currently, the construction of an over 20 m full-scale prototype structure on the coast at Aarhus is continuing and is scheduled for completion in February 2014.

The design was formulated as a TO problem subject to wind and dead loads. Anticipating later post-rationalisation by ruled surfaces, the envelope was constructed from ruled-surface geometries, merging three typologies: the corner, the wall and the canopy.

Early experimentation found that translations using compositions of simple hyperbolic paraboloids from circular or ellipsoid starting geometries proved to be inadequate for approximating the TO's resulting mesh. Consequently, a procedure to create n-sided, irregular, hyperbolic paraboloids from non-parallel, double-ruled construction planes was devised. This approach allows for a parametric interpretation of the perforated topology while achieving surface curvature continuity (Fig. 7).

The prototype was designed for subdivision into six primary elements ranging from $10 \times 3.5 \times 1.7$ m to $7 \times 2.5 \times 0.3$ m. Casting the elements is achieved by using EPS plugs inserted in conventional in-situ shuttering systems, able to resist casting pressures on vibration tables commonly used in the prefabrication industry (figs. 8–11).

The formwork is produced at Odico's production facility, utilising the world's largest robotic hot-wire cutting machine, an ABB IRB-6400R industrial robot mounted on a 24-meter long linear axis (fig. 12). While milling and hot-wire cutting cannot be directly compared, since cutting is geometrically a more restricted method, i.e. bound to ruled surfaces, architecturally it's arguably more liberating. To provide a perspective on how production capacity roughly compares, the cutting process presents a speed-up factor of 25 compared to milling. Given the intricate geometry, some of the efficiency of the process is lost, where in practice two orders of magnitude in speed-up are observed.



Fig. 10: Opticut 1:1 sample cast, testing the casting quality of two adjacent, doubly ruled cells.



Fig. 11: 1:1 EPS positive of prototype segment.

ODICO

The commercialisation of RHC technologies was fuelled by the measured increase in production speed in comparison to existing procedures. While most architectural productions can feasibly be described by ruled-surface geometries, the tendering with partners NedCam and Dura-Vermeer for the production of formwork for a bridge spanning over 300 m (designed by Zwarts en Jansma) indicated a need for equivalent efficiency in doubly curved production. Following a grant received from the Danish National Advanced Technology Foundation, Odico now heads the 3-year research project, Bladerunner, which seeks to develop an economically efficient production of freeform doubly curved geometry through the development of robotic flexible-blade cutting with heated blades, in collaboration with the Development Department of 3XN Architects, GXN, the Technical University of Denmark and a number of building industry partners.

Although only founded in April 2012, production by means of RHC is now in full swing at Odico. The company is providing services for companies such as Siemens Windpower and Spaencom.¹⁴

PYRAPID

The projects described in this article fuelled the development of custom software, dedicated to RHC and RDWS, PyRAPID. PyRAPID is built on top of PythonOCC, with the open-source OpenCasCade CAD kernel as its main dependency (figs. 13, 14). The application automatically clusters the faces so that they can be cut in a single sweeping motion, and generates a tool-path optimised for extending the reachability of the end-effector and computes the inverse kinematics from that pose. As the tool orientation has two degrees of freedom (sliding and rotating) over the axis of the wire, the key is to leverage this freedom, as it allows for considerable optimisation of the reach of the robot.

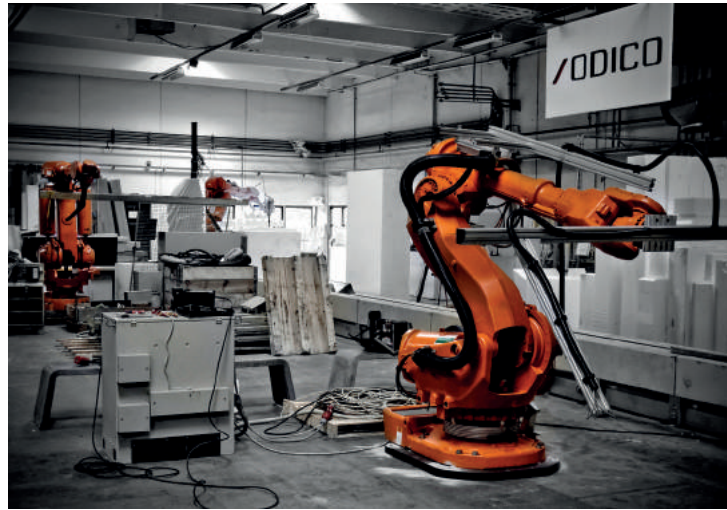

Fig. 12: Robotic workshop at Odico.

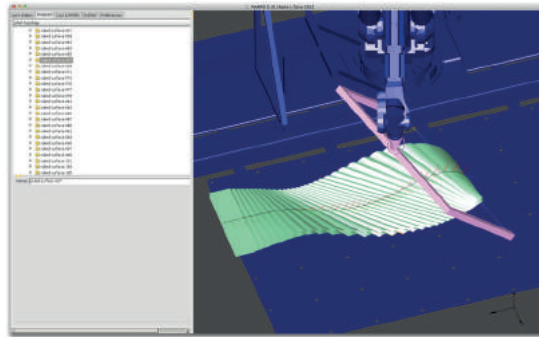

Fig. 13: PyRAPID coding of EPS mould cut with hot wire.

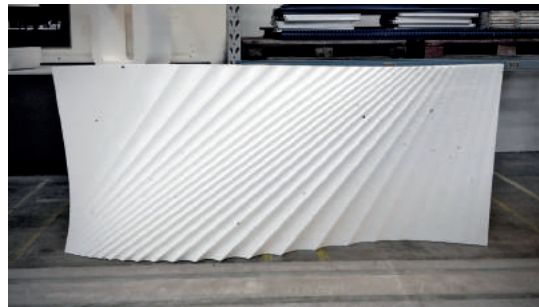

Fig. 14: Cut sample panel from PyRAPID coding.

ACKNOWLEDGEMENTS

Both the development of the diamond wire saw and the Opticut project were influenced and inspired by the work of Prof. Mark Burry.

The Hyperbody's collaboration with both the Aarhus School of Architecture and the Taubmann College of Architecture / Matterdesign took root from the 2011 Fabricate conference. The authors owe their thanks to the organisers of the first Fabricate conference, which sparked the research reported in this article.

We owe thanks to Taubmann College, the Delft Robotics Institute and the Dutch Stimulation Fund for Architecture and to our industry partners Husqvarna and Marmite Graniti d'Italia for their support for the research in RDWS. The authors thank the Aarhus School of Architecture for their generous support in funding the Opticut research project.

NOTES

- 1 Fabian Schreurer, 'Size Matters: Digital Manufacturing in Architecture', in *306090 Books*, 12 (2009), pp. 59–65.
- 2 Matthias Rippmann is a member of the BLOCK Research Group, ETH Zurich, and a founding partner of ROK Office.
- 3 Silvan Oesterle is a member of the Architecture and Digital Fabrication Group, ETH Zurich, and a founding partner of ROK Office.
- 4 Jelle Feringa is a PhD candidate at Hyperbody, TU Delft, co-founder of EZCT Architecture and Design Research and founding partner / CTO at Odico Formwork Robotics.
- 5 Marco Verde, Mark-David Hosale and Jelle Feringa, 'Investigations in Design & Fabrication at Hyperbody', in Ruairi Glynn and Bob Sheil, eds., *Fabricate: Making Digital Architecture* (Cambridge, Ont.: Riverside Architectural Press, 2011), pp. 98–105.
- 6 Wes McGee, Jelle Feringa and Asbjørn Søndergaard, 'Processes for an Architecture of Volume', in *Proceedings of Rob/Arch 2012: Robotie Fabrication for Architecture, Art, and Design* (Vienna: Springer, 2012), pp. 62–71.
- 7 'The workers call the science of the trait, when cutting the stone, the science that teaches how to cut and separately construct more than one ashlar of stone so that, when they are put together (at the right moment), they create a piece of handwork that can be considered as a single object.' Philippe de La Hire (1640–1719), *Traité de la coupe des pierres* (Bibliothèque de l'Institut de France, MS. 1596, fol. 1; cited after Camillo Trevisan, 'The Midden Proportions in the Trait of the Trompe of Anet', *Disegnare Idee e Immagini* 16 (1999), p. 1.
- 8 Li Shutao, Jörg Isele, Karl-Heinz Häfele and Andreas Geiger, 'CAD/CAM Integrated Building Prefabrication Based on a Product Data Model', in *Proceedings of the Joint International Conference on Computing and Decision Making in Civil and Building Engineering*, (Montreal, Canada, 2006).
- 9 Steven Mankouche, Joshua Bard and Matthew Schulte, 'Morphfaux: Probing the Proto-Synthetic Nature of Plaster Through Robotic Tooling', in *Proceedings of the 32nd Annual Conference of the Association for Computer Aided Design in Architecture* (Sloughton, Wis.: Printing House Inc., 2012), pp. 177–86.
- 10 Robin Evans, *The Projective Cast: Architecture and its Three Geometries* (Cambridge: MIT Press, 2000).
- 11 Bernard Cache, 'Objectile: the Pursuit of Philosophy by Other Means', in *Architectural Design*, 69 (1999), pp. 66–71.
- 12 Matthias Rippmann, John Curry, David Escobedo and Philippe Block, 'Optimising Stone-Cutting Strategies for Freeform Masonry Vaults', in *Proceedings of the International Association for Shell and Spatial Structures (IASS) Symposium* (2013). (Wrocław, 2013).
- 13 Asbjørn Søndergaard and Per Dombernowsky, 'Unikabeton Prototype', in Glynn and Sheil 2011 (see note 5), pp. 56–61. Asbjørn Søndergaard and Per Dombernowsky, 'Design, Analysis and Realization of Topology Optimized Concrete Structures', *Journal of the International Association for Shell and Spatial Structures*, 53/4 (2012), pp. 209–16.
- 14 Denmark's leading supplier of precast concrete elements.

MATERIAL EXUBERANCE

VIRGINIA SAN FRATELLO AND RONALD RAEI IN CONVERSATION WITH NERI OXMAN

NERI OXMAN It is a pleasure, Virginia and Ronald, to be talking with you.

Let's begin with Frank Lloyd Wright. When asked about his favourite project during the many years he practised architecture and design, he stated that his favourite project is 'the next one'. I want to ask the two of you, what is your next project, or, what is the project that you are most inspired by at this particular moment.

VIRGINIA
SAN FRATELLO

We are just about to complete 3D-printing a pavilion, called the Saltygloo, which is made of salt harvested from the San Francisco Bay. We are excited to see it come together. The Saltygloo has 336 3D-printed components and the design is based on the forms found in salt crystals that have been aggregated to make an igloo form. The salt has turned out to be a tremendously successful material for 3D printing because of its strength when it comes out of the printer and the beautiful optical effects of

the material. And I think the second one is an upcoming project for a gallery in San Francisco. They are interested in having us 3D-print an exhibition space for them. Those are two projects we are very excited about.

RONALD RAEI

To add to that comment, Emerging Objects started off as a project in our architecture studio. Emerging Objects is our biggest project so far: how can we create an entirely new design and additive manufacturing studio based on the premise of having expertise in architecture and 3D printing.

OXMAN

You state that your firm focuses on emerging technologies and ecological design. What do you define as an emerging technology, especially in the context of additive manufacturing? Would you consider a redefinition of an *emerging* technology as a *convergent* technology? And how do you relate to this notion of emerging technology in your practice and in general?



Fig. 1: Rael San Fratello Architects, Saltygloo, San Francisco, 2013.

RAEL I would say that one of the technologies we would very much like to explore is material technology. We are not looking at material only from a material science perspective; we are also looking at it from the perspective of material traditions. Can there be a re-emergence of traditional materials through the lens of various new technologies? Because we are interested in traditional materials, such as salt or clay or even cement for that matter, we are using them in conjunction with new technologies in order to transform them for new manufacturing processes. We are posing the question: If there are well-established traditions in building with clay or cement, how can we readapt those material traditions in a twenty-first century way through, in our case, additive manufacturing? And there is a convergence that we believe works between history and tradition and contemporaneity and new technologies. This conflation of the past and present is one of the premises behind our work, while another aspect is the convergence of social issues

and thinking about how the relationship between people, politics and society comes together with materials and technology.

OXMAN Going back to Virginia's note about the Saltygloo. As a project that really brings those two ambitions together: first, you are dealing the issue of community via rapid housing and, second, you are dealing with emergent technologies through Emerging Objects and lightweight additive manufacturing. This also matches with your ongoing interest in 3D printing and, of course, founding your new company. The panels in the Saltygloo, as I understand, were made of salt harvested from the San Francisco Bay and bring together two ways of working: on the one hand, working through a theoretical framework that is culturally sensitive and on the other, a very practical agenda that connects with Ronald's interest in earth architecture, which you bring up in your book from 2008, *Earth Architecture*, where you imagine new uses for the oldest materials on earth. It is also very

exemplary of the fact that you can eloquently blend your interests as theoreticians, as academics and as practitioners, which is something that I thoroughly admire about your work. So, share with me a little more about the Saltygloo in this context and the direction you would like to take this project in terms of merging the theoretical, social and cultural agenda and the practical and technological agenda. How do you imagine moving forward from the Saltygloo. What sort of architecture or design might you envision as projecting from or moving forward from the Saltygloo?

SAN FRATELLO

The Saltygloo sets the stage for us to think about how one might bring additive manufacturing technologies to a remote site in order to build or manufacture buildings using local, very accessible and very humble materials that aren't expensive. For example, one could take some 3D printers to a remote location, perhaps one that had recently experienced a natural disaster, and use a very simple inexpensive local material such as salt or clay to build something very large, instead of flying in large amounts of expensive industrialised materials from all over the world, materials that aren't a part of the local tradition or vernacular. That is one way in which the convergence of thinking practically and socially about how material technology can merge with the academic research that we've been pursuing.

RAEL

I'd like to add something, thanks for mentioning the book since it sets the groundwork for just thinking about how powdered materials can be reconstituted into architecture and one of humankind's oldest traditions of building. Certainly, when that research was being done, there were lots of discoveries of the kinds of on-site materials that are used for making architecture and salt is one of them. There is a strong tradition of building with salt in the Middle East, for example, and I think that is interesting because what is happening now in California is that the salt manufacturer who

controls the salt crystallisation ponds (where the salt in the Saltygloo was harvested) is also becoming a building developer, and there is a lot of controversy about how this salt manufacturer is going to use the Bay's water. The San Francisco Bay area, as you may know, is a place where people have a great interest in natural ecology and in preserving the Bay. The salt company is attempting to become a housing developer using the same lands on which it harvests salt. Therefore, theoretically – and maybe someday actually – there could be an interesting speculation about how development could occur on the Bay, and if it were to occur, thinking about the local material resources that would be available for production, so it's all tied back together again.

OXMAN

Is there an emerging definition of the vernacular in your work? How might you define vernacular in your research? To preface this question, when I juxtapose two of your projects, Saltygloo and SOL Grotto, one is exploring the vernacular using organic materials, while the other seems to offer a much more abstract interpretation of the vernacular. Or, by landing a new kind of structure in the Berkeley Natural Gardens, is the Grotto a social message that deals with recyclability? You are operating on a domestic scale, but you are carrying a significant social agenda and to reiterate what Virginia said, thinking about using global tools, such as 3D printing, in local contexts, local communities and local environments. In the Straw Gallery you did a few years earlier, you offered a different definition, favouring again a vernacular material, straw, which is revisited in a modern interpretation in the way which you organised the straw in the form of a gallery, etc. Tell me a little bit about your definition of vernacular in the digital age.

SAN FRATELLO

There is some history in our work that influences the way we approach the vernacular and its confluence with materials and technology. We both come from very rural places. I grew

Fig. 2: Rael San Fratello Architects, SOL Grotto, Berkeley Botanical Garden, Berkeley, Calif., 2012.

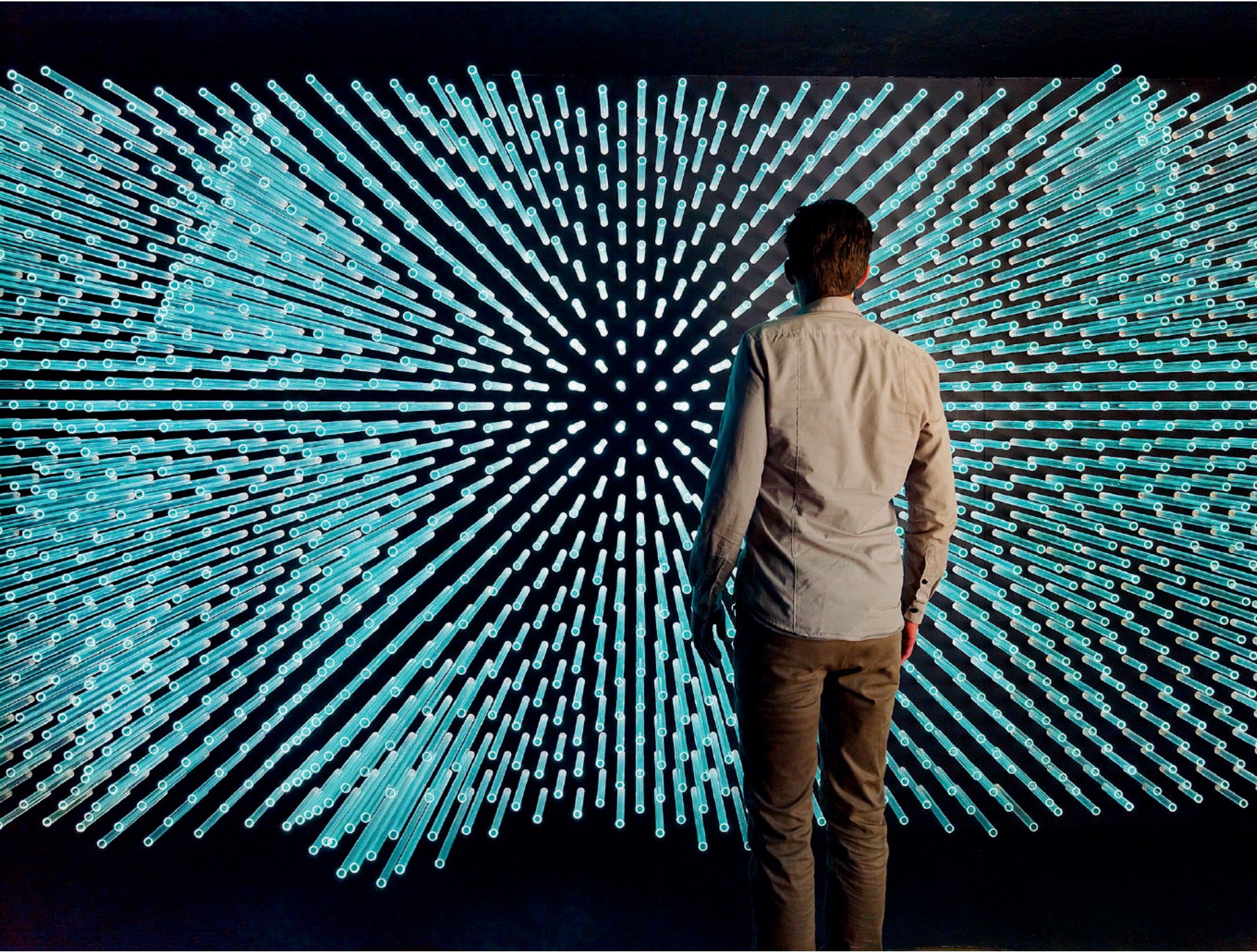

up on a farm and Ronald grew up on a ranch. So we both have a strong connection to the land, to agrarian cultures and to materials. And when we think about these vernacular materials or agricultural materials, we understand them very well – how they smell, what they are composed of – and I think we have a strong desire to use these materials in conjunction with twenty-first century technologies and new programmatic paradigms that would not typically be built using these agrarian or vernacular materials. That’s the origin ...

OXMAN That is fascinating!

RAEL I think, for us something interesting happened when the daughter of a forester and the son of a cattle rancher met at Columbia in the 1990s and discovered digital technology. I think we certainly both come from vernacular traditions. My own house in Colorado happens to be made out of mud. But there is also a redefinition of the vernacular in our work. I think architects tend to think of vernacular as consisting only of past traditions that perhaps no longer exist to a certain extent in certain places. But for us, I think we think of the literary definition of the vernacular, something contemporaneous that which is commonly found in a region, so a high-tech material, such as the Solyndra glass rods, can be seen as a local or vernacular material as well, since the Bay area is known for its research and manufacturing in the high-tech sector. So, for us, using the leftover Solyndra glass rods in the SOL Grotto was an opportunity to build using a local material that was going to be disposed of otherwise. We saw the glass rods as very much a contemporary material as well, because of the controversy caused by the Solyndra bankruptcy, which was widely discussed in the national media and had actual consequences for the built landscape. There were new buildings being built because of Solyndra, land being sold and bought because of their bankruptcy, acres of land being used just to store the 24 million rods,

which were just sitting around after the bankruptcy and we thought we should use them in the creation of a new landscape. I think it’s up to us as architects to also invent vernaculars when reshaping the landscape. I think there is a difference between the architects’ understanding of the vernacular and the understanding of the people shaping the vernacular. I also think we probably don’t see ourselves as vernacular architects, rather we think of ourselves as architects very interested in the vernacular. To work from that by recognising that the vernacular really means working with materials and systems that are ordinary and existing in the present, not only in the past.

OXMAN The farm and the ranch – that is beautiful! I was looking at your website and found the incredible snow globes. I *love* that project! Moving now from the vernacular (and the origins of your childhood as proof of the origin of your work) to another question relating to dichotomy. I find a lot of dichotomies in your work that are very productive dichotomies. You engage with theoretical discourse, but you combine it with a highly technical discourse. You deal with humanistic issues through technological tools. You embody the local and the global, etc. I find these highly productive and meaningful dichotomies in your work and would like to present another that relates to a way of practising design and architecture. There are designers who pursue their practice as a series of projects, almost like Chopin’s etudes, one after the other, where one series leads to the next, etc., and one can almost trace the evolution of the practice through the evolution of the series or the exploration of studies. Here I refer to, in your case, Digital Cement and Digital Ceramics. Then, there are projects on your website that I consider singular, gestural expressions, like your proposal for Life at the Speed of Rail or certain entries to competitions. How do you make decisions about new work or entering a competition? Is there a general thesis that guides those decisions? In other words, how

do you make decisions about which projects to choose and which commissions to take on?

SAN FRATELLO There is one thing they all have in common – even when they seem very different. They are all based on interventionist strategies, we are always thinking about how to intervene in an existing system, landscape, network, piece of equipment, construction technique, etc., so that we can improve the situation through design. If we are talking about Border Wall or Bay Line, for example, there is an infrastructural problem that needs to be addressed, then what is a way that we as designers can comment on it through design to raise awareness or suggest potential change through design? In the case of the SOL Grotto and the use of the Solyndra glass tubes, we found a material that was being disposed of and we asked ourselves how could we intervene into the local waste stream by recycling this material. With 3D printing for example, hacking the printer and using our own materials was a way of intervening in that manufacturing process in order to create new materials and to subsidise our ability to produce in large scales and large quantities.

RAEL You mentioned that architects work in terms of a series of projects and I think one way to define how we work is that we work in two modes of operation that lie at two different ends of the spectrum and outside of the realm of projects. One being ‘operations’ and the other being ‘thesis’. Maybe the singular works that you see are much more like operations. They are the beginning of a formation – what may become a thesis, but hasn’t quite arrived yet. Then there are the theses, which have undetermined trajectories. We can very clearly tie in the relationship between our architecture projects, let’s say our work on the Prada Marfa installation in Marfa, Texas, which is made of adobe, and the US–Mexico border wall speculations that have both grown out of a lineage that also connects them to 3D printing because they are both projects grounded in earthen

construction and earthworks. These kinds of tracteries are found in our work and if we attempted to map them out, we would find they are all connected through a family tree of sorts. We think along those terms. We choose projects that often fall within this lineage, we see how they evolve and grow from one project to another. The Straw Gallery, which might seem like a stand-alone piece of work, had about four different straw and hay projects come before it.

SAN FRATELLO Projects like the 3D-printed Hex Curtain and Wave Curtain, which might seem completely removed from the earth or our research into traditional materials, were actually inspired by looking at mashrabiya, the wood screens one often finds in mud buildings in the Middle East. We made those connections during our travels to Yemen, where we were looking at earthen architecture. For us, there is always a history and a story or a lineage behind the project that ties all of the work together.

OXMAN Would you define yourself as a humanist or a technologist?

RAEL We are certainly humanists, I think even more so because our proficiencies or understanding of technology falls second to our desire to interact with the human condition.

OXMAN It really doesn’t get better than that! Thank you, thank you, for taking the time and for your inspiring reflections.

Fig. 1: Front view of assembled grotto wall.



PRINTING ARCHITECTURE: CASTLES MADE OF SAND

BENJAMIN DILLENBURGER, MICHAEL HANSMEYER

(COMPUTER AIDED ARCHITECTURAL DESIGN, DEPARTMENT OF ARCHITECTURE, ETH ZURICH)

Computational design allows the creation of architecture with an extraordinary degree of geometrical and topological complexity – to the point that it is impossible to fabricate it using traditional CNC technology. In recent years, these complex forms can, for the first time, be materialised using additive manufacturing technologies, albeit hitherto at a very small scale. In trying to use additive manufacturing for the construction of full-scale architecture, one encounters a dilemma: existing large-scale 3D printing methods can only print highly simplified shapes with rough details, while existing high-resolution technologies have limited print spaces, high costs, or material attributes that preclude structural use. In order to overcome these restrictions, the research presented here explores the application of 3D sand-printing technology at an architectural scale. This paper describes the design and fabrication process of a highly complex immersive space that is entirely built of structural 3D printed elements.

INTRODUCTION

COMPUTATIONAL DESIGN: GROWING COMPLEXITY

The advent of CAD software brought a newfound interest in freeform architecture and ornamented surfaces. Today, computational design is further increasing the ‘space for possible forms’ in terms of topological and topographical complexity. While these forms can be readily created and visualised on the computer, they face significant production hurdles. While in earlier days, complex geometries could be built through extensive manual craftsmanship, recent CAM technologies still limit the range of possible forms that can be produced. Therefore, designs have to be significantly adapted to the fabrication processes and material attributes.

DIGITAL FABRICATION TURNS TO ADDITIVE MANUFACTURING

Digital fabrication has been one of the key drivers of the latest evolution in architecture. The digitalisation of building processes has overcome many of the limitations of industrial mass-fabrication: it allows a large degree of customisation, paired with high efficiency and precision. Today additive manufacturing is introducing a paradigm shift in digital fabrication; just as with printing ink on paper, the amount of information and complexity of the output is no longer a relevant constraint.

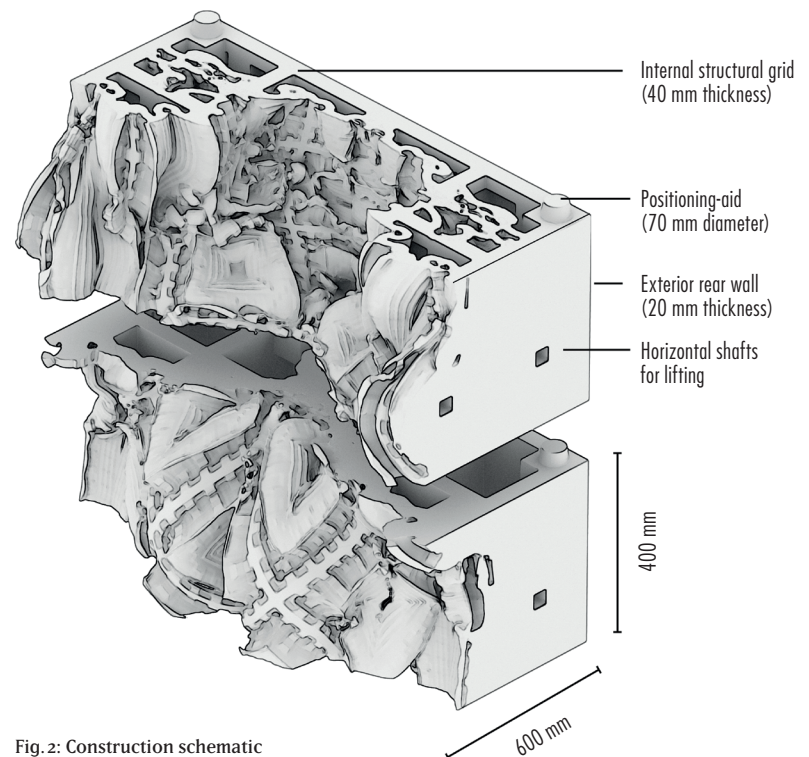

Fig. 2: Construction schematic of two grotto elements.



Fig. 3: Printed 1:3 scale model of grotto wall, uncoated.

3D printing differs from other CNC methods in that it additively combines material, instead of subtractively removing it (e.g. milling, laser cutters, hole punchers) or deforming it (e.g. CNC tube bending, metal bending). It also introduces a new scale in computer-controlled fabrication: materialisation occurs at a fraction of a millimetre. While traditional CNC fabrication methods still require prefabricated elements as a base for customisation (milling, bending, and laser cutting all manipulate semi-finished materials), most 3D printing technologies directly solidify raw material.

Up to now, the application of this technology for architecture has been limited to prototyping or small parts. Material costs are high, machines have limited scales, and the majority of materials are not strong enough to fulfil construction requirements. Recent research in large-scale printers, based, for example, on printing concrete, has failed to achieve high resolutions and is subject to geometrical restrictions. This leads to a situation in which small-scale printed models of buildings can have a higher resolution than the actual constructed buildings. The potential of additive manufacturing is thus far from being utilised.

OVERVIEW OF EXISTING TECHNOLOGY

3D PRINTING AND ARCHITECTURE

The first attempts at printing spatial objects were made in the early 1970s. The term '3D printing' appeared in 1995 in relation to the experiments of Jim Bredt and Tim Anderson at MIT as they printed binder onto a powder bed.¹ The most prominent technologies in additive manufacturing can be differentiated by the state of their raw material (granular, liquid, laminates, and extruded), the components involved in the production process (with or without binder) and the mechanism of solidification (binder, laser, light or heat).²

The first pioneering efforts in construction-scale 3D printing were made by Enrico Dini (D-Shape) and the researchers at Contour Crafting³ and Concrete Printing.⁴ While these visionary engineering approaches already allow additive manufacturing of large-scale, structural components, their relatively low resolution limits the articulation of surfaces, and it prevents complex details from being printed.

3D SAND PRINTING

Sand-printing technology has recently emerged as an additive manufacturing technique that overcomes the limitations described above. This technology is currently used primarily for casting forms in product design. Yet the technology has unique features that make it suitable for creating architectural components. Specifically, it allows the fabrication of large-scale elements with high resolution and accuracy at a competitive price and in a short period of time. The printed sandstone elements can be fully self-supporting and assembled as a solid construction.

Key attributes of sand-printing technology are:

- Large printable space (current volumes up to 4 × 2 × 1 metres)
- High resolution and accuracy (up to 200 dpi, layer height 200–300µm, ± 0.3%)
- No extra support material necessary; almost no geometric restrictions
- High structural capacity (220–280 N/cm² bending strength)
- Low-cost materials (sand) and economical production
- High speed (3 cm/hour at 4 × 2 metre layers)
- Sustainable: natural material, highly efficient use of material with no residual

DIGITAL GROTESQUE: PRINTING ARCHITECTURE

Digital Grottesque is the first human-scale immersive space entirely constructed out of 3D printed sandstone. A complex geometry, consisting of millions of individual facets, was de-

signed uniquely through customised algorithms. This geometry is printed at a resolution of a tenth of a millimetre to the dimensions of a 3.2-metre high, 16 square metre room.

DESIGN

Instead of being designed with mouse and CAD software, Digital Grotesque is created through an algorithmic procedure called mesh-grammars.⁵ This procedure consists of rules that iteratively articulate the structure out of a primitive input form by splitting and growing, in analogy to morphological genesis in nature. At each iteration, the form effectively analyses itself by measuring local topological and topographical attributes in relation to an overall context. This allows highly specific local conditions with complex topologies to emerge. The resulting form, consisting of a mesh of 260 million individual facets, has a resolution and level of detail that would be impossible to specify using traditional means, which fully demonstrates the potential of additive manufacturing. Digital Grotesque explores the dialectic between the natural and the artificial, between chaos and order.

VOXELISATION

Adaptation of the calculated geometry is limited to transforming the surface so that it describes a volume. The articulated mesh is self-intersecting and does not enclose a volume (is not a differentiable, orientable manifold). In order to turn the geometry into a topologically buildable volume, the mesh is voxelised at a resolution of 1 mm, yielding 30 billion voxels in total. Voxelisation is performed by calculating the distance field of the mesh. Segmentation of the overall form and detailing is done within this distance field. The final geometry of each part is turned into a clean, watertight mesh with a marching cube algorithm and exported as an STL file.

DETAILING

The entire room could be printed in just six large elements. The limiting factor for the size of the elements is no longer the printable volume, but rather logistics: parts need to be transportable, and they need to be lifted and positioned for assembly. The dimensions of the elements have been restricted to fit onto 120 × 120 cm pallets that can be lifted by four people.

The weight of the elements was minimised in order to make them more compliant and to limit floor loads. Elements are hollow and their wall-thickness is reduced to a single centimetre in non-critical areas. An internal structural grid is introduced to increase stability. In the design of the elements, two

different load cases were taken into consideration: their orientation in the 3D printer while they are lifted out, and their loads as assembled elements. Each element has simple printed details for lifting it and joining it with neighbouring pieces:

- Truncated cones and funnels provide a consistent and stable vertical alignment.
- Horizontal shafts allow steel bars to pass through for lifting and transport. These shafts are distributed along the centre of gravity of the object.
- Vertical shafts allow the introduction of a steel support structure.

These details were added to the form using Boolean operations. The vertical shafts turned out to be superfluous, as the truncated cones and funnels are of such high precision that the vertical alignment is entirely stable.

POST-PROCESSING

In order to increase the structural stability, the printed sandstone is infiltrated with resin. Together with their inorganic binder, printed elements have a dark green colour with a grainy surface. For the final coating of the elements, a mixture of pigments, alcohol and shellac was chosen to achieve a consistent, smooth, white covering.

Fig. 4: Sand removal from printed grotto element.





Fig. 5: Resin reinforcement of printed grotto element.



Fig. 6: Painting of printed grotto element.

Fig. 7: Assembly of printed elements.



Fig. 8: Side view of assembled grotto wall.





Fig. 9: Front view of assembled grotto wall.

CONCLUSION

This paper shows that with 3D sandstone additive manufacturing, the door is opened for the printing of architecture. The method can be applied both to reconstruct historic buildings or construct new ones. 3D printed elements are within reach, not only as façade modules, but also as construction systems.

In combining computational design with 3D sand printing, the presented approach demonstrates a digital design-workflow with an unknown consistency: architecture is materialised without any manual intervention and without a loss of detail or information. As a consequence, a new logic for the design of architecture is introduced: one can design not just on a plan, but fully in three dimensions, and this can be brought to reality in a level of detail and control unseen until now.

The key challenges for further applications of sand printing in architecture are identified as follows.

- Further evaluation of material properties (fire resistance, weather resistance, insulation, etc.)
- Improvement of the surface quality, allowing smooth surfaces without a loss of resolution.

- Structural optimisation and weight reduction: How can these two objectives be maximised?
- Development of adequate joints for construction and assembling of printed parts.

Addressing these challenges will involve interdisciplinary research in computational design, digital fabrication and material research. In using this technology, ornamentation and complex freeform geometries are no longer hindered by prohibitive costs. The scale of possible three-dimensional articulation and tectonics can be brought to a scale of millimetres. This technology promises a larger compositional and constructive freedom and a rationalised fabrication of unique, non-standardised architectures.

NOTES

- 1 Timothy Anderson et al., *Method and Apparatus for Prototyping a Three-Dimensional Object*, U.S. Patent 6,007,318 filed Dec. 20, 1996 and issued Dec. 28, 1999.
- 2 Duc Truong Pham and Stefan Dimov. *Rapid Manufacturing: The Technologies and Applications of Rapid Prototyping and Rapid Tooling* (Heidelberg: Springer, 2001).
- 3 Behrokh Khoshnevis, 'Automated construction by contour crafting—related robotics and information technologies', *Automation in Construction*, 13/1 (2004), pp. 5–19.
- 4 Sungwoo Lim et al., 'Developments in construction-scale additive manufacturing processes', *Automation in Construction* 21, C (2012), pp. 262–8.
- 5 Michael Hansmeyer and Benjamin Dillenburger, 'Mesh Grammars – Procedural Articulation of Form', in Rudi Stouffs et al., eds., *Open Systems: Proceedings of the 18th International Conference on Computer-Aided Architectural Design Research in Asia. CAADRIA* (Hong Kong, SAR: The Association for Computer-Aided Architectural Design Research in Asia, 2013), pp. 821–9.

Fig. 1: Bloom in UCL's main quad.



BLOOM

JOSE SANCHEZ, ALISA ANDRASEK

This paper presents the Bloom project commissioned by the Mayor of London, designed and developed by Jose Sanchez and Alisa Andrasek of the Bartlett School of Architecture, University College London (UCL) for the 2012 London Olympics. The project connects ideas of modular discrete assembly with game mechanics, generating an interactive installation that changes and grows through the engagement of the public. The project was presented in three locations during the Olympic Games, demonstrating the adaptability and the contingent formations that the public could generate with the project.

THE PROJECT

Commissioned by the Greater London Authority as part of the Wonder series that celebrated the Olympics and Paralympic Games, Bloom is an interactive architectural installation designed and developed by Alisa Andrasek and Jose Sanchez of the Bartlett School of Architecture at UCL, London. The project proposes a crowd-sourced approach for assembling a forma-

tion by using game mechanics as part of the design of one unit. This unit (the Bloom Cell) would be produced in an array of 60,000 identical copies, both allowing and expecting the public to 'play' and assemble diverse formations. The project was conceptualised as an act of 'collective gardening', where new formations could constantly emerge or disappear depending on the interactions with the crowd.

Fig. 2: Bloom competition entry.



The project was also intended as an educational installation; the public would learn about patterns and structure by figuring out what structures could stand and how to achieve specific sequences. Collective interaction was expected based on the number of units that would be available to the public at any given time. The units were intended to become tokens of participation, allowing the public to take them home as a souvenir, while adding to the concepts of dissipation and entropy of the piece. The project was approved in April 2012, leaving a very short timeframe for development since it needed to be ready for the London Olympics by the beginning of July 2012.

COMPUTATION

Bloom was conceptualised using an algorithm of recursive aggregation: the algorithm uses a piece of geometry and determines possible connections to another similar unit. Once the possible combinations are determined, the script will replicate the geometry in a selected orientation, just the way you would build the system in reality. As the shape of the unit is asymmetrical, every connection, if followed over several iterations of aggregation, would generate different patterns. The underlying principle is a branching or Lindenmayer system.¹ The tool, written especially for the project, had the ability to quickly generate large aggregations and evaluate the design output implied in the angles of the unit.

One of the first computational challenges the project faced was to allow the recursion of the algorithm to happen simul-

taneously from the definition of the geometry of the unit. As every variation in terms of angles and orientation generates a non-linear change in the outcome, it was crucial to have the parametrics of the system in real time. This proved to be the key in deciding the final shape of the unit, allowing the designers to iterate extensively over different aggregations anticipating the possible variations.

While the recursive aggregation would create branching structures, the project faced the challenge of allowing loops in the structure in order to generate redundancy and stability. The design team was faced with two alternatives: one in which the geometrical definition of the cell would geometrically loop in itself, or a second version in which the unit would have a certain flexibility, providing a degree of tolerance that would escalate recursively as the piece became larger. While the former would generate an outcome as an engineered forecast, the latter could cater to the uncertainty of the game play and social factors that the project had been built upon. Simulation and noise were used as a strategy for resilience and redundancy.

The strategy of flexibility was selected, based on the understanding that a social interaction with the piece would need a resilient strategy if it was to succeed. The flexibility allowed for reconnections to happen extensively throughout the structure, always requiring a slight deformation of the units. This operation would introduce tension into the structure and would become the main mechanism that allowed larger formations.

Fig. 3: Rendering of recursive aggregations.

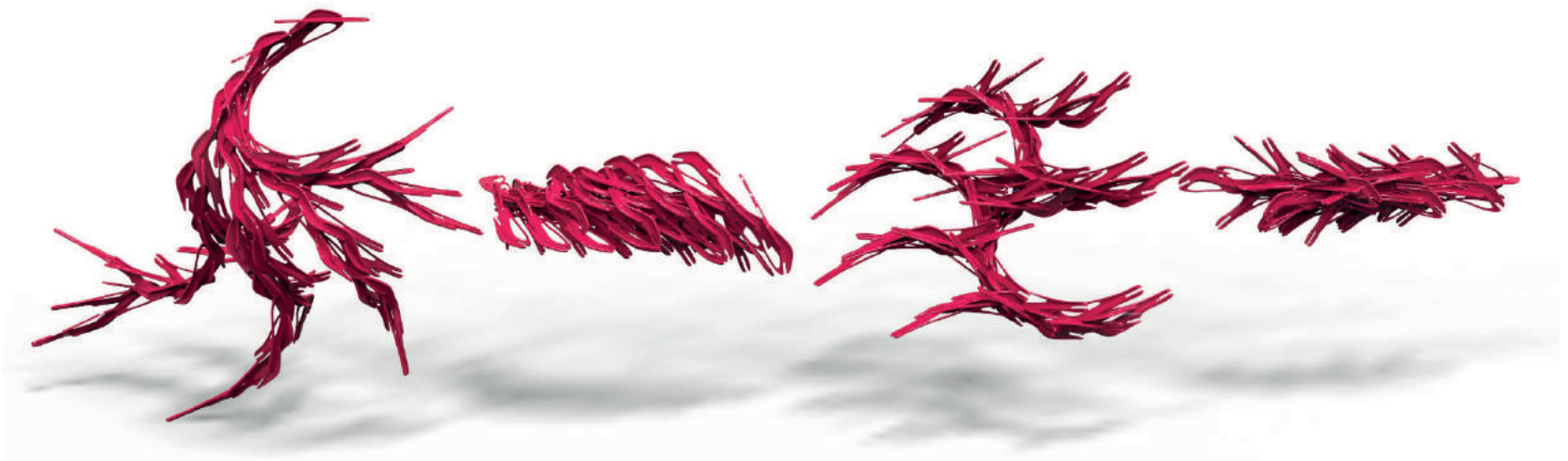



Fig. 4: Metallic mould for injection.

MANUFACTURING

The project collaborated with the Chilean manufacturer, Atomplast, whose support was important in the process of injection moulding as a large number of identical units were required. All the calculations resulted in one single unit, and with the help of engineers from Arup, it was possible to manufacture the final piece. The process of injection moulding had to be extremely precise; while a tight connection wouldn't allow the game play and disassembly of the project, a loose connection would not allow for structures to be erected. It also had to take the expansion of the polypropylene plastic under diverse weather conditions into consideration. Finally, the mould was completed, allowing production of 60,000 units in less than a month with a production time of two units per minute.

A second part of the project was the helicoidal urban 'furniture' that would support the spontaneous formations. This furniture was conceptualised as the foundation of the project, as the ground plane could not be altered. The ambition of the height and density of the project led the design team to conceive a helicoidal structure that would 'spawn' branches in several directions. The 'Helix bench' was designed as a sequential array of components positioned throughout a helicoidally bent pipe. For the construction of such a structure, the team approached a staircase manufacturer that could achieve helicoidal bending. Working closely in a rationalisation of the sections of the bench, it was possible to get the radius that would support the piece and create the desired effect.

The modules were designed to be disassembled and transportable, allowing the project to re-appear in different sites without the need for foundations. The form of the unit also

Fig. 5: Bloom spiral bench.



needed a series of variations to allow the pipes to go through it. The form of these holes in the Bloom Cell were adapted for the distribution of stress in the unit, while considering the contact points of the structural tube going through them.

TAXONOMY AND UNCERTAINTY

Bloom presented a paradox in trying to classify it. The project presents an undefined taxonomy, which poses a problem for insurance policies and city planning permits. The problem of uncertainty was initially detected through structural engineering as it was impossible to do simulations for all possible formations or apply rules that would ban certain structures. Ultimately, no engineer would sign a project that is so open-ended. In terms of permits, it was difficult to give a classification to the project; it was unclear if the outcome could be an enclosed space that would need evacuation or simply urban furniture. It was unclear if it would fit in an architectural classification. The ambiguity of the taxonomy of the project presents an interesting reflection on what is an expected outcome of a creative process and the boundaries of the discipline.

INSTALLATION

Bloom was installed in three locations in London for the duration of the Olympic and Paralympic Games: Victoria Park, UCL main quad and Greenwich.

The project didn't have any blueprints, and thus relied on the improvisations of the participants in order to learn how to build structures. A fast learning curve, based on game mechanics, allowed members from the Bloom team to initially build diverse formations in the different sites, adapting to the



Fig. 6: Bloom in Victoria Park.

particular conditions of the location. Each installation used approximately 5000 units and was built over a period of 3–4 days with a team of 3–4 people. This time became shorter in every instance of the project as the installation team learned how to work with the material.

The unit presented three very distinct connections (A-B-C). Due to the asymmetry of the units, each connection could be used in two different orientations. The notation system would allow any player to share the ‘code’ of how to create a specific formation; much like Lindenmayer Notations, a code would be expressed by a series of strings like $+A\triangleright+A$, $+B\triangleright-A$, where the $+$ and $-$ signs would suggest the flipped alternative.

The public did not engage this system but created an alternative where the unit would be associated with the shape of a fish, and connections would be Mouth (A), Tail (B) and Fin (C). This emergent notation required knowledge transfer for the creation of structures, thus reinforcing the educational nature of the project and the importance of knowledge transfer.

The concepts of redundancy and flexibility embedded in the piece proved to be essential for stable structures and allowed players to break the determinism of branching structures and generate redundancy.

What the Bloom team initially developed soon became accessible to the public, which altered the initial structures. Moreover, Bloom provided approximately 2000 pieces a day just for playing.

GAME PLAY

The process of documenting the game play of the public with the piece was a fundamental part of the project. By understanding how the geometry would generate the engagement of the public, we could speculate on the relationship of design to negative entropy. The pieces were provided in a disorganised manner, making it necessary that the rules of assembly must be self-evident to any non-specialised builder. In this regard, the project draws inspiration from kits like LEGO®, which define an open sandbox for creation and also an explicit form of assembly.

Neil Gershenfeld defines digital materials² as materials that can define their own coordinate system in a discrete way and correct the inaccuracies of the assembly. While Bloom was inspired by this idea of pure discreteness, it was inevitable that the project would have to work with flexibility, as explained previously, making the project navigate constantly between discrete assembly and continuous deformations.

While most of the alterations and production from the public remained in the domain of expected outcomes, there were some ‘black swans’,³ using Taleb’s term for unexpected events. Taleb describes how ‘black swans’ are highly improbable events that cannot be forecasted because they are outside our models of prediction. This is precisely what the Bloom project is, in a way, searching for: outcomes that redefine the limits of the designed system by altering or breaking some of the rules provided. This idea suggests that the designer accepts that he/she cannot forecast all the possible outcomes of



Figs. 7, 8: Bloom game play.



Figs. 9–11: Bloom game play and creations by the public.



Fig. 12: Bloom formations in UCL's main quad.



an intervention, and also suggests that there are strategies to actively engage with this condition.

It was also important that the piece would not have any right or optimum solution or any clear signification or association with existing forms, as this would have caused the outcomes to converge into similar solutions. In this way, the game needs to be contextualised as an open-ended structure, not a puzzle. References from the video game world, such as *Minecraft*^{TM,4} suggest that there is no ‘winning’, but rather a perpetual act of building. This point is central to the thesis of the project, as it tries to question the idea of the optimum or of ‘form-finding’, which imply a right way of doing design.

The public found new patterns that quickly spread among players and allowed different and more resistant structures, often understanding that the rhythmicity and repetition in the assembly could generate patterns with specific properties. Some of the most exciting assemblies came out of figuring out these principles.

Bloom is an ongoing project that will be exhibited in numerous locations worldwide, including France, Hungary and China.

ACKNOWLEDGEMENTS

The Bloom project wouldn't have been possible without the extraordinary team of support that includes Chris Sazos, Manja Van de Worp, Salih Topal, Dagham Cam, Andres Darko, Kathleen O'Donnell, Alberto Herrera, Julia Almeida, Pallavi Sharma, Nicolo Friedman, Vincenzo D'Auria, Mark Muscat and all the Bloom players. More information can be found at: www.bloom-thegame.co.uk.

NOTES

- 1 Przemyslaw Prusinkiewicz and Aristid Lindenmayer, *The Algorithmic Beauty of Plants* (New York: Springer Verlag, 1990).
- 2 Neil Gershenfeld, ‘How to Make Almost Anything’, *Foreign Affairs* 91/6 (2012), pp. 43–57.
- 3 Nassim Nicholas Taleb, *The Black Swan: The Impact of the Highly Improbable* (New York: Random House, 2007).
- 4 *Minecraft* is a trademark of Notch Development AB; and under copyright to Mojang © 2009–2013.

Fig. 1: Cast Thicket: peel-away drawing showing scaffold, steel, skin and volume layers.

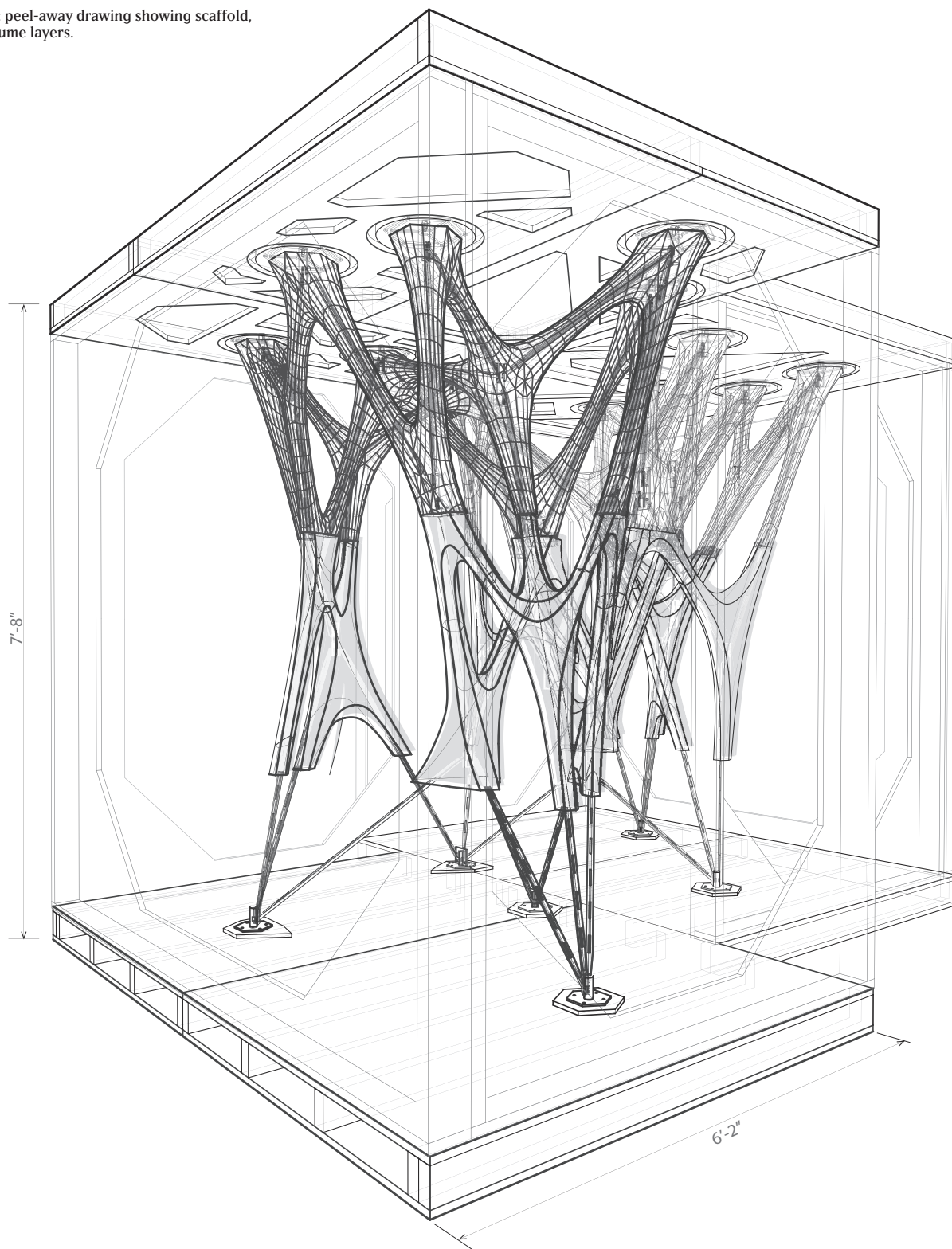

PLASTIC-CAST CONCRETE: FABRICATION AS APPLIED RESEARCH

KENNETH TRACY, BRAD BELL, CHRISTINE YOGIAMAN, LAVENDER TESSMER, KEVIN MCCLELLAN,
ANDREW VRANA, ERIK VERBOON

Cast Thicket is a prototypical installation that furthers earlier research into tensile concrete moulds through the use of plastic formwork and a layered structural network. Leveraging the fluid materiality of concrete and the machinability of polypropylene, Cast Thicket creates a lacy network of thin members that disperse and coalesce to address structural and spatial needs. Proposed as an application for tall, concrete buildings, the research responds to the 2012 APPLIED: Research through Fabrication competition. Collaboration between Yogi Aman Tracy Design, the TEX-FAB fabrication network, the TOPOCAST Lab and Buro Happold Engineering facilitated the project's realisation and expanded the discussion beyond the single installation.

APPLIED: RESEARCH THROUGH FABRICATION

Within the field of architecture, exploration involving computational fabrication is both wide and varied. There is no standard of how the technology is developing and no singular focus on how it is impacting the design process or the construction of buildings. And yet there is growing evidence that the application is quickly evolving in a variety of unique directions. From novel geometries and innovative structures to improved material and environmental performance, it is clear there is a focused agenda towards a more rigorous implementation of the digital toolset through applied research.

The impetus for this development is coming simultaneously from three positions that collectively provide a critical nexus in the field of computational fabrication: First, the professional demands for buildings to have greater performance capacity, stylistic coherence, and economic efficiency; second, the academic realm where experimentation, research, and theory continue to push technological exploration forward; and third, industry, where innovative development is both an economic imperative and a generative vehicle for technical application and testing.

Cast Thicket is the winning proposal of the two-stage APPLIED: Research through Fabrication competition (fig. 2). The winning



Fig. 2: Cast Thicket: installation at the TEX-FAB Exhibition at the University of Texas, Arlington. (Photo: Craig Gillam.)

team of Yogiaman Tracy Design (yo_cy) along with TEX-FAB, TOPOCAST Lab, and Buro Happold worked to execute the next iterative step in the development of research into tensile concrete moulds through the use of plastic formwork and layered structural network. This collective action demonstrates both the range of innovation being conducted in the field of computational fabrication research and also the capacity for collaborative action to facilitate compelling opportunities for exploration.

CAST THICKET PREMISE

Architectural use of tensile formwork is not new. Patents date from as early as 1899 and ongoing practitioners continue to push the boundaries in terms of practical application and aesthetic expression.¹ Miguel Fisac's work from the late 1960s is arguably the first that leverages the expressive materiality and practicality of soft moulds. Fisac's work consciously expressed the softness of the plastic moulds and the fluid materiality of concrete.² Inspired by Fisac's buildings, Andrew Kudless furthered this research with his P_wall project of 2009.³ Taking advantage of both stretchy fabric and computational strategies, Kudless creates continuously variable surfaces, modulating both material density and aesthetic intensity. Led by Mark West, The Centre for Architectural Structures and Technology (CAST) in Manitoba indexes the specific materiality of geo-textiles to create large-scale, concrete components that optimise structure while using minimal material.⁴

Cast Thicket continues this work on soft moulds, but is distinct in two ways. First, it uses semi-rigid polypropylene sheets with integrally fabricated seam connections. Second, the overall organisation uses a tensile network of struts and nodes to distribute load and create space. These distinctions yield several technical and spatial advantages. Embedded, prefabricated seams in stiff plastic expand the formal language of tensile moulds, allowing for concave ruled-surface geometries as well as convex forms. The seam strategy also allows for the tool-less assembly of seams in 3D space and reduces the need for vertical seam supports. The tensile network formation in conjunction with localised surface optimisation allows the minimal use of mould surface while remaining incrementally variable and spatially responsive to contingent design constraints.

DYNAMIC TENSILE NETWORK

The design of the latest iteration of Cast Thicket used a compressive scaffold as its starting point (fig. 1). The scaffold allows the internal mould to be entirely tensile and serves as a reference for positioning the frame. TOPOCAST Lab additionally developed the scaffold to act as transport bracing and shipping. Fitting the scaffold into the gallery space for the exhibition thus set the preliminary size and weight constraint of the overall piece. Within these constraints, yo_cy developed a tensile network, which became the centreline for both concrete mass and steel reinforcement.

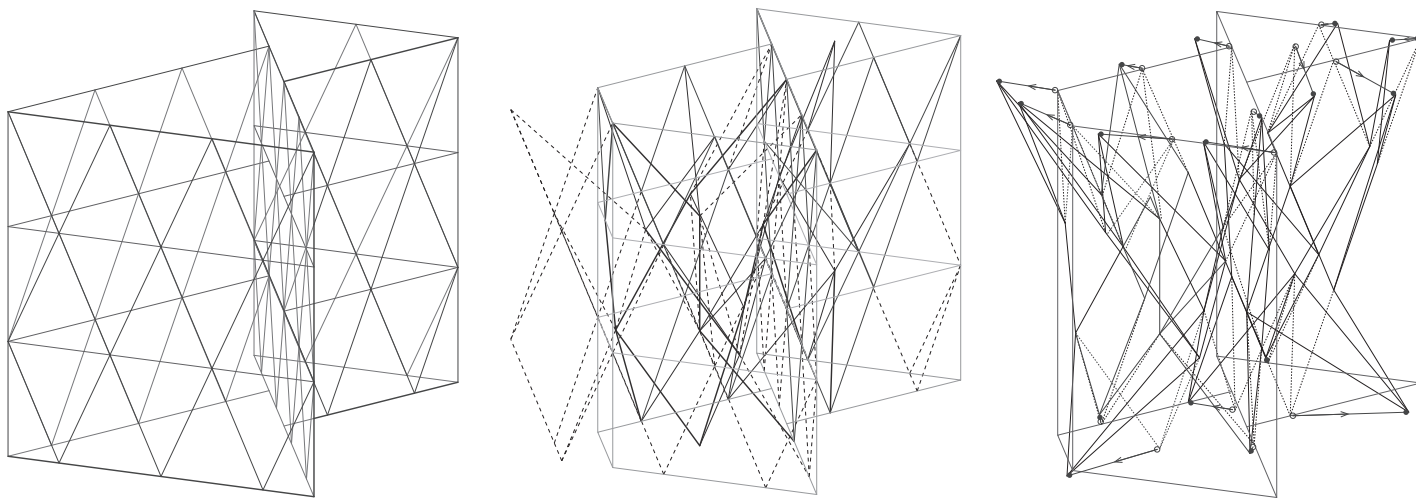

Fig. 3: Massing strategy diagrams (from left): equilateral triangles with three levels of vertical diagrid, truncated massing grid with simplified interior branching members, and base points spread out for stability.

Starting from an initial grid converted to virtual springs in Kangaroo, yo_cy set up an optimisation scheme similar to the game cat's cradle (fig. 3). Played out over a series of iterations, the virtual spring simulation is trained into an optimised, interlaced network. Using two types of nodes, fixed and dynamic, allows the framework to be moved either directly by positioning fixed nodes or more subtly by changing the tension on the springs. This nuanced, haptic design process allows yo_cy to interface with and adjust to the structural concerns from Buro Happold while creating a formation that demonstrates the maximum flexibility of the system.

STRUCTURAL ANALYSIS

The computational approach used by yo_cy in developing the form allowed a fluid exchange between the design and analysis models. The embedded centreline skeleton is the primary interface for design iterations. The iterative simulation allowed the design and fabrication team to make decisions about member lengths, cantilever spans, and the required bracing during construction.

To prevent the concrete from cracking, the final geometric configuration must satisfy the imposed loads without failure or signs of stress. The neuron-like formation of the piece, though inherently stable, does not provide direct vertical load paths and its upper, cantilevered branches resulted in some high nodal moments. These constraints on the structure, once

analysed, confirmed the original strategy of relying on a steel reinforcement frame for tensile support. To ensure that the concrete does not show signs of stress, the underlying steel is designed to do the primary structural work, not relying on the concrete for stability, while minimising deflections in both the pre- and post-cast conditions.

STEEL REINFORCING FRAME

Cast Thicket's internal steel frame replaces typical steel re-bars. Using both flat-cut and radial laser cutters, the system leverages CNC technology and parametrically variable connections to create a smooth fabrication workflow and to ensure precise positioning within the slender moulds (fig. 4). The system uses T-section struts and vertical pipe connectors to overlay the tensile network's spans and nodes. Organising the welding workflow in stages allows small node components to be tack-welded so the frame can be cold-assembled and positioned before the final structural welds are made.

Centred at each node, vertical pipes act as the primary positioning element of the assembly. Indexing the azimuth angle of each connection, these slotted pipes receive the hooked tenons of the vertical component of the T-sections. Each strut is fabricated from three flat-cut parts. Registering the altitude angles of each connection, the vertical portion of the 'T' is bisected so each side can be pre-welded to its corresponding node-pipe (fig. 5). Working with TEX-FAB, yo_cy designed

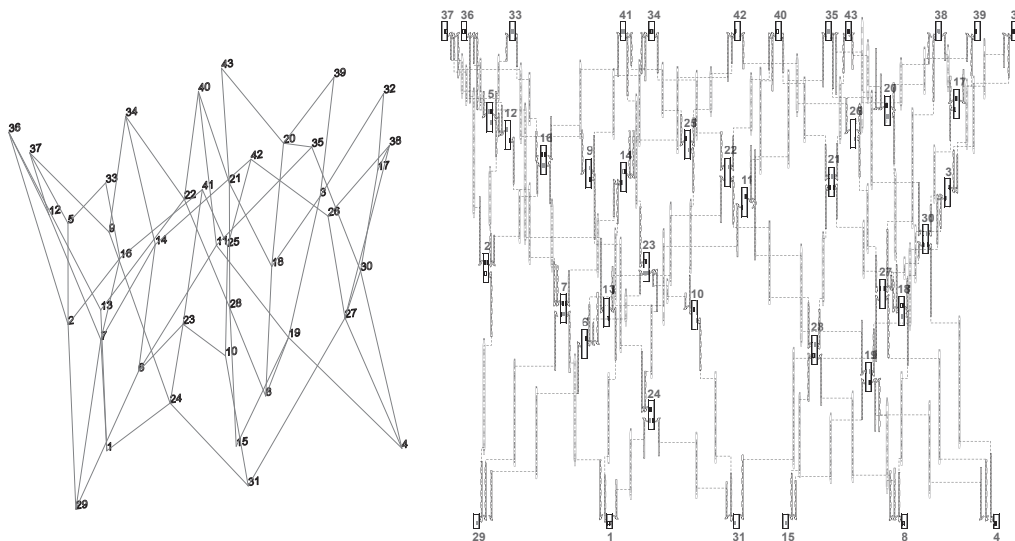

Fig. 4: Cast Thicket: diagram showing relationship of steel components.

a system of CNC cut angle-finding jigs to precisely locate and weld the vertical strut components to the node-pipes (fig. 6). A notched, horizontal T-component spans the full length of each strut, precisely aligning to the tenons of each pair of bisected verticals. This three-part connection system allows pre-welded, branching nodes to be ‘stitched’ together and temporarily secured with zip ties. Using a system developed by TOPOCAST, the zip-tied assembly is precisely located relative to a template in the base of the scaffold and then welded in place.

MOULD SURFACE OPTIMISATION

Again using the spring network as a centreline, the mould patchwork starts from a piped, hexagonal profile. The hexagonal profile accommodates many nodal relationships, including 1:1 or bypassing conditions, 1:2 bifurcating conditions, up to 3:3 nodes and all permutations in between. This rough, tubular form is topologically refined through mesh relaxation (fig. 7). Relaxation dynamically simulates the behaviour of a stretchy, tensioned skin morphing the straight, longitudinal profiles towards minimal arcs. Several parameters were at play in formally defining the final surfaces. Increasing mesh subdivision prior to relaxation greatly decreased the volume of the final mesh, creating a more linear formation, while decreasing subdivisions spreads the struts into more continuous surfaces. The intensity of the relaxation can be varied through using more or fewer iterations. Each iteration brings the struts closer to a true catenary profile, thus reducing their surface area. Limiting this variation is crucial, as it tends to create a bottleneck for concrete when the profile area at the centre point is decreased. Once a balanced volume is achieved, the initial profile edges are extracted from the mesh and lofted to form developable, ruled-surface patches. These patches are combined and unrolled to form the initial patterns for the polypropylene formwork.

PLASTIC FORMWORK

Integrally fabricated parametric tabs are used to lace or tie the tensile plastic patches together. Seam curvature indexes the relaxation of the mesh. This same curvature guides the distribution of the tabs, which increase in density to correspond with reduced curve radii (fig. 8). This non-uniform distribution of tabs allows for stronger, more redundant connections at nodal joints where most tension occurs during the casting process.

Designed to be assembled exclusively from the exterior of the formwork, the tabs leave a smooth tensioned seam on the

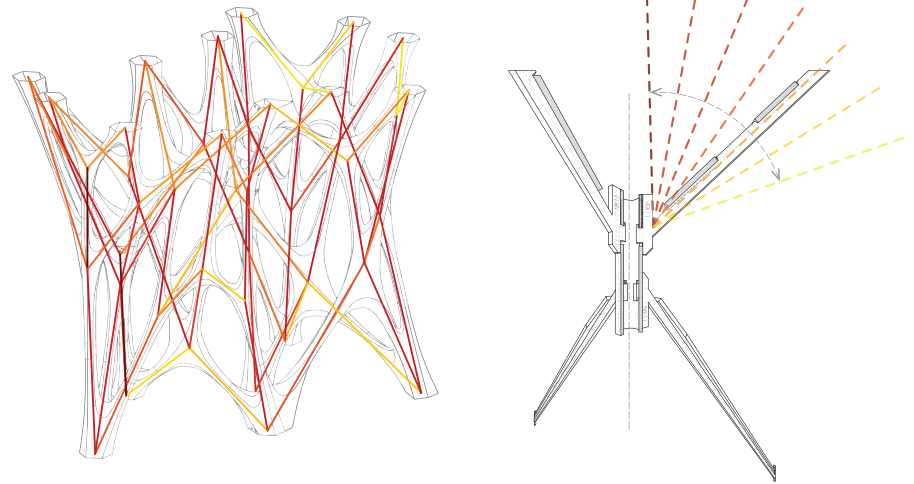

Fig. 5: Steel assembly diagrams: variety of vertical steel connection angles, range of vertical angles accommodated by steel pipe detail.

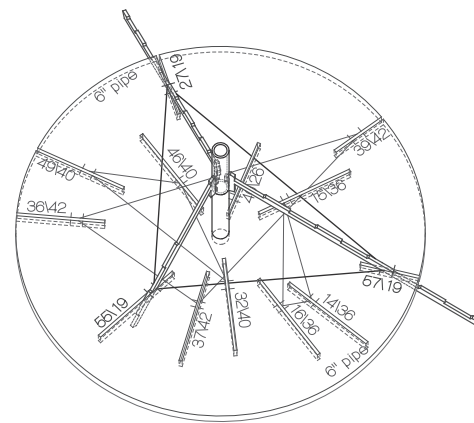

Fig. 6: Steel assembly process: precise horizontal angles registered by angle-finder welding jig. Radially-cut steel pipe, flat-cut steel struts, and plywood angle-finder jig.



interior of the mould surface. Calibrated to the dexterity of the hand, a single hole in each tab creates a finger-sized handle to allow incremental manual lacing of the seams. Sequenced after the final welding of the steel frame, the external tabs allow the skins to be partially pre-laced in groups that correspond to nodes and then wrapped around the steel to form the moulds (fig. 9). This strategy organises the skin assembly so several nodes can be assembled simultaneously (fig. 10).

Once assembled around the steel, the plastic formwork is further tuned using techniques developed by TOPOCAST Lab.

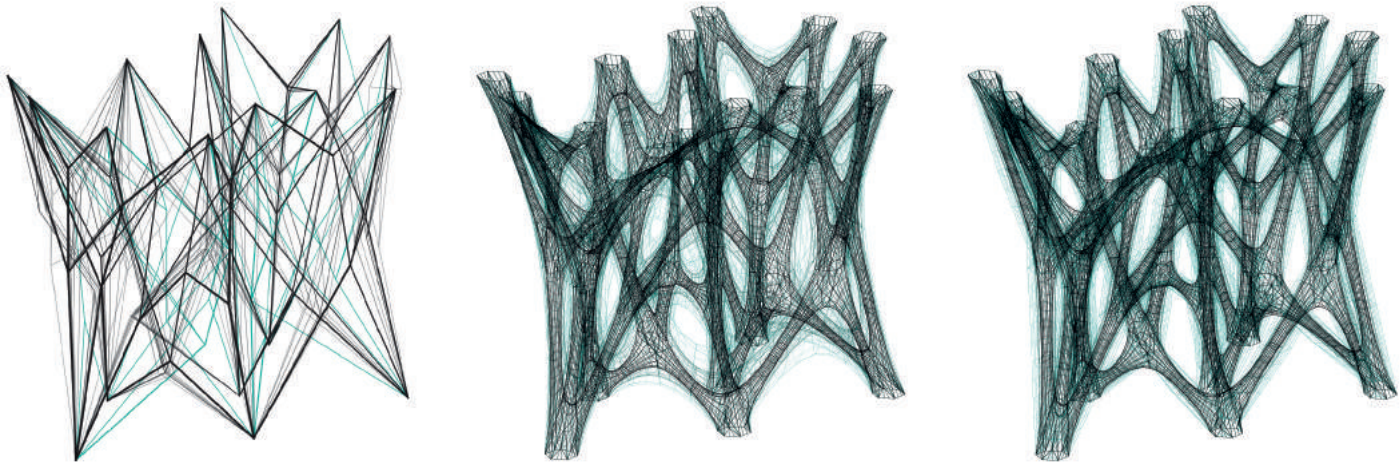

Fig. 7: Form-finding and optimisation diagrams (from left): tensile network optimisation, mesh subdivision form-finding resulting in varying porosity, and mesh relaxation varying iterations.

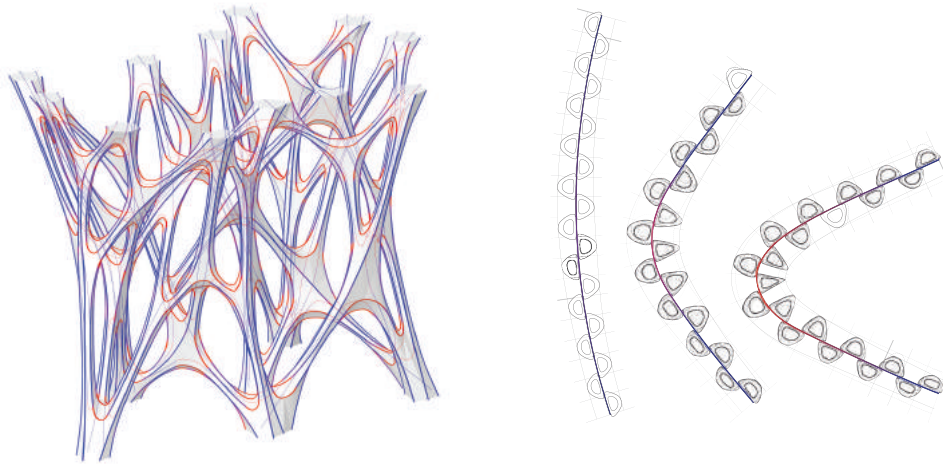

Fig. 8: Plastic formwork detail diagrams: seam curvature analysis, tab density increases with increased curvature.

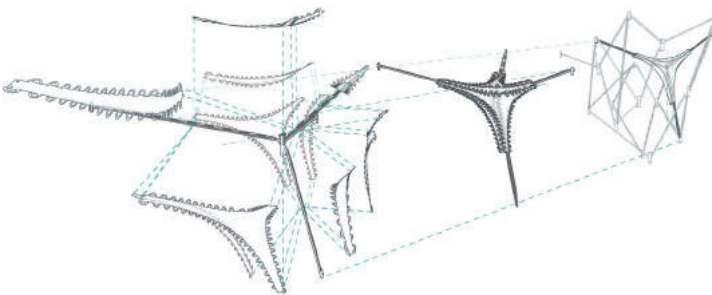

Fig. 9: Cast Thicket: exploded axonometric drawing describing assembly process.

The tabs play an important role at this stage, providing an anchoring device for seam reinforcement and positioning the mould relative to the scaffold. Nylon string is laced through the tabs and reinforces the mould at the bottom nodes and in other areas of high pressure (fig. 11). Further reinforcing can be achieved locally through the use of zip ties during pouring. Though empirically determined, these techniques evidence the tensile nature of the mould and the materiality of the polypropylene by piggybacking on the optimised connection system.

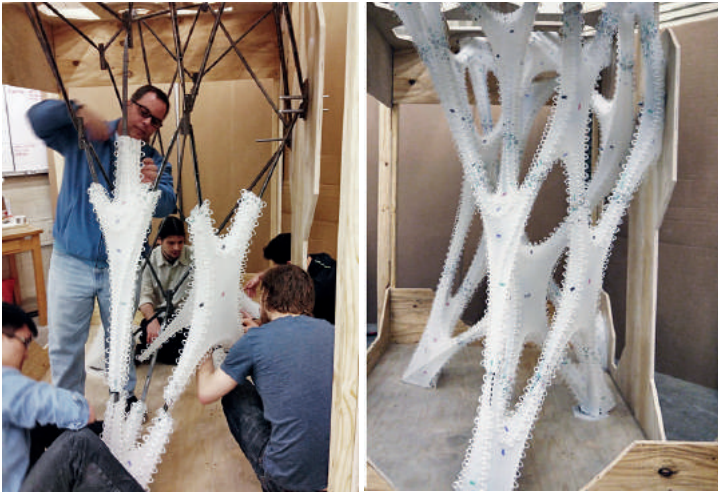

Fig. 10: Plastic formwork assembly process: assembled steel frame, plastic formwork being tied around steel frame, and fully assembled plastic formwork.



Fig. 11: Nylon string laced through tabs in plastic formwork.

CONCRETE COMPOSITION

The final material component of Cast Thicket is a custom formulated mix of high strength, low-viscosity white concrete. Several substitutions and admixtures were made to create a mix that is lightweight and facilitates pouring into the complex, slender moulds. Using Poraver[®] expanded glass to replace sand as a fine aggregate is the most significant deviation from typical concrete. This ultralight, air-filled aggregate reduces the

overall weight of the mix by 22%, allowing a significantly larger construction and enabling manual positioning inside the gallery. Polypropylene fibres reduce small cracks that may occur during movement, and set retarders and plasticisers increase workability time and liquidity. Along with precisely screened large aggregate, these admixtures allow the concrete to flow into small gaps and enable larger quantities of concrete to be poured incrementally into the intricate moulds (fig. 12).



Fig. 12: Casting process: assembled polypropylene formwork, formwork after casting, and unwrapped concrete. (Photos: Craig Gillam.)

CONCLUSION

Cast Thicket is a proof-of-concept prototype that presents formal qualities, structural configurations and spatial effects new to tensile mould typology. This novel approach has proved at an installation scale that the logistic and spatial effects predicted in simulations and small tests are achievable. Though successful at this scale, the installation also provokes new questions and problems for plastic cast tensile moulds. Primary among these concerns is the current lack of predictability of the moulds' final form and the lack of information to increase the scale of this application. While Cast Thicket closely simulated the overall configuration and approximate volume, the current simulation techniques do not predict local buckling. Though this is not central to the form or structure at this scale, in a projected, large-scale application this type of discrepancy may be detrimental. Further exploration will attempt to predict buckling through more precise physics simulation. Scalability is also a challenge both in terms of labour management and seam strength. Integral seams do allow for variation, but testing on larger-scale components would significantly add to the variation and to instrumentalization of the process. Finally, structural testing of the concrete and prefab frame would yield critical data for realizing a larger application.

Though challenges remain in the direct use of Cast Thicket for tall projects, the test proves the materiality, novel formal qualities and structural assumptions. Seam detailing and semi-rigid plastic moulds allow for concavity and visually sharp seams which are new to tensile mould typology, while the tab geometry yields both fast, toolless assembly and secondary spatial effects registering the stress based on local curvature. Additionally, the use of recyclable, ultralight, one-off moulds presents a radical variation in the economy of cast architecture. Finally, the network-based structural configurations show potential for more contingent, flexible structure that could alleviate the need for opaque structural cores while reducing the overall weight and cost of moulds.

NOTES

- 1 Diederik Veenendaal, Mark West and Philippe Block, 'History and Overview of Fabric Formwork: Using Fabrics for Concrete Casting', *Structural Concrete*, 12/3 (2011), p. 165.
- 2 Luis Fernández-Galiano, 'Miguel Fisac', *AV Monographs* 101 (2003).
- 3 Andrew Kudless, 'Bodies in Formation: The Material Evolution of Flexible Formworks', in Joshua M. Taron, Vera Parlac, Branko Kolarevic and Jason S. Johnson, eds., *Integration through Computation: Proceedings of the 31st ACADIA Conference, October 11–16, 2011, University of Calgary, Banff, Alberta, Canada* (Capo Beach, Calif.: Association for Computer-Aided Design in Architecture, 2011), p. 101.
- 4 Veenendaal, West and Block 2011 (see note 1), p. 172.
- 5 Poraver® is a registered trademark of the Canadian firm Poraver North America Inc.

Fig.1: Honeycomb brick: detail of wall prototype.

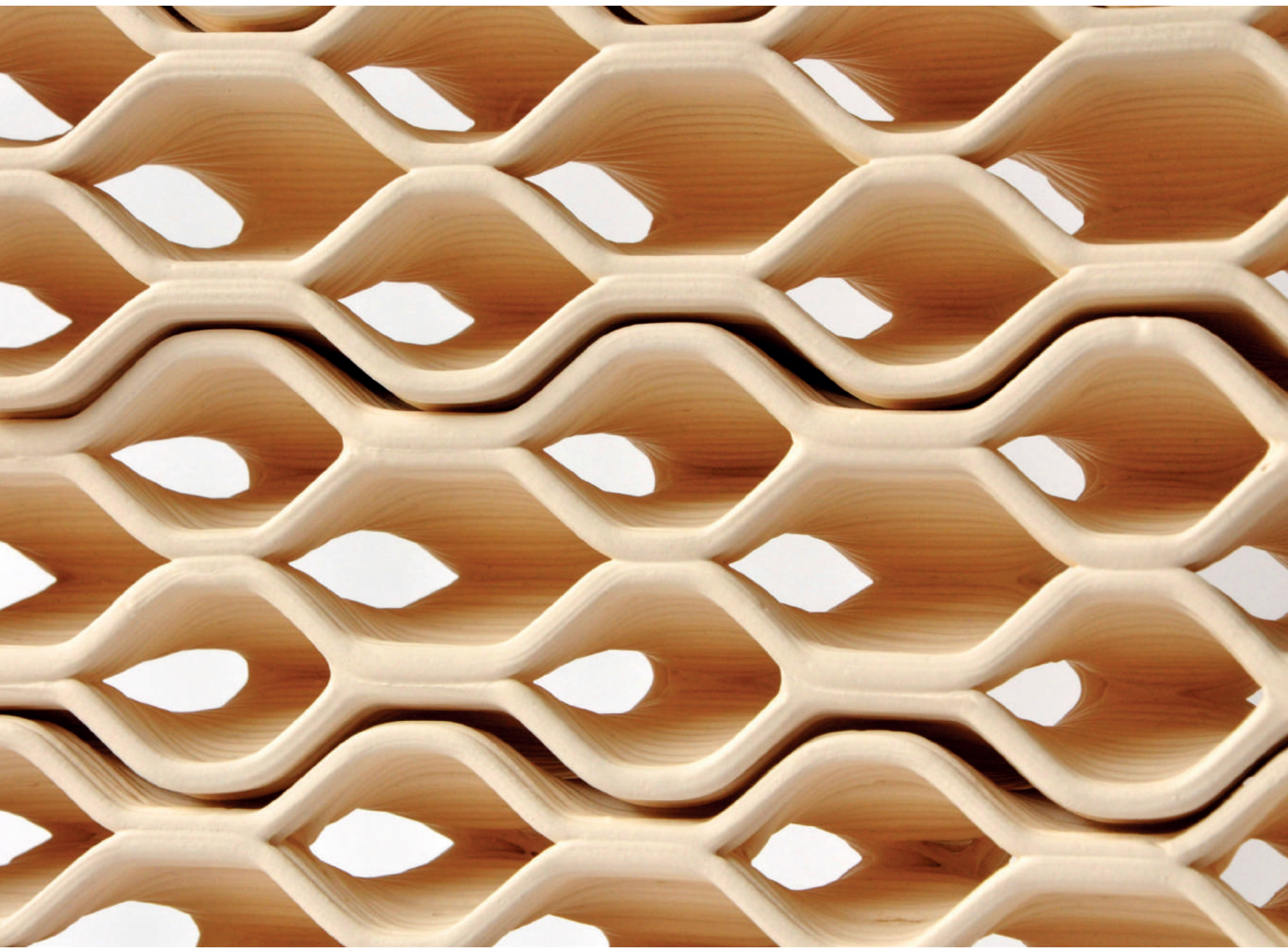

BUILDING BYTES: 3D-PRINTED BRICKS

BRIAN PETERS (COLLEGE OF ARCHITECTURE AND ENVIRONMENTAL DESIGN, KENT STATE UNIVERSITY)

Combining a traditional building material (ceramics) with a new fabrication technique (3D printing) to rethink an ancient building component (bricks), the Building Bytes project demonstrates how 3D printers can become portable, inexpensive brick factories for large-scale construction.

INTRODUCTION

Building Bytes is an ongoing research project looking into digitally fabricated building blocks (fig. 1). While several large-scale 3D printing projects are currently being developed, this research examines the potential of using small-scale, accessible technologies to continue the long tradition of using bricks in architectural applications. The first phase of this research was conducted during an eight-week residency at the European Ceramic Work Center (EKWC) in the Netherlands during the summer of 2012.

FABRICATION PROCESS

Bricks are an ancient building component and their fabrication has seen several innovations throughout history; however, it has consistently relied on a system of moulds or extrusions that produce the same shape hundreds, or thousands, of times. Building Bytes is an exploration of a new tool for brick fabrication: 3D printing. This technique does not rely on moulds, but rather prints each brick individually, allowing users to fabricate complex forms within which each brick can be unique.

While there are several scales and techniques of 3D printing, this project was specifically focused on desktop 3D printers that use the FDM (fused deposition modelling) technique

of printing. These machines are inexpensive and currently widely available on the market. Their relatively small printing size – approximately 20 cm (l) × 20 cm (w) × 20 cm (h) – was not considered a limitation, but rather a design parameter.

The initial challenge of the project was to reconfigure a desktop 3D printer to print with ceramics. The plastic extrusion system (print head) was replaced with a bespoke one that used air pressure, while the existing x-y-z gantry remained (fig. 2). The final printing material was derived from a slip cast recipe of earthenware ceramics, which is commonly used for casting moulds, and was stored in reusable plastic cartridges. Various recipes were tested to determine the optimal viscosity, drying time and shrinkage of the mixture.

The ceramic mixture was extruded from the plastic cartridge through a thin nozzle (print head) using air pressure. The speed of the extrusion was controlled by adjusting the pressure, which needed to be consistently maintained throughout a print. The bricks were printed with a continuous extrusion (fig. 3); material flowed from the print head without stopping and starting, following a series of vertically stacked printing paths composed of polylines (fig. 4). The goal for each polyline was to create an unbroken path that was both structurally stable and time-efficient (fig. 5). Each brick required

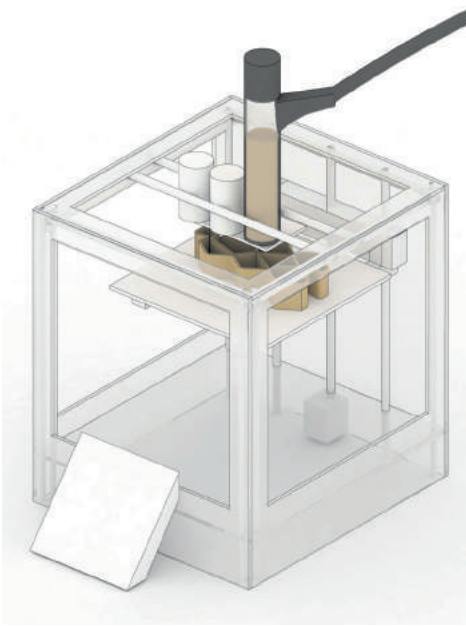

Fig. 2: Diagram of a desktop 3D printer with a custom ceramic extrusion system.

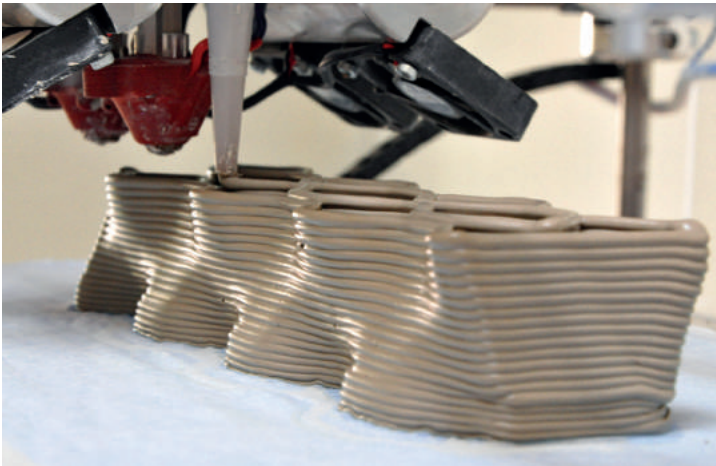

Fig. 3: 3D printing bricks with a liquid ceramic mixture on a modified desktop 3D printer.

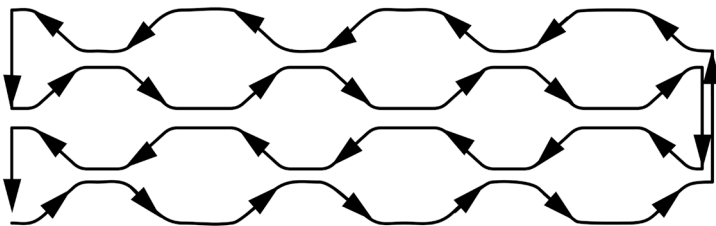

Fig. 4: Diagram of a honeycomb brick printing path.

approximately 15–20 minutes to print and after printing, the bricks were air-dried for one day (fig. 6) and then fired in a kiln at 1100 degrees Celsius for twelve hours.

PARAMETRIC DESIGN

The Building Bytes brick designs were developed using a parametric design software, Grasshopper. The initial part of the Grasshopper definition involved scripting an overall form of the application (e.g. a wall screen), by inputting the design parameters of the desired structure. This form was then subdivided into modules (bricks) that could be fabricated by the 3D printer. Each brick within the larger structure had its own set of parameters that could be adjusted, such as the exterior skin, interior skin, internal structure, and interlocking joint detail. Additional information for each brick was also embedded into the digital model, such as the material cost, printing time, and

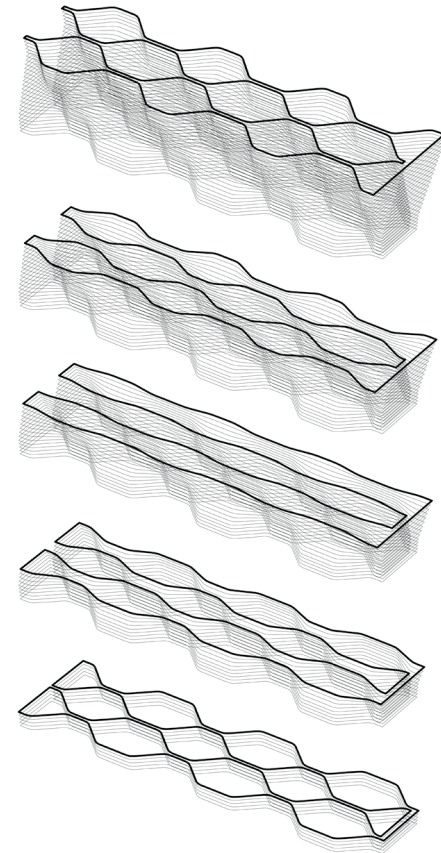

Fig. 5: Diagram of various printing paths that comprise the honeycomb brick.

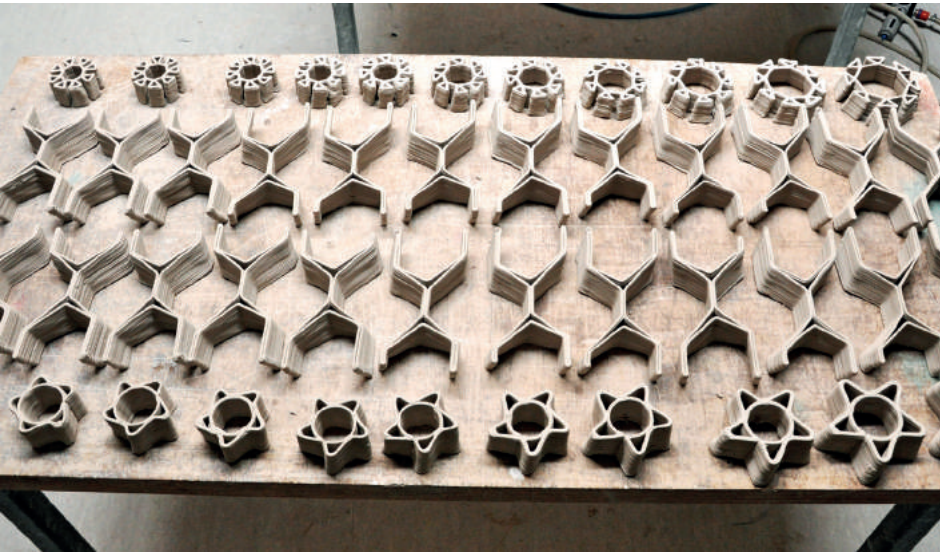

Fig. 6: Air drying bricks prior to kiln firing.

a labelling system for the full-scale assembly. When the overall form was changed, the individual bricks were automatically updated, creating a design system that could quickly adapt to varying scales, sites and applications.

The final part of the Grasshopper definition was a custom script that translated the desired 3D model into g-code. G-code is the programming language that is read by 3D printers, communicating the relevant x, y, and z points and the speed to travel between those points. As a result, a master Grasshopper script included all the information needed for a brick, from the design and structural data to the fabrication code and a simulation of the printing process. This minimised the time spent redesigning and modifying the bricks based on the fabrication system and physical tests.

PROTOTYPING

Creating a direct link between the digital models and physical tests was essential for this project, since the printing process, in combination with the material, was highly experimental. Optimal fabrication standards could only be determined through several physical prototypes. The following factors were examined: extrusion (flow of material), speed of printing, material viscosity, material slump, amount of layer overhang, stability during printing, and layer height. Three of these factors are discussed below.

First, since the material used in the prototypes was very viscous and unstable, the bricks had to be designed to support

themselves during the printing process; otherwise, they would collapse and fail (fig. 7). This steered the design towards intricate interior patterns (see 'Honeycomb Bricks') and undulating exterior skin patterns (see 'Ribbed Bricks'). Second, since a secondary support material was not used, the amount of vertical overhang from one layer to the next was limited. A series of tests determined the maximum angle of overhang per layer to be around ten degrees, and that information was embedded into the parametric model as a design parameter. Finally, the height between printing layers, in particular, had an effect on the fabrication process. For example, thinner layers led to longer print times with less visible contours (texture), while increasing the layer height reduced the print time and increased the visible contours. Every factor influenced the others, creating a dynamic prototyping process that ultimately informed the design of the bricks.

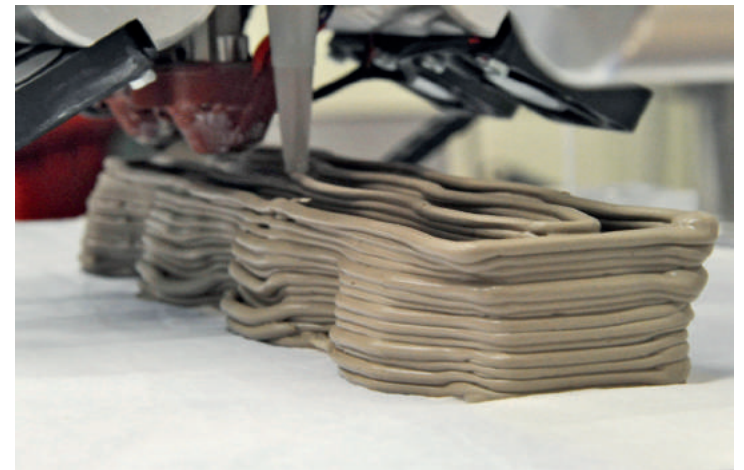

Fig. 7: Printing early honeycomb brick prototype.

BRICK DESIGN

Building Bytes highlights new opportunities for ingenious and adapted brick designs. For example, bricks can be designed with interlocking joints and different three-dimensional profiles on each façade. Building Bytes also offer the possibility of incorporating necessary electrical or mechanical infrastructure within a brick or engineering each brick's strength to correlate with its placement within a wall.

Four brick types were designed to test and demonstrate the design potential of this fabrication system and its applications in interior and exterior architecture. Along with full-scale prototypes of a single brick and stacked aggregations of 15–30 bricks, scale models of potential final applications were produced to visualise and communicate the design intent.

HONEYCOMB BRICKS (figs. 8–10)

Honeycomb bricks are modular and can be stacked in three different orientations, allowing flexibility. They are also very stable during the printing process and in the final application, due to their intricate interior structure. The potential applications for this type of brick include interior and exterior privacy or sunscreen walls.



Fig. 8: Honeycomb brick: prototype.

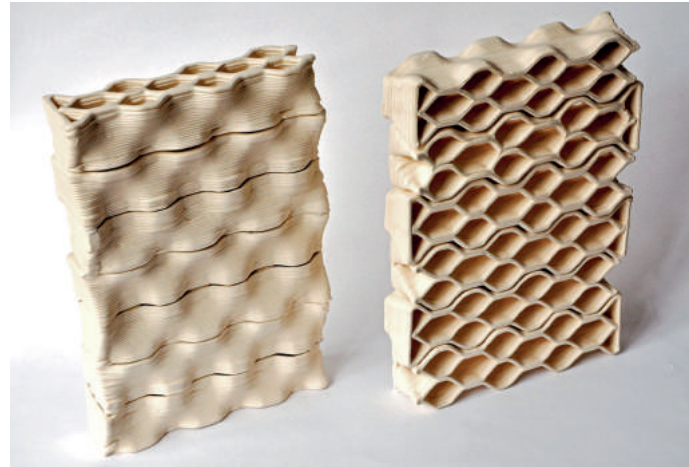

Fig. 9: Honeycomb brick: scale model of screen wall application.

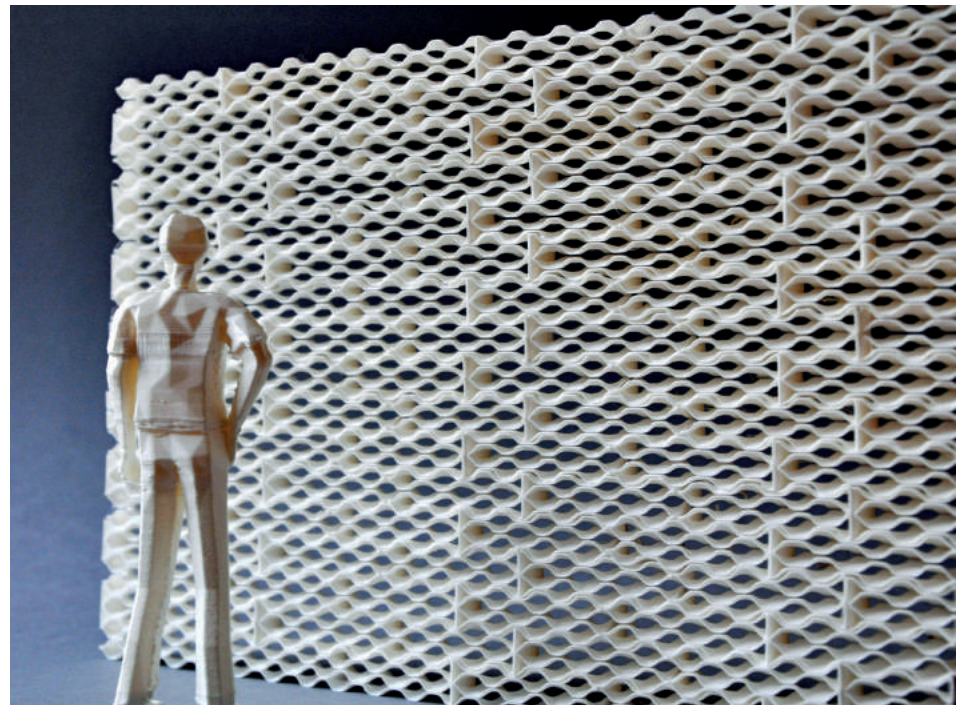

Fig. 10: Honeycomb brick: full-scale wall prototypes.

INTERLOCKING BRICKS (fig. 11)

These prototypes are an exploration into the use of interlocking brick joints in wall structures. The interior bracing provides stability, while the exterior can expose the structure (as in the prototype) or be clad in another texture (which is integral to the brick design).

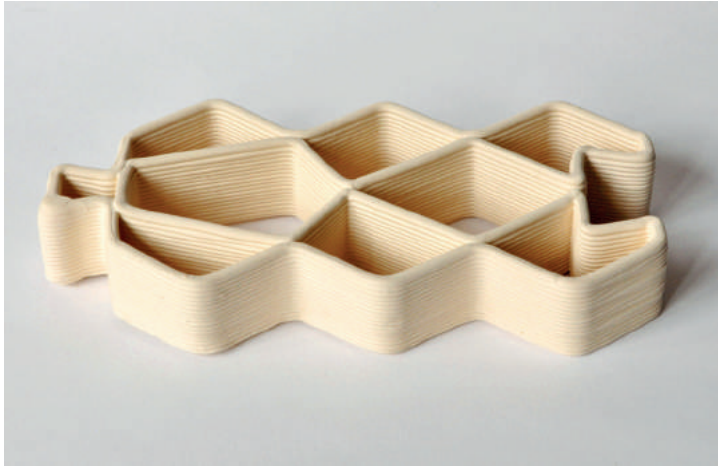

Fig. 11: Interlocking brick: prototype.

RIBBED BRICKS (fig. 12)

Designed for column applications, ribbed bricks have a distinct outer surface that is both structural and ornamental. The material stability while printing drives the unique outline, which can be designed any number of ways with no increase in fabrication complexity. Each brick in the column prototypes is unique, allowing for a twisting, narrowing profile.

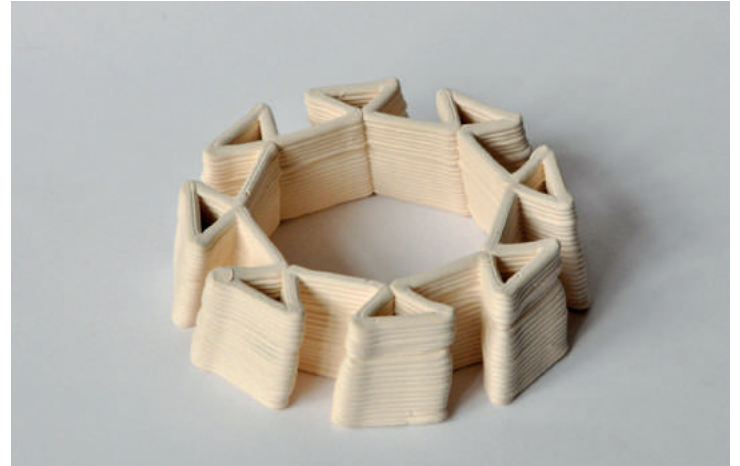

Fig. 12: Ribbed brick: prototype.

X-BRICK (fig. 13)

This brick type was designed to maximise visual opacity through walls, optimise printing time, limit material use and test non-modular constructions. The X-brick prototype structure creates an undulating surface by using unique bricks per row.

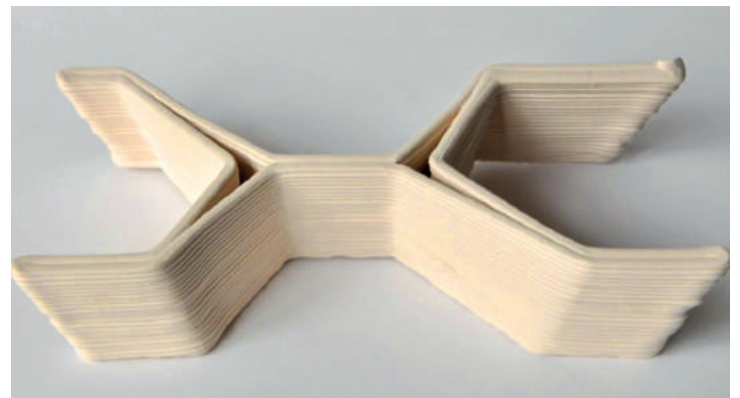

Fig. 13: X-brick: prototype.

ONGOING RESEARCH

Building Bytes is an ongoing project and there are several current lines of research, which include: testing new materials, investigating structural integrity, improving the fabrication system, developing new joints and connection details between bricks, and exploring other design applications.

Material research is focused on two avenues. First, traditional materials, such as ceramics and concrete, because it is beneficial that local builders have familiarity with their properties. Second, alternative materials (experiments with sand and adobe are being carried out), as this could lead to the development of a system that uses on-site materials in construction.

For the system to become a viable fabrication tool, innovations in the printing process are being developed. First, the capacity of the material storage system will be increased, whether from a continuously fed system or enlarged material containers. Second, investigations into increasing the printing speed are being carried out for greater efficiency. And finally, a process needs to be developed to reliably test the structural integrity of the bricks, to better understand the performance characteristics of designs, porocities and materials.

The intent is to test these lines of research through the construction of a full-scale structure. This will not only explore construction necessities, such as mortar application, but also highlight the potential of this new fabrication tool in small-scale architecture.

CONCLUSIONS

The Building Bytes research has created a functioning and reliable brick fabrication system from a standard desktop 3D printer. Initial experiments and prototypes began exploring the design implications and opportunities for the profession, with the hope of demonstrating that 3D printing has the potential to influence future architectural applications.

The research also hopes to raise important questions for the design and construction industry, such as:

- 1) What applications will benefit from custom designed and printed bricks?
- 2) What material systems can now be considered for building?
- 3) How can this fabrication technique be engineered to consistently produce structurally sound bricks?

In conclusion, Building Bytes envisions a future building site where local designers and builders are fabricating bricks on site using a series of easily-accessible desktop 3D printers with local materials.



Fig. 14: Honeycomb brick: detail.

Fig.1: Mobile Orchard. View of animated lights encircling tree at night, Finsbury Avenue Square.



THE MOBILE ORCHARD: GROWING ERGONOMIC, EDIBLE, AERIAL DATASCAPES

ALEX HAW (ATMOS)

The Mobile Orchard is an inhabitable public art installation by the art/architecture practice *atmos*, commissioned as the centrepiece for the City of London Festival 2013 to highlight the decline in British orchards. The digitally-cut, laminated-timber structure celebrates the urban fruit tree, welcoming visitors to a varied landscape of occupiable spaces arrayed around a sculptural central spine. It utilised a sophisticated parametric design model to control a complex range of inputs and systematically feed thousands of individual components to the CNC router, and onwards to assembly. This text explores the project's genesis and illuminates some intricacies of the multilayered fabrication and installation process.

THE UNWITTING ARCHITECT

'The best friend on earth of man,' wrote Frank Lloyd Wright, 'is the tree. When we use the tree respectfully and economically, we have one of the greatest resources on the earth.' Yet the tree, provider of that most ubiquitous and economic of building materials, is also the contemporary architect's arch-enemy: effortlessly graceful in its stretch from soil to sky; humiliatingly all-encompassing in its integration of form and function; unsurpassed in its economy of means, unparalleled in its management of budgets; defiant and exuberant in its unstoppable, muscular, florid will to form.

Trees' structural diagrams are of such extraordinary (and elusive) efficiency that they alchemise timber into steel, even in apparent defiance of logical loading routes. Their branches wriggle outwards in unrestrained creativity, yet still sate the most exacting of briefs. Their leaves maximise surface area with the most minimal of means. Their welcoming roots (think Newton's cradle) have changed the very course of scientific history – and engulfed world monuments: think Cambodian figs at Tra Prohm. Their environmental collaboration with symbiotic 'tenants', their fertilisation by local hand-maiden fauna, and their reliance on hidden soil fungi, all taunt individualist humanity with a future-thinking model of ecological cooperation.

ARBOREAL ALMANACS OF DESIGN

It was a gardening journalist, Walter B. Hayward, writing for the *New York Evening Post* in 1913, who preceded Frank Lloyd Wright's famous other quote on trees, and said on the saving grace of vines: 'Some day the American Institute of Architects will get together and vote a solid gold medal, *summa cum laude*, to the man who invented vines; for it was he who made the architect's profession safe.' Planners and urbanists seem all to agree: trees heal the wounds inflicted by buildings, softening their sharp corners, foliating the flatness of their inarticulate façades.

In an age of algorithms and emergent digital design, the complex growth patterns of nature's closest thing to architecture, whilst also its most radical engineer and its most inventive geometer, demand investigation and sincere attempts at flattering imitation, offering, as they do, deep lessons in a wide array of architectural issues, spanning culture and technology.

BUILDING A TREE

The City of London Festival is an annual event that activates the hidden spaces of the corporate capital with cultural content. It also increasingly pursues an environmental agenda that promotes biodiversity within the crystalline caverns of the city's architecture.

In 2013, the city commissioned *atmos* to design a 'Mobile Orchard', which would thematically explore the role of trees in the city, the decline of British orchards, and the disappearance of the urban fruit tree (fig. 2). Like a wind-borne seedling, the Mobile Orchard was to travel to five separate locations within London's Square Mile, introducing tight logistical requirements for rapid breakdown, transport and reassembly.

DESIGN SEEDS

In the face of countless sculptural imitations of nature, *atmos*'s core design principle was to engineer an inhabitable tree, tailored to the ergonomics of intrepid users, a structure that would welcome and embrace, encouraging exploration and relaxation, cross-fertilising nature and architecture in ways every bit as artificial as their urban-tree referent; splicing, grafting, pruning and re-engineering raw matter to construct a labyrinth of branches that would indiscernibly double as steps leading to a constellation of aerial seats and sky-thrones.

Early designs investigated the use of thin stainless steel sheet, V-folded along curved lines using developable surfaces, creating long filigree spans with minimal use of material while emphasising a crystalline artificiality that reflected the local architectural palette and the engineering prowess of trees themselves.



Fig. 2: View of Mobile Orchard amidst fruit trees at the Gherkin building in London.



Fig. 3: Close-up of the tree's grain at the intersection of trunk segments. (Photo: Jonathan Perugia / jp foto.)

ARTIFICIAL GRAIN

Budgetary and comfort issues governed a switch to the flesh of trees themselves, and a design that developed its own form of timber grain – ironmongery its only recourse to steel. The tree's emphatically horizontal (and thus accessible) limbs were to offer and bear the hardest and most sturdily-packaged of fruits, apples,¹ that a wary public were likely to feel comfortable to pick and eat, and one they would most readily symbolically associate with a British orchard.²

Fabrication negotiations led to a design layering 4 mm slices of glued Latvian birch plywood, chosen for its economy, strength and durability. This lamination of laminations created a rigorously parallel series of stripes and striations that fortuitously recalled the 'straight, fine, uniform texture' of vernacular apple and cherry hardwoods. The differentially-torqued bolting technique,³ required to further bind the plywood sheaves, counteract shear, and resist splitting or overturning as they deviated from their centreline, similarly mimicked the way hardwood 'pulls' leaning stems into alignment through the development of 'tension wood' (fig. 3).⁴

ECCENTRIC SPIRALS

The core design centred on a trunk that leaned and cranked and bent and spiralled, and generally twisted as far as engineering constraints would allow such a structure with a deeply eccentric centre of gravity, a vulnerability to sudden gusts of fierce wind at the base of its host towers, and the challenge of mobile live loads tracing their aerial paths across its aerial branches. The trunk had 12 trunk segments of 30 degrees (their edges thus simply machined by a 15-degree CNC bit) (fig. 4) bundled against an asymmetrically-spiralling series of diminishing ellipsoidal compression tree-rings, to which they were tensioned and glued. Like trees in general, it had a severely limited budget, and thus deployed the minimum material needed, arraying slices of only 50 mm width into the shallowest shell possible thus encasing a central void which could be visually surveyed by those that leant across its base and dipped their head into a hole that exploited a pocket of local structural redundancy.

The structure originally had, like most trees, a generous fanning array of undulating, elongated roots⁵ that multi-tasked as welcoming street-furniture and buttressing supports. When budgetary constraints amputated their extensions, the base of the trunk was forced to evolve into a separately bolted void (fig. 6) that could incorporate over 1.5 tonnes of ballast, which

Fig. 4: Separated trunk-slice segments awaiting tethering together.



Fig. 5: Assembled, denuded trunk core being lifted for transport to first site.



Fig. 6: View past lowest tree ring into the void of the trunk base, without ballast.

had to be removed for transport. The tree ultimately relied upon a sole central 'shadow' root for its stability – a mutant echo of the real-world adventitious stilt, knee or buttress roots that more typically intermesh to form a rigid support for the structure above.⁶



Fig. 7: Rows of assembled branch slices awaiting tensioning into trunk slots.



Fig. 8: Close-up of 'London Leaves' laser-cut in the shape of boroughs.

PARAMETRIC THICKET

The trunk's complex spiralling geometry governed each segment's capacity to generate branches, each extension fighting both for limited local purchase and fluid incorporation in the global constraints of optimised stair paths and head-height enclosures. Each branch needed to be removable for transport (fig. 7), and so its structural connection back to the trunk was reduced to the simplest possible essence: a protruding resin-anchored threaded rod traversing the trunk void, which was then wound tight against the shell opposite, its highly-torqued nut then concealed by the overlay of an LED strip.

The junction between trunk and branch entailed a two-fold flaring-plane socket detail that ensured the branch could be socketed against the meat of the inner rather than outer trunk, the angled tolerance of its outer taper allowing for the timber's expansion and contraction from heat and humidity. The fading array of bolts along each limb assured its life, much like the punctuation of bark's gas-exchanging lenticels. The branches wound outwards and upwards and bifurcated, spliced with lighter laser-cut slices of S-shaped aluminium (strengthened using curved folding), referencing both arbo-real uses of folded strengthening, and the binary materiality of bark and core.

LONDON LEAVES

The canopy, like trees themselves, was subject to a strict budgetary constraint, thus developing a leaf design that doubled shading with information (that great unifier of natural and financial systems), each leaf outlined a local London borough, each shape thus perfectly tiling without waste onto laser-cut sheets, maximising material surface spread whilst providing visitors with local cultural reference (fig. 8).

Its phyllotaxy hybridised common fruit-tree leaf types, alternating distichous⁷ with verticillate,⁸ since spiral arrangements became impossible along the enforcedly two-dimensional axis of the secondary branches. The petiole (or stalk) expanded each borough boundary into a meaningfully-wriggly line that balanced maximum extension (thus avoiding auto-shading) with minimum viable strength; a single, central, vein-like fold on each, hand-pinned in seconds, and thus afforded further structural stability.

The collection of borough outlines, varying widely in geographic area, reflected the variance in leaflet blade size of many compound leaf types, with each 'London Leaf' lamina also varying widely in appearance, from ovate to semi-elliptical, orbicular to perfoliate.⁹



Fig. 9: Various visualisations from the evolution of the Grasshopper model. (Renderings by *atmos.*)

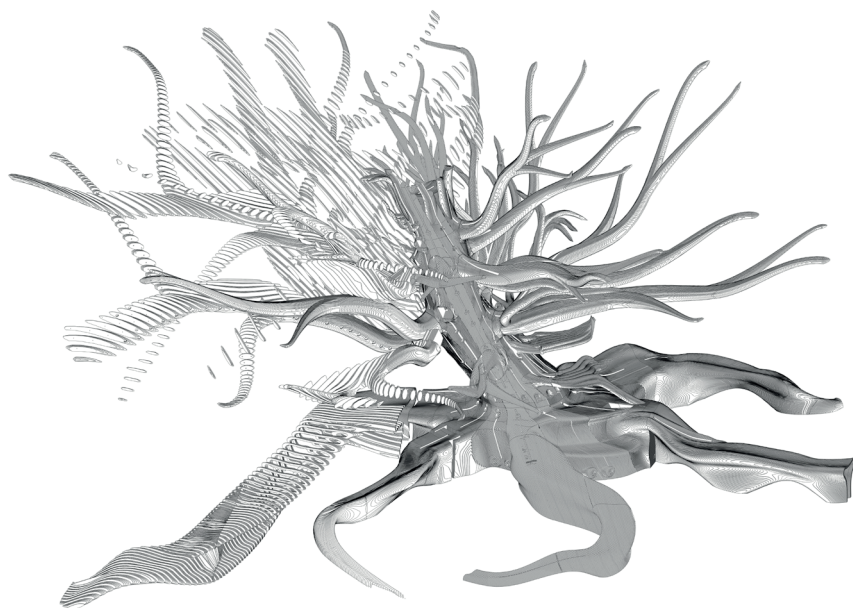

Fig. 10: Exploded isometric showing atomised branch segments at the rear. (Drawing by *atmos.*)

SCRIPTING NATURE

The design process was developed almost entirely using Grasshopper and RhinoscriptVB (fig. 9), where an ever-expanding ecology of interdependent tools were built that simulated the artificial growth of trees at a range of scales. The scripts enabled the management, automation, rationalisation, subdivision, contouring, slicing, separation, numbering and preparation of parts into geometries that could be categorised, separated, routed, assembled and physically realised (fig. 10). The system steadily aggregated enormous levels of unprecedented complexity, constantly informed by engineering, ergonomic, economic, fabrication and logistical inputs and iterations.¹⁰

The network of forking branches required iterative geometrical testing to seek maximum spread with minimum ingredients whilst incorporating randomised switches of direction, with varying intensities of 3D curvature and bifurcation, each toggled to optimise local coverage (fig. 11). Planometric deviation was limited by structural capacity, whilst sectional genesis was governed by ergonomics, secondary-branch geometries and tertiary foliation. An extensive array of drivers and constraints thus generated a deeply rigorous relationship between root and trunk, branch and leaf, all centring on a single, all-inclusive parametric definition.



Fig. 11: View of seat-cradling branches winding towards the Gherkin's lattice.

LUMINOUS XYLEM

Trees generally appear to be the epitome of static nature, monumental and immutable – yet internally, they bristle with electricity; they can trigger startlingly rapid movements through nerve-like electrical impulses. The physiologist John Burdon-Sanderson first noted botanical electrical signals in 1873 whilst studying Venus flytraps,¹¹ and science has since documented (with notable recent upsurge) the pantheon of sensitivities of various forms of plant life, including swift signal response and transduction.¹²

The limited gestation period of the Mobile Orchard forbade development of sophisticated tactile thigmonasty,¹³ though it incorporated a DMX-programmed version of photonasty; its bark echoing the surrounding public clocks by responding to the fluctuation of light across the day. Long 16-mm wide strips of linear LEDs, IP-encapsulated in sap-like silicone, excavated a perfect quartet of plywood slices (fig. 12), their linearity emphasising the bundled fibrosity underlying all trees, their segments illuminating in accelerating chronological sequence, rotating in a slow crescendo that climaxed with a cataclysmic hourly chime. The tree's dead matter was thus enlivened with live data, just as trees coalesce living and sloughed-off matter.¹⁴ The continuous presence of light – the phototroph's¹⁵ core fuel – alluded to the city's own unceasing nocturnal rhythms, and its factory of productivity, whatever the hour (fig. 1).



Fig. 12: Detail of integration of luminous LED strips within grain of trunk base.

FABRICATION PROCESS

The manufacturing hybridised a range of subtractive technologies (3D-axis CNC routing with water jetting and laser cutting), working with one of the only CNC operators in London that also operates as a fabricator and contractor. The initial design specified 18-mm plywood sheet, ubiquitous and by far the most economic per weight, monolithically CNC-contoured in 3-mm steps, but prototyping revealed that the necessary flipping and undercutting required for rounded three-dimensionality catastrophically undermined the vacuum suction of the machine bed, prompting the switch to thinner slices cut rapidly from a single side only. The project's virtual geometries necessitated close collaboration and feedback between designer and fabricator, particularly in the refinement of CNC cutting protocols.

And yet, as with so many digital works, the presence of the human hand was far from expunged. With assembly of the slices impossible to automate, the process relied heavily on a host of volunteers (mostly unemployed southern European designers, the recession thus unwittingly funding the project) and thus the design of a tight informational system and managerial sequencing of tasks. The assembly process also revealed a wider truth about complex arboreal (and perhaps all) structures and their reliance upon broad collaboration between multiple agents. It recalled the astonishing inter-species alliances that occur under the ground, where fields of entirely separate roots agree to interlock and enmesh, and share resources.¹⁶

KEY PROJECT DATA

WEB PAGES

Project Website (due updating):

<http://www.mobileorchard.info/>

atmos webpage on the project:

<http://www.atmosstudio.com/Mobile-Orchard>

atmos collection of videos on the project (due updating):

http://www.youtube.com/playlist?list=PLz6LhwhDR5pEGN_inDNuh3m4cxP4rEQPC&feature=mh_lolz

TIMELINE

Design Commission: February 2013

Fabrication: June 2013

Installation: 24 June–27 July 2013

SITES (all City of London, Financial District, UK):

24 June: Paternoster Square

1 July: Devonshire Square

8 July: St Mary Axe

15 July: New Street Square
22 July: Finsbury Avenue Square
Map: <http://goo.gl/maps/yulzc>

MATERIALS

600 8×4' sheets of 4 mm Latvian birch plywood
300 1250×2500 mm sheets of 'Priplak' polypropylene (for leaves)
3 8×4' sheets of 1.2 mm aluminium (for secondary curved-folded branches)
22 3W IP65 LED micro-spotlights (Wibre)
90 m of 12 W/m IP65-rated LED strips (LEDLinear)
160 hours of CNC time

CREDITS

DESIGN: atmos: Alex Haw, Jeg Dudley, Natalie Chelliah, Xiaolin Gu, Maite Parisot, Juan Carlos Bueno, Adamantia (Mando) Keki, Miriam Fernandez

STRUCTURAL ENGINEERING: Blue Engineering

LIGHTING DESIGN: Arup

LIGHTING SPONSOR: Architectural FX / LEDLinear / Wibre

PLYWOOD SPONSOR: DHH Timber

FABRICATION: Nicholas Alexander + volunteers

LOGISTICS: Tellings Transport

CLIENT: City of London Festival

FESTIVAL TREE SPONSOR: Bloomberg

FUNDING PARTNER: Arts Council England

REAL ORCHARD TREES: YouGarden + The Worshipful Company of Fruiterers

MICROSITE WEB DESIGN: 8-fold

HOSTS: Broadgate Estates, Devonshire Square Management, Land Securities, 30 St Mary Axe Management Company Ltd (The Gherkin)

NOTES

1 Even if they were out of season in the United Kingdom, a fact that ruined early plans for gleaning and freeganism; further pages than available here would be required to expand on the ecological acceptability of pan-national, cross-seasonal fruit transport.

2 'The British eat 50 billion apples each year' (BBC, 'British to the Core', Weds 14 Nov 2012, <http://www.bbc.co.uk/programmes/b011wz53>, accessed Wed 18 Sept 2013, and Britain played a key technological role in the plant's modern cultivation, e.g. 'The majority of the rootstocks used today to control size in apples were developed in England in the early 1900s'; <http://en.wikipedia.org/wiki/Apple>, accessed Thurs 19 Sept 2013.

3 Ranging from just 2 Nm at 50 mm-diameter limbs, to 32 Nm at 200 mm diameter.

4 Peter Thomas, *Trees: Their Natural History* (Cambridge: Cambridge University Press, 2000), p. 69; note that conifers do the opposite, 'pushing' their limbs into alignment.

5 Most underground tree roots extend far beyond (up to three times) the spread of their companion canopy above, yet occupy an extremely shallow pocket of soil; Thomas 2000, p. 72.

6 Thomas 2000 (see note 4), p. 106.

7 The arrangement of a single leaf at each node.

8 Bob Watson, *Trees: Their Use, Management, Cultivation and Biology* (Marlborough: The Crowood Press, 2013), p. 54. Multiple leaves at each node.

9 Thomas 2000 (see note 4), p. 30. Note that even homogeneous single-species leaf arrays embed diversity: 'leaves act as independent units, similar to a block of apartments'.

10 Some of the variables controlled by the extensive master parametric model include: programmatic constraints like lowest branch heights; step heights and positions, and position of crown seat; position of connection points between trunk base and trunk above; height; width, segmentation, twist and taper of trunk, including extent of deviation from pure spiral; thickness, number, position and depth of trunk tension rings; depth-to-cantilever ratios of branches, along with their deviation in plan and section, and location of their inflection points; depth, width and taper of their plugs in relation to trunk sockets, and the corresponding position and size of tension bolt holes and washer recesses opposite; adaptive bolt spacing and nut recessing, and intermediary location of recessed micro-spotlights and linear strip channels; and fabrication constraints including slice thickness, part labelling, part size and layering, and orientation, arraying and positioning of final pieces for CNC-cutting.

11 Research that would be continued in his Department of Medicine at University College London, with the first publication nine years later in the *Philosophical Transactions* titled 'The Electromotive Properties of the Leaf of *Dionæa* in the Excited and Unexcited States' (1892); J. Brian Ford, *How Animals and Plants Feel and Communicate* (New York: Fromm International, 1999), p. 191.

12 See, for instance, *The Journal of Plant Signaling & Behavior* (František Baluška, Stefano Mancuso, Tony Trewavas, Dieter Volkmann, eds.).

13 Thigmonasty means movement in response to touch or vibration.

14 Watson 2013 (see note 8): 'a combination of green primary growth and bark-covered, woody, secondary growth' (p. 137).

15 An organism enacting photosynthesis (also known as *photoautotroph*).

16 Thomas 2000 (see note 4), p. 94. 'In a mixed hardwood forest, it is possible to get the roots of 4–7 trees below the same square metre of soil surface.'

Fig.1: Weathering of outdoor installation of Study in Spin-Valence.

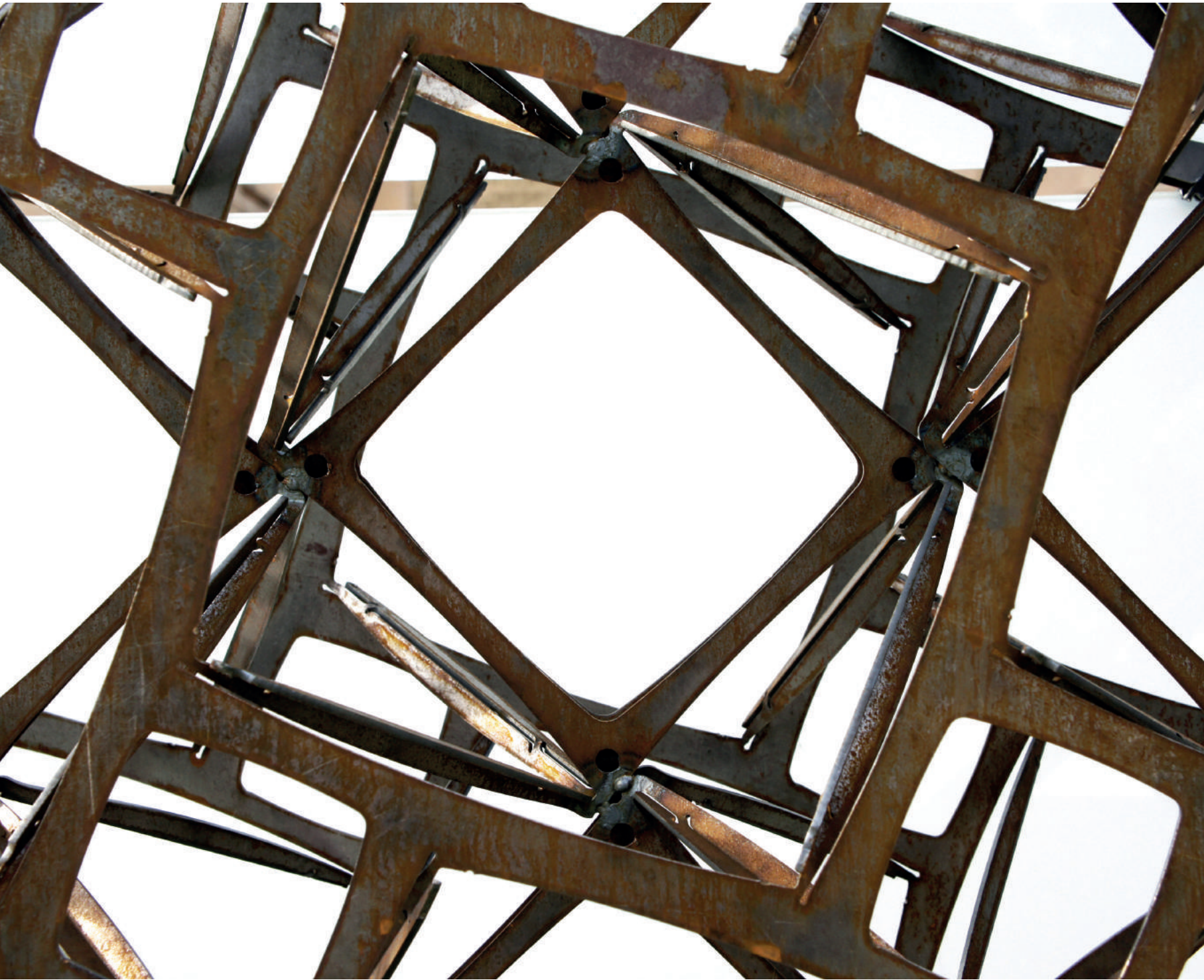

SEARCH FOR A ROOTED AESTHETIC: STUDY IN SPIN-VALENCE

EMILY BAKER (AMERICAN UNIVERSITY OF SHARJAH, UNITED ARAB EMIRATES)

The evolutionary development of the fabrication pattern-logic Spin-Valence serves as an example of the potential for discovering a 'rooted aesthetic', or one in which the appearance of a constructed system is intrinsic to the way that it functions. Spin-Valence employs the cut line as the tool in the formation of a structurally effective space frame through rotational bending of interacting units out of a flat sheet of steel. The description of its process of development also posits a tactic for reinvesting the intuitive and improvisational hand of the architect.

Spin-Valence is a fabrication pattern-logic that was the culmination of a year of research and experimentation while completing a course of graduate study in architecture at Cranbrook Academy of Art in Bloomfield Hills, Michigan. The goals of this work, and the larger investigation of which it is a part, lie in the search for architectonic expressions that arise out of methods of fabrication and attaining structure. Many of the historically meaningful architectonic expressions have at their core issues of construction and structure. Thus, this work seeks to establish what can be termed a 'rooted aesthetic', or one in which the appearance of the system is intrinsic to the way that it functions, much like the evolution of biological forms, wherein the beauty of the organism arises out of its being tuned to a specific environment and set of biological needs.

In order to embark on this search, the designer suppressed the influence of appearance on the development of the system in favour of its functional goals. Each choice to evolve the work was made based on structural capacity and in service to constructability, disregarding any formal biases and allowing a new aesthetic to emerge unadulterated from this evolutionary process, the results of which could not have been preconceived.

PROCESS

The development of Spin-Valence began by exploring the use of digitally cut sheet steel to produce a system that could be self-structuring, scalable and easily constructed. Much of steel fabrication is the amalgamation of standardised steel shapes. However, as demonstrated in this work, the reimagining of ubiquitous steel systems via new technologies can present novel architectural possibilities and advance our understanding of fabrication and construction. Instead of choosing a structural system to emulate, the field of possibilities was at first left open, and the idea of cutting and bending the sheet from the flat plane into a self-supporting form was initially explored in paper. A few paper iterations yielded a kind of pattern-logic that utilises rotational bending to create structural integrity through triangulation. Further study revealed that this logic is also translatable into any regular polygonal shape (fig. 2).

The square version of the pattern was selected as the initial site of investigation. Aggregation of the resultant structural units yielded various self-supporting forms depending on the relationship between discrete units. These units, like atoms in molecules, began to produce predictable form-generating combinations and behave based on their chirality, or

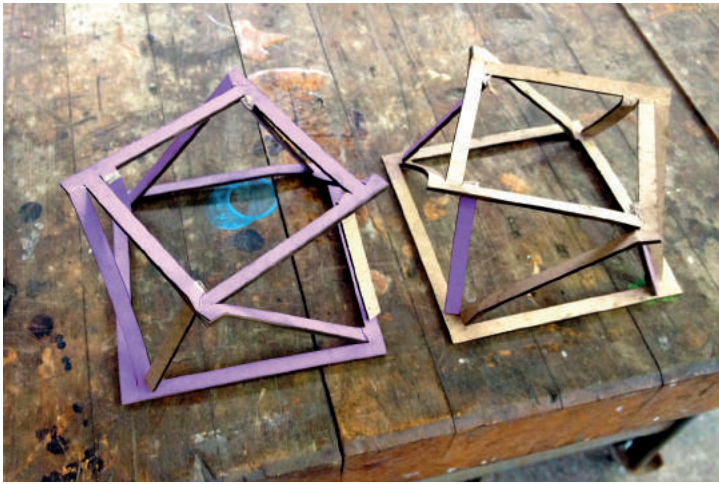

Fig. 2: Paper-based structural 'toy' that served to inform subsequent full-scale prototypes.

handedness. Many aggregation strategies came out of the playful recombination of these paper units. This development of an easily manipulable paper-based structural 'toy' served to inform subsequent full-scale prototypes. The enabling of play, and thus a kind of useful ambivalence,¹ through the physicality of the prototypes was key to the progression of this evolutionary process (fig. 3).

With demonstrated potential in this pattern-logic, the process of translating the pattern, and thus the structural unit, from paper into a larger scale steel version began. Some revisions were made to the cut pattern before the first steel unit was produced in order to maintain stability with the increase in scale. The obvious weaknesses of this first steel prototype precipitated many revisions to the original steel cut pattern. For instance, each leg of the structural unit was given a curved shape that both created a precise amount of necessary weakness at the intended bend point and also increased the amount of steel in the leg where it was likely to buckle. Additionally, each leg was perforated to accommodate one bend along its length for further stiffening. This second iteration of the pattern yielded a much more stable and production-friendly steel unit (fig. 4). Further refinements were made in order to reduce the cut pattern to the least amount of lines possible, thus reducing cut time and wear on equipment (each discrete line meant a new striking of the arc of the plasma cutting tip, producing wear), and also to tune bend points and leg lengths for optimised stability, strength and ease of production.

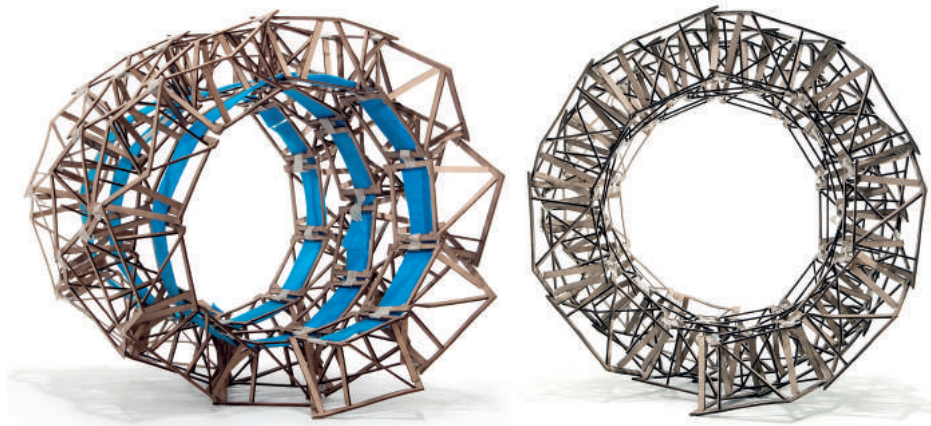
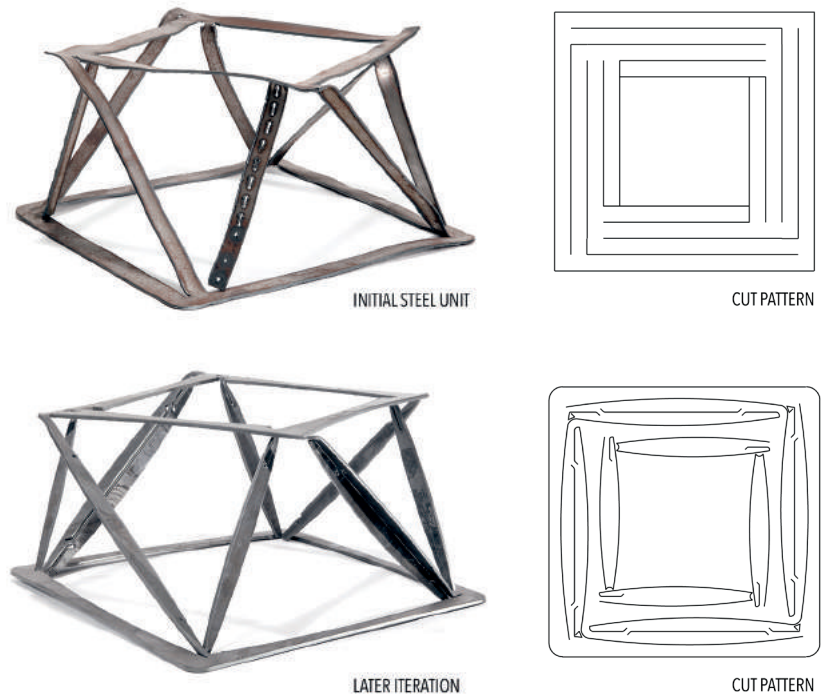

Fig. 3: Aggregation models of paper-based structural 'toy'. (Photo: P.D. Rearick.)

Fig. 4: Top: The first steel unit prototype utilised the same pattern as the paper units. Expanding this pattern in steel highlighted the need for programmed points of weakness within the pattern to facilitate bending. Below: Facilitating bend points drove the revision to the curved shape of the legs, which simultaneously served to allow a stiffening fold down the length of each leg. Inner legs were shaped so as to stabilise their connection points at the base. This pattern minimized the number of cut lines to thirteen, reducing wear on equipment and cut time. Note the eight triangulated legs of the independently structured unit, later reduced to four within the Spin-Valence pattern-logic. (Photo: P.D. Rearick.)



As seen in the above referenced images, these four-sided units employed eight legs for structural triangulation – four outer legs and four emanating from the unit’s centre. Examining aggregation models revealed that the units could be placed in rotational proximity to each other such that triangulation would occur *between* units instead of within each unit individually, rendering four of the eight legs in each unit vestigial (fig.8). The ensuing investigation of a pattern-logic in which the relationship of multiple structural units cut on the same sheet of material produced structural bonds, or valences, resulted in the scalable pattern system that characterises Spin-Valence.² A sheet employing Spin-Valence, when expanded, effectively forms a space frame, or two parallel planes joined continuously by triangulated arms.



Fig. 5: Prototype in steel exhibiting structural capacity and light transmission. (Photo: D. Skidmore.)

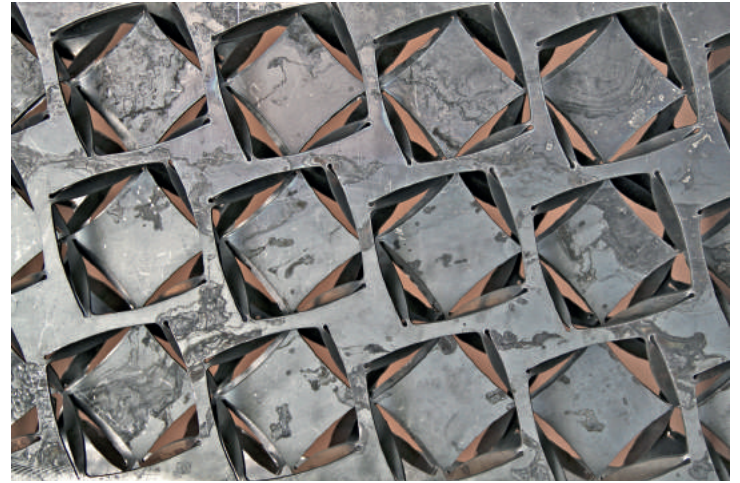

Fig. 6: Prototype in steel.

INSTALLATION

Spin-Valence emerged from the amalgamation of non-aesthetic decisions and refinements in service to structural goals and ease of fabrication. As the number of prototype iterations grew, it became clear that the rooted aesthetic that had been the goal of the endeavour was emerging. In order to further understand the potential of the system on a functional level and to study its aesthetic potential, an installation was planned and exhibited on the grounds of Cranbrook Art Museum.

The primary component of the installation was a wall, approximately 2.2 m by 5.5 m (7 ft 8 in. high and 18 ft. long), which separated at one end to create an occupiable space. The ‘floor’ of this space employed Spin-Valence at a smaller scale than the wall, allowing visitors to experience how the system could support their weight. The entire pavilion was elevated on custom steel components that translated loads to small screw piles.

One of the potential capacities of the system that was revealed during its development was that it might, with the addition of a sealable skin, become a building enclosure as well as a structure. The installation began to probe the experiential qualities of that idea with the incorporation of eight translucent glass panels. The panels were hung on the wall at eye level with clips that were developed, along with many other necessary elements of installation, in the same immediate and improvisational way that the system itself was developed, thus they were tuned to work within the pattern-logic of the wall.

The three-dimensional pattern produced by Spin-Valence in combination with the shifting daylight and movement of

people produced an amazingly dynamic and alluring surface. The installation begged the closer inspection of passers-by, who were drawn to consider how the system worked – to touch it, to observe the shifting shadows.

LINE IS TOOL

Within this cut-and-bend system, the tool for the formation of the work is not only embedded in, but actually is the cut line. The line is the tool. Thus, a new tool is being created or refined with every line drawn. Each point of weakness to allow bending and strength to resist buckling – each length, spacing and rotation – has been choreographed and calibrated through iterative testing. Within this type of system, the act of drawing is not only the description of geometry, but the very creation of the tools that will provide a construction logic and imbue the material with structural capacity, as well as aperture, shading, and shadow play.

The system is efficient in that the connections between the units are not additive, but pre-existing in the raw material. A perceived complex arrangement of parts is actually a single piece. It is strong enough to support itself along with a significant load, yet literally and visually light. It holds shadow and light in the vertical plane, and its patterns shift dramatically and dynamically with light changes and the position of the viewer.

REINVESTING THE INTUITIVE HAND

The resulting pattern-logic was one that could not have been derived solely by the capabilities of the designer through computational modelling. The feedback loop within this evolutionary process between drawing and resulting artefact re-

lied heavily on the enabling of an intuitive and improvisational hand. Complete access to the means of production, a three-axis CNC plasma cutter, enabled the very immediate translation of drawn line to cut line, acting to invest the hand of the designer to work with sheet steel in a way previously inaccessible. The elimination of layers of influence between designer and artefact resulted in an intuitive, improvisational, immediate and iterative workflow.

This work situates itself as a possible, or even necessary, precursor to the pairing of digital fabrication and advanced computation in that it gleans invaluable strategies and embedded knowledge through intuitive, improvisational investigation that precedes the application of computation. There are many lessons to be learned at this level of engagement that could bring important insight and depth to subsequent iterations that do make use of digital abstraction and computation. The system is stronger, not weaker, because it was not initially computationally derived. A system thus calibrated to the hand and material properties might then readily be computationally augmented or employed.

CONCLUSIONS

Spin-Valence resulted from investigations rooted in the reality and physicality of material construction. Because discovery was preferred over forced authorship, there was no prescribed end, only a fossil record of constructed objects leading towards building components that maintain the performative joy of dreamed architectures while addressing the real problems of making them and making them useful.

In his essay, 'The Agency of Constraints', Joe MacDonald speaks of 'the opportunity to introduce an additional set of

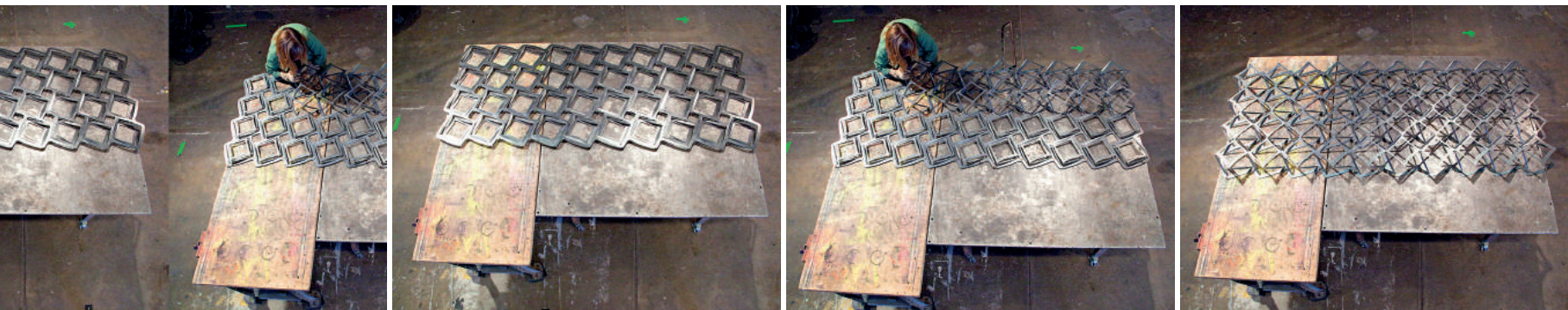

Fig. 7: Process of expanding a steel sheet employing Spin-Valence.
(Photo: P.D. Rearick.)

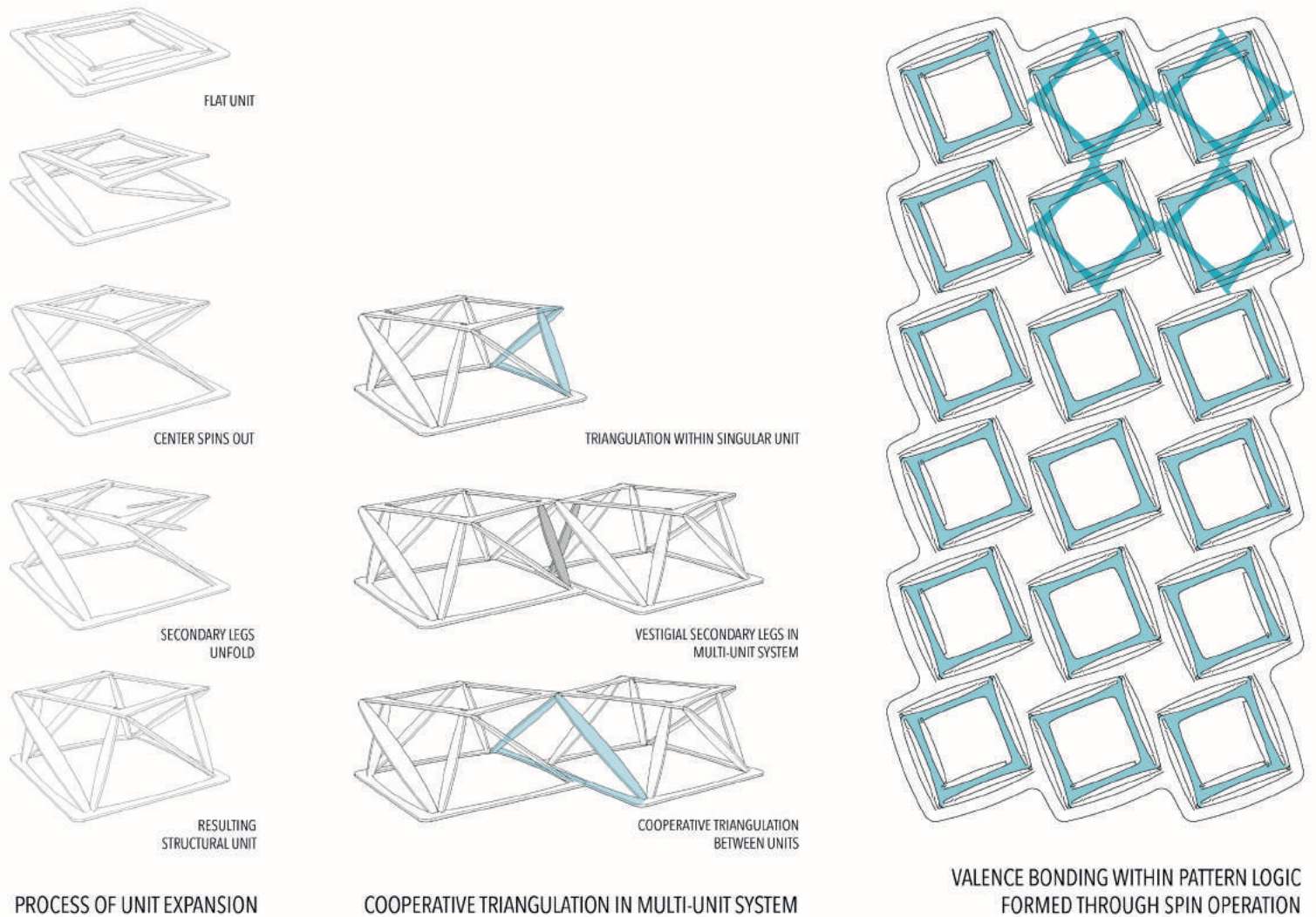

Fig. 8: Left: Process of unit expansion. Center: Triangulation in single unit and multi-unit system. Inner legs become vestigial as units cooperate to create triangulation. Right: Valence bonding formed through spin operation.

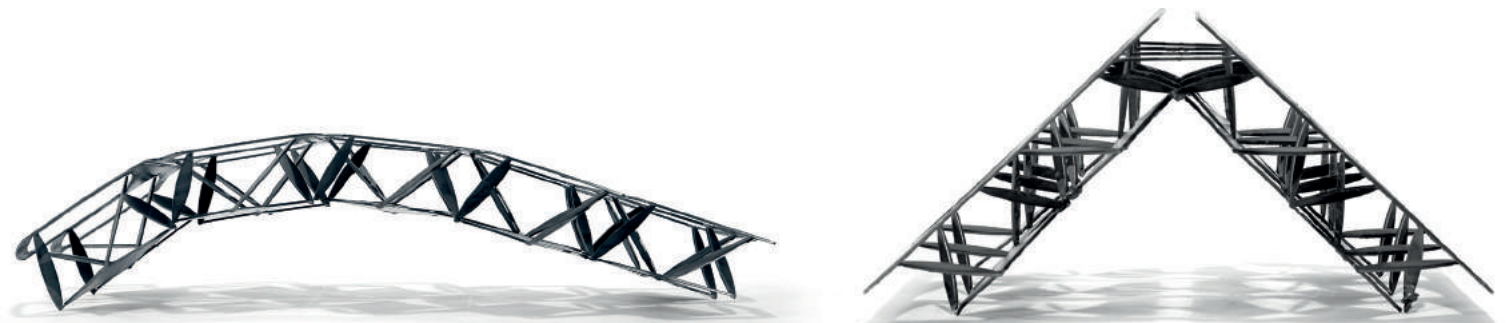
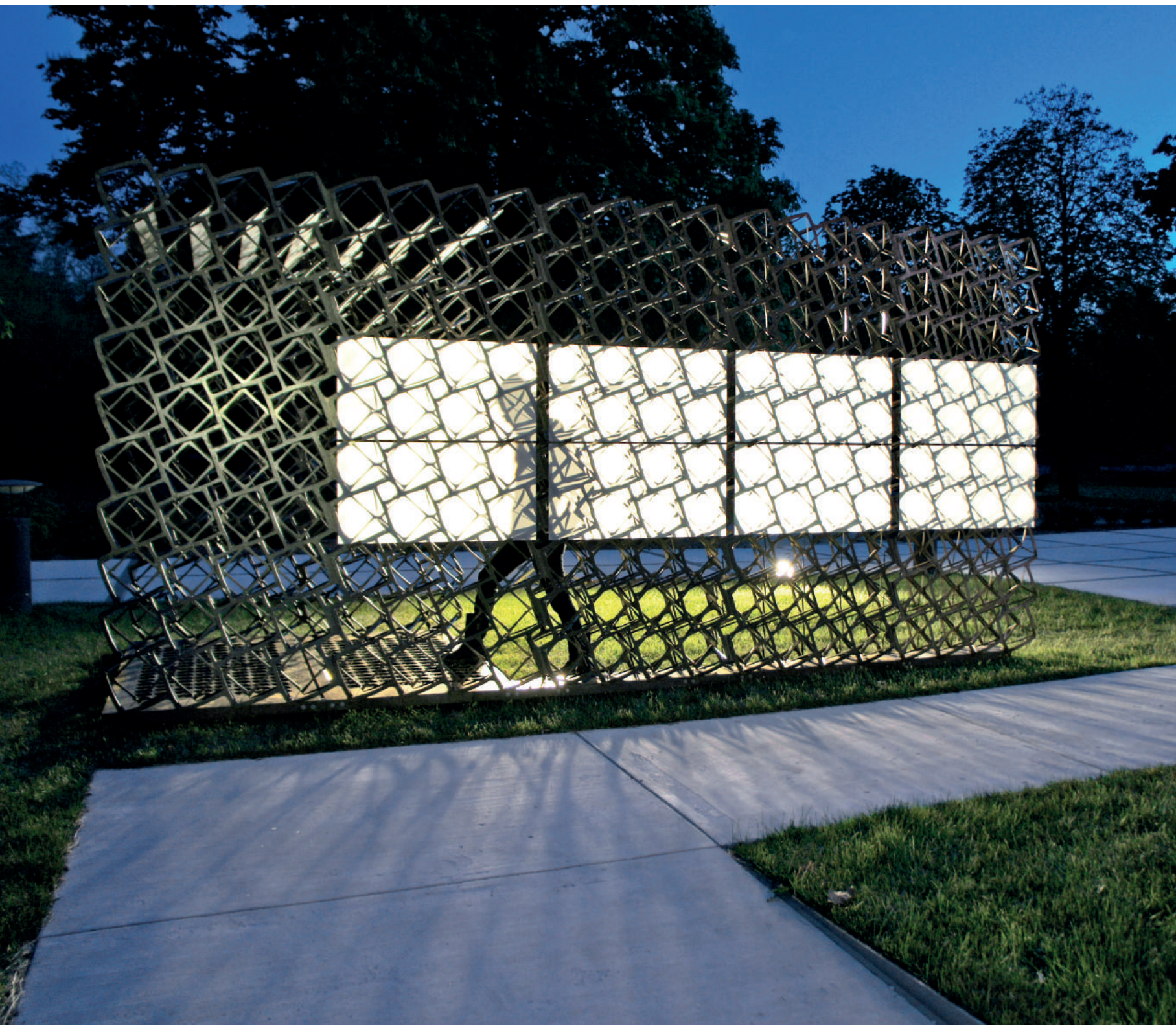

Fig. 9: Side views of curvilinear and angled space frame prototypes in steel. (Photo: P.D. Rearick.)



carefully designed parameters geared toward generating new links, new connectivities and new relationships ... The emergence of these properties offers an unprecedented interaction between intrinsic geometric, structural and material qualities, on the one hand, and conscious form-making on the other.³ The designer's influence on the appearance of each project will and should always be present, however, its temporary suppression in favour of other goals allowed this material system to evolve and cultivate its own intrinsic aesthetic qualities. An aesthetic emerged rooted in this evolutionary process.

Spin-Valence was not developed as a system to rationalise complex forms, rather as a means of reinvesting the human hand with agency in the realisation of material architecture. The pattern is intrinsic to its usefulness and its tuning to the hand of the maker, but the pattern is also the allure of the system. It gives the system depth and complexity even in its profound simplicity.

Two distinct yet interconnected veins of further research present themselves for the future of Spin-Valence. The first would explore the immediate relevance of digitally fabricated systems to the construction industry by developing this work into an integrated structure/enclosure system that will seamlessly interface with standard construction. This entails the further integration of sealable skins on both sides of the structural framework, creating a weather-tight, insulated, breathable wall, as well as space for the incorporation of lighting and other building services. The pressure of usefulness will evolve the system in ways it would never evolve outside of the criteria for real architecture. The second would further develop the system by keeping it free of constraints in order to push the formal and experiential possibilities of the pattern-logic. How can the system curve or transition in scale while maintaining its structural integrity? How can the play of light and shadow be further explored and exploited? How does morphing the cut pattern change the system structurally and formally? What properties are highlighted in the system at its scalar extremes? How can the system become interactive?

Future development of Spin-Valence will seek to employ the principles refined through iterative material testing within a computational framework, expanding and evolving the structural, formal and aesthetic capacities of the system.

Figs. 10, 11: Installation of Study in Spin-Valence on the grounds of Cranbrook Art Museum.

NOTES

1 Philip Beesley and Michael Stacey, 'Q & A', in Ruairi Glynn and Bob Sheil, eds., *Fabricate: Making Digital Architecture* (Cambridge, Ont.: Riverside Architectural Press, 2011), pp. 134–43. See discussion of ambivalence, esp. pp. 135–6.

2 While the work was not directly influenced by principles in chemistry, the rotational bending and bonding between units, as well as their chirality, or handedness, strongly resemble certain chemical and molecular behaviours. These similarities began to surface during and after development of the system. The name Spin-Valence was derived from the expansion process after cutting, and any apparent connection to Spin-Coupled Valence Bond Theory in chemistry is coincidental, though perhaps not surprising, based on the basic sympathy between the structures of the two.

3 Joe MacDonald, 'The Agency of Constraints', in Glynn and Sheil (see note 1), p. 198.



Fig. 1: The Rise – commissioned for the spring exhibition 'ALIVE: Designing with Living Systems' at the EDF Foundation Espace in Paris. Close-up view.

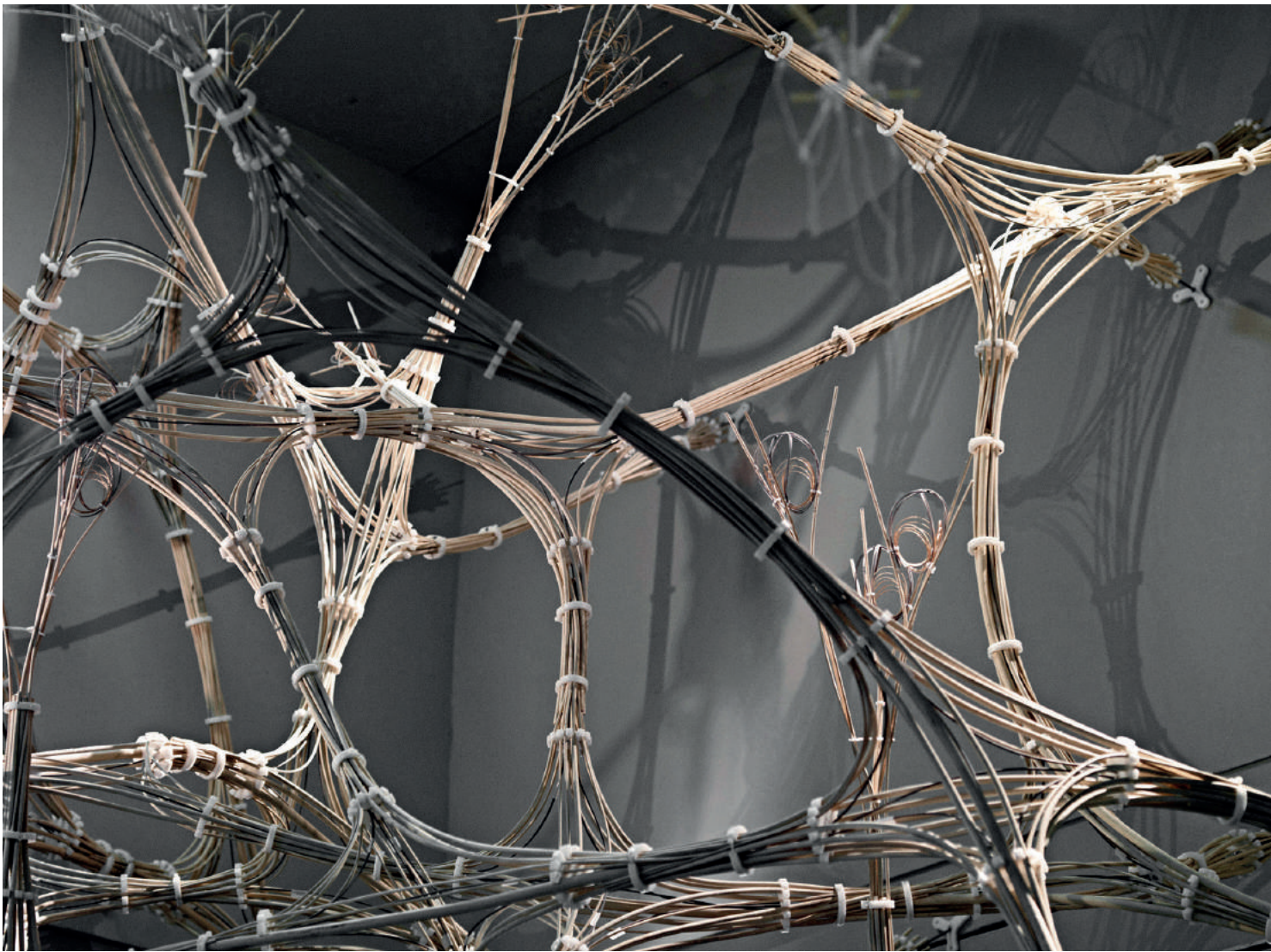

THE RISE: BUILDING WITH FIBROUS SYSTEMS

MARTIN TAMKE, DAVID STASIUK, METTE RAMSGAARD THOMSEN

Fibrous systems represent an alternative approach for building construction, combining individual member continuity with the potential for bespoke and locally differentiated distributions of material. A synthesis of multiple computational approaches in both design morphogenesis and in fabrication logics enable the modelling of construction assemblies that emulate fibrous biological systems. So, while the focus within the discussion of digital manufacturing generally revolves around the computer-controlled fabrication of elements, the research-driven installation project, *The Rise*, shows the benefits of using assembly logic as an integrated, incremental step in a more cohesive generative design and building process. The use of a time-based design, growth or fabrication logic throughout the entire process enables the fabrication of a three-dimensional structure comprised of bundled, actively bent fibres.

INTRODUCTION

Through evolution, fibre-based set-ups have emerged as the dominant mechanism for composing matter in complex organisms.¹ In many of these instances, long fibres are oriented in parallel and arrayed in nested hierarchies of stacked bundles, often beginning at the molecular scale. These relatively stiff fibres are generally unconnected physically and are either embedded in a matrix material, such as tree fibrils in a soft mix of lignin and hemicellulose,² or are organised through friction, such as muscle fibres, which are bundled in multiple groups and subgroups, each of which is collected through connective tissue.³ Bundling as a mechanical but mainly organisational principle provides organic systems with methods that direct generation, adaptation and variation⁴ and provides means for compartmentalisation, redundancy, robustness and flexibility.⁵

Human construction has long taken advantage of bundling and friction-based structures. In these prehistoric and vernacular architectures, the larger load-bearing capacity of bundled poles in comparison to the pure addition of individual poles has led to 'extremely efficient systems made of bamboo canes, thin branches and rods, reeds or even blades of grass'.⁶ Bundled reed poles define the tectonic of Greek Doric columns.⁷

Similar practices continue today: the Ma'dan in south Iraq make houses from tapered reed bundles⁸ and the South American Uros, indigenous people who live on Lake Titicaca upon floating islands fashioned from the Totorá reed, use the same plant to make boats of bundled dried reeds.⁹

Fig. 2: *The Rise* at the exhibition 'ALIVE: Designing with Living Systems' at the EDF Foundation Espace in Paris.



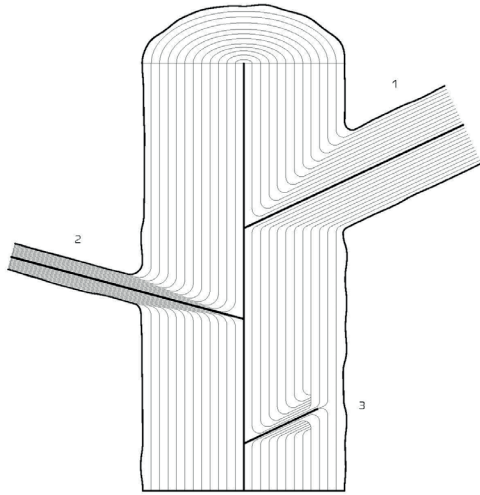

Fig. 3: A simplified section of a branch reveals its complex fibrous structure, which works in compression as well as in tension. (Diagram based on the publications of Dr Alex Shigo).¹³

Just as the use of bundling and fibre-to-fibre friction enables the use of vegetative fibre materials, so do contemporary practices with fibre-reinforced composite materials extend this practice into the twenty-first century. Non-uniform distributions of components create bespoke graded anisotropic materials, with variable properties in multiple directions and areas.¹⁰ Based on advances in computation, fabrication and material science in reinforced composites, the orientation and distribution of fibres is used to determine the properties that will become the means of optimising the material for specific applications.¹¹ This allows a full integration of material, contextual and structural considerations in the design of component systems.¹²

Contemporary research into the use of fibreglass-reinforced materials on an architectural scale shows that a performance-oriented organisation of material can be achieved through the utilisation of areas of similar properties and actually fabricated in surface-like topologies.¹⁴ In contrast, the branching and growth logic of trees in nature exhibit a fibrous organisational system wherein, over time, each element is individually directed and able to respond. Through their growth mechanisms, vegetative systems can balance a set of dynamic forces that are both internally and externally driven (fig. 3). Thus, evolution provides a blueprint for a resilient and sustainable building process that is based on the ability to handle emerging complexity through the responsive arranging of each additive fibre.

BIOMIMETIC TRANSLATION OF NATURAL FIBROUS SYSTEMS

The research-based installation, *The Rise*, was commissioned for the exhibition 'ALIVE: Designing with Living Systems' at the EDF Foundation Espace in Paris. *The Rise* examines and displays these natural systems and employs design and fabrication techniques that engage with the performance and behaviours of fibrous bundling material constructions. Bundling was explored for its potential to regulate stiffness and bending strength in the creation of bifurcations, reconnections and multi-branch conditions of aggregations of variably sized bundles of rattan core. Methods associated with member continuity, friction-based construction systems, and bespoke geometries achieved through novel oppositional active-bending connection assemblies were investigated. The integration of material simulation during morphogenesis and the registration of time-based, growth-driven model transformations on the topological level assigns growth mechanisms a place in the digital design model. After a successful growth cycle, this informs the separate fabrication model. The fibrous material system, in contrast, informs the genesis without being conceptualised itself as a responsive system.

BIOMIMETIC TRANSLATION OF GROWTH TROPISMS INTO DYNAMIC MODEL TOPOLOGIES

In order to counter the reciprocal conditions that characterise fibrous systems, *The Rise* endeavours to emulate the principles of vegetative growth. Rather than solving all requirements at once, this time-based and iterative approach allows the system to gain complexity over time and adapt dynamically to the specificities of the environment and the states that it encounters as it grows into form. Where the system is not intended to perform as a vegetative system itself, it takes on key concepts from plant growth for its morphogenesis. The particulars in this process are modelled after a selection of plant tropisms, those qualities of plants that 'are operationally defined as differential growth responses that reorient plant organs in response to the direction of physical stimuli'.¹⁵

The stimuli registered in the generative system emulate vegetative responses to light (*phototropism*), gravity (*geotropism*) and touch (*thigmotropism*). These responses are characterised by growth behaviours that result in accretion, branching, climbing and self-grafting. These last qualities endow the assembly with the ability to fuse into new circular relationships, creating both structural strength and additional infrastructure network pathways. With these generative guidelines operating as a conceptual, algorithmic, and mate-

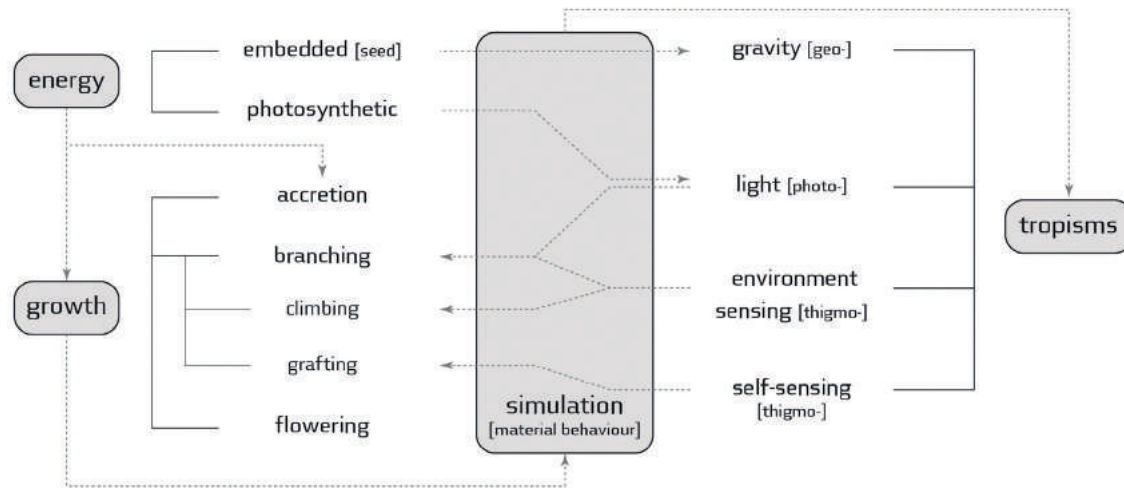

Fig. 4: Diagram of relationships between modelling drivers for morphogenetic modelling in The Rise project.

rially focused scaffolding, a fully integrated design system is created. Critical to this design system is the embedding of a virtual light as an 'energy source' and the integration of a continuous particle-based simulation of the bending and torsional deformation that accompany multiple stages of incremental growth (fig. 4).

FROM MORPHOGENESIS TO FABRICATION DEVELOPMENT

The structural system for The Rise emulates natural systems by laminating multiple elements in bundling for active bending under self-weight. As it is modelled after growth systems, these bundles grow, bend, branch, graft and climb in the process of digital morphogenesis. The specifics of these critical interpretations of natural systems emerged through an iterative process consisting of multiple cycles of speculative design through both digital and physical systems (figs. 5, 6).

Fig. 5: Investigations of bundling, element morphology and active bending in branch geometry.





Fig. 6: Speculative physical model investigating tropisms, branching, grafting and flowering towards a light source.

Here early speculative physical probes on details and global configurations are informed by already loosely sketched digital generative processes and in turn enrich the design feedback loop.¹⁶ A formal and conceptual scaffold emerges that informs/shapes targeted computational development, physical prototyping, empirical measurement and any ensuing system (re)calibration (figs. 7–9).

Through this iterative process, it becomes clear that the design and construction systems operate best through strategic decoupling. Here the assembly system is not fully realised during morphogenesis, but key topological, geometric and material performance indicators are captured through localised spring deformation in the generative model (fig. 10). This relies on a simple triangulated, truss-like configuration of accumulating modules that becomes central to the organisation of the custom particle spring simulation system that governs not only morphogenesis during the design process, but also systems organisation and the assignment of sectional thickness and orientation for later deployment in the fabrication system (fig. 11).¹⁷



Fig. 7: Analysis of bending and creeping by section and variable loading conditions.

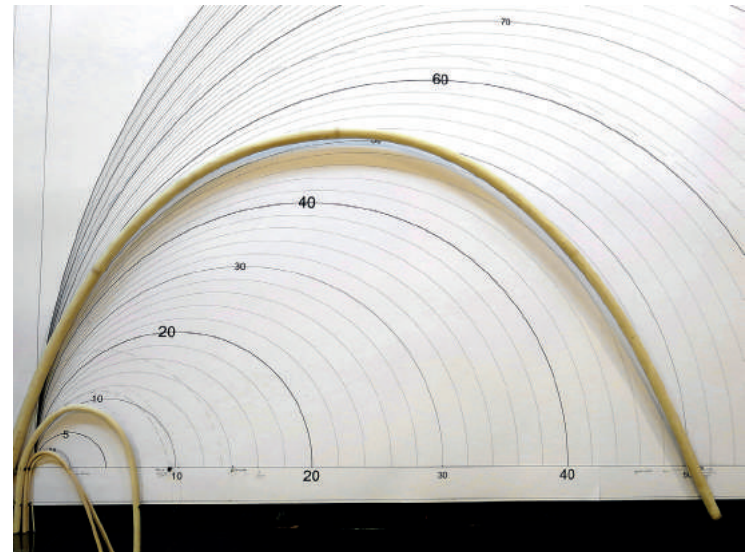

Fig. 8: Identification of minimum bending radius by rattan section.

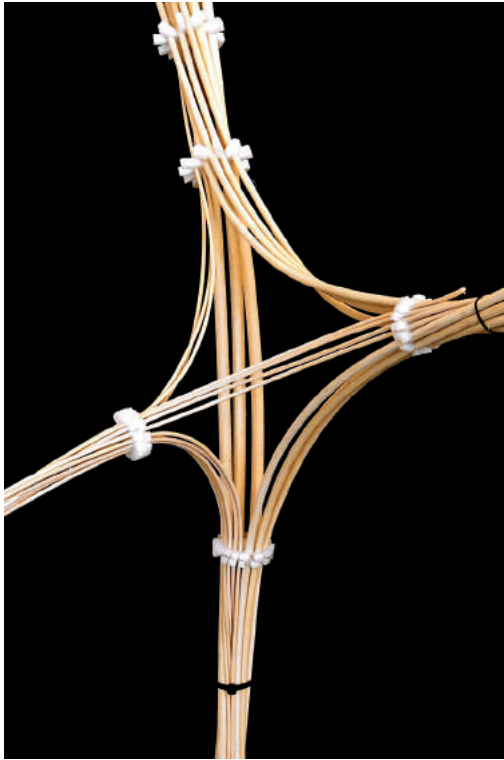

Fig. 9: Physical prototype for testing the digital system and providing materially driven feedback through empirical observation.

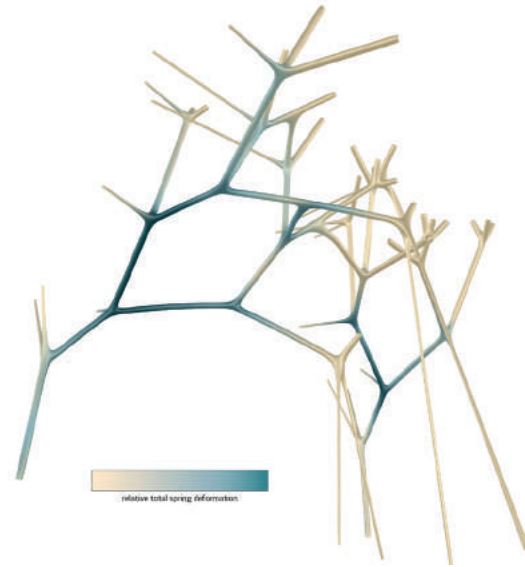

Fig. 10a: Localised spring deformation of morphogenetic model due to bending under self-weight during growth.

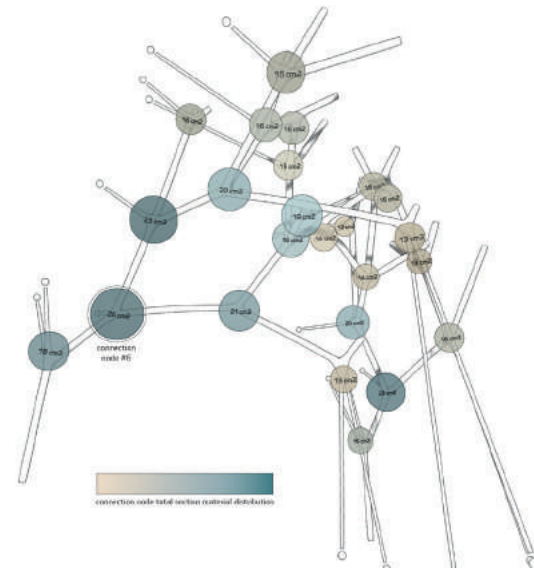
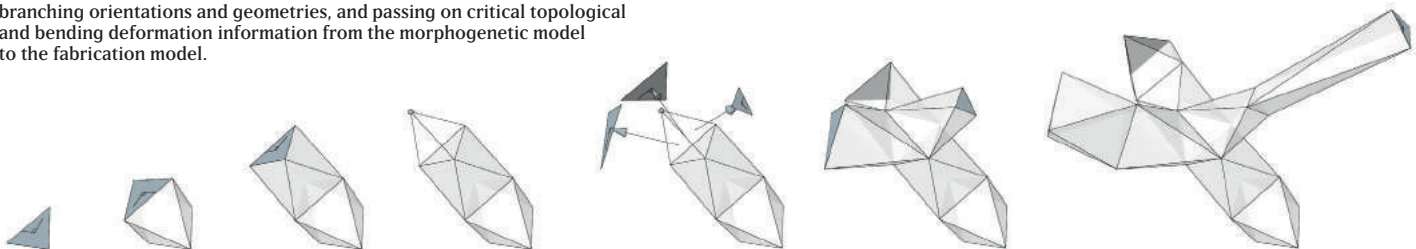

Fig. 10b: Translation of local deformations to assigned material thickness along each connection node.

Fig. 11: Triangulated system used for capturing growth, registering branching orientations and geometries, and passing on critical topological and bending deformation information from the morphogenetic model to the fabrication model.



MATERIAL AND ASSEMBLY SYSTEMS

Using a kit of three sectional diameters (5 mm, 10 mm and 19 mm) with up to 5 m in length, The Rise was assembled from a series of 'struts', bundled rattan core members, each of which describes a connection between one or more branching 'connection nodes' (fig. 12). The Rise uses a system of individually CNC-milled high-density polyurethane elements (HDPE) packing nodes to create the necessary cohesion between the bundled collections of rattan members along the assembly's struts (fig. 13). These rings, calculated to fit the bundled rattan elements, are equipped with teeth and compressed through an outer cable tie in order to create sufficient friction between the rattan elements.

Further overall cohesion is generated through a strategy for maximising the continuity of individual rattan members through compression rings and multiple connection nodes (fig. 14). A matrix material, such as in wood or composite fibre products, would afford a higher degree of structural efficiency; the approach taken considers the constraints of on-site installation and the engagement of the fibres with the connection nodes.

Similarly, the scale of the fibres used for The Rise precludes the weaving of collections of fibres with cross-lamination, as

in woody plants. Instead, a system of oppositional bending is leveraged that uses the rattan's flexural resistance to demonstrate both structural capacities and the bespoke geometric formations that emerge from the algorithmic growth process. These fibrous assemblies are organised through an integrated system of individually custom-milled HDPE star nodes. These inform the distribution of each source growth tip into three new branches and reorient and manage the rattan member

Fig. 13: Packing nodes for organising rattan bundles along structural struts.

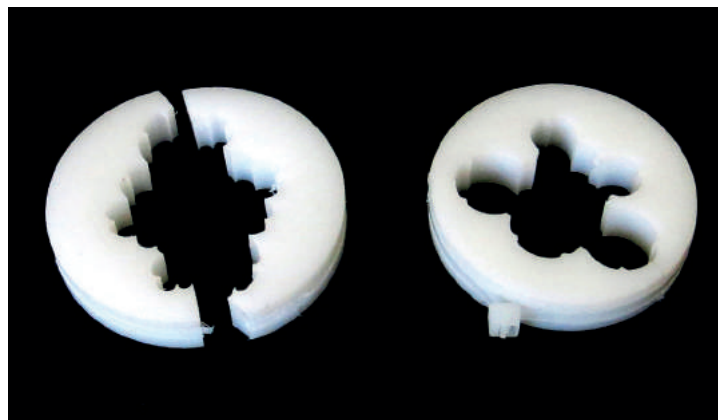
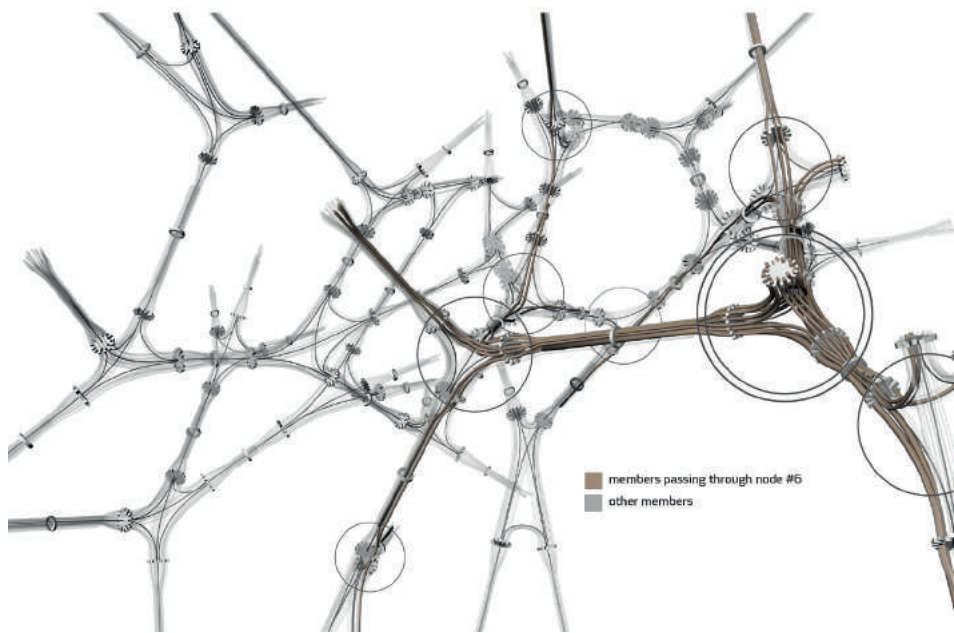

Fig. 12: Star nodes for organising oppositional active-bending rattan branch connection elements for both structural performance and bespoke geometric deployment with inner grey guideposts.



Fig. 14: Member continuity through multiple connection nodes, as demonstrated by identifying all the members that pass through node #6.



topologies that emerge from the meeting of multiple struts. Each node's composite rattan members are dimensioned such that both of the desired geometric orientations are achieved through oppositional bending resistance by the members in each node and the overall structural performance can be met (fig.15).

The end of each open strut is crowned with a 'flower'. These elements split the tapered struts and create a visual link to the

Fig. 15: Physical models exploring oppositional bending.



Fig. 16: Ornamental 'flower' describing open branch termination and conceptual continuity.



traditional crafting techniques associated with rattan core through their delicate detailing (fig. 16).

Finally, The Rise was able to establish connections to adjacent walls and the floor through custom-made steel and HDPE feet and wall pins. These combine the splicing logic of the stars with steel ball-joint elements that transfer tension and compression forces while maintaining free rotation.

FABRICATION AND INSTALLATION

The fabrication and installation experience associated with The Rise has been surprisingly seamless. The digital model was organised so that the packing node CNC drivers are rapidly exported for milling and are easily drawn, along with each rattan member number, for installation (figs. 17–19).

Likewise, each rattan member's topology is printed and arranged in terms of locating all the packing and star nodes associated with it along its length. The cutting and labelling simplifies the process of cutting and allows the installation to proceed easily, as each element essentially self-jigs according to the locations of the printed labels (fig. 20).

Essential self-jigging for struts and nodes is provided through guideposts (fig. 11). These are pre-cut 4 mm rattan members that define the exact length for each connection between star

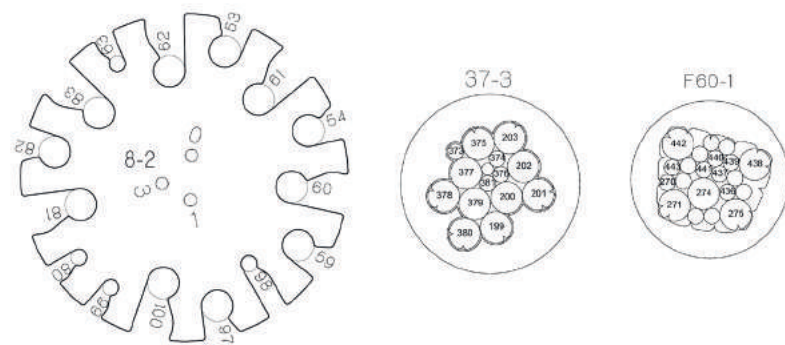

Fig. 17: Sample drawings of various star and packing nodes, from left to right: star node, tight packing node, and loose packing node for the connection of a strut to a flower.

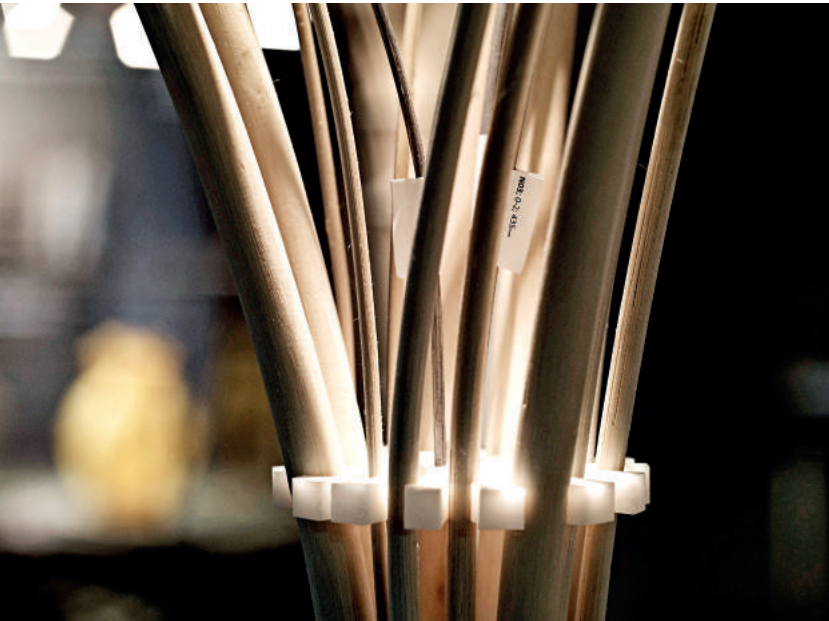

Fig. 18: Detail of installed star node.

nodes, whether it is along each strut or within each connection node. Each node has pre-drilled holes of 4 mm for embedding these elements. Use of these eliminates the need for additional measurement devices during installation, which proved critical for rapid and confident installation. This proceeded along the initial growth path within the generative model.

Fig. 19: Star nodes and packing nodes arranged according to installation order.



CONCLUSION

The translation of principles from nature was not undertaken in *The Rise* in order to create a responsive physical system, but rather to enrich the design space through biological logic. In watching the overall process from concept to fabrication on an architectural scale, the predominant nature of the design space is to be responsive and provide feedback.

The translation of fibrous logics found in nature into an architectural-scale structure poses multiple challenges:

- The design system must translate the design intent into a morphogenetic and fibre-based fabrication logic.
- Aggregation of fibres must be informed by the expected behaviour of the fibres under load and within the structural compound.
- Individual control of fibres in a material set-up must be maintained even as global behaviours are being considered and registered.
- Diagrammatic transformations of natural processes may have to be applied in order to approximate behaviours occurring at scales not accessible through a given material library.

These challenges are recursive and self-enforcing, and necessitate the use of ongoing feedback mechanisms between the scales of the design assembly and individual component materials.

The key to handling the fibrous systems in *The Rise* lies in the management of tightly integrated, complex systems. The collapse of simulation and accretion during the generative

Fig. 20: Rattan elements laid out sequentially, according to installation order, with temporary tags showing locations of associated star nodes and packing nodes along the length of each member.

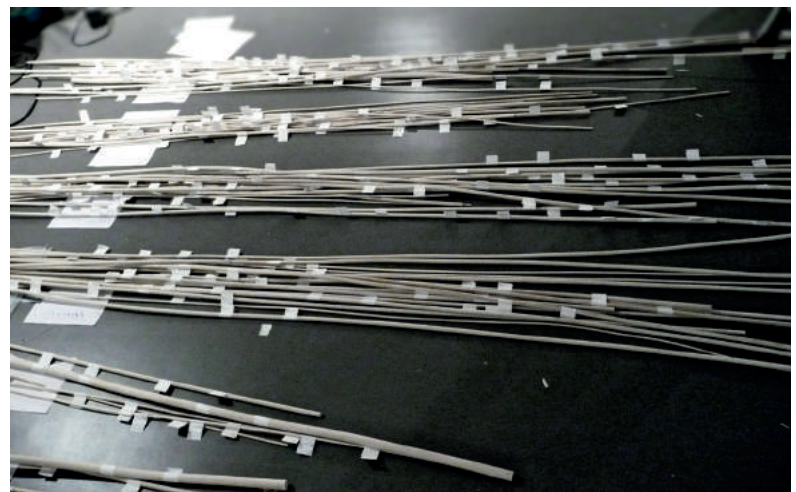

modelling phase can only be implemented through the strategic integration of tracking processes for all of the data and geometric drivers essential to making the model. The Rise applies a series of approximations and substitutions during the translation of biomimetic drivers into generative algorithms and fabrication strategies. These are tied in through a conceptual scaffold and diagram of operation developed during the investigation and modelling phases of the project. Here observations – e.g., that a matrix material as in wood or composite fibre products provides a higher degree of structural efficiency – can be balanced with the constraints of on-site installation and the engagement of the fibres with the connection nodes.¹⁸

The Rise demonstrates that the handling of organisation and time is more essential to the handling of complexity than fabrication machinery or material, as these are becoming an extension to emerging digital crafting techniques.¹⁹

ACKNOWLEDGEMENTS

The study would not have been possible without the enduring efforts of Hollie Gibbons and Shirin Zhagi on design and development, Hasti Valipor for the Parisian support, Carole Collet for the invitation to the exhibition and excellent curatorship.

NOTES

- 1 William E. Friedman and Sandra K. Floyd, 'The Origin of Flowering Plants and Their Reproductive Biology', *Evolution* 55 (2001) pp. 217–31.
- 2 George Jeronimidis, 'Structure-Property Relationships in Biological Materials', in Manuel Elices, *Structural Biological Materials: Design and Structure-Property Relationships* (Amsterdam: Pergamon, 2000) pp. 3–16.
- 3 Brian Macintosh, Philip Gardiner and Alan McComas, *Muscle Architecture and Muscle Fiber Anatomy, Skeletal Muscle: Form and Function* (2nd ed.) (Champaign, Ill.: Human Kinetics, 2006), pp. 3–21.
- 4 Jeronimidis (see note 2).
- 5 Nicolas de Moncheaux, *Spacesuit: Fashioning Apollo* (Cambridge, Mass.: MIT Press, 2011), p. 319.
- 6 Johannes Fritz, Siegfried Gass, Switbert Greiner, et al., 'Building with Straight Vegetal Rods', in Siegfried Gass, ed., *IL 31: Bambus – Bamboo* (Stuttgart: Krämer, 1985) pp. 264–86.
- 7 Frei Otto, 'Comments on the History of Rod Structures', in Gass (see note 6), pp. 396–410.

- 8 Edward Ochenschlager, 'Life on the Edge of Marshes', *Expedition*, 40/2 (1998), pp. 29–39.
- 9 Charles B. Heiser, 'Totoras, Taxonomy and Thor', *Plant Science Bulletin*, 20/2 (1974), pp. 22–6.
- 10 Toshio Hirai, 'Functional Gradient Materials', *Materials Science and Technology*, online (2006).
- 11 Paul Nicholas, 'Embedding Designed Deformation: Towards the Computational Design of Graded Material Components', in Lars Hallnäs, Annika Hellström and Hanna Landin, eds., *Ambience '11 Proceedings, 28–30 November 2011, Borås, Sweden* (Borås: University of Borås, 2011). Available at: http://www.re-ad.dk/files/34560369/Ambience11_PaulNicholas_paper.pdf.
- 12 Marshall Stoneham and John H. Harding, 'Not Too Big, Not Too Small: the Appropriate Scale', *Nature Materials*, 2 (2003) pp. 77–83.
- 13 Axel Shigo, *Tree Anatomy* (Durham, N.H.: Shigo & Trees, 1994).
- 14 Jan Knippers, Jan Cremers, Markus Gabler and Julian Lienhard, *Construction Manual for Polymers & Membranes: Materials and Semi-Finished Products, Form Finding and Construction* (Basle: Birkhäuser, 2011); Frederic Waimer, Roberto La Magna and Jan Knippers, 'Integrative Numerical Techniques for Fibre Reinforced Polymers: Forming Process and Analysis of Differentiated Anisotropy', in *Proceedings of the International Association for Shell and Spatial Structures (IASS) Symposium, Beyond the Limits of Man* (Wroclaw, 2013) (forthcoming).
- 15 Alex Esmon, Ullas Pedmale and Emmanuel Liscum, 'Plant Tropisms: Providing the Power of Movement to a Sessile Organism', *International Journal of Developmental Biology*, 49 (2008), pp. 665–74.
- 16 Mette Ramsgaard Thomsen and Martin Tamke, 'Narratives of Making: Thinking Practice-Led Research in Architecture', in J. Verbeke and A. Jakimowicz, eds., *Communicating (by) Design* (Brussels: Chalmers University of Technology / Sint-Lucas School of Architecture, 2009), pp. 343–51.
- 17 Martin Tamke, David Stasiuk and Mette Ramsgaard Thomsen, 'The Rise: Material Behaviour in Generative Design', in Philip Beesley, Omar Khan and Michael Stacey, eds., *Adaptive Architecture: Proceedings of the 33rd Annual Conference of the Association for Computer Aided Design in Architecture, October 24–27, 2013, Cambridge, Ontario, Canada* (forthcoming).
- 18 Nicholas 2011 (see note 11); Hirai 2006 (see note 10).
- 19 Malcolm McCullough, *Abstracting Craft: the Practiced Digital Hand* (Cambridge, Mass.: MIT Press, 1996).

Fig. 1: Matter Design, *La Voûte de LeFevre*, Banvard Gallery, 2012.



LA VOÛTE DE LEFEVRE: A VARIABLE-VOLUME COMPRESSION-ONLY VAULT

BRANDON CLIFFORD, WES MCGEE

Particle-spring systems are commonly used to develop compression-only form-finding systems. This paper proposes to use a particle-spring system in response to a desired form in order to generate a variable-volume, compression-only structure fabricated of volumetric material. By varying the depth and the volume of the system, loads can be re-directed through the depth of material in order to result in a desired form, as opposed to a structurally optimal form that assumes a uniform thickness approach. This paper proposes to generate, build, and test a compression-only vault composed of variable-volume units. This research will advance knowledge surrounding volumetric physics calculations as well as volumetric fabrication methodologies.

INTRODUCTION

Thin-shell compression-only structural systems are relatively new to the built environment. Compression-only structures, on the other hand, are ancient. Thin-shell structures assume a minimal and consistent cross-section. This assumption is driven by material efficiency. The results are forms developed exclusively by structural concerns (typically gravity), hence the term form-found. Architecture has to respond to structural concerns, but it also has to address a variety of other issues, e.g. acoustical, formal, programmatic, etc. It is not necessary for form to be driven strictly by structural requirements. For example, Gothic cathedrals contain the thrust-vector within the variable depth of the stone's cross-section. These cathedrals are not determined by idealised catenary form, but through a confluence of architectural desires with compression-only principles. With this approach as inspiration, this paper addresses the potential of compression-only systems to be resolved through a variable volume in order to obtain a desired form.

Much research has been done in analysing existing variable-depth structures to determine if a thrust vector falls inside the depth of material.¹ Other methods assume a fixed depth of material in order to generate a design. The method proposed in this paper assumes a desired geometry and allows for a variable-

volume to redirect the thrust vector as a means to produce a viable design that concerns both structure and other formal concerns. If typically one assumes thin, this paper assumes form.

This method is dedicated to addressing architectural concerns with structural results. This paper does not advocate for the reversion to a past architecture. It promotes the insertion of lost knowledge into our current means and methods of making.

PARTICLE-SPRING SYSTEMS

Particle-spring systems are based on lumped masses, called particles, which are connected to linear elastic springs. The solver used for this research is part of a particle-spring system implemented by Simon Greenwold.² 'Each particle in the system has a position, a velocity, and a variable mass, as well as a summarised vector for all of the forces acting on it.'³ This Runge–Kutta solver is not necessary to generate a catenary (even load distribution), but it is necessary when evaluating an irregular load case. The method applied in this research will always be an irregular load case because it is assumed the resulting geometry is not an idealised catenary form.

Particle-spring systems have been explored to create virtual form-finding methods such as Kilian's *CADenary* tool.⁴

COMPRESSION-ONLY STRUCTURES

A compression-only structure will stand as long as the thrust vector of the system falls within the middle third of its cross section. It is not always predictable that a structure will fail, though it is possible to know if it will stand. A paper by Jacques Heyman introduced the safe theorem for masonry structures.⁵ This theorem states that a compression-only structure can stand so long as one network of compression forces can be found in equilibrium within the section of the structure. This solution is a possible lower-bound solution. When evaluating existing structures, it is not always possible to understand exactly where this force network is.⁶ The method applied in this paper can calculate and ensure a thrust vector falls within the thickness of material.⁷

FORM RESPONDING

Form-finding analogue models by such researchers as Otto⁸ and Gaudi, or even the virtual versions like Kilian's *CADenary*,⁹ have proved it is difficult to control and predict the results of the final found-form. Moreover, if that form does not correspond with a force that is external to the form-finding model, it is difficult to resolve the two into a solution. This paper proposes form-responding as approach. Form-responding takes a desired form as input and produces a variable-volume solution to allow for interaction between these external forces and the solver-based model.

METHODOLOGY

The vault is computed with a solver-based model that elicits a compression-only structure from a structurally non-ideal geometry. The model requires a fixed geometry as input and opens apertures in order to vary the weight of each unit. This dynamic system reconfigures the weight of the units based on a volumetric calculation. If unit A contains twice the volume of unit B, then unit A weights twice as much. It requires that the material of the project be consistent, and solid (hollow does not work). The computed result produces a project that will stand 'forever' as there is zero tension in the system precisely because of the weight and volume of the project, and not in spite of it.

BASE GEOMETRY

This paper assumes the base geometry as fixed. The assumption is that this geometry has been predetermined by a force external to the model: acoustics, formal, building code, etc. Future research could allow for a more fluid and reciprocal re-

lationship between the structural requirements and these other formal drivers. While this geometry is not strictly aligned with structural concerns, it must be close in order to result in a solution. In previous versions of the calculation,¹⁰ almost any geometry would work as input. The variable-volume calculation is more nuanced.

This calculation requires a number of inputs to the system. It requires both an upper and lower bound surface. These surfaces parameterise the depth of the units as variable during the form generation, but fixed during the variable-volume calculation. The calculation also requires a location for the node of each unit to be located within the system.

These particles are evenly distributed across a base geometry that falls between the upper and lower bound surfaces. This distribution employs another particle-spring system to locate and distribute the points across the surface, increasing in distance from each other as they approach the upper elevations of the geometry. Figure 2 demonstrates the result: an enlarging of the units in the vault, and a tightening of the units down in the columns. The particle-spring system computes itself against these three inputs, which serve as the data.

Fig. 2: Drawing of the particle-spring system arrayed across the desired base geometry.

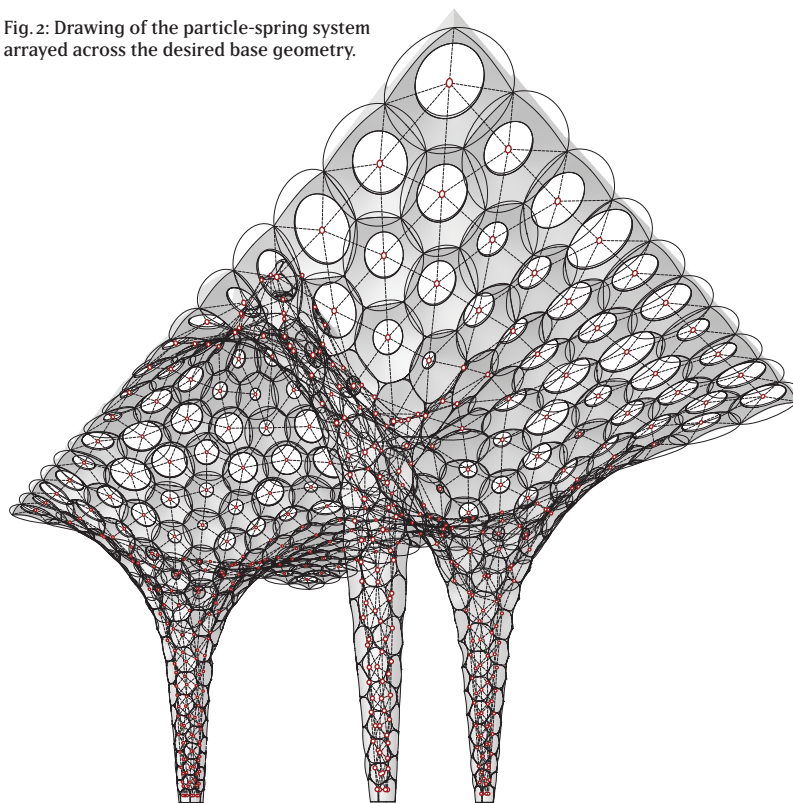

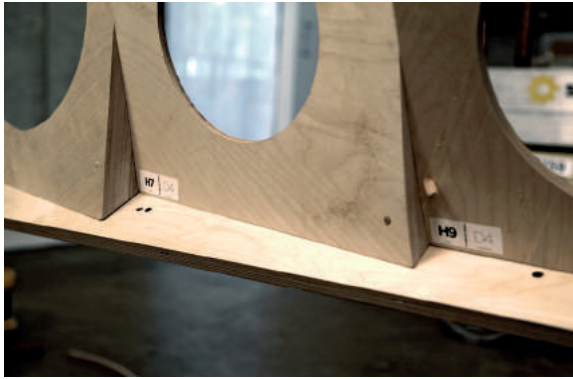

Fig. 3: Detail of the voussoir connection and indexing.



Fig. 4: The upper bound geometry skips continuity at the connection of the voussoirs due to the requirement for the milling operation to have a flat surface.

PARTICLE-SPRING SYSTEM

The particle-spring system is composed of a number of particles, the length of the springs that connect the particles, and the continual resulting forces on each particle informing the system. While the organisation is consistent, the system has been reconfigured in a variety of solutions.¹¹ This paper employs an evenly distributed system as described above.

VERTICAL DISTANCE VERSUS VOLUME

When analysing masonry arches, it is common practice to use static block analysis to break down an arch into a few polygons. The area of each polygon determines the vertical thrust vector.¹² Previous iterations of this calculation employed a high resolution of vertical distances to inform each particle with its new relative weight. This paper employs volume as opposed to area or distance. Similar work has been conducted using volume to analyse and determine the viability of a structure.¹³ This paper employs the variability of the volume to ensure a solution.

The location of the particles defines the virtual thrust network. In order to ensure a solution, these particles are required to be moving during the calculation until they find equilibrium. At each interval of the calculation, a number of operations occur, complicating the calculation beyond a simple distance measurement. The new location of each particle generates a three-dimensional Voronoi calculation that intersects with the lower bound base geometry surface. This intersection then produces points at the intersection of each curve where an interpolated curve is generated. Simultaneously, the centroid point (also the particle) finds the closest points on the upper bound surface and generates a circle perpendicular to the line connecting these two points. The plane this circle is

generated on also serves as the flat backside that sits on the table of the computer numerically controlled (CNC) router, a useful fabrication constraint (see figs. 3, 4) The circle and the curve are then lofted with each other, producing a surface that is trimmed with the rest of the surfaces in the system. The intersection of these surfaces extrudes to the closest position on the upper surface, producing the voussoir¹⁴ that discretises each unit in the vault.¹⁵ Each unit now contains an enclosed volume that can inform the system with its weight relative to its neighbours. Figure 5 demonstrates these operations. These operations are calculated continually until the system finds equilibrium and a solution can be detected.

Fig. 5: Diagram of particle-spring system and the variable volume calculation. The volume of the enclosed surfaces equals the vertical thrust on the particle.

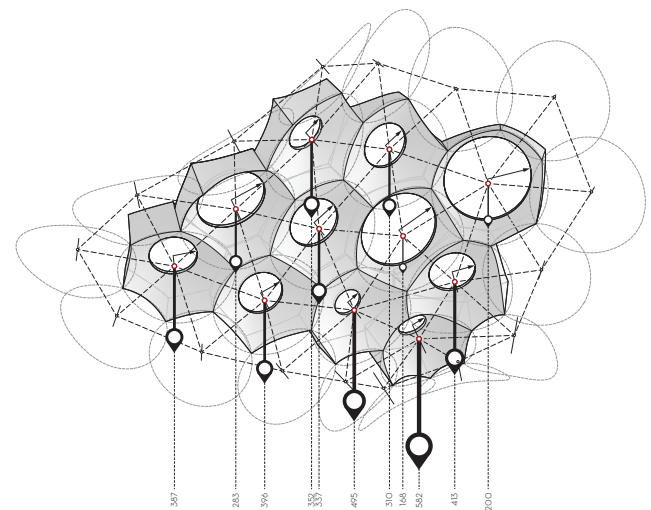

DESIGN

A deliberate attempt was made in this project to topologically¹⁶ transition from column to vault. No break is inserted in this transition; however, this is a lie. In reality, there is a difference between column and vault. The column is solid (fig. 6). It is treated as a single unit. The vault on the other hand is discretised into its constituent units.¹⁷ This moment of discrepancy is attempted to be seamless; however, the grain of the wood demonstrates the reality. There is a good reason for this false reality. A column does not perform in the same manner as a vault. The thrust vectors inside the column are vertical, not progressively horizontal. To that end, a column does not resist horizontal thrust. It resists buckling. The solidity of the column is paramount.

The discrepancy in transitioning from solid column to discretised vault is resolved via rhetoric. The rhetoric of individual units continues down the column as if the single and solid column was in fantasy an impossible continuation of the units to the ground. This rhetoric is not a simple continuation of the conical-Boolean geometry that composes the vault. It is a new, yet similar approach. It refers to the conical-Boolean, without repeating it. This shift in geometry allows the system not only to calibrate volume (as applied in the vault), but also to perform another transition from fragmented to smooth. As the units make their way down the column, they do get smaller, but the dimples slowly make their way to the surface, producing the illusion of continuity, only to push through that continuity as the very base. This punctuation to the statement suggests that the weight of the vault above is so great that the column is forced to bulge outward.

Fig. 6: Column detail, Matter Design, *La Voûte de LeFevre*, Banvard Gallery, 2012.



FABRICATION

The vault was produced with Baltic birch plywood. The plywood is sourced in three-quarter-inch thick sheets awaiting the 'thickening'. Perhaps it is evidence of the state of the industry that volumetric material is difficult to procure. Each custom unit is digitally dissected and sliced into these thicknesses, cut from the sheets, and then physically reconstituted into a rough volumetric form of their final geometry. These roughs are indexed onto a full sheet and glued, vacuum-pressed, and replaced onto the CNC router as demonstrated in figure 7. This process is materially more efficient than carving these units from one solid block of material, though it is more laborious.

Fig. 7: Roughed aggregated blanks of the desired geometry await the milling operation on the five-axis machine.



Fig. 8: Swarf milling the voussoir edges.



This project is produced on a five-axis Onsrud router.¹⁸ The swarf¹⁹ toolpaths utilised are dedicated to removing the most material with the least effort (fig.8). Instead of requiring the end of the bit to do the work, this path uses the edge of the bit to remove much more material. Because this method traces the geometry with a line, as opposed to a point via Philibert De L'Orme's technique stereotomy,²⁰ it requires the units are constituted of ruled surfaces.²¹ This constraint informed the conical-Boolean geometry in the vaulted portion of the project, though relaxed in the columns where a more typical surface milling operation produces the rhetorical bulges. This shift in tooling operation also speaks to the understanding of the difference between column and vault.

Fig. 9: Array of all the unique voussoirs that compose the vault.

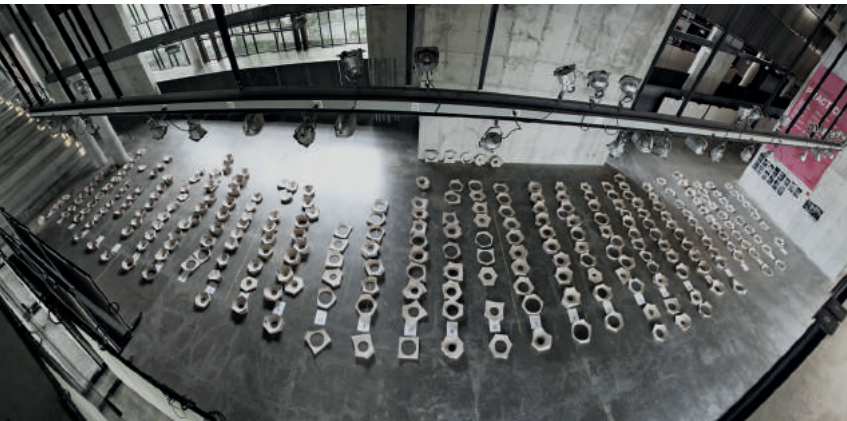

Fig. 10: Various unique voussoirs that compose the vault.



ANALYSIS

This project was fabricated with an assumed zero-fill approach. As part of the requirement that the vault must be dismantled, there is no mortar. Discrepancies, errors, and gaps were impossible to resolve because of this zero-tolerance approach. In order to ensure completion on site in difficult locations, a manual band saw handled the work of removing collision material on the backside of the problematic units. This on-site carving did not affect the front edge of the units, but it did produce a gap where the voussoir surfaces were not coincidental. This happy accident aligns precisely with the Inca wedge²² process, where masons would fill from the backside of a wall with mortar into a voided wedge between stones, while the front and

Fig. 11: Assembly of the vault.





Figs. 12, 13: Matter Design, *La Voûte de LeFevre*, Banvard Gallery, 2012.

architectural face appeared to be mortarless. There is room for further exploration to capitalise on the potential of the Inca wedge method.

CONCLUSION

La Voûte de LeFevre demonstrates the potential of informing contemporary fabrication methodologies with past knowledge concerning volume. It successfully employs physics simulation to ensure stability through volumetric calculations that serve in reciprocity with volumetric making processes. While aggregate Baltic birch plywood serves as an analogue, potential is seen in other volumetric materials, such as autoclave aerated concrete, plaster, or stone.

ACKNOWLEDGEMENTS

This paper presents results of an ongoing research project that began at the Princeton University School of Architecture under the tutelage of Axel Kilian and continued at Ohio State University, Knowlton School of Architecture (with Howard E. LeFevre Emerging Practitioner Fellowship funding) and the Massachusetts Institute of Technology (with Belluschi Lectureship funding). Two particle-spring systems have been used. The first was implemented by Simon Greenwold in Java as a library for 'Processing' (www.processing.org), an environment developed by Ben Fry and Casey Rease. gHowl (www.grasshopper3d.com/group/ghowl) by Luis Fraguada was used to communicate via UPD between processing and Grasshopper (www.grasshopper3d.com), a plug-in developed by David Rutten for Rhinoceros (www.rhino3d.com), a program developed by Robert McNeil. The second particle-spring system was generated entirely inside Grasshopper with the aid of two plug-ins: Kangaroo (www.grasshopper3d.com/group/kangaroo) by Daniel Piker served as the physics simulation of the particle-spring system and Hoopsnake (www.volatileprototypes.com/projects/hoopsnake) by Volatile Prototypes allowed the vertical distance to loop back into the calculation.

NOTES

- 1 Philippe Block, Thierry Ciblac and John Ochsendorf. 'Real-time limit analysis of vaulted masonry buildings', *Computers and Structures*, 84 (2006), pp. 1841–52.
- 2 The first particle-spring system was implemented by Simon Greenwold in Java as a library for 'Processing' (www.processing.org), an environment developed by Ben Fry and Casey Rease. Greenwold, Simon and Edward Allen. 'Active Statics', 2003, accessed 1 November 2011. <http://acg.media.mit.edu/people/simong/statics/data/>; Ben Fry and Casey Reas, 'Processing web site' (2011), accessed 1 November 2011. <http://www.processing.org/>.
- 3 Axel Kilian and John Ochsendorf, 'Particle-Spring Systems for Structural Form Finding', *Journal of the International Association for Shell and Spatial Structures*, 46/2 (2005), pp. 77–84.
- 4 Ibid.
- 5 Jacques Heyman, 'The Stone Skeleton', *International Journal of Solids and Structures*, 2 (1966), pp. 249–79.
- 6 Philippe Block and John Ochsendorf, 'Lower-Bound Analysis of Unreinforced Masonry Vaults' in Dina d'Ayala and Enrico Fodde, eds., *Proceedings of the VI International Conference on Structural Analysis of Historic Construction* (London: CRC Press, 2008), pp. 593–600.
- 7 For further reading on lower-bound analysis of unreinforced masonry structures: Jacques Heyman, *The Masonry Arch* (Chichester: Ellis Horwood, 1982); Santiago Huerta, 'Mechanics of Masonry Vaults: the Equilibrium Approach', in Paulo B. Lourenço and Pere Roca, eds., *Historical Constructions 2001, Universidade do Minho, Guimarães: Possibilities of Numerical and Experimental Techniques* (Coimbra, Portugal: Institute for Sustainability and Innovation in Structural Engineering, 2001), pp. 47–70. Santiago Huerta, *Arcos, Bóvedas y Cúpulas: Geometría y Equilibrio en el Cálculo Tradicional de Estructuras de Fábrica* (Madrid: Instituto Juan de Herrera, 2004).
- 8 Frei Otto and Bodo Rasch, *Finding Form: Towards an Architecture of the Minimal* (Berlin: Edition Axel Menges, 1995).
- 9 Kilian and Ochsendorf (see note 3).
- 10 Brandon Clifford, 'Thick Funicular: Particle-Spring Systems for Variable-Depth Form-Responding Compression-Only Structures', in Xavier Costa and Martha Thorne, eds. *Change Architecture Education Practices: 2012 ACSA International Conference* (New York: ACSA Press, 2012), pp. 475–81.
- 11 Brandon Clifford, 'Thicker Funicular: Particle-Spring Systems for Variable-Depth Form-Responding Compression-Only Structures', in Paulo Cruz, ed. *Structures and Architecture: Concepts, Applications and Challenges* (London: CRC Press, 2013), pp. 205–6.
- 12 Block and Ochsendorf (see note 6).
- 13 Block and Ochsendorf (see note 6).
- 14 Voussoir: a wedge-shaped element, typically a stone, used in building an arch or vault.
- 15 The surface geometries enclosing this volume are generated with ruled surfaces due to a reciprocal relationship with the method of fabrication. For more information on this process, see note 6.
- 16 Topology: in mathematics, the study of the properties of a geometric object that remains unchanged by deformations such as bending, stretching, or squeezing but not breaking.
- 17 A similar strategy of the solid column transitioning into voussoirs above was employed in Peterborough Cathedral. These voussoirs also misalign on the upper bound geometry, while aligning precisely on the lower bound (visible surface). For more information, see Robin Evans, 'Drawn Stone', in *The Projective Cast: Architecture and Its Three Geometries* (Cambridge, Mass.: MIT Press, 2000), pp. 178–239.
- 18 With fabrication support from the University of Michigan Taubman College FABLab.
- 19 Swarf machining is a technique that allows side cutting with an end mill while proceeding along the surface of a part, such as the sidewalls of a tapered rib.
- 20 Philibert de L'Orme (sixteenth century) was, like Palladio, the son of a mason. He merged into architecture, not through a series of rigorous understandings of form or technique, rather from the builder or mason. In his printed work of 1567, *Le Premier tome de l'architecture*, Philibert de L'Orme introduced the method and definition of *art du trait géométrique*. This method developed as a way to reciprocally draw what can be built and vice versa. Because of this emergence, de L'Orme can also be credited as the first professional architect, because his technique served to instruct and communicate between the designer and the builder, though an important distinction should be drawn between the representations of architecture we now generate and de L'Orme's descriptive geometry that served as method template to construction. In a way, de L'Orme can be considered the predecessor to digital fabrication. For more information on this topic, see Evans, 2000 (see note 17) and Brandon Clifford and Wes McGee, *Range: Matter Design* (Reykjavik: Oddi, 2013); as well as Matthias Rippmann and Philippe Block, 'Digital Stereotomy: Voussoir Geometry for Freeform Masonry-Like Vaults Informed by Structural and Fabrication Constraints', in *Proceedings of the IABSE-IASS Symposium* (London, 2011).
- 21 This project is part of a line of work dedicated to this proposal of employing the line for carving. For more information, see: Brandon Clifford and Wes McGee, 'Periscope Foam Tower' in Ruairi Glynn and Bob Sheil, eds. *Fabricate: Making Digital Architecture* (Cambridge, Ont.: Riverside Architectural Press, 2011), pp. 76–9.
- 22 Brandon Clifford, *Volume: Bringing Surface into Question* (SOM Prize Report, SOM Foundation, 2012), pp. 286–9.

FORMING MACHINES

ACHIM MENGES IN CONVERSATION WITH PHILIP BEESLEY

PHILIP BEESLEY

Achim, I think of you as a leader in a surging technology that takes computational design and combines it with a direct involvement with material properties. You offer us a new vision of architecture – don't think I'm exaggerating when I put the terms in that way, when I think of the students and researchers around your centre at Stuttgart and the almost iconic status of the research pavilions that have emerged as a result of your research. This work has potent influence. I am hoping you might be willing to take us through the substance of your work, using the research pavilions as evolving examples that integrate new craft from robotics and also the pronounced presence of biology as an analogy in the most recent generation. I am also hoping that you can reflect on your early concept of behaviour-based computational design morphologies, or 'morpho-ecologies'. Perhaps this exchange might reflect on a century-long movement in design. I think of Gaudí's iconic work, and D'Arcy Wentworth Thompson's beautiful *On Growth and Form* and

associate them with you. In different ways, both of those figures suggest that design could be based on precise forces and that bio-mathematics could become an articulate language. You carry Frei Otto's legacy, working with analysis and with full-blooded participation in empirical making, feeling and observing. How would you describe the traditions that you work within?

ACHIM MENGES

I will try to answer your question, reflecting on what lineage our work belongs to. You actually already pointed out the obvious connection to one of the most prominent former colleagues of ours here at the University of Stuttgart, Frei Otto. He really laid the foundation for an interdisciplinary research culture that creatively engages the rigour and insights of engineering science in architectural design. I think it's also important to point out that all our work is the result of a team effort, which materialises through the collaboration of a lot of people with expertise in different disciplines.

But let me come back to your main question, where we see the precedents of our work. One could say there were two parallel yet profoundly different ways of materially informed design in the twentieth century. One of them constitutes a line that investigates material systems and their capacity to become a collaborator or an accomplice in the design process. The other is more related to what has been called 'truth to materials'. Most emblematic for the latter is Louis Kahn's infamous asking the brick 'what it wants to be'. This approach is deeply rooted in typological architectural thinking. Thus, it does not come as a surprise that the response attributed to the brick is that of an idealised structural typology, so supposedly the brick 'wants to be an arch'. Here, material systems are conceptualised as derivatives of known tectonic or structural typologies. Purity and truth to materials become a measure of how close you resemble the idealised type.

In contrast to this, we see our work rooted in the former, more exploratory approach where material-oriented design does not reinforce established ways of design thinking, but is rather employed to challenge our preconception of known typologies and what architecture could be. And, obviously, you have named two of the most eminent figures in this field: Gaudí and Frei Otto. However, there are many others who have worked in a similar vein, Nervi, Dieste, and Candela, to name just a few. Instead of looking at materials from an idealist or essentialist perspective, here design is about a two-way communication process between material capacity, for example self-forming characteristics, and how the architect can act as a moderator in engaging material behaviour as one driver in the design process.

The computer seems to be particularly helpful in this kind of conversation and it allows us to go much deeper in understanding how we can unfold the design potential that is latent even in the most humble and common mater-

ials. This is similar to the way that the microscope or telescope enabled a better understanding of nature, simply because it allowed understanding at scales of observation and systems that were previously beyond human cognition and intuition. I think we try to engage the computer in a similar manner. We use the computational mode as an intense interface to the material in architecture, which allows us to engage materiality and materialisation as an active participant in the design process, rather than a passive receptor of predefined form.

BEESLEY It's interesting that you distance yourself from a stream that is dedicated to optimal forms. I'm reminded of Ernst Haeckel, the deeply problematic nineteenth-century researcher who, in understanding the forms of nature, also gave us eugenics and the idea of a master race. In spite of examples of gloriously beautiful pure platonic forms in contemporary work, I am curious about how computation can contribute to a vision that is not dominated by optimisation and purification. Your work does seem distinctly different. An early project that you showed at ACADIA was 'the informed matter aggregate structure' series. I recall you gathering together branching structures in massive numbers, pouring and observing their accretion in a beautifully empirical way, listening to what they would do. Can you comment on that kind of strategy?

MENGES The aggregate studies that we pursue at the Institute for Computational Design (ICD), mainly conducted by doctoral researcher Karola Dierichs, are indeed very interesting, because these designed granular substances are almost unique in combining the full adaptability and reconfigurability of fluids with the capacity to behave like a solid in certain configurations. This behaviour, which we usually only know from natural aggregates such as sand or snow, challenges our concept of what design entails. It challenges the still predominant concept of

architectural design based on representational techniques, geometric accuracy and assembly precision, and shifts the focus towards the observation of behavioural tendencies as well as the recognition and instrumentalisation of recurring patterns of material formation.

Aggregate architecture is an entirely different paradigm than the assembly architecture we are used to. In this way, referring to aggregate architecture, we can also touch on a second aspect of your question, the one about using computation as an optimisation tool. We've long abandoned that thought, as we don't believe that we can actually reach one 'equilibrium condition' of all acting design criteria that can be referred to as the optimum. In what Frei Otto called 'form-finding' methods, there was an underlying concept that such an equilibrium state physically exists, mainly because his studies were primarily concerned with structural forces.

We try to engage with systems that are fragile and are in a state of non-steady equilibrium in the sense that you have multiple forces or influences acting on them, not just structural criteria, and in that sense, there is no such thing as an optimum condition. One of the really interesting aspects about the notion of optimisation is that it is deeply rooted in a mechanical paradigm of engineering. That's why a lot of our work finds its conceptual roots in biology rather than in the history of technology. You may realise that the notion of the 'optimisation' of natural structures is something that only occurs from an engineering perspective on nature. In biology, they never talk about the optimum nor optimisation. Occasionally, they talk about something very different called 'temporal optimality', which is something you could also find in an architectural context, but the 'optimum' is very different from this kind of optimality.

Fundamentally, in nature there can't be an optimum because there is no goal. Evolution is an entirely open-ended process. In that sense, it's always temporal; snapshots of a lot of forces acting in an ecological interrelationship that produces the unfolding of materials, which we then perceive as a natural structure. One of the profound fascinations that we have with the understanding of biology is that it still produces systems and structures that are incredibly effective, not only in terms of the way they operate and the way they are fully embedded in their environment, but also in the way they morphologically unfold into a very particular gestalt. This is one of the intellectual challenges we are facing as we try to work towards a situation where we have multiple criteria interacting and unfolding design as a result of multiple, non-steady equilibria, while at the same time keeping the effectiveness we observe in biological systems.

We find this fascinating. It seems to promise that there is a way of reconciling a conflict that is emblematic for the contemporary condition of architecture, the conflict between resource efficiency and structural and material performance on the one hand, and architectural performativity on the other. By looking at natural examples, we can see that this discrepancy between performance and performativity is something that does not necessarily need to exist.

BEESLEY

If I were a design student hearing an elder encouraging me to let go of an optimised equation and instead, using the terms you have just described, to embrace a state that is far from equilibrium, I imagine that I might be disoriented. Your students seem to be acquiring new terms of reference that can help navigate such states. Perhaps ecology, embedded in the term you coined, morpho-ecologies, implies a set of values and a sense of viability. In the work you shared with ACADIA, you spoke directly about method, and you have been active in the

Fig. 1: Institute for Computational Design, Institute of Building Structures & Structural Design, Faculty of Architecture and Urban Planning, University of Stuttgart, ICD/ITKE Research Pavillion, Robotic Carbon and Glass Fibre Winding, Stuttgart, 2012.



Smartgeometry community where the focus on tools and enabling processes has been primary. What qualities and methods might guide an emerging designer?

MENGES You refer to the work that started already quite a while ago at the Architectural Association, which is concerned with ecology and morphology as something that is always inherently and inseparably related. This work is both an observation of some of the fundamental principles of living nature and a projection of how they could be engaged in architectural design. For example, one fascinating aspect you can observe in nature is a very high level of redundancy, but this redundancy generates robustness and adaptation. It's striking to realise that entire populations of organisms are capable of adapting to ecological shifts by employing phenomena that we rarely consider in design. A particularly striking example is what's called pre-adaptation, which refers to features that evolve in response to a particular influence or environmental pressure, but are ultimately recruited to serve a very different function. In other words, what might initially seem highly redundant actually generates the possibility to do something completely different over time. Obviously, the notions of robustness, redundancy and pre-adaptation offer an incredibly potent conceptual paradigm for design, as architects do need to provide for a vast range of spatial characteristics, human activities and societal shifts that are unknown at the moment of design – and this is only one example.

What we've done up to now is a very humble attempt to look at a limited range of material and structural systems. Even within this well-defined area of design research, we find that such ecological thinking in design computation can provide quite a significant shift in the way we look at things. There are different methods that we have spun off from this underlying design paradigm. Until now, we have only managed to develop some of them

to a relatively mature state. One example is the biological principle of 'materially-embedded responsiveness'. After many years of research, we recently synthesised this in our HygroScope installation for the permanent collection of the Centre Pompidou in Paris and the HygroSkin Pavilion for the FRAC Centre. There we managed to do what nature always does, which is to employ morphology to capitalise on innate material behaviour.

These projects utilise the hygroscopic and anisotropic characteristics of wood, which are very often conceived of as a deficiency of this material, which indeed makes it more difficult – or interesting, depending on your design attitude – to work with this naturally grown material. In fact, we can look back at a couple of thousand years of craftsmanship trying to suppress wood's inherent dimensional instability, developing artisan ways of preventing your parquet floor from becoming wobbly or your wooden drawer from jamming.

We try to do the opposite. We look at the way nature makes use of this material behaviour by employing the dimensional change to trigger a shape change, which always exists in an immediate ecological relationship with the environment because the moisture content of wood is always directly related to the ambient relative humidity level. The interaction between wood's cellulosic microfibrils and adsorption and desorption of water molecules from the surrounding humidity is what drives this basic behaviour, which allows physically programming the material so it becomes a climate-responsive skin. The simple skin elements, which combine the functions of sensor, motor and regulating device without the need for any additional mechanical or electronic equipment, do not even require a supply of energy to operate. It's such a strikingly simple, yet powerful principle that we are still wondering why nobody else tried to attempt something similar before us. If you look at the installations at

the Pompidou and the FRAC Pavilion, the material being used is probably one of the oldest and most common construction materials we have, but somehow by engaging intensely with the material's underlying cellular anatomy and related behavioural characteristics, we were able to employ computational design methods to inject it with a novel performance.

BEESLEY One of the intriguing things about your practice seems to be the way strength in complex computational analysis is combined with a basic feet-on-the-ground empirical observation. I look at the way something swells or cups and moves... Thinking of your earlier experiments of pouring and assembling simple ingredients, it would be interesting to hear your speculations on how robot machining and assembly is now contributing to the series. In the last two research pavilions, automated assembly seemed to be opening up very different qualities.

MENGES I think robots are interesting because they are fundamentally different from the previous generation of computer numerically controlled (CNC) machinery. In contrast to these machines, which are basically digitally controlled extensions of well-established processes, such as CNC-milling, CNC-sawing and so on, industrial robots are generic pieces of hardware that only become specific through control software and the choice of effector. We think this difference is profound because it enables digital fabrication to become intrinsic to design. In other words, designing the processes of materialisation becomes part of design itself. This goes far beyond the cliché of the digital chain. We don't think that employing digital machinery in a kind of linear manner, going from design to detailing to production, is particularly interesting. Instead, we think about processes of materialisation, which in architecture we tend to call fabrication, production, construction, etc., as an integral part of the explorative design process. In contrast to a linear concept of moving from cerebral design inten-

tion to physical realisation, we prefer to think about robotic fabrication as existing in a feedback loop with design. In this way, robots are not just the facilitators of preconceived design ideas, but are the particular affordances and characteristics of a fabrication environment that have become ecologically embedded in design.

In recent investigations, we researched the capacity of robotic fabrication to build up more continuous systems or structures in which a clear distinction between material, structure and form no longer exists. When we begin to think about such a high level of integration and continuity, the paradigm of fibrous composites offers intriguing possibilities. In nature, almost all load-bearing structures are actually composites. What's even more fascinating is that there are only four basic fibre materials from which the incredible diversity of natural structures unfolds: cellulose in plants, collagen in animals, chitin in insects and crustaceans, and spider silk. Nature has developed astonishingly varied yet highly effective ways of using this limited set of fibrous materials, and it is interesting to note that this has less to do with the actual material properties than it has to do with their directionality, orientation and arrangement in space. To quote George Jeronimidis, natural composites are successful not so much because of what they are, but because of the way in which they are put together. Thus, our recent work on robotic filament winding focuses on experimenting with an approach to composite structures in which the micro-scale of the material, the meso-scale of the system and the macro-scale of the resulting architecture is considered a continuum of reciprocal relationships that interact with the custom-developed robotic fabrication environment. Here, the robot becomes an interface between computation and materialisation, which makes it both a design driver and an enabler at the same time.

Figs. 2, 3: Institute for Computational Design, Institute of Building Structures & Structural Design, Faculty of Architecture and Urban Planning, University of Stuttgart, ICD/ITKE Research Pavillion, final installation, Stuttgart, 2012.





BEESLEY Could you retrace the last two ICD Pavilions, the exoskeleton of last year and beetle shell of this year?

MENGES These projects were intellectually quite challenging for us because they moderate two bottom-up design processes at the same time: One is the possibilities offered by the machine as a design driver, in this case, robotic filament winding processes, and second, the use of biomimetic design strategies, based on investigations conducted with biologists, that focus on how nature arranges fibrous materials in a hierarchical and highly differentiated manner to achieve performative structures.

For the 2012 pavilion, we were fascinated by the exoskeleton of the American lobster. If you've ever eaten lobster, you've experienced for yourself that the exoskeleton of the lobster is basically one piece, a composite of chitin fibres embedded in the protein matrix; however, this one material shows extremely different properties and characteristics. For example, the exoskeleton regions that connect the tail segments are very elastic and almost translucent, whereas the pincher and crusher claws are extremely stiff and strong. It is amazing to see that this differentiation of material characteristics results only from the arrangement and layout of the fibres and the composition of the matrix. So we were investigating how to extract the underlying principles of fibre distribution and orientation of the exoskeleton of the lobster and transfer them to the design of the pavilions.

Computation allows integrating the biomimetic principles and robotic fabrication possibilities in a generative design method that enables exploration on the architectural level. In the final pavilion, the shell is only 4 mm thick, and the transparent glass fibre and black carbon-fibre rovings really allow a perception of the logic of the differentiated fibrous organisation within the translucent envelope. The continu-

ously constructed materiality of the pavilion enables both a super-thin yet high-performance skin structure and a novel repertoire of architectural morphologies.

BEESLEY Methods of fibre placement had a special focus in the 2012 Pavilion. Could you describe the kind of tectonic that you are using this year?

MENGES In 2012, we explored composite shells as entirely continuous structures with locally differentiated fibre directionality, density and organisation. In the current project, we are investigating how we can use the technology developed, robotic filament winding on a minimal linear framework, for segmented composite shells. This research agenda resulted from the quite mundane experience that, despite its very low weight of just 320 kg, the 2012 pavilion with its 8-meter continuous span was impossible to transport, except maybe by helicopter. So this year, the size constraint for the composite modules is the loading volume of a truck, and we are trying to further develop the concept of mould-less winding by using two cooperating robots.

BEESLEY Achim, as we move towards the completion of this conversation, let me ask for your thoughts on design education. What are ways that young designers might draw together a cluster of disciplines in order to acquire the rather subtle languages that you describe? Several years ago, we heard a wonderful talk by Mark Burry in which he made a plea for architects to become 'numerate'. When he was describing his work on the Sagrada Família, it was implicit that there was a spirit behind it as well, a reverence and a sense of play amidst the efflorescence of forms that he had inherited from Gaudí. I recall him speaking about the disciplines surrounding creative exploration, suggesting that an architect should include integral calculus as a basic architectural craft. Can you speculate about the cluster of disciplines that your collaborators and students are investing in?

MENGENS This is an incredibly important question, and probably one that I cannot directly answer because what we are trying to do is, basically, explore how one can enable the next generation of architects to become more intellectually agile and at the same time, more sensitive in their interactions with other disciplines. This entails understanding their language and being literate in shared processes, such as computation. In addition, there are other aspects that I find important when engaging with multidisciplinary explorations. One is that, in order to work in an interdisciplinary setting, you need to bring in discipline-specific competences. This is something that I learned from my early days of teaching in the Emerging Technologies and Design program at the AA, where we actually had engineers, architects, designers, and mathematicians all working together. And it is an experience that continues to this day at the University of Stuttgart, where we are bringing together various disciplines in our Integrative Technologies and Architectural Design program.

In this kind of multidisciplinary context, fruitful dialogues can only occur if the deeply entrenched disciplinary preconceptions are challenged. There is also the question of whether there is a discipline specificity in the way different participants think about the design. I think this is a very subtle and intricate pedagogical challenge, because it requires you to engage in the productiveness of multidisciplinary situations, while also requiring a reframing of what disciplinary specificity is in this situation.

Within the specific collaborations that we try to form, we see that collaborative work, particularly with biology, is extremely interesting, as well as those disciplines that are closer to architecture, such as structural engineering, mechanical and control engineering, or computer science. However, it's really important to understand that architects bring a different

mode of design thinking into the process than these other disciplines. It's about moderating the different perspectives that then lead to something that no individual discipline may have found. However, it would be the wrong approach to think that multidisciplinary research undertakings or educational programmes should lead to a situation where the architect becomes the engineer, the mathematician or the computer scientist. I think one needs to be versatile enough and capable of 'speaking these languages', able to use related techniques and technologies with a certain level of proficiency, and have a sufficient understanding of the fundamental concepts. But in the end, it requires the disciplinary-specific design thinking of architecture, which in itself needs to be rethought in order to be fully capable of creatively engaging multidisciplinary. This definitely needs further exploration and is an enormous challenge for academia.

BEESELEY Thank you Achim, I've thoroughly enjoyed this conversation.

Fig.1: Custom forming tool mounted on the six-axis robotic arm.

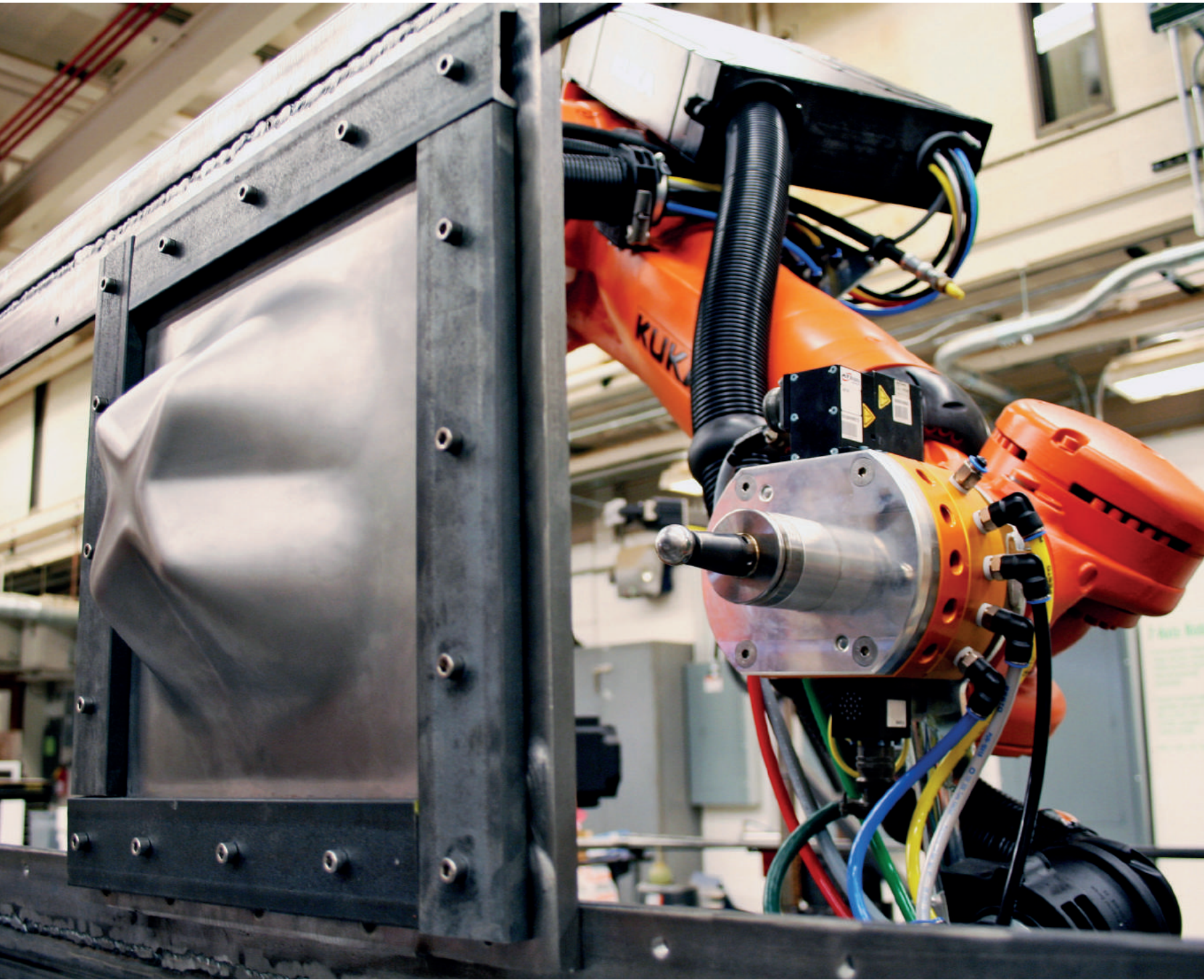

PERFORMING: EXPLORING INCREMENTAL SHEET METAL FORMING METHODS FOR GENERATING LOW-COST, HIGHLY CUSTOMISED COMPONENTS

AMMAR KALO, MICHAEL JAKE NEWSUM, WES MCGEE

Building on previous and current work, this research utilises the Single Point Incremental Forming (SPIF) process to produce mass customised, double-curved (both positive and negative Gaussian curvature), three-dimensional forms from sheet metal. These forms are produced at a scale that suggests their use as cladding elements in a building envelope. This, combined with the relative speed and efficiency of production and the variability of resultant geometries, allows for speculation on the production of high performance façade systems directly from digital models.

INTRODUCTION

Craftsmen have skilfully perfected the laborious process of turning flat sheets of metal into fully formed three-dimensional objects; be it a traditional Japanese tea kettle, an intricate Islamic lamp, or many other everyday objects. Among the most recent manufacturing advancements, incremental sheet forming stands out as a process with great potential for new architectural, formal, and structural expression. Contemporary research has primarily focused on refining this process by dealing with issues such as springback and increasing the accuracy of the resultant panel relative to the digital model.¹

Building on previous and current work, this research utilises the Single Point Incremental Forming (SPIF) process to produce mass customised, double-curved (both positive and negative Gaussian curvature), three-dimensional forms from sheet metal. These forms are produced at a scale that suggests their use as cladding elements in a building envelope. This, combined with the relative speed and efficiency of production and the variability of resultant geometries, allows for speculation on the production of high-performance façade systems directly from digital models.

MATERIALS AND METHODS

SINGLE POINT INCREMENTAL FORMING PROCESS

Single point incremental forming is a process whereby a sheet of metal is incrementally deformed at local points to achieve an overall geometry. Typically, the stock is formed using a round tool (fig. 1) that can be attached to a robotic arm or a CNC machine. The tool moves along a programmed toolpath, as it gradually steps down into the stock, until forming is complete (fig. 2).

Precise articulation using SPIF can be achieved by incorporating multiple toolpaths in the forming process. Forming in multiple passes has two results: it allows an initial work-hardening level to be reached and reduces relaxation from springback. Digital scanning of the resultant panels after each forming step revealed a dramatic increase in the accuracy. With the first pass, the overall volume is shaped. The second pass removes most of the elastic deformations throughout the volume and brings the output closer to the digital model. This is important because the first pass causes work hardening, which results in a less elastic and more plastic material.

The benefits of using multi-pass forming are not only limited to improving resultant accuracy, it also allows a secondary structuring or ribbing of panels to be introduced. This is

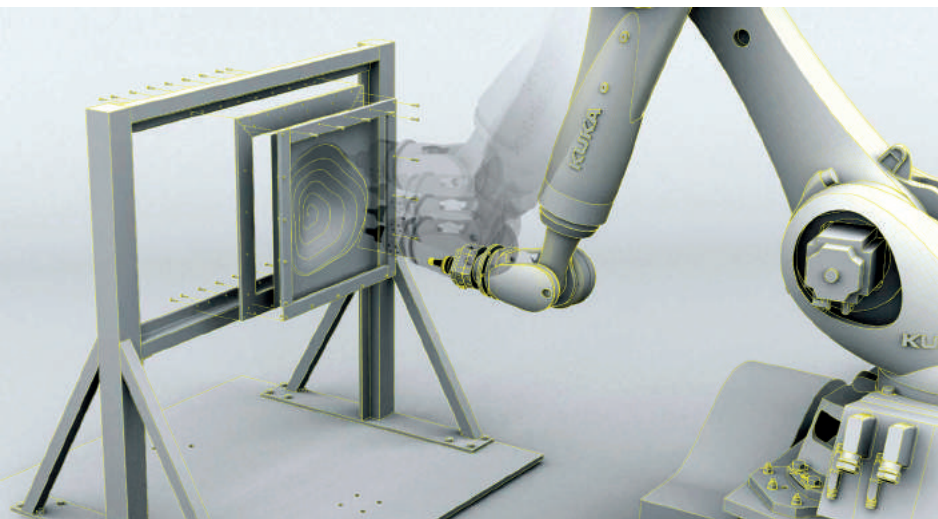

Fig. 2: Single point incremental forming set-up and process.

analogous to ‘progressive die-stamping’, but in this case the only additional cost is time, as opposed to the considerable cost of additional moulds for each panel to be formed.

MATERIAL TESTING METHODOLOGY

Single point incremental forming has the ability to form many types of sheet metals. To test the limitations of the forming process, incrementally angled cones were formed in order to understand the potential slope and depth ranges for each material at various thicknesses and alloys.

As the material is stretched, its thickness is redistributed locally around the contact point of the tool on the sheet. Once formed, test pieces are cut in half, so that the varying thicknesses of the resulting section can be measured. This allows for a numerical representation of the material’s change and an understanding of the material’s breaking point.

A variety of materials, including stainless steel, copper, and brass, have been tested for viability with the incremental forming process. The stainless steel tests failed due to galling between the metal and forming tool. While cold rolled steel and brass showed little signs of local material stretching, hence making it harder to predict tears, copper and aluminium clearly displayed signs of wear before failing. The softer alloy of aluminium, Grade 3003-H14, was tested with thicknesses ranging from 0.635 mm to 1.270 mm. Due to the microstructural properties of aluminium, the tests showed a higher chance of rupture at angles greater than 45 degrees. The areas formed on

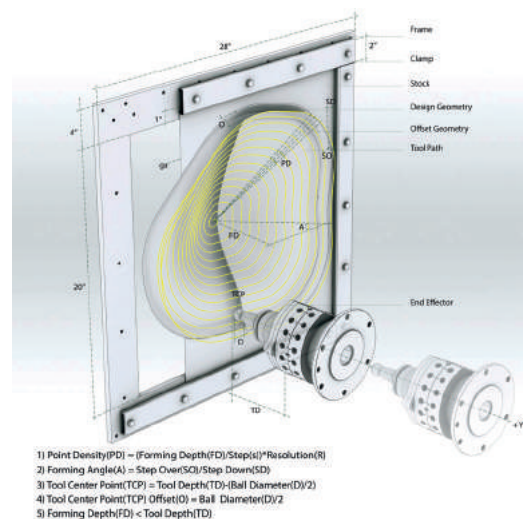

Fig. 3: Basic principles for the parametric toolpath programme.

aluminium show clear stretch marks on the back of the panels, indicating eventual rupture of the surface as a result of forming beyond its ultimate tensile strength.

Cold rolled steel sheets of thicknesses 24 ga to 18 ga were tested by the cone forming process as well. Steel’s high ductility allowed for much deeper forming in addition to more extreme angles, resulting in more controlled complex volumes. Increasing the sheet thickness allows for deeper surfaces to be formed by providing more material to stretch; this comes at the expense of requiring higher forces for forming. From the steel sheet tests, 20 ga was selected for continued research because of the increased depth, angle, and detail performance as well as the reduced springback exhibited. Once control was achieved in the deeper forming processes, the methods were used to achieve specific geometries as panel tests transitioned to prototypes.

TOOLPATH GENERATION

The forming process required the development of a parametric toolpath generator. A series of digital tools were designed that could translate the desired form into paths that could drive a robotic arm (fig. 3). Depending on the form, different combinations of these paths were used.

For the simple geometries, including bowls and cones (generalised positive Gaussian curvature), contours through the surface could be used to generate a spiral via a script that was developed. Once the designed forms were no longer radially

symmetrical, the script was modified to maintain a continuous step down in the forming process. This added calibration for the spiral was needed in order to preserve the flat centre of the stock until it is formed. The continuous step down toolpath was completed with the addition of a bezier graph control, allowing for a dynamic step down and reducing the step height according without disturbing the flat stock in the centre of the blank.

As the geometries became more demanding, including combinations of convex and concave surfaces, new toolpath generation strategies were developed. For geometries with largely divergent valleys, topographical contours were used, sorted by depth from the initial flat panel. This allowed for each valley to be formed progressively without any of the flat centres being disrupted. The topographical contours posed a unique prob-

lem where each step down was an individual closed curve, resulting in a 'seam' that compounded into a pleat in the surface, causing resistance on the forming tool. These issues were resolved by adding lead-in and lead-out motions in the script, as well as a randomising of the position of the start point of each contour to evenly distribute the occurrence.

Forms with multiple valley textures across a global geometry could be formed by a projected spiral toolpath that was developed as a secondary pass after the continuous step down spiral-forming path. With this process, the first pass would form the overall curvature while maintaining the level centre until all of the stock is formed, then the projected spiral can articulate each additional valley on the global surface without the constraints of the flat centre stock (fig. 4).

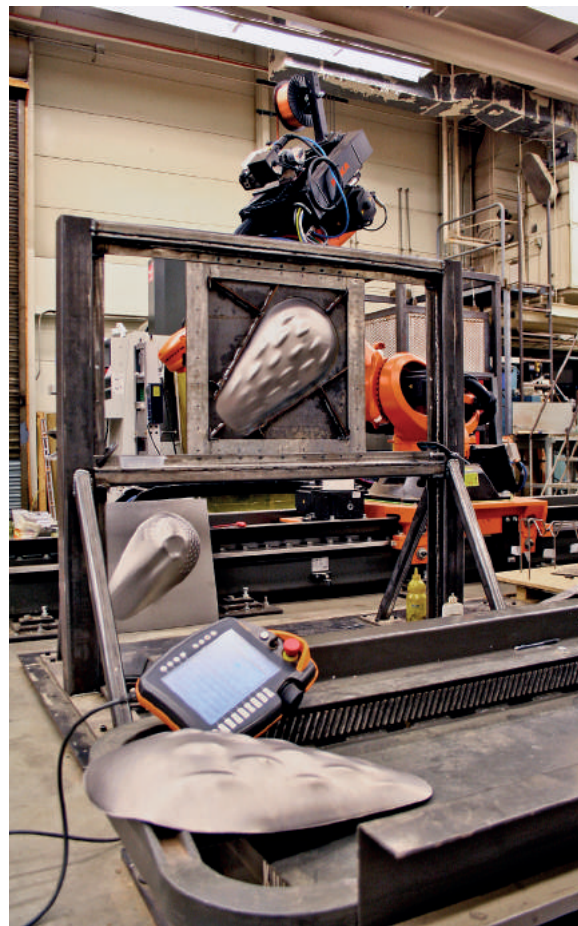
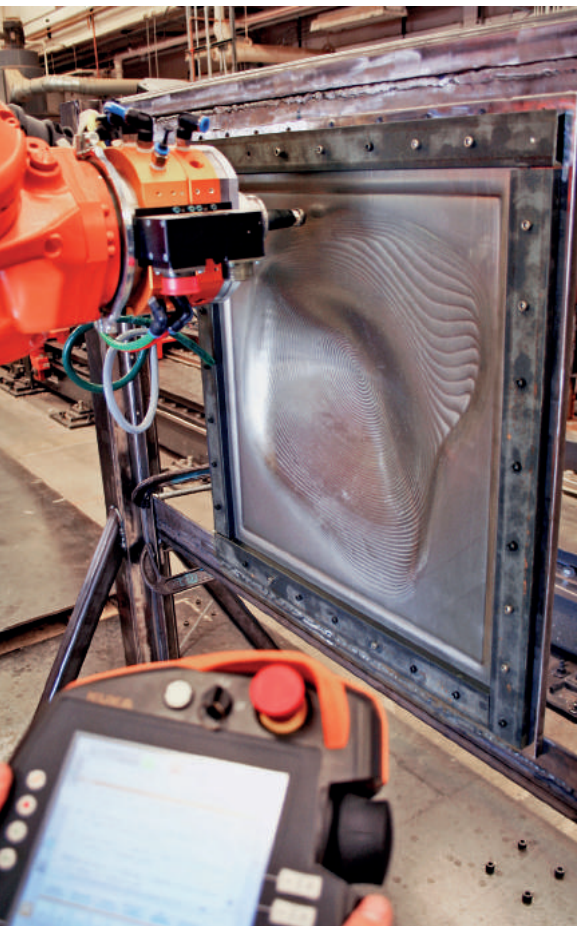

Fig. 4: (left) Forming a singular valley.
(right) Multiple valleys in one panel.

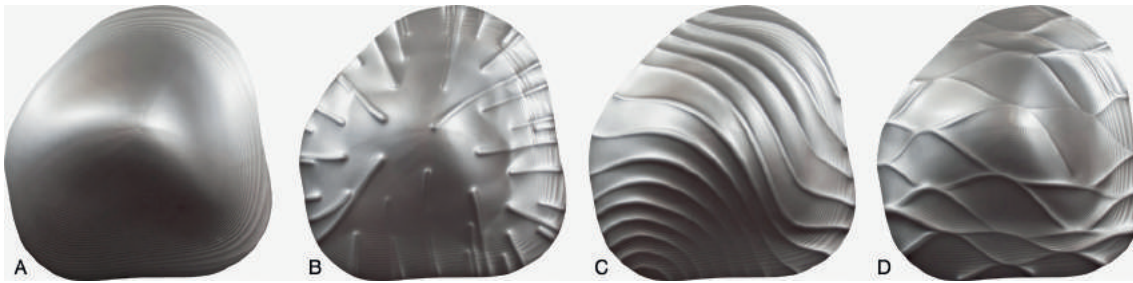

Fig. 5: a) Original geometry. b), c), and d) 'Ribbed' geometry.

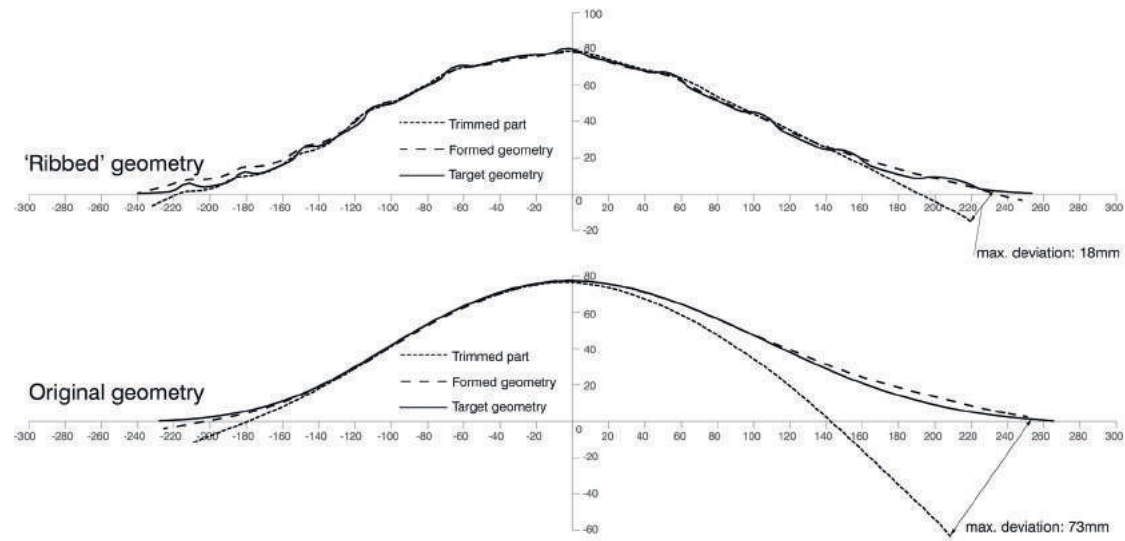

Fig. 6: Evaluation of the geometry before and after trimming.

SECONDARY STRUCTURING

Geometries which have high variability in the local radius of curvature, especially those areas of relatively low curvature, benefited from a secondary step of adding 'ribs' to the surface (fig. 5). Formed parts within the sheet metal panels maintain their geometry due to the support material holding the perimeter. Trimming the shapes from the stock releases internal stresses and causes the metal to deform, altering the overall geometry. Similar to bead rolling, adding ribs serves to locally corrugate the sheet metal where the geometry is the most shallow to prevent it from deforming. In addition to providing a unique formal opportunity, the ribs also have the potential for driving the global connection and alignment of panels. Furthermore, the ribs could drive a global panel connection strategy. Further research will focus on determining the proper distribution and orientation of ribs to best stabilise the formed panel.

VALIDATION

To validate the results of the secondary structuring method, a single test geometry was used four separate times, each time with a slight variation in the secondary pattern applied. One mimicked the geodesic curves of the geometry, the other vertically traversed across the surface bundling where most needed, and the last added a gridshell-like ribbing to the geometry to stabilise the form in more than one direction.

All four panels were digitally scanned before and after trimming the forms from the stock. When compared with the digital models, the formed geometries were comparatively close in their overall shape while attached to the stock sheet. Once trimmed, the panels were scanned again and reviewed side by side with the digital models and the post-forming panels. The results clearly show a significant change (as much as 73 mm) between the original plain panel and the three ribbed parts (fig. 6).

Fig. 7: Self-structured thickened porous skin.



Fig. 8: Self-structured skin, initial design proposal.

AGGREGATION

The majority of previous research on SPIF revolves around improving the predictability and accuracy of resultant panels. This investigation seeks to build on that work by addressing questions that are essential to its applicability at an architectural scale, notably the ability to aggregate multiple panels into a panelised system. Various strategies were explored for connecting formed panels into a larger group. One technique overlapped the valleys and peaks of doubly curved surfaces and then tack-welded the surfaces together to create a self-structured thickened porous skin (figs. 7, 8).

The inaccuracies of this system led to the development of corrugations added to the surfaces as ribs. These ribs were then used as identification points at the edges of panels to align the aggregation. Geometries were also developed that shared the same edge perimeter geometry (fig. 9). This allowed for varying shapes to be formed within this boundary that could be

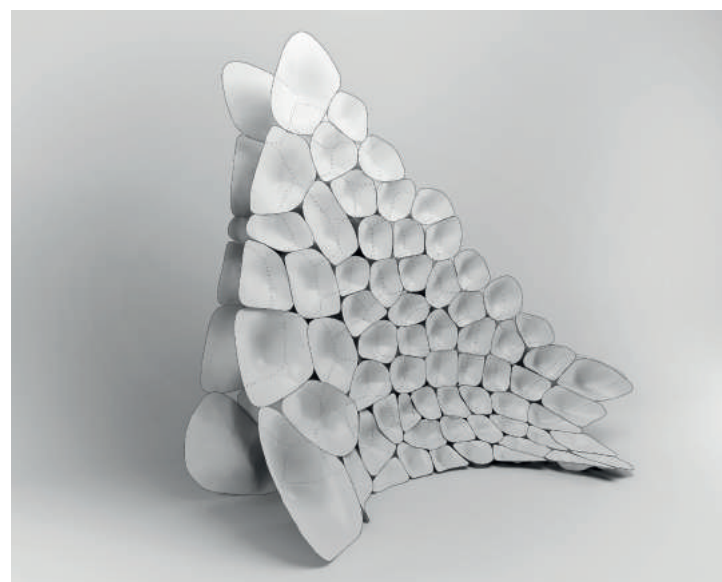



Fig. 9: An assembly of panels with continuous performative 'ribs'.

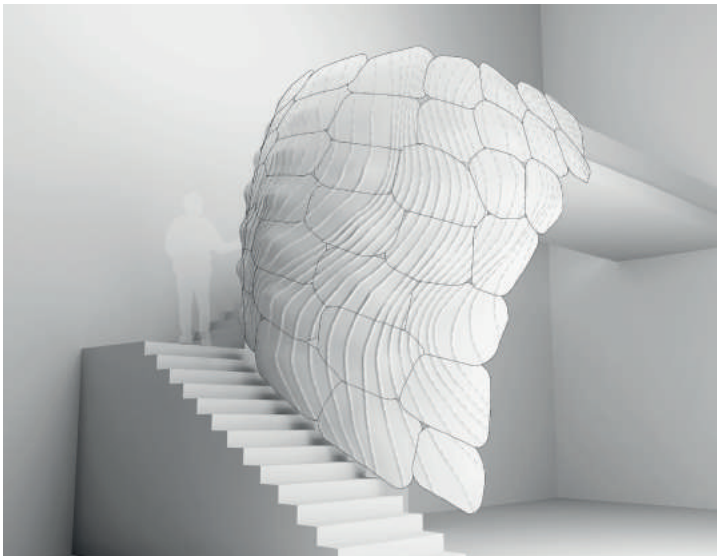

Fig. 10: A proposal for an aggregated interior skin formed with performative ribs.

Fig. 11: Micro 'bumps' and micro 'ribs' illustrate detailing potential.



connected to one another as a closed object (fig. 10). The precise architectural implications of these forming and connection strategies are currently being further explored (fig. 11).

DISCUSSION

These forming methods are opening up new avenues of formal construction, but their use must be rigorously studied so as not to simply produce architectural artifice. Projects like Skylar Tibbits' VoltaDom² and Marc Fornes's nonLin / Lin Pavilion³ are formidable examples of sheet metal manipulation to achieve complex free-form surfaces. Both projects are innovative in their application of surface rationalisation and discretisation techniques to achieve structurally efficient envelopes. Incremental forming techniques provide an additional tool by which to produce large-scale, double-curved surfaces efficiently. From the perspective of stiffness to weight, panels formed with intrinsic double curvature promise to dramatically exceed the performance of ruled and developable geometries, which gain stiffness only through aggregation techniques. While there are other methods more suitable for producing double curvature for large numbers of repeated elements, only incremental forming techniques can provide the high variability necessary for contemporary parametrically designed envelopes in a cost-effective way.

One of the aims of this research is to gather an understanding of both the potentials and limits of the forming process in order to establish a set of guidelines for designers. Like many of the processes being investigated in contemporary architectural research labs, incremental sheet forming benefits from a highly integrated protocol from design to material production. By incorporating the entire process including design, toolpath generation, and machine simulation into the digital modelling environment, designers are able to rapidly iterate within a closed-loop design space of validated results.⁴

CONCLUSION

This project demonstrates a number of proof-of-concept studies for single point incremental forming as a viable technique to produce highly variable, double-curved panels in sheet materials, without the requirement of expensive forming dies. The project also provides a model for the development of a materially informed production process, integrating design and fabrication into a streamlined production methodology. Further work will focus on understanding and developing the geometric typologies necessary to improve the performance and efficiency of panels. While the use of double-curved sheet

metal panels has long been in the vernacular of the automotive industry, the understanding of its performative capabilities at the architectural scale have been limited due to the high cost of variability. While this work leaves many questions unanswered, it serves to introduce concepts that will be fundamental to further investigations, with the hope of ultimately providing a viable technique for mass customisation in façade construction.

NOTES

1 For example: Sebastien Thibaud, Ramzi Ben Hmida, Ferriere Richard and Pierrick Malécot, 'A Fully Parametric Toolbox for the Simulation of Single Point Incremental Sheet Forming Process: Numerical Feasibility and Experimental Validation', in *Simulation Modelling Practice and Theory*, 29 (2012), pp. 32–43; Markus Bambach, Babak Taleb Araghi and Gerhard Hirt, 'Strategies to Improve the Geometric Accuracy in Asymmetric Single Point Incremental Forming', in *Production Engineering*, 3/2 (2009), pp. 145–56; Horst Meier, Stefanie Reese, Yalin Kiliçlar and Katja Laurischkat, 'Increase of the Dimensional Accuracy of Sheet Metal Parts Utilizing a Model-Based Path Planning for Robot-Based Incremental Forming', in Berend Denkena and Ferdinand Hollmann, eds., *Process Machine Interactions* (Berlin: Springer Verlag, 2013), pp. 459–73.

2 Skylar Tibbits, 'VoltaDom', in *SJET*, accessed March 2013, http://www.sjet.us/MIT_VOLTADOM.html.

3 Marc Fornes, '11 FRAC CENTRE', *The Very Many*, accessed March 2013, <http://theverymany.com/constructs/10-frac-centre/>.

4 For example: David Pigram and Wes McGee, 'Matter and Making', in Ruairi Glynn and Bob Sheil, eds., *Fabricate: Making Digital Architecture* (Cambridge, Ont.: Riverside Architectural Press, 2011), pp. 74–85; Tobias Schwinn, Oliver Krieg, Achim Menges, Boyan Mihaylov and Steffen Reichert, 'Machinic Morphospaces: Biomimetic Design Strategies for the Computational Exploration of Robot Constraint Spaces for Wood Fabrication', in Mark Cabrinha, Jason Kelly Johnson and Kyle Steinfeld, eds., *Proceedings of the 32nd Annual Conference of the Association for Computer Aided Design in Architecture (ACADIA)* (San Francisco), pp. 157–68.

Fig. 1: REX|LAB at the Bartlett School of Architecture, demonstrating the material process of stretching soft foam into self-supporting filamentous structures. Event: Robotic FOAMing, Smartgeometry 2013.



(FR)AGILE MATERIALITY: APPROXIMATING UNCERTAIN FABRICATION PROCESSES

KADRI TAMRE, MARJAN COLLETTI, GEORG GRASSER, ALLISON WEILER

This paper discusses research that explores the potential of digital fabrication through the use of robotically controlled processing of phase-change polymers in the production of porous, filamentous and fibrous structures. It investigates the complex material behaviour of such phase-change materials while combining generic robotic manipulators, custom end effectors and optimising the performance of the resulting structure through physical–digital feedback. This research is exemplified in a 1:1 scale structural prototype which is used to explore the aesthetic, structural and material possibilities discovered during the early research phase. As case studies, adaptive approximation strategies are tested for gaining control over the fabrication process.

BACKGROUND AND MOTIVATION

Some of the most relevant research in contemporary architecture is targeted at the translation of digital aesthetics, be it formal exuberance, geometric complexity or parametric ornamentation, in architecture. By rethinking real and physical processes of design and fabrication, architecture itself has performed a U-turn from cyber world to material truth and parametric certainty as the core functions of design.¹

In a contemporary debate, materiality as a driving force of innovation is possibly reflected in a post-cyber, post-virtual, post-fluid and post-digital paradigm shift towards an era of real-world physical production based on evolving processes including file-to-factory protocols, material science and biotechnologies. By integrating the material basis of architecture with computational practice through digital fabrication, the ambition of this research is projected towards innovative applied theories, techniques and technologies.

(Fr)Agile Materiality² presents an experimental design research that tries to bridge the gap between basic research undertakings and testing by way of full-scale experiments. It investigates the workflow of combining material performance and manipulation with robotic fabrication (fig. 2). This project was conceived by REX|LAB,³ with support from bachelor's



Fig. 2: (Fr)Agile Materiality as a driving force for experiments in architectural design and digital fabrication processes. Event: Robotic FOAMing, Smartgeometry 2013.

and master's degree students at the University of Innsbruck's Institute for Experimental Architecture, by RoboticFOAMing⁴ cluster participants at the Smartgeometry Conference in London (fig. 1), by participants and collaborators of Architecture Challenge 2013⁵ workshop at the University of Applied Arts Vienna and by the participants of the Responsive Robotic Materialisation workshop in Estonia. Since the launch of REX|LAB and during the introductory phase of operating a synchronised three-robot set-up, a series of experiments took place that investigated the potential of hybrid, analogue and robotic fabrication methods and techniques. Different phase-change materials and fabrication methods were explored, including three-dimensional deforming of thermoplastics, composite materials and plywood, utilising commercially available boards; producing intricate wax structures with a pouring process in a water basin; processing amorphous substances like sand and fixing the structures by casting; moulding soft and elastic materials by simultaneous implementation of external forces with different end-effectors.

Challenging current production methods was the starting point for developing adaptive, dynamic and efficient means for constructing custom material formations. In this context, the interests lie in fabrication processes that are not predetermined. Material properties, environmental effects and structural properties become a constitutive part of the design task in which the material informs and is informed through and by

fabrication processes. The basis for the design concept lies in fundamental experiences in learning to control first the material, then the digital fabrication processes and finally gaining explicit control over the manufacturing of architecture.⁶

INDIRECT CONTROL — THE GAP BETWEEN REALITY AND EXPECTATION

The main experiments are aimed at the translation of the rigid ideal of computational design space into the soft reality of an uncertain built environment as mediated by the generic technology of industrial robotic work cells. In this case, whilst the industrial robots can precisely translate the digital geometry, the final form is in fact characterised by the uncertainties of the soft material's behaviour. The resulting artefacts emerge from various parameters: the integration of the precise fabrication devices, the imprecise material behaviour, the environment, and a feedback loop between the computational systems as a series of physical design experiments. These circumstances require an open dialogue between design methodologies and fabrication processes. The material's self-organisational properties prevail over the generation of geometry. The designer's domain to directly control form is negotiated between material and the fabrication process. Eventually, it is all these characteristics of specific materials, tools and design that are defining architectural language today.

As a method of exploration, a series of speculative prototypes were constructed, with the intent of studying the achievable variety of material properties and configurations, and of incorporating the parameters of speed and time into a generative design / fabrication process (fig. 3). Crucially, this developed material process begins to speculate on fabrication scenarios that distance themselves from current linear file-to-factory-based methods and industrialised production modes. It introduces novel potential for creatively exploiting and exploring the uncertain gap between digital modelling protocols or expectations and the realisation in physical space. According to Willmann et al., 'The "operationality" of the robot is not related exclusively to the material act of producing ... but rather equally to the way architecture is intellectually conceived, programmed and designed'.⁷ The precise abilities of the robots correlate with the very uncertain geometrical conditions entailed in the foam expansion process (fig. 4). This intuitive material behaviour enriches the digital precision, resulting in artefacts with a unique aesthetic design (fig. 5).

Fig. 3: Catalogue of different ornamental formations with variable material mixture. Event: Robotic FOAMing, year-1 students at the Institute for Experimental Architecture, Hochbau, University of Innsbruck. (Photos: Anne Steinkogler, Marjan Colletti.)

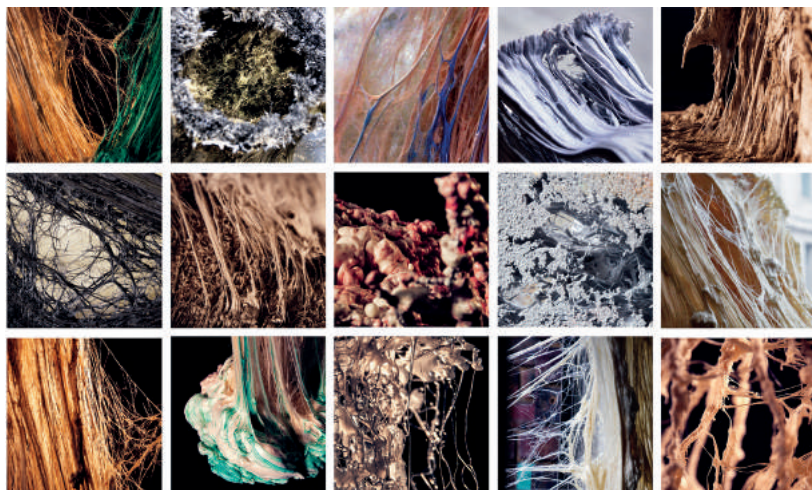



Fig. 4: Geometrically precisely defined design strategy translated into fully controlled robotic movements and reacting with loosely controlled material mixture results in unpredictable morphogenetic behaviour. Event: Robotic Infiltrations, Architecture Challenge 2013. (Image: REX|LAB.)

Fig. 5: Catalogue of different geometrical formations with the same material mixture; separate fabricated elements necessary to assemble the final structure. Event: Robotic Infiltrations, Architecture Challenge 2013. (Photos: Matthias Urschler, Kadri Tamre.)





Fig. 6: Material mixture: depending on the desired result, the additive components include modelling plaster, water, hardener and colour pigments. Event: Robotic FOAMing, Smartgeometry 2013.

MATERIAL SELF-ORGANISATION, MIXTURE AND TIMING

The specific potential of phase-changing polymers has been explored in order to create structural systems that directly express the inherent static forces in the system. These almost instantly created networked structures present a formal resemblance to the morphology of self-organisational biological systems as observed in nature. As Oxman and Hanna state, 'In nature there is no separation between modelling, analyses and fabrication, and there is constant feedback between them.'⁸ This aesthetic was exploited as a design driver in the development of robotically produced structures that exhibit optimised material placement, while embracing the natural variability within the material system itself.

Foam as an agile, malleable and soft material was investigated by this research. Mixed with additives, such an unstructured mass can be stretched into stiff yet light, filamentous, porous and fragile structures. Although its behaviour is complex and foam is typically considered a weak material in architecture, its good thermal and lightweight properties have potential to be explored further. Polyurethane foam was selected, not only due to its uncertain material nature, but because of the opportunity to manipulate its transitional phase-change state.

The material process starts with the liquid mixture, developed in a process of learning from and improving physical experiments, which is constantly stirred until it becomes viscous and starts forming filaments when stretching (fig. 6). If the fabrication process is started at an earlier moment, the re-

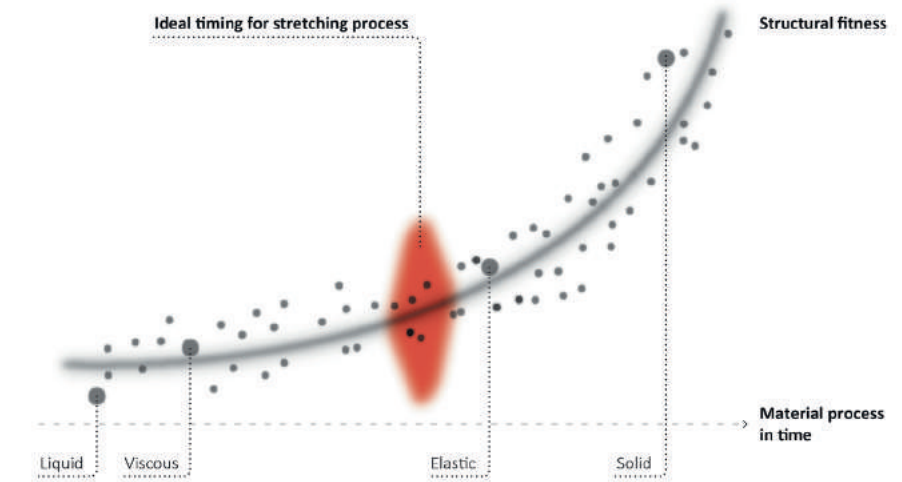

Fig. 7: Material process of phase-changing and timing of the fabrication process. (Image: REX|LAB.)

sult will be more filamentous and very fragile. During a short amount of time (roughly one minute), the stretching process will yield the most optimal results in terms of structural performance and aesthetical qualities (fig. 7). If the fabrication process is started at a later point, the result will be more solid and will perform better under compression. If the process is started too late, the material mixture will be too elastic and will resume its shape after stretching attempts. Failing to recognise the exact moment for action as well as changes in external environment (i.e. temperature, humidity, etc.) may result in the failure of earlier successful identically measured and mixed material compounds. Changing the mixture itself by adding agents to increase the viscosity in the soft phase and the stability in the hard phase, or colour pigments to directly control the appearance, is the other primary way to manipulate the properties of the manufactured pieces. It follows that a precise correlation between the time management for the fabrication process and the material process is required in order to produce elements with successful structural and aesthetic qualities (fig. 8).

As expected, the simultaneous switching between material and digital environments required extensive physical experimentation. Constant quick testing and adjustments eventually responded to emerging material properties and changing design requirements. For these applications, custom end-effectors (consisting of simple arrangements of wooden and thermo-plastic boards) were designed, built, evaluated and improved in relation to the machines and material characteristics.

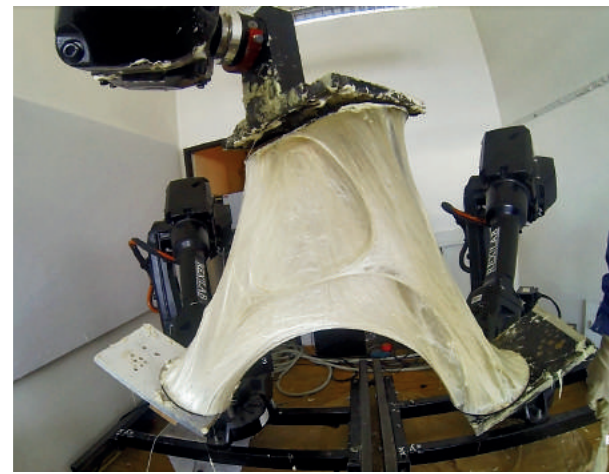
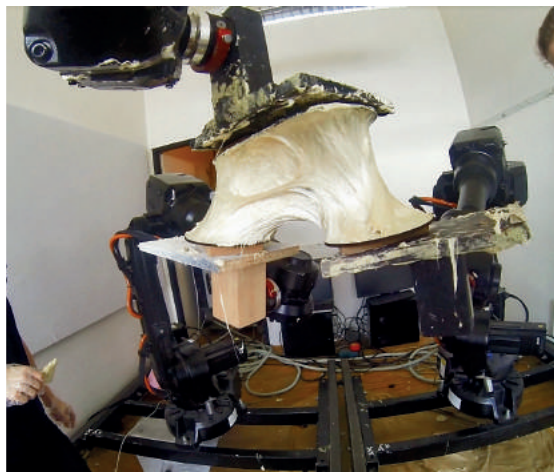
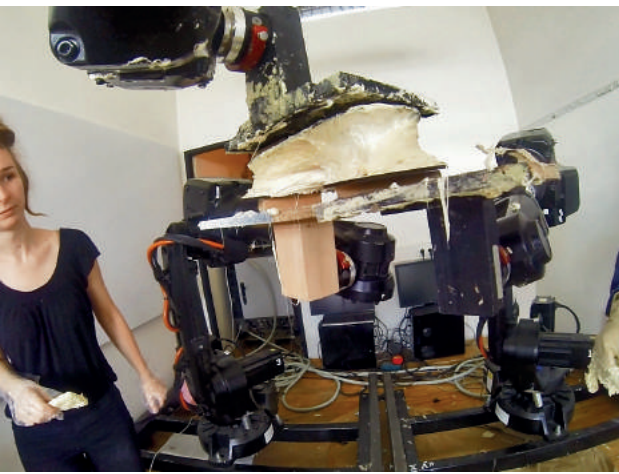

Fig. 8: The process of stretching the material mixture into a self-supporting filamentous foam structure completed with multi-directional manipulation. Event: Robotic Infiltrations, Architecture Challenge 2013. (Photos: REX|LAB.)



FULL-SCALE PROTOTYPE

The 1:1 prototype, realised at the Robotic Infiltrations workshop (fig. 9), concluded the first phase of research. The aim was to create a spatially diverse and architecturally challenging self-supportive structure working under the combination of tensile and compression forces. It had to be realisable within a 10-day workshop context, with the constructive material fabrication process integrated into the design concept. The result is a unique architectural object with a footprint of 4.6×5.5 metres that stands approximately 6 metres tall. It contains 14 stretched foam nodes, each fabricated in two parts, made out of 28 cans of polyurethane foam with additive components. The nodes were connected with 36 polyethylene tubes with a diameter of 63 mm and a total length of nearly 42 metres.

The architectural site (the courtyard at the Academy of Applied Arts in Vienna) defined the suspension points on a moveable rack. The supporting points on the floor were specified locally by taking into account the best combination of internal forces in the structure. Possible connection lines between these points were optimised for internal bending moments (the preliminary structural testing demonstrated special weakness towards bending, however, strong tension abilities in the expanded material were observed (fig. 10) using Karamba⁹ in combination with the Galapagos Evolutionary

Fig. 9: Proof-of-concept, full-scale prototype demonstrating the structural, aesthetic and spatial properties of the developed process. Event: Robotic Infiltrations, Architecture Challenge 2013. (Photo: Matthias Urschler.)



Fig. 10: Structural testing of the mock-ups revealed a strong tension ability of the expanded material. Event: Robotic Infiltrations, Architecture Challenge 2013. (Photo: Matthias Urschler.)

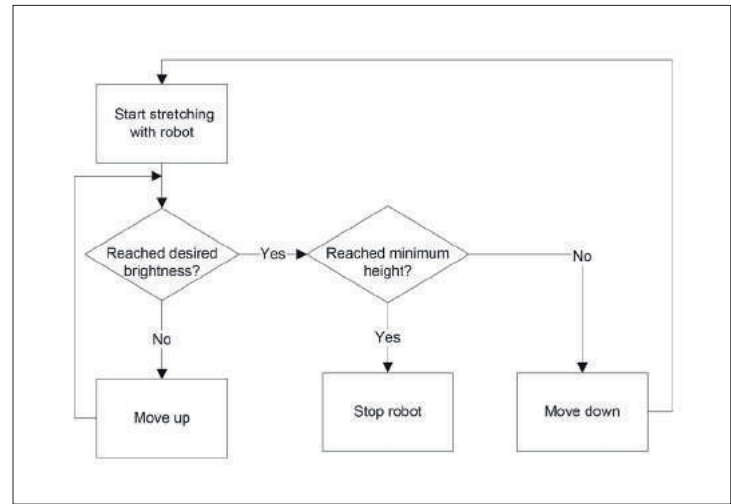

Fig. 11: External sensorial inputs integrated into form-generating algorithms that connect real-time material behaviour and digital computation. Event: Responsive Robotic Materialization Workshop, Estonia 2013. (Image: REX|LAB.)

Solver. A Grasshopper definition was developed to extract 4-point nodes and 2-point connections from the final three-dimensional network. HAL Robot Programming & Control plug-in¹⁰ for Grasshopper was used to compute specific tool paths for the three robots and automate the production.

The materials properties are considered intrinsic to the design and fabrication process, therefore the connectors produced operate under minimal torsion, but both tensile and compression forces, leaving the entire structure partly hanging and partly carrying its own weight, which is approximately 50 kg. This prototype made it possible to test a full-scale additive manufacturing strategy with the selected material and fabrication process.

FABRICATION PROCESS DEVELOPMENT AND APPROXIMATION

The self-organisational behaviour of the developed material mixture is highly complex and difficult to predict. The aim to get ultimate control over various initial environmental, material and fabrication parameters is therefore an insufficient approach. By taking environmental conditions as given, the ongoing fabrication process needs to be responsive. Therefore, new parameters of evaluation (density, luminosity, compression, tension, etc.) are established and the generated data is processed in real time (fig. 11). Through constant feedback of the current processing state, more optimal solutions can be explored. Following this principle, at the Responsive Robotic



Fig. 12: Feedback on internal forces to predict material failure. Event: Responsive Robotic Materialization Workshop, Estonia 2013. (Photo: Markus Brandtner.)

Materialisation Workshop, various strategies were developed and iteratively tested (fig. 12). In this multilayered fabrication process, emerging geometry and pulling forces are able to describe structural performance or determine material failure. Creating a system of continuous and adaptive evaluation is an approximation strategy that aims to gain control over this uncertain fabrication process – taking into account the existing conditions and reacting to them.

CONCLUSION AND FUTURE RESEARCH

When its transitional phase-change state is manipulated and the fabrication process is timed, foam becomes more than a soft material. The controlled processing of phase-change polymers leads to unexpected material behaviour and resulting geometries. The current research proposes a formal system of filamentous, fibrous and porous structures emerging from custom material processes and the workflow between the virtual and the tactile. This includes simulations and external sensorial inputs that are computed and reintegrated into form-generating and/or control algorithms that connect the real-time material behaviour and digital computation.

Future investigations will consider the advantages of the enormous geometric potential offered by digital design tools and technologies to apply ornamentation, geometry and texture on larger prototypes that test real architectural performance in structures with built-in intelligence. Potentially, this could escape from the environmentally as well as financially unsustainable, virtual and cyber-architectural production methods of the past and introduce adaptive, dynamic and efficient means for constructing custom sensuous and high-performance material formations.

NOTES

- 1 Marjan Colletti, 'Protorobotic FOAMing', *Archithese*, 3 (2013), pp. 54–7.
- 2 The conscious use of the term 'fragile' can be traced to the essay 'Protorobotic FOAMing – The (Fr)agile Beauty of Architecture' where it incorporates openness, dynamism and hybridity – all terms that imply or require fragility. Furthermore, fragile includes the term 'agile' – whose meaning suggests responsiveness and alertness. Colletti 2013 (see note 1).
- 3 REX|LAB is a robotic experimentation laboratory at the University of Innsbruck, in operation since October 2012, consisting of three six-axis ABB IRB 2600-20/1.65 industrial robots with a payload capacity of 20 kg that are installed in a transportable multi-move set-up that allows synchronised motion with all 18 combined axes (one of the first multi-robot set-ups to be integrated in an architecture school), <http://www.exparch.at/wiki/index.php/Portal:REX|LAB> (accessed 15 July 2013).
- 4 The Smartgeometry Robotic FOAMing cluster was run in April 2013 by Marjan Colletti, Georg Grasser, Kadri Tamre and Allison Weiler. For more information, see http://smartgeometry.org/index.php?option=com_community&view=groups&task=viewgroup&group_id=38 (accessed 15 July 2013).

- 5 The Architecture Challenge program is an international design workshop series in collaboration with international experts and institutions at the University of Applied Arts Vienna. Architecture Challenge 2013, Robotic Infiltrations, took place from 28 June to 7 July 2013 and was run in collaboration by Andrei Gheorghe, Georg Grasser, Kadri Tamre, Thibault Schwartz and supported by engineers from Bollinger-Grohmann-Schneider ZT GmbH Vienna. <http://www.architecturechallenge.org/> (accessed 15 July 2013).
- 6 Matthias Kohler and Hanif Kara, 'Q&A', in Ruairi Glynn and Bob Sheil, eds., *Fabricate: Making Digital Architecture* (Cambridge, Ont.: Riverside Architectural Press, 2012), pp. 115–23.
- 7 Jan Willmann, Fabio Gramazio, Matthias Kohler and Silke Langenberg, 'Digital by Material', in Sigrid Brell-Cokcan and Johannes Braumann, eds., *Rob|Arch 2012 – Robotic Fabrication in Architecture, Art and Design* (Vienna: Springer, 2012), p. 25.
- 8 Neri Oxman and Sean Hanna, 'Q&A', in Glynn and Sheil (see note 6), pp. 143–5.
- 9 Karamba is an interactive, parametric finite element program that enables the analysis of the response of 3-dimensional beam and shell structures under arbitrary loads. Karamba is being developed by Clemens Preisinger in cooperation with Bollinger-Grohmann-Schneider ZT GmbH Vienna, <http://www.karamba3d.com/> (accessed 15 July 2013).
- 10 HAL is a flexible robot programming interface allowing designers and architects to learn to program, control and develop (multi-)robot manufacturing strategies in real-time from Rhino without the need to learn the robot language or use any external software, relying mainly on their architectural intuitions. Designed and written by Thibault Schwartz, who also conducted introductory workshops in REX|LAB related to this specific set-up since November 2012. <http://hal.thibaultschwartz.com/> (accessed 15 July 2013).

Fig.1: Ceramic prototype.



[R]EVOLVING BRICK: GEOMETRY AND PERFORMANCE INNOVATION IN CERAMIC BUILDING SYSTEMS THROUGH DESIGN ROBOTICS

STEFANO ANDREANI, MARTIN BECHTHOLD (DESIGN ROBOTICS GROUP, GRADUATE SCHOOL OF DESIGN, HARVARD UNIVERSITY)

The study researches mass-customisation methods that permit novel ornamental effects in brick cladding systems, and, at the same time, point towards new sustainable design opportunities for cost-effective, self-shading façades. This paper presents an integrated workflow for the development of robotically configured ruled-surface brick units and their digitally informed aggregations. Computational design methods and robotic fabrication technologies are integrated into traditional methods of masonry production and construction. The redesigned brick unit is made possible through a strategically devised robotic intervention in the clay extrusion process. Prototyping confirmed both the validity of the design for production, as well as the thermal effect of self-shading brick façades.

INTRODUCTION

Research in the area of robotics and brick construction at ETH Zurich and elsewhere has long focussed on the robotic assembly of standard bricks.¹ This present study integrates robotic technology on the production side, so that the age-old rectangular form of the brick can be successfully overcome, while maintaining the efficiency of tried and true mass-production methods. The resulting mass-customisation of brick forms opens up a new design space in brick construction. The reason for developing the present system is twofold: first, the historical role of brick as a cladding component can be enhanced into a more contemporary design language, thus addressing the ongoing discourse on façade customisation and ornamentation;² second, the introduced systems can further improve the role of the brick as a thermally active element for the environmental performance of the building, thus contributing to current efforts towards sustainable design.

In order to explore these new roles for brick as a contemporary building material, the research follows the dichotomy of a bottom-up/top-down approach. The investigation explores the formal possibilities of clay shaping by means of a controlled robotic wire cutting method in the ceramic extrusion process. Thus, related configurations can be generated by ag-

gregating these units (bottom-up approach). On another level, the project explores the complex territory of façade design in contemporary architecture, speculating on novel building systems that can be generated through the proposed technology (top-down approach). The result is a hybrid proposal that merges the manufacturing processes of custom ceramic units with a new approach to cladding system design.

Through the implementation of the design robotics research process developed at Harvard Graduate School of Design (GSD),³ this paper presents the elaboration and application of an integrated workflow that would eventually let both architects and manufacturers re-think the way brick building systems can be used, and let designers re-create novel and unexpected relationships with this traditional material. In this sense, the proposed material system can be seen as an innovative technology that 'generates vitality'.⁴

THE BRICK INDUSTRY: BETWEEN PAST AND FUTURE

Brick is one of the oldest building materials devised by humans; its first appearance coincides with the very dawn of civilisation.⁵ Its methods of manufacturing have improved tremendously over time, transitioning from hand-shaping and moulding to today's mechanised extrusion processes in high-

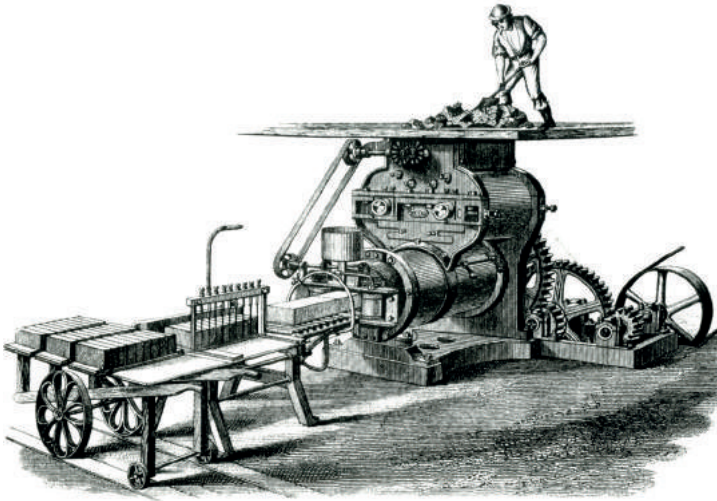

Fig. 2: Steam-driven stiff-mud brick making, 1860s.

volume mass-production facilities. Yet, despite these undisputed advances, the basic fabrication logic has remained the same for more than three centuries (fig. 2), and the shape of bricks has changed remarkably little.

Although contemporary projects show a variety of brick assembly configurations and design solutions, the basic geometry – the brick unit – has evolved far less than its fabrication methods. The ubiquitous brick has in fact preserved its basic parallelepiped shape for many centuries, the only formal variations being special pieces used for specific building features, such as cornices, corners and other decorative features. This paper questions the basic shape of the standard brick by investigating the design opportunities that emerge when robotic technology is applied during the manufacturing process of clay extrusions.

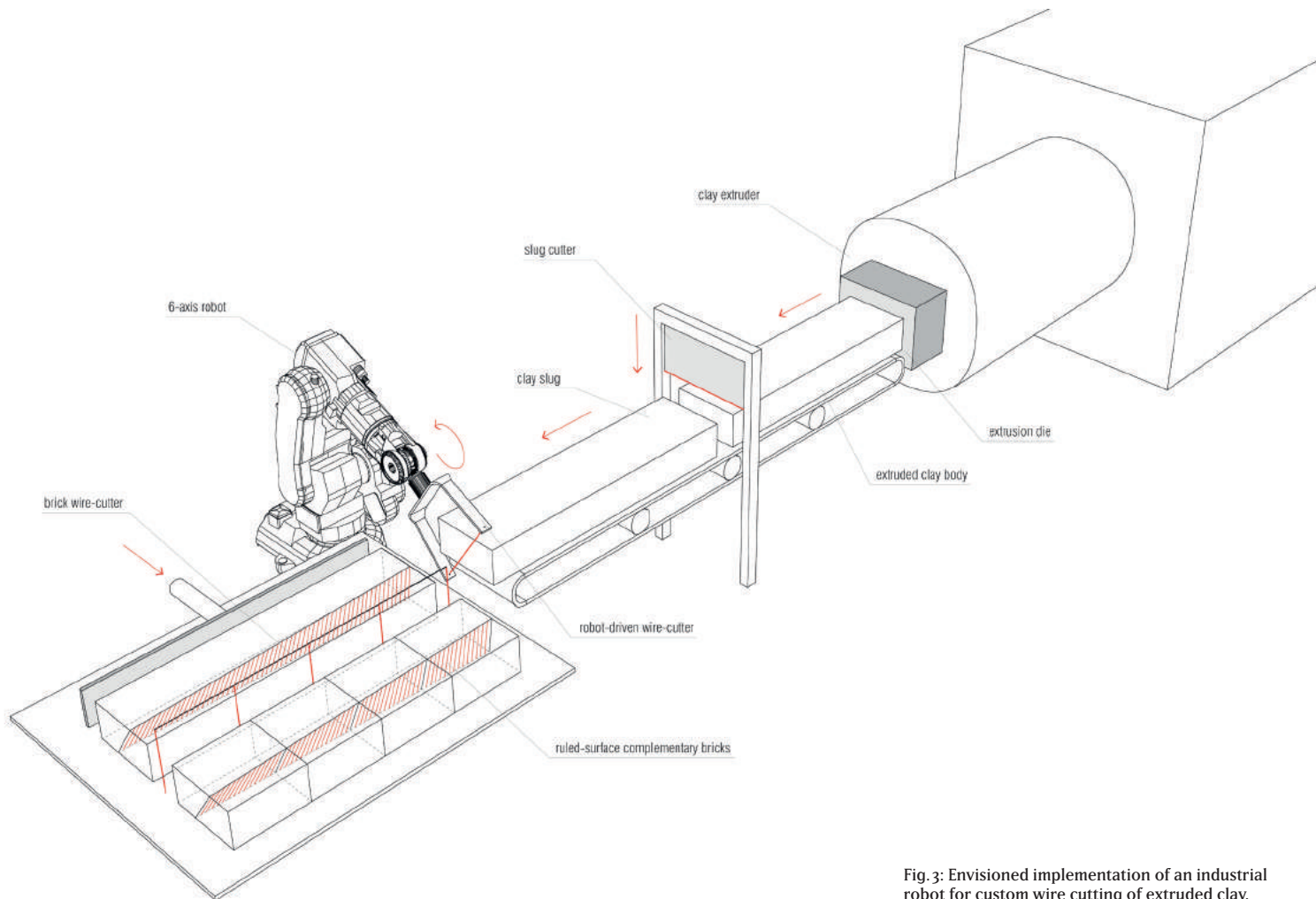

Fig. 3: Envisioned implementation of an industrial robot for custom wire cutting of extruded clay.

**MATERIAL SYSTEM: INFORMED DESIGN AND FABRICATION
WORKFLOW FOR STRATEGIC MASS CUSTOMISATION**

Rather than designing a single new brick, this study proposes a parametric brick family based on ruled surfaces shaped with robotic wire-manipulators. As with all mass-customisation approaches, a key aspect of this research is the development of an integrated workflow that links design, manufacturing and fabrication procedures. The robotic technology was primarily conceived for production, but combinations with robotic assembly systems would be possible.

DIGITAL SHAPING PROCESS: CNC WIRE CUTTING

This research proposes implementing a robotic or CNC wire cutting method in the established clay extrusion process commonly used for the production of bricks and many other ceramic building elements (fig. 3).⁶ The objective is to achieve strategic design improvements of brick construction by introducing mass-customisation of the units: bricks can now be individually and continuously shaped. Using a digitally driven wire cutting mechanism, such a technology can be integrated into industry-standard production processes without necessitating any but the most minor changes for downstream post-processing and handling activities (fig. 4).

Fig. 4: Envisioned extrusion manufacturing and construction scenario.

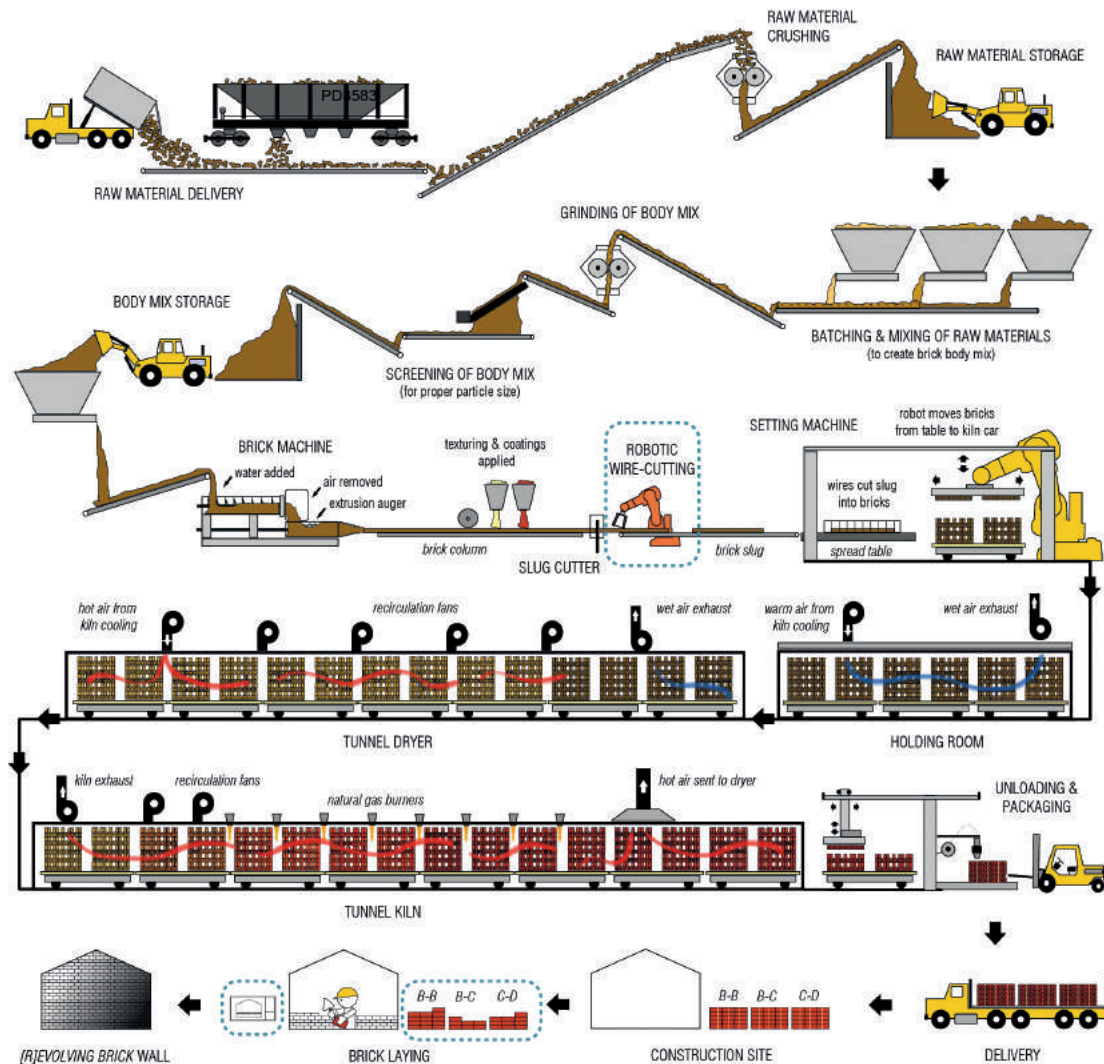

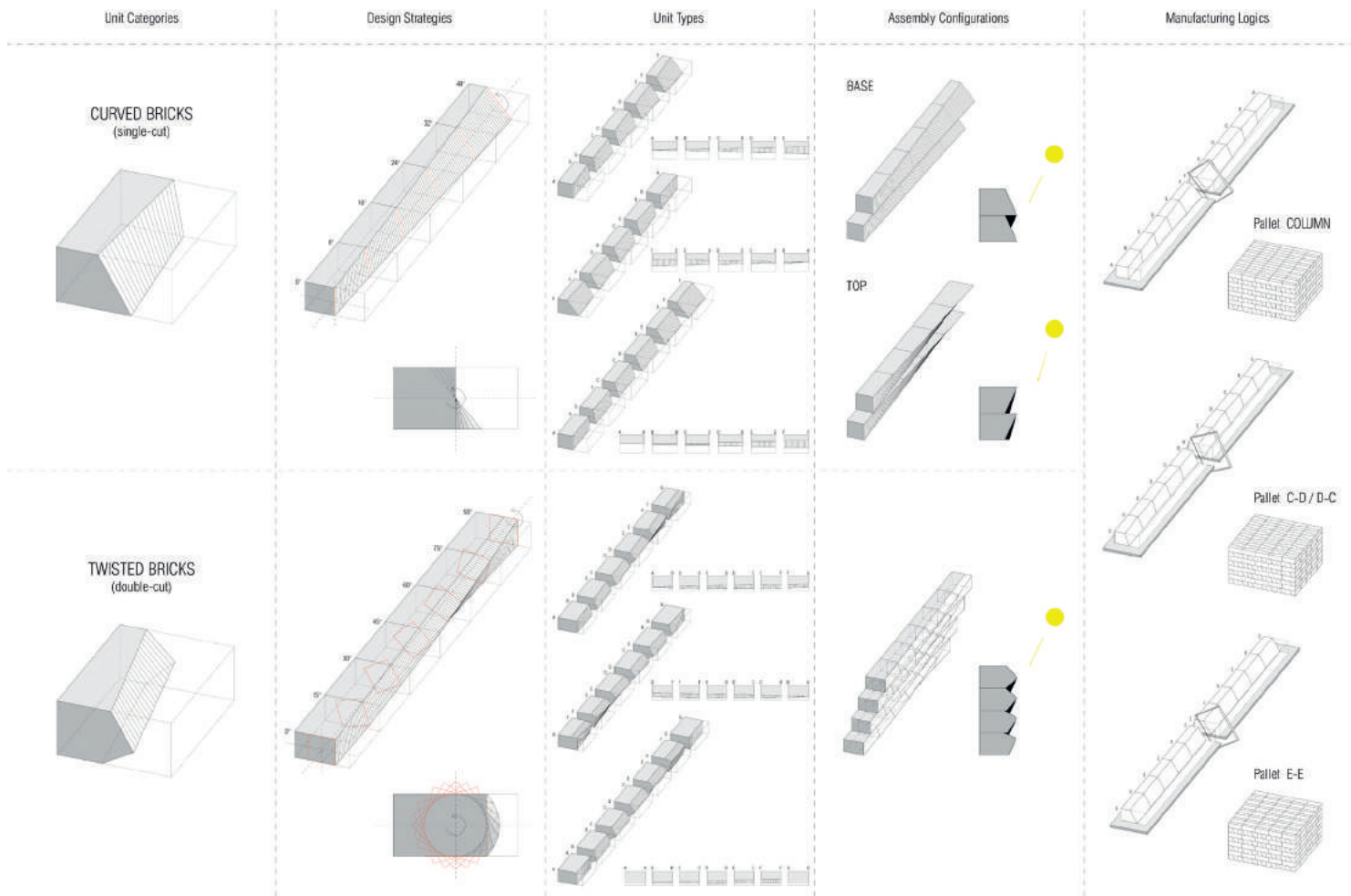

Fig. 5: Strategically customised ruled-surface unit typologies.

In the proposed shaping mechanism, a clay body is cut through by a straight wire or shaped blade that rotates while the slug is moved along the conveyor belt, or during a short rest period after the slug exits the die. By driving the cutting wire along the longitudinal axis of the clay slug, ruled-surface units are created. The wet clay slug is split into two or more pieces that face and support each other. Cross-cutting with a standard wire fence creates individual bricks. The extruded clay is dry enough to prevent adjacent units from re-bonding during drying or kiln firing. The split bricks stack much like normal rectangular bricks, and can be fired along with standard units. The strategic interventions in the extrusion process thus allow designers to pursue novel formal brick variations while maintaining the established features of a tried and true industrial process that is cost-effective and generates proven quality.⁷

ROBOTICALLY RE-MASTERED BRICKS: UNIT TYPOLOGIES

Observations and analysis of industrial brick production guided the development of several brick types. In a typical production setting, a certain percentage of bricks tend to crack and break during drying or firing. This presents a challenge for a true mass-customisation approach, which relies on the precise knowledge of what unit is produced how many times for a given location in a project.⁸ An additional problem with bricks would be tracking the extremely large number of individual parts. Even though these constraints can be overcome through comprehensive digital control and production management approaches, the research pursued a restrained customisation approach focused on prototyping a limited number of strategically designed brick units (fig. 5) that allow greater formal expression while maintaining the logic of tradition-

al on-site brick laying. These units fall under two categories: curved bricks (fig. 6) and twisted bricks (fig. 7), mainly differing in the shaping device employed.

To test the range of brick types, the research initially investigated image-based brick patterns for façades. Using Rhino 4.0™ and Grasshopper™ with custom C# scripts, a digital workflow was developed that allowed the upload of an input image in order to automatically map brick patterns according to colour values. The data is used to generate ruled-surface bricks, control wire cutting during extrusion, and produce a construction document with precise installation instructions. Coding methods that employ texturing rolling devices can be used to facilitate the identification of brick types after production.⁹

DYNAMIC PATTERNS: TIME AS A FOURTH DIMENSION

Brick walls are normally perceived as static surface patterns. One of the main objectives of this project is to create new experiential and material relationships between the building and its users. This can be achieved by consciously designing for the fourth dimension (time), both geometrically and environmentally. With the novel brick façade, shadows can be used in the design so the walls display dynamic, deep textures. Thanks to affective interplays between sunlight/shadow and materiality through time, the wall patterns become in fact naturally kinetic systems, creating vibrating façades that constantly change their character and their intensity from sunrise to sunset (fig. 8).

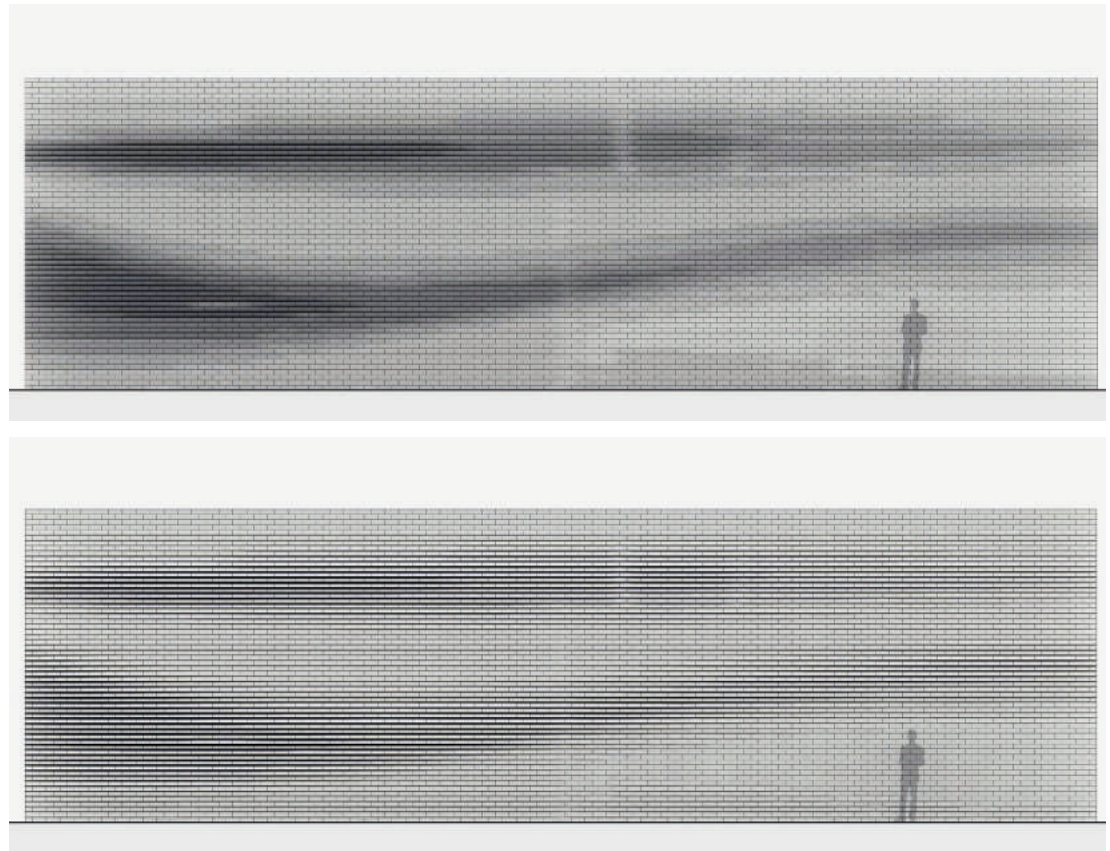

Fig. 6: Curved bricks unit typology: base and top configurations.



Fig. 7: Twisted bricks unit typology: ceramic prototype.



Fig. 8: Dynamic texture of a brick façade from sunrise to sunset.

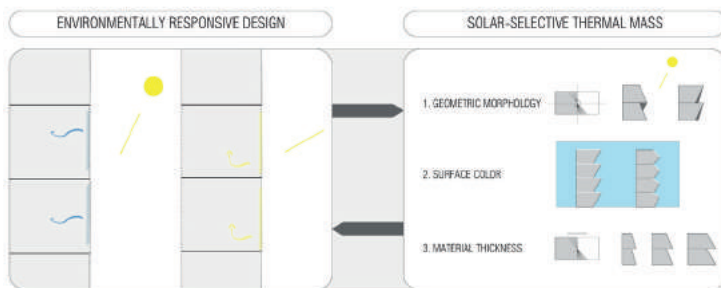

Fig. 9: Principles of the solar-selective thermal mass system.

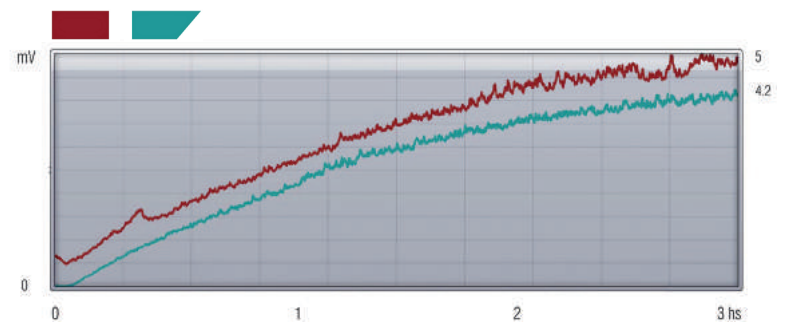

Fig. 10: Heat flux results from the physical test.

PERFORMATIVE ORNAMENTS: SOLAR-SELECTIVE THERMAL MASS SYSTEM

In order to improve the energy efficiency of brick façade systems, this research argues that specifically designed ruled brick shapes can optimise the material configuration so that solar-selective thermal mass systems are created, i.e. material systems whose geometric and material characteristics are strategically calibrated to maximise the energy benefits of solar radiation. In fact, by taking advantage of the geometric complexity achievable through the proposed shaping process, an architectural product can be developed that responds to variable climatic and diurnal cycles.

The main parameters that affect the heat-transfer behaviour of ceramic façade systems can be basically grouped into three categories (fig. 9):

1. Geometric morphology
2. Surface colour
3. Material thickness

This paper investigates the parameters related to the geometry of the units and their assembly configuration. Two main implementations of the material system are introduced, in particular for relatively extreme climates:

- *Self-shading systems*: Units are articulated in order to configure the façade system to be self-shaded for a relevant portion of the daytime. This configuration would be particularly effective in moderate to hot climates, where the sun's rays are substantially vertical and the solar radiation is intense.
- *Thermal storage systems*: Units are aggregated in order to maximise the solar heat gain of the wall system. Especially in cold climates where the altitude of the sun is generally lower than in other climate zones, the custom-cut facing surfaces of the bricks can be oriented in such a way that they would be perpendicular to the sun's rays as much as possible.

A series of physical tests were performed as proofs-of-concept for self-shading. The traditional flat brick system was compared with a purpose-shaped brick façade, simulating the thermal effects of shading on a hot sunny day. A comparison between the surface temperatures of the two prototypes showed that, after reaching a steady state, the custom-shaped units were cooler than the flat ones, both at the facing and back surfaces. A comparison between the heat flux of the two systems further validated this result (fig. 10). This first study thus demonstrates that geometric articulations have the potential to generate self-shading façade systems, with the subsequent benefit of reducing building heat gain in moderate to hot climates when compared to traditional flat-brick construc-

tion. This design potential was finally tested in the context of an architectural design study.¹⁰

PROCESS PROTOTYPE: ROBOTIC FABRICATION

In order to simulate the envisioned scenario of integrating custom wire cutting with industrial clay extrusion, a six-axis industrial robot (ABB IRB140 at Harvard's GSD Fabrication Lab) equipped with a custom wire end-effector was employed in a prototypical work cell.¹¹ The cutting set-up also involved a steel or wood jig for holding the clay unit during the robotic shaping process.¹²

The prototyping consisted of custom slicing $5 \times 11 \times 14$ cm 'green' terracotta units using the robotic manipulator. In order to facilitate the exploration of serialised mass customisation established by the proposed production system, an automated robotic programming workflow was developed to derive machine codes from the different digital geometries. Automation of robotic programming was facilitated by using a custom Hal™ script for Grasshopper™, inside the Rhinoceros™-based digital design platform. Once all the machine codes were generated, the devised cutting process allowed the production of hundreds of bricks per day (fig. 11). Dry bricks were fired in gas

Fig. 11: Robotic wire cutting simulation and prototyping.

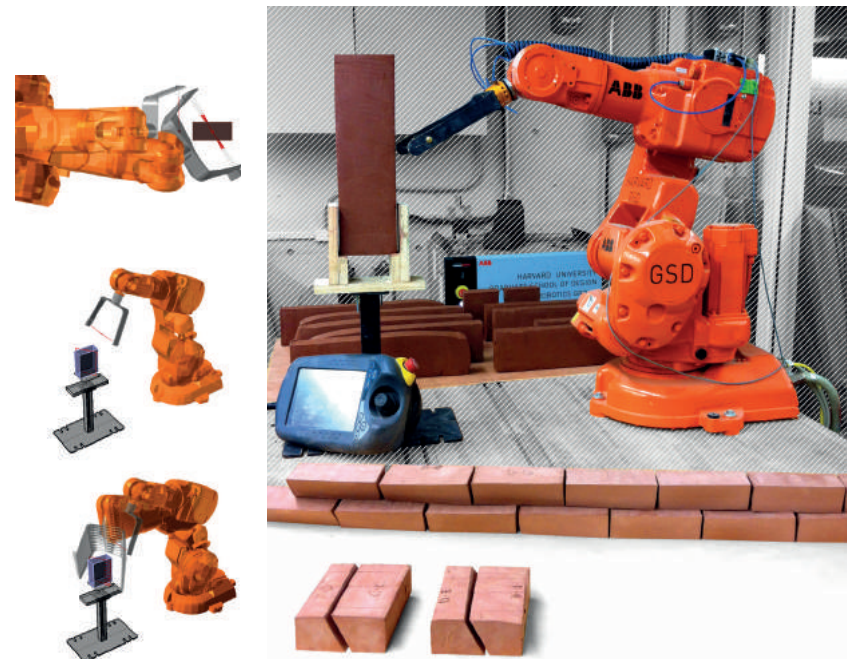

kilns. Despite their different thicknesses, shrinkage was uniform, thus confirming the feasibility of the new brick system. The bricks, labelled for clarity, were assembled into prototypes that demonstrated the novel richly patterned surface.

For the definition of the final prototype as proof-of-concept, a strategic brick configuration was designed. A construction document with the labelled bricks was then used to guide the assembly process, as it would take place on a construction site (figs. 1, 12).

CONCLUSION

Through the strategic employment of robotically re-mastered clay units and their digitally informed aggregations, the new brick system vastly expands the formal repertoire present in traditional brick construction. In order to combine ornamental effects with sustainable design in architectural ceramic systems, this work also developed strategies to improve the en-

ergy efficiency of brick envelopes. In particular, by combining material proprieties and geometric parameters, the research showed that it is possible to optimise the material configuration to generate solar-selective thermal mass systems that include self-shading. Exploiting the advantages of the geometric complexity available through the proposed shaping process, the new material system merges aesthetics and environmental performance by creating design pattern articulations that respond to variable climatic and diurnal cycles.

This design robotics research project pursues a new path towards expanded design scope in brick construction by devising a robotic intervention in the production system itself, while leaving downstream construction processes unchanged. Robotic brick assembly is possible and could facilitate the identification of brick types and assembly by using machine vision approaches. By merging computational design methods and robotic fabrication technologies with traditional meth-

Fig. 12: Ceramic prototype and its construction document.

D-C	C-C	C-B	B-B	B-A	A-A	A-A	A-B	B-B	B-C	C-C	C-D	D-D	D-E	E-E	E-E	E-E	E-E
D-D	D-C	C-C	C-B	B-B	B-A	A-A	A-A	A-B	B-B	B-C	C-C	C-D	D-D	D-E	E-E	E-E	E-E
D-D	D-C	C-C	C-B	B-B	B-A	A-A	A-A	A-B	B-B	B-C	C-C	C-D	D-D	D-E	E-E	E-E	E-E
E-D	D-D	D-C	C-C	C-B	B-B	B-A	A-A	A-A	A-B	B-B	BC	C-C	C-D	D-D	D-E	E-E	E-E
E-D	D-D	D-C	C-C	C-B	B-B	B-A	A-A	A-A	A-B	B-B	B-C	C-C	C-D	D-D	D-E	E-E	E-E
E-E	E-D	D-D	D-C	C-C	C-B	B-B	B-A	A-A	A-A	A-B	B-B	B-C	C-C	C-D	D-D	D-E	E-E
E-E	E-D	D-D	D-C	C-C	C-B	B-B	B-A	A-A	A-A	A-B	B-B	B-C	C-C	C-D	D-D	D-E	E-E
E-E	E-E	E-D	D-D	D-C	C-C	C-B	B-B	B-A	A-A	A-A	A-B	B-B	BC	C-C	C-D	D-D	D-E
E-E	E-E	E-E	E-D	D-D	D-C	C-C	C-B	B-B	B-A	A-A	A-A	A-B	B-B	B-C	C-C	C-D	D-D
E-E	E-E	E-E	E-D	D-D	D-C	C-C	C-B	B-B	B-A	A-A	A-A	A-B	B-B	B-C	C-C	C-D	D-D
E-E	E-E	E-E	E-D	D-D	D-C	C-C	C-B	B-B	B-A	A-A	A-A	A-B	B-B	B-C	C-C	C-D	D-D
E-E	E-E	E-E	E-D	D-D	D-C	C-C	C-B	B-B	B-A	A-A	A-A	A-B	B-B	B-C	C-C	C-D	D-D

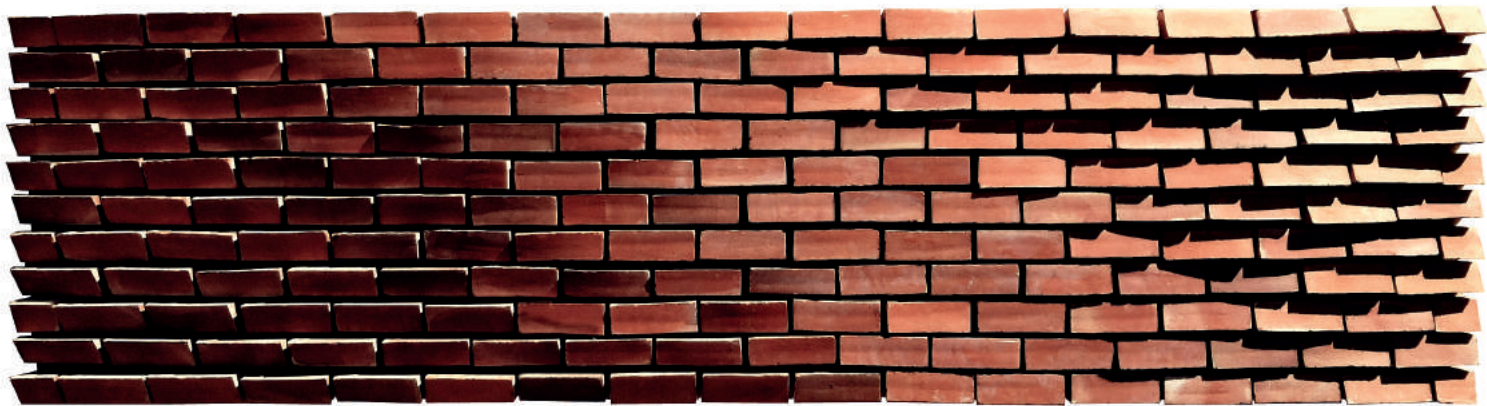

ods of masonry production and building construction, new sustainable and aesthetic design opportunities open up. The disruption of existing brick mass-production systems remains minimal. Next steps include the design of actual pilot runs in an industrial setting, as well as further quantification of self-shading brick geometries.

ACKNOWLEDGEMENTS

The research was supported by ASCER Tile of Spain and Morin Brick Co.

NOTES

- 1 Fabio Gramazio and Matthias Kohler, *Digital Materiality in Architecture* (Baden: Lars Müller Publishers, 2008).
- 2 Branko Kolarevic and Kevin R. Klinger, *Manufacturing Material Effects: Rethinking Design and Making in Architecture* (New York/London: Routledge, 2008).
- 3 Martin Bechthold and Nathan King, 'Design Robotics: Towards Strategic Design Developments', in Sigrid Brell-Cokcan and Johannes Braumann, eds., *Rob/Arch 2012: Robotic Fabrication in Architecture, Art and Design* (Vienna: Springer, 2013), pp. 118–28.
- 4 Pia Ednie-Brown, Mark Burry and Andrew Burrow, 'The Innovation Imperative: Architectures of Vitality', *Architectural Design*, 83/1 (2013), pp. 8–17.
- 5 James W. P. Campbell, *Brick: a World History* (London: Thames & Hudson, 2003).
- 6 Stefano Andreani, Jose Luis Garcia del Castillo, Aurgho Jyoti, Nathan King and Martin Bechthold, 'Flowing Matter: Robotic Fabrication of Complex Ceramic Systems', in *Proceedings ISARC 2012: The 29th International Symposium on Automation and Robotics in Construction* (Eindhoven: International Association for Automation and Robotics in Construction, 2012).
- 7 Andrea Bresciani, 'Shaping in Ceramic Technology: an Overview', in Frank Händle, ed., *Extrusion in Ceramics* (Berlin: Springer, 2007), pp. 13–34.
- 8 Daniel L. Schodek, Martin Bechthold, Kimo Griggs, Kenneth Martin Kao and Marco Steinberg, *Digital Design and Manufacturing: CAD/CAM Applications in Architecture and Design* (Hoboken, NJ: John Wiley & Sons, 2005).
- 9 The Brick Industry Association, 'Manufacturing of Bricks', *Technical Notes on Brick Construction*, 9 (2006), pp. 1–7.
- 10 The ongoing project (Nine Villas in Venice, Italy) is the result of a collaboration between RBA Studio (Ruggero Baldasso Architects, San Dona' di Piave, Italy) and Stefano Andreani.
- 11 Martin Bechthold, 'Design Robotics: New Strategies for Material System Research', in Brady Peters and Terri Peters, eds., *Inside Smartgeometry: Expanding the Architectural Possibilities of Computational Design* (London: John Wiley & Sons, 2013), pp. 254–65.
- 12 The wire cutting set-up was developed by Stefano Andreani, Jose Luis Garcia del Castillo and Aurgho Jyoti as part of the Flowing Matter project (Ceramic Lab, Professor Martin Bechthold, Fall 2011, Harvard GSD).

Fig. 1: Horizontally printed structure. (Image by courtesy of Joris Laarman Lab.)

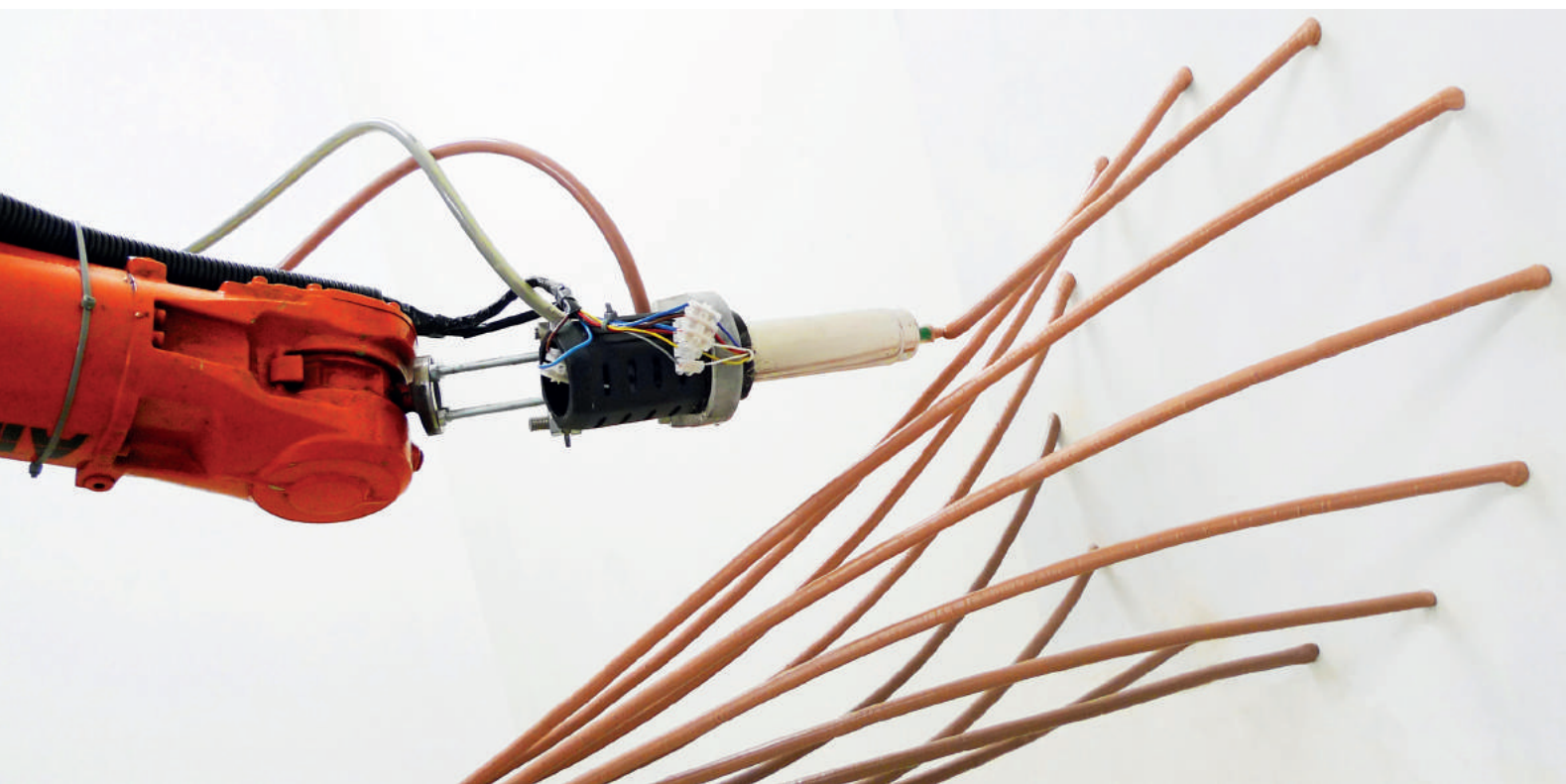

ANTI-GRAVITY ADDITIVE MANUFACTURING

JORIS LAARMAN (JORIS LAARMAN LAB),

SAŠA JOKIĆ, PETR NOVIKOV, LUIS E. FRAGUADA, ARETI MARKOPOULOU (IAAC BARCELONA)

The current paper describes a new method of additive manufacturing using a robotic arm. The research project presented is based on a technique that allows the creation of 3D objects on any given working surface independently of its inclination and smoothness, and without a need for additional support structures. By using rapidly hardening thermo-set resins in combination with innovative extrusion technology, it is possible to 3D-print double-curved lines of varying diameter without the need for support structures.

INTRODUCTION

Over the past several decades, the transition from analogue to digital has revolutionised many fields, most notably the distribution of information, computing and social media. The digital era not only changed the way we communicate, socialise, or organise people around ideas, or even disseminate critical information across national and political lines, thus provoking political change, it is now also starting to define an evolution in the way we finance, manufacture, distribute, sell and also recycle products in the physical world.¹

In its turn, the digitalisation of production not only allowed the automation of existing manufacturing techniques, it also brought in new manufacturing processes, such as the additive manufacturing process, also known as 3D printing.

While all traditional manufacturing techniques (computer-driven or not) mostly rely on the subtraction of material, additive fabrication is a process of producing a three-dimensional object layer by layer, particle by particle. The process of adding successive layers of a particular material allows unprecedented freedom in the design of the form and in its complexity.

There are many known methods of additive manufacturing that are used to form three-dimensional objects and many more different devices that use these methods. Some of the

best-known methods are fused deposition modelling (FDM), selective laser sintering (SLS), stereolithography (SLA) and powder bed and inkjet-head 3D printing. These methods of forming three-dimensional objects have a lot of differences, though they have one very important similarity: they all produce three-dimensional objects from computer data by creating a cross-sectional (two-dimensional cross-sections) pattern of the object and then forming the object by laying material on the pattern in an additive manner again and again, resulting in many layers of formed and adhered laminae.²

LIMITATIONS

The above-mentioned methods share similar limitations, the most important of which are: the necessity for a support structure under hanging laminae, a suitable working surface where additive manufacturing can take place and the need for the mutual adherence of the laminae.

In the cases of SLS, powder bed and inkjet head 3D printing, this problem is usually solved by the presence of preceding layers of material that were used to create previous lamina. In the cases of the FDM or SLA methods, this problem is usually solved by laying support laminae, which are usually calculated by the software. This results in additional structures

being connected to the final object, which then require post-processing that can sometimes result in damage to the object.

Most of these methods usually require a special horizontal working surface for forming objects. With most common 3D printers, objects cannot be formed on working surfaces with an irregular height, nor on vertical working surfaces, due to the force of gravity, resulting in the inability to form objects on surfaces such as walls, ceilings and coarse surfaces.

Although 3D printing tests in microgravity are already taking place, especially for exploring how additive manufacturing could be used on the International Space Station,³ these tests are limited to small-scale printing of objects and always inside hermetically closed microgravity boxes.

While the previously mentioned methods are efficient for forming high-resolution objects inside designated machines, they are not adequate for forming objects outside of the machines on unprepared settings or for forming objects that don't have a support underneath them.

It was apparent to the research team that the need exists for a method whereby the objects could be formed on any given working surface, independent of its inclination or smoothness, without a need for support structures or machines of limited size. In addition, the team focused on generating a method that would allow creating three-dimensional curves instead of working with the two-dimensional geometries of conventional additive manufacturing methods (fig. 2).

MATERIAL PROTOTYPING

Precise manipulation of the state of the material is essential for the process, as late solidification would result in a low strength of the curve thus formed and an early solidification would clog the process.

After conducting a large number of material experiments with different polymers, the use of very rapidly hardening, two-component thermosetting polymer was selected as the most appropriate mix of materials, and the first prototypes of the extruder were created. A static mixer-nozzle and a two-barrel constant-rate plunger extruder were used to mix the source material components (fig. 3). Both material components were pushed through the mixer at such speed that solidification took place precisely 1 mm away from the nozzle aperture.

Initially, some acrylic tubes were used as extruder barrels, but due to the high viscosity of the material, they failed to withstand the pressure, which resulted in cracks. Finally, the acrylic tubes were replaced with aluminium equivalents and the first printing experiments were held using a CNC machine to position the nozzle. The experiments proved that the prototype worked and a 50 cm long spiral line connected to a vertical surface was printed. Though the results were successful, there were some important issues about the low printing speed.

Additive manufacturing speed is always limited by the chemical properties of the materials used, since the materials can only be extruded at a specific rate or the properties of the part will be destroyed.⁴

After exhaustive tests of the material properties of the mixed thermosetting polymers at different heating and deposition speeds, the most optimised scenario was followed up and, as a consequence, two heaters were connected to the nozzle to speed up the curing process of the mixed material (fig. 5). The optimised scenario allowed a final speed of one meter of printed height per five minutes.

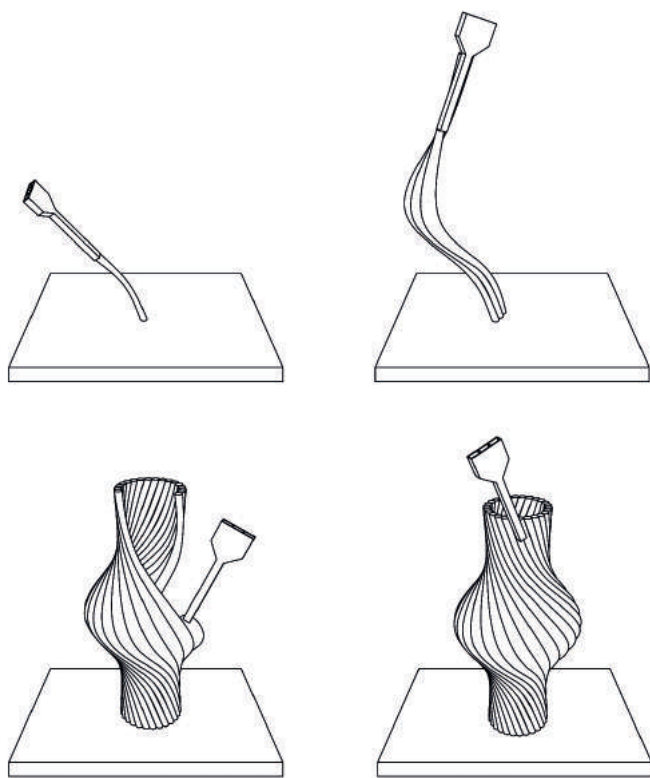

Fig. 2: Perspective view showing the preferred technical setting for the invention presented here. (Image by courtesy of Joris Laarman Lab.)



Fig. 3: Extruder and nozzle. (Image by courtesy of Joris Laarman Lab.)

ROBOTIC PROTOTYPING

The next research steps focused on the digital fabrication techniques and protocols. An ABB 2400L robotic arm at Joris Laarman Lab was used for performing fabrication tests and fine-tuning the material prototypes. The S4 controller directs the robotic arm, which has a reach of 1800 mm.

Since there was no existing software to control both robotic movement and extrusion speed, a customised plug-in for Rhinoceros software was developed by the research team and scripted with the Python language. The software was used to control the robotic arm movement as well as material extrusion speed, since the synchronisation of these two factors is vital for the project's development. The customised plug-in provides the ability to not only control the robot for printing complex structures, but also to control the thickness of the printed curves by changing the extrusion speed. For example, if the extrusion speed is halved, then the diameter of the printed curve is halved accordingly. Therefore, one curve can have a thickness of 5 mm in one part and 15 mm in another, while the flexural strength of the curve is 160 mPa.

Avoiding any collisions of the robotic arm with previously formed curves is a significant and complex problem that cannot be solved with software control alone. After numerous experiments, it was discovered that the nozzle could incline from the vector of the printed curve in order to avoid preceding curves without affecting the quality of the result (figs. 3, 4). This inclination control significantly simplified the collision avoidance solution.

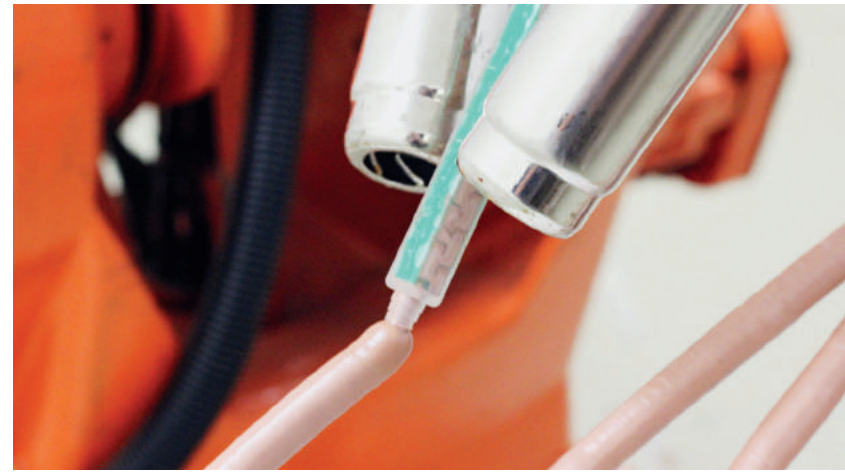

Fig. 4: Printed layer with different stages of curing. (Image by courtesy of Joris Laarman Lab.)

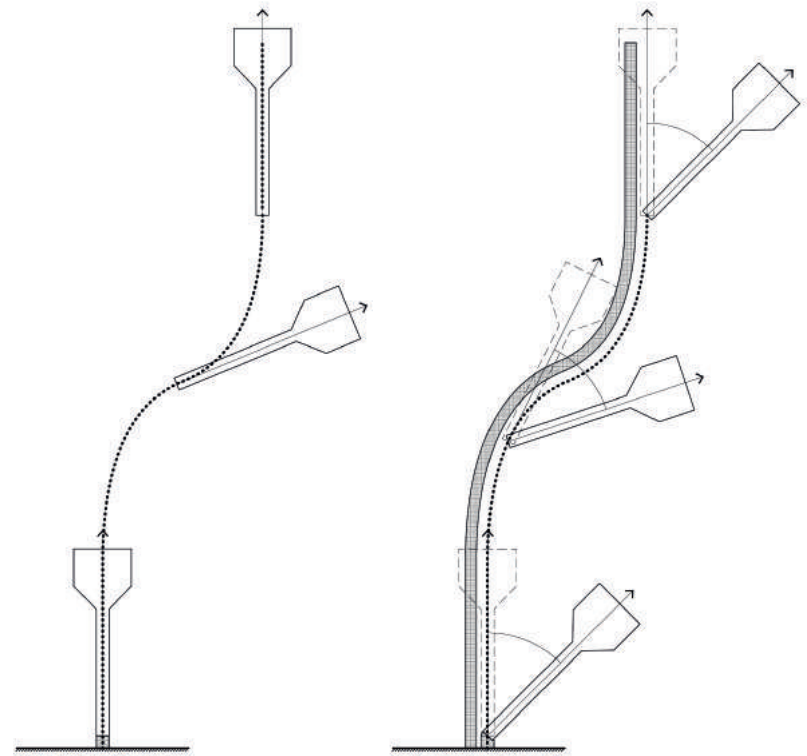

Fig. 5: Side view showing the process of forming a first curve with the orientation of the nozzle. (Image by courtesy of Joris Laarman Lab.)

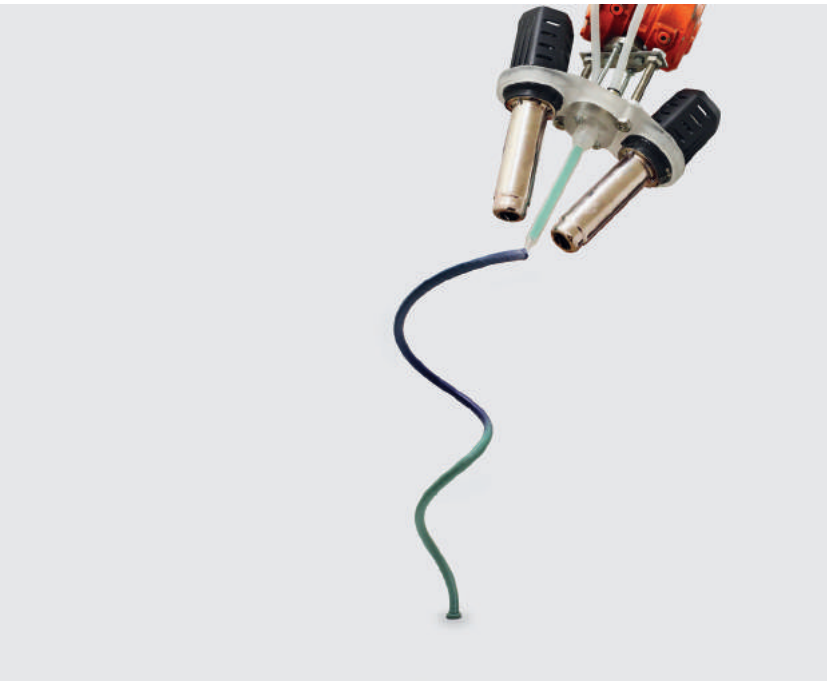

Fig. 6: Fully colour-programmed spiral.
(Image by courtesy of Joris Laarman Lab.)

Additionally, a colouring feature was developed in an effort to offer different colours for the final printed object. Colour dye is mixed in programmed proportions and injected into the static mixer. This feature allows users to pre-program the colour of the printed object, increasing the aesthetic possibilities of the technology (fig. 6).

ARCHITECTURAL APPLICATIONS

The introduction of additive manufacturing to architecture and the construction industry is being researched in a number of institutions and is considered to offer many possibilities in these fields.⁵ From Enrico Dini and DShape, a large-scale 3D printing-stone machine, to the concrete contour crafting of Behrokh Khoshnevis or the Freeform Construction Project from the University of Loughborough, additive manufacturing is becoming a significant revolutionary technique for future construction.

However, until it can be fully applied in real construction work, multiple limitations need to be solved. One of these problems is the requirement for support material during the printing process.

The method presented in this paper is considered a major step in the direction of solving this limitation. Based on this method, a series of different devices may appear in the near future, from desktop 3D printers to building construction and restoration robots. The proposed technology can considerably influence architecture and design industries, as it provides ways of controlling form much more elaborately than before. Furthermore, it brings the concept of the on-site digital fabrication of architectural buildings closer.

ACKNOWLEDGEMENTS

The research project was carried out in collaboration with Joris Laarman Lab and advised by Joris Laarman. It was conducted during an IaaC Open Thesis Fabrication Program (OTF 2012) directed by Areti Markopoulou and advised by Luis E. Fraguada, Fabian Scheurer and Mette Ramsgard Thomsen.



Fig. 7: Surfaces and objects can be formed by combined 3D curves instead of successive 2D layers allowing more control over the fabrication process. (Image by courtesy of Joris Laarman Lab.)



Fig. 8: The formed curve is not affected by the gravity force. No support material is needed. (Image by courtesy of Joris Laarman Lab.)

NOTES

1 Areti Markopoulou, *Towards the Democratization of Production, Additive and Personal Manufacturing in Fab Labs* (Athens: Re-Public, 2012).

2 Ian Gibson, David W. Rosen, Brent Stucker, *Additive Manufacturing Technologies: Rapid Prototyping to Direct Digital Manufacturing* (New York: Springer, 2010).

3 NASA Marshall TV, *3D Printing in zero gravity*, accessed 20 November 2013, <http://www.youtube.com/watch?v=Ijwxn6EzW84>.

4 Nick Allen, *Why 3D Printing is Overhyped*, Gizmodo, accessed 20 November 2013, <http://gizmodo.com/why-3d-printing-is-overhyped-i-should-know-i-do-it-fo-508176750>.

5 Philip F. Yuan and Neil Lynch, *Fabricating the Future* (Shanghai: Tongji University Press, 2012).

Fig. 1: Section of lunar outpost, showing the internal pressurised inflatable and the regolith shielding.

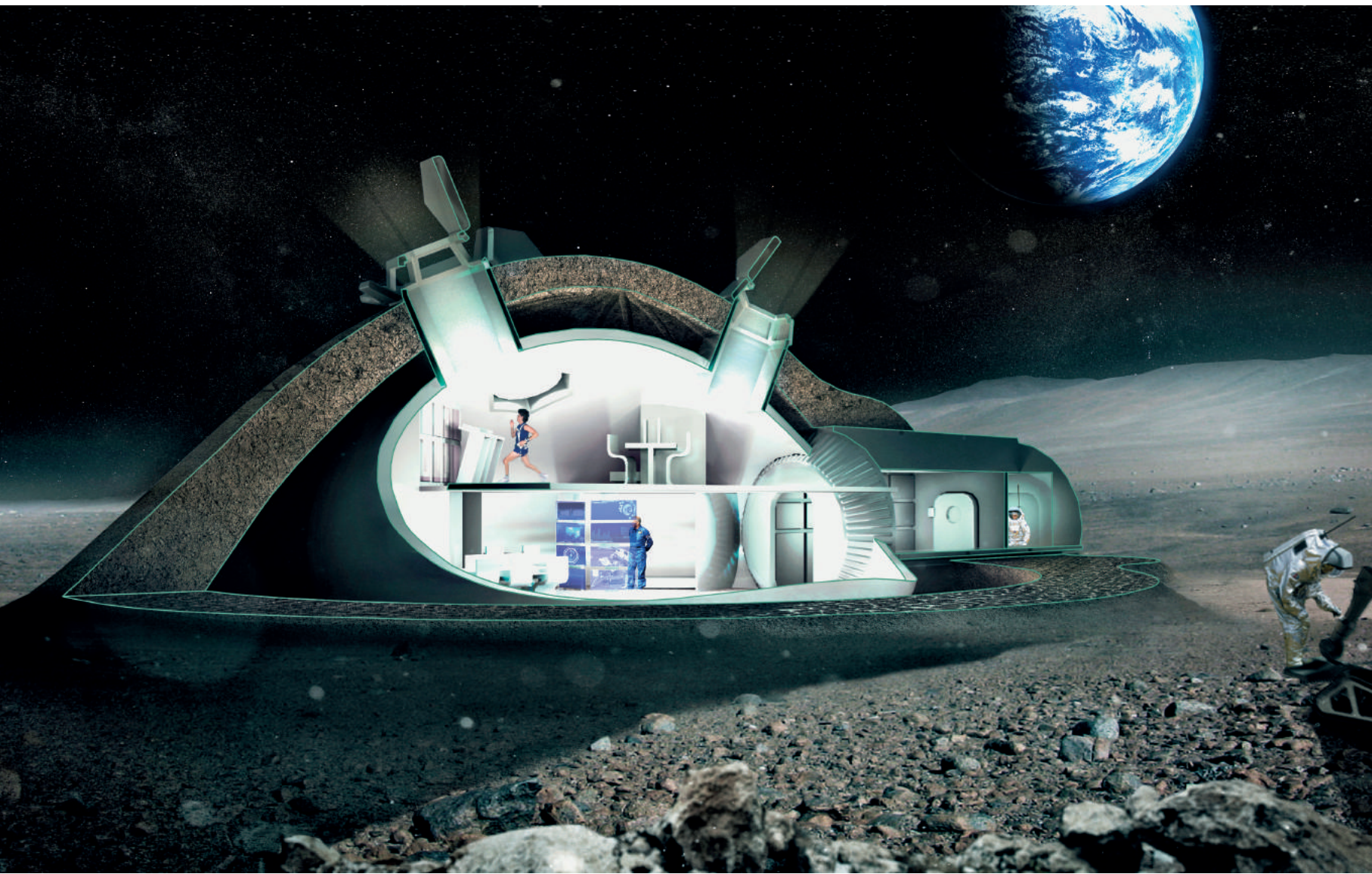

THE DESIGN OF A LUNAR OUTPOST: 3D PRINTING REGOLITH AS A CONSTRUCTION TECHNIQUE FOR ENVIRONMENTAL SHIELDING ON THE MOON

XAVIER DE KESTELIER (FOSTER + PARTNERS, UK), ENRICO DINI (MONOLITE LTD., UK), GIOVANNI CESARETTI (ALTA, SPA, ITALY), VALENTINA COLLA (SSSC_PERCO, ITALY), LAURENT PAMBAGUIAN (ESA, ESTEC, THE NETHERLANDS)

In 2009, the European Space Agency awarded a General Study Programme contract entitled 3D Printing Building Blocks for Lunar Habitation to an industrial consortium comprised of Foster + Partners, Alta SpA, Monolite Ltd, and Scuola Superiore Sant'Anna. The main objective of the study was to investigate whether 3D printing of moon dust is a viable construction technology for possible future lunar colonisation. Each of the companies in the consortium brought their unique expertise and specialised knowledge. The research was led by Alta Spa, a space engineering company. Foster + Partners provided the overall design concepts, computational modelling and visualisations. The Perceptual Robotics Laboratory (PERCRO) of the Scuola Superiore Sant'Anna provided the know-how for control systems and robotics and Monolite UK delivered the printing technology.

INTRODUCTION

Ever since the Apollo missions in the late 1960s, the idea of colonising the moon, or at least having a permanent base there, has been the focus of many research projects. Most of these focus on very particular technical aspects of lunar colonisation and habitation.¹ This project does the same to a certain extent, but it also tries to bring a more holistic approach to the design of a lunar base.

The research can be broadly divided into two main aspects. The first is mainly related to the technical feasibility of 3D printing with moon dust (or its scientific name: regolith) in a lunar environment. The chemical and physical characteristics of lunar regolith and terrestrial regolith simulant will be examined and assessed to see if it is a viable construction material for large-scale 3D printing. The second aspect of the research, and the focus of this paper, looks at how printed structures could be used as shielding and how this could be integrated into the overall design of a lunar outpost.

A permanent base on the moon would require constructions to house and shelter astronauts and all their equipment, as well as provisions and protection from the harsh lunar conditions. The moon is by far one of the most extreme environmental conditions one could imagine. Astronauts would

have to be protected from extreme temperature differences, meteorite impacts, radiation and space vacuum.

PRECEDENTS

Over the last 40 years, most of the designs for lunar bases have been based on ready-to-use modules, which are typically transported from earth fully constructed and kitted out.² These modules have geometries that are compatible with launch vehicles and are often shaped to fully utilise the cargo space of launch vehicles. This is why the design of moon bases is often built around assemblies of cylindrical elements not so dissimilar to, for example, the ISS (International Space Station) modules.³

The problem with this approach is that the cost per square metre is extremely high. As a result, some studies have assessed lunar habitation based on inflatable structures. The advantage of inflatable structures is that they are extremely light and are highly collapsible for transportation to the moon. Some space habitation proposals, such as Bigelow,⁴ which was based on the TransHab⁵ system, have combined core cylindrical modules with an inflatable module around the core. This hybrid approach exploits advantages provided by both systems.

Neither inflatable nor ready-made modules provide adequate long-term protection from the harsh lunar environment. There have been numerous studies into shielding permanent lunar bases.⁶ One possible solution would be to use bulk material such as moon dust. There is an abundance of this material, as the moon's surface is covered with a layer of it, varying in thickness⁷ from 20 cm up to 10 m. There are quite a few ways in which this bulk regolith could be applied to a structure: piling of loose regolith, retention walls, and regolith sandbags.⁸ Most of these concepts rely on an underlying rigid structure, such as a standard cylinder ready-to-use module.

The question is, of course, how this loose material can be consolidated into a usable structure. There are extremely high costs related to bringing any equipment to the moon, let alone heavy traditional construction equipment. Any feasible construction method should therefore not include large machinery. On a conceptual level, 3D printing as a construction technology could be a possible fabrication strategy, as material is only added locally and incrementally in small amounts. So there is no huge displacement of materials, requiring large, heavy machinery.

LARGE-SCALE 3D PRINTING

The consortium's expertise in 3D printing is provided by Enrico Dini. He developed the D-shape printing technology, which is one of only a handful of technologies that are currently able to 3D print on the scale of buildings or building components. The D-shape technology works in a quite similar way to most addi-

tive manufacturing processes. It starts by putting down a thin (5 mm) layer of fine granulates. A gantry controlled deposition head then moves across the surface and selectively adds an inorganic binder to the granulates. This process is repeated as the head returns to its starting position and then iterated with subsequent layers of sand across the entire build area. Part of the research project is to see if the D-shape process is a feasible technology for lunar printing on a purely chemical and environmental level. Does the process work in 1/6th of the Earth's gravity, in a vacuum and under extreme temperatures?

DESIGN OF THE BASE

The architecture of Foster + Partners is always attuned to local environmental conditions. The difference in designing on the moon is that the environmental conditions are so much more extreme and complex than on Earth. Therefore, a set of environmental and technical requirements were established by Alta to provide the design team at Foster + Partners with guidelines for designing in a lunar environment.

One of the first ideas was to decouple the sealing capability from the thermal, mechanical and radiation protection functions. The main sealed and pressurised habitable space is, in this design, constructed from a mixture of hard shell ready-to-use modules and an inflatable structure (fig. 1). The current design proposes an assembly of three inflatable volumes, interconnected with ready-to-use cylindrical elements that also form airlocks to the outside environment (fig. 2). The inflatables would have a typical height of 5 m in order to contain two

Fig. 2: The lunar outpost is a modular design and can be extended in the future.



Fig. 3: The shielding of the dome is printed by a series of small 3D printers and uses moon dust, which is available in abundance on the moon's surface.

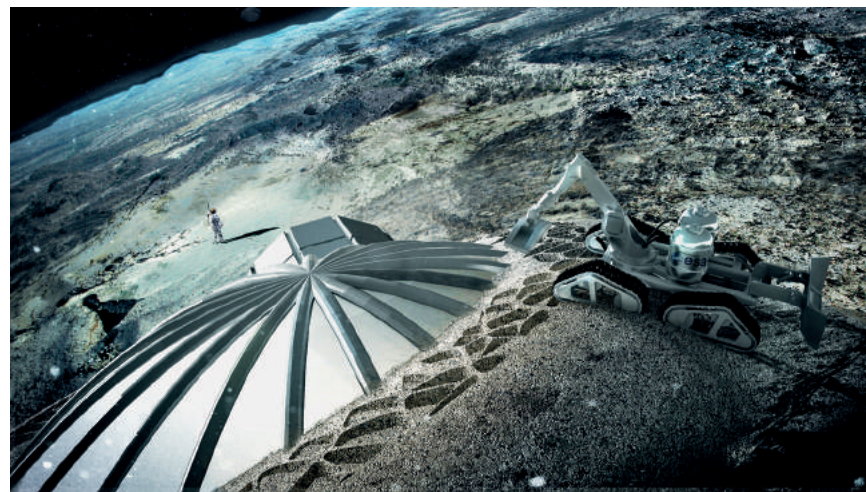

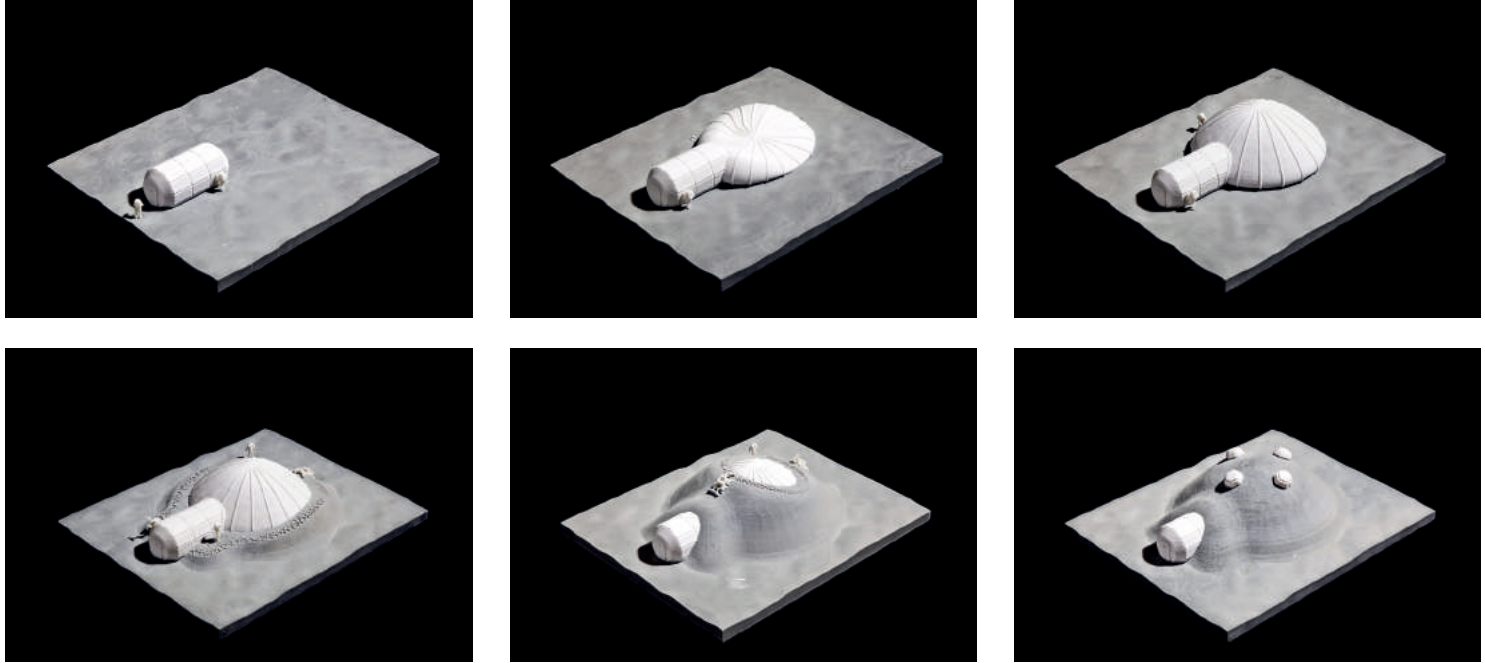

Fig. 4a–f: A temporary highly pressurised inflatable dome creates a support structure on which the regolith dome can be 3D printed.

levels. The overall sectional dimension could be in the region of 10 m by 5 m. The overall shape of the inflatable has continuous curvature so that it can withstand the internal pressures. This inflatable does not give any protection, but it provides an atmospheric pressure and conditioned space. It is quite obvious that such a fragile structure would have very limited rigidity and would need to be protected.

This protection will come from a dome-shaped shell, constructed from 3D printed regolith. The current D-shape printing process, like most 3D printers, uses a gantry system that is always of an order larger than the printed object. This is not, of course, a feasible set-up for any large-scale structure. It is assumed that to be able to print on the moon, a much more 'bottom up' approach must be taken. Smaller robots could deposit small amounts of regolith and selectively solidify them with a printing device.

The D-printing process uses, just like all powder-based 3D printing processes, its own powder as a support structure. The problem with this approach for large-scale structures is that, in this case, the dome would need to be excavated and hollowed out after it has been 3D printed. Therefore, an additional inflatable structure is envisioned that would serve as a support on which the dome can be constructed. This inflatable support dome is a high-pressurised rib structure, on which a set of robotic printers can start to deposit layers of regolith and subsequently solidify them (fig. 4a–f). At the end of this

process, the inflatable support dome can be removed and a second inflatable dome can be raised. This provides the low-pressure conditioned dome in which the astronauts would live and work. In between this dome and the regolith is a vacuum cavity, which acts as an excellent insulator. This is necessary, as the temperature differences on the regolith dome could potentially be as much as 200°C.⁹

3D printed regolith, like masonry, has a very low tensile strength.¹⁰ The geometry of the structure ensures that the forces are primarily compression. Therefore, a catenary structure was chosen to span the internal pressurised volume. In this way, mainly compression forces will be acting on the structure (fig. 3).

The moon has almost no atmosphere, therefore, meteorites impact the surface at speeds close to 18 km/s; to put this into perspective, a bullet leaves a rifle at about 2 km/s. Although large meteorites are rather rare, a sufficient protection layer for micrometeorite impacts is necessary. With a probability of 0.998 to have no fatal event during a lifetime of 10 years, a protection layer of 800 mm is needed. This protection is achieved by offsetting the catenary structure radially by 800 mm. This offset is radial as meteorites can impact the surface at any angle (fig. 5).

Due to the non-existent atmosphere and the magnetic fields on the moon, space radiation on the surface is far higher than on Earth. There are three types of radiation that reach the moon's surface: solar wind, solar flares and galactic

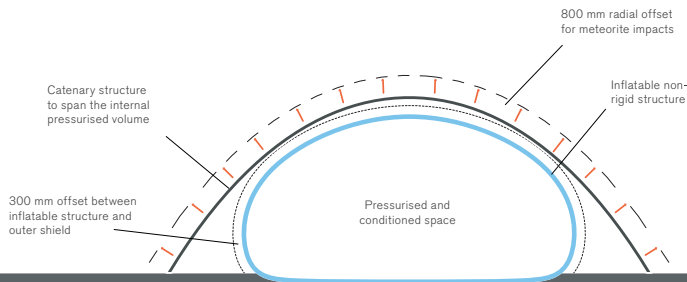

Fig. 5: The lunar outpost can be protected from meteorites by an 800 mm layer of regolith.

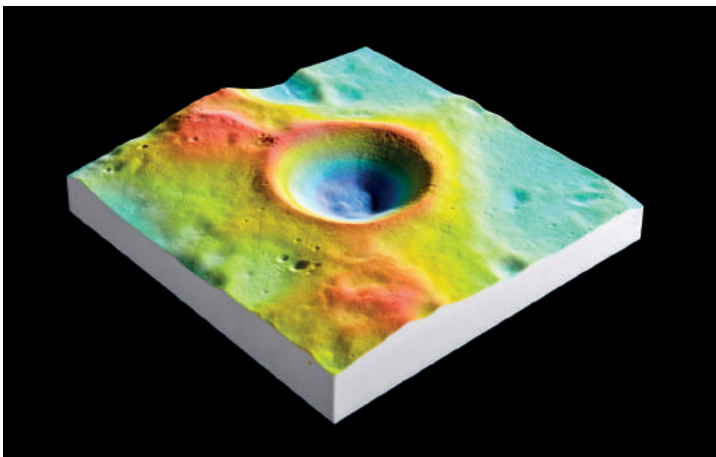

Fig. 6: Solar analysis of the Shackleton Crater on the south pole of the moon. The red areas have eternal sunlight and the dark blue areas are in eternal darkness.

cosmic rays (GCR). Solar radiation will, in particular during solar flares, be the main design driver.¹¹

The proposed location for the lunar base is on the edge of the Shackleton Crater near the south pole. This is one of the 'peaks of eternal sunlight', as the sun would never set and would be continuously on the horizon (fig. 6).¹² A lunar day lasts 28 earth days; this means that the sun rotates around the lunar base in relatively 28 days. Therefore, any solar radiation will come in at a very low, almost horizontal angle. The geometry, and, in this case, the catenary curve, can be horizontally offset by 1500 mm to effectively protect against solar radiation (fig. 7).

The proposed design synthesises the main design drivers: inflatable inhabitation module, catenary structure, radial pro-

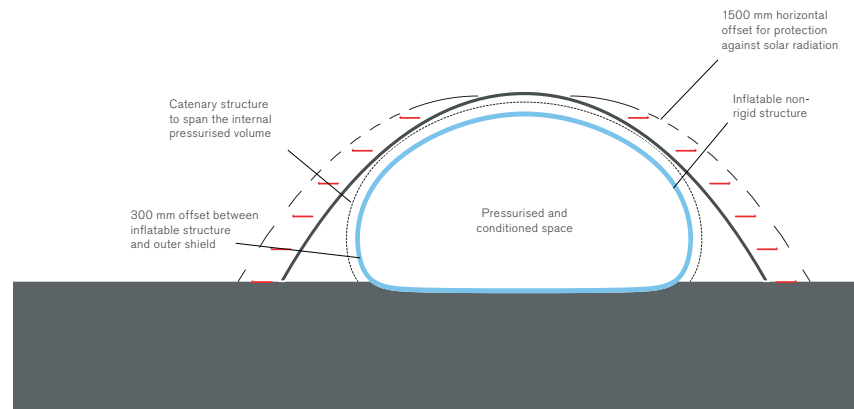

Fig. 7: The lunar outpost is protected from solar radiation by a 1500 mm layer of regolith.¹³

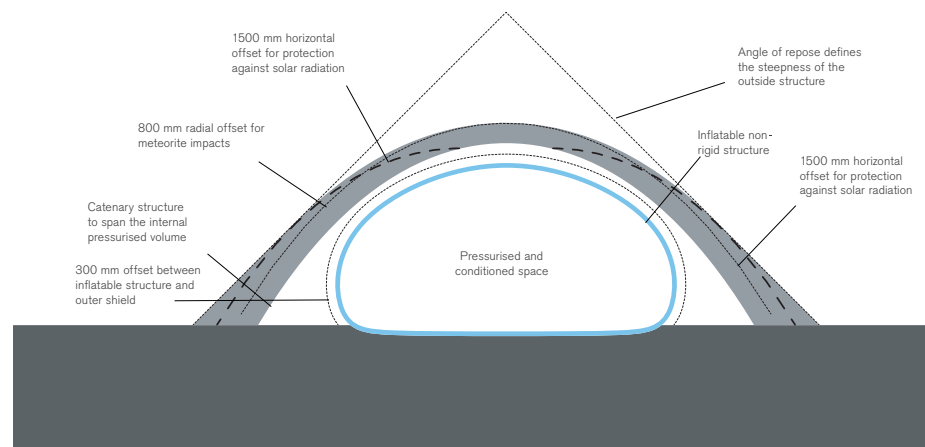

Fig. 8: Overall sectional logic of the design drivers for the regolith protection shield.¹⁴

tection against meteorites and protection from radiation. The resulting structure has a variable thickness over its cross-section. It has a greater thickness at the rim, where it meets the horizontal ground plane, and is thinner at the zenith (fig. 8).

The current D-shape printing technology uses two inorganic binders (metallic oxide and magnesium chloride), which probably cannot be found on the moon. One of the challenges taken up by the designers is to create structures that use the minimum amount of binder per volume of regolith, seeking to optimise the overall regolith protection skin, without losing its overall rigidity.

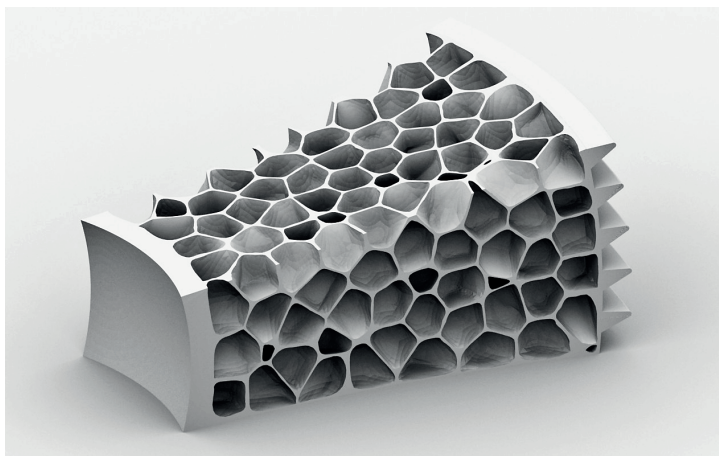

Fig. 9: Sample of the internal foam structure.

INTERNAL STRUCTURES

One of the lightest space-filling topological systems that can be found in nature are foam structures. Foams are often defined as a two-phase system, in which typically a high volume of gas cells are enclosed in a liquid or solid state. In this case, loose regolith is enclosed in a 3D-printed closed-wall cell system.

There are two main reasons why a closed-wall foam system was chosen. Firstly, although the thickness of the regolith would protect from meteorites, it does not minimise the damage from such an impact. To absorb the impact of meteorites, a layered approach of solidified and loose regolith would be ideal to disperse the energy of the impact.

Secondly, closed foams also have the advantage that any section through the structure delivers a structural platform. This is crucial, as the regolith dome will be built up from hor-

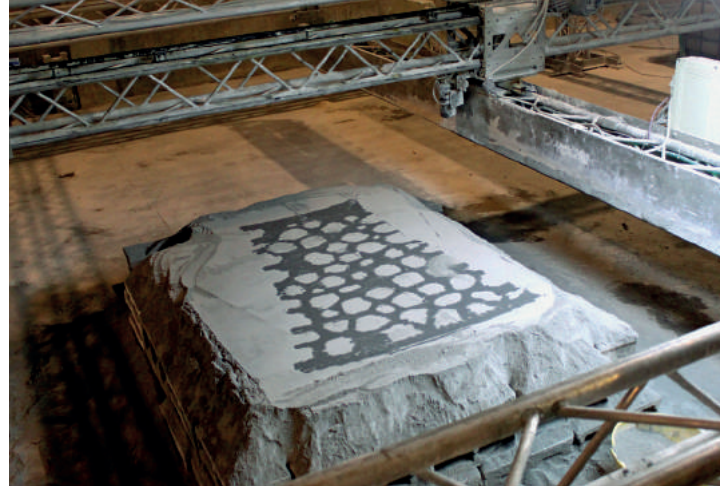

Figs. 10, 11: A large mock-up of the regolith shield was fabricated on the D-shape printer.

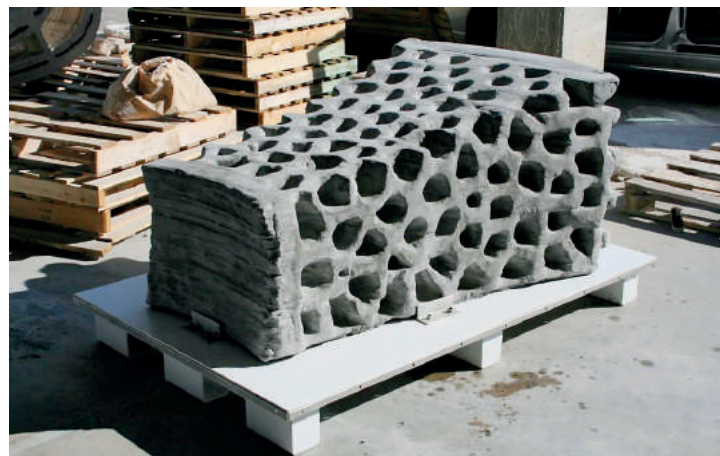

izontal layers. Each of these layers will need to be a platform from which the 3D printing robots can build the next layer.

A parametric model and script were developed by the Specialist Modelling Group at Foster + Partners to investigate the usability of foam as internal structure of the regolith shield (fig. 9). A structural feasibility study has been pursued, making some simplifying assumptions, by performing a structural analysis on a shell structure, a comparative finite elements (FE) structural analysis on small samples with different cell sizes and an analytical study comparing the cell structure with other materials.¹⁵

To verify the D-shape printing process, two different demonstrators were produced. The first was a 1.3 ton and 1.5 metre long section of the regolith dome printed on a D-shape printer (figs. 10, 11). The second demonstrator was a much smaller

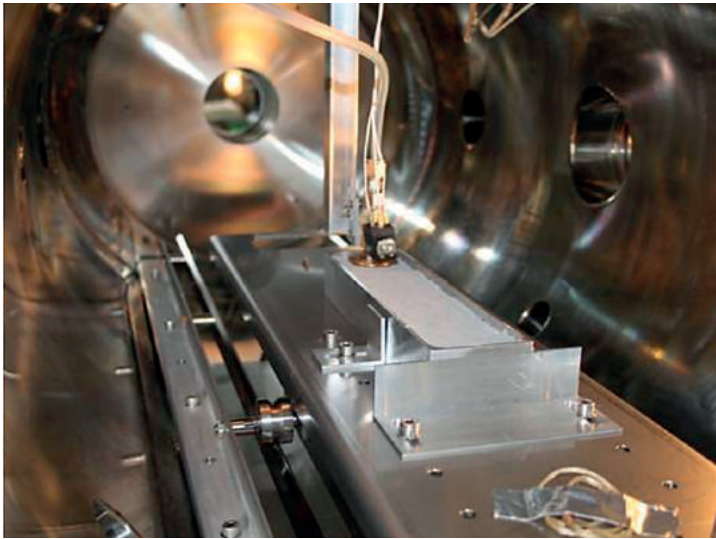

Fig. 12: A 3D printing test rig was set up in a vacuum chamber to investigate the validity of printing in a space vacuum.

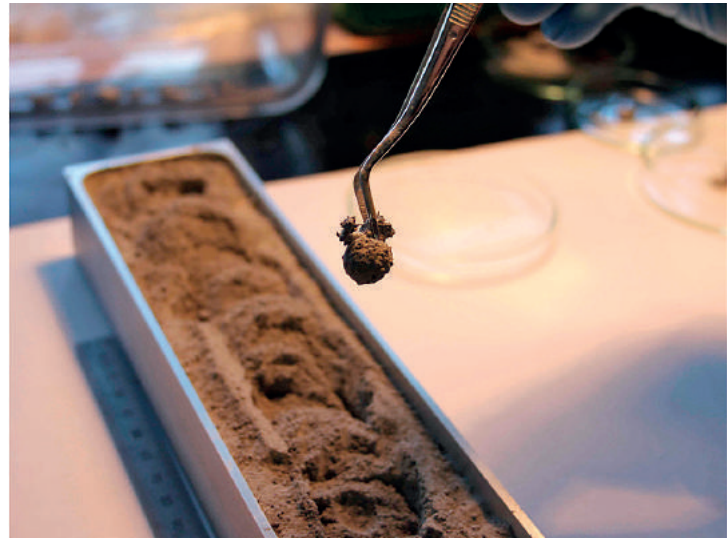

Fig. 13: A small sample was successfully printed in a vacuum by injecting the binder underneath the regolith surface.

sample and aimed at testing the printing process in a vacuum. A small test rig was created with a printing nozzle that injected the binder a few millimetres beneath the top of the regolith simulant. This was to avoid immediate evaporation of the binder liquid in a vacuum. This test resulted in six small spherical 3D-printed pieces, which demonstrated the feasibility of 3D printing in a vacuum (figs. 12, 13).

Many more years of research will be needed, of course, before the first robotic 3D printers could be sent to the moon. But it does show the potential for using 3D-printed regolith as a construction methodology for shielding on the moon, and suggests how this could be integrated into an overall design strategy for future moon bases (fig. 14).

ACKNOWLEDGEMENTS

The authors wish to thank the General Studies Programme at ESA for funding the research and Scott Hovland, also from ESA, for his input with his broad knowledge of space exploration. We would also like to thank Fabio Ceccanti, Leonardo Priami, Federico Cannelli and Stefano Caneschi from Alta for their valuable contributions; Stefan Behling and Roger Ridsdill Smith from Foster+Partners for their design leadership and Daniel Piker, Jonathan Rabagliati, Giovanni Betti, Kristoffer Josefsson, Salmaan Craig, Jethro Hon from the Specialist Modelling Group at Foster+Partners for their design expertise; Alice Borselli and Mirko Sgarbi of Scuola Superiore Sant'Anna.

NOTES

- 1 Peter Eckart, ed., *The Lunar Base Handbook: an Introduction to Lunar Base Design, Development, and Operations* (Boston, Mass.: McGraw-Hill, 2006).
- 2 Stewart Johnson, 'Habitats, Laboratories, and Airlocks', in Eckart 2006 (see note 1), pp. 261–97.
- 3 David Baker, *International Space Station: 1998–2011* (Sparkford, England: Haynes, 2012).
- 4 <http://www.bigelow aerospace.com/>, accessed September 2013.
- 5 Kriss J. Kennedy, 'Transhab Project', in A. Scott Howe and Brent Sherwood eds., *Out of this World: the New Field of Space Architecture* (Virginia: American Institute of Aeronautics and Astronautics, 2009), pp. 81–8.
- 6 Michael Rycroft, 'Shielding Requirements and Concepts', in Eckart 2006 (see note 1), pp. 497–523.
- 7 W. David Carrier, *Geotechnical Properties of Lunar Soil* (Lakeland, Fla.: Lunar Geotechnical Institute, 2005).
- 8 Rycroft 2006 (see note 6).
- 9 Alexander M. Jablonski and Kelly A. Ogden, 'A Review of Technical Requirements for Lunar Structures – Present Status. Paper presented at the Seventh International Conference on the Exploration and Utilization of the Moon, 18–23 September 2005, Toronto, Canada. Available at: <http://sci.esa.int/ilewg/43268-abstracts-and-presentations>, accessed 16 December 2013.

10 Dini Cesaretti and Xavier De Kestelier et al., 'Building Components for an Outpost on Lunar Soil by Means of a Novel 3D Printing Technology', *Acta Astronautica*, 93 (2014), pp. 430–50.

11 Thomas A. Parnell et al., 'Radiation Effects and Protection for Moon and Mars Missions', *Space 98 Conference Proceedings* (1998).

12 Wubbo J. Ockels, Jeroen F. De Weerd and Michiel Kruijff, 'Search for Eternally Sunlit Areas at the Lunar South Pole from Recent Data', *IAF 98 Q.4.07*.

13 This image has already been published in Cesaretti and De Kestelier 2014 (see note 10).

14 This image has already been published in Cesaretti and De Kestelier 2014 (see note 10).

15 Cesaretti and De Kestelier 2014 (see note 10).

Fig. 14: Rendering of the first phase of the lunar outpost.



Fig. 1: FABCLAY Project, developed by Nasim Fashami, Saša Jokić, Starski Naya.
FABBots 3.0, IaaC, 2012. Machine-material test running on a universal robot depositing clay.
(Photo: Saša Jokić.)

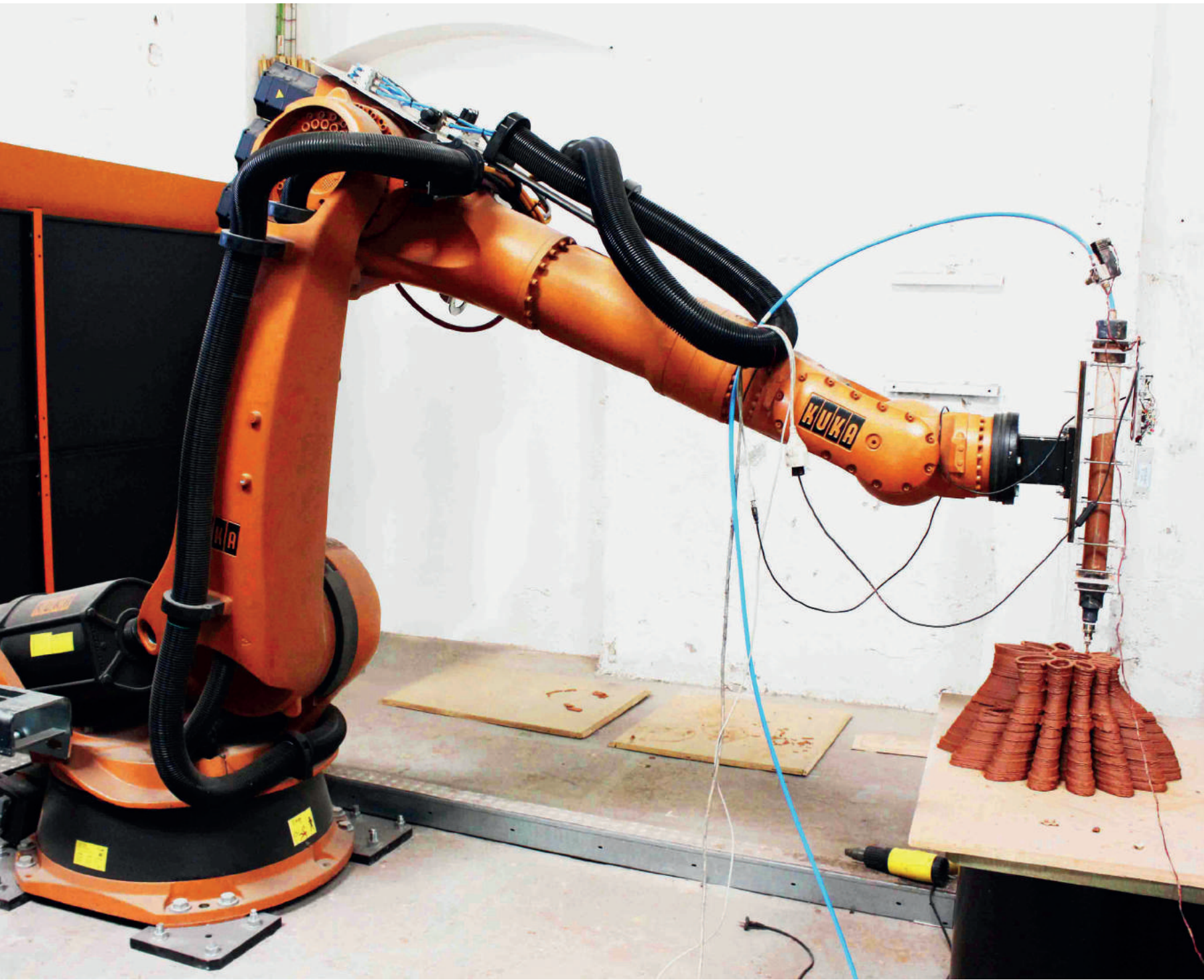

FABbots:

RESEARCH IN ADDITIVE MANUFACTURING FOR ARCHITECTURE

MARTA MALÉ-ALEMANY, JORDI PORTELL

FABbots is a compilation of projects that show ways of developing and adopting additive manufacturing in architecture, exploring 3D printing matter in a continuum and customised robotic tools for building on site. This research focuses on the use of locally available materials, hacking or reengineering existing mechanical devices, and developing custom software tools. It simultaneously engages material science, machine design and computation to guide the generation, simulation and evaluation of design solutions. This paper aims to share what has been learnt from these projects, promoting new forms of additive design and fabrication, and framing a vision for its future development and application in architecture.

INTRODUCTION

The growing interest in 3D printing and other additive manufacturing (AM) processes in most design-related domains has still found few responses in architecture. For several years, little has been explored beyond the early technological developments of contour crafting by Behrokh Khoshnevis, the freeform construction system by Rupert Soar and his colleagues and artificial sandstone printing by Enrico Dini and his company D-Shape. Yet, lately it seems that the use of AM in architecture is an expanding research field, as more designers and academic environments¹ are showing a greater interest in this topic.

In architectural practice (although these inventors have been promoting their machine and material processes for years), the potential of AM developments for construction has not yet been fully explored. Because they did not directly participate in its development or tested its implementation, architects have not yet embraced the fabrication and material constraints of the technology, which are key to unfolding its creative possibilities.

The FABbots research agenda² explores the integration of material science, machine design and computation to guide the generation, simulation and evaluation of novel design and

building solutions. Initiated in 2009 as a design studio brief,³ and presented as a research agenda at Fabricate 2011,⁴ today FABbots has become a compilation of 27 research projects⁵ developed in several schools of architecture.⁶ The range of proposals that have emanated from it shows the innovative potential of using customised robotic tools for building architecture with additive processes.

RESEARCH OBJECTIVES AND CONCERNS

FABbots explores the implicit design and fabrication possibilities of AM technologies. It embraces them as an alternative paradigm for construction, pursuing the production of an integrative, multi-material and multifunctional architecture built in a continuum. With that objective, it encourages an approach of 'learning by doing' with full engagement, to foster integrated machine-material processes that are specific to architecture.

FABbots seeks alternatives to the prefabrication of building components by promoting the use of autonomous fabrication devices on site. This vision stimulates and drives the projects' considerations on sustainability, choosing locally available materials and/or conceiving devices powered by renewable energies.

METHODOLOGY

Methodologically, FABbots combines three areas of knowledge: material processes, machine design and computation. This interdisciplinary approach⁷ supports innovative architectural design and fabrication opportunities. The work emerges from the intersection of these three domains, simultaneously exploring the use of materials suitable for building applications, the reengineering of mechanical devices or making custom robotic devices, and the programming of specialised software tools.

MATERIAL PROCESSES:

FORMING MATTER THROUGH ADDITIVE MANUFACTURING

Many FABbots projects test additive formation processes using known construction materials, starting a new method from scratch or following a material process from a previous project that proved to be suitable. Whatever way is chosen, the work requires acquiring knowledge on material behaviour concerning the physical and chemical properties of matter (before, during and after deposition). Tests are conducted to obtain the crucial data to inform later computer simulations.

Focusing on the intrinsic benefits of AM for creating complex material networks, FABbots comprises quite diverse and original methods. For instance, projects investigate alternative materials to the use of plastic and polymers for layer-by-layer deposition, using fast curing materials to 'print in the air' and eliminate scaffold material, casting phase-changing materials in fluid environments to build 'instant structures', adding material with multi-directional spray nozzles to overcome printing in layers, and shaping a deposition of iron-based paste with magnetic forces to challenge the effects of gravity.

Other projects investigate a very promising terrain for additive construction: using several materials with multi-deposition heads. Their aim is to test a multi-material architecture that benefits from both spatial intricacy and functional gradation within its built continuum.

MACHINE DESIGN:

HACKING, DESIGNING AND PROTOTYPING CUSTOM ROBOTIC TOOLS

The projects explore the customisation of devices or tools. This varies from developing nozzles that integrate with CNC mills to creating new end-effectors for industrial robots, or even prototyping completely new robotic systems.

Students use the school's fabrication equipment to make machine parts, and become familiar with programming, physical computing, and electronics.⁸ With additional open resourc-

es, they can easily prototype, program and test the functionality of their devices.

With these means, the projects have explored digitally-controlled deposition nozzles for sand, glue, cement and other materials, reused and recycled small inkjet printers and other appliances by hacking them for alternative uses, dismantled plotters and turntables to prototype different mid-sized devices, and collaborated with companies⁹ to bring these prototypes to professional robotic development.

COMPUTATION:

THE EMERGENCE OF DESIGN CATALOGUES THROUGH CODING MACHINE-MATERIAL SYSTEMS

Existing software is often inadequate for designing novel additive methods and running custom fabrication devices. New computational tools are needed to cover all the phases of design and production that have been altered by new machine-material approaches.

What gets built is not always 100% predictable; it emerges from the tension between the precise execution of an abstract machine code and the textured, low-definition features of the material itself while being shaped under varying conditions. Adaptability then lies in the printing code or program: its capacity to handle real-time data and its robustness to evaluate it and interactively generate new machine instructions. To use these dynamics as a creative design source, developing specific software¹⁰ is fundamental.

These custom computational tools enable generative design processes, where material complexity, machine specifics, and printing logics meet as the genesis of design. Design catalogues emerge by scripting the material properties and exploring plausible printing patterns and machine trajectories. By thoroughly studying the system and testing what it is possible to build, spatial opportunities naturally arise and reveal an intrinsic architectural language.

PROJECT OUTCOMES

A representative selection of the FABbots projects are presented in this paper. They represent three thematic groups to demonstrate individual research efforts and contributions.

The first group of projects are those that look at existing AM processes and reconsider them for architectural uses, using materials and processes that could also be suitable on a larger scale.¹¹

— Both the projects DIGITAL VERNACULAR and FABCLAY¹² explore 3D printing with clay. Material samples are made by attaching a

Fig. 2: FABCLAY Project, developed by Nasim Fashami, Saša Jokić. Starski Naya. FABbots 3.0, IaaC, 2012. Printed building component in clay, specifically programmed for continuous material flow. (Photo: Saša Jokić.)



custom deposition head for paste-like materials to an existing CNC machine or industrial robot (figs. 1, 2).¹³

- PET FLAKES is a customised fused deposition modelling (FDM) technique for architecture. Exceeding the limitation of layer-based conventional FDM machines, three-dimensional, tubular building structures are printed out of recycled thermoplastics, which solidify in the air immediately after being deposited.¹⁴

- ARE(A)NA, FLEXIMOULDS and SANDSTONE(D) use sand as a scaffolding system to shape other materials. In the first two cases, sand is piled up following generative patterns and a liquid binder or a paste-like material is deposited and shaped on top of those formations. In the last case, a binder is injected into a sandy ground. After a curing phase, the sand is removed or excavated to reveal the solidified structures (fig. 3).¹⁵

The second group comprises projects that focus on inventing new additive methods using unconventional materials or processes.

- FLUID CAST explores the opportunities of fast solidification of phase-changing materials (like wax) in water, calibrating

Fig. 3: ARE(A)NA Project, developed by Miguel Guerrero, Chryssa Karakana, Carolina Miro, Anastasia Pistofidou. FABbots 2.0, IaaC, 2011. Left: Binder flow simulation and structural deformation simulation. Center: Machine-material test of binder deposition over a programmed sand formation. Right: Digitally produced, fractal sand formation. (Photos: Miguel Guerrero.)

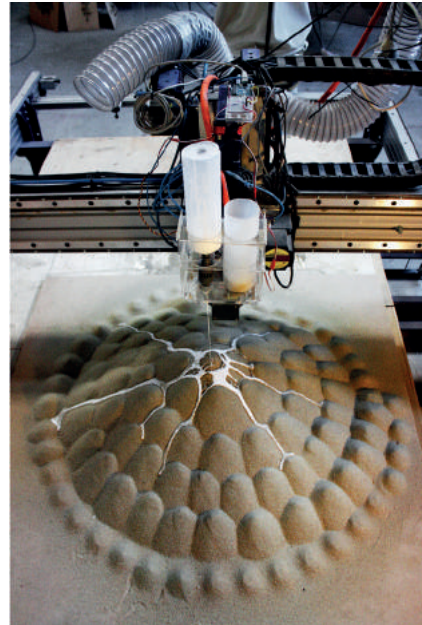
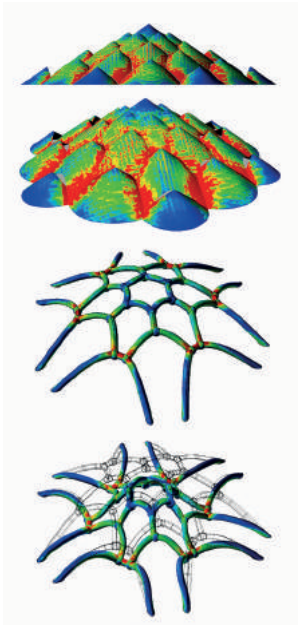

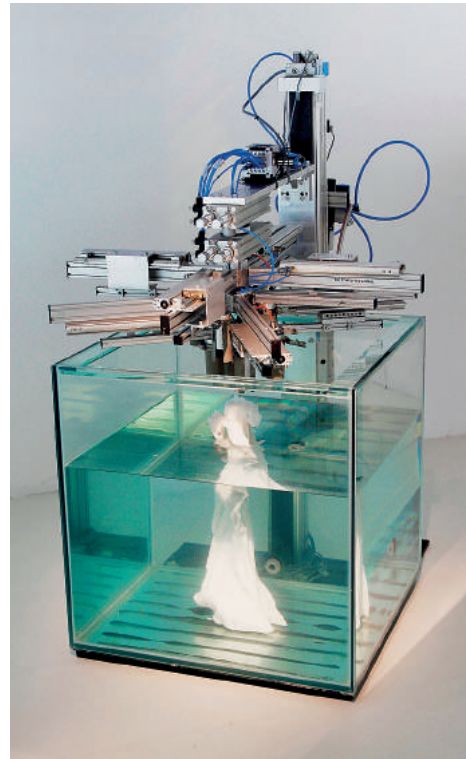
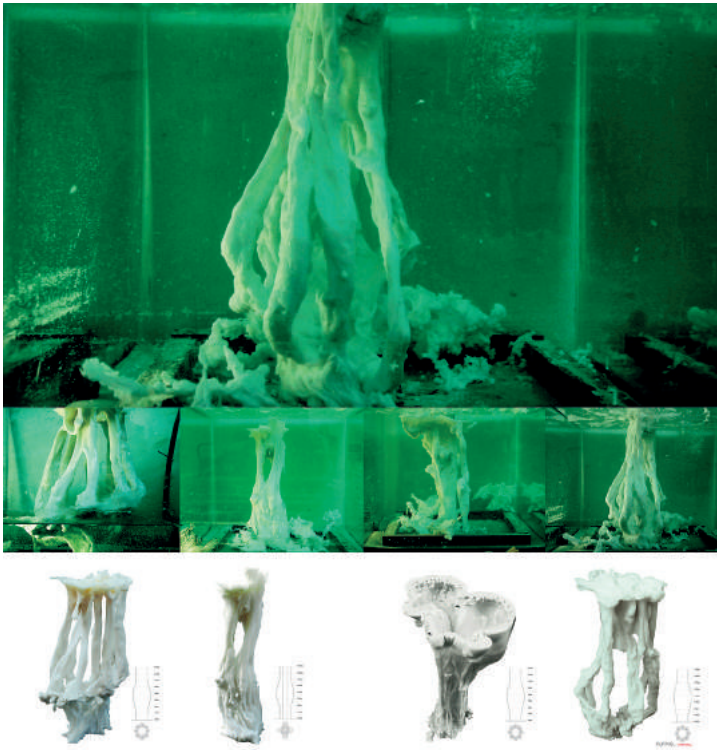

Fig. 4: FLUID CAST Project, developed by Jaime De Miguel, Ena Lloret, Catalina Pollak, Maria Eugenia Villafane. Machinic Control v.i.o. AA DRL, 2009. Left: Material samples of wax in water. Images by FLUID CAST team. Right: Custom CNC wax injection machine. (Photo: Oriol Rigat.)

the precision of a digitally controlled deposition and its unpredictable behaviour in fluid dynamic environments. This project proposes building floating large-scale structures using a swarm of underwater deposition robots (fig. 4).

- **STONE SPRAY** is a multidirectional, spray-based additive construction method. It uses granular materials (i.e. sand) and a binder with a very fast drying time and exceptional structural capacities to solidify them on site. Attached to a five-axis robot, a CNC sand-binder spray can build stone-hard, complex structures (fig. 5).

- **MAGNETIC ARCHITECTURE** is an additive process that uses digitally controlled magnetic fields to drive material deposition and solidification.¹⁶ By positioning two strong magnets in space and using the control of a CNC machine or specialised robot arm, one can create sequences of longitudinal elements to form complex structural beams and wall formations (fig. 6).

Finally, the third group consists of projects that explore multi-material additive solutions.

- **NGPS** is a multi-material fabrication technique based on depositing calcium-based paste droplets into a water and algae solution.¹⁷ The chemical reaction produces the solidification of the building material, forming spherical voxels, which can be arrayed in space, while they stay in suspension in the liquid, unaffected by gravity (fig. 7).

- **POROCITY** explores a variable composition 3D printing technique, with a digitally controlled printing head that can deposit a specific mix of cement and foam balls. Following nature's strategies and functionally graded materials, elements such as columns are built by optimising density distribution.

- **HOSMENOS** and **MATWORKS**¹⁸ investigate multi-material additive techniques to build complex material networks and explore functionally diverse architectural applications by mixing

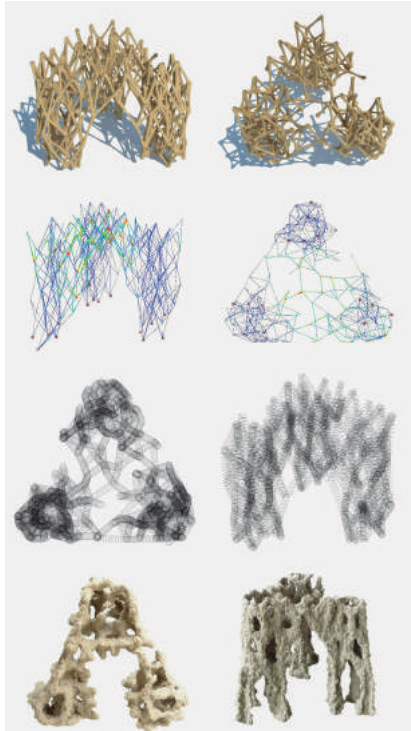

Fig. 5: STONE SPRAY Project, developed by Anna Kulik, Petr Novikov, Inder Parakash Singh. FABbots 3.0. IaaC, 2012. Left: Different phases of simulation culminating in a printed sample. (Photos: Stone Spray team.) Right: Small-scale material prototype of solidified sand and binder, which explores plausible structural topologies that can be achieved by a multidirectional deposition technique.

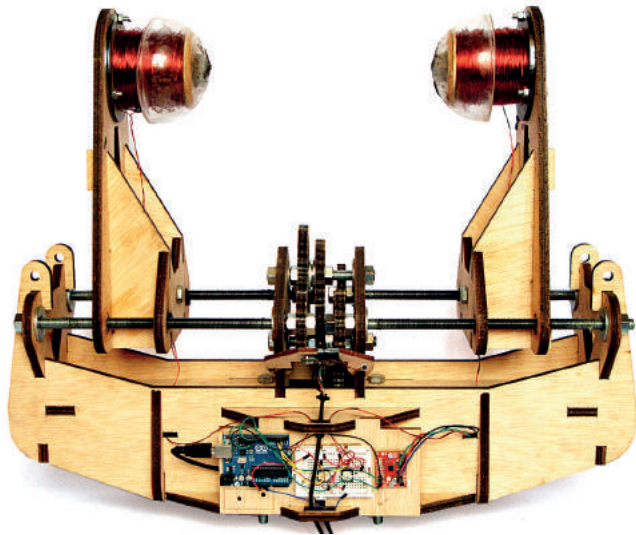

Fig. 6: MAGNETIC ARCHITECTURE Project, developed by Gabriel Bello, Alexandre Dubor, Akhil Kapadia, Angel Lara. FABbots 3.0. IaaC, 2012. Left: Custom-made, digitally controlled magnetic clamp. (Photo: Jordi Portell.) Right: Complex formation of iron and binder matter, built with a magnetic clamp that can be positioned in multiple directions. (Photo: Akhil Kapadia.)

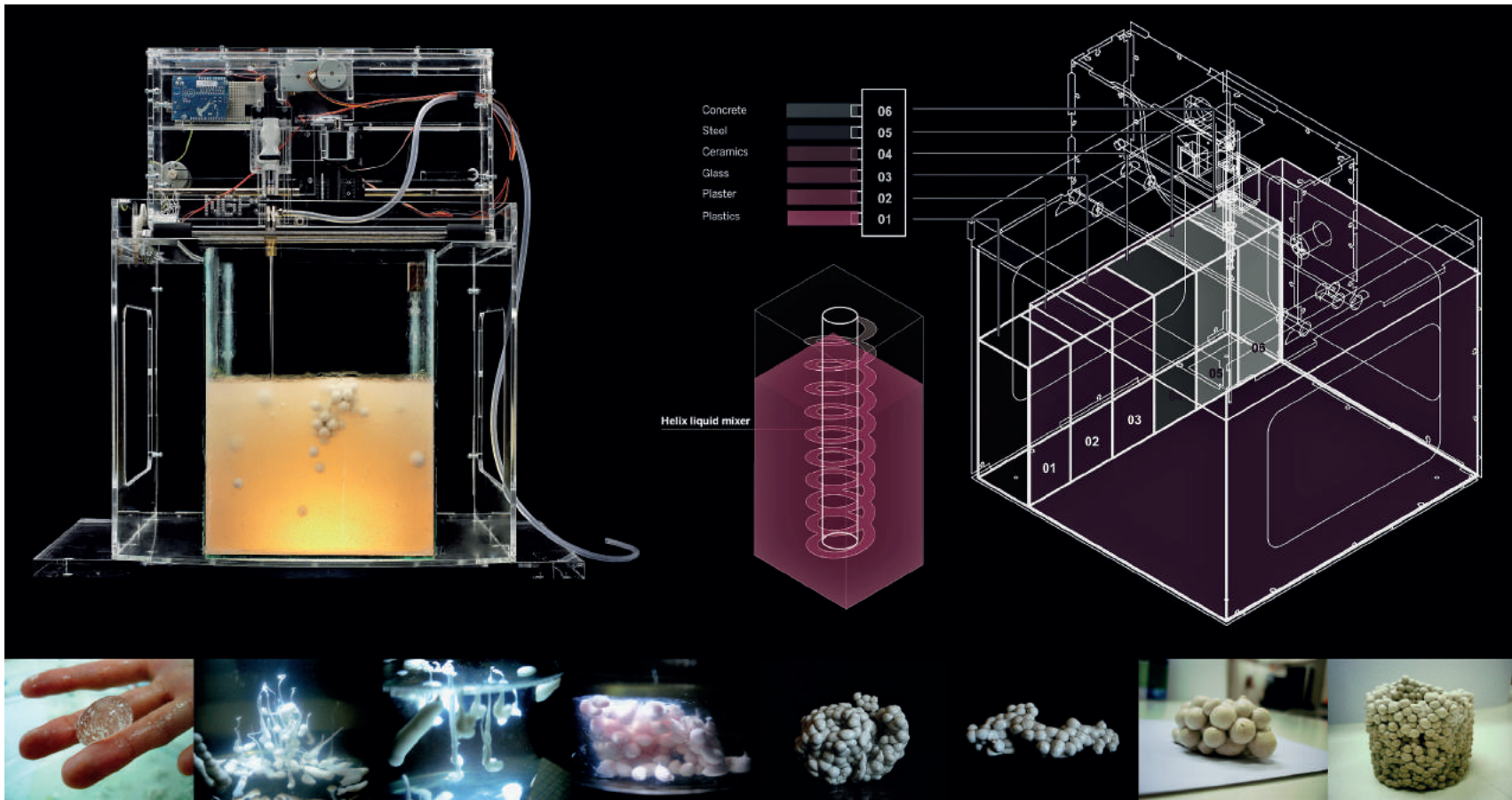

Fig. 7: NGPS Project, developed by Ali Basbous, Miquel Lloveras. FABbots 1.0, IaaC, 2010. Left: Machine prototype with filled tank. (Photo: Diaz Wichmann Photography.) Right: Machine diagram showing multi-material capabilities. (Image: NGPS team.) Bottom: Material spherification samples. (Photos: Miquel Lloveras.)

granular materials such as dry mortar, sand and sawdust with a digitally controlled multiple deposition head (fig. 8).

CONCLUSIONS

LESSONS FROM THE PROJECTS

Collectively, FABbots shows how today's digital architects can not only code their own design tools, but also develop custom fabrication devices to innovate construction processes.¹⁹ The experience of guiding these projects and assessing the results has motivated some reflections:

- ON MATERIALS: The work shows that AM technologies can use existing construction materials (e.g. sand) in novel ways, and also that it is possible to bring unconventional materials into the architecture realm. In both cases, the spectrum of ma-

terial choices and opportunities for AM in architecture is very promising. It is especially interesting when projects choose natural or recycled construction materials, which are widely available, to explore new ways of building that are also more sustainable.

- ON ACCURACY: In return, these materials are often heterogeneous, and exhibit different behaviour during deposition, solidification and/or curing, thus creating a formal inaccuracy that is, nonetheless, fully accepted in our philosophy. In opposition to the tendency found in industrial applications of 3D printing, where fine results are fundamental, in these projects, it is acceptable that additive construction does not work within the same finishing requirements.

- ON TEXTURE: FABbots thus promotes an approach for ad-

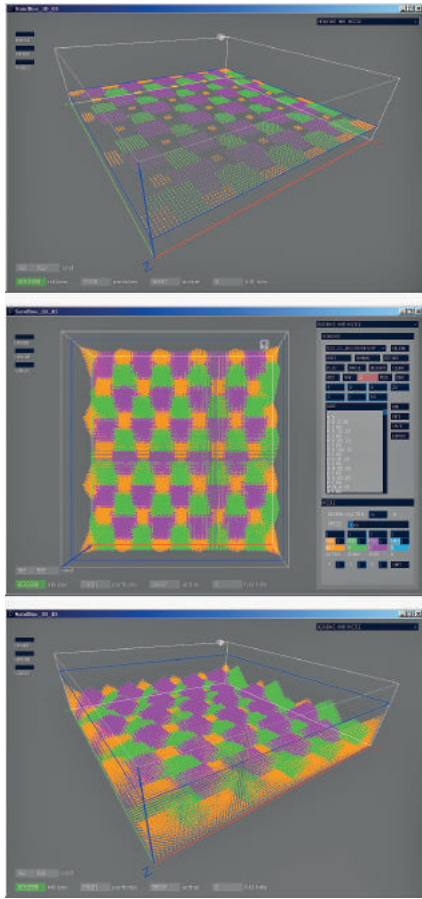

Fig. 8: MATWORKS Project, developed by Martin Firera, Julian Hildebrand, Ohad Meyuhas, Jordi Portell. FABbots 2.0, laaC, 2011. Left: Custom sandbox simulation software, used to reproduce the deposition of granular materials. Right: Multi-material deposition process.

ditive fabrication that welcomes the unpredictable beauty of emergent forms, valuing their material expression and texture. The projects accept printing deviations and material flaws in a creative way, using custom software to play with built-in tolerances and develop design catalogues that are conceived as adaptive printing codes.

- ON REAL-TIME ADAPTATION: The hypothesis of using 3D printing for buildings with robots on site necessarily implies the acceptance of a printing process that is influenced by environmental changes. In this respect, some attempts have been made using artificial vision tools and other forms of sensing to embrace these material dimensional changes or printing irregularities, exploring additive processes with continuous feedback and adaptation. Ensuring real-time evaluation and

fabrication control is key to working with materials that are suitable for construction and yet behave irregularly, as well as autonomous machines on site that are exposed to unregulated conditions.

- ON SCALABILITY: The value of the FABbots work is that at all phases of project development, the samples produced are not representations or models, but working prototypes of the proposed machine-material system on its current (actual) scale. Yet, considering the goal of real architectural applications, the scalability of the processes is still unresolved and, in a way, the work is in its infancy. There is thus full awareness that new challenges will appear when making larger prototypes, because the behaviour of both the construction material and the machine itself will not scale linearly to a larger size.

SEEDS FOR FUTURE RESEARCH AND APPLICATIONS

FABbots has shown different strategies for developing, adopting and seeking applications for AM methods in architecture, envisioning future on-site deployment. Thus, it is crucial to clarify the research directions that should be undertaken to continue the research:

- Increasing the scale of robotic devices to allow additive fabrication on-site.
- Further exploring widely available and local materials, with a specific interest in sustainable solutions.
- Expanding creative ways of designing architectural solutions, while integrating the not-yet-programmed textures that emerge from printing natural materials under varying environmental influences.
- Allowing for design and fabrication adaptability by scripting interactive printing codes with real-time feedback.
- Complementing these custom scripts with analysis features to optimise the printing patterns into meaningful material networks that can effectively improve building performance.

This work requires experts beyond architecture, including mechanical and robotic engineers, material scientists, software developers, environmental physicists, biologists and others. Integrating these multidisciplinary fields will ensure that architects are involved in the development of technological and creative opportunities intrinsic to additive fabrication. As a consequence, future projects will show greater maturity and be closer to real application. Taking into account the multiple demands of architecture (functional, aesthetic, energetic and other), this situation may help develop disciplinary reciprocity. In addition, pursuing this research can contribute to the development of AM methods, tools and processes also desirable for other fields.

ACKNOWLEDGEMENTS

The authors of this paper would like to acknowledge all the participants, teaching staff and external consultants of the various design studios, as well as the companies who directly contributed to support the FABbots research agenda. These are architects Jeroen van Ameijde, Daniel Piker, Victor Viña, Cesar Cazares, Luis Fraguada, Brian Peters, Jordi Portell, Miquel Lloveras, engineers Santiago Martin Laguna (Vórtica) and Santiago Martin González (Univ. of Oviedo), and the companies FESTO and KUKA. The selection of projects presented here includes the following authors, in order of appearance:

DIGITAL VERNACULAR: Shankara S. Kothapuram, Ling Han, Mei-Ling Ling, Jiawei Song (AA DRL 2009); FAB CLAY: Nasim Fashami, Saša Jokić, Starski Naya Lara (IaaC, 2012); PET FLAKES: Akram Ahmed, Pavlos Bakagiannis, Theodoros Grousopoulos, Christiana Vlanti (IaaC, 2012); ARE(A)NA: Miguel Guerrero, Chryssa Karakana, Carolina Miro, Anastasia Pistofidou (IaaC, 2011); FLEXIMOULDS: Bhavya Bora, Guruprakash Govindswarmi, Ranjini Manimudi, Raja Vignesh (IaaC, 2012); SANDSTONE(D): Antonio Atripaldi, Ayber Gulfer, Andrés Briceño, Mani Khosrovani (IaaC, 2011); FLUID CAST: Jaime de Miguel, Ena Lloret, Catalina Pollak, Maria Eugenia Villafane (AA DRL, 2009); STONESPRAY: Anna Kulik, Petr Novikov, Inder Parakash Singh (IaaC, 2012); MAGNETIC ARCHITECTURE: Gabriel Bello, Alexandre Dubor, Akhil Kapadia, Angel Lara (IaaC, 2012); NGPS: Ali Basbous, Miquel Lloveras (IaaC, 2010); POROCITY: Lana Awad, Seiichi Suzuki, Jianhong Wu (IaaC, 2012); HOSMENOS: Eugenia Diaz, Kai Sun Luk, Alan McLean, Daniel Silverman (AA DRL, 2010); MATWORKS: Martin Firera, Julian Hildebrand, Ohad Meyuhas, Jordi Portell (IaaC, 2011).

NOTES

- 1 In addition to the research guided by Marta Malé-Alemany, the use of additive building methods in architecture was investigated earlier in experimental design studios and courses in a few academic environments, such as those led by Ronald Rael, François Roche, Wes McGee, Peter Testa, Fabio Gramazio and Matthias Kohler, Neri Oxman and others. Nowadays, this research is expanding and becoming present in most advanced schools of architecture.
- 2 FABbots is the research agenda of a series of design and research studios directed by Marta Malé-Alemany in different schools of architecture. It includes a collection of 27 projects developed by master level students working in teams. The studios were taught at the AA DRL in London and at IaaC in Barcelona, supported by expert tutors in computation and fabrication (Victor Viña, Cesar Cazares, Jeroen van Ameijde, Daniel Piker, Luis Fraguada, Brian Peters, Jordi Portell, Miquel Lloveras) and consultants in engineering (Santiago Martin Laguna/ Vórtica, Santiago Martin González/ Univ. Oviedo).
- 3 The first design studio on this topic was originally named Machinic Control and was taught at the AA Design Research Lab in 2009. The studio was directed by Marta Malé-Alemany, assisted by Jeroen van Ameijde.
- 4 The FABbots research agenda was formally presented to the architectural community at the Fabricate Conference 2011 in London with a public lecture titled: FABBOTS: Customised robotic devices for design and fabrication. Marta Malé-Alemany, Jeroen von Ameijde, and Victor Viña, 'FAB(BOTS)', in Ruairi Glynn and Bob Sheil, eds., *Fabricate: Making Digital Architecture* (Cambridge, Ont.: Riverside Architectural Press, 2011), pp. 40–7.
- 5 The projects are documented chronologically at www.fabbots.com.
- 6 At the Architectural Association (AA) in London (2009–2011) and at the Institute for Advanced Architecture of Catalonia (IaaC) in Barcelona (2009–2012).
- 7 This approach is possible through the collaboration between the studio design faculty and external advisors in various disciplines (mechanical engineering, physical computing, etc.), as well as through active involvement of the students in self-educating themselves via online tools and communities.
- 8 See open source programming tools like Processing (www.processing.org) and physical computing environments like Arduino (www.arduino.cc).
- 9 This is the case with the company FESTO, who collaborated with the project team of FLUID CAST to build up a 1:1 scale version of their robotic multi-nozzle prototype for casting hot wax on water.
- 10 FABbots projects often involve programming custom software in issues such as shape generation, physical simulations, structural analysis and optimization, visualization and machine control.
- 11 Conceptually, this is a similar approach to how D-Shape was originally inspired by the technology of Z-Corp, or contour crafting by FDM.
- 12 FABCLAY is an example of a project that follows the material research initiated by an earlier project (DIGITAL VERNACULAR), exploring further steps and development for the same technology.
- 13 Both these projects found great inspiration in the work of the Belgian design studio UNFOLD (<http://unfold.be/pages/projects>).
- 14 The work of PET FLAKES later became the source of inspiration for MATAERIAL, a robotic epoxy-based extrusion system, developed as a commercial endeavour by two FABbots students (Petr Novikov and Saša Jokić) in collaboration with Joris Laarman Studio in The Netherlands.
- 15 The SANDSTONE(D) project was inspired by the 2007 AA thesis project 'Dune' by Magnus Larsson (<http://www.magnuslarsson.com/architecture/dune.asp>).
- 16 The MAGNETIC ARCHITECTURE material research was inspired by the Gravity Stool, a design by Jolan van der Wiel (<http://cargocollective.com/studiovanderwiel>).
- 17 The algae solution used by NGPS is a product developed by Spanish cook Ferran Adrià for a cooking technique called spherification (<http://www.albertyferranadria.com/eng/texturas-spherification.html>).
- 18 MATWORKS follows up on the material research initiated by project HOSMENOS, exploring further steps and development for the same technology.
- 19 Some of the earlier developments of FABbots and reflections have been elucidated in C. Ipser, ed., *Fabvolution. Advances in Digital Fabrication* (Barcelona: Ajuntament de Barcelona / Institut de Cultura – Disseny Hub Barcelona, 2012).

Fig.1: Mixed reality modelling: prototypical set-up for recursive wax forming.

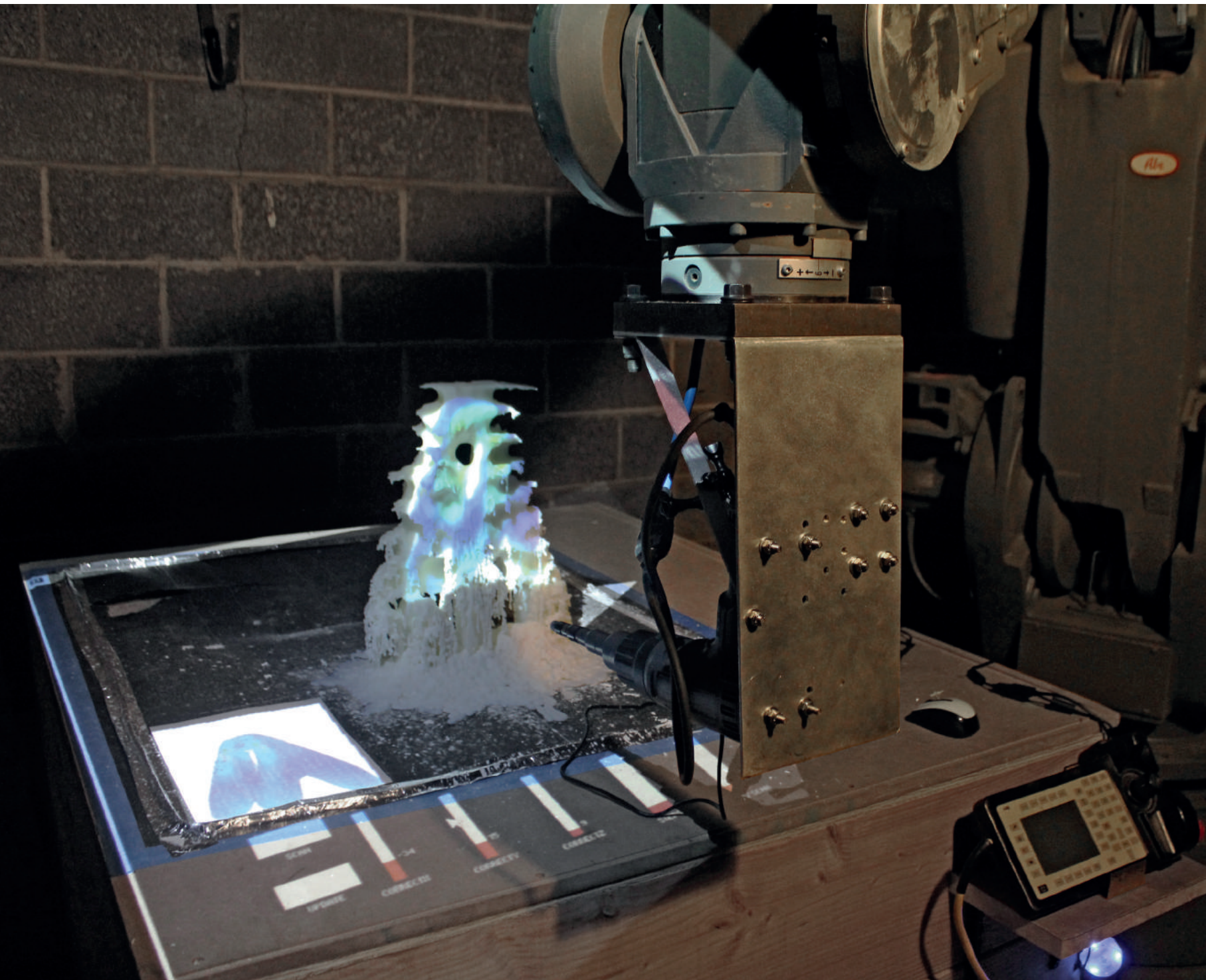

AUGMENTED MATERIALITY: MODELLING WITH MATERIAL INDETERMINACY

RYAN LUKE JOHNS (GREYSHED AND PRINCETON UNIVERSITY, UNITED STATES)

The digital revolution has instigated numerous changes to the architectural design process, which have distanced physical and intuitive material exploration from the standard procedures and protocol of the discipline. By combining augmented reality technologies with real-time computer simulation, sensory feedback and robotic fabrication tools, new workflows enable the architect to design spontaneously and intuitively with seemingly stochastic material processes while managing the complex performance criteria associated with 'highly informed' design. This paper presents a prototypical design process to these ends and discusses this approach and its implications in relation to alternative workflows as practised in architectural design and fabrication.

INTRODUCTION

With the advent of CAAD (computer-aided architectural design) and CAM (computer-aided manufacturing) technologies, both design and construction processes tend to unfold at abstract scales, effectively dissolving any organic link between human metric and material production. The current paradigm, characterised by the massive influx of digital design and computer-aided fabrication tools, could easily be mistaken for a shift solely towards architectural automation and, in turn, a move away from human intuition. New forms of digital mediation, however, provide the potential to bridge the gap that has divided human sensibilities and material properties in the design process, thus ushering in a new kind of craft that is both materially responsive and 'highly informed'.¹

As movement between each side of the digital/physical dichotomy becomes easier with the development of fabrication and digitisation technologies, a multitude of other bilateral relationships are being called into question. Recognising that the once resolute distinctions between digital/physical, man/machine, design/construction, and stochastic/deterministic dichotomies are fading, this research explores how the simultaneous occupation of multiple realms, or all of these realms, might benefit architectural design. Borrowing from the princi-

ples of computer threading, the aim of this project is to break up and interlace these previously distinct elements of the architectural design and fabrication process in order to render once linear and differentiated components concurrent.

This research commenced with the application of this design-threading strategy to a simple milling exercise. By sending only one movement command at a time to the robotic manipulator, the computer software provides a real-time visualisation of the robot's toolpaths, and allows the designer to modify these toolpaths (and thus the design) at any stage of the machining process. Drawing closer to the intent of the research, the project evolved into a recursive design-fabrication exercise which combines physical human input with the robotic manipulation of a stochastic material process (melting wax). By rapidly scanning a physical object while also melting it, the system attempts to achieve a topologically optimised result based on the given wax volume and user-placed loading conditions. A multitude of constantly communicated variables give simultaneous control to the human operator, the computer simulation, the robotic manipulator, and the material process. These elements become inseparable, and their individual import becomes indistinguishable from that of the global system.

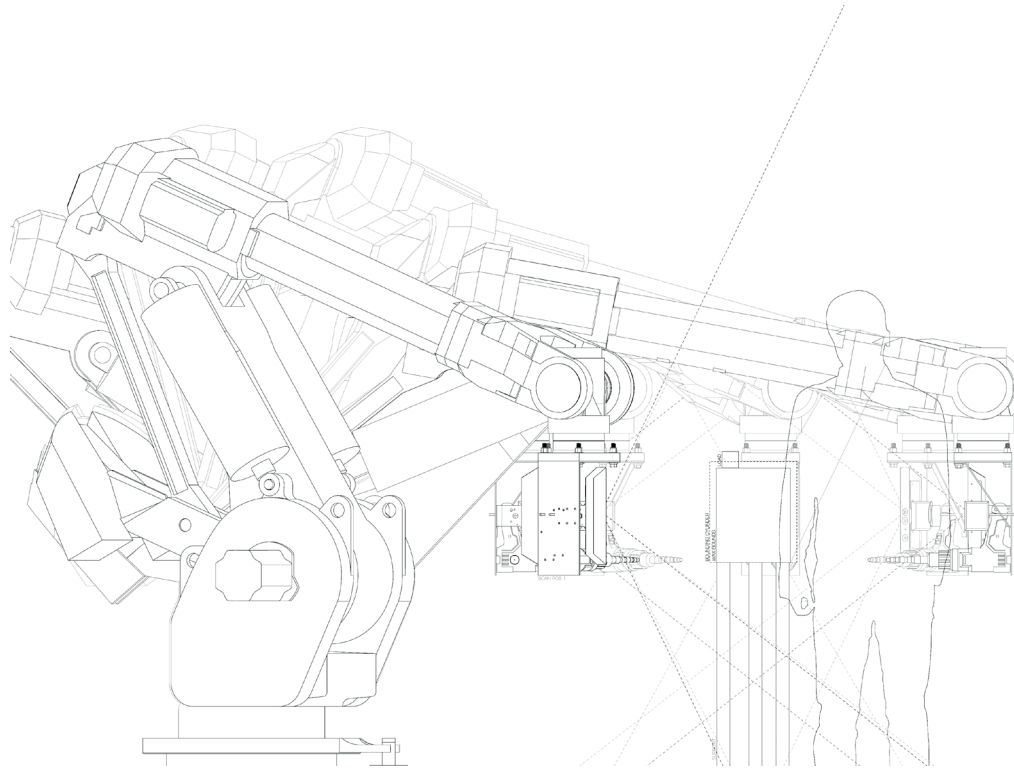

Fig. 2: Set-up elevation.

RELATED WORK

The use of bidirectional computational models and recursive (or circular) explorations is discussed at some length in Kilian's thesis, *Design Exploration through Bidirectional Constraints*,² while 'the premise that material, structure, and form can become inseparable entities of the design process' is presented by Neri Oxman.³

Mixed reality systems that link a physical interface with a digital architectural model can be found in the early experiments of John Frazer⁴ and in a variety of more recent projects.⁵ A number of research papers have engaged gestural design, augmented reality⁶ and interactive fabrication.⁷

The use of robotic manipulators to procedurally inform computationally indeterminate material processes has been explored in Roxy Paine's *Erosion Machine*⁸ and the *Procedural Landscapes* project of Gramazio and Kohler.⁹

Recognising the wide array of precedents for the individual components behind this research, this paper seeks not to explore any singular innovation, but rather to investigate the potential for combining a variety of existing technologies and principles in the early stages of design and fabrication. This amalgam fosters an intuitive control of digital fabrication tools, and in turn provides the potential to recursively manipulate stochastic material systems.

INITIAL RESEARCH: INTERACTIVE MILLING

Intuitive interaction with digital fabrication tools is severely limited by the lack of communication between the operator and the tool. While CNC (computer numerical control) mills and robotic manipulators excel in realising the digital, they cannot easily convey the complexity of their actions during the fabrication process. As fabrication procedures become more highly informed, the human operator becomes less informed of the global significance of any given operation. If the designer is to have real-time influence upon the fabrication process, he must be capable of recognising what the robot is doing at any given moment so that he may immediately grasp the role of that action in the larger and more complex narrative of the overall design.

In order to experiment with live manipulation of a design during the fabrication process, a prototypical milling technique was developed that allows the operator to see and modify the robot's toolpaths in real-time. In this set-up, an augmented reality interface provides the operator with a live preview of the robot's projected toolpaths, and allows the user to modify those toolpaths by tapping on the screen in the area where he would like to focus the mill (fig. 4).¹⁰ Rather than sending the entire milling operation as one predetermined batch of commands, the software running on the tablet sends only one

Fig. 3: Detail of wax model: indeterminate accrual.



Fig. 4: Interactive milling: The robot's toolpaths are overlaid with live video of the milling operation. Touching an area of the screen causes the robot to immediately move to and mill in that area.

movement command to the robot at a time. This allows the user to insert new movements at the front of the buffered command list at any time, ensuring that the system essentially operates on the scale of 'byte to robot' rather than 'file to factory'.

DYNAMIC MATERIALS

The prototypical milling set-up helped to establish a communication protocol with the robot and represented a shift towards both *informed-operator* and *operator-informed* fabrication. However, the determinacy of milling seemed to restrict its potential to convey interesting iterative communication between the physical material and the digital model. The subtractive result of the milling operation is always in direct parallel to the simulated Boolean operations of the computer model. This research, however, is specifically interested in the use of digital fabrication tools to allow informed control and design using materials that are not entirely predictable with computer simulations. To this end, it was necessary to experiment with a stochastic material process that engaged computationally difficult properties, such as fluid or thermodynamics, erosion, organic growth and decay, chemical reactions, etc.

Considering the realistic limitations established by current processing capability and the slight delays associated with the established communication protocol, wax-melting was selected as an intermediate material process for further experimentation. Wax is relatively indeterminate when heated, but cools rapidly enough to enable momentary lapses in the process. It thus affords time, when necessary, for contemplation and re-calculation.

This material process was also of interest because it occupies a space between *subtractive* and *additive* fabrication that is not precisely or predictably *formative*.¹¹ Much of the heated wax flows into new areas, cooling and accruing, while some falls from the work object or is vaporised.

SET-UP

This project represents a prototypical design/fabrication process that demonstrates the concurrent coordination of digital simulation with stochastic material properties, human design decisions and robotic manipulation. It thus encompasses a wide array of variables of varying complexity, which prove desirably difficult to convey as a linear narrative. While the elements of the project are presented below sequentially, in reality, they frequently operate simultaneously or are interspersed with one another. These are the primary components of the experiment:

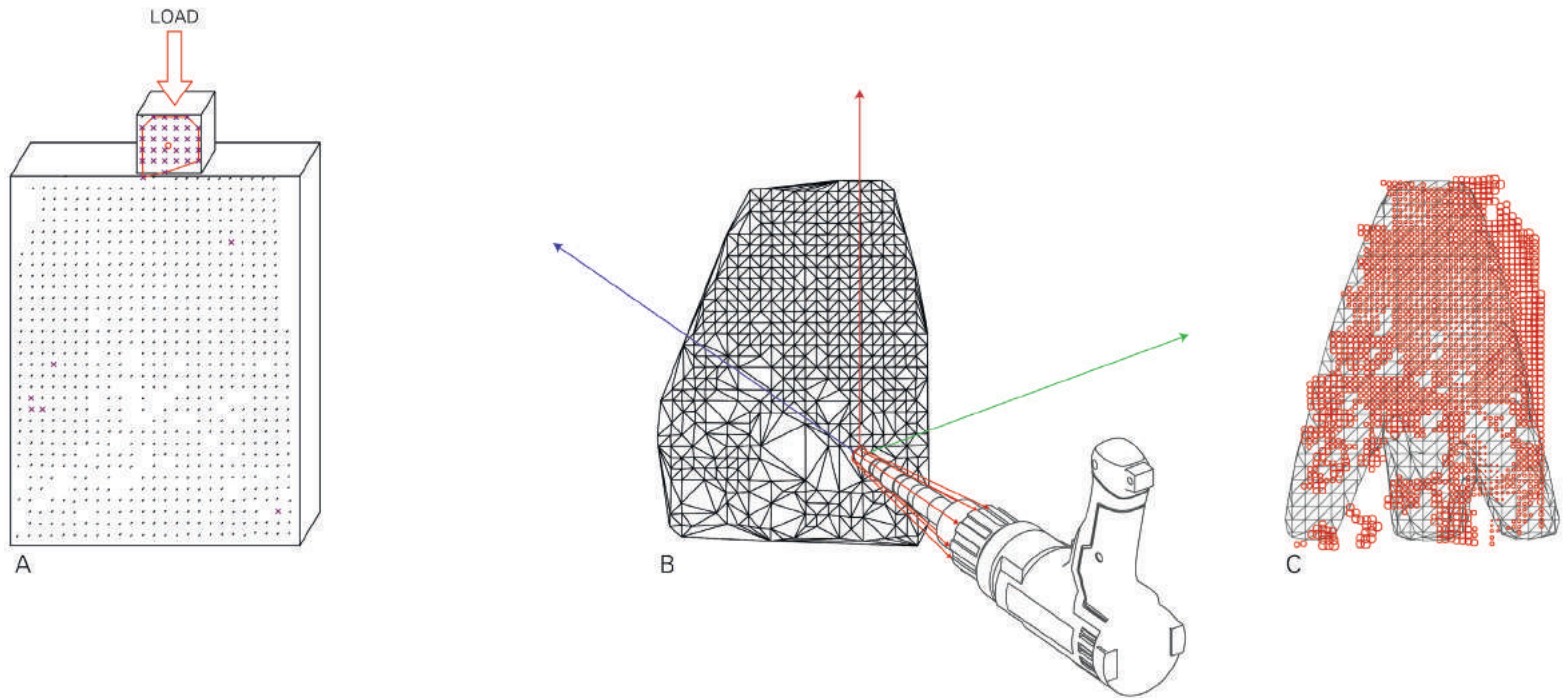

Fig. 5: Select software operations: a) Separate specifically coloured points (purple) and isolate clusters of a given size. Find centroid of convex hull and place virtual load. b) Triangle mesh created from Kinect scan for ray-based collision test. c) Sort scan points by distance to nearest vertex.

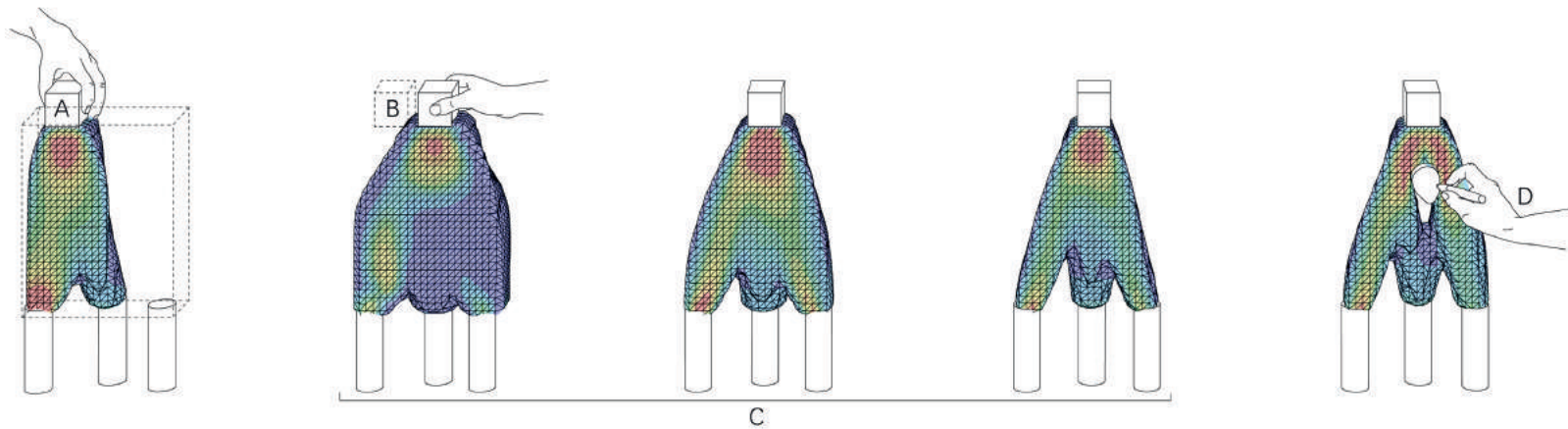

Fig. 6: A simple modelling narrative illustrated. a) Load is placed and forces are calculated. b) User decides to shift load. c) Reduction of volume. d) Void area indicated with a coloured marker.

- The process begins when the user places a wax block upon any number of supports and within the working range of the robotic manipulator.
- The human operator has access to coloured wooden blocks that represent downward load forces, and he can place any number of these upon the wax in any desired configuration.
- The robotic manipulator is equipped with an end-effector consisting of an electric heat gun and a Kinect scanner.¹² It moves to an initial scanning position, where the Kinect provides a coloured 3D point cloud of the wax block, its loads and supports.
- The computer software (written in Processing, a programming language) communicates constantly with the robot's controller and the Kinect.¹³ The local coordinates of the scanned Kinect point cloud are transformed into the world coordinate system of the robot and the digital scene using the position and orientation values of the end-effector.
- The software locates the physically placed load blocks within the digital model by first sorting all points of a given colour (in this case, purple) into clusters. By finding the area of the convex hull of these clusters and checking if this area corresponds to that of the wooden block, it finds which 3D points represent load forces.¹⁴ A virtual load-block is then placed at the centroid of each qualifying cluster (fig. 5a).
- Considering the wax volume and its corresponding support and load conditions, the software calculates the regions of material that are most (and least) essential for structural performance using topological optimisation.¹⁵
- The software sorts the digitally scanned points, which represent the physical wax volume, by their distance to the result of the topological optimisation calculation, or rather, in order of structural necessity (fig. 5c).
- Following this calculation, the robot proceeds to heat a given number of these points for a duration proportionate to their distance from the structural core. It thus melts or vaporises the wax around each location.
- At any point in this process, the user can draw with a coloured marker to indicate desired void areas in the wax volume. Employing the same strategy used to find loading conditions, the software removes these areas from the topological optimisation calculation, thus routing the structure around the opening and thickening it where possible to compensate for this change.
- The user can shift the load conditions, remove some or add others at any point in the process (fig. 6).
- As with the interactive milling experiment, an augmented reality interface informs the user of the digital model and the projected movements of the robot. Using a digital projector,

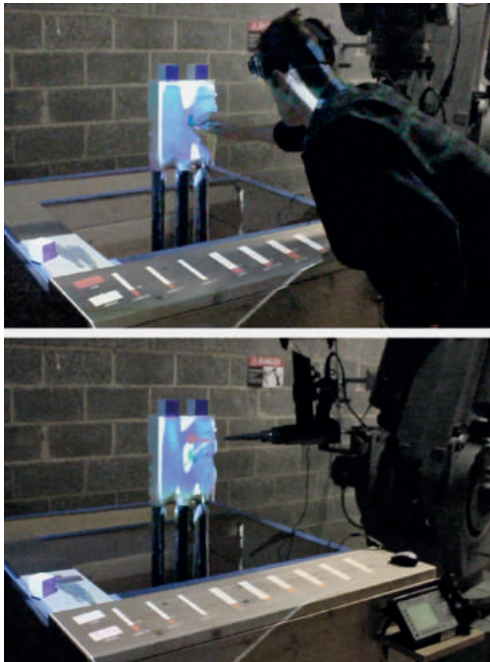

Fig. 7: Above: Desired void areas are physically indicated using a coloured marker. Below: The virtual model is automatically reconfigured around the indicated opening and the robot proceeds to melt away this area.

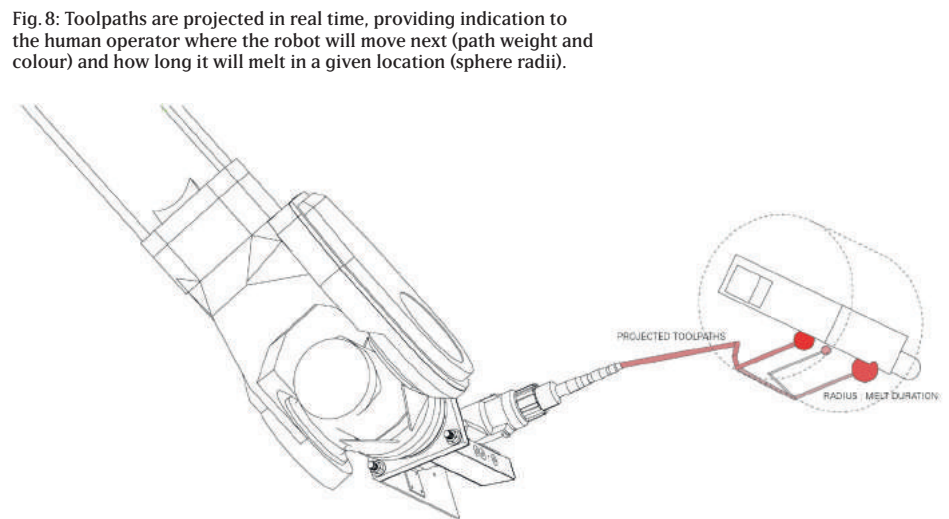

Fig. 8: Toolpaths are projected in real time, providing indication to the human operator where the robot will move next (path weight and colour) and how long it will melt in a given location (sphere radii).



Fig. 9: Wax model. The result of the operations illustrated in figure 8.



Fig. 10: Wax model. Two downward loads and asymmetric supports.

the virtual information is mapped (fig. 7) directly onto the wax surface.¹⁶ It illustrates not only the future toolpaths of the robot, but also the duration of each melt position (as spheres of varying radii) (fig. 8), the topological optimisation model, the visible scan points, and the digitally referenced support and load geometries. A second stationary Kinect tracks the user's head position and aligns the virtual camera with this location so that, from the perspective of the user, the projected information is visually aligned with the physical world and the movements of the robotic manipulator. This removes the need to hold a cumbersome tablet, though it has the necessary limitation of being optimised for a single user.

- By triangulating the scanned point cloud and mathematically testing a ray-based approximation of the end-effector for intersection with these triangles, the software prevents physical collisions between the robot and the wax volume (fig. 5b). This allows the robot to melt the wax from the closest desirable distance without fearing collisions.
- Assuming that the melted wax generally flows downwards, the software recognises over-melted areas and is capable of prioritising points above these locations so that the dripping wax helps fill the problematic cavity.

DISCUSSION

Rather than developing design in a linear progression from idea to computer-simulated model to fabrication tool and material result, the process allows these elements to operate concurrently or in rapid and recursive succession. This allows each component of the design process to inform the other from the onset. Recognising the co-dependency of these elements, the process cannot proceed without the simultaneous cooperation of its four players: the human designer, the robotic manipulator, the computer simulation, and the material reaction. This allows the designer to engage physical materials in the modelling phase and to learn from this interaction, just as one gleans scalable structural problems from an unstable architectural model. Furthermore, by employing both computer calculation and robotic execution, it becomes possible to integrate highly informed articulation and advanced material dexterity with the more traditional components of the initial design process.

While this process used the computer simulation for structural optimisation and melting wax as the material system, these components are merely placeholders for potential relationships with higher degrees of complexity and variance. On the side of computer scanning and calculation, for example, the process could be expanded to account for site-specific build-

ing codes or program requirements. These factors would make themselves apparent among the earliest design decisions, thus ensuring that they would not jeopardise the original design intent. With regard to the material system, the advent of safer, faster, lightweight and purpose-built robotic solutions coupled with developments in software and processing capability (providing, for example, faster-than-real-time calculation of fluid dynamics) could enable control over larger and more indeterminate material relationships. This project imagines a future in which real-time modelling with stochastic physical systems such as erosion, insect behaviour, plant growth, or lava flows might be not only possible, but intuitive. Just as the material properties of hanging-chain, clay, or paper models link them with certain formal typologies, so might these developments in physical modelling inform a new variety of formal variation.

ACKNOWLEDGEMENTS

This research owes much to the faculty of the Princeton University School of Architecture who advised the project during my thesis semester (Axel Kilian, Elizabeth Diller, Ryan Neiheiser, and Jesse Reiser) and to the friends and fellow students who provided the support necessary to complete such an endeavour.

NOTES

- 1 For an examination of digital craft, see Malcolm McCullough, *Abstracting Craft: The Practiced Digital Hand* (Massachusetts: The MIT Press, 1996); For 'highly informed' design, see: Tobias Bonwetsch, Fabio Gramazio and Matthias Kohler, 'The Informed Wall: Applying Additive Digital Fabrication Techniques on Architecture', in Gregory A. Luhan, Phillip Anzalone, Mark Cabrinha and Cory Clarke, eds., *Synthetic Landscapes: Proceedings of the 25th ACADIA Conference, October 12–15, 2006, University of Kentucky, Louisville, Kentucky* (Mansfield: Association for Computer-Aided Design in Architecture, 2006), pp. 489–95.
- 2 Axel Kilian, *Design Exploration through Bidirectional Modeling of Constraints*. PhD diss., Massachusetts Institute of Technology, 2006.
- 3 Neri Oxman and J.L. Rosenberg, 'Material-based Computation: An Inquiry into Digital Simulation of Physical Material Properties as Design Generators', in *International Journal of Architectural Computing*, 5/1 (2007), p. 28.
- 4 John Frazer, *An Evolutionary Architecture* (London: Architectural Association, 1996) p. 37.
- 5 Gerhard Schubert et al., 'Tangible Tools for Architectural Design: Seamless Integration into the Architectural Workflow', in Joshua M. Taron, Vera Parlac, Branko Kolarevic and Jason S. Johnson, eds., *Integration through Computation: Proceedings of the 31st ACADIA Conference, October 11–16, 2011, University of Calgary, Banff, Alberta, Canada* (Stoughton, Wis.: The Printing House Inc., 2011), pp. 252–9.
- 6 Ryan Johns, 'Augmented Reality and the Fabrication of Gestural Form', in Sigrid Brell-Cokcan and Johannes Braumann, *Rob|Arch 2012: Robotic Fabrication in Architecture, Art and Industrial Design* (Vienna: Springer, 2013), pp. 248–55.
- 7 Karl Willis et. al., 'Interactive Fabrication: New Interfaces for Digital Fabrication', in Mark D. Gross, Nuno Jardim Nunes, Ellen Yi-Luen Do, Stephen Brewster, Ian Oakley, eds., *Proceedings of the Fifth International Conference on Tangible, Embedded, and Embodied Interaction* (New York, NY: Association for Computing Machinery, 2010), pp. 69–72.
- 8 Roxy Paine, *Erosion Machine*, 2005. Accessed 30 September 2013: <http://www.roxypaine.com/Erosion-Machine-2005>.
- 9 Fabio Gramazio and Matthias Kohler, *Procedural Landscapes* (Zurich: ETHZ, 2011). Accessed 30 September 2013: www.dfab.arch.ethz.ch/web/e/lehre/208.html.
- 10 The interactive milling software was written in Processing, a programming language. Accessed 30 September 2013: <http://www.processing.org>. It uses the *NyARToolKit Library* to track a printed marker on the work surface, and thus aligns the virtual camera of the digital scene with the live video feed from the tablet's rear-facing camera: *NyARToolKit*. Accessed 30 September 2013: <http://nyatla.jp/nyartoolkit/wp/>.
- 11 Branko Kolarevic, *Architecture in the Digital Age: Design and Manufacturing* (New York: Spon Press, 2003).
- 12 The robotic manipulator is an ABB IRB 6400/2.4-150 with an S4C controller.
- 13 The software makes much use of the *toxiclibs* library, namely the vector and mesh utilities: Karsten Schmidt, *toxiclibs*, 2012. Accessed 30 September 2013: <http://www.toxiclibs.org>; Kinect communication implemented using the *Simple-Openni* library for Processing; Max Rheiner, *Simple-Openni*. Accessed 30 September 2013: <https://code.google.com/p/simple-openni/>.
- 14 The convex hull is calculated using the Mesh library; Lee Byron, *Mesh – A Processing Library*. Accessed 30 September 2013: <http://www.leebyron.com/else/mesh/>.
- 15 The topological optimisation calculations are currently processed using a custom Python script which communicates with Sawapan's Grasshopper plugin: Panagiotis Michalatos and Sawako Kaijima, *Millipede*. Accessed 30 September, 2013. <http://www.sawapan.eu/>.
- 16 Ixagon, *SurfaceMapper for Processing*, 22 December 2012. Accessed 30 September 2013: <http://www.ixagon.se/surfacemapper/>.

Fig.1: Large prototype extruded with the mobile robot.

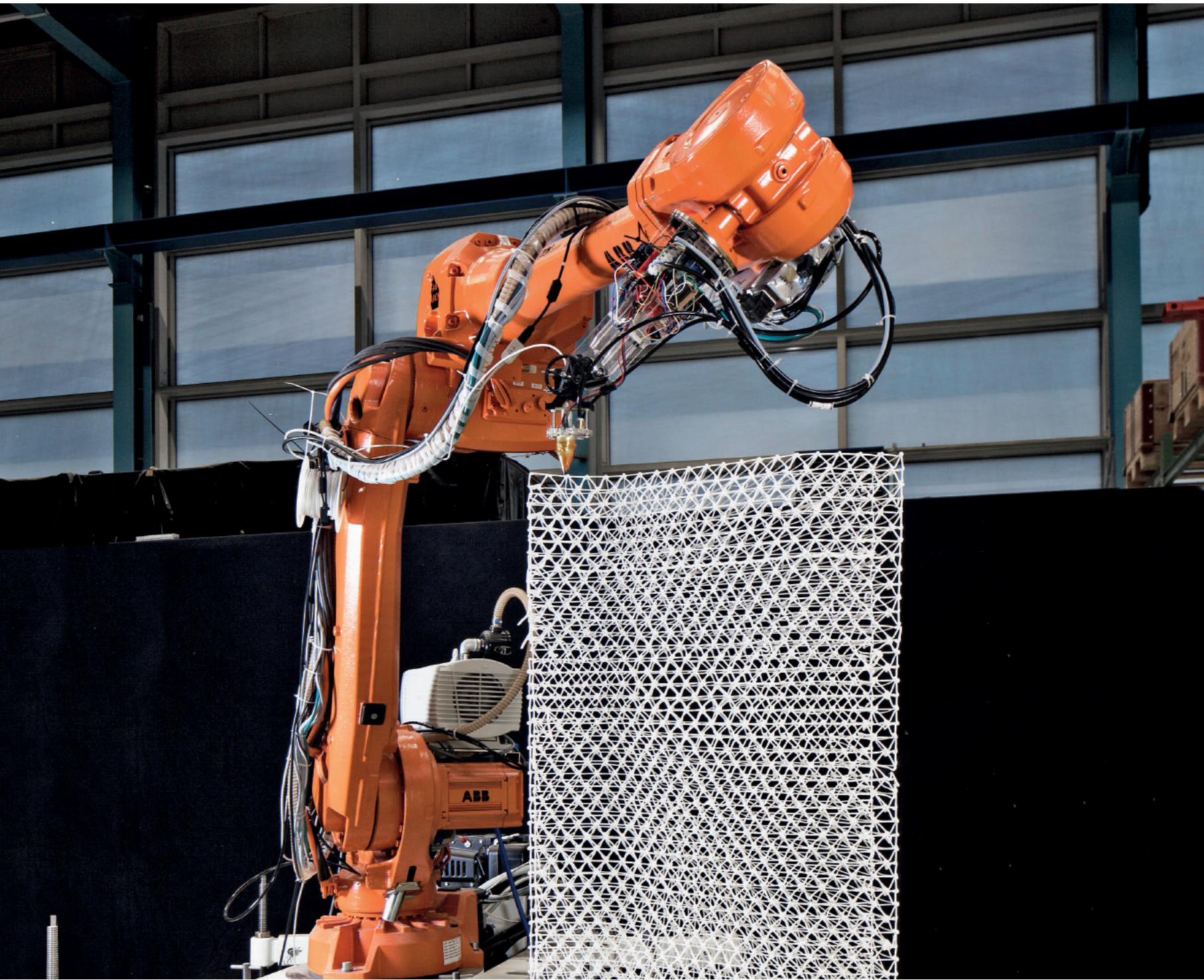

MESH-MOULD: ROBOTICALLY FABRICATED SPATIAL MESHES AS CONCRETE FORMWORK AND REINFORCEMENT

**NORMAN HACK, WILLI VIKTOR LAUER, FABIO GRAMAZIO, MATTHIAS KOHLER, SILKE LANGENBERG
(FUTURE CITIES LABORATORY, SINGAPORE-ETH CENTRE FOR GLOBAL ENVIRONMENTAL SUSTAINABILITY)**

Concrete requires formwork in order to be moulded into a desired shape. Once it is cured, it can take high forces of compression. However, concrete needs reinforcement to compensate for tensional forces. Both processes, the building of formwork and the placement of rebar, are highly labour-intensive and therefore costly. In order to cut these costs, most conventional concrete constructions tend towards geometric simplification. Consequently, concrete's inherent potential to take a specific form remains dead capital. This research investigates how computer-controlled robots can be used to shortcut these two processes. A novel spatial robotic 'weaving' method of a tensile active material that simultaneously acts as the form-defining mould folds these two separate requirements, reinforcement and formwork, into one single robotic fabrication process (fig. 1). Mesh-Mould could permit building geometrically complex, but cost-effective and materially efficient concrete structures.

INTRODUCTION

Considered globally, concrete is the most used man-made material in building construction today. The mass of concrete used is twice the total of all other construction materials together; this includes wood, steel, aluminium and synthetic polymers.¹ The labour involved for the installation of formwork and reinforcements accounts for over 50% of the total cost of a concrete structure² and rises exponentially with increasing geometric complexity. Consequently, most concrete structures tend to be simple and repetitive, neglecting the structural and aesthetic potential of this versatile material and accounting for the increasingly monotonous built environment, especially noticeable in many Asian metropolises.

Moreover, curvilinear geometries not only widen the scope of formal expression, they are likewise structurally more effective. With conventional fabrication methods, the cost of fabrication exceeds the savings in materials. The aim of this research on material systems for robotic construction is to resolve the discrepancy between efficiency of form and economy of fabrication by developing a new and competitive construction method that makes full use of the malleable potential of concrete. The project's working hypothesis is that the industrial robot, which can precisely and swiftly execute spatial move-

ments regardless of complexity, could unlock the full plastic potential of concrete as a building material.

This paper describes a robotic fabrication method that combines the two most cost- and labour-intensive aspects of concrete construction into one single process. Aside from the reduction of laborious and costly working processes, it will discuss how two essential functionalities can be merged into one material system. A novel method for producing robotically fabricated formwork that simultaneously acts as a reinforcement element is presented in its current state, and further development is discussed. The research opens up new possibilities for the fabrication of structurally differentiated, spatially more articulated and more materially efficient buildings.

EXTRUSIONS: TRENDS AND TENDENCIES IN CONCRETE AND POLYMER PROCESSING

Academia and industry have discovered the high potential of robotic fabrication of concrete structures, and research in the field has recently taken a great leap forward. Especially in the area of computer-controlled processing, there is a strong and persistent trend towards the extrusion of concrete. This trend corresponds with the general findings from the manufactur-

ing industry that material processes are easier to automate if the material is in a liquid state.³

The following section examines these tendencies towards concrete extrusion, discusses the difficulties and explores alternative material-extrusion processes. In addition, how these innovative approaches could be applied for the fabrication of non-standard concrete constructions will be discussed.

EXTRUSION OF CEMENTITIOUS MATERIALS

Ten years ago, the layer-based extrusion of cementitious materials raised hope for an entirely waste-free and geometrically unconstrained fabrication method. Researchers at the University of Southern California⁴ and the University of Loughborough⁵ set up large research facilities with concrete extrusion heads mounted on large gantry cranes to investigate concrete printing at building scale. Both approaches are linearly scaled-up versions of conventional 3D printers, which raises several difficulties: In order to achieve smooth surfaces, the layer height needs to be sufficiently small, which cubically increases fabrication time.⁶ The hydration process of concrete is very difficult to control and affects load-bearing capacity, layer adhesion and curing time. In particular, the latter is a determining factor for the printing speed of concrete.

Another, not yet sufficiently resolved issue is the integration of reinforcement elements into the extrusion process. Though the automated placement of reinforcement elements is conceptually addressed in Khoshnevis's work, the placement of discrete reinforcement elements remains in contrast to an otherwise continuous material deposition process.

Diverging from the common horizontal, layer-based extrusion, Smart Dynamic Casting⁷ focuses on the vertical extrusion of concrete columns. The research project tackles the aforementioned problems of limited material control during the process of hydration. Smart Dynamic Casting introduces the use of sensors to monitor the curing process and receive feedback about the state of the material during the process of casting. A careful orchestration of precise timing, sensor feedback and controlled spatial movement makes it possible to form concrete in the delicate moment of state change.⁸ Even though a remarkable level of material control is achieved, it becomes evident that the design freedom is limited by the properties of the material itself. In this regard, deviations from the vertical axis are only possible as long as the resulting tensional forces stay within a certain threshold.

In conclusion, cementitious materials are less than ideal for fast, precise and geometrically unconstrained extrusion

processes. The commercial success of concrete extrusion and printing processes largely depends on improvements in material technology.

ALTERNATIVE APPROACHES: EXTRUSION OF SYNTHETIC POLYMERS

In contrast to cementitious materials, synthetic polymers can be engineered to meet the exact requirements of a fabrication process and are used today for a wide variety of applications.

The robotic extrusion of polymers in a building context was first explored by the Chair for Architecture and Digital Fabrication at ETH Zurich in 2007.⁹ An off-the-shelf polyurethane foam, usually used for insulation purposes, was poured layer by layers by an industrial robot to build up custom acoustic panels. Although the control of the expanding foam was very limited, these first experiments demonstrated the potential of robotic extrusion for architecture.

In 2012, the Mediated Matter Group at MIT used a similar technique for the robotic fabrication of lost concrete formwork.¹⁰ Layers of polyurethane foam are successively sprayed on top of each other until they form an approximation of the desired geometry. In a subsequent step, the rough, imprecise surface is smoothed by milling it to the desired final shape and the formwork is finally filled with concrete. The formwork then remains in place and acts as thermal insulation.

Fig. 2: Leaking formwork by Forma-Tech.
(Image by courtesy of Forma-Tech International.)



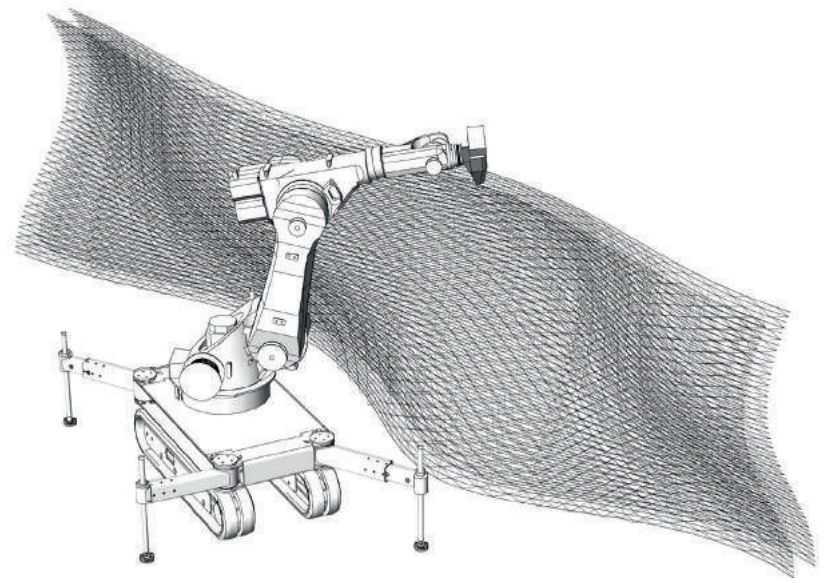
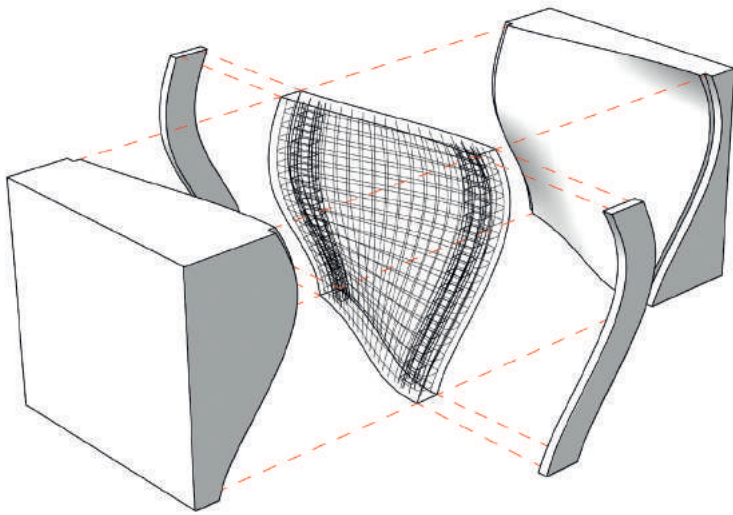

Fig. 3: Conventional formwork and Mesh-Mould.

In contrast to polyurethanes, thermoplastic and thermosetting polymers are controllable to such an extent that free spatial extrusions become possible through accurate local temperature control. Recently, research projects have been conducted that use this capacity to overcome layer-based disposition.

The 3Doodler, a PLA and ABS extruding pen, allows, for the first time, leaving the 2D plane entirely and enables drawing in space.¹¹ The project builds on conventional 3D printing technology with additional air-cooling. Instead of a computer-controlled motion path, the path control is put in the hands of the user. The challenge to control the material in space is an exciting aspect of the concept.

Mataerial,¹² a research project conducted by Novikov and Jokié at the Institute for Advanced Architecture of Catalonia (laaC) in collaboration with Studio Joris Laarman, follows a similar line of inquiry, but puts the extruder back into the digitally controlled hand of the robot. Instead of using thermoplastic polymers, the material used is a two-component thermoset that hardens under heat. The project demonstrates that using slow, precise robotic guidance, controlled spatial extrusions of relatively wide spans (1.5 m at a speed of 0.3 m/min) are possible. The use of such lightweight, polymer-based material enables extreme cantilevers that would not be possible with a dense structural material like concrete.

SYNTHESIS: ROBOTICALLY EXTRUDED POLYMERS AS CONCRETE FORMWORK

The decision to avoid the direct processing of concrete and to focus on the robotic production of formwork instead was motivated by the fundamental difficulties encountered in printing a material with hydraulic properties as well as by the pragmatic insight that it is easier and more efficient for robots to build lightweight structures than to handle the whole mass of the concrete structure.

An analysis of the existing formwork technologies led to the insight that one specific system, called 'leaking formwork',¹³ has a particularly high potential with regard to robotic fabrication. Its basic principle works as follows: Concrete is poured into a perforated formwork, which is built up from corrugated plastic panels. The concrete protrudes through the perforated surface and covers up the panels. In a final step, the protruded material gets manually troweled to create a smooth concrete surface (fig.2).

This simple and efficient material system holds great potential when crossbred and augmented with the logic of robotic fabrication. If the perforated formwork is directly extruded in situ as three-dimensional spatial meshes by the robotic arm, instead of being composed of discrete prefabricated panels, the system is liberated from planarity or single curvature (fig.3). The liberty of free spatial extrusion allows fabricating

three-dimensional formwork meshes well adapted to the forces that will act upon them. A local differentiation of the mesh, which can be achieved by varying the size of the single stitches and the thickness of the extrusion, can accommodate the changing hydrostatic pressure during the pouring process, which decreases from bottom to top, and thus controls the protrusion of the material through the openings. Besides enabling complex volumetric geometries, the local differentiation of the meshes can be further employed to create more complex, idiosyncratic material options. A local densification of the mesh interior, for example, could prevent the liquid concrete from reaching all parts of the volume and thus create a degree of porosity which would not be possible with conventional means of casting.

In addition to the primary goal of unlocking the full plastic potential of concrete as a building material, the research aims at promoting the use of extruded polymer meshes as a structural reinforcement. Their strength could be increased by the co-extrusion of tensile active filaments, and a significant amount of steel reinforcement could be saved. By going beyond the simple automation of human labour, this process would activate the full potential of robotic fabrication and enable material systems that would not be feasible otherwise.

SUCCESSIVE APPROXIMATION

In order to get a better hold on the ambitious overall aim, the substitution of steel reinforcement is implemented in sequential steps. The first step is focusing on the form-defining capacity and the spatial extrusion of polymers. A subsequent step aims at substituting the secondary reinforcement, which prevents surface cracking in concrete elements. In a final step, fabrication technique and material research converge to substitute the entire tensional reinforcement of the concrete element.

FABRICATION EXPERIMENTS: SPATIAL EXTRUSION WITH THERMOPLASTICS ON A SCALE OF 1:1

The experiments conducted up to now offer insights into the potential of spatial, non-layer-based extrusion of polylactic acid (PLA) for the fabrication of spatial meshes. The availability of a standard 3 mm PLA filament allowed running the first experiments using an off-the-shelf 3D printer, extruder and feeder components. The integration of a custom cooling system based on pressurized air that hardens the material locally at the moment it is extruded has been key to being able to extrude material freely in space. The motion path for the robot was directly generated by a custom algorithm defining three-

Fig. 4a–b: Robot extruding mesh and first prototype filled with concrete.

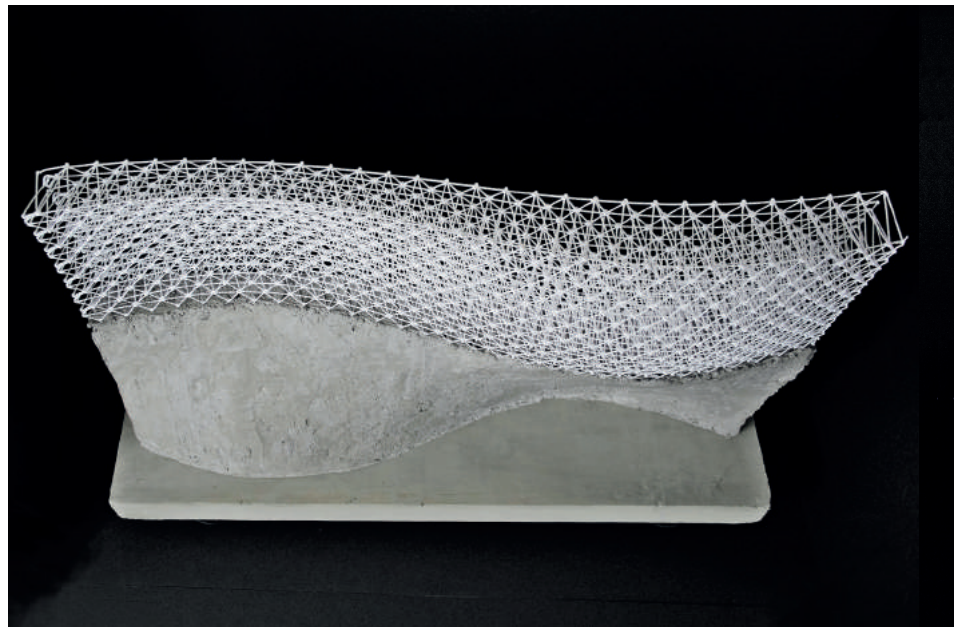
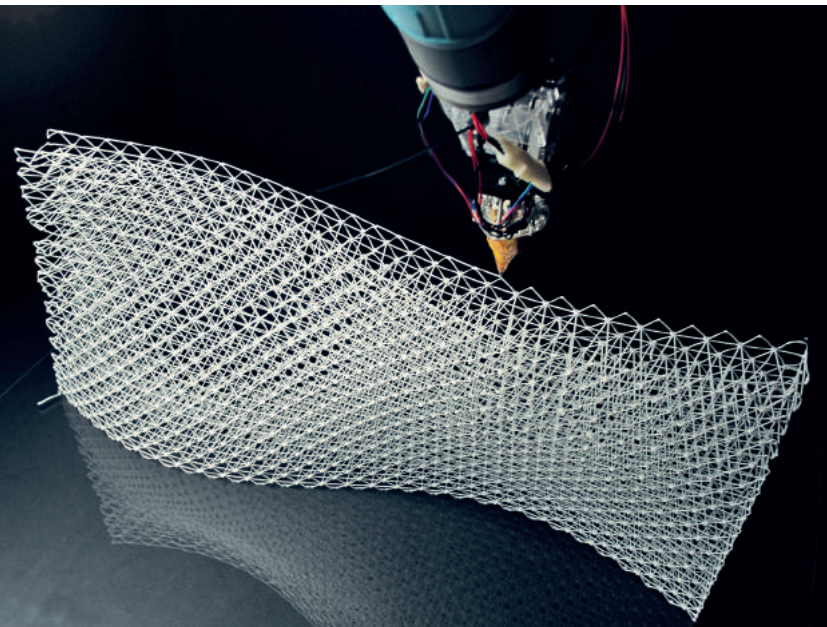

dimensional mesh structures from any arbitrary pair of surfaces. The samples created were double-curved meshes with dimensions of approximately $600 \times 500 \times 250$ mm, whereas the individual triangle is about 30 mm long and 20 mm high. The polymer is extruded with a diameter of 2 mm and makes up a total volume fraction of 2.5% (fig. 4a).

The stitch dimensions of these first samples represent approximately a 1:1 scale; however, the global geometry remains a fraction of a larger non-specified element.¹⁴ Stitch dimension, extrusion thickness and global geometry will be adjusted according to the results of subsequent concrete pouring tests. Additionally, the relatively low feed rate of 1 m/min will be addressed during the further development of the process.

OBSERVATIONS

The incorporation of dynamic material behaviour into the path-generating script has been pivotal for the successful fabrication of fully connected and stable meshes. Several experiments were conducted to understand the correlation of heating, cooling and hardening behaviour of the material and their relationship to feed rate, cantilevering distance and motion speed of a robotically controlled extruder. The findings resulted in the implementation of a slightly super-elevated amplitude, short

stops for cooling and hardening, increasing and decreasing air pressure for certain inclination angles and the selective disposition of additional material as connection knots.

While some constraints can easily be solved by clever motion planning, others require adjustments in hardware. The collision-free extrusion of material at steeper angles, for example, can only be enabled by a custom design of the extruder head (fig. 5). The experiments have shown that increasing the extrusion rate in order to speed up the process requires a more efficient cooling mechanism.

NEXT STEPS

Experiments to date have demonstrated the general technical feasibility of this fabrication process. The extrusion of complex meshes displaying horizontal cantilevers, overhanging angles of inclination and double curvature with small curvature radii have shown the versatility of this method. However, at this early stage of the research, several important fabrication parameters have not yet been included. Three key challenges have been identified as drivers for the upcoming research phases:

1. Fabrication speed
2. Tensile strength of the extruded material
3. Transmission of the forces across the extruded mesh

Fig. 5: Extruder head with air-cooling: based on standard components (left) and with custom extruder nozzle.

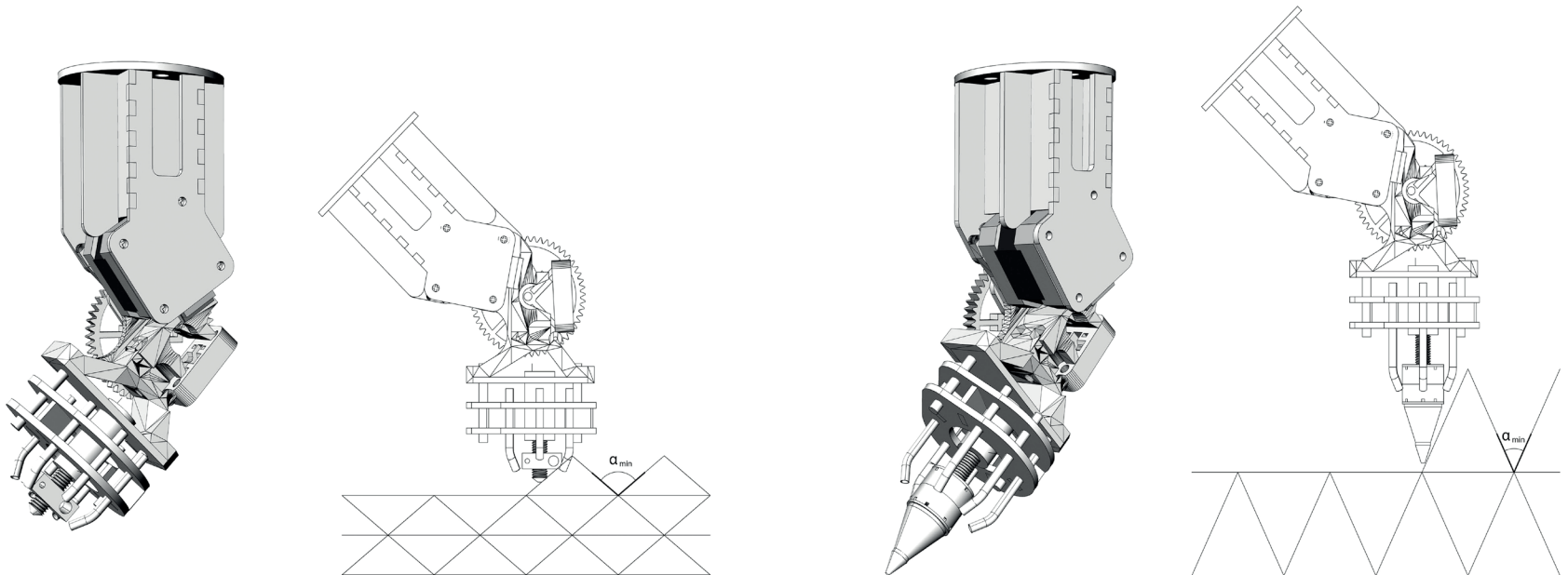

The fabrication speed is mainly dependent on the hardening behaviour of the extruded material and can be controlled through local cooling. Several cooling strategies are currently under development and are being progressively integrated into the next generation of tool heads. In future experiments, water could substitute for air as a more efficient heat-transfer medium and even nitrogen is being considered for rapid cooling. In order to substantially accelerate the process, especially when scaling it up to real scale, strategies of parallelisation, such as the incorporation of multiple extrusion heads, will have to be considered.

The tensile strength of the extruded material can be significantly increased by co-extruding a high-strength filament. Carbon, glass, bamboo and basalt fibres, as well as steel wire, are materials currently under consideration. Spun basalt is particularly interesting. Though it has long been known for its extremely high tensional capacity, it could not be implemented for concrete reinforcement due to its intolerance to an alkaline environment. Nevertheless, used in combination with an isolating polymeric binder (e.g. PLA), basalt becomes an inexpensive alternative – even exceeding the tensional load capacity of glass fibres.

Research in the field of 3D textile reinforcement for ferrocement building elements provides an insightful point of reference, not only in regard to different materials and material properties, but also regarding the third key challenge. The transmission of forces across the extruded meshes largely depends on the force-locking connection between the extruded strands. Various weaving, knitting, and crocheting techniques are being explored and evaluated for their applicability in a robotic fabrication process. This step goes hand-in-hand with the development of the parallelisation strategy mentioned earlier. One possible strategy, which is currently being evaluated, is the development of an extrusion head that extrudes multiple strands and concurrently intertwines them through rotation.

The entire development happens in feedback loops with concrete pouring tests and will need continuous adjustments of the material and fabrication system. The existing Form-Tech formwork system provided an informative basis for a stitch size to concrete viscosity ratio. This was tested and verified by the first concrete pouring tests (fig. 4b), which again provided the basis for more refined prototypes (fig. 6). These 1:1 scale prototypes were fabricated with a larger, mobile robot at ETH Zurich in October 2013 (fig. 1).

CONCLUSION

Combining formwork and reinforcement into one robotically fabricated material system promises far-ranging implications.

On the level of building site organisation, the various crafts and professions involved in the process of concrete construction can be folded into one. A typical concrete process involves the prefabrication of formwork and rebar, transportation to the site and site logistics, bending, placing and connecting rebar, installation of formwork, concreting, disassembly of formwork, cleaning of formwork and, finally, surface finishing. Most of these processes can be shortened by the in-situ extrusion of the reinforcing formwork.¹⁵ This synthesis of processes suggests that the complexity of building elements can be increased while at the same time organisational complexity on the building site can be reduced.

Beyond the aspect of merging processes, in-situ robotic fabrication will allow a dynamic response to the imprecisions and tolerances often confronted on a building site.¹⁶

Moreover, as it is an additive manufacturing process, waste production is reduced to a minimum, while the material efficiency of the process is further enhanced by the double agency of the material system.

Finally, the research challenges the conventional understanding of design where form is superimposed on a material.

Fig. 6: Mesh refinement and differentiation.

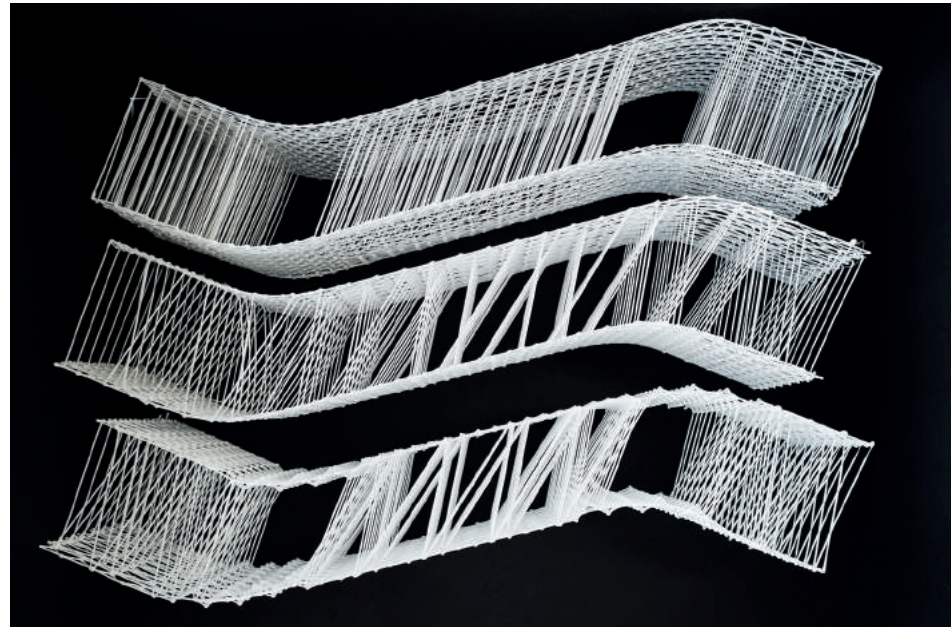

An understanding of the relationships of material, fabrication, forces and form opens up new perspectives for a more complex material and cost-efficient non-standard architecture, which could eventually defy the prevailing economy of scale in building construction.

NOTES

- 1 According to the World Business Council for Sustainable Development: <http://www.wbcscement.org/index.php/about-csi/explore-cement?start=2> (accessed 6 June 2013).
- 2 According to a joint publication of the National Council of Structural Engineers Associations (NCSEA), the American Council of Engineering Companies (CASE) and the Structural Engineering Institute (SEI) of American Society of Civil Engineers, <http://www.structuremag.org/article.aspx?articleID=423> (accessed 6 June 2013).
- 3 Leonard Bernold, 'Automation and Robotics in Construction: a Challenge and a Chance for an Industry in Transition', *International Journal of Project Management*, 5/3 (1987), pp. 155–60.
- 4 Dr Behrokh Khoshnevis, 'Contour Crafting', University of Southern California, <http://www.contourcrafting.org/> (accessed 15 June 2013).
- 5 Dr Richard Buswel and Simon Austin, 'Freeform Construction', Loughborough University, http://www.lboro.ac.uk/service/publicity/news-releases/2012/61_Freeform.html (accessed 15 June 2013).
- 6 Fabian Scheurer, 'Size Matters: Digital Manufacturing in Architecture', in: Emily Abruzzo and Jonathan D. Salomon, eds., *Dimension* (New York: Princeton Architectural Press, 2009), pp. 59–65.
- 7 This PhD research project combines conventional slip casting technique with the advantages of digital fabrication. The research is being conducted by Ena Lloret Kristensen at the Chair for Architecture and Digital Fabrication, Prof. Fabio Gramazio and Prof. Matthias Kohler in cooperation with Prof. Dr Robert J. Flatt (PI), Prof. Dr Hans Jürgen Herrmann; Civil, Environmental and Geomatic Engineering (D-BAUG), Inst. for Building Materials (IfB); Dr Peter Fisher, Dept. of Health Sciences and Technology (D-HEST), ETH Zurich.
- 8 Ena Lloret Kristensen, Fabio Gramazio, Matthias Kohler and Silke Langenberg, 'Complex Concrete Constructions: Merging Existing Casting Techniques with Digital Fabrication', in Rudi Stouffs, Patrick Janssen, Stanislav Roudavski and Bige Tunçer, eds., *Open Systems: Proceedings of the 18th International Conference on Computer-Aided Architectural Design Research in Asia (CAADRIA 2013)*, (Hong Kong: Association for Computer-Aided Architectural Design Research in Asia, 2013), pp. 613–22.
- 9 Gramazio and Kohler, 'The Foam', Architecture and Digital Fabrication, ETH Zurich Faculty of Architecture, <http://www.dfab.arch.ethz.ch/web/d/lehre/137.html> (accessed 14 June 2013).
- 10 Neri Oxman and Steven Keating, 'Building-Scale 3D Printing', Mediated Matter Group, MIT Media Lab, Massachusetts Institute of Technology, <http://www.media.mit.edu/research/groups/mediated-matter> (accessed 15 June 2013).
- 11 Peter Dilworth and Maxwell Bogue, '3Doodler', WobbleWorks, <http://www.the3doodler.com/> (accessed 15 June 2013).
- 12 Petr Novikov, Saša Jokić and Joris Laarman, 'Anti-Gravity Object Modelling' Materal, <http://www.materal.com/> (accessed 15 June 2013).
- 13 Danny Hill, *Building Component*. USA, Patent No. WO 03/040487 A1. New York, 2003.
- 14 A doubly curved surface is used as a placeholder in order to demonstrate the system's design space. In further research, the goal is to develop a more holistic application, which will be demonstrated in a final prototype in June 2016.
- 15 The short-circuiting of long and linear sequences of labour in order to dramatically simplify processes is called 'reproduction' and is described as the fifth degree of industrialisation. Roger-Bruno Richard, 'Five Degrees of Industrialised Building Production', in Gerhard Girmscheid and Frits Scheublin, eds., *New Perspective in Industrialisation in Construction: a State-of-the-Art Report* (Zurich: Eigenverlag des IBB an der ETH Zürich, 2010), pp. 15–27.
- 16 Volker Helm, Selen Ercan, Fabio Gramazio and Matthias Kohler, 'Mobile Robotic Fabrication on Construction Sites: DimRob', in *2012 IEEE/RSJ International Conference on Intelligent Robots and Systems, IROS 2012, Vilamoura, Algarve, Portugal, 7–12 October 2012* (New York: IEEE, 2012), pp. 4335–41.

LIVING ASSEMBLIES

NEIL GERSHENFELD

IN CONVERSATION WITH MARK BURRY

MARK BURRY Hi Neil. I hope this is going to be more of a conversation than an interview. I am going to start with Gaudí because that's what I do and I am actually in Barcelona now. In your fabulous book *FAB* you referred to him and I thought you were very eloquent. I wonder if you want to expand a bit more about the relationship between your world and that of Gaudí. You clearly admired his spirit of invention.

NEIL GERSHENFELD Sure. The connections to Gaudí are nested. To start with, if you look at something like the Sagrada Familia, it's clear he didn't outsource the civil engineering. He didn't just design a shape and have an engineer to build it. He did really innovative things in figuring out how to build structures in a relationship between form and function. In particular, he played with hanging catenary chains and then inverting them to make structures for arches as structural motifs. He did very inventive things in figuring out how to build his buildings; unlike the norm today, where somebody sketches what it looks

like and somebody else figures out how to build it. In turn, the Gaudí connection goes even deeper because of that wonderful design sense in Barcelona. If you fast forward to now, the city and the region has maybe 50% youth unemployment, but still has this great design tradition. A number of years ago, a colleague started a Fab lab in Barcelona, driven by a sense that engineers weren't engineering right and, in particular, if you think about digital technologies, that you could just build a building and then somebody else could just put some computers in it. And so we began a collaboration looking at how you could build a physical structure and at the same time, you also build a data network in a distributed computer and logical structure. That grew into another colleague starting a Fab lab in Barcelona and that was so successful, he is now the head architect and city planner of Barcelona. His colleagues are now running the city and a key piece of that is they are filling the city with Fab lab as part of the civic infrastructure to make the city

become globally connected and self-sufficient as well as able to locally produce what it consumes. Gaudí's design and engineering sense has now matured to really being a reinvention of economies and how cities work.

BURRY When you started the Fab lab in 2001, did you see this knock-on effect? I can say that your personal adventure is coherent with an interest in someone like Gaudí, but did you see this mushrooming into other people taking up the message and running with it?

GERSHENFELD No, not at all. I had funding in the US from the National Science Foundation to create the Center for Bits and Atoms programme at MIT. Because I never fit in with the boundary between physical science and computer science, we assembled a facility with tools to make anything on any scale. A year or two ago the US Congress passed a law on measuring the impact of research funding and the NSF staff turned around and told the grantees to show our social impact. The staff didn't know how to do it; we didn't know how to do it; but we thought that the tools were pretty cool. So rather than just making a website teaching some classes, we thought it would be more interesting to let people get access to the machines and our whole vision was to set up a site where they could do that. We set up one community lab based on the most used tools in the bigger facility and then, well, the viral spread wasn't on anybody's agenda. Since then, the labs have been doubling in size every year and a half. There are maybe 200 of us now and 200 coming and nobody is pushing, they are all pulling. Every time we open one, somebody else wants one. The larger social revolution wasn't an agenda; our piece of it is that we backed into doing it.

BURRY Someone like Gaudí, who is sometimes a renaissance man, his trajectory is in opposition to the disciplinary base of universities and the professional segregation between those parties

and the building. Do you see him as a renegade, as it were?

GERSHENFELD Let's see. What's interesting about that is that in both the Fab labs at MIT and the CBA (Center for Bits and Atoms), the programmes I run grew out of the media lab at MIT when it was created originally by Nicholas Negroponte and Jerome Wiesner, who is less well known but was MIT's president and Kennedy science advisor. Jerry did this very interesting thing: late in life he was frustrated by discipline boundaries and so he wanted to create a department, which you could think of it as a 'department of none of the above', the department for things that don't fit into departments. The academic department that made the media lab possible and then the CBA, is called Media Arts and Sciences and it is really a made-up department for things defined by not fitting into other departments. You have to do rigour, you have to know past practice and evaluate progress and all of that. It's defined not by how it fits into a canon, but essentially by how it does not fit into a canon. That way of working, at best in formal academia in places such as MIT, departments are quietly being demoted and work is moving towards interdisciplinary work groups. The CBA is defined by a way of working and by domains of working that span many disciplines. At MIT, programmes like the CBA and one studying the brain and one studying the energy, are where much more of the energy is going. In the same sense, the real driver of the Fab lab network isn't the technology; it's the nature of people who invent.

Inventive people don't fit into formal structures. Everybody talks about innovation, but innovative people are strange: they don't follow rules, they don't behave 'well' by definition. We find that all over the world, the Fab labs act as magnets for the kind of people who don't fit. There is a wonderful meeting once a year for all these labs coming together (in fact, it will be in Barcelona next summer). People are rich,

poor, north, south, east, west, rural, urban, but they are all kind of the same person in different packages, the same profile of inventive people who don't usually fit in formal organisations.

BURRY So, thinking of Vicente Guallart, who has actually started the program at IaaC Barleona and is very highly regarded in the area – are all the Fab labs running with such a degree of leadership?

GERSHENFELD Right. That's an unusual case, but a recurring lesson has been that none of these labs is self-sufficient. It has the tools to create modern technology, but not the knowledge and the links to do business or education in social programs. There isn't a critical mass in a single lab. Therefore, what has emerged is networks. I thought the technology was hard, but the research road map that Fab labs are surfing on is progressing really well. The 20-year goal is the Star Trek replicator. What's been harder is the social engineering. We've had to invent a number of new organisations and emerging Fab foundations and a Fab academy, business platforms, etc. to provide organisational capacity, because incumbent organisations in each of these areas have consistently failed us because this doesn't fit what they do. So, a smaller number of really unusual organisational entrepreneurs and social inventors have helped ramp up this emerging social structure. If anybody can make anything, it really changes how we organise society and needs a fundamental reinvention of the institutions.

BURRY That's very much the spirit of *FAB*, the book. But in terms of my own peregrinations around departments and universities, it seems to me that there is still a very fixed opposition to anybody having their discipline diluted by what I call the mavericks. I think you have a name for them. But for me, it's always been the soul of creative university life, the people who cannot be constrained within their disciplines. Speaking as an individual, I'm quite disappointed at the

lack of traction. Have you got a more optimistic message?

GERSHENFELD Yes, I do, for two reasons. Most narrowly what keeps me happily based at MIT is because MIT has a disproportionate impact per person or dollar and square foot and it has nothing to do with funding and facilities, it's in its culture. MIT is a place where that way of working fits. It's defined by breaking those boundaries and tinkering. So, locally MIT is receptive to that, but more broadly, the reason I'm optimistic is the evolutionary pressure in the maybe five steps from the spread of labs to the back-action on me.

It started when we were swamped by demand, then one step in, what we found is we were doing a lot of technology development for the Fab labs. That was different from what we did on campus. On campus, I would send out to make printed circuit boards, whereas for the Fab labs, we developed quick term precision machining to make them, away from the supply chains. We found that was better than what we had been doing and that's what we now do on campus too. In the Fab labs, we were limited by CAM – until we wrote our own CAM tools to run the machines; and on campus we bought expensive things, so we bought the stuff we wrote better with. One step in there is this nice back-action of technology in the field coming back on campus. However, as we've grown into building distributed education across the Fab lab network, this is really challenging what formal institutions like MIT are for and it's putting evolutionary pressure on them.

To describe a situation in the Fab Academy, we had a problem of bright kids in Arctic villages or rural Africa learning skills way beyond their local education options, for example, learning 3D modelling or service networking and embedded programming. The usual answer is if somebody like that appears, they have to leave home, they have to go far away to continue

their education. So what we started doing instead is, if you think of MIT in computing terms as a mainframe, you go there for processing. I am not a fan of all the attention on massive online courses because, in computing terms, that's like time-sharing. The person is like a terminal connected to a central education processor and that's not really how learning works. What we started doing in what is now called the Fab academy is that students would have peers and work groups with mentors in the labs with tools and then we'd link them globally for lectures and content sharing. In computing terms, it's like the Internet versus the Bitnet. It's a distributed network for education. It has been working really well, initially just for the course skills in the Fab lab, and the principles and application of digital fabrication.

But it has a much deeper implication, which is that you come to a place like MIT for the people, but now through broadband video, I see colleagues abroad more than most of my MIT colleagues. If you come for the books, they are online now. And if you come for the facilities and have the digital fabrication tools, it means you can, in effect, download the campus. In my lab at MIT, I've got some million dollar machines, like a micro CT, which is so expensive there are only a few in the world and they really need to be centralised, but a lot of what happens at a place like MIT can actually be done in this much more scalable and distributed way. In terms of the Fab academy, there is no way to accredit a network. The accreditors thought what we are doing was great, but said they are not even allowed to accredit something like this. Instead, we are doing skills-based accreditation based not on a degree, but on building portfolios demonstrating ability. What we are hearing is that people who hire people with degrees are complaining that the new employees don't know how to do stuff. Given the emergence of projects like ours, what it is doing is putting a lot of evolutionary pressure on traditional learning institutions to justify their existence.

There is a role, but it's a role in a hierarchical network and you really have to justify the constraints in the cost structure to do it centrally versus distributed.

BURRY

Do you think this is playing out, rather than 'played out'? Because I mentioned that governments, for instance, would be taking a keen interest in this evolution, as you described it, whereas some of the more serious institutions in the world might regard it as dismantling.

GERSHENFELD

Yes, currently, this is very much playing out. There is a careful balance to make. I naturally love the 'maker movement'. At the same time, I also cringe at a lot of bad engineering seen at things like hacker spaces and maker fairs, without mentoring to help people understand the difference. Part of what we are trying to balance in a project like the Fab academy is making it scalable and entropic and distributed, but also curated so you can progress from easy to hard and understand when you are reinventing a bad solution that's already known not to work well. In getting that balance in education, there are a lot of formal institutions that are repeating the mainframe versus PC approach and considering all of this to be more like a toy and not the real thing – while it annihilates them. Again, the thing that is challenging them is not online classes.

A person clicking away at a computer by themselves isn't what I consider real education, but these educational networks are emerging. Where it ends up is pretty obviously analogous to how the Internet works. Nobody really runs the Internet. The Internet engineering task force and the Internet Architecture Board within it run on soft power, but they do such a good job at it that everybody aligns themselves. It is a distributed, but at the same time, very hierarchical structure: in the same sense as in terms of dollars, a lab like mine at MIT has 10 million dollars, so you can think of it as 10 one-million-dollar machines to do research

across scales. Within that, there is a workshop that has 10 one-hundred-thousand-dollar machines, to make difficult-to-make things. These 10 machines have the Fab lab tools and we can think of each 100,000 dollars as ten 10,000 dollar machines. In turn, these machines are good enough to make do-it-yourself machines, which are machines that make machines. Then the ten thousand dollars can be seen as 10 1,000 dollar machines and those are machines for a few hundred dollars and they are capable enough to do simple projects.

None of those scales replaces the other, since each has capabilities you can't do in the other. So there is a natural end game where advanced research and education is much more inclusive because it's much more distributed, but there is natural flow from things that need more specialised people and resources. That's where I see this evolving. There a number of institutions like MIT and Stanford that are really embracing that future. And I think there are a lot of formal institutions that will just get left behind, places where the education they provide costs too much and is too inflexible compared to this much more scalable one.

BURRY Okay, if I can encapsulate, it is the movement that's going viral, it's fuelled by enthusiastic youth, a lot of flair and a lot of inspiration. What room for leadership is there with regard to a quality control aspect?

GERSHENFELD Yes. This is a common misunderstanding. Any successful open-source project has a dictator. Linux has Linus Torvalds managing the heart and soul of the kernel and he has what are literally called lieutenants. Mozilla has Mitchell Baker. Any of these large-scale distributed projects is scalable but has a curator. If we go back to the Internet example again, the whole idea of Internet versus Bitnet is that anybody could connect, but at its heart was the IAB that was really tending to these amazing people that make the Internet work. For me, the Fab lab

network means a couple of things. One is that it is deeply connected to the research road map we are pursuing. The second is that it really runs as a network, not as individual sites. And then it has this curator function that can go from easy to hard. Things one person can do in an afternoon might take years of knowledge. It's a common misperception that distributed means flat. The successful distributed projects really have leadership, but the leadership is defined by soft power. Nobody put them in charge. They are in charge from the value they bring by helping organise the network.

BURRY Are you providing that curator role yourself now?

GERSHENFELD Initially, for the Fab lab part of the story, it was me and my colleague Sherry Lassiter and the CBA office at MIT. It got much too big for that, so we spun off the Fab foundation. That's not really one foundation, it's a network of regional programs that are linked globally and deal with things like each lab doesn't have to separately negotiate terms on a laser cutter or sort specialised material and figure out how to account or do their own deals with big donors. There is a Fab academy that's doing the distributed education. Each lab doesn't need to and doesn't have the skills to build an entire curriculum to learn how to use this. So those kinds of organisations are spinning off and we remain very involved, but the heart of it on the MIT side, the core connection, is the research road map. Technically, we're going from computers controlling machines to machines that can make machines, from building materials discretely with code to materials with programs, and so the goal over the coming years is, initially, for the Fab labs to make more Fab labs. Then move from making Fab labs to programming with digital materials and finally to reconfigurable materials. On the MIT side, the real core involvement is driving that technical road map.

Fig. 1: Fab lab Zurich, founded in 2012.



BURRY Well, that's incredibly coherent. I might just finish with this: You quoted (Bill) Joy at the end of your book, from the article 'Why the future doesn't need us.' This was eight years ago, I suppose. What's your feeling now about the future regarding his negative prognosis?

GERSHENFELD Let's see. Among things to worry about there is unchecked self-reproduction and what's wrong with that is that the systems we create need special raw materials that aren't natural. If you need natural raw materials, then what you are describing is biotechnology and that's an important concern, but that's not a new one. Viral unchecked self-reproduction isn't technically a practical concern. A little closer is when you can make bombs and weapons. The coverage of that's been kind of silly because how to make a gun in a workshop has been familiar for hundreds of years and people make great guns in home workshops. 3D-printed guns are not particularly good guns. And not only is it not new that you can make a gun in a workshop, but guns are easily available on street corners almost anywhere in the world. So, we just haven't had a big driver for people to make guns and weapons just because that's such a well-met market need. Then you come down to what is due to society, if you spread out all of this.

There is no technology in history that's been purely good or bad. People are good and bad, but how they use technology isn't. What we do see is empowering invention, creating new kinds of economies where you ship, date, and produce on demand. All of that is very analogous to the disruption of the PC. PCs have been used for bad things, but would anybody argue they've been a bad influence in how they've empowered society? There's a very close parallel in going from mainframes to mini-computers to hobbyist computers to PCs and now there is this research road map. In 1952 when MIT made the first computer-controlled milling machine to the Fab labs today that are

very analogous to the minicomputer to the hobbyist computers that are like do-it-yourself machines and then the research on the Star Trek replicator that's analogous to the eventual personal computer... And the lesson from that parallel is where historically exactly in the analogous moment, the Internet was invented. What's going on now is a kind of literal Internet of things inventing new structures in that world. Ultimately, I do have faith in using more of the brainpower of the world. There are good people and bad people, but I think the fraction of bright inventive people whose brains we can really tap has been limited up to now by the infrastructure and that's what we are providing – a real way out of those limitations.

BURRY So we are unlocking potential.

GERSHENFELD Yes, or let's say it's already unlocked, but we are taking advantage of it. For me, the end result of smashing together digital computing, digital communication and digital fabrication at their intersection lies in using the brainpower of the planet.

BURRY I think you have very eloquently defined what I think is the post-digital construct. I think we'll leave it there if that's OK with you. Thank you. Fascinating talking to you.

GERSHENFELD Thank you. It was fun to talk. These were interesting things to talk about.

Figs. 2, 3: Fab lab Zurich, 3D printing of badges for FABRICATE conference 2014 at ETH Zurich.

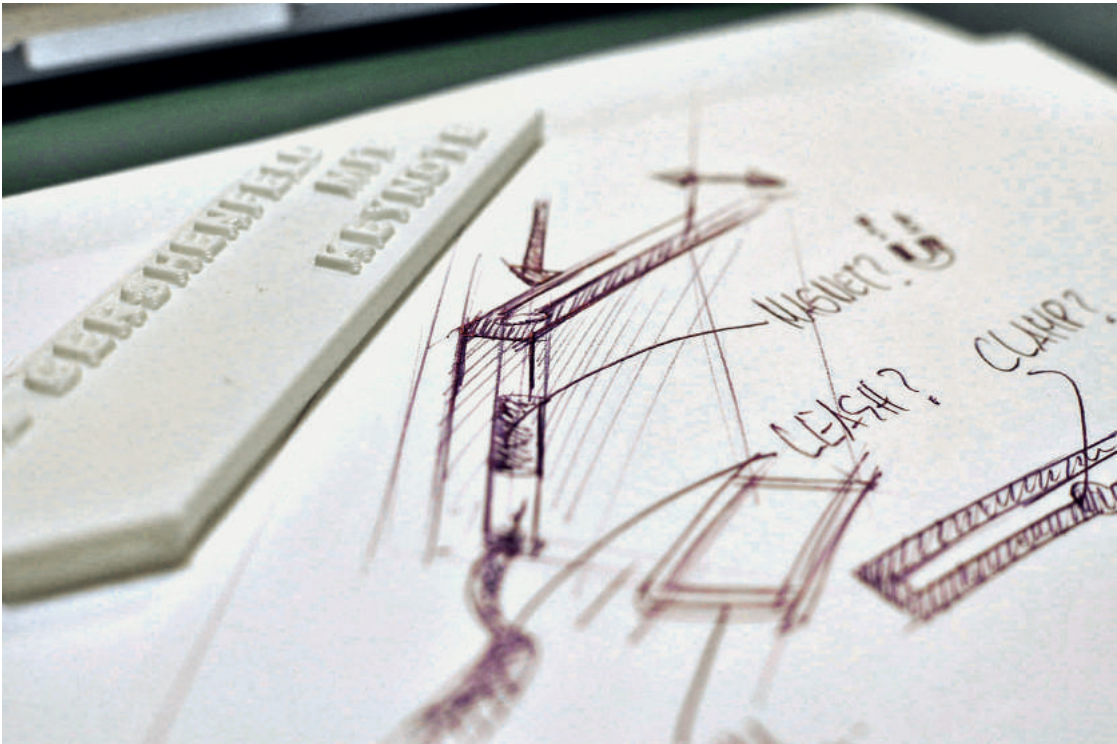
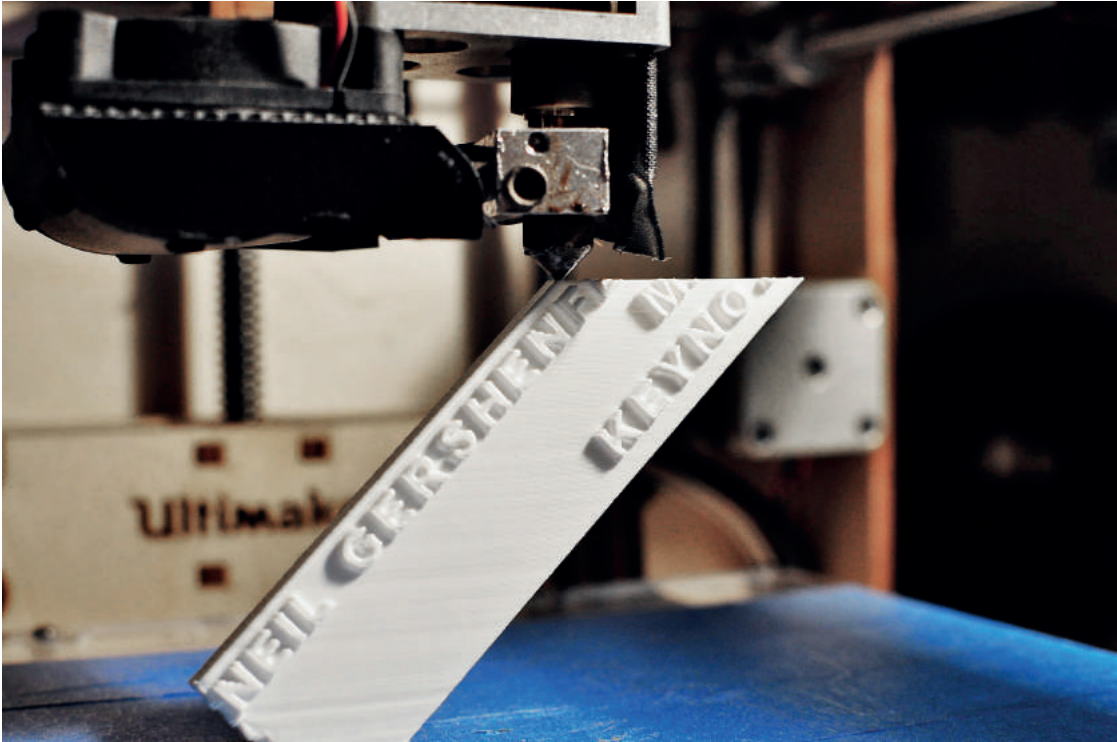
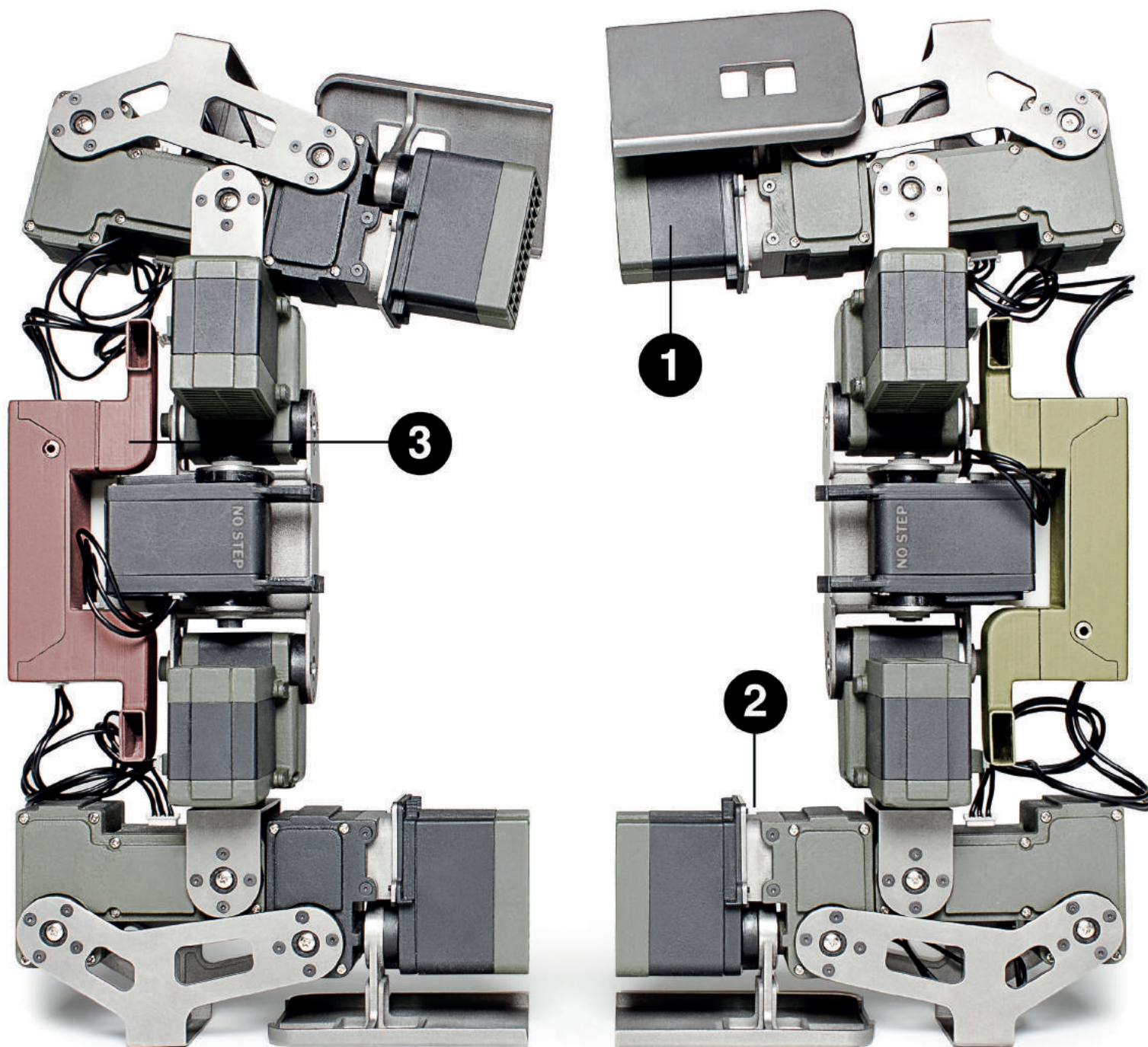

Fig. 1: Two fully functional ABS 3D-printed and titanium-sintered robots shown in the stowed position. Parts: (1) motors, (2) exoskeleton and (3) power plant and sensor package.



PERIPATETIC FABRICATION: ARCHITECTURE, CO-ROBOTICS AND MACHINE VISION

MIKE SILVER (UNIVERSITY OF BUFFALO, NEW YORK)

This essay explores the potential impact of situationally aware, walking machines on architectural design and construction. Rather than pursuing new applications for factory-based articulated arms, fellowship research conducted between 2011 and 2013 looked at how networked devices equipped with emerging machine vision technologies could work cooperatively with humans in complex, outdoor environments. This work required an expanded conception of digital fabrication and the application of tools not currently used in the discipline. With rudimentary software and scaled prototypes, students and faculty were able to create functional systems that open up design thinking to the potential of digitally controlled legs and hands.

Today, computers have become cheap, small and fast enough to operate in ways that were unachievable in decades past. At this moment, following Moore's Law, the real-time coordination of low cost, high-definition sensors and complex motion control has now become technically feasible. While the discipline's interest in responsive systems, interactivity and cybernetics is nothing new, the availability of increased processor speeds has facilitated an unprecedented level of system complexity and responsiveness. This is the age of zoomorphic machines capable of emulating behaviour formally reserved for fully evolved biological systems. The development of networked swarms, android servants and lifelike quadrupeds suggests the next phase of architectural robotics when devices which were once blind and immobile (CNC mills, laser cutters, etc.) begin to move about, sense their surroundings and interact with humans in complex milieus. While automated dishwashing and laundry folding will likely be popular applications for domestic robots in the near future, consider their use in building design and construction.¹ Armed with sophisticated sensors and fast brains, a new generation of machines has evolved the ability to operate in spaces inaccessible to wheeled vehicles. These systems possess astonishing powers, including the ability to traverse uneven ground and interact with changing circumstances in real time.

DRIVERLESS BUILDING BLOCKS

Initial research conducted at Ball State University considered the robotic manipulation of objects at both the scale of individual bricks and at the scale of a small community composed of prefabricated housing modules (fig. 2). While there are no significant barriers to implementation of this system on an urban scale, the speculative nature of such an endeavour suggested the more modest goal of automating masonry construction. Building a well-made brick and mortar structure requires the cooperation of at least three individuals who together must be able to stack an average of a thousand bricks a day. Bricklaying teams are usually composed of a skilled master craftsman who lays mortar and block with two assistants or hod carriers re-

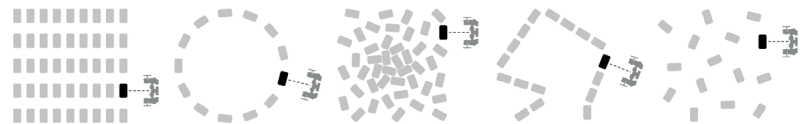

Fig. 2: Speculative diagram of a universal urban fabrication system. Large-scale walking machines could be used to create nomadic buildings that operate without the need for a fixed-in-place infrastructure. Multiple planning configurations can be established according to changing user needs, climate conditions and existing topographies.

sponsible for mixing cement and transporting material to and from a wall. Hod carrying is a hazardous job plagued by many of the long-term health problems one normally associates with repetitive and physically challenging activity. In a field already short on qualified workers, hod carrying seems like an activity ideally suited for robots.

Fellowship research therefore focused on the development of low-cost, highly manoeuvrable and easy-to-operate, co-robotic platforms capable of increasing the productivity of master masons in their effort to construct ever more complex brick and mortar structures. In the lab, bipedal and quadrupedal prototypes were developed that can autonomously navigate difficult terrain.² These systems not only carry bricks to a worker on a messy job site, they can also stack units by forming a well-choreographed, co-creative exchange between man and machine. With an upgraded system, craftsmen laying mortar would be able to receive materials on a 'just-in-time' basis. Equipped with the power to select block styles from depalletized stacks containing a variety of unit types, colours or materials (glass, stone or fired clay bricks), a small group of inexpensive robots could speed the production of large mosaics with increased accuracy and thrift.

PROCESS AND FUTURE GOALS

Fellowship work was divided into eight distinct phases. These included: technical research, on-site mapping, payload analysis, robot design, prototype manufacturing, machine vision simulation, motion control programming, and physical testing. Students and faculty worked closely at each stage of the process. Quick tours of local construction sites were organized early in the spring of 2012, followed by interviews with job supervisors who identified hod carrying and on-site waste disposal as potential work for robots. Machine parts, including all motor casings, payload designs, and exoskeletal supports, were custom-built using fused deposition modelling technology (FDM) and advanced 3D metal sintering (figs. 1, 3). Plastic boxes were printed as placeholders for full-scale components made from terracotta, mud brick and concrete block. The only off-the-shelf components employed in the prototype were Yuntong lithium batteries, hex head screws, insulated cables and a CM-530 microcontroller from Robotis Inc.

Rudimentary machine vision experiments were conducted by mounting an unpacked Microsoft Kinect © scanner on top of a partly disassembled Darwin OP humanoid robot (fig. 4). Future research will focus on the development of custom software controls that allow an even more complex device to map

its surroundings, track objects and interact with changing conditions in real time. Fellowship team members also built a semi-functional, iPad-based social networking platform and control panel that combined video conferencing, web uplinks and four rotating monitors from the full-scale robot's on-board sensors. (Live wireless video feeds, night vision, 3D scanners and thermal imaging cameras were not integrated into the tablet app.) Tests of the manoeuvrability, gripping and self-storage functions of the designs were made late in the spring of 2013. These tests demonstrated the ability of each prototype to walk up stairs, balance on one foot, grab objects and move bricks to predetermined locations. Given precedents like the

Fig. 3: Payloads ascending a staircase. This working prototype demonstrated the ability of a leg-based robot to carry three stacked components all at once. These horizontal units were conceived at multiple scales as either small building blocks or large modular housing units.

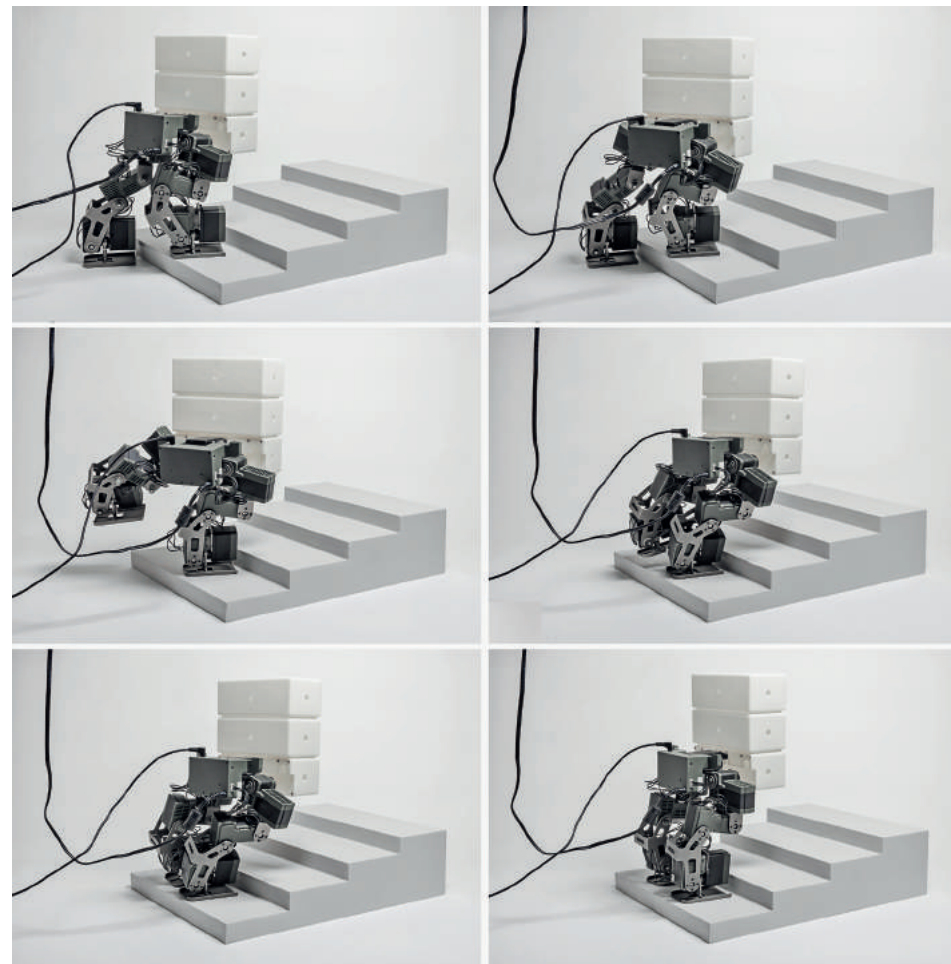

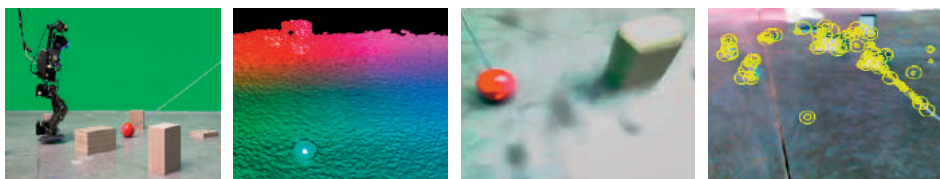

Fig. 4: Our team mounted a 3D scanner above the motion tracking video camera of a Darwin OP bipedal robot. This set-up allowed the machine to make accurate 3D terrain maps of its surroundings while tracking a tagged colour object. Darwin has a 32-bit processor and can be used as a software development platform for designing future navigation controls. Left to right: Robot following a moving ball, 3D mesh, video camera POV, and an edge detection system.

Fig. 5: Two bipeds can combine to form a more stable quadruped that can carry large payloads.

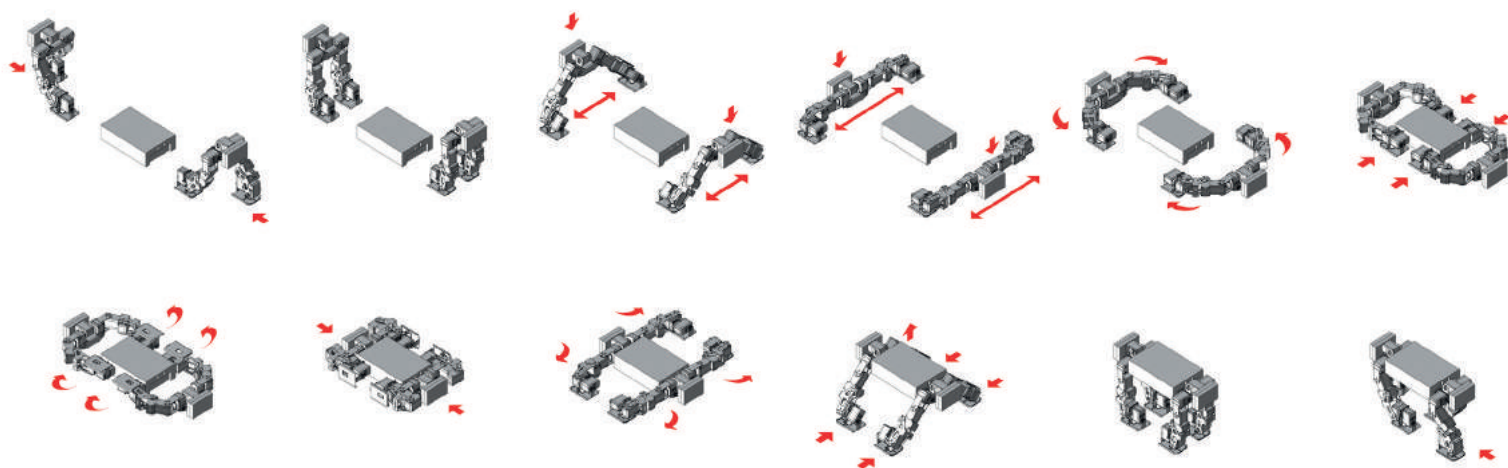
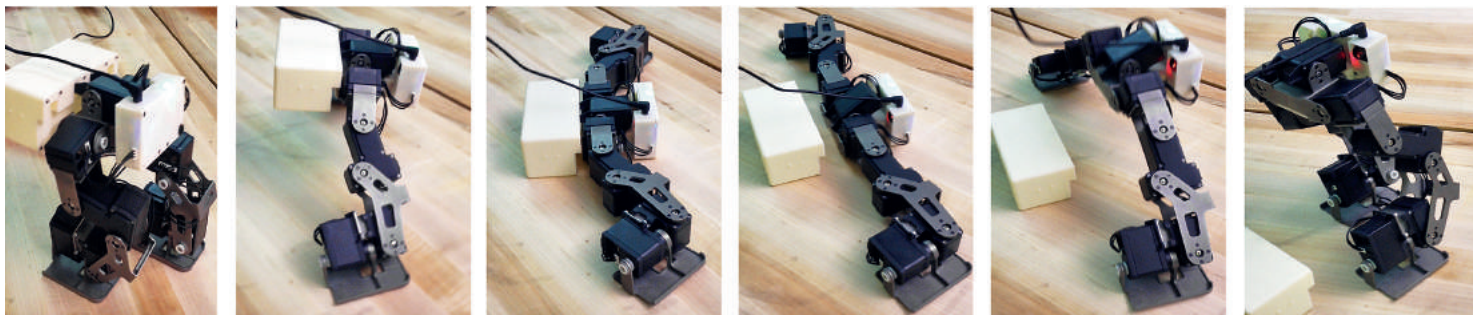

Fig. 6: Bipedal robot deploying an object. This working prototype uses its legs to both grab and transport individual payloads.



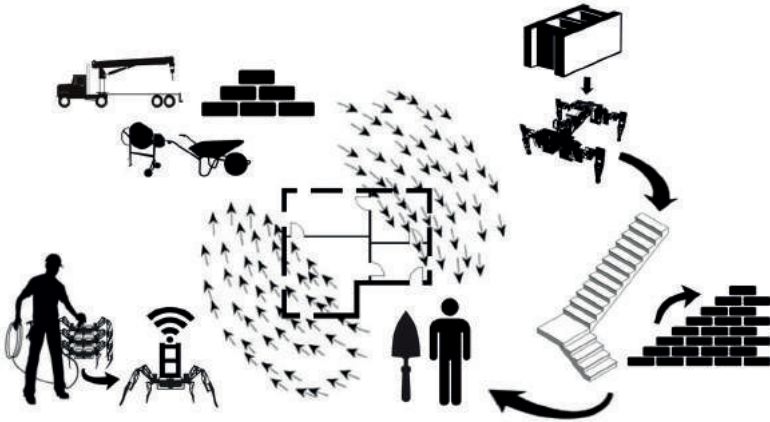

Fig. 7: Like an ant swarm, a future low-cost system could carry materials to a mason, navigate the difficult terrain of a real job site and travel up stairs. The ability to coordinate each robot allows the delivery of bricks and mortar on a just-in-time basis. Unit types, colours and positions can also be tightly controlled. With the right commands, the flock of quadrupeds can assemble a wall while a craftsman lays cement and rakes mortar.

Jasmine III micro-bots, there seem to be no significant technical barriers to the full-scale implementation of this system in low-cost, easy to transport, Bluetooth-connected swarms.

The system proposed in figure 7 will be able to complete construction tasks in areas inaccessible to wheeled vehicles. They will also be able to map the activities of multiple sites though the same up linked sensors that allow them to achieve real-time situational awareness. The acquired data can be used to understand the process of building production over time though an active cartography of supply chains, work reports, information sharing and human activity monitoring. Compiling information on the micro scale can have a profound impact on our understanding of how architecture operates as a whole. Networked robotic agents working in tandem with real people presents a unique opportunity to extend computation into realms that are currently beyond the reach of existing tools. In order to understand the architectural implications of our research we explored the possibility of using leg-based robots to build complex, non-standard brick and glass block walls for a museum in Silicon Valley (fig. 9).

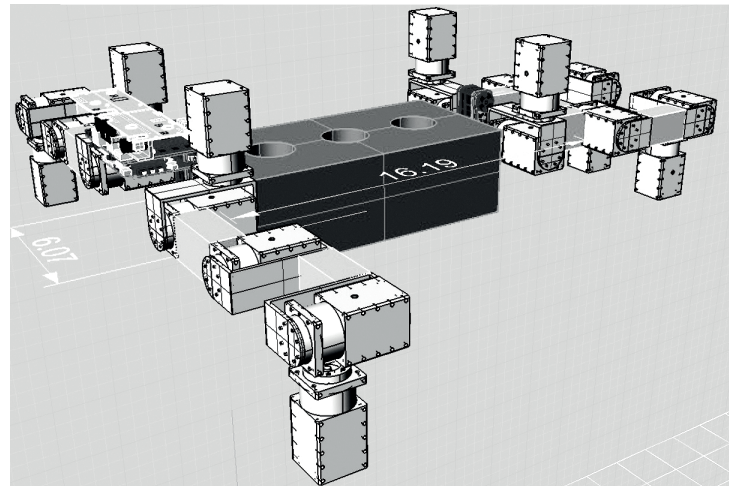
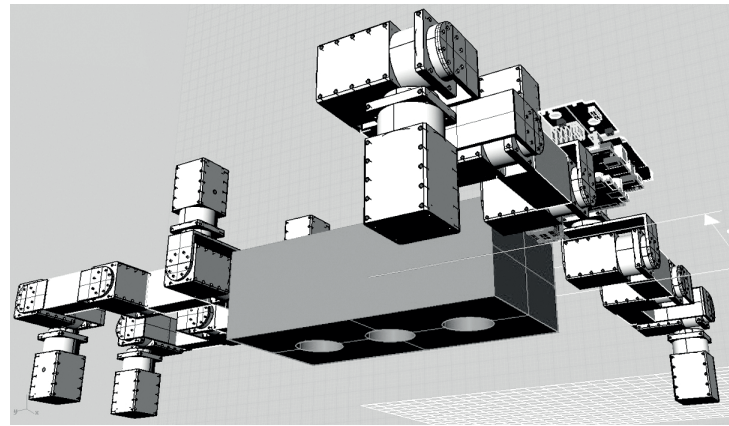
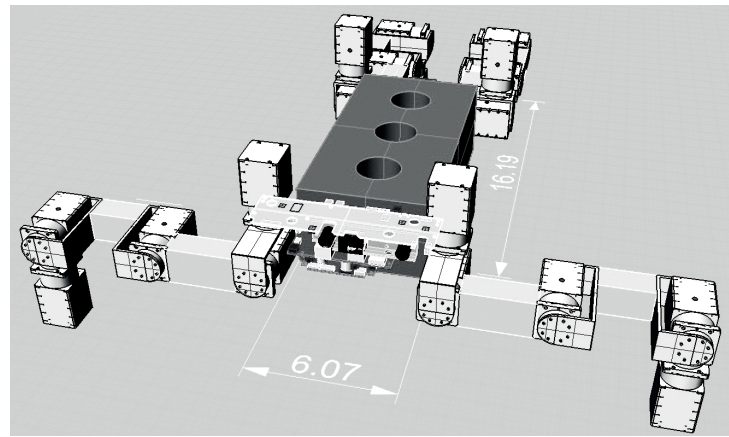

Fig. 8a–c: Sketch model of our proposed full-scale quadruped brick-stacking robot with high-powered servos motors.

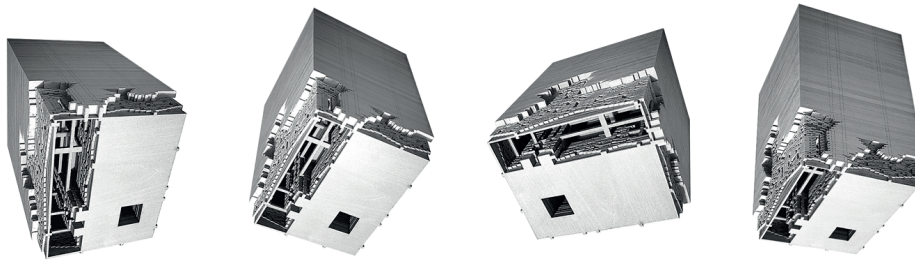

Fig. 9: Model of the San Jose State University Museum of Art and Design, San Jose, California. Low-cost, peripatetic robots could help facilitate the construction of this complex, non-standard brick and glass block structure.

CONCLUSION

While robotics will continue to influence the way buildings are designed and constructed, current developments in the field will likely have a significant impact on everyday life. In addition to form, tectonics and decoration, this next phase will force architects to confront changing social conditions influenced by the presence of constantly evolving intelligent machines. Just as new industries fuelled the rise of Modernism in the early 20th century, the inevitable development and potential ubiquity of advanced robotic technologies implies the need for a creative reassessment of how designers think about function, labour relations and economics. This reassessment will also have to consider issues long ignored in digital architecture theory with its almost total neglect of mainstream AI research and the important role it is playing in the development of robot ethics.³ As machines become more and more lifelike, difficult questions about consciousness and how it fits into the natural order will also have to be seriously examined.⁴ Along these lines, a series of important shifts in the future of computer-aided fabrication are just now coming into focus:

Old	New
Robotics	Co-robotics
Fixed in-place/wheeled	Peripatetic mobility
Low autonomy	High autonomy
The new materialism	The mind/body problem

CREDITS

Laboratory of Architecture and Applied Robotics (LAHRs/BSU):
 FACULTY: Mike Silver, University of Buffalo, Mahesh Daas, Ball State University (BSU), Josh Vermillion, BSU, and Josh Coggeshall, BSU.
 BSU STUDENTS: Yevgen Monakhov, Jason Foley, Matthew Fullenkamp, William Zyck, Justin Krasci, Michael Bolatto, Tyler Cox, Glenn Cramer, Robert Cichocki, Antone Sgro, Derek Anger, Tianxia Peng, Derek Newman, David Smith, Yao Xiao, Mathew Wollak and Thomas Friddle.

NOTES

1 In early 2013, following the success of its driverless vehicle initiative, the Defense Advanced Research Projects Agency (DARPA) issued a call to explore the practical implementation of humanoid robotics in real-world environments such as construction sites and disaster areas.

2 See a walking prototype at:
<http://www.youtube.com/watch?v=LPedOjZAYy>.

3 An overview of the latest advances in robotics and artificial intelligence can be found in Kevin Warwick's 'Robots with Biological Brains', in Patrick Lin, Keith Abney and George A. Berkey, eds., *Robot Ethics: The Ethical and Social Implications of Robotics*, (Cambridge, Mass.: MIT Press, 2011) pp. 317–32.

4 For an overview of the 'hard problem' concerning subjective mental states, see David Chalmers, 'Consciousness and Its Place in Nature', in *ibid.*, ed., *Philosophy of Mind: Classical and Contemporary Readings* (New York: Oxford University Press, 2002) p. 247.

Fig. 1: Perspective view of the Silk Pavilion and its complementary basic research exhibit.
(Photo: Steven Keating.)



SILK PAVILION: A CASE STUDY IN FIBRE-BASED DIGITAL FABRICATION

NERI OXMAN, JARED LAUCKS, MARKUS KAYSER, JORGE DURO-ROYO, CARLOS GONZALES URIBE
(MEDIATED MATTER GROUP, MIT MEDIA LAB)

The Silk Pavilion explores the relationship between digital and biological fibre-based fabrication on an architectural scale. Its primary structure is comprised of 26 silk-threaded polygonal panels laid down by a CNC (Computerised Numerical Control) machine. Inspired by the silkworm's ability to generate a 3D cocoon out of a single multi-property silk filament, the Pavilion's overall geometry was created using an algorithm that assigns a single continuous thread across patches, providing functional density gradients informed by environmental constraints such as light and heat. Overall density variation was informed by deploying the *Bombyx mori* silkworm as a biological multi-axis multi-material 3D 'printer' in the creation of a secondary fibre structure. 6500 silkworms were positioned on the scaffold spinning flat non-woven silk patches to locally reinforce the CNC-deposited silk structure. The paper provides a review of basic research into the silkworm's spinning behaviour, material and structural characterisation, computational simulation and fabrication strategy devised for the full-scale construction of the Pavilion. Potential applications for large-scale fibre-based digital fabrications that involve biological fabrication conclude the paper.

BACKGROUND AND MOTIVATION

FIBRE-BASED CONSTRUCTION

Digital fabrication processes, such as layered manufacturing, typically involve the layered deposition of materials with constant homogeneous physical properties.¹ Yet most natural and biological materials are made of fibrous structures locally aligned and spatially organised to optimise structural and environmental performance.² In the fields of product and architectural design, specifically, the automotive and avionic industries, fibre-based digital fabrication has typically been confined to the development and application of high-performance composites.³ These materials and their related processes are typically toxic and harmful to the environment. Based on previous research and inspired by the *Bombyx mori* silkworm, this research explores the possibility of merging digital and biological fabrication to deliver a holistic and sustainable design approach in the production of non-woven fibre-based constructions.⁴

Construction processes found in nature such as woven spider nets or aggregate bird's nests are characterised by the animal's ability to generate, distribute, orient, densify and assemble fibre-based composite material.⁵ Spiders, for example, can generate fibres with varying properties based on a par-

ticular need or function. These fibres are optimised for a wide range of different conditions including, but not limited to, mechanical properties such as strength and toughness. In addition to many existing types of silks, the silk itself may be rapidly adapted to different parameters during the silk spinning process. The final webs take into account a delicate balance of function, environmental conditions and material efficiency as limited by the energy resources of the spider.⁶ Similarly, the silkworm can control the ratios of fibres and matrix to generate a wide array of mechanical properties ranging across tensile and compressive structures.⁷

BASIC RESEARCH INTO FIBRE-BASED COCOON

CONSTRUCTION OF SILKWORMS

ANATOMY, BEHAVIOURS AND METHODS

The *Bombyx mori* silkworm is an arthropod with a body of approximately two to three inches in length. A division in the legs around the mid-portion of the body allows the worm to bend freely from side to side in its typical figure of eight motion (fig. 2). The silkworm's spinneret is located near its head, allowing the organism to extrude upwards of one kilometre of raw silk fibre. It traditionally spins silk in its fifth instar (stage between moults) after one to two months of feeding on mul-



Fig. 2: A *Bombyx mori* silkworm spins silk fibre on a digitally fabricated scaffolding structure.

berry leaves as it matures into a silk-producing caterpillar. When prepared to spin, the silkworm typically triangulates a three-dimensional space or corner forming a tensile structure within which the cocoon is formed.⁸

Silk production typically involves the harvesting and soaking of completed cocoons in a soapy water bath. The edge of an individual fibre is then pulled out of the bath and spun onto a spool for silk thread production. This production method requires the spinning of a full cocoon and a shortened life cycle for the silkworm, eliminating the opportunity for reproduction.

ADVANCED IMAGING TECHNIQUES AND QUANTITATIVE ANALYSIS OF SILK COCOONS

Basic research was conducted to further observe, understand and predict the motion and material deposition behaviour of the silkworm, implementing the following tools, techniques and technologies:

(1) Dynamic tracking was achieved by the application of magnetometer motion sensing to motion-capture a silkworm over the course of a 3-day cocoon construction period, during which the silkworm was tracked by attaching a miniature magnet to its head. The organism was placed in a boxed space fitted with three magnetometers capturing the worm's movement in 3D space. Data collected were converted into a visual representation of a point cloud (fig. 3).

(2) Wide-angle high resolution MicroCT (microtomography) and SEM (scanning electron microscope) imaging techniques were developed and implemented to analyse the organisational properties of silk textures across various length scales and species. SEM imaging techniques enabled micro-scale analysis of material property variation across the transversal and longitudinal sections of the cocoon.

(3) Template fibre-spinning experiments: it was observed that when spinning on a relatively flat environment, the silkworm generates a flat non-woven silk patch. Building on this observation, and coupled with previous research,⁹ a suite of environments with varying morphological features was developed in order to explore the relationship between surface features and fibre organisation.¹⁰

Experimental results determined the following: (1) A 3D cocoon structure emerged only at a sectional height of 21 mm; below this, a tent-like structure in the form of a rectangular pyramid was spun. In the absence of this height, a non-enclosed surface patch was spun. (2) Fibre density typically varied as a function of the distance from the central vertical pole to the surface boundary. This may point to a local optimal condition requiring the least amount of energy for the construction of a strong stable structure within a given timeframe. (3) Boundary contours were typically denser. This is most likely due to the silkworm's constant search for a vertical pole tall enough to allow for cocoon construction.

COMPUTATION AND DIGITAL FABRICATION COMPUTATION

The pavilion was designed and constructed in two phases: the first phase consisted of digitally fabricating a scaffolding envelope made of silk fibres and the second phase consisted of deploying thousands of silkworms to spin a secondary silk envelope. A set of apertures built into the initial envelope capture light and heat, thus controlling the distribution of silkworms on the structure.

Overcoming current limitations of existing computer aided design (CAD) tools, a parametric environment was devel-

Fig. 3: a) Silkworm with attached magnet for motion tracking. b) A *Bombyx mori* silkworm positioned within a magnetometer testing rig. c) Point cloud visualisation based on magnetometer testing rig data.

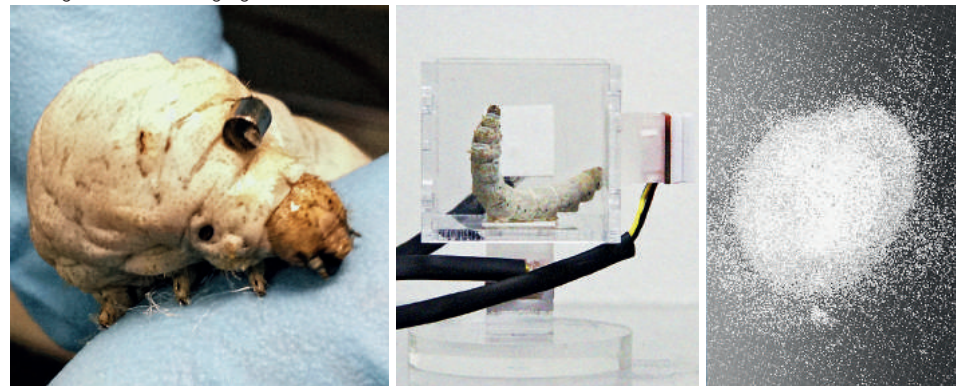

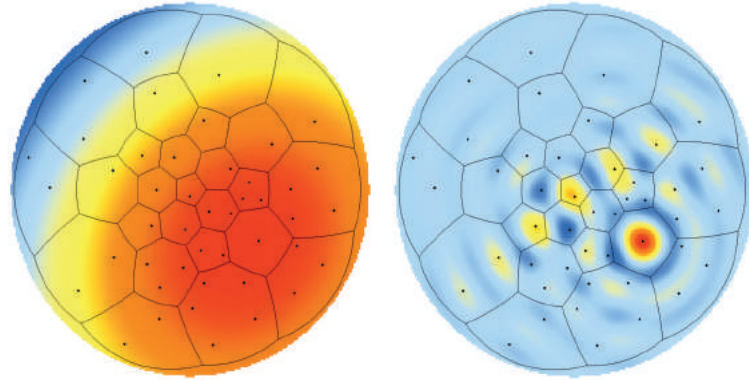

Fig. 4: a) Computational projection of panelled dome: solar mapping. b) Computational projection of panelled dome: aperture distribution mapping.

oped that facilitates the design and fabrication phases of the project, enabling continuous iteration between digital form-finding and physical fabrication processes. As such, this computational tool also served to mediate between environmental input, material properties and organisation as well as biological fabrication constraints. In addition, the tool enabled real-time evaluation of multiple design solutions.

The main goal was to develop a holistic computational design environment able to simultaneously capture and process multiple sets of complex constraints in real time. Most of these constraints are difficult or impossible to capture using current CAD tools. Amongst them is the ability to automatically determine for every digitally woven silk fibre what the conformal distance or space is within which the silkworm can spin, enabling the convergence between the digitally laid fibres and the biologically spun filaments.

A subsequent goal was to computationally embody the geometrical complexity and scalability of the Pavilion, as well as the scaffolding resolution and the range of fabrication tools used. The resulting tool informs the designer about overall material organisation as well as the effects of the biological parameters (such as silkworm motion range) on the final design.

The generative environment includes a new library designed on top of the RhinoCommon build that runs on the Grasshopper plug-in (in McNeel Rhinoceros 3D Modeler). The library comprises a set of routines that enable the shaping of a lightweight fibrous environment. The following data sets informed the algorithm for scaffolding thread geometry: the first set contains the fabrication constraints captured by the algorithm. These constraints are informed by the robotic manufacturing platform along with its prescribed gantry size and tool reach. This set generated the need for a spherical struc-

ture of the pavilion to be subdivided into a set of substructural patches. The patches conformed to a truncated icosahedron whose faces fit the robotic manufacturing bed. The second set of constraints originated in two data maps; the first map encoded the specific on-site solar trajectory and the second provided an opening radius multiplier to generate organisational fibre variation. Combined, these two maps informed the position and size of the pavilion apertures (fig. 4). The third set of constraints is linked to the silkworm's biological characteristics, with the goal of providing maximum silk deposit reach.

For each aperture, the position and size of which is determined by the site's light conditions, the computational protocol identifies a continuous tangent circle on the spherical geometry (fig. 5a). It is subsequently converted into tangent line segments, represented in 2D, matching the patch fabrication representation. For each such circle, a parameter controlling the resolution of the tangents relative to its geometry was assigned. This parameter determines the ratio between local fibre gradients to overall fibre distribution and organisation. The algorithm then checks each aperture to find out if it is contained within a prescribed patch, multiple patches or none, and classifies this information as data lists. For each patch containing a full or partial aperture, the algorithm computes the following: (1) Aperture formation in relation to the overall image of a continuous thread (fig. 5b). (2) Thread redistribution across apertures, providing balance between aperture distribution and continued thread allocation across the surface area of the overall volume. (3) Contour attachments for local continuous threads. (4) Scaffolding thread-spacing conformation to biological parameters of the silkworm weaving pattern (fig. 6a). (5) Robotic toolpath for fabrication (fig. 6b).

A final overall visualisation of the pavilion, aluminium frame profiles for water jet manufacturing of the patches (visu-

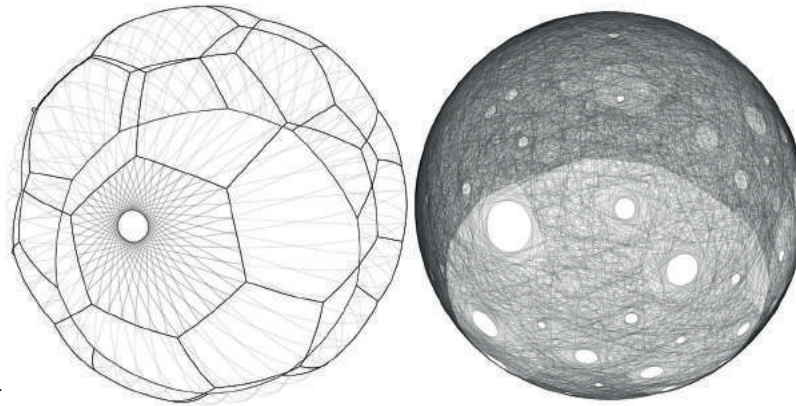

Fig. 5: a) Computational generation logic of single aperture.
b) Final computational path with global aperture distribution.

alised as the polygonal line segments), and unfolded toolpaths for CNC weaving are then generated as output (fig. 7).

DIGITAL FABRICATION

Based on the analytical protocols developed and reviewed above, a digital fabrication approach was developed that supported the findings with regard to the worm's possible range of motion and deposition behaviour, thus enabling the digital fabrication tools and biological construction to merge.

Initial toolpath development was tested with a three-axis CNC (Computer Numerically Controlled) machine. Initial computational paths were explored and implemented as traditional milling toolpaths without using the machine's spindle activation. These tests were originally developed as a drawing method prior to the development of the thread deposition tool (fig. 8).

Continued development of the CNC toolpath output (from the digital model to the machine) enabled the development of

a basic tool that allowed for the deposition of thread as a spool or roll-based material. The gantry of the three-axis machine carried the rolls to be replaced as required based on the panel to be fabricated. A tool tip was developed that could be affixed into the normal collet design of the cutting head; the spindle would remain off and in a locked position. The spooled material could then be fed down through the tool tip inside a low friction HDPE (high-density polyethylene) tube. The tube ends in a custom-made press-fit bearing attached to a rotating shaft with a spring-loaded foot where the string could exit smoothly and in accordance with the direction of machine travel. The deposition of a lightweight material onto a temporary aluminium frame allowed the machine to run at higher velocities than normal cutting operations, thus aiding the speed of the fabrication process.

The perimeter of the unfolded 2D panels making up the overall form of the structure was designed as perimeter scaf-

Fig. 6: a) Computational silkworm spinning range calculation.
b) Computational unfolded panel and toolpath diagram.

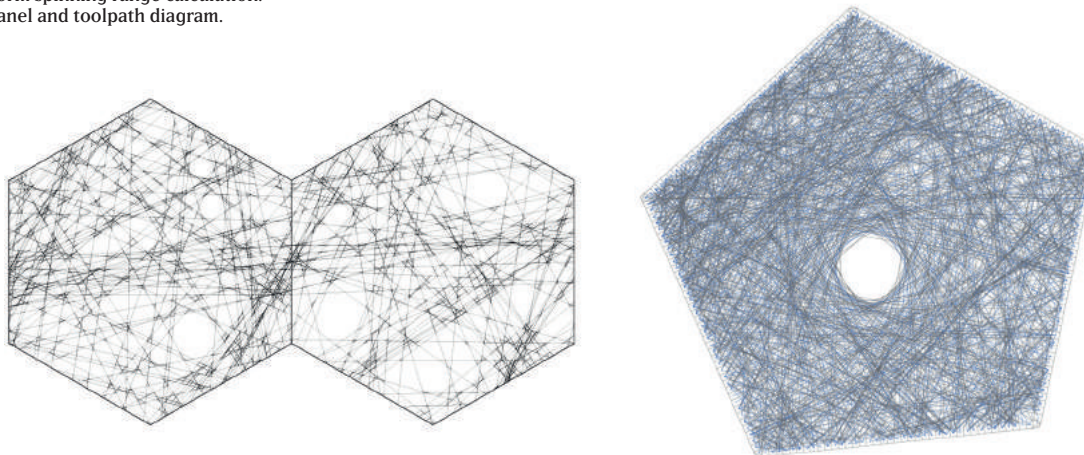

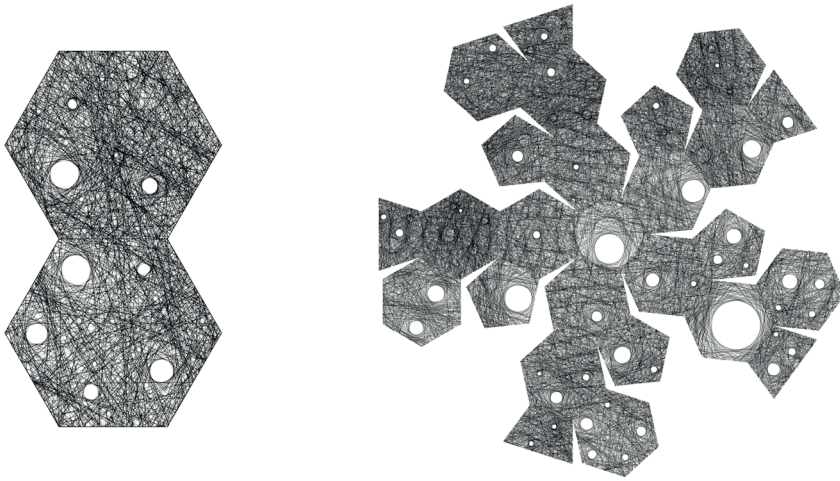

Fig. 7: a) Computational unfolded panel detail.
b) Computational unfolded overall panel layout for fabrication.

folding structures. They were cut from aluminium using water jets in order to maintain the deposited silk fibres during the fabrication process. The choice of a component-based assembly was dictated by the relatively large size of the overall structure and the limitations given by the gantry size of the CNC spinning tool. Designed as a temporary support, these panels could be reassembled after weaving to maintain the overall geometry of the system while installing it into a tensioned state in the atrium space of the Pavilion (fig. 9).

The frames were developed with small hook elements to allow the deposit of fibres. A release mechanism enabled the extraction of the frames once the panels were joined together and the structure was positioned in space. Between the joining edges of each frame was a small rubber-coated frame of piano wire to which the vertex nodes of the structure were affixed. The vertex nodes were to be used in attaching the tensile structure to its surrounding environment and the piano wire was the medium around which the edge of each panel was affixed (fig. 10).

Once the truncated icosahedron panels were assembled and knotted edge-to-edge, the overall structure was raised to its proper height and location, followed by the deployment of a series of tension lines. Each of the lines was affixed to a custom designed acrylic clip; each point location was calculated as part of the digital model of the vertex's normal intersection within the space. Tension cable lengths were measured, located and labelled. Once the structure was in place, the entire vertex and centroid tension lines were installed and tensioned to their marked lengths, suspending the metal frame and the structure in space. At this point, the frames were

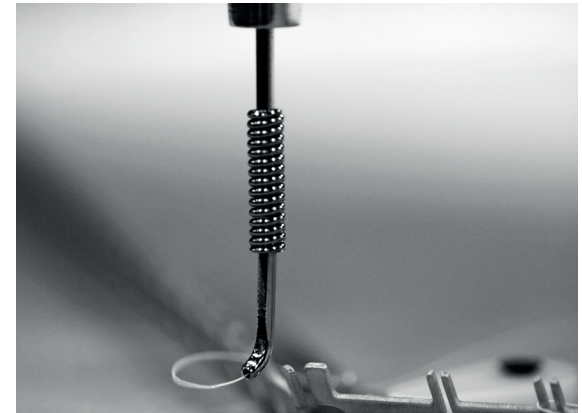

Fig. 8: Spring steel CNC threading tool and silk thread.

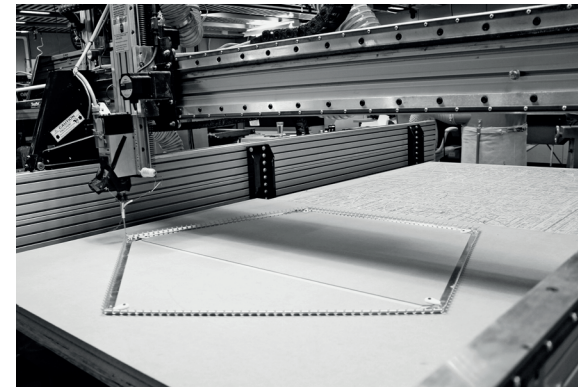

Fig. 9: Three-axis CNC machine adapted as CNC deposition tool. Custom threading tool, temporary aluminium scaffolding and MDF jig.



Fig. 10: Knotting of vertex connections of non-woven silk patches on temporary aluminium scaffolding structure.

removed, starting from the top of the structure and working down in circular fashion. Following the removal of the frame, some tension was lost that was recovered after the centroid suspension lines were tensioned. The bottom of the structure was affixed to a 25 mm thick MDF floor structure with a white vinyl covering.

BIOLOGICAL FABRICATION

Parallel to the digital fabrication of the primary structure, 6500 silkworms were raised through the remainder of their fifth instar feeding on a diet of mulberry leaves prior to the silk spinning phase (fig. 11). Reared in a light- and temperature-controlled room at the MIT Media Lab, the silkworms were fed and monitored over the course of several weeks. As the worms began spinning, they were transferred onto the tensioned silk structure with a protective fence and drop cloth in place.

Over a ten-day period, all silkworms were positioned on the scaffolding structure, typically initiating spinning from the bottom rim upwards (fig. 12).

Most silkworms were found to settle into a single space over the surface area of the structure, spinning flat patches in circular motion. In addition, most silkworms were found to migrate to the highest surface patch of the structure, possibly due to a combination of high temperature, low lighting conditions and decreased metabolic cost that is the result of horizontal movement (fig. 13).

Following two to three spinning days, the silkworms were released from the structure and collected on a drop cloth at the bottom of the dome. The silkworms were able to continue their cycle of metamorphosis into a silk moth, including egg laying and reproduction.

SUMMARY AND POTENTIAL APPLICATIONS

The Silk Pavilion explores the duality of digitally and biologically fabricated structures by proposing a template construction approach to fibre-based digital fabrication. In this approach, digital tools are implemented to deliver a highly differentiated scaffold, on top of which a biological system is deployed. The two systems are complimentary: while one provides the load-bearing paths of the structure, the other strengthens these trajectories and acts as a skin. Moreover, the biologically deposited silk embodies qualities associated with its scale that could not have been achieved using current digital fabrication tools. The silkworm-spun non-woven fibroin adheres to and wraps around the digitally deposited silk fibres and provides for a fibrous 'infill' due to the interaction



Fig. 11: Approximately 1000 *Bombyx mori* silkworms in their fifth instar upon arrival.



Fig. 12: View through pavilion apertures as the silkworms put a skin on the structure.

between the two chemical agents deposited by the silkworm: the fibroin that acts as fibre and the sericin that acts as glue or connective tissue. The template construction approach can be implemented using other types of digital fabrication tools and biological systems. In this respect, the computational environment developed for this project is considered a generative one: it can address other similar problems across a range of scales and across an array of fabrication methods, environments and biological systems of choice.

Several potential applications may be considered as possible outcomes of this research. With regard to the direct potential for biological fabrication combined with digital fabrication, the experimental data affirming the relationship between scaffold surface morphology and biological fibre organisation

can be considered the most valuable (fig. 1). Further research will explore various techniques for using templates in biological fabrication in order to generate highly controlled and tunable functional gradients of material properties. New types of high-performance textile composites may be designed in this way, not unlike the composites observed on the pavilion which combine internal and external natural-silk wrapping of the synthetic threads. In addition, direct silk fibre deposition onto a scaffolding structure not only bypasses the processing of silk cocoons into thread and textile, but also promotes a more sustainable silk harvesting cycle. Finally, with regard to decentralised swarm-like construction processes similar to the ones viewed in nature, future developments in the potential of collaborative construction behaviour will be further explored.

The Silk Pavilion was developed by the Mediated Matter Group at the MIT Media Lab in collaboration with James Weaver of the Wyss Institute (Harvard) and Prof. Fiorenzo Omenetto of Tufts University. The project was developed as part of ongoing research investigating fibre-based digital fabrication methods¹¹ combined with relevant cases found in nature. The construction stage explored the relationship between digital and biological fabrication on product and architectural scales.

Fig. 13: Top view of the Silk Pavilion as approximately 6500 silkworms construct the fibrous composite.



ACKNOWLEDGEMENTS

Research and Design by the Mediated Matter Research Group at the MIT Media Lab in collaboration with Prof. Fiorenzo Omenetto (TUFTS University) and Dr James Weaver (WYSS Institute, Harvard University). This work was supported in part by NSF EAGER Grant Award No. #1152550 'Bio-Beams: Functionally Graded Rapid Design & Fabrication'. We gratefully acknowledge the support of the Institute for Collaborative Biotechnologies through Grant No. W911NF-09-0001 from the U.S. Army Research Office and the support of the MIT Institute for Soldier Nanotechnologies (Contract No. DAAD-19-02-D0002). The content of the information does not necessarily reflect the position or the policy of the Government, and no official endorsement should be inferred. The Mediated Matter Group would also like to thank the Center for Bits and Atoms for providing some of the fabrication technologies for the realisation of this project.

NOTES

- 1 Hu Tao, David L. Kaplan and Fiorenzo G. Omenetto, 'Silk Materials, a Road to Sustainable High Technology', *Advanced Materials*, 24/21 (2012), pp. 2824–37.
- 2 Janine M. Benyus, *Biomimicry* (HarperCollins e-books, 2009), pp. 6967–85; Fiorenzo G. Omenetto and David L. Kaplan, 'New opportunities for an ancient material', *Science*, 329 (2010), pp. 528–31; Neri Oxman, Markus Kayser, Jared Lauks and Michal Firstenberg, 'Robotically Controlled Fiber-Based Manufacturing as Case Study for Biomimetic Digital Fabrication', in Helena Bártolo et al., eds., *Green Design, Materials and Manufacturing Processes* (London: CRC Press, 2013a), pp. 473–8; Neri Oxman et al., 'Freeform 3D Printing: Towards a Sustainable Approach to Additive Manufacturing', in *ibid.*, p. 479–84 (2013b).
- 3 Matilda McQuaid and Philip A. Beesley, *Extreme Textiles: Designing for High Performance* (New York: Princeton Architectural Press, 2005).
- 4 Oxman et al. 2013b (see note 2), p. 479.
- 5 Karl von Frisch and Otto von Frisch, *Animal Architecture* (New York: Harcourt Brace Jovanovich, 1974).
- 6 Frisch and Frisch 1974 (see note 5); Fritz Vollrath, 'Strength and Structure of Spiders' Silks', *Reviews in Molecular Biotechnology*, 74 (2000), pp. 67–83.
- 7 Frisch and Frisch 1974 (see note 5); Omenetto and Kaplan, 2010 (see note 2).
- 8 Frisch and Frisch 1974 (see note 5).
- 9 Brian D. Lawrence, Fiorenzo Omenetto, Katherine Chui and David L. Kaplan, 'Processing Methods to Control Silk Fibroin Film Biomaterial Features', *Journal of Materials Science*, 43 (2008), pp. 6967–85; Omenetto and Kaplan, 2010 (see note 2); Tao et al. 2012 (see note 1).
- 10 Oxman et al. 2013a, b (see note 2).
- 11 Lawrence et al. 2008 (see note 9).

Fig. 1: Persistent Model #2: a full-scale speculative construct demonstrating a computationally led investigation into irregular double-layer tensegrities. (Photo: Anders Ingvarsen.)



MULTI-SCALAR SHAPE CHANGE IN PNEUMATICALLY STEERED TENSEGRITIES: A CROSS-DISCIPLINARY INTEREST IN USING MATERIAL-SCALE MECHANISMS FOR DRIVING SPATIAL TRANSFORMATIONS

PHIL AYRES, KASPER STOY, DAVID STASIUK, HOLLIE GIBBONS

Concerns with sustainability are providing an increasingly powerful impetus towards the investigation of dynamic and adaptive architectures. This presents an increased overlap with the discipline of robotics, making collaboration between the two fields interesting and potentially fruitful. This paper presents a cross-disciplinary work-in-progress that is investigating how standard materials might be organised and processed in novel ways to promote active physical transformations of architectural structures and to assess the impact that multi-scalar shape change might have upon environmental performance. This work builds upon prior research investigating tensegrities and other pneumatics, including free-form inflated metal.

INTRODUCTION

Addressing concerns of sustainability through the lens of improving life-cycle performance in buildings is providing an increasingly powerful impetus towards the investigation of dynamic and adaptive architectures.¹ As architects begin to conceptualise and cultivate the territory of dynamic and adaptive architecture, it is worthwhile considering where overlaps with other disciplines emerge. The discipline of robotics provides a significant body of research addressing such issues as adaptation, resilience, self-awareness and morphology in artificial physical objects.² Underlying these interests is a core concern with control and motion, i.e. dynamics. This makes collaboration between the two fields potentially fruitful. Interestingly, the basis of establishing a common language between the two disciplines is not necessarily initially found amongst the concerns with dynamics, control and motion, but rather with material performance, material assignment and material organisation.

This paper presents and positions work-in-progress arising from just such a cross-disciplinary collaboration that is investigating how standard materials might be organised and processed in novel ways to promote an active physical transformation of architectural structures and to assess the impact

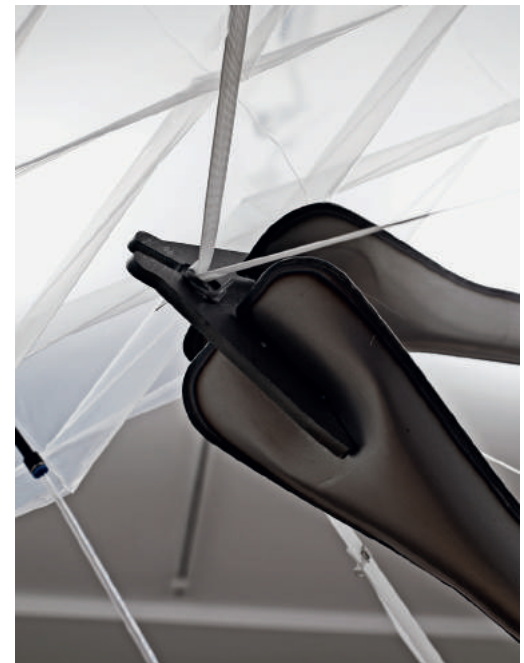

Fig. 2: The construct employs two classes of inflatable component, one 'hard' metallic, one 'soft' foil laminate. (Photo: Anders Ingvarsen.)

that multi-scalar shape change might have upon environmental performance.³ This collaborative effort builds directly upon ongoing research being conducted at the Centre for Information Technology and Architecture (CITA), which has resulted in a recently completed and exhibited full-scale speculative construct (fig. 1). The construct is an irregular double-layer tensegrity that employs two classes of inflatable components: 'hard' metallic and 'soft' foil laminate (fig. 2). This construct is also presented in this paper.

The current collaborative focus operates directly from a reflection of this research demonstrator and the identification of its potential that pertain to the question outlined above. A central aim of this work is to realise another full-scale speculative construct through which to develop cross-disciplinary approaches that integrate common and discipline-specific concerns operating through design, environmental sensitivity, fabrication and active performance.

Fig. 3: Prior work from Stoy's group in modular robotics provides a relevant domain of knowledge for collaboration; however, there is shift in concern from classic robot morphologies (such as the one pictured) to the role material performance can play in sensing, control and actuation. (Credit: University of Southern Denmark, E. H. Oestergaard et al.)



LOCATING A CROSS-DISCIPLINARY COMMON GROUND

Despite the early to mid-twentieth century cultural and literary origins of the terms robot and robotics, the discipline of robotics established its foundations in mathematics and control. However, increasingly there is an understanding that morphology, shape and materials can be exploited to aid in the control of motion. The shift towards this understanding was instigated by Brooks, who noted that robotic control based on complex, mathematical models often led to slow robots unable to function in dynamic and unknown environments.⁴ His approach was to abandon internal models in favour of direct sensor-motor couplings tailored to handle specific tasks arising in the environment. His idea was to make a control system with many of these task-achieving sensor-motor couplings operating in parallel. This insight eventually led to the successful behaviour-based control paradigm.⁵

However, this new control paradigm was probably less important compared to the new insight that behaviour emerges as the interaction between environment, morphology, and control. Suddenly, the environment and the morphology became important design parameters and hence important to robotics researchers. There has since been a movement in robotics from computational control towards morphological control. Morphological control is the idea that form and materials can do computation based on their inherent physical properties; a view that was most powerfully communicated by Pfeifer, who describes this as morphological computation.⁶ This new view of robotics has extended what robotics researchers consider a robot to be and now encompasses a much broader range of physical systems. Today, a robot does not even have to have sensors, actuators or a controller – at least not in the manner that these terms would have been previously ascribed and understood in classic robotics. For instance, this is evident in the research on passive dynamic walkers where walking is achieved through mechanically mediated conversion of potential energy to kinetic energy.⁷

It is clear that architects who are cultivating an interest in dynamic and adaptive architecture can benefit from the knowledge, technology and paradigms for controlling motion developed in the field of robotics. The collaboration between CITA and Kasper Stoy benefits from Stoy's expertise in modular robotics (fig. 3).⁸ The notion of modularity provides a territory of conceptual and technological transaction because the architectural structures under development have modular attributes. But a deeper synergy of concerns can be identified from the shift towards materiality and material performance

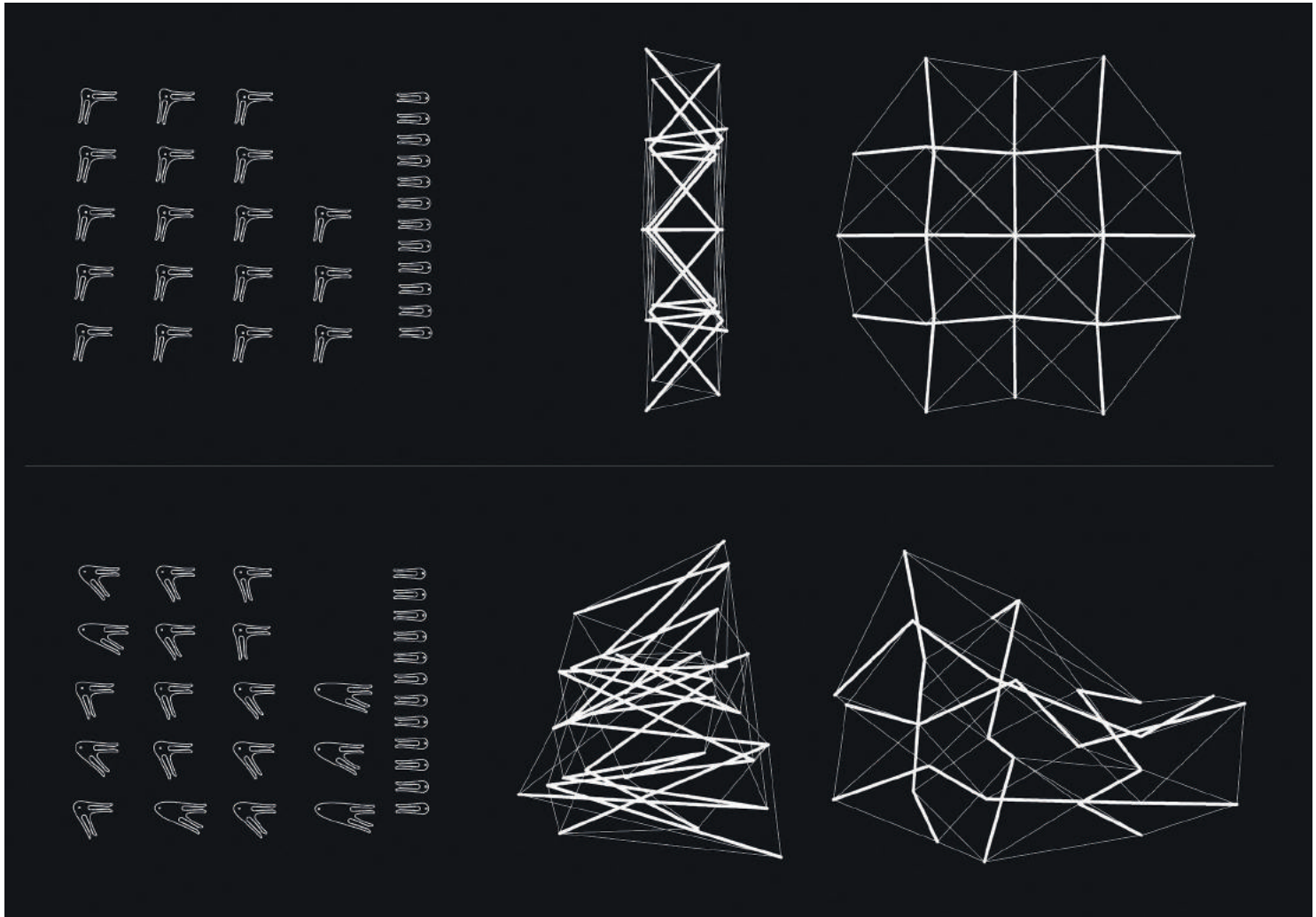

Fig. 4: A double-layer tensegrity topology is encoded in a digital design space permitting the investigation of geometric manipulations and dependencies upon fabrication, in this instance for the production of scale models.

within the robotics discipline. This focus provides the most promising potential of bridging language and understanding barriers identified during the fledgling collaboration. At a general level, this is because architects are deemed to possess an understanding of materials, their performance and how they relate to an overall structure; while at a specific level, this is because these concerns tap directly into CITA's sustained research focus that critically investigates the roles digital tools can play in extending the ways in which we think, design, realise and experience architecture together with a fundamental focus on materials, material practices, material processing and material performance.⁹

THE POINT OF DEPARTURE: PERSISTENT MODEL #2 — DYNAMIC PRESSURE SYSTEMS

The collaborative research effort takes a direct point of departure from the recently completed CITA research project Persistent Model #2. One outcome of this project is a full-scale speculative prototype that establishes the viability of producing irregular double-layer tensegrities comprising inflated metal compression members.¹⁰ The construct adopts the topology of Kenneth Snelson's Planar Weave tensegrity from 1960 (fig. 4).¹¹ The particular characteristics of Planar Weave are reconsidered with an architectural sensibility that searches for synergies between structural logic, component demands

and material dynamics, as well as addressing issues of local specificity, through the fabrication of variety and a tentative, fragmentary suggestion of skin (figs. 5, 6).

The construct employs two classes of inflatable component: one 'hard', irreversible, pre-inflated and structurally performing (metal); one 'soft', reversible, continually pressurised and structurally redundant (polyamide/polyethylene foil laminate). The use of inflatables as a component of the tensegrity system has an interesting conceptual basis: tensegrity structures and inflatable membranes can be considered analogous, i.e. both can be described as pressure-based systems in which a coherent envelope is tensioned through discontinuous compressive force in order to achieve a state of self-equilibrium.¹² The principles of tensegrity are therefore nested and evident at two distinct scales within the construct.

A significant focus of the project has been the development of a novel tectonic for the connection of the metal cushion compression members (fig. 7). The aim has been to synthesise a means of connection that employs the self-forming mechanisms arising from the process of inflation, and to steer these through a given profile geometry (fig. 8). The developed junction resolves the need for conventional means of mechanical

fixing that are generally predicated upon puncturing material, such as screwing, riveting and bolting. By avoiding such penetrative methods, the integrity of the cushion is preserved and can allow for discrete phases of inflation to be conducted arbitrarily (fig. 9). Introducing this potential to an assembled tensegrity presents interesting conflicting states across scales. At the scale of a component, there is an increase of local performance (increase in cross-sectional area and thereby increased stiffness and resistance to buckling), while at the scale of an assembly, there is a simultaneous compromising of the component's compressive contribution to the tensegrity due to the shortening of its length. In Persistent Model #2, it was decided to pre-inflate the compression members as discrete sets, and to conduct an investigation into how these mechanisms of material and component transform might be employed to drive spatial reconfigurations to future exploration. A principal implication for this dynamic would be the need to have a complementary mechanism for active tensioning. It is here that the role of the inflatable skin can be reconsidered and extended from its current structural and environmental limitations (fig. 10) to an active, integrated and more contributory element of the system.



Figs. 5, 6: Persistent Model #2: Exhibited at the gggGallery, Copenhagen, 2013. (Photo: Anders Ingvarsten.)



Fig. 7: Persistent Model #2: One aspect of the project investigates a novel form of junction for steel structures that employs metal inflation and resolves the need for conventional means of mechanical fixing. (Photo: Anders Ingvarsten.)

Fig. 8: Data of geometry of deformation through inflation informs the articulation of the receiving node components.

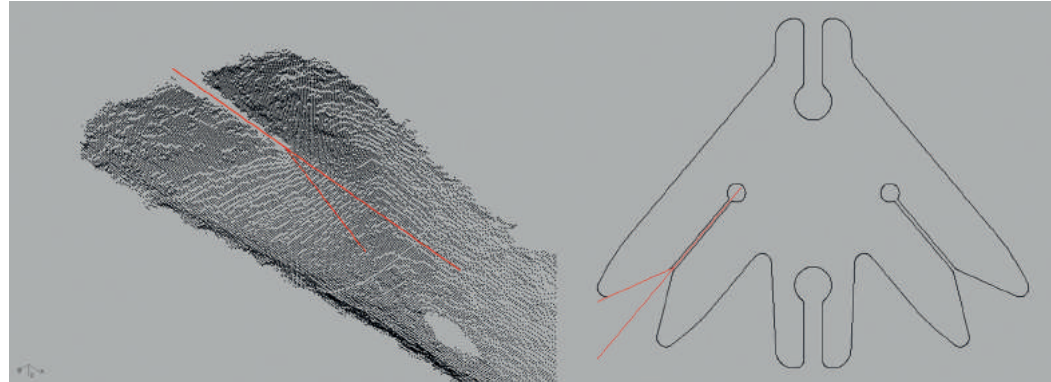

Fig. 9: Avoiding penetrative methods of connection preserves the integrity of the metal cushion, making it possible for discrete phases of inflation to be conducted arbitrarily.



Fig. 10: Current work initially focused on the role of the inflatable skin. This is being reconsidered and extended from its current structural and environmental limitations. (Photo: Anders Ingvarsten.)

CURRENT DEVELOPMENTS: PERSISTENT MODEL #3 — MULTI-SCALAR SHAPE CHANGE

Persistent Model #2 establishes a material, spatial and structural logic with an inherent potential for further development. This development now focuses on active transformation and shape change exhibited at distinct scales. The scales under consideration are defined as: micro, meso, macro. These scales map to the architectural elements: material, component, architectural assemblage. For the project, these elements denote a specific expression of metal sheet and laminate foil; inflatable metal cushions and laminate cushions; double-layer tensegrity.

Central to this investigation is the need to develop a computational infrastructure that supports cross-disciplinary approaches to design, simulation, evaluation and fabrication. The aim extends to developing this infrastructure so that it maintains an operational role beyond what might be conventionally considered the design phase. This means more than providing real-time feedback of fabrication criteria within the design space — something that the system already incorporates. The ambition is to couple the computational infrastructure to the realised artefact in order to permit comparison and assessment between predicted and actual performance, and to re-inform initial design and performance assumptions. This coupling has been described previously as a persistent model.¹³

Immediate work is focusing on extending the role of the skin with the aim of integrating structural and environmental performance. The double-cone geometry employed as the basis for the inflatable skin elements in Persistent Model #2 is being developed as a coherent element that combines two distinct types of double cone; a double-wall version that performs as an active tensioner, and a triple-wall, double-cell arrangement that permits driving the central wall through a pressure differential between the two cells. By considering a portion of this central wall to be opaque, the double cone can perform the role of active shader (fig.11). This mechanism of using a pressure differential to vary transmission can be considered a generic form of actuation and tuned to perform a host of other specific environmental mediation tasks, as evidenced by the fascinating research of Nikolaus Laing from the late 1960s.¹⁴

The conic geometry allows for the two types of double cone to be tessellated into a coherent surface despite their difference in scale. The overall topology is determined by the location of the tensegrity nodes, the points at which compression and tensile elements meet. The tensioning cones tie between nodes and construct isolated zones that are 'filled' with the triple-wall cones (fig.12). Initial modelling studies articulate

an understanding of the skin as a hyper-variegated element that mediates and materially manifests a complex relationship between irregular tensegrity geometry, geographical orientation and shading performance (fig.13). Critically, this digital model establishes a real-time link between speculation and specification. The implications of modifying underlying geometry are immediately played out in the terms under consideration; spatial, environmental, material assignment, material organisation and fabrication data provide an essential ecology of feedback to assess dependencies and inform design intent towards the goal of achieving responsive shape-change across scales. Further ambitions for the modelling environment stretch towards incorporating simulation of material deformation through the various material inflations so that spatial dynamics can be investigated in relation to shape-change potentials, and choreographies of spatial transformations can be developed and evaluated. Work towards this goal has begun with the encoding of material behaviour within spring-based simulation environments. This work already shows promise at the level of independent component studies and aims to determine if more global dynamics can be exhibited from such low-level descriptions.

In his 1968 'state-of-the-art' snapshot of the pneumatic movement entitled *Monumental Windbags*, Reyner Banham articulated a common role and also a qualitative distinction between two kinds of architectural manifestation:

'All architecture has to mediate between an outer and inner environment in some way, but if you can sense a rigid structure actually doing it (dripping sounds, tiles flying off, windows rattling), it usually means a malfunction. An inflatable, on the other hand, in its state of active homeostasis, trimming, adjusting and taking up strains, is malfunctioning if it *doesn't* squirm and creak.'¹⁵

The dynamic attributes of inflatables described by Banham are evident in the synthesised work with tensegrities. This is because, as outlined above, tensegrities and inflatables share a conceptual congruency, but also because these tensegrities directly employ inflatables (metal and foil). As such, a sensitive dependence to the environment expressed through active homeostasis can be understood as being exhibited at, and dependent upon, multiple scales of interaction, i.e. material, component, and structure. Furthermore, in a contemporary context where digital tools supporting ideation, simulation, evaluation and fabrication can be brought to bear directly upon the computation of material assignment and organisa-

tion, it is anticipated that this expression of active homeostasis can become significantly more nuanced and articulated – designed – in order to steer material proclivities towards ever more specific architectural performance.

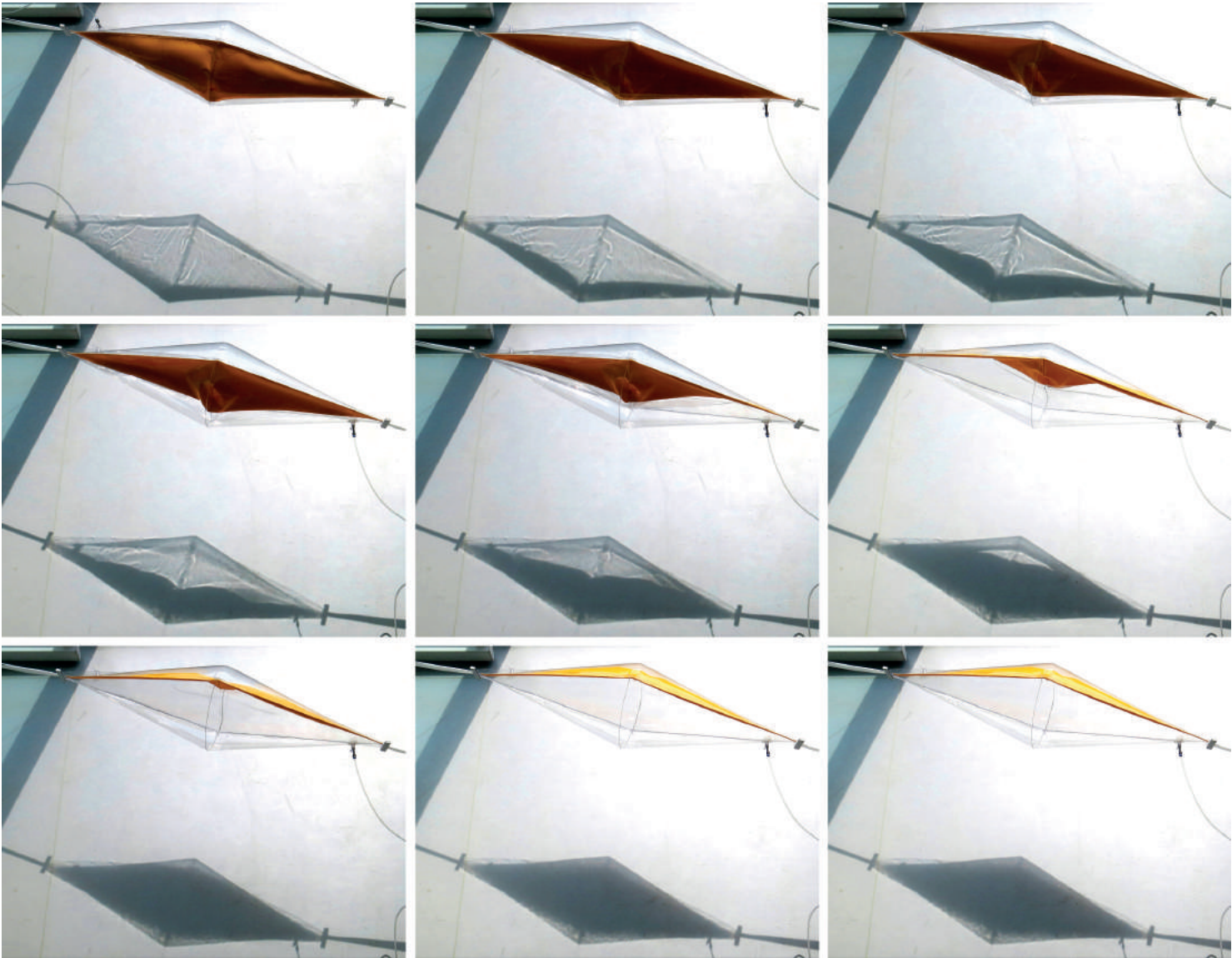

Fig. 11: A preliminary physical test of a triple-wall cushion in which the central wall can be driven by a pressure differential. This generic form of actuation can be tuned to perform a range of environmental mediation tasks – in this case, active shading.

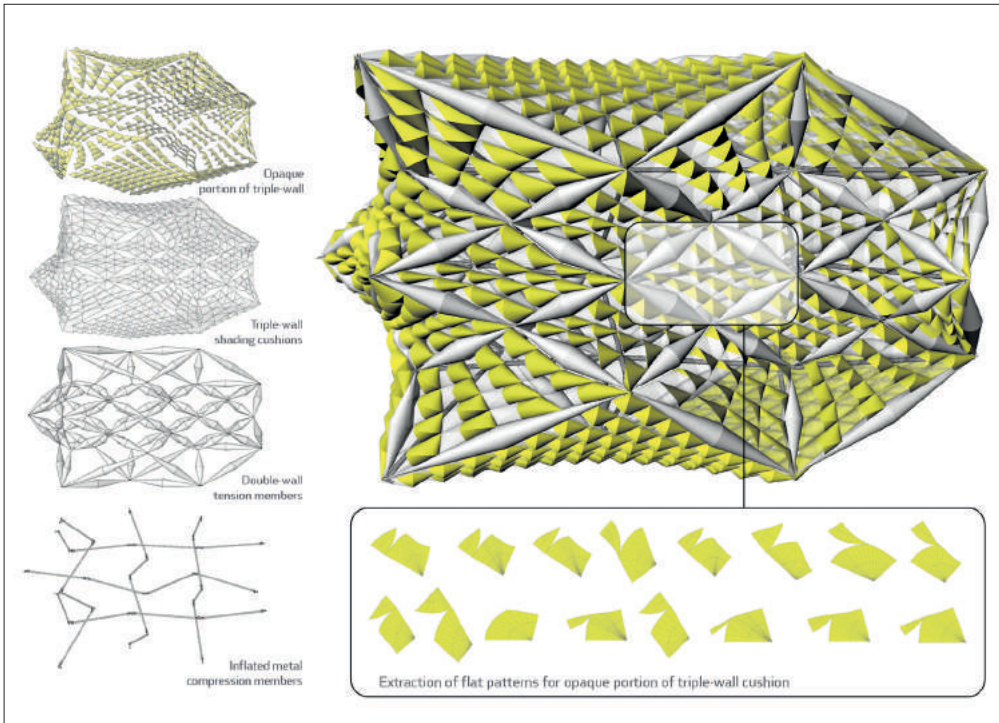

Fig. 12: Study of the proposed system elements and extracted flat-pattern data for the opaque portion of the triple-wall cushions.

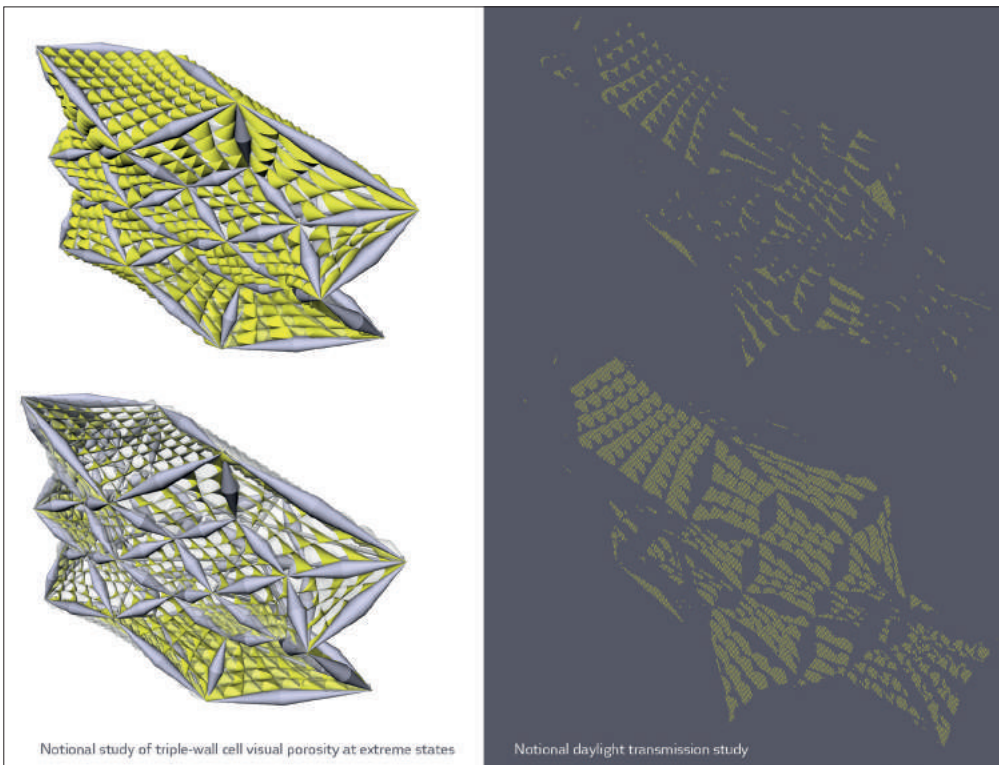

Fig. 13: The computation of material assignment, organisation and fabrication data is performed in relation to orientation and the performance envelope of desired porosity/transmission. A notional study is examined in its two extreme states.

PROJECT DETAILS AND CREDITS

Persistent Model #2 – Dynamic Pressure Systems

The exhibition Persistent Model #2 – Dynamic Pressure Systems opened 1 February 2013 at the ggg Gallery, Sølvgade 5, Copenhagen and ran until 19 July 2013.

DESIGN TEAM: Phil Ayres, Anders Krogdal Nielsen, Roxana Aron, and Kristjana Sigurdardottir

FUNDED BY Dreyers Fond and The Royal Danish Academy of Fine Arts, School of Architecture

INDUSTRIAL SUPPORT from Beyer Teknik Aps; Amcor; FESTO

SPECIAL THANKS GO TO: Ali Tabatabai, Jørgen Hauberg, Vibber Hermansen, KAM at KADK (Mads Bartholin Johnsen, Torben Valerius, Henrik Litske, Lars Tingskov Mikkelsen), Olga Popovich Larsen, Rachel Cruise, Sarat Babu, Chris Paxton

Persistent Model #3 – Multi-scalar Shape Change

DESIGN TEAM: Phil Ayres, Kasper Stoy, David Stasiuk, Hollie Gibbons
CURRENT FUNDING BY The Royal Danish Academy of Fine Arts, School of Architecture

INDUSTRIAL SUPPORT from Beyer Teknik Aps; Amcor; FESTO; Aug. Olsen's Eftf. A/S

NOTES

1 Tristan Sterk, 'Beneficial Change – the case for robotics in architecture', in Phil Ayres, ed. *Persistent Modelling – Extending the Role of Architectural Representation* (London: Routledge, 2012), pp. 155–69. Sterk's work is of particular interest as it also considers issues of robotics, active tensegrity and shape-change at an architectural scale and with a view to gaining environmental performance benefits. The work presented here differentiates itself by operating with the conceptual relation between inflatables and tensegrities for developing a novel tectonic approach, as well as through the explicit consideration of shape-change at multiple scales.

2 See for example: Rodney A. Brooks, 'Robust Layered Control System for a Mobile Robot', in *IEEE Journal of Robotics and Automation*, RA-2 (1986), pp. 14–23; Josh Bongard, Victor Zykov and Hod Lipson, 'Resilient Machines Through Continuous Self-Modeling', in *Science* 314 (2006), pp. 1118–21; Rolf Pfeifer and Christian Scheier, *Understanding Intelligence* (Cambridge, Mass.: MIT Press, 1999).

3 The collaboration is between the Centre for Information Technology and Architecture (CITA) and Kasper Stoy, formerly based at The Modular Robotics and Artificial Intelligence Group, Mærsk Mc-Kinney Møller Institute, University of Southern Denmark and now based at the IT University of Copenhagen.

4 Brooks 1986 (see note 2).

5 Ronald C. Arkin, *Behaviour-Based Robotics* (Cambridge, Mass.: MIT Press, 1998); Maja J. Mataric, 'Behavior-Based Control: Examples

from Navigation, Learning, and Group Behavior', in *Journal of Experimental and Theoretical Artificial Intelligence*, 9/2–3 (1997), pp. 323–36.

6 Pfeifer and Scheier 1999 (see note 2).

7 S. H. Collins et al., 'Efficient Bipedal Robots Based on Passive-Dynamic Walkers', in *Science*, 307 (1986), pp. 1082–5.

8 A. Lyder, R. F. M. Garcia and Kasper Stoy, 'Mechanical Design of ODIN: an Extendable Heterogeneous Deformable Modular Robot', in *Proceedings, IEEE/RSJ Int. Conf. on Intelligent Robots and Systems* (Nice, France, 2008), pp. 883–8; Kasper Stoy, D. J. Christensen and D. Brandt, *Self-Reconfigurable Robots: an Introduction* (Cambridge, Mass.: MIT Press, 2010).

9 Phil Ayres, 'Microstructure, Macrostructure and the Steering of Material Proclivities', in Bob Sheil, ed., *Manufacturing the Bespoke*. (Chichester: Wiley, 2012), pp. 220–37; Paul Nicholas, 'Embedding Designed Deformation: Towards the Computational Design of Graded Material Components', in L. Hallnas, A. Hellström and H. Landin, eds., *Proceedings of Ambience* (Boras: CTF, 2011), pp. 145–51; Ramsgaard Thomsen, Mette and Martin Tamke, 'The Active Model – a calibration of material intent', in Ayres 2012 (see note 1), pp. 141–54.

10 This project also builds upon prior research into free-form metal inflation that resulted in the speculative installation Persistent Model #1; Phil Ayres, 'Free-Form Metal Inflation & the Persistent Model', in Ruairi Glynn and Bob Sheil, eds. *Fabricate: Making Digital Architecture* (Cambridge, Ont.: Riverside Architectural Press, 2011) pp. 70–3; Ayres 2012 (see note 9).

11 Kenneth Snelson, 'The Art of Tensegrity', in *International Journal of Space Structures*, 27/2–3 (2012), pp. 71–80.

12 Richard Buckminster Fuller, *Synergetics: Explorations in the Geometry of Thinking* (London: Collier Macmillan Publishers, 1975); René Motro, *Tensegrity: Structural Systems for the Future* (London: Kogan Page Science, 2003).

13 See Ayres 2011 (see note 10); Ayres 2012 (see note 9).

14 Roger Nicholas Dent, *Principles of Pneumatic Architecture* (London: The Architectural Press, 1971); Thomas Herzog, *Pneumatic Structures* (New York: Oxford University Press, 1976).

15 Reyner Banham, 'Monumental Windbags', in *New Society* (1968), reprinted in Marc Dessauce, *The Inflatable Moment* (New York: Princeton Architectural Press, 1999), pp. 31–3.

Fig.1: Weaving of a tensile surface structure by flying around already constructed members.

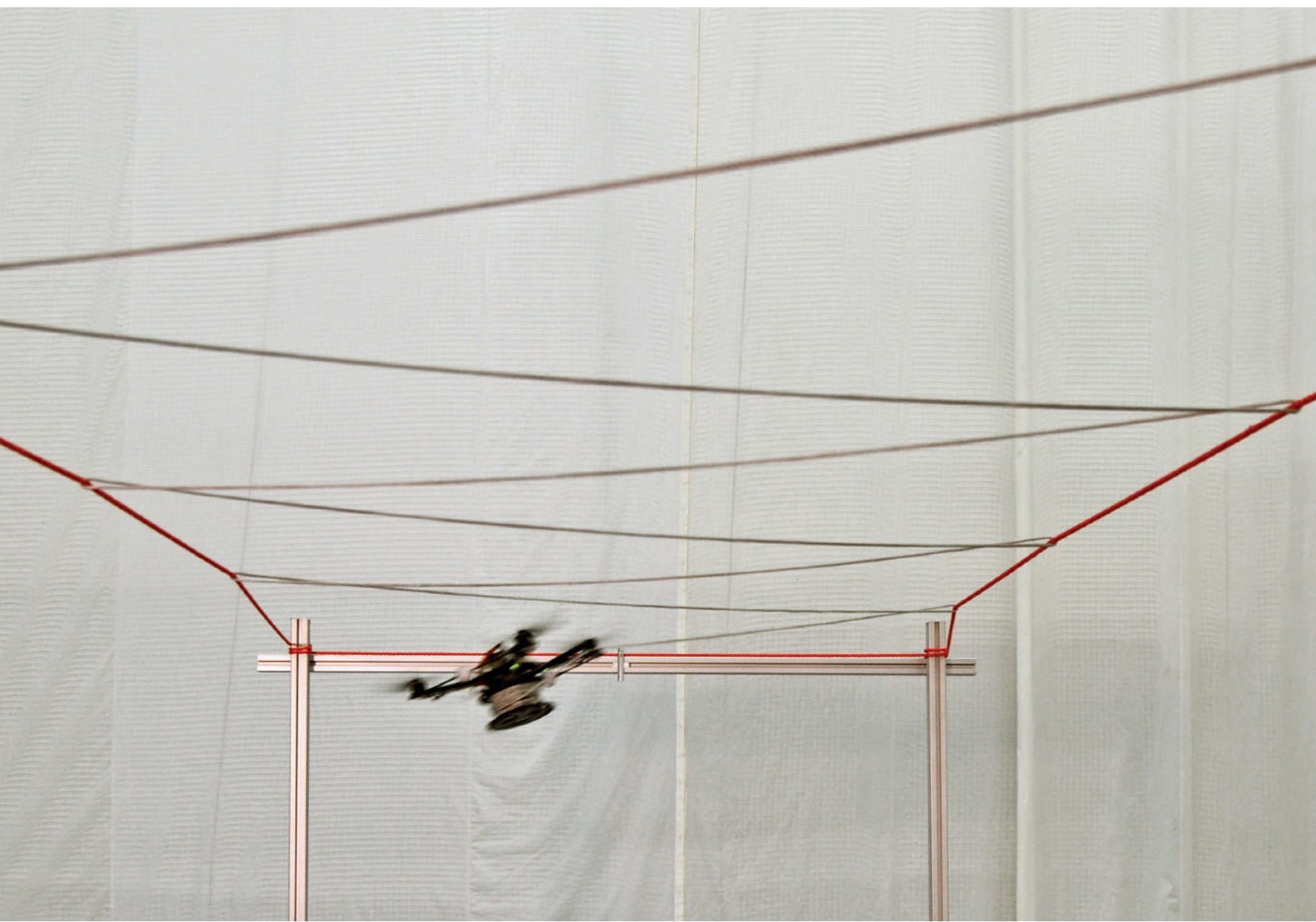

BUILDING WITH FLYING ROBOTS

AMMAR MIRJAN, FABIO GRAMAZIO, MATTHIAS KOHLER

(ARCHITECTURE AND DIGITAL FABRICATION, DEPARTMENT OF ARCHITECTURE, ETH ZURICH)

Aerial robotic construction offers a new approach to architecture. The research presented here investigates the design potential and material relationship between architecture and construction using flying machines. Analogies are drawn to existing methods of digital fabrication. The work identifies scalability, spatial autonomy and cooperativeness as key characteristics of using flying robots in architectural production. Experimental results validate the approach.

INTRODUCTION

Traditionally, machines assisting in the construction of architecture or the fabrication of building components stand on the ground. A crane, for example, requires a solid base to mechanically lift, lower and move material. The arm of an industrial robot or the linear tracks of a CNC machine ensure precision through a mechanical connection of movable parts with the surroundings. Mobile construction devices, such as a truck-mounted crane or locomotive robot,¹ extend the working range, but still need solid fixation to the ground when building. Recent developments in sensing, computation and control, however, allow the creation of autonomous construction machines with profoundly different capabilities to established mechanical fabrication devices. They are not fixed to a base and have the ability to perform construction tasks with free spatial movement in unstructured environments. These machines are flying robots, and they challenge the conditions of how architecture is designed and materialised.

The work presented here is based on a collaboration between the Institute for Dynamic Systems and Control and the Chair for Architecture and Digital Fabrication, both at ETH Zurich. The objective is to investigate and develop methods and techniques for construction with flying machines. In this

paper, the three major points of interest are: What distinguishes aerial robotic construction from conventional modes of machined architectural production? What is the material relationship of the flying machine to the physical artefact it builds? And finally: If structures can be assembled unleashed from mechanical connections to solid ground, what are the design potentials for architecture?

Architecture created by flying machines has always been an interest among researchers (fig. 2). Visionary concepts of flying cities have been around for centuries, presenting ideas of a new way of thinking about architecture,² as well as technology-based utopias,³ and predicting that advances in science and technology will enable new forms of architecture. In architectural production, manually controlled helicopters, used merely for aerial transportation to remote locations, have been a reality on the construction site since the 1950s.⁴

Autonomous unmanned aerial vehicles (UAVs) and their interaction with the environment are nowadays a research topic in many robotic groups.⁵ Research in aerial construction with flying robots, however, is a recent topic still in its fledgling stages. The first step into construction with quadcopters was building a cubic structure by assembling linear bars with magnetic joints.⁶ The Flight Assembled Architecture in-

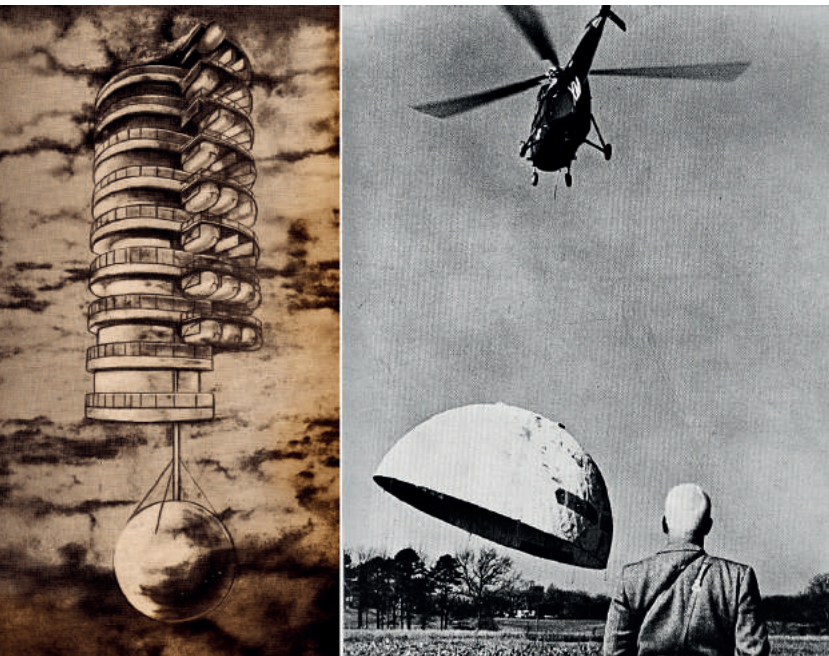

Fig. 2: a) Georgii Krutikov, *The City of the Future*, 1928. b) Buckminster Fuller, *Helicopter lifting a dome in Raleigh, NC, USA*, 1954.

stallation⁷ demonstrated the ability of quadrocopters to autonomously erect a highly differentiated six-metre tower made out of 1500 foam elements. The ARCAS project⁸ focuses on aerial assembly by autonomous helicopters equipped with robotic arms.

Today, quadrocopters offer an excellent compromise between payload capabilities, agility and robustness.⁹

CONSTRUCTIVE CONSIDERATIONS

Aerial robots enlarge the design space for digital fabrication in architecture and offer new construction techniques that would not be possible with standing machines. Research in construction with flying machines requires the development of adequate methods for hover-capable UAVs to physically interact with the environment and, at the same time, the investigation of material systems and new constructive processes that are both robotically transportable and configurable at heights.¹⁰

Aerial robots, similar to the industrial robot, are generic and can be equipped with different tools to transport and manipulate material in different ways, but the key subject here is weight. The payload capacities of flying machines are limited and their manoeuvrability is greatly influenced by the load. This requires that both the tool or gripper attached to the machine and the building material are lightweight and that the construction system makes use of the material in an efficient way. The volume of a single building element must therefore

Fig. 3: a) Lightweight jamming gripper for the assembly of space frame structures. b) Cable dispenser tool for the erection of tensile structures.

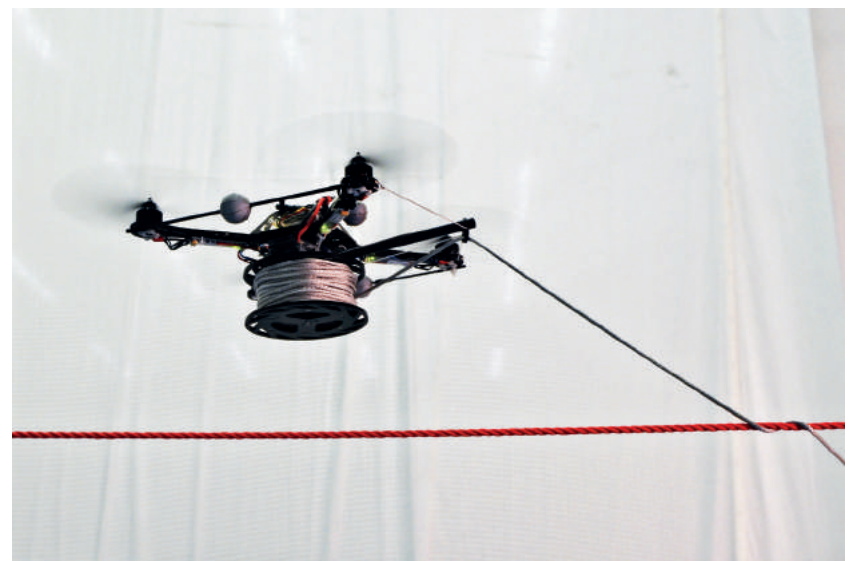

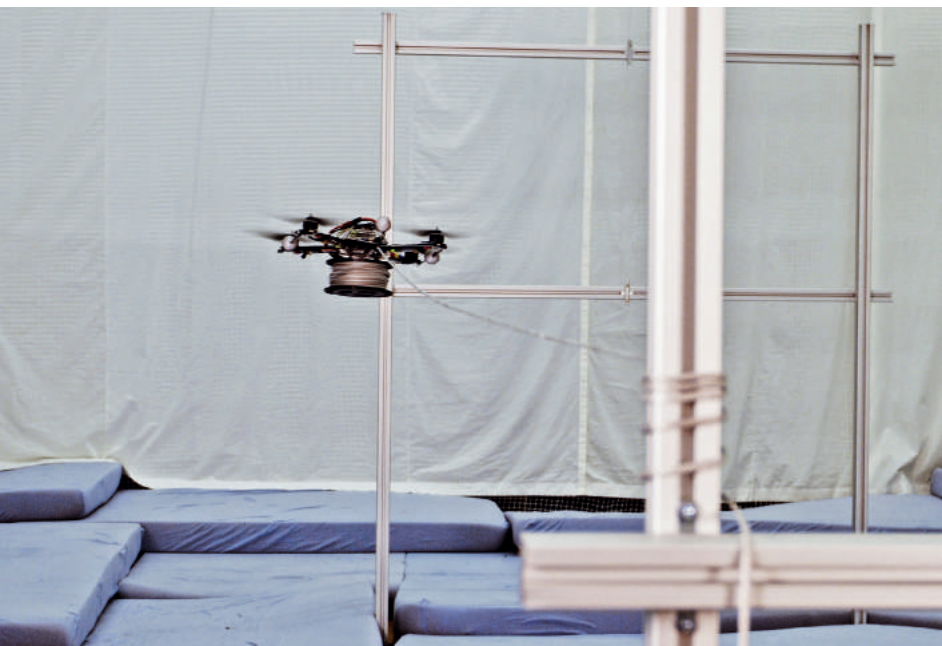

Fig. 4: Autonomous erection of a linear suspension structure.

be low in comparison to the overall volume of the erected artefact.

This relationship between weight and strength influences the design of aerial architecture and motivates research on lightweight construction systems, such as tensile structures¹¹ and space frame structures.¹² Figure 3a shows a prototype of an ultra-lightweight jamming gripper¹³ developed for the spatial assembly of three-dimensional structures with discrete elements. The gripper uses negative pressure to compress granular filling material (Styrofoam™ balls) contained in a membrane (balloon) to rigidly grasp a round carbon tube at variable angles.

The gripper tool addresses the issue of the rotation limitation of the quadcopter in a quasi-static position. The machines cannot hover at any given orientation in space. Changing the rotation angles (pitch and roll) of the vehicle results in acceleration. The concept of the system is that the building element is oriented to the required angle according to the digital model at a pick-up station on the ground where the UAV docks. The vacuum for gripping is created in stationary position and sealed by a pneumatic valve on the vehicle. Once the bar is lifted and moved to its desired position, the clamping can be released by opening the valve.

Since the energy to hold and release the building element is generated at the ground station and the transport medium is air pressure, the gripper weighs only a few grams. Figure 3b shows a tool for the erection of tensile structures. The vehicle is equipped with a cable dispenser, a roller built from lightweight sandwich panels. The friction of the roller is variable in order to adjust for different tensions. The tensile structures shown here are built with ultra-high-molecular-weight polyethylene rope (Dyneema). The material stands out due to its low weight-to-strength ratio, making it suitable for load-bearing structures and aerial manipulation.

The experiments shown here were performed in the Flying Machine Arena,¹⁴ a 10 × 10 × 10 metre indoor space for aerial robotic research at ETH Zurich. The space is equipped with a motion capture system that provides vehicle position and altitude measurements. This information is sent to a computer, which runs algorithms and control strategies and sends commands to the aerial robots. The vehicles of choice are quadcopters. These flying robots have demonstrated their dynamic capabilities performing flips,¹⁵ balancing poles¹⁶ and juggling balls.¹⁷

DESIGN POTENTIAL

A series of prototype structures have been built to investigate different building techniques for aerial robotic construction. The research proposes the following three key capabilities of flying robots in architectural production.

SCALABILITY

The operating range of a flying robot is not limited by the size of the machine. There is no mechanical connection to a base. Conventional robotic arms and CNC machines, by contrast, have constrained working areas, thus limiting their use in architecture to small artefacts or building components. The working range of flying robots, however, allows them to reach points in space otherwise inaccessible by computer-controlled construction machines, thus making them capable of operating at the full scale of architecture.

Figure 4 shows the construction of a linear suspension structure by spanning a horizontal link between two support points in the air independently of the conditions on the ground. The material characteristics of the tensile element are used as a connective method by winding around existing structural members. Using the capstan equation, the loading force can be calculated in order to dimension the strength of the knot. In the experiment, the distance between the support

points is five metres. However, this construction technique is easily scalable, allowing structural links to be established between supports much further apart (assuming the lifting capacities of the machine allow it).

SPATIAL AUTONOMY

The flying machine is physically decoupled from its working space. Flying robots loaded with material move independently of the structure they are building until they physically interact with it at a desired location. This freedom of movement differentiates the aerial robots from all other construction machines. Any device connected to a base would intersect with the existing structure or with itself when pulling the end-effector through a loop.

Figure 1 shows the construction of a surface structure by interlacing two linear structures. The trajectory of the machine resembles the continuous drawing of a figure of eight in space. The sequencing becomes crucial when erecting such a structure. Rather than establishing it layer by layer, the vehicle flies through and around already constructed members while performing the fabrication manoeuvre. This distinctive attribute allows the materialisation of structures that could not be built with other fabrication methods.

COOPERATION

Conventional robots have the capability to cooperate. The ability of the machines to interact enables them to aggregate structures that could not be sequenced and built by an individual robot. In comparison to the flying robots, however, stationary industrial robots, when working cooperatively, block each other's operational range and therefore are primarily used for repetitive tasks in assembly lines. Flying robots are not constrained to such tight boundaries, which makes them suitable for cooperative tasks.

Digital control of the robots enables the vehicles to communicate and synchronise their actions among themselves, for example to collaborate to lift particularly heavy loads.¹⁸ In addition, cooperation can be exploited during the assembly process. In such a case, the vehicles do not merely distribute the workload, but perform building tasks an individual machine could not accomplish alone, independently of the payload capacity.

Figure 5 shows multi-vehicle cooperation of two UAVs in establishing a tensile node at a defined position in the three-dimensional design space. This manoeuvre could not be accomplished by a single vehicle and demonstrates the potential for fabrication with multiple interacting flying robots.

CONCLUSION

Aerial robotic construction is a new research direction. Flying machines have different capabilities from conventional machines and alter the manufacturing conditions of digital fabrication. The first series of explorations documented here have shown some of the particularities of aerial robots in construction. The construction technique is less constrained by traditional assembly parameters, such as the need to build from the ground up. The vehicles move building material independently of the construction they are building. Structures can be erected without scaffolding or cranes. Applied to the construction of a bridge to cross a canyon, or the erection of a structure between two skyscrapers, the machines have the ability to reach any point in the three-dimensional design space, independently of the conditions on the ground.

Rather than understanding the architectural production process as a linear and congruent progression, the research aims to identify it as a spatiotemporal negotiation of man-machine, machine-machine and machine-material interactions. It pursues a shift in architectural design and fabrication where sensory data and digital building instructions orchestrate dynamic manufacturing decisions, opening up new ways of thinking about architectural design and materialisation.

Fig. 5: Multi-vehicle cooperation in freely establishing a knot in space.

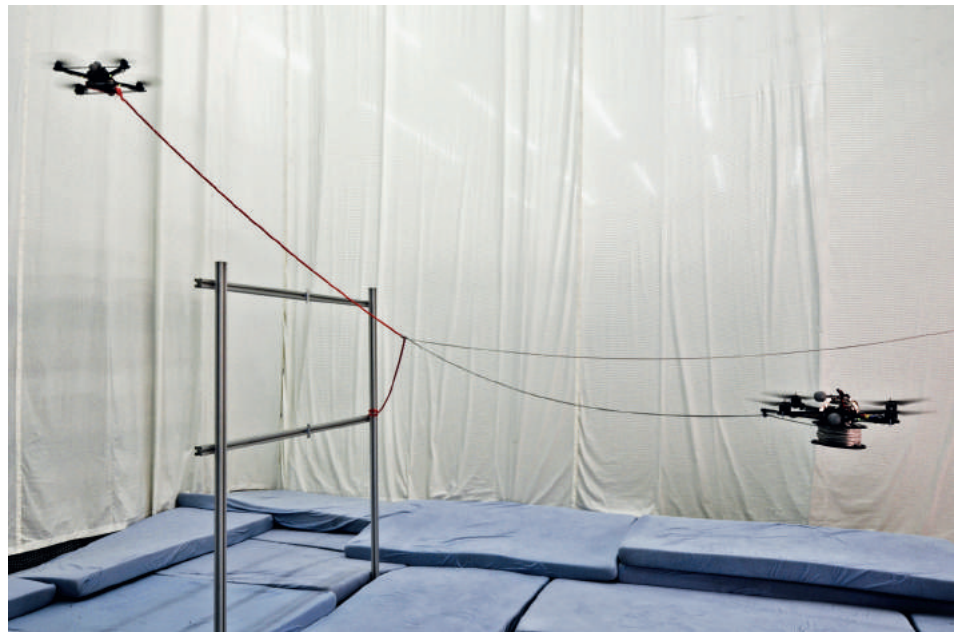

ACKNOWLEDGEMENTS

This ongoing research is based on an interdisciplinary project between the Chair for Architecture and Digital Fabrication (DFAB) and the Institute for Dynamic Systems and Control (IDSC) of Prof. Dr Raffaello D'Andrea at ETH Zurich. Project collaborator at the IDSC is Federico Augugliaro. The work is supported by and builds upon prior contributions by numerous collaborators of the Flying Machine Arena project and the DFAB team. The research is supported by the Hartmann Mueller Fund on ETH Research Grant ETH-30 12-1.

NOTES

- 1 Volker Helm et al., 'Mobile Robotic Fabrication on Construction Sites: DimRob', in *IEEE/RSJ International Conference on Intelligent Robots and Systems (IROS 2012)*, pp. 4335–41.
- 2 Georgii Krutikov, *The City of the Future* project from 1928 (in A.V. Schusev State Museum of Architecture, Moscow).
- 3 Richard Buckminster Fuller, *4D Time Lock* (Albuquerque: Biotechnic, 1928).
- 4 E. S. Carter, R. S. Decker and D. E. Cooper, 'Handling Qualities: Considerations of Large Crane Helicopters', in *Annals of the New York Academy of Sciences*, 107/1 (1963), pp. 5–18.
- 5 Kenzo Nonami et al., *Autonomous Flying Robots – Unmanned Aerial Vehicles and Micro Aerial Vehicles* (Tokyo: Springer, 2010).
- 6 Quentin Lindsey and Vijay Kumar, 'Distributed Construction of Truss Structures', in *Algorithmic Foundations of Robotics X 86* (2013), pp. 209–25.
- 7 Jan Willmann et al., 'Aerial Robotic Construction: Towards a New Field of Architectural Research', in *International Journal of Architectural Computing* 10 (2012), pp. 439–60. Fabio Gramazio, Matthias Kohler and Raffaello D'Andrea, *Flight Assembled Architecture* (Orleans: Editions Hyx, 2013).
- 8 Aerial Robotics Cooperative Assembly System (ARCAS), www.arcas-project.eu, accessed 19 September 2013.
- 9 Robert Mahony, Vijay Kumar and Peter Corke, 'Multirotor Aerial Vehicles: Modeling, Estimation and Control of Quadrotor', in *IEEE Robotics Automation Magazine*, 19/3 (2012), pp. 20–32.
- 10 Matthias Kohler, 'Aerial Architecture', in *LOG*, 25 (2012), pp. 23–30.
- 11 Ammar Mirjan et al., 'Architectural Fabrication of Tensile Structures with Flying Machines', in Helena Bártolo et al., eds., *Green Design, Materials and Manufacturing Processes* (London: CRC Press, 2013), pp. 513–18. Federico Augugliaro et al., 'Building Tensile Structures with Flying Machines', in *IEEE/RSJ International Conference on Intelligent Robots and Systems (IROS 2013)*, accepted for publication.
- 12 John Chilton, *Space Grid Structures* (Oxford: Architectural Press, 2000).
- 13 John Amend et al., 'A Positive Pressure Universal Gripper Based on the Jamming of Granular Material', in *IEEE Transactions on Robotics*, 28/2 (2012), pp. 341–50.
- 14 Flying Machine Arena, www.flyingmachinearena.org, accessed 19 September 2013.
- 15 Sergei Lupashin and Raffaello D'Andrea, 'Adaptive Fast Open-Loop Maneuvers for Quadcopters', *Autonomous Robots*, 33 (2012), pp. 89–102.
- 16 Markus Hehn and Raffaello D'Andrea, 'A Flying Inverted Pendulum', in *IEEE International Conference on Robotics and Automation (ICRA 2011)*, (Piscataway, N.J.: IEEE, 2011), pp. 763–70.
- 17 Mark Mueller, Sergei Lupashin and Raffaello D'Andrea, 'Quadcopter Ball Juggling', in *IEEE/RSJ International Conference on Intelligent Robots and Systems (IROS 2011)*, (Piscataway, N.J.: IEEE, 2011) pp. 5113–20.
- 18 Nathan Michael, Jonathan Fink and Vijay Kumar, 'Cooperative Manipulation and Transportation with Aerial Robots', *Autonomous Robots*, 30/1 (2011), pp. 73–86.

Fig. 1: Close-up photo of the HygroSkin – Meteorosensitive Pavilion (low relative humidity, 45%).

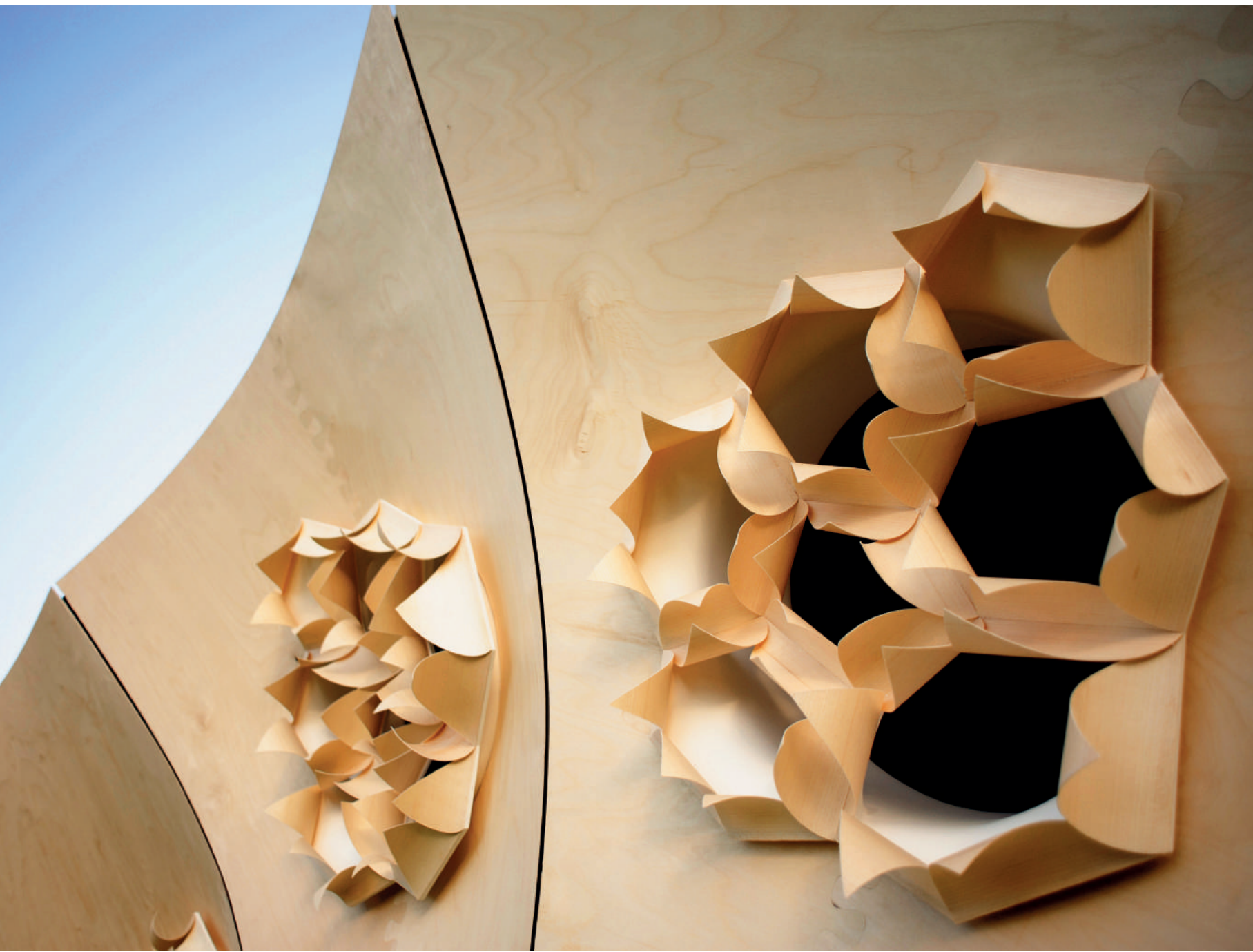

HYGROSKIN: METEOROSENSITIVE PAVILION

OLIVER DAVID KRIEG, ZACHARY CHRISTIAN, DAVID CORREA, ACHIM MENGES, STEFFEN REICHERT,
KATJA RINDERSPACHER, TOBIAS SCHWINN (INSTITUTE FOR COMPUTATIONAL DESIGN, UNIVERSITY OF STUTTGART)

The HygroSkin project explores a novel mode of climate responsive architecture based on the combination and interrelationships of material-inherent behaviour, computational morphogenesis and robotic manufacturing. The dimensional instability of wood in relation to moisture content is employed to develop a meteorosensitive architectural skin that opens and closes in response to climate changes with no need for any technical equipment or a supply of external energy. Embedded within robotically fabricated, lightweight structural components made of elastically bent plywood panels, the responsive wood-composite apertures adjust the envelope's porosity in direct feedback to changes in ambient relative humidity. The HygroSkin Pavilion was commissioned by the Fonds Régional d'Art Contemporain du Centre and now forms part of the permanent collection of the FRAC Centre in Orleans.

INTRODUCTION

Wood is a naturally grown organic tissue that has evolved as a highly effective biological system to meet the support, conduction and storage requirements of trees.¹ The multifunctional ability results in a differentiated cell anatomy that is critical for the different performance capacities of the material, including its anisotropic structural and hygroscopic characteristics.² Consequently, due to its natural anisotropic makeup, wood cannot meet the specific performance criteria of industrially produced construction materials.³ To access the material's capacity in a meaningful way, an integrative design approach that takes advantage of new computational design and fabrication tools needs to be employed.⁴

Computational design provides suitable methods for an integrative design process. A computational model can be informed by specific material and fabrication constraints, but it is also capable of abstracting geometric data into codified production instructions. Thus, it can perform as a generative information model that integrates both the internal anatomic structure of the material and the robotic control for the fabrication of large numbers of differentiated elements.⁵ The informed design capabilities and automated programming strategies allow unprecedented access to the material's capacity



Fig. 2: Photo of the HygroSkin – Meteorosensitive Pavilion in Stadtgarten, Stuttgart (high relative humidity, 75%).

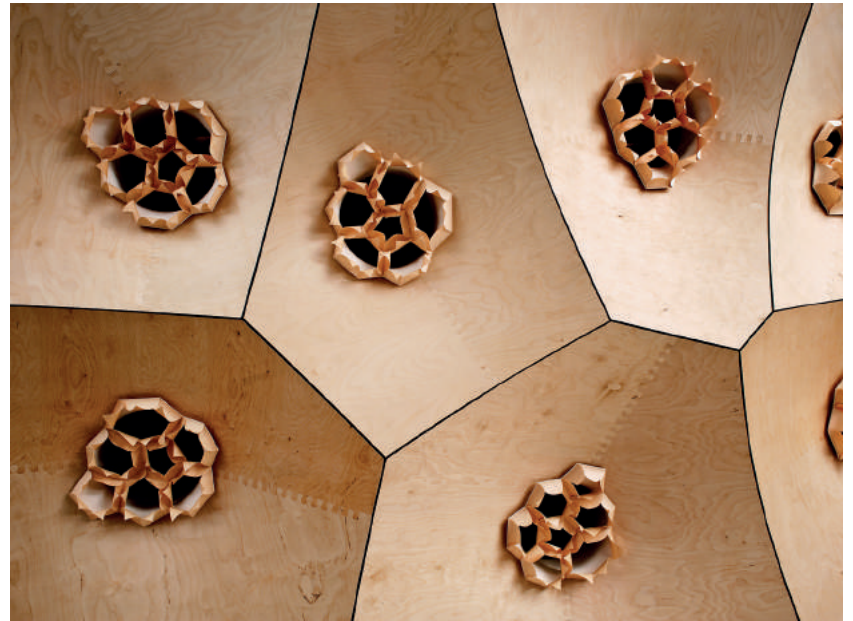

Fig. 3: Photos of the hygroscopic apertures in different states. a) High relative humidity, 75%. b) Low relative humidity, 45%.

and its range of performance. It is the aim of this research to test and evaluate these methods at full scale through the development of a climate-responsive enclosure of lightweight, geometrically differentiated components that use the wood's active bending behaviour and hygroscopic actuation of the material (fig. 3).

MATERIAL-ORIENTED COMPUTATIONAL DESIGN PROCESS

The project is based on many years of in-depth design research into component-based construction and elastic self-forming structures.⁶ Based on the elastic behaviour of thin planar plywood sheets and the material's related capacity to form conical surfaces, a computational design process was developed with the premise of integrating material and structural behaviour, robotic fabrication, and assembly logic into one coherent design approach. Initial constraints for the prototype were defined by the Fonds Régional d'Art Contemporain du Centre, which commissioned the HygroSkin Pavilion project, and the related necessity for assembly, disassembly, and transportation, suggesting a modular configuration of prefabricated elements.

Bending planar plywood sheets results in developable surfaces of which the cone is a special kind of ruled surface with straight sections that can be generated by connecting the op-

posing non-parallel edges of a flat sheet. While the conical shape increases structural stability compared to a flat sheet, the surface geometry will deviate from the ideal conical shape due to internal stresses. This bending behaviour depends on the type and quality of the connection between its edges, as well as asymmetrical cut-outs of the initially flat element and therefore suggests the use of an additional forming process.

A significant constraint for the design and fabrication of the prototype was the geometric nature of the resultant intersection curves between adjacent cones. While a circular cone is a symmetrical object, the resulting surfaces of an intersection of uniform, identical cones exhibit largely differentiated geometries (figs. 4, 5).⁷

On one hand, this opens up the possibility of generating highly differentiated conic geometries for each module while using a singular basic cone shape. On the other hand, the intersection of conical surfaces generally results in 3-dimensional curves. In order to meet the requirements for efficient fabrication and assembly, intersections had to be limited to planar curves. This can be achieved either through the free arrangement of cones with parallel axes and identical cone angles on a plane or through arrangement on a sphere with cone axes pointing to the centre of the sphere.⁸

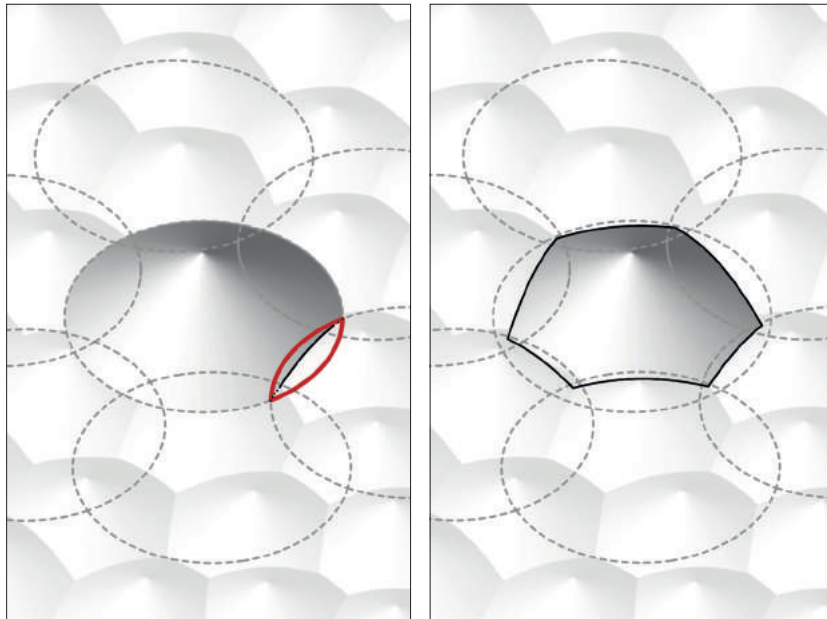

Fig. 4: Intersecting conical geometries. Intersection curves between the units and resulting module geometries after Boolean operations.



Fig. 5: Intersecting conical geometries. Interior view of the HygroSkin Pavilion.

FABRICATION INTELLIGENCE

The computational process integrates the material's capacity in order to physically compute the desired form in the elastic bending process, the cumulative structure of the resulting building components, the computational detailing of all joints and the generation of the required machine code for the fabrication with a seven-axis industrial robot. The conical shapes are fabricated through interlocking CNC milled puzzle joints along the edges of 4-mm plywood sheets. These are then used as the outer skin of each module, which becomes a sandwich construction by enclosing a layer of 100-mm polystyrene between two of the conical plywood layers (fig. 6). This configuration increases the structural stability of the modules, which range from 500 to 2500 mm in size, while minimising their weight. Subsequently, a custom vacuum moulding process ensures consistency of the conical geometry, while a subsequent robotic trimming process ensures dimensional accuracy along the edges of each module.

The robotic fabrication process is based on an interactive simulation of the robot's kinematics⁹ and automated machine code generation.¹⁰ In order to minimise fabrication tolerances, the module geometry is first surveyed with the robotic arm by measuring the position of reference points in relation to the base coordinate system defined by the vertical positioner

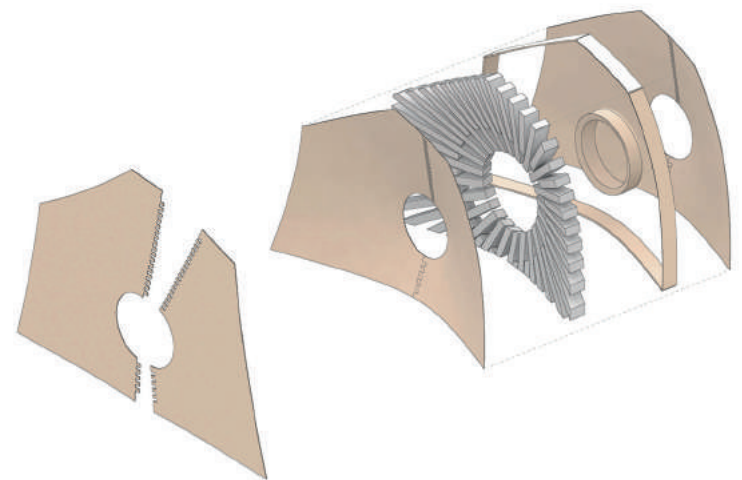

Fig. 6: Exploded axonometric view of the module layers.

Fig. 7: Measuring the module's position before robotic cutting and milling.



(fig. 7). Using the survey points, the digital geometry model is aligned with the physical model by an algorithm which minimises their difference in position and orientation. The integration of parametrically generated toolpaths for trimming the module's edges with a circular saw and milling the foam core (fig. 8) and the interactive simulation of the seven-axis robot's kinematics allows simultaneous generation of the corresponding robot control code from within the parametric modelling environment (fig. 9).

In order to be able to evaluate the fabrication precision prior to assembly, three-dimensional laser scanning was used for scanning a subset of the prefabricated modules, which were compared to their corresponding digital models. The analysis of a 3D-laser scan of a test module located in the bottom row showed that a random selection of 25,000 scan points of the more than one million available data points (fig. 10a) had an average deviation from the digital target geometry of less than 0.6 mm (fig. 10b). The 3D-scan analysis therefore showed that the digital fabrication steps of (i) prefabricating the formwork, (ii) CNC-cutting the initially flat plywood layers, (iii) vacuum-forming the modules, and (iv) robotic milling and trimming were highly accurate, with a cumulative tolerance of below 1.0 mm on the level of the individual building elements.

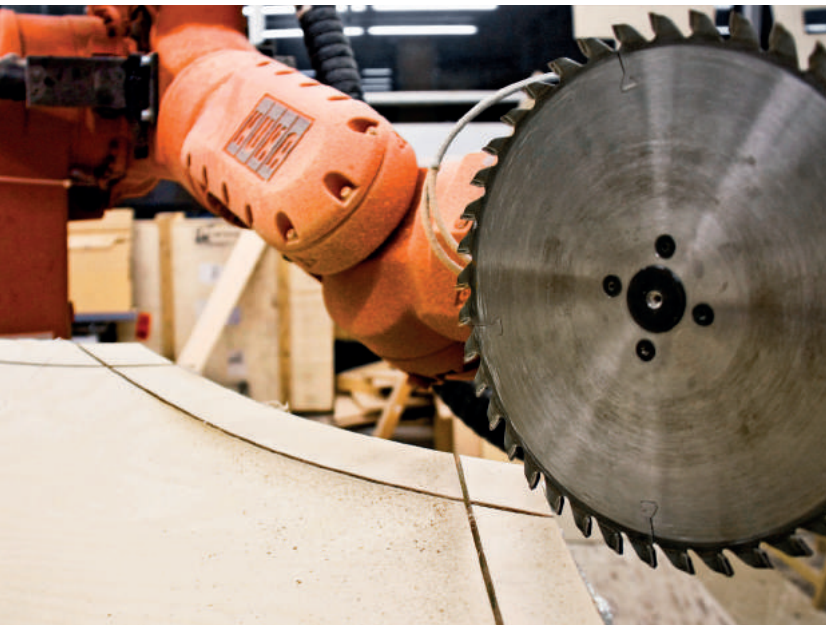

Fig. 8: Trimming the module's edges with a circular saw.

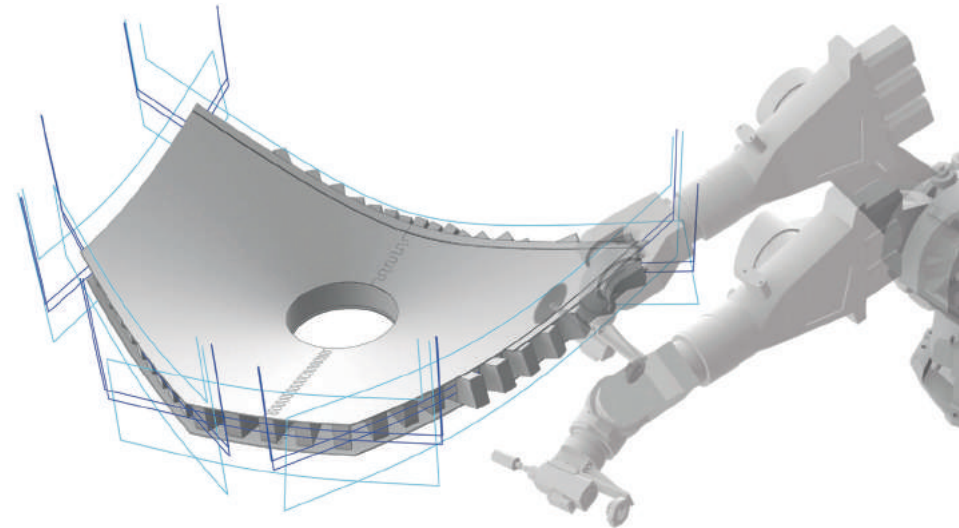

Fig. 9: Automated robot control code generation and simultaneous kinematics simulation.

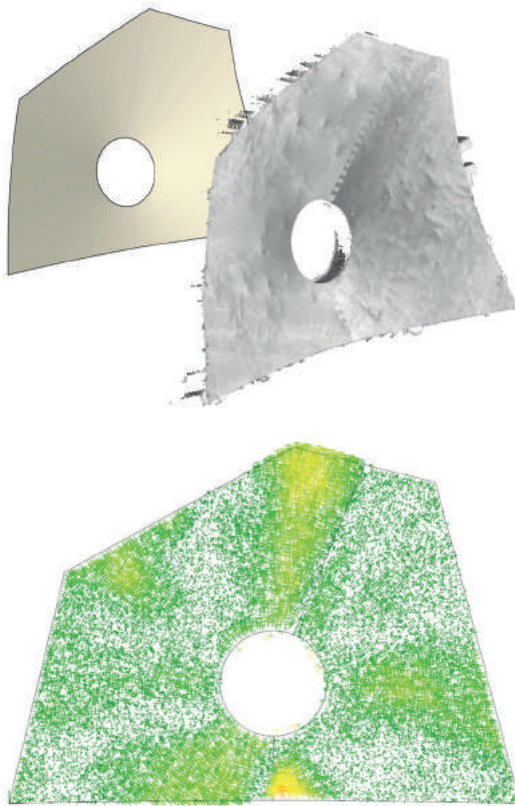

Fig. 10: Precision evaluation through 3D scanning.
 a) Comparison between the computational target geometry and the elastically self-formed wood panel.
 b) The evaluation shows a median deviation of less than 0.6 mm (units in mm).

STRUCTURAL INTELLIGENCE

The geometric design of the structure was based roughly on a plate shell concept as described by Anne Bagger.¹¹ Through controlled arrangement of the modules, no connection lines appear along the same axis, thereby eliminating inherent points of structural weakness and thus greatly stiffening the overall structure. Given the modules' curved geometry and arrangement along the vertical axis, pure plate shell theory does not apply on a local level, and thus bending moments caused by loading eccentricities on each module must also be considered. However, a finite element analysis (FEA) confirmed that only small bending loads are present, while the majority of loads are taken axially (fig. 11).

Given the sandwich configuration of the modules, the connection of the Styrofoam™ strips with adhesive causes the cross-section to work as a semi-rigid, 3D-stressed skin panel member during bending and additionally stiffens the section against axial buckling loads. The connections between elements were designed as semirigid-moment connections in order to withstand lateral and vertical bending forces in addition to the shear and axial forces typical in plate shell structures.¹² The global structural analysis indicates that the overall system provides better performance advantages – given the

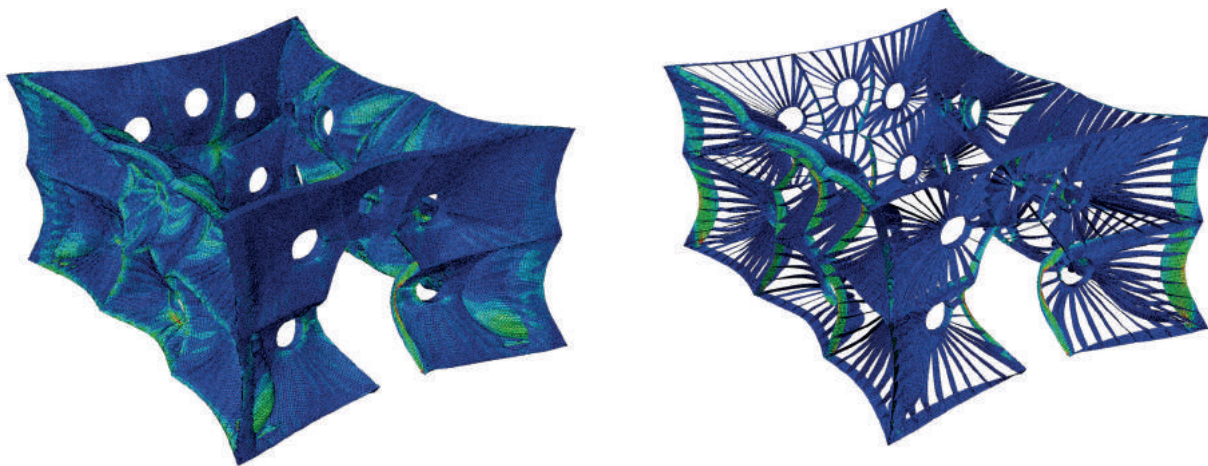

Fig. 11: Finite element analysis of the HygroSkin Pavilion.
 a) Von Mises stress results of the overall structure.
 b) Von Mises stress results of the structural frame.

plate shell concept – when it is used in non-purely vertical or horizontal applications, due to the increasing stability and strength requirements of such geometries. As a result of the material choice and geometric strategy, it is demonstrated that the highly differentiated modular structure is inherently strong, stable and lightweight.

MATERIAL INTELLIGENCE

The HygroSkin Pavilion is an extension of previous research on the integration of methods and techniques for responsive hygroscopic actuation¹³ into a functional and highly adaptable architectural system. Autonomous responsive apertures are embedded into the larger, robotically fabricated multi-component system of the pavilion, constantly responding to the changes in relative humidity of the environment. These subtle climatic changes trigger the silent, material-innate movement of the skin; constantly modulating the relationship between the pavilion's exterior and interior, leading to a unique convergence of spatial and environmental experiences. These apertures are complete geometric elements; the polyurethane lattice incorporates the wooden elements that operate as hygroscopic actuation devices, and each element also contributes geometric value by replacing the higher curvature of the cones within their centre area.

Climate-responsiveness in nature is mostly naturally embedded in the material's behaviour, while in architecture it is generally achieved through separate technical sensing, actuating and regulating devices. The HygroSkin Pavilion utilises the natural principle of embedding responsiveness into the material structure and therefore does not require any kind of control mechanism, technical equipment or external energy supply system. In direct feedback to the local microclimate, the responsive wooden components of the apertures adjust the degree of openness and porosity of the pavilion, steadily adjusting the meteorosensitive architectural skin in subtle movements. The hygroscopic wooden components are calibrated to react to local changes in relative humidity in a range from 45% to 75%, which corresponds to the typical moderate climatic conditions in central Europe. The hygroscopic actuation of the overall architectural skin provides a unique experience by constantly modulating the spatial relationship between exterior and interior in feedback with the dynamics of the environment (fig. 12).

CONCLUSION

The potential that an integrative design approach and production process offers to construction and architectural design becomes apparent in the research prototype presented in this paper. For the HygroSkin Pavilion, the differentiated material properties and performance of wood were integrated into a computational design and fabrication process. The development of a parametric production process ensured precision and dimensional accuracy in the development of the material, geometric and structural data, the elastic bending process, the computational detailing of all joints and connections and the milling and trimming of each building component with a seven-axis industrial robot. This interrelationship of material computation, digital development, computational design and robotic fabrication resulted in a highly precise, lightweight, geometrically complex morphology with a climate responsive architectural skin.

Fig. 12: Photo of the HygroSkin – Meteorosensitive Pavilion in Stadtgarten, Stuttgart. Low relative humidity, 45%, with open HygroSkin surface.



ACKNOWLEDGEMENTS

The authors would like to express their gratitude to the entire scientific development and robotic fabrication team of the HygroSkin project. This includes Andreas Kulla and Edeltraud Walla of the Faculty Wood Workshop, and all the participating students of the University of Stuttgart. The authors would also like to thank the additional members of the design team, including Nicola Burggraf and Boyan Mihaylov.

Funding for this project was provided by the Fonds Régional d'Art Contemporain du Centre, as well as DVA Stiftung, Cirp GmbH, Alfred Kiess GmbH and Holzhandlung Wider GmbH. The HygroSkin Pavilion forms part of the permanent collection of the FRAC Centre in Orleans.

PROJECT TEAM

Achim Menges, Architect, Frankfurt
Prof. Achim Menges, Steffen Reichert, Boyan Mihaylov
(Project Development, Design Development)

INSTITUTE FOR COMPUTATIONAL DESIGN, University of Stuttgart
Prof. Achim Menges, Oliver David Krieg, Steffen Reichert, David Correa, Katja Rinderspacher, Nicola Burggraf, Zachary Christian, Tobias Schwinn with Yordan Domuzov, Tobias Finkh, Gergana Hadzhimladenova, Michael Herrick, Vanessa Meyer, Henning Otte, Ivaylo Perianov, Sara Petrova, Philipp Siedler, Xenia Tiefensee, Sascha Vallon, Leyla Yunis
(Scientific Development, Detail Development, Robotic Fabrication, Assembly)

NOTES

- 1 John M. Dinwoodie, *Timber: Its Nature and Behaviour* (London: E&FN Spon, 2000), p. 2.
- 2 Rudi Wagenführ, *Anatomie des Holzes* (Leinfelden-Echterdingen: DRW Verlag, 1999).
- 3 Achim Menges and Steffen Reichert, 'Material Capacity: Embedded Responsiveness', *Architectural Design*, 82/2 (2012), pp. 52–9.
- 4 Achim Menges, 'Material Resourcefulness: Activating Material Information in Computational Design', *Architectural Design*, 82/2 (2012), pp. 34–43.
- 5 Achim Menges, 'Integrative Design Computation: Integrating Material Behaviour and Robotic Manufacturing Processes in Computational Design for Performative Wood Constructions', in Joshua M. Taron, Vera Parlac, Branko Kolarevic and Jason S. Johnson, eds., *Integration through Computation: Proceedings of the 31st ACADIA Conference, October 11–16, 2011, University of Calgary, Banff, Alberta, Canada* (Capo Beach, Calif.: Association for Computer-Aided Design in Architecture, 2011), pp. 72–81.
- 6 Menges, *ibid.*; Tobias Schwinn, Oliver David Krieg and Achim Menges, 'Robotically Fabricated Wood Plate Morphologies', in Sigrid Brell-Çokcan and Johannes Braumann, eds., *Robotic Fabrication in Architecture, Art and Design: Proceedings of the Robots in Architecture Conference 2012* (Vienna: Springer, 2012), pp. 48–61; Steffen Reichert et al., 'Fibrous Structures: An Integrative Approach to Design Computation, Simulation and Fabrication for Lightweight, Glass and Carbon Fibre Composite Structures in Architecture Based on Biomimetic Design Principles', in *CAD – Steering of Form*, 2013 (forthcoming).
- 7 David Correa et al., 'HygroSkin: A Prototype Project for the Development of a Constructional and Climate Responsive Architectural System Based on the Elastic and Hygroscopic Properties of Wood', in Philip Beesley, Omar Khan and Michael Stacey, eds., *Adaptive Architecture: Proceedings of the 33rd Annual Conference of the Association for Computer Aided Design in Architecture, October 24–27, 2013, Cambridge, Ontario, Canada* (forthcoming).
- 8 Nicholas Williams et al., 'HubPod: A Prototypical Design System for Acoustically Diffused Enclosures', in Michael Stacey, ed., *Prototyping Architecture: The Conference Papers* (London: Building Centre Trust, 2013), pp. 391–404.
- 9 Johannes Braumann and Sigrid Brell-Cokcan, 'Real-Time Robot Simulation and Control for Architectural Design', in Henri Achten et al., eds., *Digital Physicality – Proceedings of the 30th eCAADe Conference* (Prague, 2012).
- 10 Martin Bechthold, 'The Return of the Future: A Second Go at Robotic Construction', in *Architectural Design*, 80/4 (2010), pp. 116–21.
- 11 Anne Bagger, *Plate Shell Structures of Glass: Studies Leading to Guidelines for Structural Design*, PhD diss., Department of Civil Engineering, Technical University of Denmark (2010), p. 1.
- 12 *Ibid.*, pp. 4–5.
- 13 Steffen Reichert et al., 'Fibrous Structures: An Integrative Approach to Design Computation, Simulation and Fabrication for Lightweight, Glass and Carbon Fibre Composite Structures in Architecture Based on Biomimetic Design Principles', in *CAD – Steering of Form*, 2013 (forthcoming); Steffen Reichert and Achim Menges, 'Responsive Surface Structures', in Antonia B. Kesel and Doris Zehren, eds., *Bionik: Patente aus der Natur* (Bremen: Bionik-Innovations-Centrum (B-I-C) Bremen, 2010), pp. 28–35.

Fig. 1: Prototype for a tetrahedral adaptive truss: fully retracted.



FABRICATING BEHAVIOUR: A PROBLEM, A SOLUTION, A PROTOTYPE AND A PROPOSAL

WILLIAM BONDIN, RUAIRI GLYNN

This paper highlights the gap that exists between digital simulation and physical prototyping in the performance of dynamic architectural systems. Feedback loops are explored as a solution to mediating between these two domains as well as providing a means to steer material and morphologically embodied behaviour towards desired goals. Building upon this understanding, a prototype for adaptive and kinetic structures is presented called 'Morphs', along with a speculative proposal for their deployment as a mobile reconfigurable architecture. The paper presents the initial stage of a three-year research project towards a fully realised adaptive autonomous mobile architecture for public space.

A PROBLEM

Software simulation of architecture's physical behaviour, as in all scientific modelling, is built upon current best understandings of phenomena discretised and approximated into mathematical models. Error is inherently part of all simulations, although with ever-increasing resolution, computational fidelity is tightening the gap between virtual models and real-world phenomena. Further to the inherent error in digital simulation, material inconsistency, human error, tooling wear, contaminants and any number of other factors in fabrication will influence performance in ways that cannot be fully predicted. Digital manufacturing techniques are sharpening the accuracy of fabrication, again tightening the gap, but it remains regardless.

This gap is particularly evident when dynamic motive forces are at play, and this is elegantly illustrated by the difference between simulated and fabricated 'passive dynamic walkers' (PDWs). PDW research aims to understand the fundamental principles that underlie legged locomotion with applications, particularly in robotics and prosthetics. PDWs are described as a mechanism composed of a pair of legs that perform a walking behaviour that should, at least according to mathematical models, move into a steady gait once placed on an inclined

slope.¹ While in simulation, it is possible to optimise for continuous locomotion down a virtual slope, in practice, however, the fabricated prototypes (figs.2,3) based on these models failed to proceed more than a handful of steps. PDWs are perhaps, at first sight, an unlikely area of research to draw inspiration for architects and designers, but along with illustrating a problem, they offer an elegant and simple solution to bridging the gap between simulated behaviour and physical behaviour. This offers insight into the development of adaptive and kinetic architecture and has inspired the design project presented here at an early stage of prototyping.

A SOLUTION

In leading PDW research, attempts to build passive dynamic walkers universally failed to meet the performance of their optimised simulation models, often failing after a few steps, just as found out in the initial attempts presented here. To solve this, contemporary dynamic walkers utilise simple local feedback mechanisms to correct error and steer locomotion.² Methods such as active knee locks enable the walkers to attain a steady gait and perform a significantly larger number of steps than their passive counterparts. Using very simple sensor-actuator mechanisms, performance could be radically



Fig.2: Passive dynamic walkers D3 and D2.



Fig. 3: Step cycle for the passive dynamic walker.

improved without the need for any central control system, or high-order reasoning in these primitive robots.

Compared to examples of fully actuated walking robots, such as Honda's ASIMO and Sony's QRIO, PDWs utilise their morphology, material performance, environment, and local feedback systems to attain purposeful behaviour.³ With small amounts of local computational intelligence, these walkers are able to compete with some of the most sophisticated, complex and expensive robots at a fundamental task in humanoid robotics. It's a lesson well worth considering in the context of the design of adaptive and potentially robotically driven buildings: that intelligence can be found in material and morphological strategies and their interaction with the surrounding environment. Computation's role in many instances could be limited to steering behaviour towards a desired goal, thus augmenting

embodied behaviour. In the context of architectural design, passive behaviour in buildings in the areas of ventilation and heat exchange, for example, is well understood and of late has been increasingly utilised as a preferential method for active, complex and energy-demanding HVAC systems. The addition of simple sensor actuator systems in a distributed manner to otherwise passive dynamic environments can mediate uncertain factors of influence inherent in architecture, such as human occupation, building management issues, wear and failure in building components, and changes in the surrounding environment at macro and micro scales.

While entering an era of ubiquitous computing where distributed and embedded sensory devices are predicted to saturate the built environment, an imperative will be to explore novel modes of actuation to respond in a similarly distributed manner. Without central processing systems, managing these networked ecologies of building components, bottom-up sensorimotor models,⁴ will perhaps offer a means to allow architectural space to adapt and develop relationships between its body, its inhabitants and the surrounding environment. Looking to nature for examples of simple sensorimotor interactions that collectively build degrees of intelligent behaviour, inspiration came from *Physarum polycephalum*, a species of slime mould made up of brainless pulsating tissues. These nuclei come together to form a single cell that is able to successfully navigate obstacles and achieve collective goals.⁵

A PROTOTYPE

Taking these ideas forward into an architectural design context, a prototypical sensorimotor system with local intelligence and networked capabilities was conceived based on an adaptive truss mechanism. A single tetrahedral unit of this truss system was assembled using novel bilinear actuators featuring their own embedded local control system. While there have been various architectural investigations into adaptive truss mechanisms focused on structural and façade applications,⁶ mechanisms with the motive capability to propel their self-weight forward through actuation were of particular interest. A single actuated tetrahedron can tumble over irregular terrain. Continuous networks have locomotion with a high degree of freedom, resembling amoeboid movement.⁷ NASA has done particularly interesting research in the fields of swarm robotics utilising robotic tetrahedral truss systems with the intent of building vehicles that are highly adaptive to complex terrains on other planets.⁸ The focus of the research presented here is to explore their earthbound potential in public urban spaces

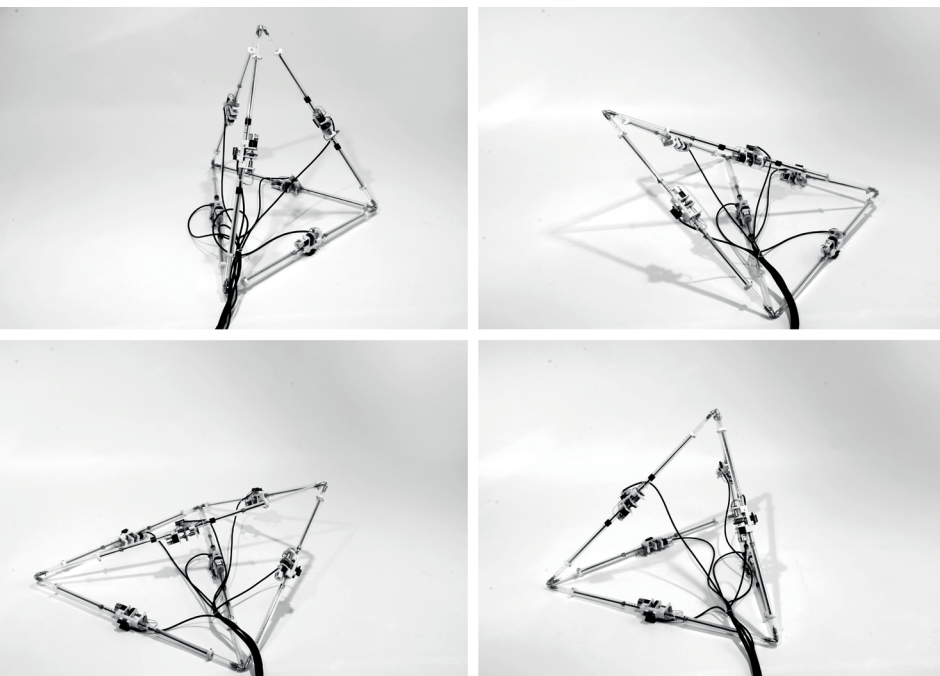

Fig. 4: Exploded view showing the individual components of the bilinear actuator.

through fabricated prototypes and a speculative proposal to develop an architectural brief.

Simulations were carried out using a rigid-body physics engine as a means to understand the dynamics of locomotion for different morphologies. A steady gait pattern was obtained by extending the length of individual rods, thus changing the centre of gravity for the entire structure and resulting in a rolling behaviour. From this, it emerged that geometries with equally distributed weight require less complex control than asymmetrical ones, as step cycles are always identical and the

Fig. 5: Step cycle for the adaptive truss.



pattern of actuation only changes when the morphology of the structure is changed. Similarly to the PDWs, the Morph's movements are not micromanaged by the sensorimotor devices, but emerge from the dynamic interaction between gravity and friction, while the actuators provide a steering role in order to achieve purposeful movement. During experimentation, it was observed that the drop that is experienced once the centre of gravity travels beyond the axis of rotation can be minimised by modifying the order of actuation.

Conventional linear actuators have the majority of their mass at one end, which results in an asymmetrical distribution of weight when configured into platonic geometries. In order to locate the mass of the actuator at its geometric centre, a bespoke bilinear actuator (fig. 4) was developed in collaboration with Paul Harkin of Form Changing Structures, a UK-based company that develops form-changing designs. Conventional linear actuators also do not feature embedded programmable controllers, wireless networking or expandable sensor capabilities, so custom controller circuitry was built on the Arduino open source platform, which allows the creation of interactive electronic products, to be housed within the central motor block.

Six bilinear actuators have been constructed and composed into a tetrahedral truss (figs. 1, 5, 6), with each edge being able

Fig. 6: Prototype for a tetrahedral adaptive truss: partially extended.

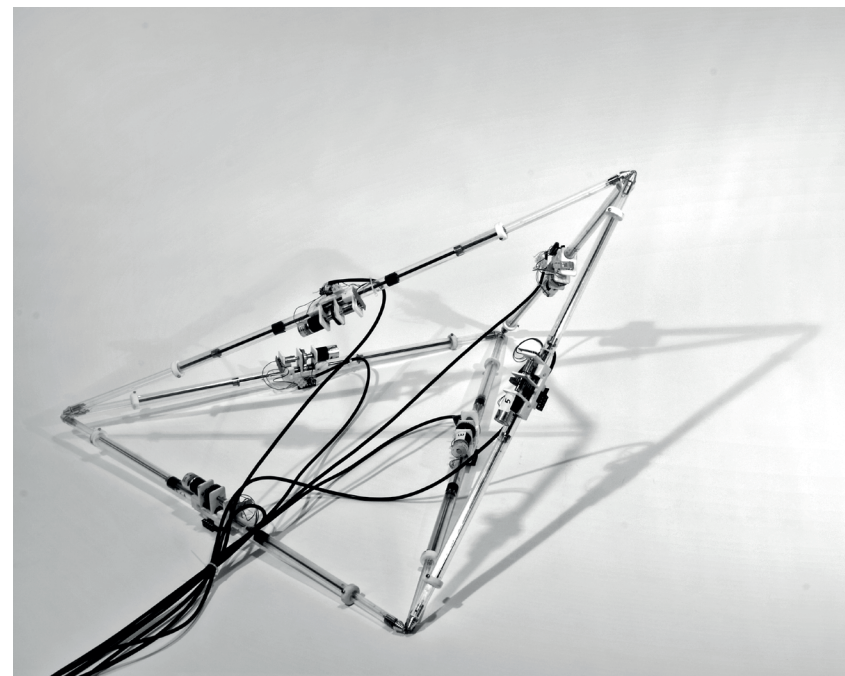

to assume a length between 750 mm and 1300 mm. A decentralised adaptive control system is currently developed to allow these mobile reconfigurable polyhedra (Morphs) to develop intelligent behaviour through their interaction with the surrounding environment. The initial experiments have resulted in the first Morph successfully being able to roll by itself. Currently tethered to an external power supply, its range of movement is limited while we test alternative transportable energy supply solutions.

A PROPOSAL

In becoming propositional about this ongoing project at these early stages of prototyping, it was possible to look ahead beyond the immediate technical challenges and tease out performance goals in individual Morphs and in their innumerable possible amoeboid incarnations. Unlike their sibling tetrahedral robots in mobile robot research, Morphs are slow – far too slow for the performance goals typically desired in robotics, but lightning-fast compared to their surrounding built environment. Moving almost imperceptibly, these structures gently and safely navigate their habitat. Their speculative home is London's Victoria Park, a busy public space with a diverse programme of activities for the Morph to engage with (fig. 7).

Inspired by Tschumi's Parc de la Villette, the park's function is shifted from recreational towards cultural production and social interaction. Morphs provide the necessary infrastructure and support temporary events by self-assembling into sheltered canopies, exhibition and performance scaffolds, and scattered playground climbing frames encourage the public to occupy and find novel uses for them (figs. 8–10). Different classes of Morphs, which are identified by their different colours, are envisioned to cater to different aspects of cultural production, including music, dance and architecture. Classes differ in terms of speed, size and function. The music-enabled units, which are finished in bright orange, are very slow and rarely change their location. They allow musicians to play music in their enclosure, and transmit the sounds they pick up via wi-fi, as a sort of free-for-all radio station. The purple Morphs, which relate to dance, are very fast movers and they respond to push-pull action by their choreographers. They are able to store unique geometries in sequence and play them back when instructed to. The architectural ones, identified by their blue colour, are very slow movers, but they can carry a significant load. They are ideal for assembling large configurations and can be attached to different coloured units to create complex spaces. An additional class of these polyhedrons is also envi-

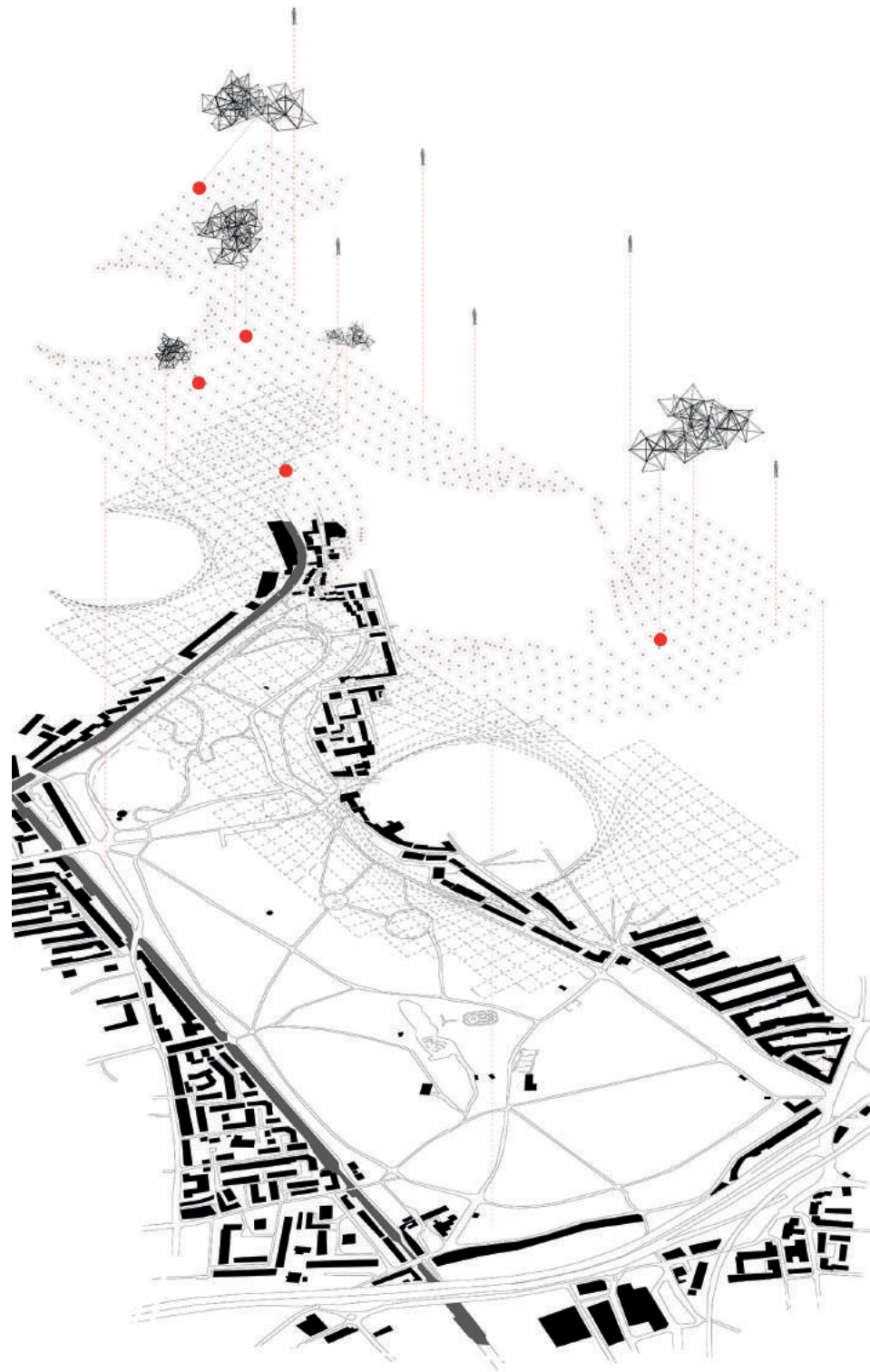

Fig. 7: Exploded view for Victoria Park proposal, showing the different design layers.

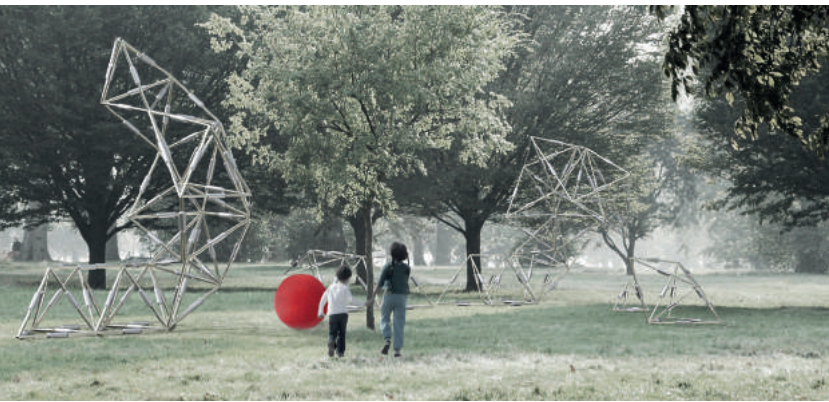

Fig. 8: Photomontage of three Morphs composed of tetrahedral nuclei.

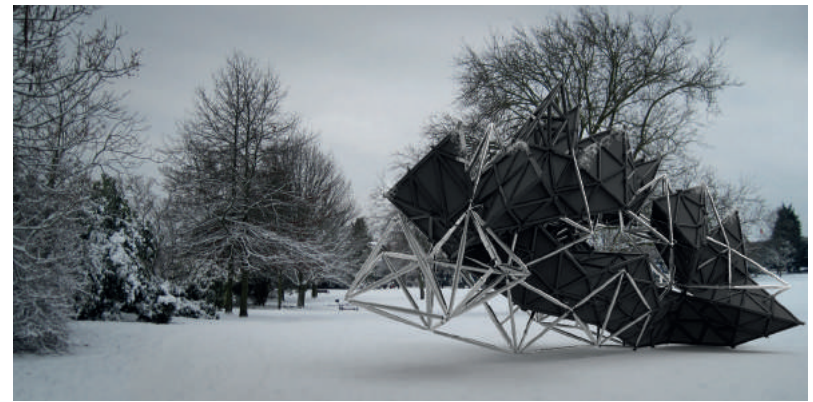

Fig. 9: Photomontage of a Morph with an additional membrane layer.

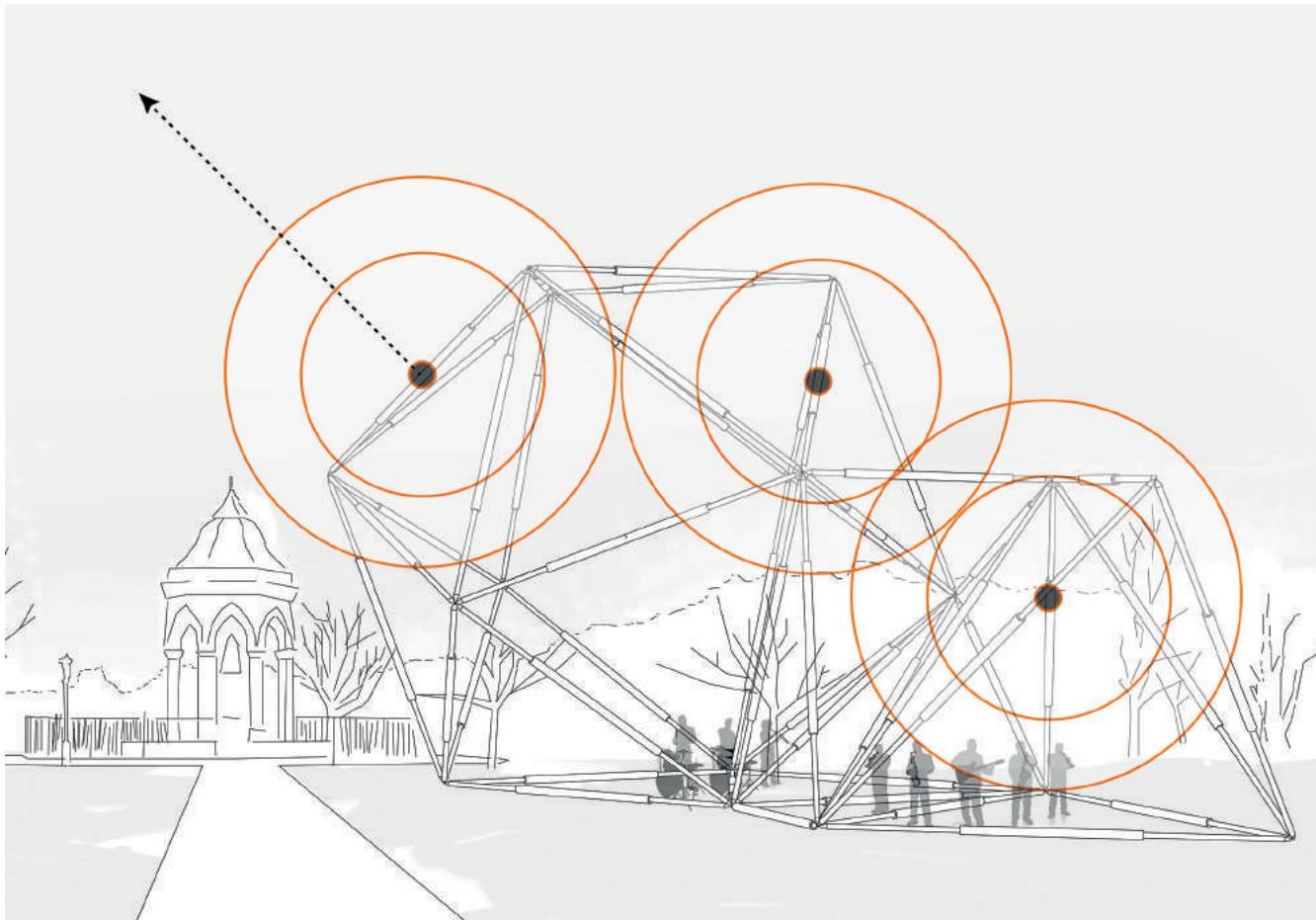

Fig. 10: Illustration of a Morph providing shade in summer.

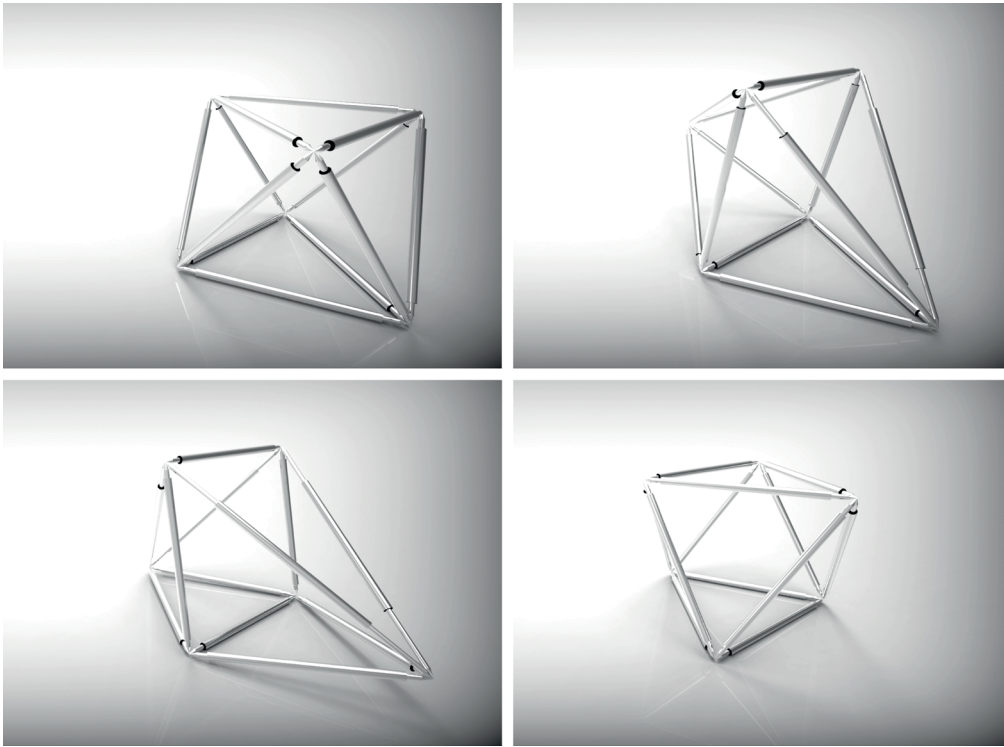

Fig. 11: Simulation for an adaptive octahedral truss.



Fig. 12: Overlays for step cycle performed by the tetrahedral truss prototype.

sioned to cater to open-source development, whereby users can design and build bespoke components that can be plugged into existing units.

Braitenberg's illustration of the importance of the environment in the emergence of complex agent behaviour expands the design space of robotics to include the built environment as a means of manipulating behaviour.⁹ In other words, to modify agent behaviour one might modify its environment as much as modify the agent itself. Charging stations and collection points might be used to choreograph assemblies. Giant visible red balls are proposed as possible mobile attractors for the public in order to manipulate swarm behaviour. As a colony of nomadic nuclei, Morphs come together in order to attain specific goals and then redisintegrate into smaller clusters in order to facilitate their locomotion. Rather than highly complex interlocking mechanisms, it could be expected that the public and park wardens might take a role in their assembly and disassembly.

Morphs are in the early stages of a long-term research project into adaptive behavioural architecture. They are planned to be released by the end of 2015 as autonomous, but socially reconfigurable architecture. Prototyping of a tetrahedron nucleus started in March 2013 and has resulted in one functional unit. Current research involves the programming of these nuclei, the development of their digital communication and the simulation of their social behaviour. The next fully mobile Morph is hoped to be completed by the end of 2013, before larger assemblies are explored during 2014.

NOTES

- 1 Ted McGeer, 'Passive Dynamic Walking', *International Journal of Robotics Research*, 9/2 (1990), pp. 62–82.
- 2 Kalin Trifonov, Guillermo Enriquez and Shuji Hashimoto, 'Design Issues and Applications for a Passive-Dynamic Walker', *International Journal of Multimedia and Ubiquitous Engineering* 4/3 (2009), pp. 57–72. Vanessa F. Hsu Chen, *Passive Dynamic Walking: A Point Foot Model*, Master's thesis (Massachusetts Institute of Technology, 2007). Russ Tedrake, 'Actuating a Simple 3D Passive Dynamic Walker', *Proceedings of the IEEE International Conference on Robotics and Automation* 5 (2004), pp. 4656–61.
- 3 Rolf Pfeifer and Don Berry, *Designing Intelligence: Why Brains Aren't Enough* (Munich: GRIN, 2011), pp. 98–9.
- 4 Rodney Brooks, 'Planning is Just a Way of Avoiding Figuring out What to Do Next', in Rodney Brooks, ed., *Cambrian Intelligence: The Early History of the New AI* (Massachusetts: MIT Press, 1999), pp. 103–10. Valentino Braitenberg, *Vehicles: Experiments in Synthetic Psychology* (Massachusetts: MIT Press, 1986). Tsuda Soichiro, Stefan Artmann and Klaus Peter Zauner, 'The Phi-bot: A Robot Controlled by Slime Mould', in Andrew Adamatzky and Maciej Komosinski, eds., *Artificial Life Models in Hardware* (New York: Springer, 2009), pp. 213–32.
- 5 Chris R. Reid, Tanya Latty, Audrey Dussutour and Madeleine Beekman, 'Slime Mold Uses an Externalized Spatial "Memory" to Navigate in Complex Environments', *Proceedings of the National Academy of Sciences* 109/43 (2012), pp. 17490–4.
- 6 Koryo Miura, Hiroshi Furuya and Kenichi Suzuki, 'Variable Geometry Truss and its Application to Deployable Truss and Space Crane Arm', *Acta Astronautica* 12/8 (1985), pp. 599–607. Axel Kilian, Philippe Block, Peter Schmitt and John Snavely, 'Whowhatwhenair', 14 June 2006. <http://musclesfrombrussels.blogspot.com>, accessed 9 May 2013. Kas Oosterhuis and Nimish Bilorla, 'Interactions with Proactive Architectural Spaces: The Muscle Projects', *Communications of the ACM* 51/6 (2008), pp. 70–8. Senatore Gennaro, Philippe Duffour, Sean Hanna and Fred Labbe, 'Pumping vs. Iron: Adaptive Structures for Whole Life Energy Savings', in Institute of Electrical and Electronics Engineers, ed., *7th International Conference on Intelligent Environments* (Nottingham: IEEE Operations Center, 2011), pp. 114–21.
- 7 Abrahantes Miguel, Leif Nelson and Peter Doorn, 'Modeling and Gait Design of a 6-Tetrahedron Walker Robot', in Institute of Electrical and Electronics Engineers, ed., *42nd Southeastern Symposium on Systems Theory* (Texas: IEEE Operations Center, 2010), pp. 248–52.
- 8 P. E. Clark, et al, 'Addressable Reconfigurable Technology (ART) for Building Sustainable Moon Bases', *American Geophysical Union* 86/18 (2005). S. Curtis, et al., 'Tetrahedral Robotics for Space Exploration', *IEEE Aerospace and Electronic Systems Magazine* 22/6 (2007), pp. 22–30.
- 9 Braitenberg 1986 (see note 4).

Fig. 1: A larger piece of ice captured amongst broken floes and ice debris; the whole mass is pushed together by wind ocean currents. (© Nick Cobbing, Greenpeace.)



FROZEN RELIC: DIGITALLY REFABRICATED ARCTIC ICE FLOES

MATTHEW SHAW, WILLIAM TROSSELL (SCANLAB PROJECTS)

In the summers of 2011 and 2012, ScanLAB Projects visited the frozen Arctic waters of the Fram Strait, northwest of Svalbard, Norway. The ScanLab team captured 3D scan data for the top surface of a series of Arctic ice floes as part of a scientific research trip. In early 2013, a fragment of this landscape was recreated in the exhibition, Frozen Relic, at the Architectural Association, London. The exhibition contained seven scale-replica ice floes, each carefully cast in ice. The moulds used to create these melting artefacts were digitally fabricated from the original 3D scan data captured during the expeditions.

In January and February of 2013, the Gallery Space and Front Members Room of the Architectural Association (AA) housed a scale-replica fragment of the frozen Arctic Ocean. Visitors entering Frozen Relic encountered seven millimetre-perfect 1:100 replica ice floes, suspended in a dark, chilly gallery space. The sound of dripping water filled the air. These replicas were cast in ice. Like the fragile environment the installation mimicked, the exhibits melted, running down the surface of glass and steel plinths to drop and splash into drip trays below.

The data used in the fabrication of Frozen Relic was captured for a wholly different purpose. In the summers of 2011 and 2012, ScanLAB Projects travelled to the Fram Strait, northwest of Svalbard, Norway, as part of a scientific research team. The expeditions, aboard Greenpeace's icebreaker the Arctic Sunrise, were organised by the Polar Ocean Physics Group at the Department of Applied Mathematics and Theoretical Physics (DAMTP), of Cambridge University. At DAMTP, Professor Peter Wadhams and a team of PhD researchers monitor the frozen surface of the Arctic Ocean, studying trends in the extent, thickness and morphology of the ice. Vast data sets of satellite imagery, aerial photography, aerial LIDAR, underwater sonar and on-site investigations are compiled, aligned and ultimately fed into the climatic models that predict global climate change.

As part of this process, the top surface of twenty-six ice floes was 3D scanned by ScanLAB Projects, charting their surface with forensic precision. This data, when aligned to underwater sonar data for the underside surface, provides one of the most detailed sets of three-dimensional information ever collected about the morphology of Arctic sea ice.

The gigabytes of precisely measured points collected by ScanLAB Projects were used in their raw format by DAMTP as data in a gigantic ascii file: endless lists of x, y and z values. While contributing to a fascinating body of research, to compress such a complex and spatial set of information into statistical analyses seems strangely unintuitive and limiting. As a group of architects, designers and fabricators, ScanLAB Projects see the scan data they collect as three-dimensional constructs where each scan is carefully staged, framed and composed. These are not just super-accurate hyper-surveys, but constructed sets of visual and spatial information. The opportunity given by the Exhibitions Team at the Architectural Association allowed a reawakening of the 3D potential of this data.

The motivation behind Frozen Relic was twofold. Both reasons stem from the frustration of the ScanLAB team that such a dynamic, fluxing and immersive landscape was frozen into a solely digital, highly abstracted data set. While this snapshot

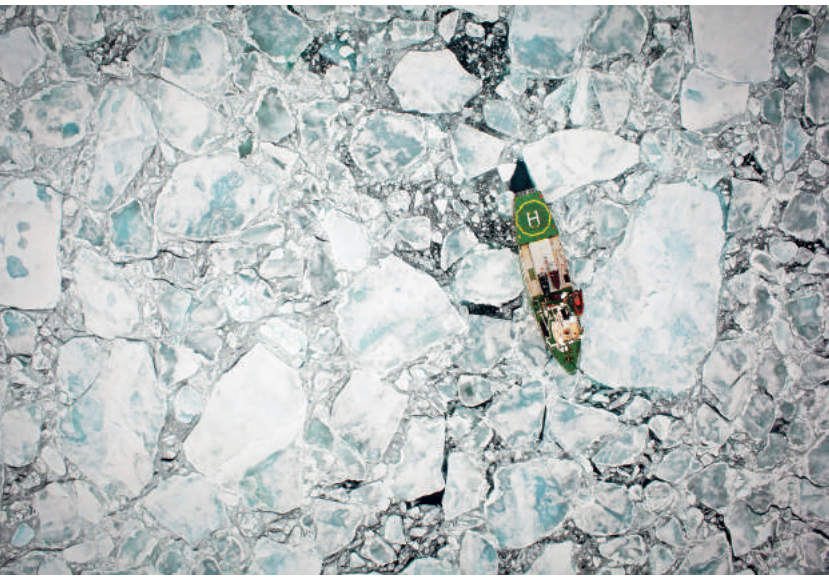

Fig. 2: The Arctic Sunrise among sea ice floes in the Fram Strait.
(© Nick Cobbing, Greenpeace.)



Fig. 3: 3D scanning of the top surface of Arctic ice floes in the Fram Strait,
northwest of Svalbard, Norway.

in time was the perfect base for scientific investigations, the database of numbers lost any sense of memory of the expeditions and lacked any of the political or emotional notions that had guided the experience of visiting such a remote terrain. The first motivation was to create something that re-enacts the original landscape, acts as a basis for its remote experience and provokes its remote contemplation.

The second motivation was more of a fabrication challenge, a test of what can be created in an illusive temperature-dependent material. Working with such a precise set of information at the outset, the continuous battle is to retain detail, despite a shift in scale and a series of fabrication processes. A strange and beautiful futility lies in the pursuit of this detail which, when finally cast in ice, is destined to disappear within the first few hours of the piece being exhibited.

This project is not without its political motivations too. Professor Peter Wadhams, the lead scientist on board the expeditions, has stated that the frozen Arctic Ocean could be subject to a major collapse; a situation where summer melt overtakes winter refreezing in a self-perpetuating cycle. This collapse, he predicted, could occur in 2015–16 when the summer Arctic Ocean would become ice-free, due to one cause: global warming.¹ Greenpeace, the host of both expeditions, were also partial sponsors of the exhibition and key to the story the pieces tell. 3D scanning of ice floes that now no longer exist and replaying this disappearance in a scaled, abstracted form to an urban audience is one of the many profile-raising projects they have supported over the last few years. Their ultimate aim is to declare the Arctic a global sanctuary free from the exploitation of oil companies.

Frozen Relic became the mechanism through which ScanLAB Projects could convey the work they have been doing in support of this research and also push the project beyond a hyper-survey into an act of design speculation. One of the goals is that the objects are simultaneously accurate, provocative and beautiful. Greenpeace roams the planet, bearing witness to the scars mankind is inflicting and raising awareness through publicity stunts and lobbying. For ScanLAB, this act of making is a statement of both fact and material memory.

As architects and designers, ScanLAB questions what these objects are in relation to those more traditionally seen in the design process (prototypes, models, mock-ups, etc). Frozen Relic was not a series of site models, there was no proposal waiting to be inserted, no design vision for their future. They were instead transplanted moments from an icy seascape that is already history. Each time they are refrozen and remelted,

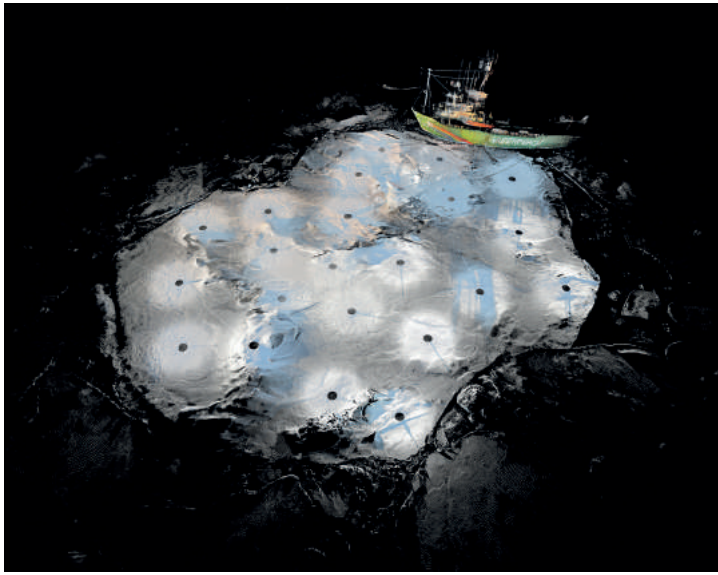

Fig. 4: An image of the aligned 3D scan data for the top surface of the largest floe visited on the 2011 expedition.

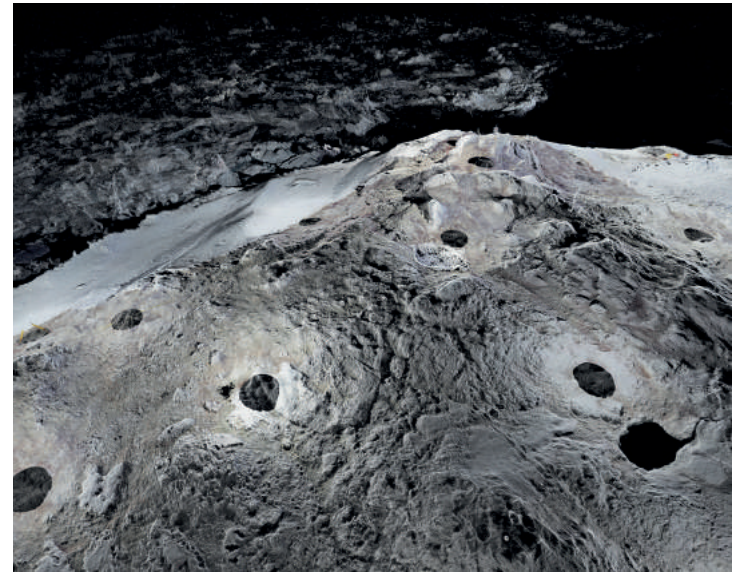

Fig. 5: An image of the 3D scanned top surface of a rare specimen of sea ice. All stamukhi have at some stage been beached and embedded with terrestrial deposits from rivers and tidal movements before being rejoining the shifting Arctic ice pack.

they echo the minute-by-minute processes that constantly occur in the Arctic region, a crushing, fluxing, melting, freezing, drifting landscape. In a way, the objects are cherished samples, test pieces of landscape-scale natural processes. In their uncanny level of accuracy, they ensure that one will remember these ice floes over any others, despite their anonymity in an icescape that is seemingly endless when one is in it. In a certain manner, these objects act as the landscape versions of stuffed exotic animals seen in a museum, as close as many observers will come to the real thing, brought back as wonders of a world far away. Hopefully, they will never become the dodos of landscape history.

The idea to somehow remake these ice floes out of ice was born on the deck of the Arctic Sunrise not long after the first scans were complete. At that stage, there was distinct potential for a number of interesting fabrications. Should these forms be machined from solid blocks of ice? Will the heat from tooling melt the stock material? Can you run a CNC machine in a freezer container? Can a 3D printer be made to accurately place and immediately freeze water particles instead of bond plaster or cure resin? Should these fragments be reproduced at 1 to 1 or as scale replicas? Should these be accurate copies, abstracted indications, an immersive experience?

The commission for the Frozen Relic exhibition at the AA came in October 2012. The timescale and gallery space dictated



Fig. 6: Frozen Relic installed in the AA Gallery, Bedford Square, London, in 2013. Each replica ice floe sits on a glass plinth. As the exhibits melted, they dripped into steel collectors below, and a scaffold structure was revealed. The scaffolds accurately locate the ice drill holes and core samples, while leaving a ghost of the melted ice.

many of the above choices. After careful consideration, and given the short designing, testing and building periods (12 weeks from commission to opening night), a digitally guided mould-making process was adopted. Time, testing and research were focused on the largest unknown – the freezing process.

Having actual data of an object, now long disappeared, as a set of fabrication instructions provoked the choice to make 'perfect' replicas. An immediate abstraction was introduced when the decision was taken to alter their scale. While accurately scaled at 1:100 in the x and y direction, the z scale was exaggerated. Ice floes are the frozen skin of the ocean, they are predominantly flat, pancake-like objects. This z-scaling technique, often employed by the Cambridge team to study the data, exaggerates changes in the topography of the top and underside surfaces, making them more identifiable. A practical consequence of this choice meant that the replicas become thicker objects, with more volume and thus more likely to last

longer than a few hours in the unheated, but not mechanically cooled, exhibition space.

Another consequence of the original data set influenced the next stage in the fabrication process. While the data for the top surfaces is highly accurate, the information for the underside is less complete, compiled from stretches of upwards-facing underwater sonar and transects of drill holes determining a grid-like approximation, rather than a millimetre-perfect surface. This conflicting level of detail was translated into the original positives from which the moulds would be made. The top surface was rapidly prototyped using SLA, giving a sub-millimetre translation of detail. The underside started from a series of laser-cut guides locating every known thickness measurement or sonar reading to give a grid of known points. From this grid, the final surface is interpolated in high-density foam. The intention was that the water level, or eye level in the final exhibition, would act as a

Fig. 7: For the first few hours of each installation, the minute details of each ice floe could be clearly seen in the surface of the ice.

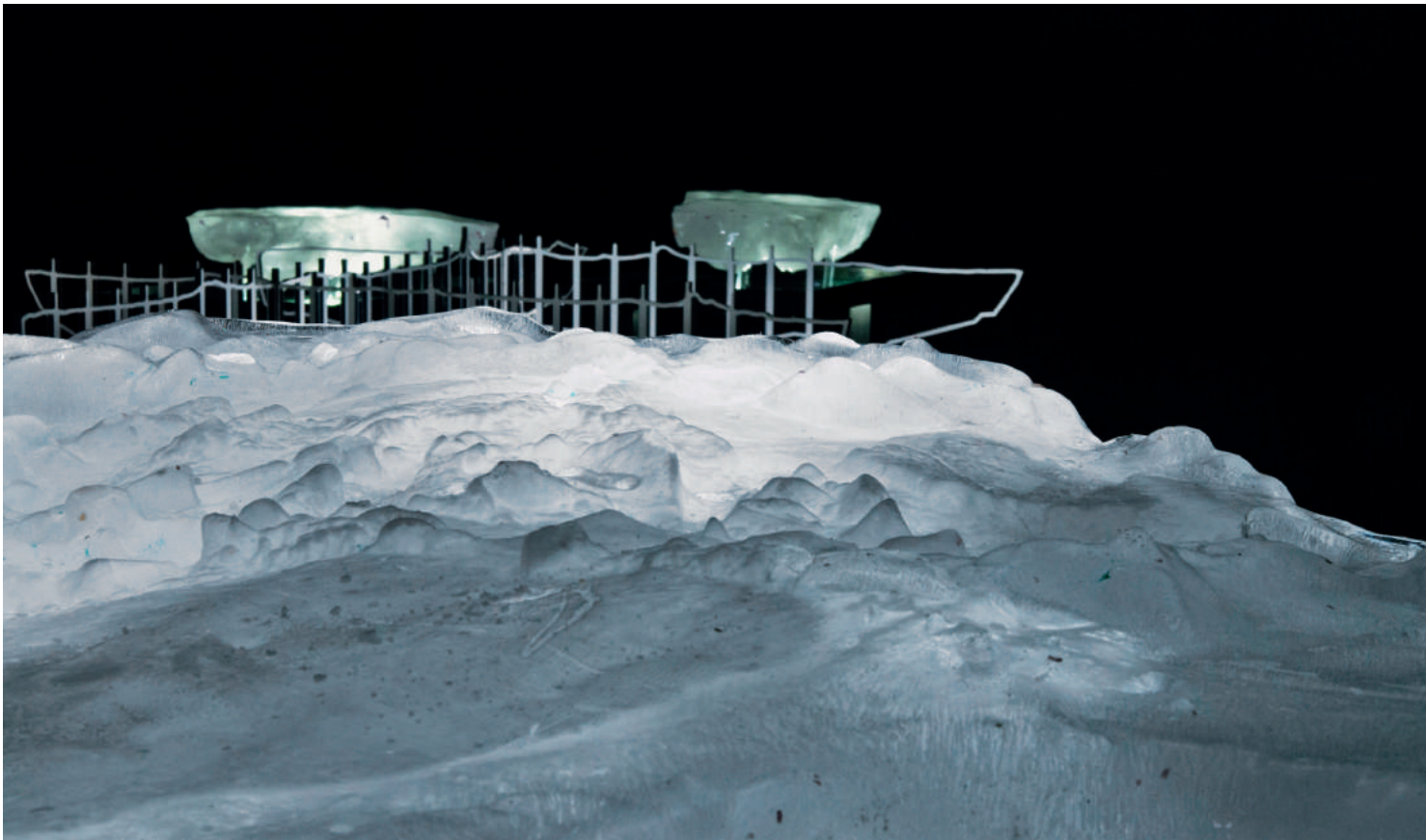

division between the rigorously known and the more speculatively interpreted.

Combining an SLA top surface with a foam underside resulted in a series of final positives. Each positive was sealed and prepared for making a silicone mould. After a series of tests and investigations into resealing techniques, a one-part mould was created for each positive. The process completely encases each positive in silicone and builds up a series of seam lines along which moulds can be cut open and resealed. With the positive still inside, each silicone mould is given a fibreglass jacket, fixed to keys in the silicone below, to give rigidity and form to the flexible silicone. Each mould was then resealed, checked for water tightness and cooled before filling and freezing. Freezing took place in a 4×2.6×2.6 metre refrigerated shipping container kept between -15 and -20 degrees Celsius in the courtyard outside of the fabrication workshop.

The aesthetic of the final ice was another topic of rigorous investigation. The complexity of freezing and the growth of ice were discussed with ice sculptors and scientists across London. There are many different types of ice, each with its own crystal structure and resultant transparency, reflectivity and colour. Frozen Relic aimed to test a series of different techniques, but the first aim was to achieve near-perfect clear ice casts.

In order to freeze perfectly clear ice, the base water must be as pure as possible. In the case of Frozen Relic, this meant distilled, de-ionized water, which was then double boiled and cooled to just above freezing before being added to the moulds. When taken to below the freezing point, water particles do not simultaneously turn into ice. Ice crystals grow from a frozen edge or a particle within, creeping across an exposed surface or slowly building up in perfectly smooth layers from the edge of a mould towards the centre. If water freezes quickly, the crystals are large and visible, the ice appears fractured

Fig. 8: After three days of melting, this abstracted fragment was all that remained of a 200-litre ice replica.

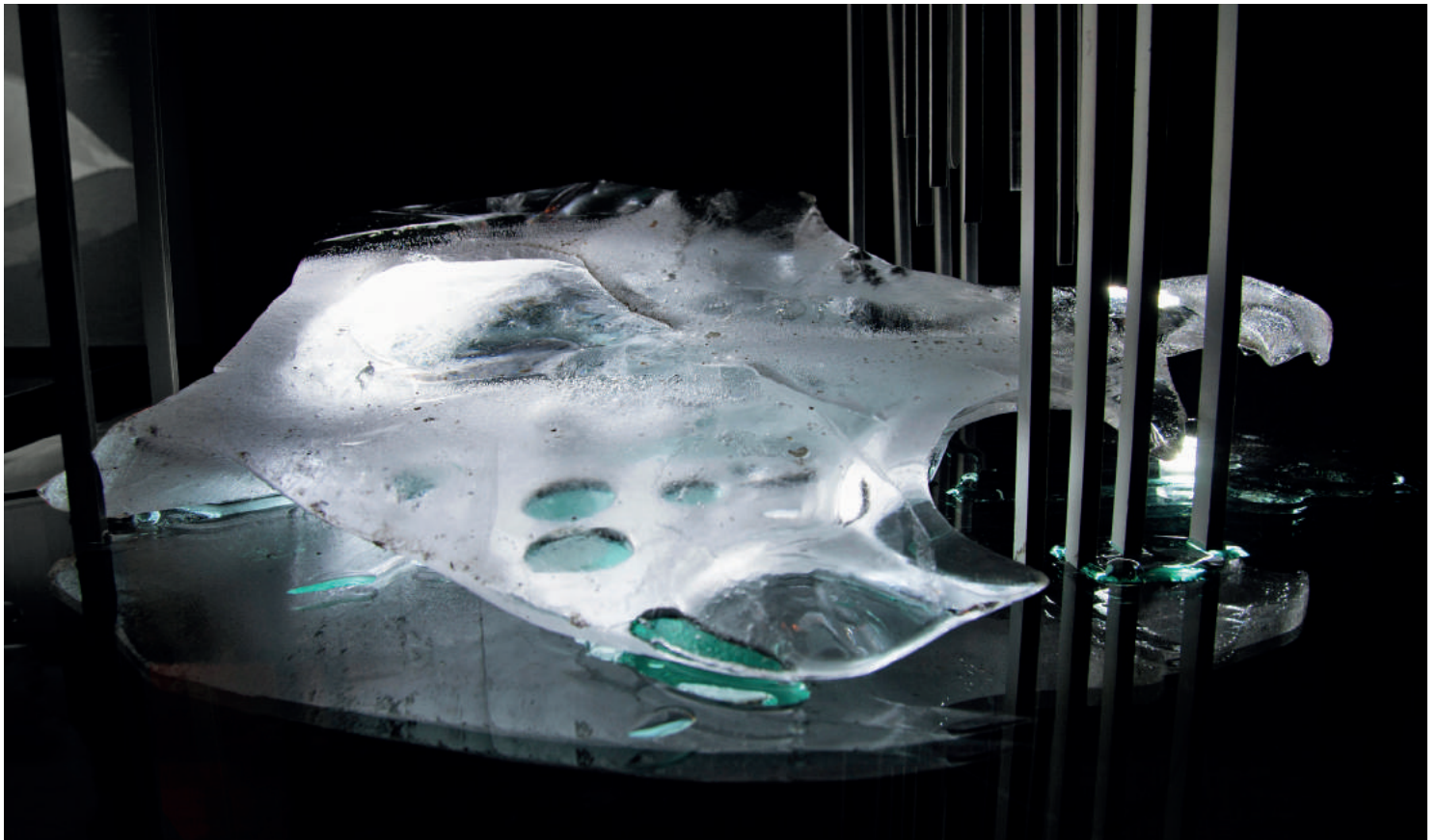



Fig. 9: The full collection of positive replicas. Each combines a SLA top surface and a high-density foam carved underside.



Fig. 10: The near-completed 1:100 positive of the stamukha ice floe originally 3D-scanned in 2012.

and white. Only when ice is frozen slowly do smaller crystals form, creating a perfectly clear, transparent cast. In order to slow the freezing process down, the water was agitated and circulated using a system of pumps. This kept the centre of mould liquid and ensured that the ice grew smoothly from the edges inwards. The exposed top surface of the water, the open part of the mould – and the most likely part to freeze – must be kept ice-free to ensure the expanding volume of the mould's contents can rise as the water freezes and increases in volume. A fully sealed mould will freeze on the outside first, leaving an unfrozen centre which, when it finally freezes, will expand so much in volume that it will crack the previously frozen shell and cause the mould to leak.

A final echo of the scientific process that provoked the project was also installed in the moulds before freezing. A scaffold structure of thin vertical rods and horizontal silhouettes accurately indicated the position of drill lines and core samples taken from each ice floe. These formed a loose frame around which the ice froze. The scaffold pieces were machined out of a white Trespa® cladding material and became exposed as the ice retreated, leaving only these indications of the scientific values recorded on site as an echo of the melted piece of ice.

When installed, the resulting seven pieces were clustered together in an icy archipelago. The pieces varied in size from the smallest at approx $450 \times 250 \times 80$ mm to the largest at $1200 \times 850 \times 450$ mm. The impact on the temperature of the room when fresh ice was installed was substantial, dropping the temperature within the gallery space by 3 or 4 degrees. A noticeable cold draft would flow from the end of the gallery space where the ice was installed to the other end of the space where animations, scan images and drawings described the expedition and pinpointed the GPS locations where each ice floe was observed. The smaller pieces of ice would melt over the course of a day, but the larger objects would last four to five days, gradually smoothing and sculpting themselves into melted memories of their original form. Once a piece melted, it was replaced with a freshly frozen substitute, giving the gallery a constantly changing series of melting fragments.

It was the unexpected and uncontrolled elements of the final ice pieces that gave the most satisfaction to both visitors and the design team. The occasional crack of ice, particularly when a new piece was freshly installed and hit the warmer air of the gallery space, would create a glinting fracture in the depth of a piece. A continuous dripping filled the gallery space with sound, unamplified, even a few drips would still be audi-



Fig. 11: One of the smallest one-part silicone moulds used to cast each Frozen Relic replica. The mould is seen here open with the split line lip for resealing exposed.



Fig. 12: A completed mould, resealed, shelled and loaded with stock ice. The mould is then filled with water and fitted with pumps to ensure a slow, clear freezing process.

ble. The dripping came in waves, sometime a slow trickling and sometimes a rush of collected drips poured from each piece, creating a waterfall of sound, usually accommodating a rise in gallery visitors and their warming of the space.

It is these inherent properties in the real material, ice, that were so removed from the digital data and provoked this investigation at the beginning. Cooling the gallery space as it did, or filling the room with the live sound of melting rewarded the sometimes ridiculous lengths taken to fabricate these disappearing objects out of ice. Reinvesting a purely digital data set with the original characteristics of the landscape where the data had been collected was a turning point in the way ScanLAB now sees the growing bodies of information it collects. These data sets are the provocation for designs and the fabrication instructions for a series of moment-specific, site-specific artefacts. They are the digital memories that will be used to create objects, experiences and statements over the coming years.

As part of a generation equipped with the digital tools to capture and replicate the world in millimetre detail, ScanLAB aims to question how designers respond to this information overload. There is much talk of the number of photos taken in the last 12 months surpassing the total ever taken before in history. In a few years, society will not be concerned with photos, but rather with the unfathomable number of perfectly measured points, sitting on servers silently freezing, archiving and mapping moments and spaces across the world. The practice of design cannot – and will not – resist exploiting them.

Frozen Relic was installed in the Architecture Association Gallery and Front Members Room from 12 January to 9 February 2013. Part of the exhibition also appeared in the Arktis exhibition at the Louisiana Museum of Modern Art, Copenhagen in Sept 2013.

PROJECT COLLABORATORS:

University College London
 Architectural Association
 Dept. of Applied Mathematics and Theoretical Physics,
 Cambridge University
 Greenpeace

NOTES

1 John Vidal, 'Arctic Expert Predicts Final Collapse of Sea Ice within Four Years', *The Guardian*, 17 September 2012, accessed 11 June, 2013 (<http://www.theguardian.com/environment/2012/sep/17/arctic-collapse-sea-ice.html>).

Fig.1: Structural patterns emerging from the Fluid Crystallisation project and 350 neutrally buoyant spheres.



FLUID CRYSTALLISATION: HIERARCHICAL SELF-ORGANISATION

SKYLAR TIBBITS

New self-assembly technologies and programmable material possibilities are emerging across length-scales and disciplinary boundaries, offering shape-changing and intelligent biological, chemical, and material assemblies. This paper proposes the study of chemical interactions and material phase-change between crystalline solids, liquids and gases as a scalable approach for macro-scale assemblies of programmable materials. The Fluid Crystallisation project is highlighted as the first physical example of macro-scale self-organisation of non-deterministic and hierarchical structures. Offering a vision towards the future of fabrication and manufacturing, this project expands the palette of techniques outside of traditional additive or subtractive methodologies into fluid realms of programmable assembly and adaptive material behaviour.

NON-DETERMINISTIC AND HIERARCHICAL ASSEMBLY

Across micro and nano length-scales, new processes are being developed that offer an unprecedented ability to program both biological and synthetic materials to assemble themselves into precisely designed structures, to change shape or material properties and even to compute.¹ This revolution is a result of emerging software, material and hardware technologies as well as the convergence of disciplines with the vision of universal programmable matter and self-assembly.² However, at larger orders of magnitude, these processes have yet to be implemented across manufacturing or construction applications. Similarly, the emerging design space revolving around DNA nanotechnology, materials science and synthetic biology have been primarily limited to deterministic, top-down approaches for engineered structures. Thus far, across these fields, predetermined shapes and functionality have been designed with traditional design tools and engineering methodologies, then self-assembled with bottom-up materials.³ An opportunity has emerged to flip this design paradigm and investigate computational design processes through physical materials that 'evolve' design solutions using self-assembled materials. In other words, bottom-up design with bottom-up materials.

Material phase change, crystallisation and the growth of living systems from fundamental building blocks point towards an alternative future where materials can be self-assembled to a level of arbitrary complexity through non-deterministic principles. Throughout the life sciences, structures and functionality are not necessarily predetermined; rather, they are built from the intersection of embedded material rule sets, i.e. interactions with one another and fluctuations in the surrounding environment. Locally, the fundamental building blocks have fixed and well-known properties that make them deterministic. They have rules for their connections and interactions with similar or dissimilar neighbouring elements and environments. However, these components build upon one another in a hierarchical fashion, whereby secondary structures emerge that are non-deterministic, leading to arbitrary complexity and high functionality as orders of magnitude increase.

INTER- AND INTRAMOLECULAR BONDING

Chemical bonding offers an important case study for local and global interactions between structures and hierarchical systems that can be self-assembled. Two main types of interaction exist between atoms and molecules, intramolecular and intermolecular forces. Intramolecular forces hold the atoms

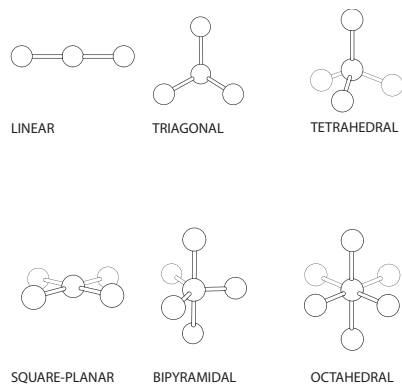

Fig. 2: Intramolecular geometries including: linear, trigonal, tetrahedral, square-planar, bipyramidal and octahedral.

together in a particular molecule and have ionic, covalent or metallic bonds. Alternatively, intermolecular bonding describes the weak forces of attraction/repulsion between molecules to form larger structures. There are various intramolecular geometries that form based on the bonding schemes, including: linear, trigonal planar, tetrahedral, octahedral and many others (fig. 2). At the next level, even with the same intramolecular geometry, various intermolecular patterns can emerge between molecules that lead to 1-dimensional, 2-dimensional and 3-dimensional structures with various material properties (figs. 3, 4). The order of the structure and the interaction of the

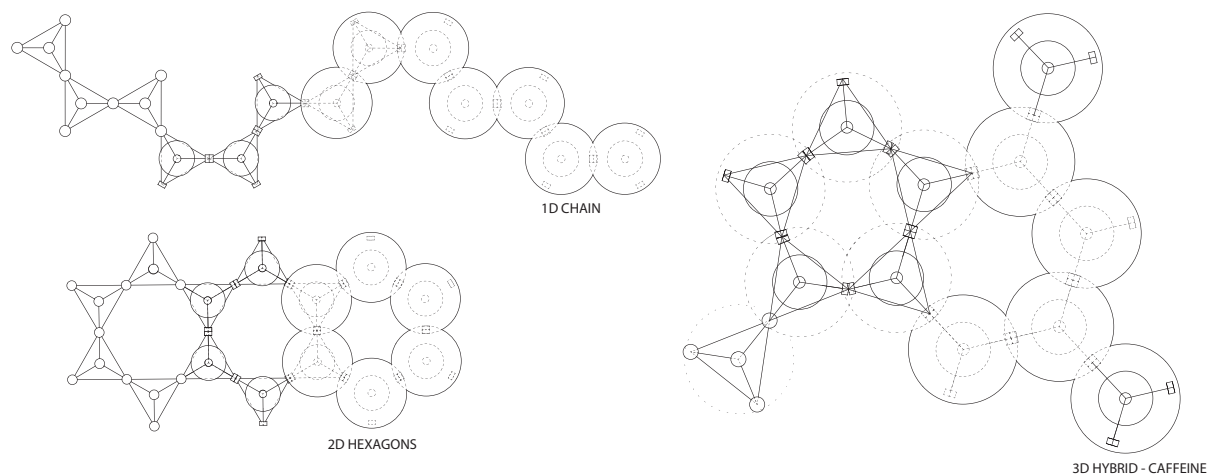

Fig. 3: Intermolecular structures, including 1-dimensional, 2-dimensional and 3-dimensional patterns.

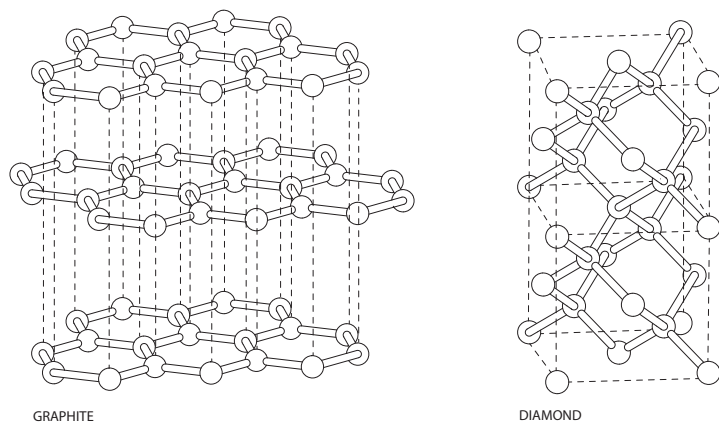

Fig. 4: Carbon-based 2-dimensional graphite sheets and 3-dimensional diamond intermolecular structures.



Fig. 5, 6: Fluid Crystallisation project, exhibited at the 2013 Architectural League Prize Exhibition, Parsons Gallery, NYC.

molecules collectively determine the phase or state of the matter at any given point. In this way, the temperature (or other energy source) of a system can excite the molecules and create phase change. Although the global behaviour of the material phase may still be repeatable and deterministic in character, the local structures may be non-deterministic in order. This can also be demonstrated at other length-scales by adding turbulence or increased interactions between components to cause self-assembly or disassembly and demonstrates an important principle towards the design of hierarchical and reconfigurable material assemblies.⁴

FLUID CRYSTALLISATION

It has been previously demonstrated that self-assembly is a scale-independent phenomenon and can be demonstrated at large length-scales with synthetic materials and human-scale forces.⁵ The BioMolecular Self-Assembly, Chiral Self-Assembly and Self-Assembly Line projects have previously demonstrated self-assembly through deterministic models with a single order of magnitude rather than offering hierarchical assembly of much larger, arbitrary, structures.⁶ Similarly, an opportunity emerged to study fluidic self-assembly with neutrally buoyant structures to eliminate the effects of gravity and ease the

introduction of turbulent energy through wave propagation. These factors led to the development of the Fluid Crystallisation project for the 2013 Architectural League Prize Exhibition in New York aiming to study hierarchical and non-deterministic self-organisation of structures based on material phase change from crystalline solids, liquids and gases (figs.5,6). This project offers a glimpse at material-based design and computation where global structures emerge, based on system entropy and embedded logics. Ultimately, if the programmable material revolution is going to influence our human-scale processes of design, manufacturing, fabrication, construction or product development, then large-scale structures of arbitrary complexity and effortless reconfiguration will need to be developed to demonstrate true viability.

The Fluid Crystallisation project consists of a 200-gallon, water-filled tank with programmable turbulence and 350 neutrally buoyant spheres (figs.1,5,6). Within the spheres, plastic armatures were constructed based on the intramolecular geometry of carbon, forming a tetrahedral structure (fig.7). Two laser-cut plastic elements interlocked to form the tetrahedron (fig.8). At each point of the tetrahedron, a magnet was placed; two magnets had positive polarity, while the other two had negative-facing polarities, demonstrating intermolecular

forces (fig. 9). At the centre of the armature was a hollow plastic sphere filled with air and two lead shots. The entire structure was then enclosed in a larger hollow sphere and filled with water. The complete structure, including the plastic armatures, magnets, hollow inner sphere and lead shots, added up to precisely 104 g in order to have perfect neutral buoyancy in the water-filled tank. Neutral buoyancy allowed each of the spheres to move effortlessly in all three dimensions (x, y, z) and ultimately made it possible to self-organise 1-dimensional, 2-dimensional and 3-dimensional structures, rather than limiting the structures to either floating on the surface or sinking to the bottom.

cy in the water-filled tank. Neutral buoyancy allowed each of the spheres to move effortlessly in all three dimensions (x, y, z) and ultimately made it possible to self-organise 1-dimensional, 2-dimensional and 3-dimensional structures, rather than limiting the structures to either floating on the surface or sinking to the bottom.

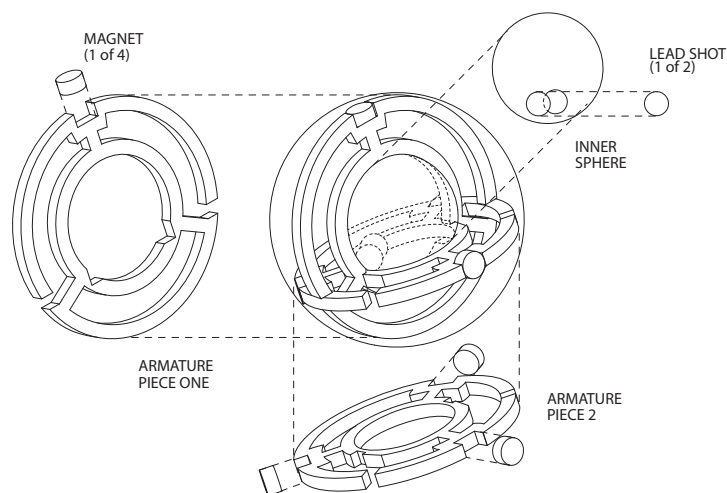

Fig. 7: Carbon-based tetrahedral armatures holding four magnets, a hollow inner sphere and lead shot enclosed in a water-filled outer sphere.



Fig. 8: Figures showing the carbon-based tetrahedral armatures and hollow inner spheres.

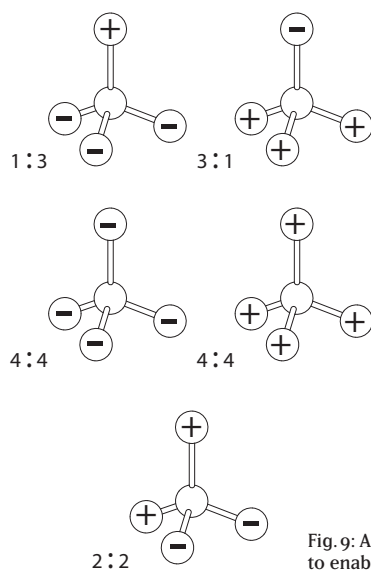

Fig. 9: All possible magnetic polarities for the carbon-based armatures to enable the formation of larger intermolecular structures.

ENVIRONMENT AND SELF-ORGANISED STRUCTURES

Two programmable pumps were placed in the 200-gallon, water-filled tank to introduce turbulence into the system. The pumps could be programmed to have repetitive oscillations, natural wave patterns, random intensity and constant force. Each of the patterns of force provided different opportunities for assembly and disassembly in the system. Greater intensity of the force would break the structures apart into individual sphere elements or lower-level connections, while continuous circulation around the tank and moments of stasis helped the structures self-assemble. The location of the pumps also offered a parameter of influence. The final configuration placed both pumps at the centre of the tank on the rear wall. This allowed a strong pumping force to move from the back wall toward the front wall breaking up structures as they passed while also creating two vortex patterns of circulation around the left and right sides of the tanks where larger structures assembled.

Various local and global structures emerged over the course of seconds, minutes and hours (fig.10). Locally, the structures formed 1-dimensional chains and 2-dimensional squares, pentagons and hexagons. Pentagons formed most successfully due to their local strength and the high force needed for disassembly. Hexagons were also common, however they often broke due to the structures' flexibility. Squares were the least common and probably the most difficult structures to construct. At the next order, icosahedrons or partially formed dodecahedrons could be easily observed as spherical structures moving freely and connecting or disconnecting from larger masses. Globally, many patterns developed from a solid mass across the tank, two large bodies in the left and right sides, distributed individual spheres or small ordered structures. The various hierarchies demonstrate the relationship between material phase-change (solid, liquid, gas) and the structural ordering of atoms or molecules within a material. Polymorphism was observed where the same local structures could solidify in more than one crystalline form, demonstrating the versatile nature of carbon as a building block for life.

A single mass observed in the tank demonstrated a crystalline solid, however at closer inspection, various local structures were built within the mass, forming a hierarchical order and impurities of the larger material system. As understood in the study of liquid crystals, the observed structures and imperfections of the system may correspond to a material's performance through a translation between the molecular order and the global material behaviour.⁷ The non-deterministic nature of the system leads to the observation that large struc-

tures of arbitrary complexity and high functionality may be possible with guided environments, programmable material logics and designed local/global interactions of the system.

APPLICATIONS AND FUTURE WORK

The Fluid Crystallisation project contributes to the field of programmable matter and universal self-assembly, and offers a new glimpse at hierarchical, non-deterministic, models of construction for arbitrarily complex structures. Further studies will investigate larger scale systems in fluid mediums, either with more parts or larger components. Other environments like zero gravity or helium-filled structures could offer potential for self-assembly at a human scale for reconfiguring spatial conditions and fluid-like behaviours. Tracking systems, pattern recognition and further simulation tools will be developed to help predict possible structures, given a pattern of programmable interaction or intra/inter geometry, and also highlight the structures when they physically assemble. The existing structures utilised orange and black units to differentiate patterns and help visualisation as densities or specific geometries emerged, however, further techniques could be developed to pinpoint connected, closed structures, such as closed-loop circuits and object recognition tools.

This work points towards a future of fabrication and manufacturing that is not limited to additive or subtractive techniques, but rather a future in which fluid mediums can contain programmable elements that clump, aggregate and assemble complex structures with high resolution. Repeatable and efficient, this form of programmable materials and non-deterministic self-assembly is completely recyclable and controlled by environmental changes, internal elements and local interactions. Energy, time and component interactions relate to one another in this highly delicate relationship. In manufacturing or construction, if energy input should be reduced for sustainability and productivity should increase, then environmental constraints can be utilised to increase efficiency and maintain high entropy. In this way, programmable material assemblies can become a new tool for the future of efficient manufacturing and product assembly. Future construction scenarios at extreme length-scales, complex environments and expensive or dangerous situations will require new methods of fabrication and assembly that do not rely on existing human-based assembly or fabrication practices. New programmable and fluid processes will need to be developed where materials, energy, machines and humans can collaborate for scalable, highly reconfigurable, adaptive and intelligent environments.



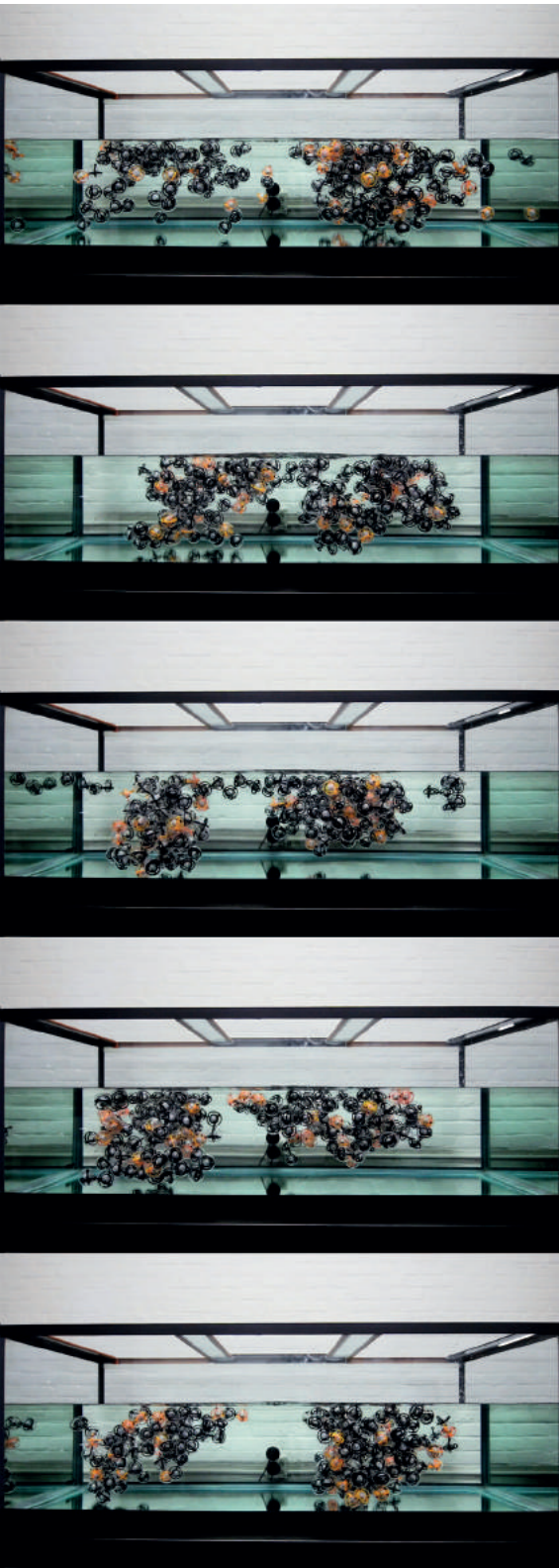

Fig. 10: A sequence of images showing various global structures that self-organise over time.

ACKNOWLEDGEMENTS

Fluid Crystallisation was developed in the Self-Assembly Lab, MIT and was made possible by support from the Department of Architecture, MIT and the Architectural League of New York. The project was a collaboration between Skylar Tibbits, Arthur Olson, Graham Francis, Marianna Gonzalez, Amir Soltanianzadeh, Monica Zhou and Veronica Emig.

NOTES

- 1 Nicole Michelotti, et al., 'Beyond DNA Origami: the Unfolding Prospects of Nucleic Acid Nanotechnology', *WIREs Nanomed Nanobiotechnology*, 4 (2012), pp. 139–52.
- 2 Kenneth C. Cheung, et al., 'Programmable Assembly with Universally Foldable Strings (Moteins)', *IEEE Transactions on Robotics*, 27/4 (2011), pp. 718–29. Neil Gershenfeld, *FAB: The Coming Revolution on your Desktop: From Personal Computers to Personal Fabrication* (New York: Basic Books, 2005). George A. Popescu, 'Digital Materials for Digital Fabrication', M.Sc. thesis (Cambridge, Mass.: MIT, 2007).
- 3 Michelotti 2012, (see note 1).
- 4 Skylar Tibbits, 'Design to Self-Assembly', *Architectural Design*, 216 (2012), pp. 68–71.
- 5 Ibid.
- 6 Skylar Tibbits and Anna Falvello Tomas, 'BioMolecular, Chiral and Irregular Self-Assemblies', *Proceedings of the 33rd Annual Conference of the Association for Computer Aided Design in Architecture, Waterloo, Canada* (2013), pp. 261–8.
- 7 Sivaramakrishna Chandrasekhar, *Liquid Crystals* (2nd ed.), (Cambridge: Cambridge University Press, 1992).

AUTHORS' BIOGRAPHIES

ROBERT AISH is visiting professor of Design Computation at the University of Bath. He studied with the renowned craftsman, David Pye, at the Royal College of Art and also with the pioneering design methodologist, Bruce Archer. His interest in design computation reflects these formative influences. Robert Aish has been at the forefront of the parametric design movement, first in shipbuilding at the Gdansk Shipyard, followed by YRM where parametric software was first applied to architecture in the development of the Waterloo International Railway Station designed by Grimshaw. These ideas were further developed in GenerativeComponents with Smartgeometry and latterly with the development of DesignScript as the fusion of graph-based parametrics and imperative scripting.

ALISA ANDRASEK is an architect and curator. She is a founding principal of Biothing operating at the intersection of design, complexity and computer science. Alisa teaches at the UCL Bartlett School of Architecture and has taught at the AA, Columbia, Pratt, UPenn and RMIT Melbourne. She has received numerous awards and her work has been exhibited worldwide.

STEFANO ANDREANI is a licensed architectural engineer and teacher interested in the strategic implementation of advanced technologies in architecture for innovative design solutions. As Research Associate at the Graduate School of Design at Harvard University, he pursues research on performative material systems within the Design Robotics Group (DRG) and on the future of learning and healthcare environments within the Responsive Environments and Artifacts Lab (REAL). Stefano received a Master in Design Technology degree from Harvard GSD and a Master in Architectural Engineering degree from the University of Perugia, where he was Assistant Professor of Architectural Technology. As Project Designer at RBA Studio and Design Technology Consultant for the South China University of Technology, his professional work mainly focuses on high-rise design.

PHIL AYRES is an architect, researcher and educator. He joined the faculty at CITA (Centre for Information Technology and Architecture, Royal Academy of Fine Arts, Copenhagen) in 2009 after a decade of teaching and research at the Bartlett School of Architecture in London, and is completing his PhD in Denmark at the Aarhus School of Architecture. He has also been a partner of sixteen*(makers) since 1998. Phil is the editor of the book *Persistent Modelling: Extending the Role of Architectural Representation*, published by Routledge in 2012. He is also the Head of the international master's programme CITAstudio: Computation in Architecture.

EMILY BAKER is an American architect with degrees in architecture from the University of Arkansas and Cranbrook Academy. Practising architecture in the US has afforded her ample time on job sites observing construction processes and coordinating work among architects, engineers and contractors. This experience formed the basis of her research in developing innovative structural and construction systems through full-scale constructed experimentation. Her work, employing both digital and traditional design and fabrication techniques, aims to reunite the architect with the possibilities inherent in material reality. She teaches design studios, drawing, and courses that centre on fabrication and full-scale construction at the American University of Sharjah in the United Arab Emirates.

MELONIE BAYL-SMITH is the Director of Bijl Architecture and Adjunct Professor at the School of Architecture at the University of Technology Sydney, where she undertakes research and teaches design studio and professional practice. Since 2007, Bayl-Smith has been instrumental in leading several innovative design/build studios at UTS, each of which utilised prototyping and building to explore digital/analogue relationships in design and construction. These interests are further evident in recent built projects

undertaken by Bijl Architecture and in the Buildability research project, which gathered international attention for her critique and vision of the future of construction education in architecture schools.

MARTIN BECHTHOLD is Professor of Architectural Technology at the Graduate School of Design (Harvard University), Director of the Design Robotics Group, and Co-Director of the GSD's Doctor of Design Program. His research on material system innovation pursues computer-aided design and manufacturing applications in architecture, with a focus on broadening design scope through construction automation and industrial robotics. Current projects investigate adaptive material systems, lifecycle design, and fabrication automation strategies for architectural ceramics and other construction systems. Martin is the co-author of *Structures and Computer-Aided Design and Manufacturing* as well as the author of *Innovative Surface Structures*, a book that addresses the increasing conflation of structural design and digital fabrication techniques through the microcosm of thin shells and membranes.

PHILIP BEESLEY MRAIC OAA RCA (Professor, School of Architecture, University of Waterloo; Director, Integrated Group for Visualization, Design and Manufacturing, Director, Riverside Architectural Press) is a practising architect developing responsive kinetic architectural environments that approach near-living functions. He is cited as a pioneer in the rapidly expanding technology of responsive architecture with wide press including WIRED, TEDx, Discovery Channel features. He has authored and edited eight books, three international proceedings and a number of catalogues, and appears on the cover of Artificial Life (MIT), LEONARDO and AD journals. Current projects are in Salt Lake City, Seoul, Edmonton and Hangzhou. He was selected to represent Canada for the 2010 Venice Biennale for Architecture and the 2012 Biennale of Sydney. He works as part of a multidisciplinary collective that includes Rachel Armstrong, Rob Gorbet and Iris van Herpen. Distinctions include Prix de Rome in Architecture (Canada), VIDA II.O, FEIDAD, RAIC Allied Arts, ACADIA Emerging Digital Practice and Dora Mavor Moore awards. He was chair for the ACADIA 2013 Adaptive Architecture international conference.

BRAD BELL is an Assistant Professor of Architecture at the University of Texas, Arlington, where he teaches undergraduate and graduate courses on the integration of digital fabrication technologies into the architectural design process. He has lectured, taught and written on the uses of such technologies for the past 12 years and has been an invited critic throughout the United States. Brad received his master's degree in architecture from Columbia University in 1998 and a bachelor's degree in Environmental Design from Texas A&M in 1993. In 2012, Brad started TOPOCAST, a design and consultation firm focused on the implementation of innovative methods in casting through the application of digital fabrication technologies.

JAMES BELLAMY is a sustainable builder and runs a socially responsible construction company based in New Zealand, specialising in earth construction methods with a focus on public facilities. His most notable projects include the Pines Calyx in Dover, England and Mapungubwe National Park Interpretation Centre, South Africa. With a passion for ecological systems and a degree in Parks and Recreation Management, his efforts are to design and build structures that resonate with and utilise the local natural setting.

PHILIPPE BLOCK is Assistant Professor in structural design and head of the BLOCK Research Group at the Institute of Technology in Architecture at ETH Zurich, specialising in equilibrium analysis of unreinforced masonry vaults, computational form finding and optimisation of curved surface structures and innovation in fabrication and construction of such structures.

He is a structural engineer and architect, trained at the VUB in Belgium and MIT in the USA. As partner of Ochsendorf DeJong & Block LLC, he applies his research in practice on the structural assessment of historic monuments and the design and engineering of innovative compression shells.

WILLIAM BONDIN is a Maltese architect and creator of Morphs – a reconfigurable architectural system. He completed his professional studies in Malta (UoM) and then undertook research at the Bartlett School of Architecture (UCL), where he focused on interaction design and architectural behaviour. His work has been featured on wired.com and published at the Fascinate 2013 conference, amongst others. Inspired by the architectural works of Ron Herron and Richard Buckminster Fuller and the robotic theories of Rolf Pfeifer and Rodney Brooks, his designs take a fabrication-oriented approach towards architectural performance and behaviour.

BRENNAN BUCK is principal of the firm FreelandBuck, based in New York City and Los Angeles, and a critic at the Yale School of Architecture. His work and writing, which focuses on technology within the discipline and its associated aesthetic culture, has been published in *Log*, *Frame*, *Architectural Record*, *Detail* and *Surface* as well as several recent books on architecture and technology. Prior to teaching at Yale, he worked for Neil M. Denari Architects and Johnston Marklee & Associates in Los Angeles and taught at the University of Applied Arts in Vienna, the Royal Danish Academy in Copenhagen, the University of Kentucky and Pennsylvania State University.

MARK BURRY has published internationally on two main themes: the life and work of the architect Antoni Gaudí in Barcelona, and putting theory into practice with regard to 'challenging' architecture; he has also published widely on broader issues of design, construction and the use of computers in design theory and practice. As Consultant Architect to the Temple Sagrada Família since 1979, Mark Burry has been a key member within the small team, untangling the mysteries of Gaudí's compositional strategies for the Sagrada Família, especially those coming from his later years, the implications of which are only now becoming fully apparent as they are resolved for building purposes. In February 2004, in recognition of his contribution to this project, he was given the prestigious award '*Diploma I la insígnia a l'acadèmica corresponent*' and the title *Senyor Illustre* by the Reial Acadèmia Catalana de Belles Arts de Sant Jordi and he was recently awarded an Australian Research Council Federation Fellowship. Mark is director of RMIT's state-of-the-art Spatial Information Architecture Laboratory, which has been established as a holistic interdisciplinary research environment dedicated to almost all aspects of contemporary design activity. The laboratory focuses on collocated design research and undergraduate and postgraduate teaching with associated advanced computer applications and the rapid prototyping of ideas. The laboratory has a design-practice emphasis and acts as a creative think-tank accessible to both local and international practices, including ARUP in Melbourne and London, dECOi in Paris and Gehry Partners in Los Angeles.

MARIO CARPO is Vincent Scully Visiting Professor of Architectural History at Yale University and at the Ecole d'Architecture de Paris-La Villette (currently on leave). After studying architecture and history in Italy, he was an Assistant Professor at the University of Geneva in Switzerland, and has been a tenured Associate Professor in France since 1993. Mario Carpo's research and publications focus on the relationship among architectural theory, cultural history, and the history of media and information technology. His award-winning *Architecture in the Age of Printing* (MIT Press, 2001) has been translated into several languages. His most recent books are *Perspective, Projections and Design* (2007, co-edited); a translation and commentary of Leon Battista Alberti's *Descriptio Urbis Romae* (2007,

co-authored); a monograph on the work of Swiss architect Valerio Olgiati (2008, co-authored); *The Alphabet and the Algorithm* (MIT Press, 2011), and *The Digital Turn in Architecture, 1992–2012* (Wiley, 2012). His recent essays and articles have been published in *Log*, *The Journal of the Society of Architectural Historians*, *Grey Room*, *L'Architecture d'aujourd'hui*, *Arquitectura Viva*, *AD/Architectural Design*, *Perspecta*, *Harvard Design Magazine*, *Cornell Journal of Architecture*, *Abitare*, *Lotus International*, *Domus*, and *Arch+*.

GIOVANNI CESARETTI is Marketing and Sales Manager at Alta SpA. After completing his PhD, he worked for government bodies and Technology Transfer Centres. In 2005, he moved to Alta, where he was in charge of the bids and tenders sector. He is also Project Manager for various activities, and since 2004, he has been a reviewer of research and development projects for Italian and European institutions in the fields of information technology and space engineering.

ZACHARY CHRISTIAN is a research associate in the Department of Timber Engineering, Materials Testing Institute (MPA) at the University of Stuttgart since 2012. He completed his master's degree in Structural Engineering (MSc) at Chalmers University of Technology in Sweden in 2012 and a bachelor's degree in Civil Engineering (BSCE) at Purdue University in the USA in 2007. Between his degrees, he worked for 3 years in Madrid as a structural engineer, dealing mostly with prestressed concrete bridge design. His current research focuses on timber as a building material, with projects ranging from fatigue in special timber elements to creep of wood adhesives.

BRANDON CLIFFORD is currently the Belluschi Lecturer at the Massachusetts Institute of Technology as well as Principal at Matter Design. Clifford received his Master of Architecture from Princeton University in 2011 and his Bachelor of Science in Architecture from the Georgia Institute of Technology in 2006. From 2006 to 2009 he worked as project manager at Office dA. Brandon also served as editor of *Pidgin Magazine* from 2009–11, the 2011–12 LeFevre Emerging Practitioner Fellow at the Ohio State University Knowlton School of Architecture, and the founder of the Malleablist Movement in architecture. He has received numerous prizes, including the prestigious SOM Prize in architecture and urban planning in 2011 and the Architectural League Prize for Young Architects + Designers in 2013.

VALENTINA COLLA obtained a master's degree in Engineering in 1994 from the University of Pisa and a PhD in Robotics in 1998 from Scuola Superiore Sant'Anna of Pisa, where she is currently working as a Technical Research Manager at the Institute for Communication Information and Perception Technologies. Her research interests deal with simulation, modelling and control of industrial processes and industrial data processing through traditional and AI-based techniques. She has been involved in about 40 projects funded by the EU and many projects supported by industries. She is presently coordinator of two projects supported by the Research Fund for Coal and Steel. She is a member of the European Steel Technology Platform (ESTEP).

MARJAN COLLETTI is an architect, educator, researcher, author, and co-founder of marcosandmarjan (with Marcos Cruz). She is currently Senior Lecturer at Bartlett UCL and University Professor at Innsbruck University, as well as elected Head of the Institute of Experimental Architecture. Previously she was guest professor in the US, UK and EU with workshops at École Spéciale d'Architecture Paris, Royal Danish Academy of Fine Arts Copenhagen, School of Architecture Oslo, Tonghai University and Feng Chia University Taichung Taiwan. Marjan was invited expert/peer reviewer/board member of RobArch2012, ICESEP China, Ministry of Education Russia,

Canada Foundation for Innovation, American University of Sharjah UAE, Queen's University Belfast, *Journal of Cultural Economy*, Taylor and Francis, Ashgate Publishing, and Initiative Architektur Salzburg.

DAVID CORREA is a doctoral candidate at the Institute for Computational Design at the University of Stuttgart. He completed a Master of Science in Architecture at the University of Calgary and a Bachelor of Science in Architectural Science from Ryerson University in Toronto. In 2012, he was awarded the Royal Architectural Institute of Canada's Student Medal for Academic Excellence. Prior to joining the ICD in August 2012, he worked professionally as a designer in both architecture and commercial digital media. His research focuses on the physiological relation of information intensive technologies with architectural theory, practice and material production.

KRISTOF CROLLA is a licensed architect who combines his Assistant Professorship in Computational Design at the Chinese University of Hong Kong (CUHK) with his practice at the Laboratory for Explorative Architecture & Design Ltd. (LEAD). After graduating from Ghent University and practicing in Belgium, he trained and taught at the Architectural Association's Design Research Laboratory (AA-DRL) in London. He worked for several years as Lead Architect for Zaha Hadid Architects before moving to Hong Kong in 2010, and has been an invited jury critic, lecturer and tutor in numerous institutions throughout Europe, China, Chile and South Africa.

XAVIER DE KESTELIER is a partner at Foster + Partners, where he jointly heads Foster + Partners' Specialist Modelling Group, a project-driven R&D group that specialises in complex geometrical problems, computation and building physics. Besides this, he was also responsible for the implementation of rapid prototyping technology in the practice and has initiated several research projects on the application of additive manufacturing on an architectural scale. He has been Visiting Professor at the University of Ghent, Adjunct Professor at Syracuse University and a teaching fellow at the Bartlett School of Architecture (UCL). In 2010, he became a Director at Smartgeometry, a non-profit organisation that promotes advances in digital design in architectural research and practice.

BENJAMIN DILLENBURGER is an architect and programmer with a focus on computational design in architecture. He is currently based at the CAAD group at the Swiss Federal Institute of Technology's Architecture Department in Zurich. He holds a Master of Advanced Study degree from ETH Zurich and a Master of Architecture degree from the Technical University of Kaiserslautern. Benjamin is also member of the spin-off company KAISERSROT, an interdisciplinary consulting and design team exploring the potential of information technology for architecture and urban planning.

ENRICO DINI graduated in Civil Engineering from the University of Pisa, and has spent most of his career on the implementation of robotic automation of shoe manufacturing. During these years, Enrico came across rapid prototyping technology, which he made his sole focus from 2004 onwards. Since then, he has developed a large-scale 3D printer using inorganic binders. In 2008, his first large-scale 300-nozzle 6 × 6 meter 3D printer became operational. His technology has been used since then to make 3D print sculptures and architectural mock-ups. Recently, he has been working on a 'maritime' printer suitable for printing artificial reefs for coastal protection.

JORGE DURO-ROYO, born in Barcelona, graduated as an architect from the Polytechnic University of Catalonia School of Architecture and as a mechanical engineer from the Polytechnic University of Catalonia School of Industrial and Aeronautic Engineering, where he graduated with honours.

In 2006, he spent a year in Paris on an Erasmus Scholarship at the École Nationale Supérieure Paris-La Villette. From 2009 to 2010, he co-taught Introduction to Parametric Architecture for 4th and 5th year students with the Coda Group. In 2010, he attended the master's degree programme in Advanced Design and Digital Architecture at the Pompeu Fabra University. In 2010–11, he completed a master's degree in Architecture, Energy and Environment at UPC-ETSAB. He has worked in Europe in international offices such as Dominique Perrault DPA and Duro Architecture and Engineering. Jorge co-founded DumoLab in 2008, a young architecture, engineering and research studio that focuses on experimental design, data management in architecture, innovative material systems and programming of new design tools. He has spent the last two years in Cambridge MA, collaborating with MIT professors on multiple innovative research subjects. In 2013, he joined the Mediated Matter Research Group as a Research Assistant.

DAMIAN ELEY led the design of the superstructure on the Leadenhall Building since its inception. An Associate Director with 20 years' experience in Arup's London office, Damian works closely and creatively with architects and the rest of the design team to create exceptional designs. He has a particular passion for pursuing the clear and elegant expression of structural behaviour in his design work, and his portfolio of projects includes Osaka Maritime Museum in Japan, Incheon Airport in Korea and, in London, the exclusive One Hyde Park development, the 'flying carpets' at Unilever House and the 'beacon' at Plantation Place.

GUSTAV FAGERSTRÖM is a registered architect and Associate with Buro Happold New York, where he leads the structural BIM and advanced modelling team. Specializing in design computation, automation and building information modelling, he has developed his knowledge in all project phases from concept to construction. His work focuses on the areas of intersection of architecture, engineering and computer science and deals with the optimisation and automation of design processes by means of novel techniques in computational modelling, analysis and programming. He has practised architecture with Urban Future Organization and with Kohn Pedersen Fox Associates in the UK and with UNStudio in the Netherlands, gaining experience of projects in over 10 different countries. Work by him has been exhibited and published in Europe, America and Asia as well as presented at the Venice Architecture Biennale, CAADRRIA, ACADIA and the Smartgeometry conference. Frequently engaging with academia, he has sat on design juries, given workshops and lectures at UPenn, Yale, the AA London, UCL Bartlett, the Royal Institute of Technology and the Royal Academy of Fine Arts in Stockholm.

JELLE FERINGA is co-founder of EZCT Architecture and Design Research. Some works by the office are in the collection of the FRAC Centre as well as the permanent architectural collection of the Centre Pompidou. EZCT participated at the 2004 and 2013 editions of Archilab. In 2007, the office won the Seroussi competition. While working on his PhD thesis, Jelle established the Hyperbody Robotics Lab in late 2011. In spring 2012, he co-founded Odico Formworks Robotics, based on the offline robotics programming platform PyRAPID that lies at the heart of the business. With Thomas Paviot, he has been driving the development of an open-source CAD framework, PythonOCC, a CAD/CAE/PLM rapid prototyping framework for the Python programming language.

LUIS E. FRAGUADA investigates critical issues in architecture, design, and urbanism through various modes, including associative design, scripting, and fabrication. Luis is currently a member of the Faculty of Architecture at IaaC as the principal computation instructor, focusing on the interface between computational processes and fabrication. Luis joined Built By

Associative Data, an architecture and research studio, as an associate and the Director of the Barcelona office in 2010. He currently leads Built by Associative Data Research – the research component of the office which focuses on creating tools and processes to push the computational capabilities of the team as well as expand the project focus of the office into areas such as gastronomy and fashion design.

NEIL GERSHENFELD is Professor and Director of MIT's Center for Bits and Atoms. His unique laboratory is breaking down boundaries between the digital and physical worlds, from creating molecular quantum computers to virtuosic musical instruments. Technology from his lab has been seen and used in settings including New York's Museum of Modern Art and rural Indian villages, the White House and the World Economic Forum, inner-city community centers and automobile safety systems, Las Vegas shows and Sami herds. He is the author of numerous technical publications, patents, and books including *Fab*, *When Things Start To Think*, *The Nature of Mathematical Modeling*, and *The Physics of Information Technology*, and has been featured in media such as *The New York Times*, *The Economist*, and *The McNeil/Lehrer NewsHour*. He is a Fellow of the American Physical Society, has been named one of Scientific American's 50 leaders in science and technology, as one of 40 Modern-Day Leonardos by the Museum of Science and Industry, has been selected as a CNN/Time/Fortune Principal Voice, and by *Prospect/Foreign Policy* as one of the top 100 public intellectuals. Neil has a BA in Physics with High Honors from Swarthmore College, a PhD in Applied Physics from Cornell University, honorary doctorates from Swarthmore College and Strathclyde University and was a Junior Fellow of the Harvard University Society of Fellows, and a member of the research staff at Bell Labs.

HOLLIE GIBBONS studied architecture at the Royal Danish Academy of Fine Arts, School of Architecture, specialising in design and industrial form. Hollie was awarded an MA in Architecture in 2012. She also holds a BA (Hons) in Architecture from Kingston University, London. After graduating, Hollie joined CITA as Research Assistant. She has worked on a number of CITA research projects with a focus on design and fabrication, including the large-scale installation *The Rise for the ALIVE* exhibition at the EDF Foundation, Paris, France, in 2013. Hollie is also engaged in teaching for the master's programme, CITAstudio: Computation in Architecture.

RUAIRI GLYNN practices as an installation artist and architectural researcher. He has exhibited his work internationally, most recently at the Tate Modern London, the Centre Pompidou Paris, and the National Art Museum Beijing. He is co-founder of the FABRICATE Conference with Prof. Bob Sheil and co-chair of its steering committee. He is Lecturer in Interactive Architecture at the Bartlett School of Architecture (UCL), and teaches on both the master's programmes MArch Graduate Architectural Design (RC3) & MSc Adaptive Architecture and Computation. Study across both his courses is based on a design through 'making' methodology, with an emphasis on using and misusing digital and material technologies. The studio builds and tests at a 1:1 scale, experimental objects and interactive installations that uncover new design opportunities to sense and respond to the natural and built environment, to people and other living things, and to data both local and global. This work is done in collaboration with his Associate Lectureship on the master's programme *Textile Futures* at Central Saint Martins, University of Arts London.

CARLOS DAVID GONZALEZ URIBE was born in Mexico City. He received his undergraduate degree in architecture from ITESM in Mexico City in 2008 and a master's degree in Architecture and Urban Design from Pratt Institute in 2011, where he was honoured with the Pratt Circle Award and for

Outstanding Academic Achievement. In 2010, he was also awarded a Fellowship by the Mexican Science Foundation (CONACYT). After graduation, he worked as an intern in the research and development department of Bentley's Generative Components Department and served as a media consultant at the University of Pennsylvania with Prof. Ferda Kolatan. In 2011, he collaborated with the firm *su11* in the Corallines Project, which was on exhibit at the Istanbul Design Biennial. Currently, Carlos is a Research Assistant at the Mediated Matter Group at MIT.

FABIO GRAMAZIO and **MATTHIAS KOHLER** are architects with multidisciplinary interests ranging from computational design, robotic control and fabrication to material innovation. In 2000, they founded the architecture practice Gramazio & Kohler, where numerous award-winning designs have been realised, integrating novel architectural designs into a contemporary building culture. Built work ranges from international exhibitions, private and public buildings to large-scale urban interventions. Opening also the world's first architectural robotic laboratory at ETH Zurich, Gramazio & Kohler's research has been formative for the field of digital architecture, setting precedence and de facto creating a new research field merging advanced architectural design and additive fabrication processes through the customized use of industrial robots. This ranges from 1:1 prototypical installations to robotic fabrication on a large scale, which is being explored at the SEC Future Cities Laboratory. Fabio and Matthias were awarded the Swiss Art Awards, the Global Holcim Innovation Prize and the ACADIA Award for Emerging Digital Practice. Their innovative explorations have contributed to numerous exhibitions around the world, such as the 2008 Architectural Biennial in Venice, the Storefront Gallery for Art and Architecture in New York 2009 or *Flight Assembled Architecture* at the FRAC Centre Orléans in 2011. Their work has been published in a large number of journals, books and mass media, and has been first documented in the book *Digital Materiality in Architecture* in 2008. Their recent research is outlined and theoretically framed in the book *The Robotic Touch – How Robots Change Architecture*, released in 2014. Together with leading researchers in architecture, material sciences, computation and robotics, they have just launched the first architectural National Centre of Competence in Research on Digital Fabrication.

GEORG GRASSER studied architecture at the University of Innsbruck, Ecole d'Architecture de Paris-La Villette, Vienna University of Technology and holds a postgraduate degree in architecture, with a specialisation in computer-aided architectural design from ETH Zurich. He has taught seminars and workshops in Kosovo and Taiwan and has worked for various architectural offices in Austria, France and China. Since 2009, he has been teaching and researching parametric modelling, script-based design processes and computational fabrication strategies at the Department for Experimental Architecture, Hochbau at TU Innsbruck. In 2013, he was one of the cluster champions of the Robotic FOAMing workshop at the Smartgeometry conference in London. He is currently co-running the university's robotic laboratory.

NORMAN HACK received his Diploma in Architecture from the Technical University of Vienna. A scholarship from the German Academic Exchange Organization (DAAD) allowed him to pursue a postgraduate degree at the Architectural Association in London, from which he graduated with distinction. Norman gained professional experience in renowned offices across Europe, including Coop Himmelb(l)au, UNStudio and Herzog & de Meuron, where he worked as a specialist in computational design and fabrication. His PhD research at the Chair of Architecture and Digital Fabrication at ETH Zurich focuses on material processes for non-standard constructive assemblies.

MICHAEL HANSMEYER is an architect and programmer who explores the use of algorithms and computation to generate architectural form. He is currently based in the CAAD group at ETH Zurich. Recent projects include Platonic Solids and Subdivided Columns. He holds a Master of Architecture degree from Columbia University and an MBA from INSEAD Fontainebleau. He previously worked in the consulting and financial industries at McKinsey & Company and J.P. Morgan, respectively, as well as at Herzog & de Meuron architects.

ALEX HAW is Director of the award-winning UK art/architecture practice *atmos*. Their projects span the scale from algorithmic master plans to data-generated furniture, merge sculptural ergonomics with innovative fabrication technologies and digital mapping, and seek a synthesis of mind and body – creating kinaesthetic experiences that are both meaningful and pleasurable. Alex graduated with a Fulbright scholarship from Princeton and a First from the Bartlett, and has taught Master's Studios at the Architectural Association, the Royal College of Art and TU Vienna. He runs the Latitudinal Cuisine community, writes widely, and played the lead psycho in Chris Nolan's first feature film *Following*.

CLEMENS HUBER is a structural engineer and a graduate of the University of Applied Sciences for Construction Management and Engineering in Graz. He started his professional career as a project manager at the renowned Austrian Glulam specialist Wiehag. Later, he changed to the design and engineering department as Assistant Director. A recent project of interest was awarded the prize Achievement in Engineered Timber in 2009 by Timber Trade Journal for the timber roof of the University of Reading's new business school, where he was responsible for the structural design. Currently, he is Design Manager for the contractor design of the Canary Wharf Crossrail Station timber roof.

RYAN LUKE JOHNS is a research specialist at the Princeton University School of Architecture and co-founder of GREYSHED, a design-research collaborative focused on robotic fabrication in art, architecture and industrial design. He holds a Bachelor of Arts degree in Architecture with a concentration in mathematics from Columbia University (2009) and a Master of Architecture from Princeton University (2013). He was recently the recipient of Princeton University's Suzanne Kolarik Underwood Prize for Design Excellence (2013) and the KUKA Young Potential Award for Best Scientific Paper at RoblArch 2012.

SAŠA JOKIĆ is a researcher and inventor in the field of robotics in architecture and the construction industry. He studied at the Faculty of Architecture in Belgrade, where he earned a master's degree in architecture in 2010. After graduation, he worked as assistant teacher at the Chair for Architecture at Belgrade University. In 2012, he graduated from the Institute for Advanced Architecture of Catalonia specialising in digital tectonics. During his studies, Saša also gained experience in design at UNStudio in Amsterdam. Currently, he is working as a Senior Researcher at IaaC, where he leads several research projects for the Open Thesis Fabrication course.

AMMAR KALO recently received a Master in Science in Architecture with a concentration in Digital Technologies from the University of Michigan Taubman College of Architecture and Urban Planning (2013). Prior to pursuing his post-professional studies, he has held professional posts in architecture and design in Dubai and worked on international projects of various scales. At Taubman College, his work focused on digital fabrication and computational design methodologies. His current research interests include synthesizing conventional materials and digital technologies into hybrid material systems. Ammar holds a bachelor's degree in Architecture from the American University of Sharjah (2008).

MARKUS KAYSER studied 3D Furniture and Product Design at London Metropolitan University and continued on in 2009 with the study of Product Design at the Royal College of Art. Currently, Markus is a PhD candidate at the MIT Media Lab, where he has joined the Mediated Matter Group. Before joining the group, he started his own studio, engaging in discussions about opportunities in the production of design involving new as well as forgotten processes and technologies. Now, as then, his research draws on science, art and engineering and aims to blur the gaps between seemingly separate fields. Experimentation plays a central part in developing his research. Markus's recent work demonstrates the exploration of hybrid solutions linking technology and natural energy to show opportunities, question current methodologies in manufacturing and test new scenarios of production. His work has been widely publicised around the world in exhibitions, broadcasting and web-based media.

OLIVER DAVID KRIEG is a doctoral candidate at the Institute for Computational Design at the University of Stuttgart. With the completion of his Diploma thesis in 2012, he also received the faculty's Diploma Prize. Prior to that, he worked as a Graduate Assistant at the Institute's robotic prototype laboratory, RoboLab, from the beginning of 2010. With a profound interest in computational design processes and digital fabrication in architecture, he has participated in several award-winning and internationally published projects. In the context of computational design, his research aims to investigate the architectural potential of robotic fabrication in wood constructions.

DIRK KROLIKOWSKI has been the architect and associate in charge of the design, development and delivery of the unique external structure (the Megaframe) of the Leadenhall Building, a 51-storey office development in the city of London. Dirk also heads the Digital Research Cluster of Rogers Stirk Harbour + Partners and led the implementation of advanced modelling strategies for Leadenhall, an award-winning project that has received international recognition for its integrated use of digital technology. In 2011, Dirk was appointed Lecturer for Innovative Technology and Design at the Bartlett School of Architecture (UCL).

JORIS LAARMAN is a Dutch designer, artist and entrepreneur best known for experimental designs inspired by upcoming technology. He attended the Design Academy Eindhoven in 1998 and graduated cum laude in 2003. He founded Joris Laarman Lab together with his partner Anita Star. His critically acclaimed work has been added to the permanent collections of many renowned international museums such as MoMA in New York, V&A in London, Centre Pompidou in Paris and the Rijksmuseum in Amsterdam. He has contributed articles and seminars for *Domus* magazine and was a guest teacher at European universities such as the Architectural Association London, Rietveld Academy Amsterdam and the Design Academy Eindhoven. In 2011 he received one of the eight Innovators of the Year awards by the *Wall Street Journal*.

SILKE LANGENBERG is a senior researcher at the Chair of Architecture and Digital Fabrication, Institute of Technology in Architecture at ETH Zurich. Between 2011 and 2013 she was based in Singapore several times to research at the Singapore ETH Centre for Global Environmental Sustainability. From 2006 to 2011 she was Researcher at the Institute of Historic Building Research and Conservation of ETH Zurich. Silke has studied architecture at the Universities of Dortmund and Venice. She received a Scholarship for extraordinary achievements for her PhD in Engineering Sciences about *Buildings of the Boom Years. Architectural Concepts and Planning Theories of the 60s and 70s* (finished 2006). In 2013, Silke was appointed as Full Professor for Design and Construction in Existing Contexts, Conservation and Building Research at the University of Applied Sciences in Munich.

JARED LAUCKS is a trained maker, architect, designer and fabrication specialist. He is currently a Research Assistant in the Mediated Matter Group at the MIT Media Lab, where he is interested in developing novel methods of digital fabrication for design research. Jared graduated from Philadelphia University with a bachelor's degree in Architecture, focused on digital technologies. As an extension of this research, he launched *j_laucks*; initially a platform for experimental design and fabrication, it has since grown into a multifaceted research agenda exploring avenues from architecture and design to computation, material systems, and fabrication. In parallel to working as an architect, he was appointed Adjunct Professor at Philadelphia University, developing a new advanced modelling curriculum. Jared has exhibited work in cities across the globe, including Philadelphia, Berlin, Frankfurt, NYC, Valparaiso, Lyon, Paris, Miami, Sao Paulo, London and Munich.

WILLI VIKTOR LAUER is a research assistant at the Future Cities Laboratory, Singapore ETH Centre for Global Environmental Sustainability, Module II Architecture and Digital Fabrication, led by Fabio Gramazio and Matthias Kohler, where he has implemented a research facility for investigating robotic fabrication methods for high-rise buildings. Between 2009 and 2011, he worked as a Scientific Assistant at the Chair of Building Realization and Robotics at the Technical University of Munich, where he gained in-depth knowledge of the young history of robotic construction technologies and the forerunners in building industrialization. In the context of his master's thesis in 2009, he reconstructed the first architectural robotic arm: the Location Orientation Manipulator by Konrad Wachsmann.

DIETER LINKE is experienced in development and inventions for membrane structures and their details, merging architectural and pragmatic requirements. Following his carpentry apprenticeship, he was awarded a Civil Engineering Diploma from the Munich Technical University in 1991. Key projects are Mina Tent City (PTFE, Medinah), Masoala Rainforest Hall (ETFE cushions, Zurich), AWD Arena (single layer ETFE, Hanover), Allianz Arena (ETFE cushions, Munich), National Stadium (Birdnest, single layer ETFE, Beijing), Sports and Concert Complex, (plane PVC, Baku). Further, the benefits of using ETFE film in modern greenhouse culture and sustainable energy technologies currently hold his interest.

MARTA MALÉ-ALEMANY is an architect, researcher, and educator from Barcelona. Since 1997, she has combined her professional practice with teaching experimental design studios and research seminars in architecture schools from the US (MIT, UPenn, UCLA, SCI-ARC among others) and Europe (AA, IaaC, UIC), in combination with directing several master's degree programmes in architecture. Following many years of exploration in using digital technologies for the production of architecture, her current research agenda focuses on developing innovative material and construction solutions using customised robotic devices, with a particular interest in additive manufacturing for architecture. Marta graduated from ETSAB-UPC (Barcelona) in architecture, holds a master's degree in Advanced Architectural Design from Columbia University (New York), and is currently a PhD candidate at the ETSAB-UPC (Barcelona), investigating the potential of large-scale additive manufacturing technologies to innovate building construction.

ARETI MARKOPOULOU is a Greek architect and educator whose research and practice design explores new architectural models where applications of ICT, energy and fabrication allow built and public space to dynamically adapt to behavioural and environmental changes over time. She holds an MArch by IaaC in the field of 'Prototypes of Urbanity: from Bits to Geography' and a Fab Academy diploma on Digital Fabrication offered by the MIT Center for Bits and Atoms and the Fab Lab Network. She is permanent faculty at IaaC with several published articles internationally. Co-founder of the

Mycity-me nonprofit organization, her practice includes project collaborations with multidisciplinary offices and institutions and she has participated in R + D projects ranging from intelligent cities (such as 'Smart BCN' with City Hall Barcelona, 2013), self-sufficient buildings (such as 'Fab Lab House' at Solar Decathlon Europe, 2010), digital fabrication (such as 'Fabrication Laboratory' at DHUB, 2010) and Internet of things (such as 'Hyperhabitat' at the XI Venice Biennale, 2008). She is currently the Director of the Masters in Advanced Architecture at IaaC in Barcelona and initiator and partner of Fab lab Athens in Greece.

KEVIN MCCLELLAN is a designer, artist and founder of Architecturebureau, a design research office exploring complex systems and their material effects on form. After receiving his master's degree in Architecture and Urbanism from the DRL at the Architectural Association School of Architecture with a Project Distinction in 2005, he subsequently worked in New York for Kevin Kennon and in London with Zaha Hadid Architects. In 2011, he co-founded the UK-based Dsgndot, an online marketplace for the sale of unique and collectable designs.

WES MCGEE is an Assistant Professor in Architecture and Director of the Fab lab at the University of Michigan, Taubman College of Architecture and Urban Planning. As a founding partner and senior designer in the studio Matter Design, his work spans a broad range of scales and materials, always dedicated to re-imagining the role of the designer in the digital era. In 2013, Matter Design was awarded the Architectural League Prize for Young Architects & Designers. Wes has presented his work at many national and international conferences on design and fabrication. He is Chair of the Conference Robotic Fabrication in Architecture, Art, and Design, hosted at the University of Michigan in 2014.

ACHIM MENGES is a registered architect and professor at the University of Stuttgart, where he is the founding director of the Institute for Computational Design (since 2008). In addition, he has been Visiting Professor in Architecture at Harvard University's Graduate School of Design (2009–10), at the AA School of Architecture in London (2009–current) and at Rice University in Houston (2004). Achim Menges graduated with honours from the AA School of Architecture in London (2002), where he subsequently taught as Studio Master of the Emergent Technologies and Design Graduate Program (2002–09) and as Unit Master of Diploma Unit 4 (2003–06). Achim's practice and research focuses on the development of integral design processes at the intersection of morphogenetic design computation, biomimetic engineering and computer-aided manufacturing that enables a highly articulated, performative built environment. His work is based on an interdisciplinary approach in collaboration with structural engineers, material scientists and biologists. He has published several books on this work and related fields of design research, and is the author/co-author of numerous articles and scientific papers. His projects and design research have received many international awards, has been published and exhibited worldwide, and form parts of several renowned museum collections.

AMMAR MIRJAN is an architect with a background in automation engineering. He studied at the Berne University of Applied Sciences and at the Bartlett School of Architecture in London. He has worked for different architecture studios in New York, Tokyo and London. In 2011, he joined ETH Zurich, where he is currently pursuing his PhD at the Chair for Architecture and Digital Fabrication. His research focuses generally on the relationship between design and construction with intelligent machines and specifically on architectural fabrication processes with flying robots.

MICHAEL JAKE NEWSUM is the Robotics Lab Coordinator at the Southern California Institute of Architecture. His work currently focuses on the development of computational tools for the integration of design and fabrication through new robotic workflows. He received a Master of Science in Architecture with a concentration in Digital Technologies from the University of Michigan, Taubman College of Architecture and Urban Planning. Additionally, he earned a bachelor's degree in Architecture from the University of Arkansas, Fay Jones School of Architecture.

PETR NOVIKOV holds a master's degree in Architecture from Moscow Architectural Institute and a master's degree in Advanced Architecture from IaaC. Petr is co-inventor of the Stone Spray technology, which was created during a digital tectonics course at IaaC. The project received the Golden Prize of Spark Awards 2012. During the Open Thesis Fabrication program of IaaC in 2012, he and Saša Jokić worked on the new 3D printing technology Mataerial. Petr has given numerous lectures on the use of robotics in architecture. In 2013, he was featured in *ICON* magazine as one of 50 people pushing the boundaries of architecture.

NERI OXMAN is the Sony Corporation Career Development Professor and the Director of the Mediated Matter Research Group at the MIT Media Lab. Her group conducts research at the intersection of computational design, digital fabrication, and materials science, applying that knowledge to design across scales from the micro-scale to the building scale. Neri coined the term 'material ecology' to describe her work, applying the science of ecology to the world of the artificial. A leader in the field of biologically inspired digital fabrication, her research and design work have been acquired for permanent collections and exhibited at the Museum of Modern Art (NY), Centre Georges Pompidou (Paris), the Museum of Fine Arts (Boston), and the Smithsonian Institute, among others. Neri was named in *ICON*'s list of the top 20 most influential architects to shape our future (2009), selected as one of the 100 most creative people by FASTCOMPANY (2009) and awarded the Earth Award (2009), a METROPOLIS Next Generation Award (2009) and the 40 Under 40 Building Design + Construction Award (2012) amongst many others. She publishes and lectures worldwide.

LAURENT PAMBAGUIAN obtained his PhD in Material Science in 1994 from Paris XI University for the work he did at ONERA, the French Aerospace Lab. Over the last 20 years, he has developed expertise in several advanced materials and processes topics, including metal matrix composites for structures, thermal management and lubrication, cellular materials and carbon nanotube-based materials. He joined the Materials Technology Section of ESA in 1999 and for the last eight years has been involved in the development of additive manufacturing technologies for space use.

BRIAN PETERS is an architect and designer who specialises in emergent design and fabrication techniques. He received a Master's of Architecture from the University of Illinois at Chicago and worked for several years as an architect in Chicago. In 2009, Brian moved to Barcelona, where he received a Master of Advanced Architecture with an emphasis on digital tectonics from the Institute of Advanced Architecture in Catalonia. More recently, Brian was based in Amsterdam, where he started several projects investigating the role of 3D printing in architecture, including Building Bytes and the KamerMaker with DUS Architects. As of the fall of 2013, Brian is teaching and conducting research at Kent State University in the College of Architecture and Environmental Design.

DAVE PIGRAM is a designer, researcher and educator and holds a Master of Science in Advanced Architecture from Columbia University. As co-director of the international, award-winning architecture and innovation practice supermanoeuvre, his research focuses on the use of computation to increase the number and quality of feedback loops between design and fabrication. Dave is currently the Director of the Master of Advanced Architecture programme at the University of Technology, Sydney (UTS) and co-directs research into robotic fabrication at the University of Michigan and is a Research Affiliate at MIT's Media Lab.

JORDI PORTELL is a practising registered architect who has become increasingly dedicated to research as a result of being a master's level student, and later a faculty assistant at the FABbots Research Studio directed by Marta Malé-Aleman. He holds a professional degree in architecture from the ETSAB UPC-Barcelona and a Master's in Advanced Architecture from the IaaC Barcelona. His research is focused on the application of additive manufacturing techniques in architecture, with a special interest in multi-material systems and complex material networks.

JONATHAN RABAGLIATI is an artist whose field of practice extends across architecture, art, design and curation. He is one of the longest-serving members of the Specialist Modelling Group at Foster + Partners. Recent projects include the design and delivery of Canary Wharf Crossrail Station roof, a hypotrochoidal staircase for Bloomberg and defining geometry for the National Bank of Kuwait tower. He engages primarily through sculpting with code, and wrestling with design systems to seek out simplicity, the other side of complexity. In the interstices, he regularly collaborates with Julie Kim, where graphic design meets in a critical dialogue with conceptual art and computational experimentation.

METTE RAMSGAARD THOMSEN is an architect working with digital technologies. Her research centres on the relationship between crafts and technology framed through 'digital crafting' as a way of questioning how computation, code and fabrication challenge architectural thinking and material practices. Mette is a Professor at the Royal Danish Academy of Fine Arts, School of Architecture in Copenhagen, where she heads the Centre for Information Technology and Architecture (CITA).

STEFFEN REICHERT is a research associate and doctoral candidate at the Institute for Computational Design at the University of Stuttgart, Germany. He received a Master of Science in Architecture Studies in the field of design and computation from the Massachusetts Institute of Technology (MIT) and a diploma degree with distinction in product design from the Academy of Arts and Design in Offenbach. His research focuses on the relationship of form, fabrication and performance in responsive, biologically inspired systems based on anisotropic material behaviour.

KATJA RINDERSPACHER is a doctoral candidate at the Institute for Computational Design at the University of Stuttgart and a registered architect. She holds an engineering degree from the Fachhochschule Mainz and a Master of Science in Architecture with honours from Pratt Institute, New York. Her work was distinguished by scholarships (e.g. Fulbright Scholarship, DAAD/German Academic Exchange Service) and awards (e.g. Excellence in Academic Achievement Award). As an architect and project manager, she worked in New York, Switzerland and Germany, including Studio Daniel Libeskind. Her current research involves the integration of geomorphological processes in computational design and digital fabrication for the construction of complex structures.

JEAN ROULIER was trained as joiner, carpenter and wood building engineer. Having accumulated extensive experience in CAD in practice, he co-founded the company Lignocam SA in 2006 in order to develop CAM software for the wood industry. Since then, the homonymous software Lignocam has become the leading CAM software interpreting BTL files. Its objective is the promotion of wood in construction – even the most daring ideas – as well as the realisation of a smooth digital chain in the construction and fabrication process.

VIRGINIA SAN FRATELLO and **RONALD RAEI** are architects, artists and educators. They are partners at Rael San Fratello and in Emerging Objects, which is a pioneering design and research company that specializes in 3D-printed materials and objects for the built environment based in Oakland, California. Ronald is Associate Professor at the University of California Berkeley and Virginia is Assistant Professor in the area of Design at San Jose State University. They both hold Master of Architecture degrees from Columbia University in the City of New York. Their research focuses on the convergence of digital, ecological, and creative material explorations. The research is applied through the design and fabrication of innovative buildings and their components, furniture elements and site-specific installations that often look at inherent material resources and have embedded political consequences. Rael San Fratello was the recipient of Metropolis Magazine's Next Generation Design Award for their Hydro Wall concept, a finalist in the WPA 2.0 design competition and winner of the Van Alen Institute's Life at the Speed of Rail competition. Rael San Fratello was voted one of '10 to watch' by *California Home and Design* magazine. Their work has been published in *Metropolis* magazine, *L'Arca*, *DOMUS*, the *NY Times*, *Interior Design* magazine, the *Praxis Journal of Writing and Building*, *Make* magazine and *MARK* magazine.

JOSE SANCHEZ is an architect/programmer/game developer based in Los Angeles, California. He obtained his licence at Universidad de Chile, in Santiago and his Master in Architecture at the Architectural Association's Design Research Lab, London. He is a partner at Bloom Games, a start-up built upon the BLOOM project, winner of the WONDER SERIES hosted by the City of London for the London 2012 Olympics. He is the director of the Plethora Project, a research-based practice investing in the future of on-line open-source knowledge propagation. The project has over 150 videos and an open-source library of code with over 700,000 completed video sessions since 2011. His background in computational design and digital manufacturing is linked to the practice Biothing, where he has been one of the principal designers in numerous projects and exhibitions since 2009. In 2012 he founded the Plexus talks at the Bartlett School of Architecture, bringing together designers from different disciplines speculating on the role of computational design and new media in the practice of the discipline. Today, he is Assistant Professor at USC School of Architecture in Los Angeles and Co-Chair of ACADIA Conference 2014, to be hosted at USC. His research 'Gamescapes' explores generative interfaces in the form of video games, speculating on modes of intelligence augmentation, combinatorics and open systems as a design medium.

FABIAN SCHEURER is founding partner of designtoproduction and leads the company's office in Zurich. He graduated from the Technical University of Munich with a diploma in computer science and architecture. In 2005, designtoproduction was founded as a research group at ETH to explore the connections between digital design and fabrication. At the end of 2006, designtoproduction teamed up with architect Arnold Walz and became a commercial consulting practice, since then having implemented digital planning and production chains for projects like the Hungerburg-Funicular in Innsbruck (by Zaha Hadid), the Rolex Learning Center in Lausanne

(by SANAA), or the Centre Pompidou in Metz (by Shigeru Ban) among others. Fabian Scheurer has taught as guest lecturer/tutor at the AA in London and the IaaC in Barcelona. Since 2012, he has been a lecturer for Digital Modelling and Production at HTW Chur.

TIM SCHORK is co-director of MESNE Design Studio and a lecturer in the Department of Architecture at Monash Art Design & Architecture (MADA). His integrated design-based practice, research and teaching investigate the relationship between architecture and divergent domains of knowledge through the use of computation in order to create innovative design strategies for novel spatial structure. His work is trans-disciplinary and fosters connections between and across disciplinary domains such as architecture, other art and design disciplines, engineering and science in order to innovate in design, often challenging the operative boundaries as well as formal and conceptual aesthetics of what is regarded as standard architectural practice.

TOBIAS SCHWINN is a research associate and doctoral candidate at the Institute for Computational Design at the University of Stuttgart. His research focuses on the integration of robotic fabrication and computational design processes. Prior to joining the ICD, he worked as a Senior Designer for Skidmore, Owings and Merrill in New York and London applying computational design at various planning stages. Tobias studied architecture at the Bauhaus University in Weimar and at the University of Pennsylvania in Philadelphia as part of the US-EU Joint Consortium for Higher Education. He received his engineering degree in 2005.

MATTHEW SHAW is an architect, maker and educator based in London. His work is driven by the speculative use of digital technologies, the impact these technologies will have on our lives and the way they shape our architecture. Matthew is co-founder of ScanLAB Projects, tutor at the Bartlett School of Architecture, University College London, and Director of Graticule Architecture.

BOB SHEIL is an architect, Professor in Architecture and Design through Production, and Director of Technology at the Bartlett School of Architecture, where he also runs MArch Unit 23 with Emmanuel Vercurysse and Kate Davies. He is a founding partner of sixteen*(makers), whose work in collaboration with Stahlbogen GmbH '55/02' won a RIBA award for design in 2010, and also includes a ten-year catalogue of experimental projects both internationally published and exhibited. He is an educator, critic, researcher, collaborator and practitioner, as well as an experimental designer who is fascinated by transgression between making, craft, and technology, in architectural design practice. As Director of Technology, he has been responsible for the School's significant acceleration of investment in digital technologies, which led to the establishment of the Digital Manufacturing Centre (2009) and more recently, the Bartlett Manufacturing and Design Exchange (B-MADE). In 2011, he chaired the highly acclaimed inaugural conference FABRICATE with Ruairi Glynn.

MIKE SILVER is an architect, researcher and educator. He is currently on the faculty of the Department of Architecture at the University of Buffalo. Mike directs a multidisciplinary design laboratory that explores emerging technologies such as humanoid robotics, automated fibre placement and mobile design apps for on-site construction. His work has been exhibited at the New Museum of Contemporary Art in New York, the International Design Center Nagoya, the National Building Museum in Washington, DC, the Architecture League in New York and the Cooper-Hewitt National Design Museum, also in New York. He built his first working robot out of Scotch tape and spirograph parts at the age of 12.

ASBJØRN SØNDERGAARD is an architectural researcher working in the field of digital fabrication in relation to architectural design. He is coordinator of Digital Experimentation at the Aarhus School of Architecture, Chief Development Officer and founding partner of Odico Formwork Robotics, a high-technology enterprise framing architectural design experimentation and fabrication in the field of industrial robotics. As the academic project manager of several interdisciplinary research projects, he heads investigations into structural design and architectural robotics. His doctoral research focuses on morphogenetic processes and the development of novel structural logics in relation to numerical fabrication techniques.

DAVID STASIUK is an architect and PhD Fellow at the Centre for Information Technology and Architecture in Copenhagen. His research investigating development strategies for emergent parameterisation is a component of the Centre's larger, multi-pronged Complex Modelling project. His own work is focused on investigating the development of emergent parameter spaces through the integration of simulation systems with topological transformation. His professional work has focused on bespoke detailing for advanced architectural geometries, computational design implementation, and the use of digital fabrication and documentation techniques, some of which was presented at the ACADIA 2012 conference.

HANNO STEHLING is consultant for digital fabrication and parametric modelling at the digital fabrication consultancy designtoproduction in Zurich. He graduated with a diploma in architecture from University of Kassel, where he studied under Prof. Manfred Grohmann (Bollinger + Grohmann) and Prof. Frank Stepper (Coop Himmelb(l)au) and is Dipl.-Ing. Architekt SIA. He has a strong background in computer programming and gradually focused his studies on the intersection between architecture and computer science. He worked as a freelance programmer and as computational designer for renowned architects such as Bernhard Franken before joining designtoproduction in 2009. Hanno Stehling is co-founder of the online platform RhinoScript.org and gives modelling and scripting classes to both academic and professional audiences.

KASPER STOY is a robotics and embodied artificial intelligence researcher holding an Associate Professor position at the Software and Systems Section of the IT University of Copenhagen. He has published more than sixty papers in international conference proceedings or journals and is the author of *Self-Reconfigurable Robots: an Introduction*, published by MIT Press. He holds an MSc degree in computer science and physics from the University of Aarhus, Denmark (1999) and a PhD in computer system engineering from the University of Southern Denmark (2003), where he also worked as Assistant Professor (2003–6) and Associate Professor (2006–13).

MARTIN TAMKE is an architect pursuing design-led research on the interface and implications of computational design and its materialisation. His special focus is on the methods and consequences of digital fabrication and the integration of simulation and feedback in the process of architectural design and production. Martin is a founding member and Associate Professor at the Centre for Information Technology and Architecture (CITA) at the Royal Danish Academy of Fine Arts, School of Architecture in Copenhagen.

KADRI TAMRE is an architect, currently working as a Teaching and Research Associate at the Institute for Experimental Architecture, Hochbau at the University of Innsbruck. She holds a master's degree in Architecture from the University of Applied Arts Vienna / Studio Wolf D. Prix and has working experience in architectural practices in Austria, Estonia, Spain and China, receiving several awards and scholarships. She has been teaching various international parametric design and robotic fabrication workshops. Her

current research focuses on the development of novel interface and material processes and she is co-running the University of Innsbruck's robotic laboratory.

LAVENDER TESSMER is a designer, fabricator and musician. Currently a lecturer at Washington University of St. Louis, she is teaching courses in architectural representation and digital fabrication. Since 2010, Lavender has worked with Yogiama Tracy Design (yo_cy) on a variety of installations and residential and commercial projects. Her specialisations include parametric design, steel fabrication, connection design, visualisation and material testing. As a recent graduate of Washington University in St. Louis, she received the 2011 Laskey Award, a Fall 2011 Degree Project Award, and was nominated for the Frederick Widmann Prize in Architecture.

SKYLAR TIBBITS is a trained architect and computer scientist whose research focuses on self-assembly technologies for industrial applications in a built environment. Skylar was recently awarded a 2013 Architectural League Prize, the Next Idea Award at Ars Electronica 2013, the Visionary Innovation Award at the Manufacturing Leadership Summit, a 2012 TED Senior Fellowship and was named a Revolutionary Mind in *SEED* magazine's 2008 Design Issue. He has designed and built large-scale installations around the world and exhibited at the Guggenheim Museum NY, the Beijing Biennale and lectured at MoMA and SEED Media Group's MINDo8 Conference. Skylar is the Director of the Self-Assembly Lab at MIT and the founder of a multidisciplinary research-based practice, SJET LLC. Skylar is also on the faculty of MIT's Department of Architecture, teaching master's and undergraduate-level Design Studios and co-teaching How to Make (Almost) Anything at MIT's Media Lab.

KENNETH TRACY teaches architectural design at the American University of Sharjah, United Arab Emirates, where he is an Assistant Professor of Architecture. Kenneth has taught at the Pratt Institute, Columbia University, the New Jersey Institute of Technology, and Washington University, where he established the Digital Initiative Fabrication Research Lab in 2009. He holds a master's degree in Architecture from Columbia University and a bachelor's degree in Design from the University of Florida. In 2005, he co-founded Associated Fabrication, a digital fabrication shop in Brooklyn, New York. Currently, Kenneth co-directs Yogiama Tracy Design, whose research includes designs, lectures and writing related to digital techniques and culturally resonant craft practices.

WILLIAM TROSSELL graduated from the Bartlett School of Architecture, University College London, in 2009. Since completing a master's degree in Architecture, he has created structures, sculptures and events that draw on an extensive understanding of digital fabrication. Will is co-founder of ScanLAB Projects and tutor at the Bartlett School of Architecture.

ERIK VERBOON is an Associate with Buro Happold New York, drawing upon more than seven years' experience developing computational solutions to advance the Buro's Complex Building Envelope Design practice. His research areas include parametric modelling, object-oriented methodologies, performance- and algorithmic-driven design, environmental and thermal analysis, and rapid prototyping (3D printing). Erik collaborated on the winning entry to the 2007 PS1 Young Architects Program. He has also presented at numerous academic institutions and professional conferences and published in accompanying journals and books. A graduate of the Stevens Institute of Technology's Product Architecture Lab in Hoboken, NJ, he teaches courses there in environmental analysis and design.

ANDREW VRANA is a Principal Architect at Metalab, based in Houston, which integrates expertise in digital media and fabrication with architecture, product development and civic art, from concept through construction. Recent projects include collaborations with artists for turnkey designs and CMservices, including development, optimisation and installation of large-scale civic art. Metalab's product design work has successfully incubated and launched several businesses and product lines through its partnerships. As Assistant Professor at the University of Houston's College of Architecture, Andrew has co-taught the Digital Fabrication seminar since 2005, which has realised numerous award-winning and published works.

ALLISON WEILER is currently working as a Teaching and Research Associate at the Institute for Experimental Architecture, Hochbau at the University of Innsbruck. She also works with LAAC Architekten/Austria in the realm of sustainable Alpine infrastructure development, as well as collaborating with [uto]. She graduated with honours from the University of Pennsylvania, and holds a master's degree in Architecture. Her current research focuses on the development of novel interface and material processes, and she is currently pursuing this work with the REX|LAB, an experimental architectural robotics lab based in Innsbruck.

CHRISTINE YOGIAMAN is an Assistant Professor at the American University of Sharjah in the United Arab Emirates, where she teaches architectural design. Integrating digital technologies into all levels of architecture design education, Christine has coordinated the Graduate Core Studio sequence in conjunction with her development of a digital curriculum in Washington University in St Louis. She directs Yogi Aman Tracy Design, whose current projects in Indonesia focus on the utilisation of digital techniques along with contextual influences to create culturally embedded, affective work. She received third place for the 2012 Steedman Fellowship in International Design, and has won the 2012 TEX-FAB APPLIED: Research through Fabrication competition.

Fabricate 2014

Editors: Fabio Gramazio, Matthias Kohler, Silke Langenberg

This open access edition published in 2017 by
UCL Press by agreement with gta Verlag.
University College London
Gower Street
London WC1E 6BT

Available to download free: www.ucl.ac.uk/ucl-press

This book was originally published in 2014 by
gta Verlag
ETH Zurich
Stefano-Francini-Platz 5
8093 Zurich
Switzerland
<https://verlag.gta.arch.ethz.ch>

gta Verlag are duly acknowledged for the editing, proofreading and design of this publication.

This publication is based on peer-reviewed papers, contributed to the FABRICATE
conference 2014 at ETH Zurich.

Conference Chairs: Fabio Gramazio, Matthias Kohler

Conference Co-Chairs: Bob Sheil, Ruairi Glynn

EDITORS OF PUBLICATION

Fabio Gramazio, Matthias Kohler, Silke Langenberg

ASSISTANCE TO EDITORS

Orkun Kasap, Marilena Skavara

COPY-EDITING

Beverly Zumbühl, Zurich

PROOF READING

Michael Robertson. Augsburg

GRAPHIC DESIGN

Oliver Schmid, Osch Design, Zurich

PRINTING

rva, Druck und Medien AG, Altstätten, SG

BINDING

Schumacher AG, Schmitten, FR

FONTS

Matrix II and Futura (cover)

© 2014 gta Verlag, ETH Zurich, 8093 Zurich, Switzerland

A CIP catalogue record for this book is available from The British Library.

This book is published under a Creative Commons Attribution Non-commercial
Non-derivative 4.0 International license (CC BY-NC-ND 4.0). This license allows you
to share, copy, distribute and transmit the work for personal and non-commercial use
providing author and publisher attribution is clearly stated. Attribution should include
the following information:

Fabio Gramazio, Matthias Kohler, Silke Langenberg (eds.), *Fabricate*. London, UCL
Press, 2017. <https://doi.org/10.14324/111.9781787352148>

Further details about Creative Commons licenses are available at creativecommons.org/licenses.

ISBN: 9781787352148 (PDF)

DOI: <https://doi.org/10.14324/111.9781787352148>

FABRICATE IS AN INTERNATIONAL PEER REVIEWED CONFERENCE THAT TAKES PLACE EVERY THREE YEARS WITH A SUPPORTING PUBLICATION ON THE THEME OF DIGITAL FABRICATION. DISCUSSING THE PROGRESSIVE INTEGRATION OF DIGITAL DESIGN WITH MANUFACTURING PROCESSES, AND ITS IMPACT ON DESIGN AND MAKING IN THE 21ST CENTURY, FABRICATE BRINGS TOGETHER PIONEERS IN DESIGN AND MAKING WITHIN ARCHITECTURE, CONSTRUCTION, ENGINEERING, MANUFACTURING, MATERIALS TECHNOLOGY AND COMPUTATION. DISCUSSION ON KEY THEMES INCLUDES: HOW DIGITAL FABRICATION TECHNOLOGIES ARE ENABLING NEW CREATIVE AND CONSTRUCTION OPPORTUNITIES FROM COMPONENT TO BUILDING SCALES, THE DIFFICULT GAP THAT EXISTS BETWEEN DIGITAL MODELLING AND ITS REALISATION, MATERIAL PERFORMANCE AND MANIPULATION, OFF-SITE AND ON-SITE CONSTRUCTION, INTERDISCIPLINARY EDUCATION, ECONOMIC AND SUSTAINABLE CONTEXTS. FABRICATE FEATURES CUTTING-EDGE BUILT WORK FROM BOTH ACADEMIA AND PRACTICE, MAKING IT A UNIQUE EVENT THAT ATTRACTS DELEGATES FROM ALL OVER THE WORLD.