

**UTS ePRESS**

University of Technology Sydney  
Broadway NSW 2007 AUSTRALIA  
[utsepress.lib.uts.edu.au](http://utsepress.lib.uts.edu.au)

**Copyright Information**

This eBook is copyright. The work is licensed under a Creative Commons Attribution-Non Commercial License CC BY-NC



<https://creativecommons.org/licenses/by-nc/4.0/>

**First Published 2019**

© 2019 the authors of each work in this collection.

**Publication Details**

DOI citation: <https://doi.org/10.5130/acis2018>

ISBN: 978-0-6481242-4-5  
(eBook)

**Peer Review**

Contributions were independently, double blind, peer reviewed on the basis of the full paper, prior to publication.

**Declaration of conflicting interest**

The editors declare no potential conflicts of interest with respect to the research, authorship, and/or publication of this book.

**Funding**

The editors received no dedicated financial support for the research and publication of this book.

**UTS ePRESS**

Manager: Scott Abbott  
Books Editor: Matthew Noble  
Enquiries: [utsepress@uts.edu.au](mailto:utsepress@uts.edu.au)

For enquiries about third party copyright material reproduced in this work, please contact UTS ePRESS.

**OPEN ACCESS**

UTS ePRESS publishes peer reviewed books, journals and conference proceedings and is the leading publisher of peer reviewed open access journals in Australasia. All UTS ePRESS online content is free to access and read.



## **ACIS 2018**

### **Conference Theme: Strategic Positioning**

Within the current global context, resilience is a key driver for various facets of decision-making processes. Information systems have a critical role to facilitate such processes. Indeed, information system researchers have pioneered many of the conceptual tools that this vantage point of decision making demands. This thematic view of IS will offer IS researchers to position and present their efforts not only more cohesively but also will provide a platform to focus on the impact of IS research to solve ongoing societal challenges. These include a focus on organisational resilience and sustainability encompassing risk assessment, cyber threats mitigation, the role of big data, disaster management, and environmental modelling.

### **Conference Tracks**

[Organisational Resilience and Disruption](#)

[Digital Business Innovation](#)

[Emerging Technologies and the IoT](#)

[Social Impact, Diversity, and Inclusion](#)

[Information and Knowledge Management](#)

[Business Analytics and Big Data](#)

[IS in Healthcare](#)

[Design and Design Science \(including HCI\)](#)

[Agile, Project Management, and IS Development](#)

[IS Education, Training, and Learning Technologies](#)

[IS Philosophy and Research Methods](#)

[Social Media](#)

[IS Security Management and Privacy](#)

[General](#)

### **Submission Types**

[Full Research Papers](#)

[Research-In-Progress Papers](#)

**Conference Co-Chairs**

Prof Iwona Miliszewska (University Technology Sydney)  
Emeritus Prof Graham Low (UNSW Sydney)  
Prof Ghassan Beydoun (University Technology Sydney)

**Program Chairs**

Prof Rosemary Stockdale (Swinburne University of Technology)  
A/Prof Khin Than Win (University of Wollongong)  
Prof Vijayan Sugumaran (Oakland University)

**Organising Chairs**

Dr Rosemary Van Der Meer (Deakin University)  
Nick Ketley (University Technology Sydney)

# Distributed Participatory Design in Crowdsourced Information Systems Development

## **Karlheinz Kautz**

School of Business IT and Logistics  
RMIT University  
Melbourne, Australia  
Email: karlheinz.kautz@rmit.edu.au

## **Gro Bjerknes**

Faculty of IT  
Monash University  
Melbourne, Australia  
Email: gro.bjerknes@monash.edu

## **Julie Fisher**

Melbourne, Australia  
Email: j.fisher@bigpond.net.au

## **Tomas Jensen**

Communication, Knowledge & Change  
(Formerly United Nations Children's Fund)  
Cairns, Australia  
Email: tjensenconsulting@gmail.com

## **Abstract**

Distributed participatory design (DPD) is an approach to information systems development (ISD) where different stakeholders participate in the development and design of information systems in distributed design teams which are mostly online on Internet, web-based, and social media platforms. User participation in online DPD projects is primarily voluntary and the participants are typically unaffiliated with the development organisation. Going beyond individual methods, techniques, and practices and to extend research on participatory approaches to ISD beyond conventional settings, roles and types of participants, we are interested in how DPD projects in crowdsourced ISD are managed and performed in their entirety. To answer this research question we studied a case of DPD in crowdsourced ISD in the context of a DPD project which engaged Pacific Youth in the development of a digital game. As contemporary ISD is generally acknowledged as a complex activity we apply complex adaptive systems (CAS) theory to better understand and make recommendations for ISD practice.

**Keywords** Distributed participatory Design, Crowdsourced ISD, Complex Adaptive Systems Theory

## 1 Introduction

Participatory design (PD) is an information systems development (ISD) and design approach. Its central tenet is the participation of people in the co-design of the information systems and technologies (IS/IT) that they are supposed to use themselves (Kensing and Blomberg 1998). It sees users as equal design partners effectively harnessing the enthusiasm and creativity of people to generate design visions and to improve design (Lukyanenko et al. 2016). It originally developed in the 1970s in Scandinavia and focused on user participation in internal organisational settings in the development of dedicated, tailor-made IS/IT, which were to be used in the workplace. Thus most studies of PD examine the development of a single, customised information system that typically supports work flows within a single client organisation (Obendorf et al. 2009).

Recent PD considers non-organisational, community-driven, open contexts (Lukyanenko et al. 2016). Participation by less formally organised communities and the crowd in the development of open source software systems and content producing community-based service systems has challenged existing information system development (ISD) and PD approaches (Öberg et al. 2009; Kazman and Chen 2009; DiSalvo et al. 2013; Lukyanenko et al. 2016). To cope with these new contexts and forms of work and participation – such as communities and virtual networks – traditional PD expanded to deal with the diversification of stakeholders and with settings where stakeholders are distributed across various dimensions of time, space and organisational structures (Obendorf et al. 2009). The concept of distributed participatory design (DPD) refers to the participation of different stakeholders in distributed design teams, mostly online, through Internet, web-based, and social media platforms where user participation in online projects is primarily voluntary and the participants are typically unaffiliated with the development organisation (Lukyanenko et al. 2016). In this context, the Free and Open Source Software approach has been identified as a successful and continuous form of open ended DPD (Titlestad et al. 2009). Much of the research on DPD focusses on individual methods, techniques, and practices such as mediated feedback, commented case studies, and surveys (Gumm et al. 2006) as well as probe blogs, idea, concept, and feature postings, commenting, voting and online testing (Näkki and Koskela-Huotari 2012). Going beyond these individual methods, techniques, and practices and to extend research on participatory approaches to ISD beyond conventional settings, roles and types of participants and contributors, we are interested in how DPD projects in crowdsourced ISD are managed and performed in their entirety. To answer this research question we studied a case of DPD in crowdsourced ISD in the context of an UNICEF (Pacific)<sup>1</sup> initiated DPD project which engaged Pacific Youth in the development of a Facebook based digital game, which had the objective to raise awareness about climate change challenges in that region (Fisher 2012).

Contemporary ISD takes place in a dynamic environment; it is generally acknowledged as a complex activity (Highsmith 2000; Kautz 2012) and that the nature of participation in such design and development processes is emergent and cannot be fully controlled (Markus and Mao 2004). Benbya and McKelvey (2006) purport that ISD is often viewed as a complex top-down process and lament the fact that such a perspective falls short in dealing with the identified, but often unexpected contingencies of the ISD process. As an alternative, they put forward a conception of ISD based on complexity theory (Kauffman 1993, Holland 1995; Holland 1998) and propose that ISD projects should be viewed as complex adaptive system (CAS) and that these projects are better understood through the application of CAS where complexity generally refers to an emergent property of systems that are made of large numbers of self-organizing agents that interact in a dynamic and non-linear fashion. CAS theory therefore serves as the theoretical background for our analysis.

The remainder of the article is structured as follows: The next section introduces our theoretical background and analytical framework in more detail. Our research approach is explained in section 3 and a case narrative is provided in section 4. Section 5 includes the analysis of the DPD and ISD process in the case setting; it also discusses our findings and their implications for research and practice. We finish with our conclusions and a summary of our contributions in Section 6.

---

<sup>1</sup>The United Nations Children’s Fund (UNICEF) is a United Nations (UN) non-government, non-for-profit organisation and program that provides humanitarian and development assistance to children and mothers in developing countries. For the remainder of this article we will refer to UNICEF (Pacific Islands Countries) as UNICEF (P).

## 2 Theoretical Background: CAS Theory

CAS theory studies how a complex system can adapt to its environment and how innovative properties of a system emerge from the interactions of its components (Vidgen and Wang 2009). CAS theory has been extensively applied in management studies, with Benbya and McKelvey (2006) and Vidgen and Wang (2009) providing two excellent summaries of this literature. More recently, there are also writings on the topic in the IS domain (Jacucci et al. 2006; Merali and McKelvey 2006), as well as specific research on CAS and ISD (Highsmith 2000; Jain and Meso 2004; Benbya and McKelvey 2006; Meso and Jain 2006; Vidgen and Wang 2006; Vidgen and Wang 2009; Kautz 2012). As there is no single and fully shared definition of CAS and no unifying CAS theory, our theoretical background is based on Vidgen and Wang's (2009) literature review, which takes both the original CAS literature and its applications in managerial, organisational and IS studies into account.

A complex adaptive system consists of a large number of loosely interconnected and interacting autonomous parts or agents, each of which behaves according to some set of, sometimes rather simple, rules. These rules require agents to adjust their behaviour to that of other agents with whom they interact. The resulting system behaviour can be very complex (Vidgen and Wang 2009). Interaction is a significant concept in this context, as 'the behavior of the system is determined by the nature of these interactions, not by what is contained within the components. Since the interactions are rich, dynamic, nonlinear, and are fed back, the behaviour of the system as a whole cannot be predicted from the inspection of its components. The notion of "emergence" is used to delineate this aspect' (Jain and Meso 2004 citing Cilliers 2000). As CAS theory rests on the idea that order emerges through the interaction of the agents (Benbya and McKelvey 2006), the emergent system behaviour cannot be predicted or fully explained from the measured behaviours of the agents (Highsmith 2000). Interaction and emergence are closely related, and link together other generally acknowledged properties of CAS. Beyond the interconnected autonomous agents, a number of concepts are frequently used when discussing CAS. These concepts, which we briefly introduce in the following, are self-organisation, co-evolution, the poise at the edge of chaos, time pacing, and the poise at the edge of time.

Interconnected autonomous agents, human or non-human, have the ability to independently intervene and determine what action to take, given their perception of their environment. Yet, they are interconnected and interact in such a way that they collectively or individually are responsive to change around them, but not overwhelmed by the information flowing to them by this connectivity (Mitleton-Kelly 2003). *Self-organisation* is the capacity of interconnected autonomous agents to evolve into an optimal organized form without external force. It results from the agents' interaction in a disciplined manner within locally defined and followed rules and, as such, requires a departure from command and control management (Volberda and Levin 2003). *Co-evolution* relates to the fact that a CAS and/or its parts alter their structures and behaviours at a sustainable change rate in response to the interactions of its parts and to the interaction with other CAS that co-exist in an ecosystem where adaptation by one system affects the other systems. This leads to further adaptations and reciprocal change where the systems do not evolve individually, but concertedly (Kauffman 1993). *Poise at the edge of chaos* describes the ability of a CAS to be at the same time stable and unstable, to never quite lock into place, yet never quite fall apart. The edge is the place that provides not only the stimulation and freedom to experiment and adapt as well as for novelty to appear, but it also allows for the sufficient frameworks and structures to avoid disorderly disintegration. This gives a competitive advantage: CAS that are driven to the edge of chaos out-compete those that are not (Stacey 2003). *Time pacing* in this context indicates that a CAS creates an internal rhythm that drives the momentum of change. Change in a CAS is triggered by the passage of time rather than the occurrence of events; this stops them from changing too often or too quickly (Brown and Eisenhardt 1998). *Poise at the edge of time* conceptualizes a CAS's attribute of simultaneously being rooted in the present, yet being aware of the future and its balance as well as synchronization between engaging enough exploitation of existing resources and capabilities to ensure current viability with engagement of enough exploration of new opportunities to ensure future viability (Brown and Eisenhardt 1998; Volberda and Levin 2003).

All these core concepts are heavily intertwined and mutually reinforcing (Vidgen and Wang 2006). Thus, CAS can be characterized through the emergence of co-evolutionary, self-organized behaviour, structure and order through the interaction of interconnected autonomous agents in a time-paced rhythm balanced at the edge of time. At the heart of CAS theory's relevance for ISD is the concept of *emergence*, which appears in relation to all key concepts (Kautz 2012).

### 3 Research Approach and Method

Our research follows the interpretive paradigm. Given the limited literature concerning distributed participatory design in crowdsourced ISD and how it unfolds, our investigation is based on an exploratory, qualitative case study (Creswell 2003) of an ISD project. While it is often stated that it is not possible to generalise and certainly not to theorise from a single case study, Walsham (1995) suggests that it is possible to generalise case study findings among others in the form of a contribution to rich insight. On this background we used the features of the process model for our data analysis. The roles and length of stay in the field varied for the four authors of this paper. The fourth author has been involved in the project as a reflective practitioner (Schön 1983) throughout the whole period. As the UNICEF (P) communications specialist and project sponsor, he was involved as the overall project co-coordinator at all stages of the project. He shared correspondence and provided reflections on the process. As an employee and insider he enhanced the depth and breadth of understanding the case setting that may not be accessible to a non-native researcher (Kanuha 2000). The third author also participated during the whole project, as an involved, accompanying (Walsham 1995) researcher impacting the design and development of the game. Given the background of these authors the purpose of the research presented here was to investigate in a less unbiased manner how DPD takes place in practice. Thus, the first and the second author acted as outside observers (Walsham 1995) and were included in the reflective process. They conducted interviews with the involved researchers and independently analysed all available empirical material. The combination of intervention, interpretation, and collaboration between the three academic researchers and the fourth author was chosen to bring interpretive rigor to our analysis. In line with the research topic and the interpretive approach, our understanding of DPD in the game development project has come about through an iterative process of interpretation, comparison and connecting of prior research and empirical data.

Given the distributed location of the participants the extensive email trail between them was the main data source. These emails contained status information, reflections before, during and after the development and implementation of the game, conceptual feedback, reflections and recollections concerning input into the design of the game, the elements of climate change which it was addressing, test results as well as technical feedback. The empirical data also comprised social media postings by the four Fiji adolescents who served as facilitators between the technical development team and the juvenile Pacific crowd and their responses to the request for input. Project documentation such as the UNICEF (P) strategic plan for digital engagement, its project description, brief and evaluation as well as a terms of reference document were included as valuable data sources as were the field notes by the sponsor and the accompanying researcher. Further empirical data for the study was collected through semi-structured, open-ended interviews conducted by the accompanying researcher with the three members of the technical development team and by the outside researchers with the accompanying researcher concerning her role and experience during the co-creation project. The developers were interviewed for about 45 minutes in length with the interviews focusing on the issues around the DPD process and their reflections on the project. The issues included how they undertook the development process, how they managed the interactions with other participants, the mechanisms for communication and how they incorporated new ideas and change requests. The interviews also explored how the developers generated and refined their ideas particularly in relation to the sponsor's brief and delved into their motivations for becoming involved apart from the modest amount they were paid.

We wished to achieve an interaction between the existing literature and our observations from the case setting to explain interrelationships and contribute to theory with new insight from practice that might be useful for scholars and practitioners. Our analysis takes its starting point in September 2010 when the project was conceived and ends in August 2011. As a first step in the analysis, we produced a timeline spanning that period and a case narrative which is included here in a condensed form. The next stage involved revisiting the narrative and the empirical data. Then we mapped the data onto the CAS concepts and categorised our findings accordingly. Using CAS theory helped us to increase our understanding of DPD and ISD practice in the case setting. Before providing a more detailed analysis, we next present a narrative account of the investigated project.

### 4 A Case Narrative

We identified the following five phases of the game development project: 1 Initiation of the idea and funding; 2 Establishment of the team; 3 Conceptual design of the game; 4 Development of the consolidated game; 5 Launch of the consolidated game.

### **Phase 1 – Initiation of the idea and funding**

Mid 2010 the communications specialist at UNICEF (P) proposed a project to the organisation. He was concerned that although UNICEF (P) had a strong social media presence and was regularly communicating with their audience via social media, two-way interaction was very limited. His major objective was to ensure that Pacific Islander youth engaged more with UNICEF. His vision was to engage youth through encouraging them to participate in a project via social media. Given the threats posed to small Pacific Islands from climate change the proposal was to develop a game which would also help youth to learn more about how to respond to climate change. He put this proposal to COL in November 2010 and modest funding was subsequently provided early January 2011. The communications specialist who was located on the Pacific Islands immediately approached the third author of the paper in Melbourne, Australia who was known to him with a request to join the project to help establish and manage if necessary a development team. This led to the second phase.

### **Phase 2 – Establishment of the team**

The third author in January 2011 approached three young research students who fulfilled the position requirements; they accepted the invitation and were in the same month appointed as the developers for a period of 30 working days with an original project runtime from February 1 to April 15, 2011. Two of them were Chinese by birth and one was from Bangladesh. One developer was living in Hong Kong, another lived in regional Victoria, Australia and the third in Melbourne; the latter two knew each other, but they did not know the third developer beforehand, nor did they meet this developer in person during the project. The sponsor's first email to the development team including the third author as facilitating academic described his vision and what he wanted to achieve, the game was not to be about climate change but how people could respond to the impact of climate change. In January 2011, the Sponsor identified and contacted four adolescents from Fiji to be social media facilitators for soliciting and gathering ideas from Pacific Islanders youth about the game. The Social Media Facilitators posted a photo with a message inviting input on the game and launched this as a Facebook album with text encouraging UNICEF (P) Facebook fans to participate and to contribute to the design of the game. Input and comments came from 16 fans, as well as 15 fans hitting the 'like' button.

During the same period the third author facilitated a process among the members of the core development team and the Sponsor who also acted as project co-ordinator where protocols for how the development team would operate were agreed. The third author played no further role in the development process after the communication protocols had been agreed. The Sponsor was happy for the developers to manage the project themselves in terms of ideas for the game and how the work was undertaken. The developers' first meeting was a telephone conversation about how they would manage the process given they were geographically dispersed. They agreed that they would email each other every couple of days to cater for the quite short timeline for finalising the game. They also planned to use Skype to talk and instant messaging and chat to communicate. Although there was no formal team leader, the student from Bangladesh very quickly took charge of managing how things would work, she kept meeting minutes including the decisions that were taken, the next discussion topics and who would be responsible for determining what the tasks would be. The tasks were reviewed at each meeting confirming what had been done and establishing the next tasks and responsibilities. At the end of each meeting an email summarising progress was sent to the Sponsor by the informal leader. He reviewed the progress and if he thought there was something that needed to be changed or wanted to provide feedback he would email the informal leader or alternatively he called her using Skype. Brief notes were taken from the Skype meetings focusing on any requested changes.

### **Phase 3 – Conceptual design of the game**

The first stage of development was to reach agreement on what the game would be and its look and feel. One developer researched relevant aspects of climate change, another looked at different approaches to and types of Facebook games and the third investigated appropriate technologies, tools and development approaches. As the development of the ideas for the game progressed the Sponsor was an intermediary sharing these ideas with a range of people from the funding organisation, climate change experts and UNICEF staff to receive input concerning the direction of the game. Further information on climate change was also provided on a regular basis by the relevant experts to the Sponsor. The Sponsor handed the feedback and the ideas of the involved Pacific Islanders youth provided through the Facebook page and facilitated by the four adolescents from Fiji to the developers. The requirements of the Sponsor and ideas of the key stakeholders, Pacific Islanders youth, and UNICEF (P) staff, guided the developers. The team used the following process to decide on their final game: At the very beginning the Sponsor asked the developers to think about some ideas. They gave themselves a week to brainstorm and then collected their ideas to see which of them could be



combined. This led to three major ideas; each with a particular focus from one developer which reflected what they individually thought what the youth and UNICEF (P) should concentrate on. This resulted in a game which consisted of three games in one. Each game was quite different in the way the players would interact; the CO2 Reducer challenge requires players to identify potential CO2 emitters; the Evacuate Life challenge requires players to understand the climate change threats and initiate action, e.g. to evacuate or rebuild before there are serious consequences; the Flood Tales challenge highlights the causes of floods and the need for flood mitigation. An important design principle was to ensure that each game was not too complicated. The developers found the fan page postings very helpful; the responses from the Pacific Islanders youth had suggested that the game needed to be very interactive, interesting and colourful; it should have graphics, be fun and focused on action, something which promoted to be positive and to make change.

#### **Phase 4 - Development of the consolidated games**

After the developers and the Sponsor had agreed on the consolidated game's design, development proper, including detailed design, coding, testing and evaluation could begin. Managing the process, one developer commented: *"[The development process proper] was very challenging because we would not face each other and sit together, this was a challenging part."* The team took an active role in ensuring input in the form of further information and feedback was managed effectively and encouraged further participation by the Sponsor and UNICEF staff. As there was no opportunity to discuss, elaborate and clarify ideas and concerns face to face all information and communication had to be very concise. As the team members were working independently and each component of the game was developed separately, several issues concerning the build and layout of the consolidated game arose during this phase as one developer highlighted: *"The game came in three different formats, totally different interfaces. The developing process of the three people was quite different. It came as three totally different styles of game, different user interface, different colour, a lot of things were different. There was no standard look to the three different games. Fortunately, finally we got this sorted out - the three games now look quite similar."*

The Sponsor and UNICEF staff reviewed the first version of the consolidated game and provided feedback; this included the colours, fonts and graphics, the text and help function provided with the game. The Sponsor highlighted that further work was needed on standardisation and how the three components linked together to be one game. The Sponsor also reinforced the need for links to further information be embedded in each game. Technical testing and evaluation were iterative. The developers each first conducted technical unit and system testing to uncover programming errors and for this purpose identified a set of criteria in particular to test the features of the game, to ensure the various games linked internally, that the colour schemes, text size and files et cetera were correct and consistent. Each developer tested the work of the other two and provided feedback through their regular phone and Skype meetings and email. While the developers tested for programming errors the game was functionally tested by UNICEF (P) staff who played the game and provided feedback to the Sponsor. A technical person within UNICEF also tested the consolidated game and provided technical feedback once the team had incorporated the earlier feedback. The developers were also asked to find a platform to run the game and after investigation identified Google which had a free service. Further user evaluation similar to user acceptance testing was undertaken by three friends of the developers in China who were young and used Facebook. They played the game and provided advice suggesting that the graphics and artwork needed to be still more attractive. They thought players would be encouraged to play longer if the game was even more interesting. The social media facilitators also provided feedback along these lines, suggesting the game be more colourful and easier to play. All feedback was considered, further changes made and the final version of the game was ultimately accepted by the Sponsor.

#### **Phase 5 - Launch of the consolidated game**

An email to various international UNICEF groups announced the launch of the game in July 2011. The game had a favourable reception as many positive comments on what had been achieved were made by UNICEF worldwide, Pacific Islanders youth and Facebook fans. A press release issued shortly after the launch showed UNICEF's positive assessment of the initiative. Postings on the UNICEF (P) fan page highlighted how successful the game was with requests for the game to be translated into Pacific Islands' languages and to include it on the Madagascar UNICEF page. Voices of Youth, a UNICEF organisation designed to support young people and to give them the opportunity to learn about their world requested that they embed the game on their website which the developers then did. Lastly, the launch event marked the end of the project for the development team and sparked the developers'

pride about their achievement. The consolidated game is now in use and distributed through three Facebook sites: UNICEF (P), Voices of Youth and Unite for Climate.

## **5 Analysis and Discussion: The Game Development Project as a Complex Adaptive System**

Interactions in the game development project took place and involved the different participant groups throughout the whole project in multiple forms, formal and informal, organized and spontaneous, during scheduled meetings and feedback sessions, between the Sponsor and the Developers, and between the Developers themselves. There is ample evidence of the rich, intense, dynamic, and non-linear interactions, which were fed back into the project and determined its performance and its emerging innovative properties resulting in the consolidated game. It indicates that project's progression could not be predicted. The difference between the planned three months for developing the game and the actual seven months illustrates this, and the concept of emergence describes this characteristic of CAS. In the following, we revisit the game development project and accentuate the different facets of emergence and of the other key concepts of CAS theory to provide a better understanding of DPD in crowdsourced ISD. Our analysis shows how all these core concepts of CAS are entwined and reciprocally reinforce each other.

### **Interconnected, Autonomous Agents and the Emergence of Team Learning**

In the game development project all participants groups acted as autonomous, interconnected agents. The 11 different distributed groups of participants were interconnected through various social and technical mechanisms. Technologies, mostly digital technologies, such as telephone, email, Skype, instant messaging and chat were mainly used to connect in what Kazman and Chen (2009) call the kernel of the project, while email and primarily Facebook were used in the periphery and by the masses in the crowd (Kazman and Chen 2009). The Sponsor and the Social Media Facilitators acted as social mechanisms and implemented simple rules of engagement to coordinate design proposals and other input from the periphery and the masses. The Sponsor and the Developers had developed another simple rule set for the communication between them and within the development team. The participants' autonomy was expressed in numerous ways. At the periphery the Requirements Contributors, the various UNICEF staff as well as the Testers voluntarily joined the project, provided their input, and left the project as they saw fit. The Social Media Facilitators autonomously communicated with the Requirements Contributors and filtered their input for the Sponsor and the Developers. The autonomy of the Developers showed when they contributed to the functional design where the Sponsor then made the final decisions. Their autonomy became even more apparent in the liberty that the Developers had when distributing and picking tasks. Further, when implementing the games, the Developers acted as self-governing with regard to the technical design decisions they made. Despite that autonomy, the project participants were highly interlinked and maintained their relationships through the above described structures and measures, which supported the various described forms of interactions to achieve interconnectivity. A result of autonomy, the different capabilities of autonomous, interconnected agents and their interactions is the emergence of 'team' learning (Mitleton-Kelly 2003). The sharing of project-relevant knowledge in the scheduled feedback sessions and frequent meetings, combined with all the kernel team members' involvement in project management and design decisions, in addition to the Developers' self-assignment of tasks based on competence and interest, led to the emergence of mutual learning among the participants in the kernel of the project. They also learned about the crowdsourced development and utilization of digital games and the issue at hand, climate change. Through the involvement of other participants in design and evaluation activities the emergent learning spread to, and in, these other involved participant groups as well.

### **Emergent Self-Organization and the Emergence of Order**

The concept of self-organization departs from the command and control philosophy of traditional organizations. It places emphasis on increased autonomy, delegated decision making, more interactions with other individuals and the environment. Individuals and teams must still define and follow local rules and allow these rules to evolve over time in the course of self-organization. Self-organization is closely related to the concept of interconnected, autonomous agents (Volberda and Levin 2003). The game development project showed all these characteristics. The project was not led and controlled top-down, but managed in a rather egalitarian manner. The Sponsor acted primarily as a facilitator and co-ordinator. After having negotiated the communication protocol with the Developers and the Social Media Facilitators he created an environment with short communication

paths that fostered self-organization of the Developers which was characterized by task self-assignment and largely autonomous decision making and joint responsibility. One of them, self-appointed and accepted by the other two, co-ordinated their work internally in their team. In fact, all those in facilitator roles appeared more like peers and were part of a very flat organizational structure as they contributed to the environment that nurtured self-organization. Self-organization was further evidenced by the way the Social Media Facilitators solicited and filtered the requirements which were provided by the other youth, and the way these youth offered their ideas. The implementation of the communication protocols and the introduction of the role of the Social Media Facilitators illustrate the emergence of self-organization of autonomous participants and the subsequent emergence of order in the design and development process of the project. It also shows that individual and team discipline are not in conflict with, but a vital element of, self-organization. In this context, the way feedback - beyond the self-organized regular feedback sessions - was provided and gathered from the other participants and subsequently handled in orderly form, as part of planning activities, also reflects the emergence of order.

### **Poise at the Edge of Chaos and the Region of Emergent Complexity**

The game development project poised at the edge of chaos as it was constantly in a state of bounded instability, which means that it, paradoxically, was simultaneously stable and unstable (Stacey, 2003). The Sponsor's initial project plan and vision as well as his specification of the overall requirements, the Developers' formal contract, and the organization of a kernel consisting of the Sponsor and the Developers, acted as super-ordinate structuring mechanisms that created a relative stable space within which the development process and the various versions of the game could unfold. However, it also had to deal with the instability brought about by the continuous flow of ideas, requirements, change requests, and feedback caused by the involvement of 11 different groups of participants who were spread over several continents and time zones. These made up the edge of chaos where complexity emerged. The project balanced this complexity and coped with the 'chaos' (Benbya and McKelvey 2006) by emergent organization of the participants in (1) the before mentioned separate stable kernel which had a decision mandate and performed the functional and technical design as well as the technical development tasks, (2) a dispersed periphery, which provided, facilitated and filtered requirements and feedback and (3) independent and even less stable masses, who provided ideas and requirements. This organizational form allowed for the steady and flexible handling of, and swift reaction on the frequently incoming input through short iterations of manageable task size, as well as through the regular planning and feedback sessions of the participants in the kernel of the project. It illustrates how the project manoeuvred in a region of emergent complexity, and balanced at the edge of chaos as these measures at the same time supported the necessary flexibility and provided a frame for stability, as they structured the project participants' activities and helped those in the kernel to know what to do, when to do it, and what to expect from others.

### **Emergent Co-evolution and the Emergence of Behaviour and Structure**

Co-evolution emerged in the game development project through the above described multiple forms of interactions in which the distributed participants shared knowledge and learned from each other. The mutual learning had the reciprocal effect of reinforcing the emerging structures of collaboration and interaction, as well as the behaviour of the individual project participants. In particular, the continuous provision, filtering, and handling of ideas, requests, requirements, and other feedback, along with the frequent availability of early versions of the game fuelled this process. It kept the participants informed about the current status of the game and provided opportunities to explore, evaluate, and learn how to use it, as well as to create new ideas that were then fed back to the development team to become part of the next version. Thus, the game co-evolved with the distributed participants. Together, this demonstrates the co-evolution of people, processes and products (Meso and Jain 2006). The project also exhibited the unpredictable emergent behaviour and structure of the different entities of a CAS based on the described co-evolution during the distributed design and development process. The organizational structure of the dispersed participants was not planned on beforehand nor was the inclusion of certain participants. The Youth Requirement Contributors, the UNICEF staff and the Climate Experts joined the project voluntarily when being called upon and left it when they had decided to do so without any notice; they were largely unknown to each other and the other participants. Further, the idea of involving other young people such as the Testers or the Requirements Contributors in further feedback cycles on the design and early versions of the game emerged during the Developers' interactions. When implemented, the feedback changed the game and its behaviour accordingly.

## **Time Pacing and the Emergence of Rhythm**

In the game development project, the overall project plan and the Developers' contract set the time frame for the DPD and development process. The short iterations made early versions of the games available. The emergence of a lasting working rhythm and the setting of the pace for the project were supported by the virtual planning meetings and feedback sessions, held weekly or more often, that handled the continuously incoming input from the participants at the periphery and the masses. This was achieved through the agreed rules for coordination, communication, and engagement, as well as mechanisms for selecting the ideas, requests, and requirements from the different dispersed participants. As a result the versions of the game did not change too frequently or too fast. Together with the manageable size of the requirements, it provided the appropriate intervals to match and handle the changes. In this way, time pacing, as reported by Vidgen and Wang (2009) and the emerging internal rhythm drove change in the project in accordance with the passage of time and, at the same time, allowed for stability and flexibility.

## **Poise at the Edge of Time and the Emergent Balance of Exploitation and Exploration**

In CAS theory a focus on the present while keeping the past in mind and preparing for the future is regarded as poising at the edge of time (Brown and Eisenhardt 1998). In the game development project, the centre of attention was always the current iteration and the current requirements and design proposals while also taking into account the existing version of the game and the design for future extensions. The Developers built the game through a number of iterations where they at any point took the available knowledge and requirements concerning the development process, the game development, and the issue at hand, climate change into consideration, while investigating further options, receiving new ideas, requirements and feedback. The Developers exploited existing knowledge by including links to other information resources, by using accessible code from other games, and not least by sharing code between themselves. They used ideas, requirements and proposals with their roots in the present and simultaneous awareness of the past and the future approved by the Sponsor to produce a current version of the game whilst investigating prospective options with information and feedback from, and in consultation with, the Sponsor, but also the Social Media Facilitators, the Youth Requirements Contributors, local and headquarter UNICEF staff, international Climate Change Experts, and the three Testers. In doing so the project concurrently balanced the exploitation of existing knowledge and the exploration of new knowledge at the edge of time (Bocanet and Ponsiglione 2012). This emerging balance was supported through the frequent virtual meetings and feedback sessions between the Developers themselves and between them and the Sponsor as well as the other coordination and filtering mechanisms. The overall project plan and vision, as well as the frequent planning sessions structured around 'releases' and iterations of current versions of the game, supported a focus on, and constituted a manifestation of, both the past and the future. The frequent feedback sessions with the Sponsor were also used by Developers to think about their own behaviour and to review and improve the development process. This is reflected in the developed formats for managing and communication in the core team, the standardization of the game interface as well as the inclusions of further youth into the distributed testing and evaluations.

## **6 Conclusion**

Prior research into PD centred to a large extent on industrial environments with a focal organisation with some exceptions notably in open source software development in the not-for-profit arena. Most of the work on DPD is based on action research projects with significant intervention by researchers and only to a lesser extent on actual empirical practice studies without or only marginal direct influence by a research team on the course of the DPD project; DPD research also focusses heavily on individual methods, techniques, and practices (Gumm et al. 2006; Obendorf et al. 2009; Titlestad et al. 2009; Näkki and Koskela-Huotari 2012; Lukyanenko et al. 2016). In contrast, ours is a case study of genuine DPD through a non-government organization (NGO) and mainly youth in an ISD project of a digital game. Our analysis provides an in-depth understanding of how the project was managed and performed in its entirety in a not-for-profit environment. It reveals a complex network of geographically dispersed actors in a transient project organisation.

We demonstrate that the game development project can be understood as an example of DPD in crowdsourced ISD. Furthermore, by applying CAS theory we show that the project can be understood as a CAS and that CAS theory provides explanations for how and why DPD as an approach to ISD worked in the investigated case. The validation of our empirical results through the application of CAS theory contributes to the growing literature that acknowledges CAS theory as a relevant theoretical foundation for understanding contemporary DPD and ISD. Researchers can use CAS theory to

perform, analyse, present and compare longitudinal case studies of how DPD, and more general ISD unfolds in practice over time. This is crucial as social science and IS researchers (see e.g. Eisenhardt 1989; Walsham 1995; Van de Ven 2007) highlight that the complexity of practice is such that a theory and an explicit framework of ideas are necessary as a guide for data collection and identification of important research findings. Detailed studies of practice and subsequent formulation of empirically grounded theories serve to enhance researchers and practitioners' knowledge and to introduce new concepts that both groups can bring to their respective practice (Madsen et al. 2006).

Our work has practical bearings, too. It shows how actual DPD can be organized in a project to result in a process and outcome that all stakeholder groups appreciate. In practice, while recognizing that the actual course of an ISD project will evolve with the situation, CAS can be used for: (1) managing and performing DPD during the development process by providing an understanding of DPD as an approach to ISD, and (2) after-the-fact reflection and collection of lessons learnt.

In conclusion, we acknowledge that our study is an exploratory, single case study and that the game development project belongs to a special class of development project, which may limit the generality of our findings. But, like Walsham (1995), we contend that this does not mean that it does not contribute to - in our case a sound empirical practice study and rich insight about DPD as a vital approach to ISD - the collective body of knowledge, both academic and practical, of a discipline. While our research provides a link between the otherwise often disconnected research areas and research communities of DPD, ISD and CAS, still more studies are necessary to allow for more theorising and for a viable theory of DPD in ISD. To accomplish a more exhaustive explanatory theory, to answer why DPD in ISD played out the way it did in the presented case and to draw more general lessons learnt, further research is needed.

## 7 References

- Benbya, H., and McKelvey, B. 2006. "Toward a complexity theory of information systems development," *Information Technology & People* (19:1), pp. 12-34.
- Brown, S., and Eisenhardt, K. 1998. *Competing on the Edge: Strategy as Structured Chaos*. Boston, MA: Harvard Business School Press.
- Bocanet, A., and Ponsiglione, C. 2012. "Balancing exploration and exploitation in complex environments," *VINE - The Journal of Information and Knowledge Management Systems* (42:1), pp. 15-35.
- Cilliers, P. 2000. "What Can We Learn From a Theory of Complexity?," *Emergence* (2:1), pp. 23-33.
- Creswell, J. 2003. *Research design - Qualitative, quantitative and mixed methods approaches*. CA: Thousand Oak Sage Publications.
- DiSalvo, C., Clement, A., and Pipek, V. 2013. Communities: Participatory Design for, with and by communities. In J. Simonsen and T. Robertson, T. (eds.), *Routledge International Handbook Of Participatory Design*, NY: Routledge, pp. 218-248.
- Eisenhardt, K. 1989. "Building Theories from Case Study Research," *The Academy of Management Review* (14:4), pp. 532-550.
- Julie Fisher 2012. "Engaging Pacific youth through a Facebook game," *ACM Inroads* (3:4), pp.79-85.
- Gumm, D.C., Janneck, M., and Finck, M. 2006. "Distributed participatory design - a case study," in *Proceedings of the NordiChi Workshop on Distributed Participatory Design*, Vol. 2, Oslo, Norway.
- Highsmith, J. 2000. *Adaptive Software Development: A Collaborative Approach to Managing Complex Systems*, NY: Dorset House Publishing.
- Holland, J. H. 1995. *Hidden Order: How Adaptation Builds Complexity*, Reading, MA: Addison-Wesley.
- Holland, J. H. 1998. *Emergence: From Chaos to Order*, Cambridge, MA: Perseus Publishing.
- Jacucci, E., Hanseth, O., and Lyytinen, K. 2006. "Taking complexity seriously in is research. Introduction to the Special Issue," *Information Technology & People* (19:1), pp. 5-11.
- Jain, R., and Meso, P. 2004. "Theory of Complex Adaptive Systems and Agile Software Development," in *Proceedings of the 10<sup>th</sup> Americas Conference on Information Systems*, New York, NY, pp. 1661-1668.
- Kanuha, V.K. 2000. "Being native" versus "going native": Conducting social work research as an Insider. *Social Work in Health Care* (45:5), pp. 439-447.
- Kauffman, S. 1993. *The Origins of Order: Self-Organization and Selection in Evolution*, NY: Oxford University Press.

- Kautz, K. 2012. "Beyond Simple Classifications: Contemporary Information Systems Development Projects as Complex Adaptive Systems," in *Proceedings of the 33rd International Conference on Information Systems*, Orlando, FL.
- Kazman, R., and Chen, H. 2009. "The metropolis model a new logic for development of crowdsourced systems," *Communications of the ACM* (52:7), pp. 76-84.
- Kensing, F., and Blomberg, J. 1998. "Participatory Design: Issues and Concerns," *Computer Supported Cooperative Work* (7:3), p. 167-185.
- Lukyanenko, R., Parsons, J., Wiersma, Y. F., Sieber, R., and Maddah, M. 2016. "Participatory Design for User-generated Content: Understanding the challenges and moving forward," *Scandinavian Journal of Information Systems* (28:1), pp. 37-70.
- Madsen, S., Kautz, K., and Vidgen, R. 2006. "A framework for understanding how a unique and local IS development method emerges in practice," *European Journal of Information Systems* (15:2), pp.225-235.
- Markus, M. L., and Mao, J.-Y. 2004. "Participation in development and implementation-updating an old, tired concept for today's IS contexts," *Journal of the Association for Information Systems* (5:11), pp. 515-544.
- Merali, Y., and McKelvey, B. 2006. "Using complexity science to effect a paradigm shift in information systems for the 21st century," *Journal of Information Technology* (21:4), pp. 211-215.
- Meso, P., and Jain, R. 2006. "Agile Software Development: Adaptive Systems Principles and Best Practices," *Information Systems Management* (23:3), pp.19-30.
- Mitleton-Kelly, E. 2003. "Ten principles of complexity and enabling infrastructures," In *Complex systems and evolutionary perspectives on organisations: the application of complexity theory to organisations*. Mitleton-Kelly, E. (ed.) Oxford, UK: Elsevier Science Ltd, pp. 3-20.
- Näkki, P., and Koskela-Huotari, K. 2012. "User Participation in Software Design via Social Media: Experiences from a Case Study with Consumers," *AIS Transactions on Human-Computer Interaction* (4:2), pp. 129-152.
- Obendorf, H., Janneck, and Finck, M. 2009. "Inter-Contextual Distributed Participatory Design: Communicating design philosophies and enriching user experience," *Scandinavian Journal of Information Systems* (21:1), pp.50-76.
- Öberg, K.D., Gumm, D., and Naghsh, A.M. 2009. "A Special Issue Editorial - Distributed PD: Challenges and opportunities," *Scandinavian Journal of Information Systems* (21:1), pp. 23-26.
- Schön, D.A. 2003. *The Reflective Practitioner. How Professionals Think in Action*. NY: Basic Books.
- Stacey, R. D. 2003. *Strategic Management and Organisational Dynamics: The Challenge of Complexity* (4<sup>th</sup> ed.), Harlow, UK : Financial Times, Prentice Hall.
- Titlestad, O.H., Staring, K., and Braa, J. 2009. "Distributed Development to Enable User Participation: Multilevel design in the HISP network," *Scandinavian Journal of Information Systems* (21:1), pp. 27-50.
- Van de Ven, H.A. 2007. *Engaged Scholarship A Guide for organizational and social Research*. NY: Oxford University Press.
- Vidgen, R., and Wang, X. 2006. "Organizing for Agility: A Complex Adaptive Systems Perspective on Agile Software Development Process," in *Proceedings of the 14<sup>th</sup> European Conference on Information Systems*, Goeteborg, Sweden. Ljunberg J., and Andersson, M. (eds.), pp. 1316-1327.
- Vidgen, R., and Wang, X. 2009. "Coevolving Systems and the Organization of Agile Software Development," *Information Systems Research* (20:3), pp. 355-376.
- Volberda, H. W., and Levin. A. Y. 2003. "Guest editors' introduction: coevolutionary dynamics within and between firms: From evolution to co-evolution," *Journal of Management Studies* (40:8), pp. 2111-2136.
- Walsham, G. 1995. "Interpretive Case Studies in IS Research: Nature and Method," *European Journal of Information Systems* (4:2), pp.74-81.

**Copyright:** © 2018 authors. This is an open-access article distributed under the terms of the [Creative Commons Attribution-NonCommercial 3.0 Australia License](https://creativecommons.org/licenses/by-nc/3.0/au/), which permits non-commercial use, distribution, and reproduction in any medium, provided the original author and ACIS are credited.

# Too Tight - Too Loose: Controlling Lessons from a Failed IS Development Project

## **Subasinghage Maduka Nuwangi**

Business Information Systems Department  
Auckland University of Technology  
Auckland, New Zealand  
Email: maduka.subasinghage@aut.ac.nz

## **Darshana Sedera**

Faculty of Information Technology  
Monash University  
Melbourne, Australia  
Email: darshana.sedera@gmail.com

## **Abstract**

Information Systems Development outsourcing (ISD-outsourcing) projects are notorious for not providing agreed deliverables within the stipulated time and budget. More alarmingly, it is estimated that 19% of ISD-outsourcing projects fail outright (Hastie and Wojewod 2015). This study investigates an ISD-outsourcing failure case which was attributed to issues in the requirements engineering process. Adopting a 'control theory' perspective and leveraging case study approach, we examine how the weaknesses in control portfolio contributed to project failure. We attribute the failure not to the absence of control portfolios, rather (i) employing particular control mechanisms incorrectly depending on the phase of requirements engineering process, (ii) dominance of a particular control mechanism, and (iii) insufficiency of particular control mechanisms.

## **Keywords**

Information Systems Development Outsourcing, Control Theory, Requirement Engineering

## 1 Introduction

According to Gartner (2017), the worldwide IT outsourcing services market reached about 283.5 billion U.S. dollars in 2016. A survey conducted with industry professionals<sup>1</sup> indicated that 72% of their IT functions have been outsourced and there will be a further 31% of increase in the future (Deloitte 2016). Information Systems Development outsourcing (ISD-outsourcing) is one of the most popular type of outsourcing, with strong and continuous growth in ISD-outsourcing initiatives (Gregory et al. 2013). ISD-outsourcing is a contract-based relationship between client and vendor organization wherein the client contracts out all or part of its ISD activities to the vendor (Khan et al. 2011). These projects require continuous engagement between the client and the ISD vendor to exchange ideas, information and efforts.

ISD-outsourcing projects commence with a contractual agreement between the client and the ISD vendor. These projects consist of several stages such as requirements engineering, design, development, testing and implementation (Boehm 1988). The requirements engineering is particularly important step in ISD-outsourcing projects, where the focus is on understanding the development requirements (Pohl 1996). Projects often fail due to mis-specified requirements (Mishra et al. 2008), conflicting requirements (Salado and Nilchiani 2016) and in general for lacking a clear understanding of the requirements (Sim and Brouse 2014). According to Pohl (1996, p. 3), requirements engineering is “a systematic process of developing requirements through an iterative co-operative process of analysing the problem, documenting the resulting observations in a variety of representation formats, and checking the accuracy of the understanding gained.” Nuseibeh and Easterbrook (2000) discussed the stages of requirements engineering process as; 1) requirements elicitation, 2) requirements analysis and modelling, 3) requirement communication, 4) agreeing with the requirements, and 5) evolving requirements. Requirements engineering process entails iterative discussions between the client and the team members of ISD vendor such as consultants, project managers and technical staff. It is also a vital process that identifies the budgetary constraints and technical limitations (Saiedian and Dale 2000). Requirements engineering is conducted in multiple iterations, where the requirements are gathered, updated, verified, confirmed and documented. Once the requirement documents are developed, they are passed on to the technical staff to develop the system with agreed specifications.

Requirements engineering process is inherently complex. First, it entails multiple stakeholders who rarely agree on common value propositions (Nuseibeh and Easterbrook 2000). Second, a third-party organization discovering the business requirements from the client organization is always open for misinterpretation and mis-specification (Mishra et al. 2008; Sedera et al. 2014). Third, the conversion of business requirements into technical requirements often lead to misunderstandings (Tiwana 2004). In addition, complexities could arise through lack of appropriate skills (Tiwari et al. 2012), inadequate knowledge transfer mechanisms (Pee et al. 2010) and over promising of requirements by the ISD organization (Ehrhart 2002; Nuwangi and Sedera 2017). Given the complexity of requirements engineering process in ISD-outsourcing projects, the selection of appropriate control mechanisms for each stage of requirements engineering process is crucial for project success.

ISD-outsourcing projects are notorious for not providing the agreed deliverables on time (Nakatsu and Iacovou 2009; Savolainen et al. 2012; Srivastava and Teo 2012). As per Standish Group (2014) average only 16.2% of ISD-outsourcing projects are completed within the expected time and budget. More alarmingly, it is estimated that 31.1% of ISD projects are cancelled before completion (Standish Group 2014) and 19% of projects completely fail (Hastie and Wojewod 2015). However, rarely we receive an opportunity to investigate the failed projects (Chua and Lam 2005). It is said that failure cases can provide insights that are often ignored in investigations of successful projects (Lyytinen and Robey 1999).

This study investigates an ISD-outsourcing failure case which was attributed to the inefficiencies and issues of the requirements engineering process. The present study addresses the following research question: “how the weaknesses in the control portfolio contribute to project failure?” This posthumous view provides a rare insight into where and how ISD-outsourcing firms should focus on formal and informal controls. The analysis and recommendations presented here provide insight into the landscape of control mechanisms in ISD-outsourcing. The paper proceeds in the following manner. Next section discusses the theoretical background of the research. Then, it explains the case and research

---

<sup>1</sup> More than 85% of the respondents were from companies with over \$1 billion annual revenue.



methodology followed by preliminary results section. The paper concludes with a discussion, which includes summary of results and research implications.

## 2 Theoretical Background

Requirements engineering process consists of five main stages; 1) requirements elicitation, 2) requirements analysis and modelling, 3) requirement communication, 4) agreeing with the requirements, and 5) evolving requirements (Nuseibeh and Easterbrook 2000). Requirement elicitation, the first stage of requirements engineering process is focused on capturing client requirements, system boundaries and goals. Interviews, observations, focus groups and brainstorming can be considered as techniques that can be used to capture client requirements during requirement elicitation (Paetsch et al. 2003). Requirement analysis and modelling is where the collected requirements are analysed for consistency, completeness and feasibility (Paetsch et al. 2003). Requirements modelling techniques such as data-flow models and object-oriented approaches can be used to depict the requirements. Requirement documentation is important method of requirement communication between multiple stakeholders. Goal of requirement documentation is to ensure that requirements can be read, analysed and validated. Since it is difficult to identify all requirements initially, the development of requirement documents can be considered as an incremental process where the requirements are added to the documents successively (Mishra et al. 2008). Requirements are validated by certifying that the requirements are an accurate representation of Information System to be implemented. After the requirement validation, the stakeholders agree and sign-off the requirements. Agreeing upon requirements can be difficult as the stakeholders' may have diverse goals. Since ISD-outsourcing projects consist of volatile client requirements (Gefen et al. 2008), managing requirement changes is an important step of requirements engineering process.

### 2.1 Control Theory

Control Theory is one of the most prominent theoretical foundations to study ISD-outsourcing projects (Wiener et al. 2016). There are four types of management control modes that are commonly considered in control theory literature that can be used in assisting complex project management. Formal controls involve managing employees through mechanisms such as performance evaluations in which either the outcomes or behaviours of the employees are measured, evaluated and rewarded (Kirsch 1996). Formal controls are further subdivided into outcome-based and behaviour-based control modes, where the outcome-based modes specify the expected outcomes of projects, and the behaviour-based modes influence the behaviours (Kirsch 1996). Common project management techniques companies employ in ISD-outsourcing projects, like the requirement documents, project plans and regular meetings, fall under the outcome and behaviour controls of the control theory (Choudhury and Sabherwal 2003; Nuwangi et al. 2014). The informal controls like social and people strategies are also commonly employed in ISD-outsourcing projects. The informal control consists of clan and self-controls. Ouchi (1978) explains clan control as promoting common values and beliefs within a clan, which is defined as a group of individuals who share a set of common goals. Unwritten clan-control mechanisms can promote a sense of unity and a shared objective in disparate projects. Self-control occurs when the employees of the company control their own actions (Kirsch 1996). The formal ones – outcome and behavioural control modes are typically suitable for well-structured projects, while the informal – clan and self-controls are suitable for situations with evolving structures (Kirsch 1996).

As per control theory, ISD-outsourcing projects can be managed by implementing a portfolio of controls, which consists a mix of formal and informal controls (Choudhury and Sabherwal 2003; Kirsch 1996). Previous research discussed the use of control portfolios to manage ISD-outsourcing projects (Choudhury and Sabherwal 2003; Nuwangi 2016; Wiener et al. 2016), however to the best of the authors' knowledge, no study has specifically focused on identifying appropriate control mechanisms as per the stages of requirements engineering process. Requirements engineering is a complex and unpredictable process which combines ideas, perspectives and objectives of multiple stakeholders (Abrahamsson et al. 2017; Pandey et al. 2010). Since requirements engineering process provides the base for all other project stages such as software coding and testing, it is important to select appropriate control mechanisms as per the stages of requirements engineering process. Selecting appropriate control mechanisms as per the requirement engineering process enables the project team to constantly act upon evolving requirements (Abrahamsson et al. 2017). An effective control portfolio has the potential to deploy a combination of formal and informal controls based on the situation. Much of the existing knowledge on control portfolio suggests deriving a portfolio 'based on the context' (Wiener et al. 2016). While this is true for most situations, prescriptive guidelines on which composition of controls work better, and which control compositions are worst at 'known' situations are absent in the literature. A well-developed

prescriptive guidelines of a control portfolio at the requirements engineering would: 1) ensure that ISD vendor completes agreed task on-time with agreed service level agreements (Kirsch 1996), 2) ensure cooperation amongst individuals (Choudhury and Sabherwal 2003), 3) monitor, evaluate and provide feedback, especially in issues (Kirsch 1996), and overall 4) increase team performance (Wiener et al. 2016).

### 3 Introducing the Case and Methodology

As the phenomenon being examined is relatively new and unexplored, we follow the case study method to capture the richness of the context in which the phenomenon is situated (Yin 2009). Three conditions formed the benchmark for the selection of the research site. First, the vendor should have a successful track record of managing ISD projects. Second, the vendor must execute multiple ISD-outsourcing projects at the time of our interviews and third, the vendor must have been involved in ISD-outsourcing for at least five years, to have mature and stable controlling structures. Vendor-StockEx<sup>2</sup>, was a large ISD-outsourcing company engaging in stock exchange related software application development. Vendor-StockEx has been in the business for over 10 years, employing over 300 staff. Aforementioned characteristics convinced the section of Vendor-StockEx as our target case. Vendor-StockEx developed capital market automation software including the functionalities of multiple trading methods, asset classes and market structures.

#### 3.1 The Failed Project

The purpose of this project was to develop a post-trade application, which provides clearing and settlement of trades after execution. The solution developed in this project was characterized by complex trade processing methods, which were highly integrated with clearing and settlement procedures. There were seventeen (17) team members in the project; project management team (2), consultant team (3), technical team (6), quality assurance team (4), support team (1) and user interface design team (1). These team members have been involved in multiple successful projects within the company. For example, the consultancy team was concurrently engaging in another ISD project, which was categorized as a successful project. Thus, the team members were capable of planning, analysing and delivering successful ISD projects. This project had a client company from Asian region which provided brokerage services for stock exchanges. The client company commenced its operations in 2000s with the intension of becoming a leading financial intermediary for providing capital market access to investors. The company had a wide range of clients including financial institutions, corporates and banks. The brokering products of the company included equity, derivative and on-line trading products. Client company dealt with multiple exchanges, which had multiple asset classes such as equities, securities lending and borrowing<sup>3</sup>. Each asset class consisted of different market types such as normal markets and auction markets.

Project followed agile methods where the information system development tasks were divided into multiple iterations with short time frames, where at the end of each iteration some proportion of the information system was delivered to the client (Boehm 1988). These iterations involved the team working through a full ISD lifecycle including requirements engineering, design, coding and testing. Multiple iterations were required to release a complete software product for the clients. In the requirements elicitation stage of the project, client requirements were gathered and decomposed. Similar requirements were grouped as eleven (11) requirement modules, which were described in 11 Business Requirement Specifications (BRSs)<sup>4</sup>. BRSs consisted of information about the requirement modules including functionalities, dependencies, parameters and concepts. For example, trade processing BRS explained the procedure of entering a trade in to the system, trade processing, trade management, contract and bill generation, trade confirmation and trade rejection procedures. Each BRS of the project contained around 50-100 pages. As specified in the deliverables dashboard (V1.0) document, requirement modules of the system were planned to be delivered in three deliverables: deliverable 1 - client registration, master data, trade processing and user management; deliverable 2 - fund processing, stock processing, brokerage taxes and charges and general accounting and journal

---

<sup>2</sup>To maintain confidentiality, the name of the company, project and personnel were disguised.

<sup>3</sup>For a wider discussion of the above concepts see for example Senarath and Copp (2015), Senarath (2016) and Senarath (2017)

<sup>4</sup> BRSs are also referred to as software requirement specifications, functional specifications, product specifications, system specifications or requirement documents

entries; and deliverable 3 – derivatives, initial public offering and manual funds processing and depository participant module. Since trade processing, fund processing and stock processing were identified as main functionalities of the system, this study mainly focused on these three BRs. During these deliverables, multiple iterations of requirements engineering process was conducted. Since consultants of the failed project documented requirements while analysing requirements, we integrated the two steps (i.e. requirement analysis and modelling step and requirement communication step) suggested by Nuseibeh and Easterbrook (2000) in to one for analysis purposes (see figure 1). As depicted in figure 1; evolving requirements triggered a new requirement engineering process iteration.

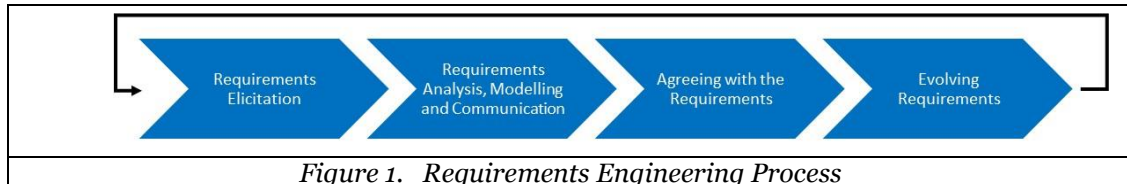

Figure 1. Requirements Engineering Process

### 3.2 Data Collection and Analysis

Six (6) semi-structured interviews, lasting between 30-40 minutes each, were conducted with team members of consultant team, technical team, project management team and quality assurance team. The sampling technique is non-probability, purposive and employed the ‘snowball technique’, where the interview participants were appropriate opinion leaders with well-developed views on the research topic (Minichiello et al. 1995). At the beginning of each interview, the participants were briefed about objectives of the study. All the interviews were recorded, with notes taken when necessary, and then transcribed. In total, our interviews of approximately 3 ½ hours transcribed into 45 pages. The interviews were supplemented with the BRs and other internal documents such as process flow diagrams and mind maps. Eleven (11) BRs, five (5) process flow diagrams, two (2) mind maps and one (1) deliverables dashboard document were collected and analysed. The BR is considered as the contract which specifies the client requirements whereas the process flow diagrams and mind maps indicate the relationships between requirements and the flow of requirement execution. Deliverable dashboard document was used to outline the expected deliverables of the project. Grinnell, Gabor, and Unrau (2015) recommended the use of objective data (e.g. BRs and process flow diagrams) to reduce the ambiguity of data and generate unbiased results.

Predominantly a deductive approach was adopted in this research. Coding guidelines for control mechanisms were informed by the literature. For example Choudhury and Sabherwal (2003, p. 301) discussed that “mechanisms to explicitly specify desired outcomes that were assessed later” can be identified as outcome controls. Therefore, “expected outcomes are written in detail in the BRs” was identified as one characteristic of formal-outcome controls. Control mechanisms were established as follows; 1) formal outcome controls - expected outcomes of the project were identified and documented in the BRs (i.e. client requirements and system functionalities), 2) formal behaviour controls - expected behaviours of the project were identified and documented in the BRs (i.e. steps that should be followed to achieve the expected outcomes), 3) informal-clan controls - shared values and beliefs, team spirit, interactions and collaborations between team members, and 4) informal self-controls - ISD team members’ ability to control their own actions, provide feedback and suggestions and execute the project as per their requirements.

## 4 Results

Initially, few team members of the project (i.e. a consultant, a project manager and a tech lead) visited the client premises to conduct initial discussions. During initial discussions, the team and the client were able to agree with the high-level project goals, timeline and budget. After returning, the consultant team commenced requirement analysis, modelling and documentation. During this stage, consultants created process flow diagrams to explain the process flows of main functionalities of Information System (i.e. trade processing, fund processing and stock processing) and commenced writing BRs. Consultant team had several conference calls with the client to get the requirement clarifications. Draft BRs, which were documented by the consultants were sent for client review. First iteration of requirements engineering process completed in November 2010 with following outputs: Trade processing BR (V1.00), Fund processing BR (V1.00) and Stock processing BR (V1.00). The signed-off BRs were shared with the technical team for development.

Second round of requirements engineering process was supported by the signed-off BRSs of the first round. After the second round of requirement elicitation, in January 2011, the initial BRSs of trade processing, fund processing and stock processing were updated with client comments. For example, in revision history of trade processing BRS, it was mentioned *“Jan 21, 2011 - Trade Processing (V1.01) - Updated with [client] comments (Entire document updated)”*. Second iteration of requirements engineering process was completed on January 2011 with following outputs: Trade processing BRS (V1.01), Fund processing BRS (V1.01), Stock processing BRS (V1.01), trade processing flow diagram (V1.00), fund processing flow diagram and stock processing flow diagram (V1.01). During the third iteration, a lead consultant of the project visited client site again for one month. During this period, consultant continued requirement elicitation, analysis and BRS documentation. In the revision history of trade processing BRS it was mentioned; *“March 10, 2011 – Trade Processing (V1.02) Updated spec [specification] with feedback received from the visit to [client]”*. When the project goes through multiple iterations, BRSs were updated including more information. For example, trade processing BRS of the project had eight (8) main versions. Although there were only 16 pages in trade processing BRS (V1.00), trade processing BRS (V1.08) consisted of 154 pages. The requirements iterations took place for over three years and eventually the project was abandoned. Respondent 02 mentioned; *“It is almost at the exit procedure level. So, we were [in] discussion how we get out from the project”*. Respondent 01 mentioned; *“We have temporary halted it, but we haven’t stopped it. We are looking for another potential client. If we get one, we will open it again”*.

### **Controls in requirements engineering process iterations:**

During the initial stages, draft BRSs consisted of broad information on expected outcomes and behaviours of Information System to be developed. Thus, the level of outcome and behaviour controls were recognized as low. When the project goes through multiple iterations, BRSs were updated including more information. Respondent 01 explained; *“For like two years the BRS have been frequently been updated. So, after like two years we had 95% complete set of BRSs. But, initially that was not completed”*. This indicates that the level of outcome and behaviour controls were enhanced gradually. Since the discussions between client and consultant team was friendly during initial agreements, the level of clan control between client and consultant team was identified as high. Since the consultants had the ability to suggest and discuss functionalities of the Information System, the level of self-control of the consultant team was identified as high. However, the level of clan control between client and consultant team declined gradually. Respondent 02 mentioned; *“The client [is] so demanding, whatever requirement they find out today, they put in to the go live scope. They say ok, this should be there, it is obvious thing it should be there”*. One member from the technical staff joined the team for initial client visit. Other than that, there was minimum involvement of technical staff during requirements engineering process. Lack of involvement and collaborations between consultants and technical team indicated low level of clan control between consultant team and technical team. As a result of lack of collaborations, the technical team was unable to suggest and discuss functionalities of the system. Thus, the level of self-control of the technical team was identified as low.

Key issues of the control portfolio as per the four stages of requirements engineering process are described below.

### **Step 1: Requirements elicitation**

Lead consultant went to the client site for one month of requirement elicitation. However, one month of requirement gathering at the client site was insufficient due to the large scope of the project. Respondent 01 explained; *“Problem with the requirement gathering was in the initial part. The time given to her was a month. [...] One month is not enough. [...] Scope is very large. [...] There were business requirement specification after that month, but when the project progress we realized [...] the requirement is not very clear”*. This highlights that expected outcomes and behaviours of Information System were not clearly identified during requirement elicitation stage. During the project execution, client was required to be contacted for requirement clarifications. Since the client was not committed for project, consultant team did not receive answers for their queries. *“Their [clients’] commitment was minimum. So, when we even ask a simple question they didn’t reply”* [respondent 01]. As a result, consultant team had to find alternative methods to elaborate client requirements. Respondent 01 mentioned; *“It was very difficult, sometimes we came up with solutions, couldn’t wait for the client reply. We have to come up with the solutions and we have to elaborate on the functionalities”*. Due to lack of client commitment, consultant team defined expected outcomes and behaviours of the system as per their knowledge and understanding of client requirements. Some of the software functionalities suggested by the consultant team were never used by the client. *“Since we don’t know the exact way that they are doing that functionality we just try to come up with several alternatives which would*

*never be used by the client. So, that was a big problem*" [respondent 01]. With the intension of reselling the information system to other potential clients, the consultant team included new requirements even without client request. Respondent 01 explained; *"Most of the time what we did was we added some alternatives. For example, if the client wants one and two [features] we added three and four"*. This indicated inaccurate estimations of outcome and behaviour controls of the system.

### **Step 2: Requirements analysis, modelling and communication**

Signed BRSs consisted of high-level functional requirements. There was lack of information about the implementation procedures. *"They signed-off the business functionality basically. BRSs don't have this is exactly how we are going to give [this] to you"* [respondent 01]. Since the BRSs did not include detail information about the requirements, quality assurance team encountered difficulties during testing. Respondent 06 explained; *"Sometimes we don't know whether it is defect or not. We don't have proper BRSs. That is the major problem"*. This highlights that lack of outcome and behaviour controls originated issues in testing stage. After the BRSs were agreed and signed-off by the clients, consultants updated BRSs including implementation details. However, the client was not informed about these updates. According to respondent 01; *"We did the changes on the top of signed BRSs. [...] We couldn't update the client. So, the signed-off BRSs are like one set, we have a new set of BRSs which are something different from the signed-off BRSs"*. This highlighted that the consultant team had high level of self-control, where they updated the signed-off BRSs as per the requirements of the team without client approval. When the consultants suggested a solution for a specific issue in the requirements or else an ISD implementation method, the technical team did not agree with the consultant's suggestions. Respondent 01 discussed: *"Most of the time, when we [consultants] suggest a problem or suggest a solution [technical team mention that] we can't do this"*. This highlights that there was lack of clan control between consultant team and technical team.

### **Step 3: Agreeing with the requirements**

Draft BRSs were not reviewed by the technical team before signing off. Respondent 01 explained; *"We should have given the BRSs before signed off for the development to review. It never happened"*. As a result, technical team was unable to provide information about the technical limitations of the system. Thus, the level of self-control of the technical team was identified as low. When the project goes through multiple iterations, agreeing with the requirements became much difficult. There were many disagreements between clients and consultant team. This highlights that the level of clan control between client and consultant team declined gradually. For example, on 20<sup>th</sup> September 2011, around fifty (50) spec points<sup>5</sup> of trade processing BRS was updated as per the client requests during BRS finalization calls.

### **Step 4: Evolving requirements**

Since the signed-off BRSs did not include clear information, the client requested several new requirements after the BRSs were signed-off. Respondent 02 discussed; *"The client [is] so demanding, whatever requirement they find out today, they put in to the go live scope. They say ok, this should be there, it is obvious thing it should be there, initially we didn't identify, didn't realize [the difficulty of providing the functionalities]"*. Since some of the initially agreed requirements could not be implemented because of the interdependencies, those requirements were removed later in the ISD lifecycle. Respondent 01 from stated: *"This requirement cannot be implemented without that [requirement], because it is clashed with other requirement. So, a big requirement was removed"*. Since the BRSs were updated after removing the functionalities, the software engineers had to amend the software code accordingly. Respondent 02 stated: *"They [software engineers] have to change certain things, because the document [BRS] is changing, it is changing continuously. It is frequently changing. So, the developer [software engineers] can't always accommodate the changes [...] It is not easy. It is not the proper practice"*. This highlights the volatile nature of expected outcomes and behaviours of the system.

Table 1 summarizes the key issues of the control portfolio as per the four stages of requirements engineering process.

---

<sup>5</sup> Spec point- a description written under a specific number in BRS (e.g. section 2.2.1 – update trade postings).

Table 1: Summary of Key Issues of the Control Portfolio

Stage	Description	Key issues of control portfolio
<b>Requirement elicitation</b>	Requirements are not clear	Expected outcomes and behaviours of Information System were not clearly identified
	Some requirements suggested by consultants were never used by clients	Inaccurate estimations of expected outcomes and behaviours of the system Domination of self-control of consultants
	Consultant team included new requirements even without client request	Inaccurate estimations of expected outcomes and behaviours of the system Domination of self-control of consultants
<b>Requirements analysis modelling and communication</b>	Lack of information in BRSs	Expected outcomes and behaviours of Information System were not properly documented
	Documented BRSs were updated many times including clarification information	Expected outcomes and behaviours of Information System were not properly documented
	Consultants updated signed-off BRSs	Domination of self-control of consultants
	Technical team disagree with the consultants' suggestions	lack of clan control between consultant team and technical team
<b>Agreeing with the requirements</b>	BRSs were not reviewed by the technical staff before sign-off	Low level of technical team self-controls
	Many disagreements during BRS finalization calls	Level of clan control between client and consultant team declined gradually
<b>Evolving requirements</b>	Client requested several new requirements after the BRSs were signed-off	Volatile outcome and behaviour controls
	Some of the requirements were removed from the BRSs	Volatile outcome and behaviour controls

## 5 Discussion

This study was motivated by the need to understand the how the weaknesses in the control portfolio contributed to an ISD-outsourcing project failure. Analysis of interview data through the control theory perspective provided the ability to understand this phenomenon. Control portfolios were visible in all stages of requirements engineering process. Therefore, we attribute the failure not to the absence of control portfolios, rather (i) employing particular control mechanisms **incorrectly** depending on the phase of requirements engineering process, (ii) **dominance** of a particular control mechanism, and (iii) **insufficiency** of particular control mechanisms. For example, some of the software functionalities suggested by the consultant team were never used by the client. This indicates incorrect estimations of expected outcomes and behaviours of the system during requirement elicitation stage. As per Guinan et al. (1998), some consultants believe that they are aware of what is best for the clients and are not willing to work with requirements provided by the clients. With the intension of reselling the information system to other potential clients, the consultant team included new requirements even without client request. Some software development projects over-heat to failures as a result of ambitious consultants overpromising the software deliverables (Zhu 2012). This indicates dominance of consultants' self-controls during requirement elicitation stage. BRSs were documented during requirement analysis, modelling and communication stage. These BRSs did not include sufficient information about the expected outcomes and behaviours of information system to be developed. This indicates insufficiency of outcomes and behaviour controls. Previous research (Karlsson et al. 2007; Ricca et al. 2009) highlighted similar concerns of unclear and incomplete information about expected outcomes and behaviours of information systems.

Findings of the study highlighted the importance of further exploring the control portfolios focusing on the stages of requirements engineering process. Findings of this study have the potential to influence practice. First, the findings help ISD-outsourcing companies to understand how the incorrect execution of control mechanisms, dominance of particular control mechanisms or insufficiency of control mechanisms could lead to project failures. Second, it highlights the importance of focusing on control mechanisms as per the stages of requirements engineering process. Third, the application of control theory perspective provides useful guidelines for ISD-outsourcing, which could ultimately minimize ISD-outsourcing project failures. Several studies in the literature discussed stages of requirements engineering (Nuseibeh and Easterbrook 2000; Pohl 1996) and application of control mechanisms in ISD-outsourcing projects (Choudhury and Sabherwal 2003; Nuwangi et al. 2018); however, this study provides a novel perspective of identifying appropriate control mechanisms for ISD-outsourcing projects as per the stages of requirements engineering process. Through the control theory perspective, this research highlighted that incorrect execution of control mechanisms, dominance of particular control mechanisms or insufficiency of control mechanisms could lead to ISD-outsourcing project failures.

## 6 References

- Abrahamsson, P., Salo, O., Ronkainen, J., and Warsta, J. 2017. "Agile Software Development Methods: Review and Analysis," *VTT Technical Research Center*), pp. 1-107.
- Boehm, B. W. 1988. "A Spiral Model of Software Development and Enhancement," *Computer Modelling and Simulation of Smart and Green Computing Systems* (21:5), pp. 61-72.
- Choudhury, V., and Sabherwal, R. 2003. "Portfolios of Control in Outsourced Software Development Projects," *Information Systems Research* (14:3), pp. 291-314.
- Chua, A., and Lam, W. 2005. "Why KM Projects Fail: A Multi-Case Analysis," *Journal of knowledge management* (9:3), pp. 6-17.
- Deloitte. 2016. "Deloitte's 2016 Global Outsourcing Survey."
- Ehrhart, T. 2002. "All Wound Up: Avoiding Broken Promises in Technology Projects," *Risk Management* (49:7), pp. 12-17.
- Gartner. 2017. "Market Share Analysis: IT Outsourcing Services, Worldwide, 2016." from <https://www.gartner.com/doc/3744417/market-share-analysis-it-outsourcing>
- Gregory, R. W., Beck, R., and Keil, M. 2013. "Control Balancing in Information Systems Development Offshoring Projects," *MIS Quarterly* (37:4), pp. 1211-1232.
- Guinan, P. J., Coopriider, J. G., and Faraj, S. 1998. "Enabling Software Development Team Performance During Requirements Definition: A Behavioral Versus Technical Approach," *Information systems research* (9:2), pp. 101-125.
- Hastie, S., and Wojewod, S. 2015. "Standish Group 2015 Chaos Report." from <http://www.infoq.com/articles/standish-chaos-2015>
- Karlsson, L., Dahlstedt, Å. G., Regnell, B., och Dag, J. N., and Persson, A. 2007. "Requirements Engineering Challenges in Market-Driven Software Development—an Interview Study with Practitioners," *Information and Software technology* (49:6), pp. 588-604.
- Khan, S. U., Niazi, M., and Ahmad, R. 2011. "Barriers in the Selection of Offshore Software Development Outsourcing Vendors: An Exploratory Study Using a Systematic Literature Review," *Information and Software Technology* (53:7), pp. 693-706.
- Kirsch, L. J. 1996. "The Management of Complex Tasks in Organizations: Controlling the Systems Development Process," *Organization Science* (7:1), pp. 1-21.
- Lyytinen, K., and Robey, D. 1999. "Learning Failure in Information Systems Development," *Information Systems Journal* (9:2), pp. 85-101.
- Minichiello, V., Aroni, R., Timewell, E., and Alexander, L. 1995. *In-Depth Interviewing: Principles, Techniques, Analysis*, (2nd ed.). Melbourne, Australia: Pearson Education Australia.
- Mishra, D., Mishra, A., and Yazici, A. 2008. "Successful Requirement Elicitation by Combining Requirement Engineering Techniques," *First International Conference on the Applications of Digital Information and Web Technologies: IEEE Xplore Digital Library*, pp. 258-263.
- Nakatsu, R. T., and Iacovou, C. L. 2009. "A Comparative Study of Important Risk Factors Involved in Offshore and Domestic Outsourcing of Software Development Projects: A Two-Panel Delphi Study," *Information & Management* (46:1), pp. 57-68.
- Nuseibeh, B., and Easterbrook, S. 2000. "Requirements Engineering: A Roadmap," *Conference on the Future of Software Engineering: ACM Digital Library*, pp. 35-46.
- Nuwangi, S. M. 2016. "The Impact of Modularisation on Information System Development Outsourcing Project Control," in: *Information Systems*. Queensland University of Technology, Australia p. 259.
- Nuwangi, S. M., and Sedera, D. 2017. "The Impact of over Ambitious Consultants on Project Failures: An Ambition Theory View," in: *ANZAM Conference*. Melbourne, Australia: ANZAM.
- Nuwangi, S. M., Sedera, D., and Srivastava, S. C. 2014. "Introducing System Controls for Control Theory," *Australasian Conference on Information Systems*, Auckland, New Zealand.
- Nuwangi, S. M., Sedera, D., and Srivastava, S. C. 2018. "Multi-Layered Control Mechanisms in Software Development Outsourcing," *Pacific Asia Conference on Information Systems*, Yokohama, Japan: Association for Information Systems AIS Electronic Library (AISeL), pp. 1-9.
- Ouchi, W. G. 1978. "The Transmission of Control through Organizational Hierarchy," *Academy of Management Journal* (21:2), pp. 173-192.
- Paetsch, F., Eberlein, A., and Maurer, F. 2003. "Requirements Engineering and Agile Software Development," *Enabling Technologies: Infrastructure for Collaborative Enterprises: IEEE Xplore Digital Library*, pp. 308-313.
- Pandey, D., Suman, U., and Ramani, A. 2010. "An Effective Requirement Engineering Process Model for Software Development and Requirements Management," *International conference on Advances in recent technologies in communication and computing: IEEE*, pp. 287-291.

- Pee, L. G., Kankanhalli, A., and Kim, H.-W. 2010. "Knowledge Sharing in Information Systems Development: A Social Interdependence Perspective," *Journal of the Association for Information Systems* (11:10), pp. 550 - 575.
- Pohl, K. 1996. *Process-Centered Requirements Engineering*. New York, USA: John Wiley & Sons, Inc.
- Ricca, F., Torchiano, M., Di Penta, M., Ceccato, M., and Tonella, P. 2009. "Using Acceptance Tests as a Support for Clarifying Requirements: A Series of Experiments," *Information and Software Technology* (51:2), pp. 270-283.
- Saiedian, H., and Dale, R. 2000. "Requirements Engineering: Making the Connection between the Software Developer and Customer," *Information and Software Technology* (42:6), pp. 419-428.
- Salado, A., and Nilchiani, R. 2016. "The Concept of Order of Conflict in Requirements Engineering," *IEEE Systems Journal* (10:1), pp. 25-35.
- Savolainen, P., Ahonen, J. J., and Richardson, I. 2012. "Software Development Project Success and Failure from the Supplier's Perspective: A Systematic Literature Review," *International Journal of Project Management* (30:4), pp. 458-469.
- Sedera, D., Lokuge, S., Krcmar, H., Srivastava, S. C., and Ravishankar, M. N. 2014. "The Future of Outsourcing in the Asia-Pacific Region: Implications for Research and Practice—Panel Report from PACIS 2014," *Communications of the Association for Information Systems* (35:1), pp. 317-331.
- Senarath, S. 2016. "Not So 'Bankruptcy-Remote': An Insight into Sri Lankan Securitization Practices in a Post\_Gfc Context," in: *Multidisciplinary Academic Conference on Management, Marketing and Economics*. pp. 53-60.
- Senarath, S. 2017. "The Dodd-Frank Act Doesn't Solve the Principal-Agent Problem in Asset Securitisation." LSE Research Online: LSE Business Review.
- Senarath, S., and Copp, R. 2015. "Credit Default Swaps and the Global Financial Crisis: Reframing Credit Default Swaps as Quasi-Insurance," *Global Economy and Finance Journal* (8:1), pp. 135-149.
- Sim, W. W., and Brouse, P. S. 2014. "Empowering Requirements Engineering Activities with Personas," *Procedia Computer Science* (28), pp. 237-246.
- Srivastava, S. C., and Teo, T. S. H. 2012. "Contract Performance in Offshore Systems Development: Role of Control Mechanisms," *Journal of Management Information Systems* (29:1), pp. 115-158.
- Standish Group. 2014. "The Standish Group Report: Chaos."
- Tiwana, A. 2004. "An Empirical Study of the Effect of Knowledge Integration on Software Development Performance," *Information and Software Technology* (46:13), pp. 899-906.
- Tiwari, S., Rathore, S. S., and Gupta, A. 2012. "Selecting Requirement Elicitation Techniques for Software Projects," *International Conference on Software Engineering (CONSEG): IEEE Xplore Digital Library*, pp. 1-10.
- Wiener, M., Mähring, M., Remus, U., and Saunders, C. 2016. "Control Configuration and Control Enactment in Information Systems Projects: Review and Expanded Theoretical Framework," *MIS Quarterly* (40:3), pp. 741-774.
- Yin, R. K. 2009. *Case Study Research: Design and Methods* (4th ed.). Thousand Oaks, CA: Sage Publications.
- Zhu, P. 2012. "Five Ponderings on Why IT Projects Fail." from <http://futureofcio.blogspot.com.au/2012/01/five-pondering-why-it-projects-fail.html>

**Copyright:** © 2018 Subasinghage Maduka Nuwangi and Darshana Sedera. This is an open-access article distributed under the terms of the [Creative Commons Attribution-NonCommercial 3.0 Australia License](https://creativecommons.org/licenses/by-nc/3.0/au/), which permits non-commercial use, distribution, and reproduction in any medium, provided the original author and ACIS are credited.



# Towards a Cloud Architectural Decision Framework using Case-based Reasoning and Rule-based Reasoning

## **Kent Ramchand**

School of Computer Science and Software Engineering,  
Swinburne University of Technology, Melbourne, Australia  
Email: [kramchand@swin.edu.au](mailto:kramchand@swin.edu.au)

## **Mohan Baruwal Chhetri**

School of Computer Science and Software Engineering,  
Swinburne University of Technology, Melbourne, Australia  
Email: [mchhetri@swin.edu.au](mailto:mchhetri@swin.edu.au)

## **Ryszard Kowalczyk**

School of Computer Science and Software Engineering,  
Swinburne University of Technology, Melbourne, Australia  
Email: [rkowalczyk@swin.edu.au](mailto:rkowalczyk@swin.edu.au)  
Systems Research Institute, Polish Academy of Sciences, Warsaw, Poland  
Email: [rkowalcz@ibspan.waw.pl](mailto:rkowalcz@ibspan.waw.pl)

## **Abstract**

Correct decision-making about the cloud platform architecture is crucial for the success of any cloud migration project; bad decisions can lead to undesirable consequences including project delays, budget overruns, application instability, below-par performance and creation of technical debt. Rule-Based Reasoning (RBR), a popular approach for solving clearly defined problems, can be used for cloud platform recommendation if a comprehensive set of requirements are available. However, the responsibility of decision-making is increasingly moving away from the hands of the technical subject matter experts, and into the hands of the business sponsors. Therefore, in this paper, we propose combining Case-Based Reasoning (CBR) with RBR to assist business sponsors in making strategic decisions between public, private and hybrid cloud with a high level of confidence even at the initial stages of the project.

**Keywords:** Cloud Migration, TCO Calculator, Decision Support Tool, Case-Based Reasoning, Rule-Based Reasoning.

## 1 Introduction

The Australian Government, through its National Cloud Computing Strategy (Australian Government, 2013) strongly encourages cloud uptake by both Government agencies and businesses alike, to boost productivity, innovation and business agility across the digital economy. Its Secure Cloud Strategy (Australian Government, 2017) states that government agencies should use the cloud as much as possible, and more importantly *use the public cloud services as default*, citing that it provides fast and competitive options. Yet, despite the push for cloud adoption, and its obvious benefits, there are several challenges associated with cloud migration (Gholami et al., 2017) that need to be addressed. Any cloud migration decision process has to incorporate several aspects including requirements gathering, identifying and understanding constraints, tracing constraints to architectural building blocks, and identifying infrastructure components (Pahl, 2013). Failure to carefully consider these aspects and selecting the public cloud based on implied assumptions can lead to undesirable consequences including project delays, budget overrun, below-par performance, application instability, poor customer experience, and creation of technical debt.

We have previously developed a cloud decision framework (Ramchand et al. 2017; Ramchand et al. 2018) that uses Rule-Based Reasoning (RBR) to recommend cloud platform architectures based on an extensible set of functional, non-functional, compliance and regulatory requirements. It also provides a Total Cost of Ownership (TCO) calculator for the financial viability assessment of the technical recommendation, and supports iterative decision-making until a best *'fit for purpose'* cloud solution can be found that is both technically and financially viable. The framework requires a detailed set of decision criteria as input in order to make technical recommendations with a high degree of confidence, although it also supports a streamlined approach for decision-making with a reasonable level of confidence (Ramchand et al. 2017). However, the growing prevalence of agile methodologies is making it important for organizations to identify a suitable cloud platform architecture, with a high level of confidence, early on in the project lifecycle (Younaset al. 2016); this responsibility of strategic decision-making is increasingly moving away from the hands of the technical subject matter experts, and into the hands of the business sponsors, who typically do not have access to enough information to provide a sufficiently complete set of requirements.

This issue can be addressed by using the Artificial Intelligence paradigm of Case-Based Reasoning (CBR) - a problem solving and knowledge reuse technique that seeks to solve new problems by reusing information and knowledge from similar situations in the past (Aamodt et al. 1995; Marling et al. 2002). CBR comprises the following steps: (1) analyse the new case (or problem) at hand; (2) based on the analysis, identify and retrieve relevant past cases from the case base; (3) rank the retrieved cases according to their relevance to the new case based on some *"similarity metric"*; (4) select one or more *"most similar"* cases to use for solving the new case; (5) create a solution to the new case based on the selected cases' solutions; (6) test and explore the created solution; and (7) if appropriate, add the new case and its solution to the case base for future use. There are three key benefits of using CBR for requirements elicitation: (a) it supports evidence-based decision-making, instead of relying on implied assumptions, (b) it supports explainable decision-making, unlike other black-box algorithms such as neural networks, and (c) it enables learning from experience. Learning occurs as a by-product of problem solving since the experience gained in successfully (or unsuccessfully) solving a problem can be used in the future to solve similar problems.

Therefore, in this paper, we propose an extension to our cloud decision framework, in which CBR is used in the requirements elicitation phase to assist business sponsors in identifying and prioritising a full set of requirements, following which RBR is used to recommend an appropriate cloud platform architecture.

The rest of the paper is organized as follows. Section 2 presents related work on cloud decision frameworks that use Case-Based Reasoning. Section 3 presents our proposed extension that combines CBR with RBR to enable better decision-making. Section 4 provides a simple illustrative scenario to illustrate applicability and coverage of concepts. The sample scenario underpins the motivation and need for technical decision support and illustrates how a combination of RBR and CBR can assist with this. Section 5 concludes the paper by providing a summary of the completed work and identifying areas of future work.

## 2 Related Research

Requirements elicitation is not straightforward and requirements engineering research has recognized elicitation incompleteness as an important issue (Burnay et al. 2015; Daramola, O et al. 2012).

Requirements incompleteness may occur when information remains implicit – either due to tacit knowledge, implicit requirements or implicit assumptions (Christel et al. 1992; Hickey et al. 1994), or if information remains unknown. It can also occur when the stakeholders cannot decide what it is to be built when interfacing with people or machines (Brooks et al, 1987). Existing tooling for requirements elicitation such as Requisite Pro<sup>1</sup> and Doors<sup>2</sup> do not assist in solving this problem (Daramola et al. 2012) and the implications of incomplete requirements are severe and several as highlighted in Section 1.

Case Based Reasoning (CBR) has been used previously in the Cloud platform decision process (Alhammadi et al. 2015; Soltani et al. 2016). In Soltani et al. (2016), CBR is used to recommend a cloud platform and automate the process from business requirements through to provisioning of resources in public cloud. The authors use a combination of application business and non-functional requirements to drive a process of comparison with the case history to measure a ‘similarity’ threshold score representative of precision, that is, a measurement of the usefulness of the case. It does not use ‘closeness’ as part of the comparison. If there is a match, it returns the most appropriate set of resources in the IaaS platform and identifies the most cost effective deployment back to the user. Similarly, in (Alhammadi et al. 2015), CBR is used with Analytical Hierarchical Process (AHP) to support decision making; CBR has five categories of cases (technical, organisational, security, economic and regularity) with different weighting to determine similarity of the case with those in the case history to assess its usefulness. AHP is used to calculate these weights, following which the result of the new case is compared with those of the retrieved cases.

Alternatively, in (MuBbacher 1992) the CBR system represents and organises requirements with the help of commonalities and variabilities, and retrieves requirements through similarity based retrieval options. The approach advocated is to use Requirements Traceability Matrix and an effort database as the model to compare requirements similarity followed by a requirements engineer to complete the requirements, which is not required in our framework. It then attempts to capture estimates around the SDLC in the effort database and assumes an organisation is at CMM Level 2 (meaning projects and plans are in place to use repeatable processes and work products in an enterprise) (CMMI Institute, 2018).

CBR has been widely used in other domains such as software development projects using CBR and Object Oriented design patterns for Service Oriented Architectures (Rodriguez et al. 2018), construction projects using CBR with a case history of family home project costs (Ji 2011), and for on-line course production (He 2014), utilising CBR and a Work Breakdown Structure (WBS) as a means of deriving estimates.

The main contribution of our research is to use CBR to address the problem of elicitation incompleteness. If the key decision-maker in the cloud migration project is unable to provide a comprehensive set of requirements, CBR can assist with requirements completion by utilising the knowledge gained from past completed cloud migration projects. CBR enables the automation of the measurement of the similarity and closeness of the new case with candidates from the case history subsequently improving the quality of decision-making. Productivity is gained through automating what would otherwise be a manual process for the comparison and determination of the closest cases. Furthermore, overlaying the actual results with the case history enables optimised decision making. We provide two approaches; one where we automate the process to populate the remaining criteria, provide a recommendation and conduct the feasibility assessment; and another, where a user can be provided suggested classifications for each of the remaining criteria, one at a time.

To the best of our knowledge, our approach is the first to use CBR to assist decision makers with incomplete requirements to obtain a comprehensive set of decision criteria based on which a cloud platform architectural decision can be made.

### 3 Cloud Decision Framework with Case Based Reasoning

We have previously developed a cloud decision framework (Ramchand et al. 2018) that uses RBR to make a cloud platform recommendation based on a detailed decision criteria set (see Figure 1 below). Under normal circumstances, the RBR based decision framework requires a business sponsor to identify a comprehensive criteria set with classifications to have a cloud platform recommendation provided.

---

<sup>1</sup>

[https://www.ibm.com/support/knowledgecenter/en/SSSHCT\\_7.1.0/com.ibm.reqpro.help/get\\_start/c\\_product\\_overview.html](https://www.ibm.com/support/knowledgecenter/en/SSSHCT_7.1.0/com.ibm.reqpro.help/get_start/c_product_overview.html)

<sup>2</sup> <https://www.ibm.com/us-en/marketplace/rational-doors>

The shortcoming of this approach is that business sponsors are increasingly having to provide the criteria for cloud platform selection and are unable to provide a full set of requirements early in the initiative.

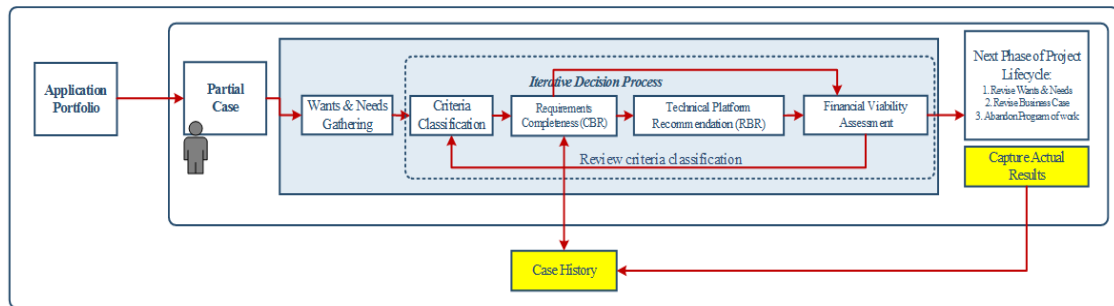

**Figure 0 : Cloud Decision Framework using RBR and CBR**

To overcome this shortcoming, we extend the framework by introducing the CBR-based requirements elicitation step. The introduction of CBR provides business stakeholders with an avenue to obtain insights from prior technical recommendations and subsequent outcomes from the case history. The CBR approach is not necessary if all the criteria are known upfront by the user of the Decision Support Tool, as the tool will produce the same result every time. However, if the user is aware of a subset of criteria, the CBR approach assists with requirements elaboration as illustrated in Figure 2. CBR will assist with determining similarity and closeness through the strength of matching with cases.

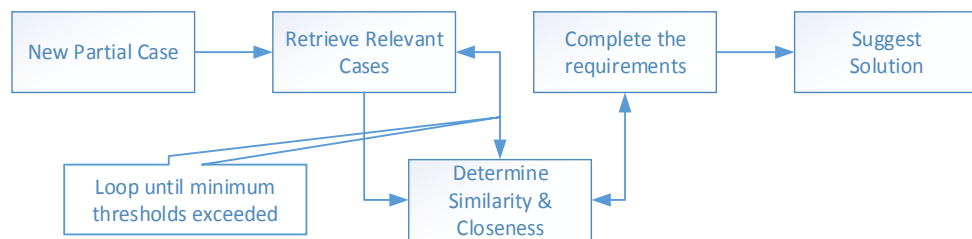

**Figure 2: Requirements Completion using Case Based Reasoning**

### Building a case history

Access to a sufficiently large case base is necessary for leveraging CBR for requirements completion. In our framework, we assume that the case history is initially built from cases where RBR is used to make the technical cloud platform recommendation and both the recommended and actual solutions are recorded as cases using an appropriate representation. Figure 3 below shows an example case model representation using attribute values. It should be noted that our ongoing work is focussed on building an appropriate model for the variety of cases required for decision making. Once there are sufficient cases in the case history, the cases can be used for requirements completion. Each time a user of the system provides an incomplete set of requirements, CBR can be used to identify and retrieve the ‘best fit’ historical case/s for completing the remaining criteria classifications, following which RBR can be used to determine an appropriate cloud platform recommendation and conduct a financial viability assessment.

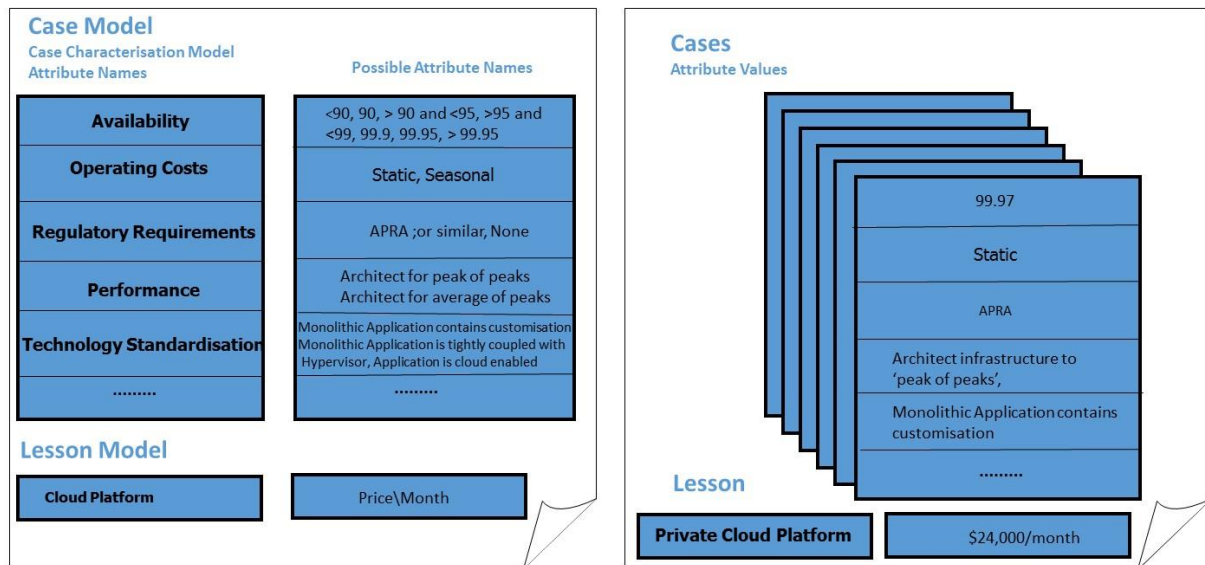

**Figure 3 Example Case Model Representation**

There are a number of different techniques that can be used for similarity matching (Aamodt and Plaza 1995; MuBbacher 1992; Alhammadi et al. 2015). In our model, the number of criteria classification matches between the historical and the new case determines the degree of similarity. Similarly, the closeness is determined by the degree of alignment between the priority of criteria for the new and historical cases. A minimum threshold is set for each comparison based on the desired confidence level.

### Updating the case history

The technical recommendation of our cloud decision framework is not a binding decision. The business sponsors may choose to follow it as-is or make their own minor/major adjustments which can result in a final outcome that is different to that recommended by the system. Therefore, our framework will also support the capturing of the actual outcome and associated costs when the technical recommendation is actually implemented. Capturing this information optimises the decision making process for new cases. Essentially, the user will capture the actual costs and compare them with what was estimated. Building this case history for each business SME's own purposes will likely increase the accuracy of future decision making in their cloud environments.

## 4 An Illustrative Scenario

As a simple illustrative example we use the Contact Centre scenario to illustrate how CBR can be used for requirements elicitation. In this scenario, an enterprise reaches a point in time where its Contact Centre (application) infrastructure reaches its end of life and a need arises to consider alternative compute, storage and network infrastructure options. The scenario includes both the new case and historical case/s with associated priorities (p1 – new partial case, p2 – historical case) and classifications as shown in Table 1.

Prior to analysing the classifications from the new case with the case history, the user specifies a threshold for similarity matching. The threshold is a configurable parameter, whose value can be set based upon the level of confidence preferred by user. As an example, a threshold of 50% is used in our scenario. Having surpassed the 50% threshold of matches at a classification level (matches in italics), the 'closeness' is measured through analysing the priorities. The priorities match is also greater than 50% in this case, hence this historical case is used to elaborate the remaining requirements. The benefit of having this match is that the user is better placed than having no reference point at all to guide their decision making. A key benefit of using CBR for requirements completion is that the recommended decision is explainable as it is evidence based and traceable to attributes of the case.

<b>Scenari</b> <b>o 1</b>	<i>Avaya Contact Centre</i>
------------------------------	-----------------------------

Cloud Decision Criteria	Criteria	Classification	P(1)	P(2)	From Case History
	Availability	Required	1	1	Required
	Business Service Availability	Required			Required
	Long running business process	Required			Optional
	Application Usage	Optional			Optional
	Regulatory requirements	Required	2	2	Optional
	Operating Costs	Optional	3	3	Optional
	Performance	Optional	4	5	Optional
	Application architecture	Required			Optional
	Application constraints	Required			Optional
	Security	Required			Optional
	Data Security Classification	Optional			Optional
	Network Global Load Balancing	Optional			Optional
	Connectivity to private MPLS network or internet VPN	Optional			Optional
	Hypervisor	Required			Required
	Enterprise Control	Required			Optional
	Data Classification	Required			Required
	Technology Standardisation	Required	2	4	Optional

**Table 1 : Avaya Contact Centre Scenario**

## 5 Conclusion

In this paper, we have presented our work in progress on using CBR to address the problem of requirements incompleteness in the early stages of a cloud migration project. With the cloud platform decision increasingly moving into the hands of the business sponsors, it is likely that not all criteria that influence the decision are known upfront. To address this issue, in our approach, CBR is used to supplement partial requirements specified by the business sponsors with default information from similar past cases to generate a comprehensive set of requirements for a migration initiative. RBR is then used to recommend the most appropriate cloud platform architecture based on these requirements. Our ongoing research focus is on building an appropriate model for case representation followed by extensive evaluation of the proposed approach. As future work, we also intend to explore combining CBR with RBR for technical cloud platform recommendation.

## 6 References

- Aamodt, A., & Plaza, E. 1994. "Case-based reasoning: Foundational issues, methodological variations, and system approaches". *AI communications*, 7(1), pp 39-59.
- Agarwal, R., & Karahanna, E. 2000. "Time flies when you're having fun: Cognitive absorption and beliefs about information technology usage". *MIS quarterly*, pp 665-694.
- Alhammadi, A., Stanler, C., Eardley, A. 2015. "A Knowledge based Decision Making Tool to Support Cloud Migration Decision Making", 17th International Conference on Enterprise Information Systems (ICEIS-2015), pp 637-643
- Australian Government. 2013. "Australian Cloud Computing Strategy". [online] Available at: [https://www.communications.gov.au/sites/g/files/net301/f/National\\_Cloud\\_Computing\\_Strategy.pdf](https://www.communications.gov.au/sites/g/files/net301/f/National_Cloud_Computing_Strategy.pdf) [Accessed 20 Jul. 2018]
- Australian Government. 2017. "Secure Cloud Strategy". [online] Available at: <https://www.dta.gov.au/what-we-do/policies-and-programs/secure-cloud>
- Brooks, Frederick P. Jr, "No Silver Bullet: Essence and Accidents of Software Engineering," *Computer*, 20(4):10-19, 1987
- C. Burnay, I. Jureta and S. Faulkner, "Towards a Model of Topic Relevance during requirements elicitation - Preliminary results," *2015 IEEE 9th International Conference on Research Challenges in Information Science (RCIS)*, Athens, 2015, pp. 151-158.

- Champigneulle, P., Williams, J. and Echternach Jr., D. 2017. "The Hybrid Cloud Survival Kit". [online] Available at: <https://advisory.kpmg.us/content/dam/advisory/en/pdfs/hybrid-cloud-survival-kit.pdf> [Accessed 20 Jul. 2018]
- Christel, M.G., Kang, K. C. "Issues in requirements elicitation," Technical Report CMU/SEI-92-TR-12 ESC-TR-92-012, 1992.
- CMMI Institute. 2018. "CMMI Levels of Capability and Performance". [online] Available at: <https://cmminstitute.com/learning/appraisals/levels>
- Daramola, O., Moser, T., Sindre, G., Biffel, S. 2012, "Managing Implicit Requirements Using Semantic Case-Based Reasoning". Norwegian University of Science and Technology
- Gholami, M. F., Daneshgar, F., Beydoun, G. & Rabhi, F. 2017. "Challenges in migrating legacy software systems to the cloud—an empirical study". *Information Systems*, 67, pp 100-113.
- He, W. 2014. "A framework of combining case - based reasoning with a work breakdown structure for estimating the cost of online course production projects". *British Journal of Educational Technology*, 45(4), pp 595-605.
- Ji, S. H., Park, M., & Lee, H. S. 2011. "Cost estimation model for building projects using case-based reasoning". *Canadian Journal of Civil Engineering*, 38(5), pp 570-581.
- Bareiss, E. R., Porter, B. W., & Wier, C. C. 1990. "Protos: An exemplar-based learning apprentice". In *Machine Learning, Volume III*, pp. 112-127.
- Marling, C., Sqalli, M., Rissland, E., Muñoz-Avila, H., & Aha, D. 2002. "Case-Based Reasoning Integrations". *AI Magazine*, 23(1), 69.
- MuBbacher, G. 1998. "Combining CBR and community analysis for software requirements reuse", Simon Fraser University
- Ramchand, K., Chhetri, M. B., & Kowalczyk, R. 2017. "Towards a Flexible Cloud Architectural Decision Framework for Diverse Application Architectures". In *The 28th Australasian Conference on Information Systems, (ACIS2017)*, WestPoint Tasmania, Hobart, Tasmania, 4-6 December 2017.
- Ramchand, K., Chhetri, M. B., & Kowalczyk, R. 2018. "Towards A Comprehensive Cloud Decision Framework with Financial Viability Assessment". In *Proceedings of the 22nd Pacific Asia Conference on Information Systems (PACIS 2018)*, 26-30 June 2018, Yokohama, Japan (p. 2744).
- Rodriguez, G., Andres Diaz-Pace, Alvaro, S. 2018. "A case-based reasoning approach to reuse quality-driven designs in service-oriented architectures". *Information Systems* 77 pp 167-189
- S. Soltani, K. Elgazzar and P. Martin, "QuARAM Service Recommender: A Platform for IaaS Service Selection," *2016 IEEE/ACM 9th International Conference on Utility and Cloud Computing (UCC)*, Shanghai, 2016, pp. 422-425.
- Younas, M., Ghani, I., Jawawi, D. N., and Khan, M. M. 2016. "A Framework for Agile Development in Cloud Computing Environment". *Journal of Internet Computing and Services*, 17(5), 67-74.

## Copyright

**Copyright:** © 2018 Ramchand, Baruwal Chhetri, Kowalczyk. This is an open-access article distributed under the terms of the [Creative Commons Attribution-NonCommercial 3.0 Australia License](https://creativecommons.org/licenses/by-nc/3.0/), which permits non-commercial use, distribution, and reproduction in any medium, provided the original author and ACIS are credited.

# Risk Management in IT Departments: a Process Perspective

## Neda Azizi

School of Information and Communications Technology (ICT)  
Griffith University  
Brisbane, Australia  
Email: [neda.azizi@griffithuni.edu.au](mailto:neda.azizi@griffithuni.edu.au)

## Bruce Rowlands

School of Information and Communications Technology (ICT)  
Griffith University  
Brisbane, Australia  
Email: [b.rowlands@griffith.edu.au](mailto:b.rowlands@griffith.edu.au)

## Abstract

This research reports on a field based research investigation into the processes of implementing Risk Management (RM) schemes in IT departments from a sensemaking perspective. Participation and implementation of the framework is conceptualised as a process of organisational learning. The literature on RM, specifically implementation issues associated with RM schemes, is reviewed. This paper focuses on contextual and processual elements as well as the action of key players associated with implementation. This research also suggests a different approach to doing RM research – one that takes into account the interaction over time of learning, context, meaning, process, planning and action around the implementation of RM schemes. The findings will provide insight for theory and practice, detailing the organisational learning that are associated with RM frameworks under certain circumstances, and how these might be assessed and managed.

**Keywords** Risk Management, Organisational Learning, Sensemaking, Process Research, Qualitative Research.



## 1 Introduction

This research steps outside the conventional factor analytical perspective of RM research (Darwish 2015) by emphasising and employing terms such as process research, learning, and interpretations to explain implementation with a RM framework. It is argued in this paper, the process by which IT departments come to participate in RM learning for the first time, remains poorly understood.

Until now the majority of research in this field has been influenced by the dominant variance research perspective involving quantitative methods which identify organisational factors to understand correlations between variables and a specific outcome (Wiesche et al. 2015). While this perspective may identify some of the critical factors, it does not examine the dynamic set of contextual elements that interact with one another over time leading to a successful implementation. What needs to be researched this paper argues, is the interplay of events and process by IT departments which come to be involved with RM process. Process research and methods that track activities over time are needed to fill this gap.

This paper takes the position that research on the uptake of RM needs to be widened to examine the process of implementation from a sensemaking perspective within organisations. A sensemaking perspective consists of both the interpretation of information and generating what is interpreted. This perspective is a continual process that makes an inter-subjective sense of shared meaning via interactions and non-verbal behaviour in face-to-face settings in which individuals attempt to negotiate and maintain a shared sense of meaning (Gephart et al. 2010). Accordingly, this research calls for a redirection of research towards RM as a learning process, thereby necessitating an emphasis on the qualitative dynamics of socio-technical change and the impact this has on perceptions.

In line with this call for a wider and re-directed focus on the implementation issue, and factually – because RM learning process and COBIT5 (ISACA 2012) are quite new to many organisations and industry sectors – this paper accordingly conceptualises RM learning process as a dynamic phenomenon– in terms of movement, activity, events, change and temporal evolution– that help manage IT risk through process thinking. Furthermore, the ISACA (2012) – an international professional association focused on IT governance – has conceptualised COBIT5 as a good-practice framework that helps manage IT risks and guide individuals behaviours, based on the perceived usefulness that they expect from a framework (De Haes et al. 2013).

To focus on the process of socio-technical interpretation (Sawyer and Jarrahi 2014), this research uses a framework comprised of individual, organizational, and social forces that clarify some unexamined aspects of implementation. The research examines, through a series of propositions inductively developed from prior studies, the process of how IT departments come to be involved with RM for the first time. Hence, one intent of this research is to provide an alternate framework so that researchers might address a more complete picture of RM. It also is intended to assist practitioners working through understanding a comprehensive framework that can make more balanced and informed learning regarding RM adoption strategies. Fundamentally, in using a sensemaking perspective to understand RM as a social process of learning, the research is focused on answering the following questions:

RQ1. What factors and contextual conditions influence the interpretation and perception of IT departments to adopt a RM framework such as CobiT5 for Risk? RQ2. How do contextual conditions and factors (the antecedents) interact to ensure implementation? RQ3. How can these processes be depicted in a RM framework?

The remainder of this paper is organised as follows. The next two sections present a detailed background to the study by reviewing the concept of process thinking and describes the concept of RM process. After describing the process of sensemaking and participation the paper continues by discussing the concept of recursivity which permits the reproduction of interactions over time. We then propose the research design based on the literature. The last section provides a short overview of the intended research.

## 2 Theoretical Foundations

### 2.1 Process Thinking

Mohr (1982) suggests that two fundamentally different types of theoretical approaches can be used to investigate organisational phenomena: variance and process models. While variance models focus on correlations between groups of variables and a specific outcome, process models aim to understand the sequence of events leading to a result over time. This study adopts the later approach.

Recent studies have been made at the organizational level to understand implementations as a process (Langley et al. 2013). Considering organization as a process does not deny the existence of events or

entities but needs to open the “box” to reveal the complex activities and transactions and provide a story that explains how issues interpret, interact and how and why outcomes, are achieved. The concept of recent process thinking in studies focuses on capturing the ongoing and ever-mutating character of organizational life, but without considering the existence of organizations as constant frames of individual action. Thus, events and activities reconfigure and reinterpret an already created pattern, thereby changing its character; every moment is qualitatively various and could be treated as such.

An alternative approach to the variance models begins with a view of RM implementation as a process of learning leading to the practice of introducing RM initiatives that incorporate a balancing of the technical, economic and political aspects of individual, organisational and societal action. This approach departs from a factor analytic perspective to focus on how IT individuals perceive and interpret IT risk, and how individuals seek to produce, negotiate, and maintain a shared sense of meaning. From this new perspective, Daft and Weick (1984) conceptualised learning as making sense or abstracting meaning. Indeed, learning is defined as interpreting and understanding reality in a new way.

Although factor analytic studies have contributed to our understanding of RM practices (Aven, 2016), fundamental problems are associated with empirical research that follows this paradigm. First, most studies following this approach only focus on a small number of pieces of the problem. Second, and most important, the factor analytic approach does not provide insight into the dynamics of the learning process, that is, how and why contextual elements interact and effect RM outcomes. While some progress has been made (Massingham, 2010; Wiesche et al. 2015), researchers should admit that all we have developed so far is a fragmented, static, and narrow understanding of implementation. Indeed, process thinking about RM focuses on how and why RM practices change and act over time. Process thinking emphasises how RM in IT departments come to be reproduced and reinterpreted through ongoing processes. As stated by Olson and Wu (2017), it is essential to advance beyond a factor analytical perspective of organizations focusing instead on individual interpretations and perceptions of actions and events. The next section of the paper develops the concept of RM as a learning process.

## 2.2 Risk Management as a Learning Process

To provide context to the study, it is important to know how IT risks and RM frameworks have evolved in terms of the emphasis organisations have placed on promoting RM within IT departments (Oliva 2016). Prior studies have identified frameworks such as COBIT5 as tools for increasing efficiency, realising benefits, and optimising risk (De Haes et al. 2013). In addition, the ISO 31000 RM standard describes the RM process as a cyclic process of learning (ISACA 2012). It is noted that the process as defined in ISO 31000 is fully covered by the various processes and practices of the COBIT 5 for Risk process (ISACA 2012). COBIT 5 for Risk, however, provides more extensive guidance and includes areas not covered by ISO 31000, such as risk governance. De Haes et al. (2013) conceptualised COBIT5 as good-practice frameworks that help in managing IT risk and guiding individuals' behaviours.

Wiesche et al. (2015) conceptualised that effective RM process appears as a learning process; but there is a concern with what happens when risks take place. In this way, RM could be considered as a process by which behaviour and action change as a result of experience. Wiesche believed that there is not enough knowledge about how learning is particularly made. Although studies could explain how and why organizations may pass from one category to another, they would not be detailed enough to explain how learning was actually made on the ground or how they were improved and adapted. What issues and contextual conditions influence the interpretations of the IT departments to embark on RM is not entirely known. Likewise, what processes IT departments go through, and descriptions of implementation issues and interpretations remain undocumented. For this reason, the absence of prior research on the RM learning process highlights the need for exploratory and descriptive research on the RM with focusing on individual interpretation and perception of actions and events.

The majority of research on RM has neglected the intentions and actions of the key players, and the process by which a framework such as CobiT5, and the organisational context within which such events occur. Thus, there is a need to investigate how and why the pieces of the ‘puzzle’ work together to produce an outcome. Assessments from the perspective of IT departments towards adopting CobiT5 are used to study the following question: RQ1. What factors and contextual conditions influence the interpretation and perception of the IT departments to adopt a RM framework such as CobiT5 for Risk?

A number of organisational researchers have produced models of technology adoption. For example, Darwish (2015) suggested a model of the interaction of global, industry and enterprise factors; and Wiesche et al. (2015) further refined this model, providing a general model of enterprise involvement in RM. These models say little about how conditions, in sequence, over time, with chance and random events play a role, result in an implementation. Hence, this study proposes to explore the following

question: RQ2. How do contextual conditions and factors (the antecedents) interact to ensure implementation? RQ3. How can these processes be depicted in a RM framework?

On the basis of the above discussion, this study employing a sensemaking perspective proposes: RM has a dynamic nature that emphasizes the ongoing change to identify new risks. RM improves the organisation's effectiveness and its capability to adapt in the changing environment for obtaining sustainable competitive advantage from learning. Successful RM is generally measured by beneficial outcomes and better ways of performance. In the context of organisational learning, Process Thinking, Sensemaking, and Negotiation of Meaning could be considered as mutually interlocking phenomena. The following section deals with the processes of sensemaking, and dynamic negotiation of meaning.

### **2.3 Sensemaking Perspective**

Sensemaking is the process by which individuals interpret and give meaning to their collective experiences and knowledge. It refers to "the ongoing retrospective development of plausible images that rationalize what people are doing" (Weick et al. 2005). Thus, Weick et al.'s approach focused on the importance of insights into the retrospective aspects of sensemaking, because the attention necessary for sensemaking requires experience to pass before attention can take place. While, Gephart et al. (2010) conceptualised sensemaking as future-oriented aspects "the conscious and intentional consideration of the probable future impact of certain actions of individuals". Emirbayer and Mische (1998) conceptualised how actors engaged in agentic, interpretive processes "oriented the past, future, and present at any given moment." However, sensemaking is considered a continual learning process that makes an inter-subjective sense of shared meaning through interactions in which individuals decide to negotiate, and maintain a shared sense of meaning (Gephart et al. 2010). Thus, individuals use resources and continual participations to identify IT risks through past and present temporal orientation and to provide contexts for proposed entities.

### **2.4 Action and Dynamic Negotiation of Meaning**

Extant organisational studies have largely explored meaning as the distinction between the real and possible (Gephart et al. 2010). In a dynamic perspective, this can be interpreted, as one side of the difference that highlights what is momentarily actual and the other side which demonstrates what could then become actual. When this instability accompanies possible ensuing events, it can lead to a particular dynamic of meaning. Although every meaningful action vanishes as soon as it happens, it produces additional meaningful actions that succeed it. All that people do and say may refer to what has been done and said in the past, yet they produce an experience: they produce meanings that extend, reinterpret, or confirm the histories of the meanings of which they are part. Thus, individuals are considered in a constant process of negotiation of meaning when analysing IT risks.

On the basis of the above discussion, this study employing a sensemaking perspective proposes: action and dynamic negotiation of meaning is an ongoing process that plays an important role within organisations in which IT RM occurs through problem-solving activities (analysing IT risks).

"Participation" and "Reification" are the activities for disseminating meaning within organizations. These activities include a variety of means such as interaction and social networks. The following two sections deal with participation and reification, which are seen as crucial means to facilitating RM.

### **2.5 Participation and Reification**

Engagement in social contexts consist of a binary process of meaning making. On the one hand, people are involved directly in interactions, and other forms of personal participation in social life. On the other hand, people produce physical and conceptual artefacts that reflect their shared experience and around which people organize their participation (Wenger 2001). RM in social contexts is facilitated by both participation and reification. Reification without participation does not carry its own meaning and participation without reification is uncoordinated. Thus, social studies have considered these concepts together to negotiate and renegotiate the meaning of experience. The process is dynamic, active and alive (Wenger 2001). However, participation is considered as a stream of information transferring among individuals to achieve common objectives, with the main emphasis on continual interpersonal interactions. Lee et al., (2015) stressed the importance of effective participation in IT departments through sharing risk-related knowledge for smooth workflow and effective RM.

On the basis of the discussion above, this study employing a sensemaking perspective proposes: participation and reification are ongoing contributions to enhancing and facilitating RM through identifying and assessing IT risks. In other words, RM can hardly occur without participation and reification. With a sensemaking perspective, the effectiveness of RM depends on sharing risk-related

knowledge or participation and interaction among individuals as well as physical and conceptual artefacts or reification. Indeed, IT departments' members use resources such as documents, reports, and experience as well as continual interactions to mitigate IT risks through the past and present.

## 2.6 Planning

An important feature of communication for identifying risks is organisational documents (Lee et al., 2015). According to Darwish (2015) documents are essential in organisation's plans and planning that has future orientation. Planning facilitates controlling risks from past as well as predicting new risks. Additionally, planning is classified into two subsets of functional and symbolic planning. Functional planning estimates the probabilities of actions with a definite history, while symbolic planning cannot allocate definite probabilities to actions and fantasy documents are mostly created because events are uncertain. The fantasy documents with a future-oriented perspective are developed by "experts" who "predict" uncertain events by implicit information from IT members. Hence, planning can facilitate organizations to save cost, time and to avoid making frequent mistakes by learning issues.

On the basis of the discussion above, this study employing a sensemaking perspective proposes: planning is important means to developing organizational RM through controlling IT risks. Indeed, the accessible knowledge about what actually happened in the past, when available and verified during the planning, may provide helpful knowledge for future with a sensemaking perspective and ongoing process by mitigating uncertainty and risky situations in IT departments.

## 2.7 Recursivity

The concept of recursivity is considered as recreation of interactions over time (Langley et al. 2013). Indeed, recursivity occurs when the information and experience needed by the organization is offset by the present information, which again enables new information to happen. Recursivity take places in the field of tension between structure and actions, thus an organization's structure and production become mutual media for one another in recursive, which may facilitate RM. However, a knowledge structure is created through production. Although an organisation's knowledge structure was produced in the past, it is considered for future production. It is, however, inconceivable to understand the future without understanding the past, because the past is written into the future.

On the basis of the earlier discussion, this study employing a sensemaking perspective proposes: an organisation serves to bind various components over time. This means that it is impossible to understand that an organisation can exist without such relations. Indeed, organisation assumes interaction around these components and provides the essential stabilization of expectations among people who participate in these activities. It is also impossible that an organisation can exist without production. A recursive perspective highlights that a knowledge structure is formed through production. Indeed, an organisation's knowledge structure formed in the past can be formative for future.

This study adopts a process model suggested by Daft and Weick (1984) as part of their learning theory. The learning process starts with data collection and interpretations and continues with defining learning. In this research a framework will be introduced during the learning process (see Figure 1).

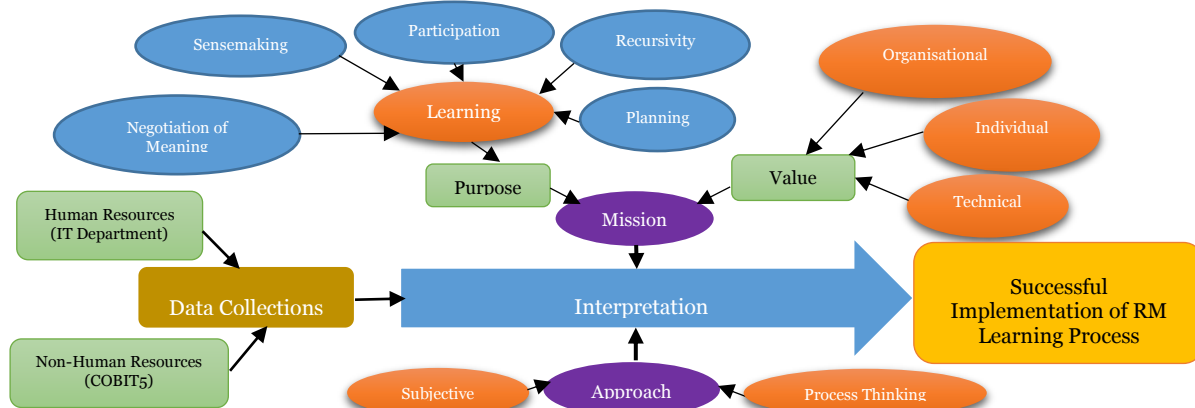

Figure 1: A model of the learning Context (Based on Learning model of Daft and Weick, 1984)

## 3 Research Design

The broad objectives of this research are two-fold. The first is to explore, describe, and explain how IT departments in the field go about forming their opinions and assessments of RM as part of the

implementation learning process. In this regard, we need to discover and understand the interaction between contextual issues, the RM framework, IT individual interpretations towards them, and their effect on implementation. The second objective is to develop a theoretical framework for use in guiding the design and analysis of the proposed empirical work. As described in the opening, and in light of the paucity of previous research on the RM implementation, this study provides an alternative perspective to an emerging research topic. It is argued that without more emphasis on the dynamic nature of the learning process, an incomplete understanding of the RM implementation will result. The research also argues that due to the stage of knowledge accrual about this problem, more attention should be paid to the development of new models more fully specified through grounded research that are better able to account for the phenomenon under investigation.

The research design involves three main phases with three different outcomes. In the first phase, a literature review seeks to find evidence supporting initial statements addressing the main research questions. Initial statements or tentative theory involving the identified factors are proposed as a result of reviewing the prior studies. In the second phase a multi-case study will be employed to understand the implementation learning process. The qualitative tools referred to in this thesis include: in-depth interviews, observations, document collection, and personal experience. The design follows an exploratory research strategy by applying Grounded Theory (GT) techniques to analyse data. GT is an inductive approach that allows the researcher to develop a theoretical account of the general features of a topic while simultaneously grounding the account in empirical observations or data. In phase three, the interview data will be analysed using a GT-like approach to develop a theory on RM learning process. This feedback is a continual and iterative process, and occurs at all stages of the process (see Figure 2).

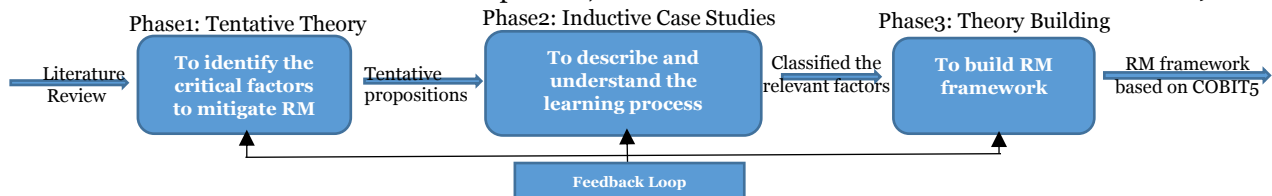

Figure 2: Three Phases of the Research Design

In particular, this research will be a qualitative study; it will be based on a social constructivist paradigm aligned with a qualitative research methodology that helps the researcher to interpret data from selected documents. An interpretive paradigm is based on the view that people socially and symbolically construct their own organisational realities. Therefore the goal of theory building in the interpretive paradigm is to generate descriptions, insights, and explanations of events so that the system of interpretations and meaning, and the structuring and organising processes are revealed. By adopting an interpretive approach this thesis construes knowledge as only gained through social constructions such as language, shared meanings, documents, tools; and is a changing and relative phenomenon. In terms of whether this study's findings are generalizable beyond the immediate set of cases, interpretive studies, do not seek to produce results that are universally applicable. In analytical generalisation, this study only attempts to generalise a particular set of results to some broader theory or research proposition. Thus, it will adopt a combination of two case studies and GT as a research method, and organisational learning theory as the research sensitizing concept. According to Yin (2014), the case study is appropriate when a "how" or "why" research question is being asked about a contemporary set of events, over which the researcher has little or no control. In addition, the case method is well suited to capturing the subjective experiences of IT members and developing theoretical propositions from them. GT-like analysis of the case data will produce a structure of conceptual categories and themes related to the implementation process in the context of IT departments. The use of the GT-like approach will be particularly appropriate, generating a set of propositions that address the critical elements involved in implementing RM— elements to date overlooked in the literature.

## 4 Conclusion

The study takes the position that research on the uptake of RM needs to be widened to examine the process of implementation from the perspective of IT department members. Thus, this research calls for a redirection of research towards RM as an organisational learning process, thereby necessitating an emphasis on the qualitative dynamics of socio-technical change and the impact this has on individual interpretations of the actions and events. Hence, this research suggest an approach to doing RM research — one that takes into account the interaction over time of intentions, process, and action around RM schemes. Accordingly, this paper is distinctive and differs from previous research in three important ways: First, given the domination by logical positivist research methods (considering RM process as a

black box) (Wiesche et al. 2015) and a variance perspective framing much of the research within IT risk (Olson and Wu 2017), this research provides a fresh perspective to the research domain. Second, a position is taken advocating that research on the phenomenon needs to be widened to examine the process of learning from the perspective of IT members. Prior research has an emphasis on senior management, without the involvement of IT workers in the process of implementation (Aven 2016). Third, the core concerns of this study are pursued by means of inductive analysis and interpretive methods respectively. It is argued that interpretive methods have the potential to produce greater understanding of RM phenomena including the deployment of formal RM frameworks, and IT department members' learning processes. In essence, the interpretive perspective helps us understand an individual's social practices when they are faced with IT risks. These social practices are influenced by the interpretations and perception of individuals to manage IT risk.

## 5 References

- Aven, T., 2016. "Risk assessment and risk management: Review of recent advances on their foundation," *European Journal of Operational Research* (253:1), pp 1-13.
- Daft, R.L. and Weick, K.E., 1984. "Toward a model of organizations as interpretation systems", *Academy of management review* (9:2), pp 284-295.
- Darwish, S. Z. 2015. "Risk and Knowledge in the context of Organisational Risk Management," *European Journal of Business and Management* (7:15).
- De Haes, S., Van Grembergen, W., and Debreceny, R. S., 2013. "COBIT 5 and enterprise governance of information technology: Building blocks and research opportunities," *Journal of Information Systems* (27:1), pp 307-324.
- Emirbayer, M., and Mische, A. 1998. "What is agency?" *American Journal of Sociology* (104:4), pp 962.
- Gephart, R. P., Topal, C., and Zhang, Z. 2010. "Future-oriented sensemaking: Temporalities and institutional legitimation," *Process, sensemaking, and organizing*, pp 275–302.
- ISACA. 2012. *COBIT 5 Implementation*, Rolling Meadows, IL: ISACA.
- Langley, A.N., Smallman, C., Tsoukas, H. and Van de Ven, A.H., 2013. "Process studies of change in organization and management," *Academy of Management Journal* (56:1), pp 1-13.
- Lee, S., Park, J. G., and Lee, J. 2015. "Explaining knowledge sharing with social capital theory in IS development projects," *Industrial Management and Data Systems* (115:5), pp 883-900.
- Mohr, L. B. 1982. *Explaining Organizational Behaviour*. San Francisco: Jossey-Bass.
- Oliva, F.L., 2016. "A maturity model for enterprise risk management," *International Journal of Production Economics* (17:3), pp 66-79.
- Olson, D. L., and Wu, D. D. 2017. "Data Mining Models and Enterprise Risk Management," *In Enterprise Risk Management Models*, pp. 119-132. Springer Berlin Heidelberg.
- Sawyer, S., and Jarrahi, M. H. 2014. *Sociotechnical approaches to the study of Information Systems*. In *Computing handbook*, Third Edition.
- Weick, K., Sutcliffe, K. M., and Obstfeld, D. 2005. "Organizing and the process of sensemaking," *Organization Science* (16:4), pp 409–421.
- Wenger, E. 2001. *Communities of practice: Learning, meaning, and identity*. Cambridge, UK: Cambridge University Press.
- Wiesche, M., Schermann, M. and Krcmar, H. 2015. "Understanding the enabling design of IT risk management processes," *in Proceedings of the 36th International Conference on Information Systems, Fort Worth, TX, USA*.
- Yin, R. K. (2014). *Case study research: Design and methods*, Sage publications.

## Copyright

Neda Azizi and Bruce Rowlands © 2018. This is an open-access article distributed under the terms of the [Creative Commons Attribution-NonCommercial 3.0 Australia License](https://creativecommons.org/licenses/by-nc/3.0/au/), which permits non-commercial use, distribution, and reproduction in any medium, provided the original author and ACIS are credited.

# Conceptualizing the Effect of Cultural Distance on IT Outsourcing Success

**Michael Könning**

TU Dresden

Dresden, Germany

Email: michael.koenning@mailbox.tu-dresden.de

## Abstract

The relationship quality between client and vendor organizations is one of the most significant influence factors for IT outsourcing success. In this context, the degree of dissimilarity between cultural values of two or more organizations (“cultural distance”) can represent a considerable challenge for establishing and maintaining good-quality relationships. Still, research on cultural distance and its effects is scarce. This paper seeks to address this gap. Building on extant theory on culture and IT outsourcing, we develop a research model which we are currently evaluating. This is done by means of an exploratory, qualitative research design based on an in-depth single case study that analyzes three outsourcing configurations of a leading European media company. Their diversity allows for a detailed examination of cultural distance on the national, organizational, and team level. Given its highly relevant characteristics, we expect our research to yield valuable contributions for both theory and practice.

**Keywords** IT outsourcing, culture, cultural distance, relationship quality, ITO success, IT service types

## 1 Introduction

Information technology outsourcing (ITO) has evolved into an essential strategic topic for organizations of all sectors and sizes ever since the first large-scale ITO engagement that involved the outsourcing of IT services from Eastman Kodak to four vendors in 1989 (Applegate 1992). 30 years later, its advantages in cost, flexibility, or access to external capabilities have made ITO a common practice to consider in organizations of all sizes, industries, and geographies, and led virtually every Fortune 500 company and many large public institutions to outsource significant parts of their IT (Schneider and Sunyaev 2016).

Corresponding to ITO's increasing relevance in practice, academia has conducted extensive research on various aspects of outsourcing such as motivations for outsourcing, main decisions, outcomes and success factors, as well as benefits and risks (Dibbern et al. 2004; Gonzalez et al. 2006; Lacity et al. 2016; Liang et al. 2015). In terms of success factors, numerous studies have found the establishment of a high-quality relationship between client and vendor organization to be highly influential for delivering successful ITO engagements (Gonzalez et al. 2015; Grover et al. 1996; Kern 1997; Kishore et al. 2003; Lee and Kim 1999; Murthy et al. 2016; Oshri et al. 2015). However, studies on how a positive relationship is established and maintained are still scarce (Jin Kim et al. 2013; Lacity et al. 2016; Xu and Yao 2014).

One of the most important and substantial, yet often overlooked influence factors in society and working relationships is culture. It exerts a subtle and unnoticed, yet powerful and oftentimes decisive influence on people, information flows, and the use and adaption of information systems (Leidner and Kayworth 2006). Previous studies have conceptualized culture in three levels (national, organizational, team) and analyzed the influence of a specific level on client-vendor relationship quality (Blaskovich and Mintchik 2011; Dibbern et al. 2012; Jain et al. 2011). However, by focusing on one or two levels, these studies paint an incomplete picture of cultural effects.

Furthermore, extant research has commonly investigated complete client-vendor partnerships as the smallest unit of analysis. However, these partnerships often comprise multiple individual services that are outsourced (e.g., application development and maintenance, infrastructure operations, IT support). Second, considerable cultural distance can be mitigated by appropriate leadership that is culturally aware and intelligent, e.g., when leaders are able to identify and interpret culture-induced statements or actions, take on a moderating role and thereby alleviate negative effects of cultural distance (Winkler et al. 2008). Hence, in summary, our research seeks to answer the following three research questions:

*RQ1: How does cultural distance on the national, organizational, and team level influence client-vendor relationship quality and ITO success?*

*RQ2: How does the outsourced IT service type moderate the effect of cultural distance?*

*RQ3: To which degree can cultural awareness and intelligence mitigate the effect of cultural distance?*

The remainder of this paper is structured as follows: The next section provides a brief introduction into related work in ITO, client-vendor relationship quality, and culture. Based on these fundamentals, we then develop our research model before describing research method and case setting. Lastly, section 5 gives an overview of our preliminary findings and outlines expected contributions to theory and practice. For brevity, we center this article around the derivation and development of our research model, and refer to our future contributions for further empirical analyses.

## 2 Theoretical Background and Related Work

### 2.1 IT Outsourcing

ITO can be defined as “the commissioning of a third party (or a number of third parties) to manage a client organization's IT assets, people, and/or activities (or part of them) to required results” (Dibbern et al. 2004). It can take on many different forms along several dimensions, be it the scope of IT services to be outsourced (partial or full outsourcing), the number of vendors to partner with (single-vendor sourcing vs. multi-vendor sourcing), or the location of service fulfillment (onshoring, offshoring, nearshoring). The consequential plurality of possible sourcing configurations is mirrored by a myriad of academic studies on the topic (Dibbern et al. 2004; Gonzalez et al. 2006; Lacity et al. 2016).

However, across all these dimensions, ITO always involves the partnering of two or more organizations over the provision of one or more IT services. The concept of such a relationship is closely linked to Social Exchange Theory which explicitly examines the social processes between multiple parties (Homans 1958). Accordingly, the establishment and management of a strong client-vendor relationship is one of the strongest predictors for success in ITO engagements (Grover et al. 1996; Lee and Kim 1999).



The value of a high-quality client-vendor relationship is particularly true for long-term ITO engagements with a broad scope of service provision. In this setting, contracts are typically unable to adequately predict and meet the dynamics of the business environment (Jin Kim et al. 2013). Academic research has therefore devoted considerable resources to understand the influence factors for the quality of client-vendor relationships (Kern 1997; Kishore et al. 2003). Among their most significant is culture.

## 2.2 The Concept and Influence of Culture

The concept of culture is complex and multi-faceted in nature. One of the first and arguably most influential definitions of culture was established by Tylor (1889) who described culture as “that complex whole which includes knowledge, belief, art, morals, law, customs and any other capabilities and habits acquired by man as a member of society” (p. 1). Another popular definition is provided by Hofstede et al. (2010) who see culture as “the collective programming of the mind that distinguishes the members of one group or category of people from another” (p. 6).

Based on this definition, the term ‘cultural distance’ can be used to express the degree of dissimilarity between cultural values of two or more organizations. Cultural distance becomes observable in differing beliefs about what values, behaviors, goals, or policies are considered important or unimportant, appropriate or inappropriate, and right or wrong.

Because of its complexity and the difficulty to grasp it in its entirety, it has been proposed to disintegrate culture into its constituent parts and analyze it in a structured manner. Following the work by Leidner and Kayworth (2006), we therefore conceptualize culture in three layers: national, organizational, and team culture.

### 2.2.1 National Culture

Differences in national culture are part of every nearshore and offshore outsourcing engagement. A very popular breakdown of national culture is offered by Hofstede et al. (2010) who originally described it as differences in four dimensions (Hofstede 1983), then later added two additional dimensions (Hofstede et al. 2010). Many studies on ITO relationship quality have itemized and used them as a means to assess and compare national cultures (Leidner and Kayworth 2006). They are defined in the following.

*Individualism vs. collectivism*: The degree to which members of a society act as individuals rather than as members of a group (Hofstede et al. 2010). Extant literature finds that individualists and collectivists perform differently in different group settings. While collectivists were found to work better as part of a group, individualistic people performed better when working alone (Earley 1993).

*Masculinity vs. femininity*: Describes whether a society is called *masculine*, i.e. when emotional gender roles are clearly distinct in that “men are supposed to be assertive, tough and focused on material success, whereas women are supposed to be more modest, tender, and concerned with the quality of life” (Hofstede et al. 2010, p. 140). It is called *feminine* when emotional gender roles overlap.

*Power distance*: “The extent to which the less powerful members of [...] organizations within a country expect and accept that power is distributed unequally” (Hofstede et al. 2010, p. 61). It ranges from relatively low (i.e., equal distribution of power, e.g., in Germany) to relatively high (unequal distribution of power, e.g., in India). Extant ITO literature finds that different degrees of *power distance* lead to problems in communication and decision-making (Heeks et al. 2001; Nicholson and Sahay 2001).

*Uncertainty avoidance*: “The extent to which the members of a culture feel threatened by ambiguous or unknown situations” (Hofstede et al. 2010, p. 191). Cultures that are high in uncertainty avoidance are considered to be more resistant to change.

*Long-term vs. short-term orientation*: Hofstede’s fifth dimension distinguishes between long-term orientation, the emphasis on virtues that are oriented toward future rewards (e.g., perseverance and thrift), and short-term orientation, i.e., the emphasis on virtues oriented towards present and past (e.g., respect for tradition, preservation of face, fulfilling social obligations) (Hofstede et al. 2010).

*Indulgence vs. restraint*: Indulgence is conceptualized as “tendency to allow relatively free gratification of basic and natural human desires related to enjoying life and having fun” (ibid. p. 281). The opposite form is restraint, i.e. the “conviction that such gratification needs to be curbed and regulated” (p. 281).

Extant literature has also identified influential differences on three additional dimensions:

*Activity vs. passivity*: A society is considered active if members see themselves as doers (actively contribute own ideas to shape their environment), and passive if members consider themselves as reactors to the world (Lytle et al. 1995).

*Language and communication style:* Refers to any differences, difficulties and misunderstandings due to the use of the common language used in the interaction (Carmel and Agarwal 2002). A second part is the way that a given language is used, i.e. the communication style which can be more abstractive or assertive, high context or low context, more holistic or more linear. Lytle et al. (1995) find that different communication styles are more likely to lead to misunderstandings and conflict.

*Conflict resolution:* Describes the way that a culture typically handles and solves conflict situations. Koh et al. (2009) illustrates how members from low power distance and more individualistic cultures voice disagreements by means of direct confrontation, whereas members of collectivistic and high power distance cultures tend to avoid and withdraw from conflict situations.

## 2.2.2 Organizational Culture

Analogous to how each ethnical group, society or nation is characterized by their specific national culture, each organization within a society develops its own organizational culture. It can be defined as “the pattern of shared values and beliefs that help individuals understand organizational functioning and provide norms for behavior in the organizations” (Deshpande and Webster 1989). I again draw on Hofstede et al. (2010) who isolated six work-related dimensions as characteristics of an organization:

*Process-oriented vs. result-oriented:* This dimension contrasts a culture with strict adherence to pre-defined, risk-minimized, routine-based processes (*process-oriented*) with one where goals are the core concern, with less focus on how they are achieved (*results-oriented*). In practice, *process-oriented* organizations tend to be more rigid, *result-oriented* work teams are more flexible and organic.

*Employee-oriented vs. job-oriented:* This dimension opposes an orientation towards people (*employee-oriented*) to an orientation on completing the work (*job-oriented*). While *employee-oriented* cultures take a responsibility for employee welfare and respect employees’ private life, employees in *job-oriented* cultures perceive the organization as only interested in the work they fulfilled, not their private welfare.

*Parochial vs. professional:* This dimension discerns between organizations whose employees strongly connect their identity and private life with the organization and feel hired as a whole person (*parochial*) from those where people consider their private life and identity their own business and feel the organization solely hires on the basis of job competence (*professional*).

*Open system vs. closed system:* This dimension depicts whether members of an organization consider it open to outsiders and newcomers, where new members feel at home after a short period of time (*open system*), or whether they perceive it to be closed and secretive, even to society members (*closed system*).

*Loose control vs. tight control:* This dimension measures the amount of internal structuring of an organization. Employees in *loose control* organizations typically report that meeting times are only kept approximately and cost awareness is rather low. In contrast, work in organizations with *tight control* is carried out more cost-conscious and meeting times tend to be kept more diligently.

*Normative vs. pragmatic:* Hofstede’s sixth dimension evaluates organizations in terms of customer orientation. It locates organizations between *normative* units where the main emphasis is on strictly adhering to organizational procedures, whereas *pragmatic* units are described as market-driven with strong focus on customer needs. In these units, results are more important than correct procedures.

## 2.2.3 Team Culture

Like every organization is influenced by the superordinate national culture, each team is subject to the superordinate organizational culture. As a result, different teams within the same organization partly exhibit the same values, and partly differ from each other. Culture on the team level is also strongly influenced by team or project leaders, e.g., their task assignment and scheduling of deadlines (Guinan et al. 1998). Consequentially, extant literature finds that similar values on work mode and task accomplishment lead to less conflict and more successful project outcomes (Walsham and Geoff 2002).

## 2.3 ITO Success and Relationship Quality

Since our research investigates the effect of cultural distance on ITO success, it is important to define what constitutes ITO success and how it is influenced. Extant literature suggests that the main reasons for ITO include access to expertise/skills, cost reductions, flexibility enablement, and service quality (Lacity et al. 2016). The better these goals are met, the higher the client satisfaction (Grover et al. 1996; Lee and Kim 1999). Our study will therefore use these four reasons as indicator to measure ITO success.

In various empirical studies, the relationship quality between client and vendor organization has been found to have a strong influence on ITO success (Dibbern et al. 2004; Grover et al. 1996; Lee and Kim

1999; Westner and Strahinger 2010). In line with Winkler et al. (2008), it can be defined as “the degree of connectedness between a client and a vendor in the aim to achieve specified goals” (p. 245). Extant research has identified several attributes that determine the quality of an ITO relationship. Among them are communication, cooperation, trust and vendor performance which positively affect relationship quality, and conflict which exerts a negative effect (Dibbern et al. 2004; Lacity et al. 2016).

### 3 Research Model

For our research model we integrate the concept of *cultural distance* on the national, organizational, and team level. Building on the work of Winkler et al. (2008), we argue that *cultural distance* on each of these levels leads to *behavioral differences in service delivery* (i.e., work in the context of an ITO engagement) which, in turn, reduce *relationship quality* by hampering *communication, cooperation, trust, and vendor performance*, and lead to increased levels of *conflict*. Reductions in *relationship quality* then lead to reduced *ITO success*.

In addition, the relationship between *behavioral differences in service delivery* and *relationship quality* is moderated by two factors: *Interaction necessity* describes the amount of interaction between client and vendor that is required in delivering the contracted service. We argue that it depends on the specific *service type* that is outsourced and is higher for application development and maintenance than for infrastructure operations. Second, *leadership and management of culture* has been found to reduce negative effects of cultural distance on relationship quality. It requires *cultural awareness and intelligence* (Winkler et al. 2008). The resulting research model is shown in Figure 1.

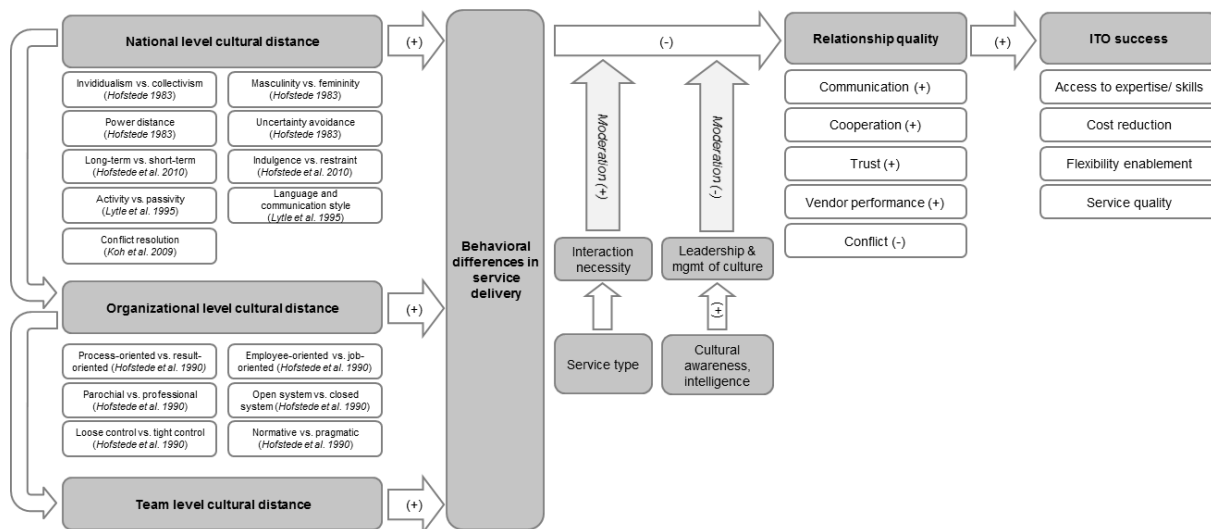

Figure 1: Research model

### 4 Research Design and Case Description

Our research follows an exploratory, qualitative research design based on an in-depth single case study. The case study method was chosen because it has been described as especially applicable for exploratory research and theory building (Eisenhardt 1989). The case study used for this research is that of a leading European media company. Between 2008 and 2018, the organization went through three phases of ITO: (1) An initial single-vendor full outsourcing and offshoring to a large multi-national vendor with service delivery from India, (2) a single-vendor outsourcing with the same partner in a mixed offshore/onshore delivery model, and (3) a multi-vendor model with two local mid-sized vendors onshore, accompanied by an increased share of insourcing. This makes the case highly relevant for evaluating the research model because its three ITO phases represent three different configurations of cultural distance.

During the first phase, client and vendor organization were separated by different national as well as organizational cultures. In the second phase, services were partly provided from onshore, thus reducing national level cultural distance, while keeping organizational distance. Finally, in the third phase, the client company shifted to a multi-vendor configuration with different onshore vendors and an increased share of insourcing. In addition to eliminating national level cultural distance through onshoring, the client company minimized organizational and team level cultural distance by considering cultural compatibility as part of their vendor selection process. For the insourced services, national level and organizational level distance are nonexistent, which allows a clear view on team level cultural distance.

Due to its unique setup and three culturally different configurations, this case study promises valuable insights into the effect of all three levels of cultural distance on ITO success. Moreover, by concentrating on a single case study, we inherently control for other variables that influence relationship quality and ITO success, especially all client characteristics and capabilities, as well as certain project characteristics.

This research project is and will be conducted as follows: After deriving a research model from extant literature and identifying a relevant case, we evaluated relevant documents in the case company (e.g., status reports, steering committee documents) and interviewed key staff involved with the ITO decisions over the last ten years, including the company's CIO, responsible project managers, and ITO strategists. This allowed us to get a first understanding of the situation and identify additional key informants. Next, we will use the research model presented here to derive a semi-structured interview guideline that will include questions on cultural distance, relationship quality, ITO success, and potential moderators. The interview guideline will then be used to conduct additional interviews with key staff from both the client and vendor organizations to obtain deeper insights into particularly relevant parts of the case. In the third phase, we will transcribe and qualitatively analyze the interviews along the research model.

## 5 Preliminary Findings and Expected Contribution

After the first set of interviews and document analyses, our preliminary findings point towards a strong influence of cultural distance on relationship quality and ITO success, especially on the national and organizational level. Talking about the first phase of ITO (single-vendor offshoring), managers in the client organization particularly stressed how differences in communication style, conflict resolution, and activity/passivity inhibited the establishment of trust and effective cooperation schemes. Consequently, these differences in national culture led to the shift towards a combined offshore/onshore model in the second phase. As a result, cultural distance on the national level was greatly reduced, but organizational level differences persisted and showed in daily procedures. As their CIO put it:

*"We are not a company that is very compatible with someone like [ITO vendor]. They are very process-focused, very professional, somewhat formal, if you will. Our organization, on the other hand, is quite the opposite: Rather informal, very pragmatic, very agile - and that just doesn't go together very well!"*

The company said they tried to address these issues by implementing adequate management practices. However, significantly improving the situation required another strategy shift towards two smaller ITO vendors that currently provide the services from onshore. In this model, cultural distance is nonexistent on the national level and greatly reduced on the organizational level. During the first interviews, client company representatives said that the organization has learned from these ITO reconfigurations in that cultural distance now plays a decisive role in their vendor selection process. Today, partnerships with more reasonable cultural distance are preferred, even if they come with an added expense.

Based on our first results, we expect valuable contributions for both research and practice. For academia, this case study can provide additional empirical evidence on how cultural distance influences outsourcing success. By providing a multi-level perspective on culture that is also reflected in the case setup, it promises to contribute to the existing research body on the effect of culture on ITO. On the practical side, the case study can serve as a highly relevant insight into the ITO practices of a leading European media company, explain how cultural effects influence ITO, and provide information on how and which methods can help in mitigating the effect. Last, it will also explain what lessons can be learned from cultural misfit and how it is avoided using adequate ITO vendor selection processes.

## References

- Applegate, L. M. 1992. "Eastman Kodak Co.: Managing Information Systems Through Strategic Alliances: Harvard Business School Teaching Note 193-037," Harvard Business School, Boston, MA, USA.
- Blaskovich, J., and Mintchik, N. 2011. "Information Technology Outsourcing: A Taxonomy of Prior Studies and Directions for Future Research," *Journal of Information Systems* (25:1), pp. 1–36.
- Carmel, E., and Agarwal, R. 2002. "The Maturation of Offshore Sourcing of Information Technology Work," *MIS Quarterly Executive* (1:2), pp. 65–77.
- Deshpande, R., and Webster, F. E. 1989. "Organizational Culture and Marketing: Defining the Research Agenda," *Journal of Marketing* (53:1), pp. 3–15.
- Dibbern, J., Chin, W. W., and Heinzl, A. 2012. "Systemic Determinants of the Information Systems Outsourcing Decision: A Comparative Study of German and United States Firms," *Journal of the Association for Information Systems* (13:6), pp. 466–497.
- Dibbern, J., Goles, T., Hirschheim, R., Bandula, J., and Jayatilaka, B. 2004. "Information Systems Outsourcing," *The DATA BASE for Advances in Information Systems* (35:4), pp. 6–102.

- Earley, P. C. 1993. "East Meets West Meets Mideast: Further Explorations of Collectivistic and Individualistic Work Groups," *Academy of Management Journal* (36:2), pp. 319–348.
- Eisenhardt, K. M. 1989. "Building Theories from Case Study Research," *Academy of Management Review* (14:4), pp. 532–550.
- Gonzalez, R., Gasco, J., and Llopis, J. 2006. "Information Systems Outsourcing: A Literature Analysis," *Information & Management* (43:7), pp. 821–834.
- Gonzalez, R., Gasco, J. L., and Llopis, J. 2015. "Information Systems Outsourcing Satisfaction: Some Explanatory Factors," *Industrial Management & Data Systems* (115:6), pp. 1067–1085.
- Grover, V., Cheon, M. J., and Teng, J. T.C. 1996. "The Effect of Service Quality and Partnership on the Outsourcing of Information Systems Functions," *Journal of Management Information Systems* (12:4).
- Guinan, P. J., Coopridge, J. G., and Faraj, S. 1998. "Enabling Software Development Team Performance During Requirements Definition," *Information Systems Research* (9:2), pp. 101–125.
- Heeks, R., Krishna, S., Nicholson, B., and Sahay, S. 2001. "Synching or Sinking: Global Software Outsourcing Relationships," *IEEE Software* (March/April 2001), pp. 54–60.
- Hofstede, G. 1983. "National Cultures in Four Dimensions: A Research-Based Theory of Cultural Differences among Nations," *International Studies of Management & Organization* (13:1), pp. 46–74.
- Hofstede, G., Hofstede, G. J., and Minkov, M. 2010. *Cultures and Organizations: Software of the Mind. Intercultural Cooperation and its Importance for Survival*, New York: McGraw-Hill.
- Homans, G. C. 1958. "Social Behavior as Exchange," *American Journal of Sociology* (63:6), pp. 597–606.
- Jain, R. P., Simon, J. C., and Poston, R. S. 2011. "Mitigating Vendor Silence in Offshore Outsourcing: An Empirical Investigation," *Journal of Management Information Systems* (27:4), pp. 261–298.
- Jin Kim, H., Shin, B., and Lee, H. 2013. "The Mediating Role of Psychological Contract Breach in IS Outsourcing," *European Journal of Information Systems* (22:5), pp. 529–547.
- Kern, T. 1997. "The Gestalt of an Information Technology Outsourcing Relationship: An Exploratory Analysis," *Proceedings of the 18th International Conference on Information Systems*, pp. 37–58.
- Kishore, R., Rao, H. R., Nam, K., Rajagopalan, S., and Chaudhury, A. 2003. "A Relationship Perspective on IT Outsourcing," *Communications of the ACM* (46:12), pp. 86–92.
- Koh, C., Joseph, D., and Ang, S. 2009. "Cultural Intelligence and Collaborative Work: Intercultural Competencies in Global Technology Work Teams," *International Workshop on Intercultural Collaboration*, pp. 261–264.
- Lacity, M. C., Khan, S. A., and Yan, A. 2016. "Review of the Empirical Business Services Sourcing Literature: An Update and Future Directions," *Journal of Information Technology* (31:3), pp. 269–328.
- Lee, J.-N., and Kim, Y.-G. 1999. "Effect of Partnership Quality on IS Outsourcing Success: Conceptual Framework and Empirical Validation," *Journal of Management Information Systems* (15:4), pp. 29–61.
- Leidner, D., and Kayworth, T. 2006. "A Review of Culture in Information Systems Research: Toward a Theory of Information Technology Culture Conflict," *MIS Quarterly* (30:2), pp. 357–399.
- Liang, H., Wang, J.-j., Xue, Y., and Cui, X. 2015. "Information & Management IT Outsourcing Research from 1992 to 2013: A Literature Review Based on Main Path Analysis," *Information & Management*.
- Lytle, A. L., Brett, J. M., Barsness, Z., and Janssens, M. 1995. "A Paradigm for Confirmatory Cross-Cultural Research in Organizational Behavior," *Research in Organizational Behavior* (17), pp. 167–214.
- Murthy, C., Padhi, S., Gupta, N., and Kapil, K. 2016. "An Empirical Investigation of the Antecedents of Value Co-Creation in B2B IT Services Outsourcing," *Business Process Management Journal* (22:3), pp. 484–506.
- Nicholson, B., and Sahay, S. 2001. "Some Political and Cultural Issues in the Globalisation of Software Development: Case Experience from Britain and India," *Information and Organization* (11), pp. 25–43.
- Oshri, I., Kotlarsky, J., and Gerbasi, A. 2015. "Strategic Innovation Through Outsourcing: The Role of Relational and Contractual Governance," *Journal of Strategic Information Systems* (24:3), pp. 203–216.
- Schneider, S., and Sunyaev, A. 2016. "Determinant Factors of Cloud-Sourcing Decisions: Reflecting on the IT Outsourcing Literature in the Era of Cloud Computing," *Journal of Information Technology* (31:1), pp. 1–31.
- Tylor, E. B. 1889. *Primitive Culture: Researches into the Development of Mythology, Philosophy, Religion, Language, Art, and Custom*: Holt.
- Walsham, and Geoff. 2002. "Cross-Cultural Software Production and Use: A Structural Analysis," *MIS Quarterly* (26:4), pp. 359–380.
- Westner, M., and Strahringer, S. 2010. "Determinants of Success in IS Offshoring Projects: Results from an Empirical Study of German Companies," *Information & Management* (47:5-6), pp. 291–299.
- Winkler, J. K., Dibbern, J., and Heinzl, A. 2008. "The Impact of Cultural Differences in Offshore Outsourcing: Case Study Results from German-Indian Application Development Projects," *Information Systems Frontiers* (10:2), pp. 243–258.
- Xu, P., and Yao, Y. 2014. "Knowledge Sharing in Offshore Software Development: A Vendor Perspective," *Journal of Global Information Technology Management* (16:1), pp. 58–84.

**Copyright:** © 2018 Michael Könning. This is an open-access article distributed under the terms of the [Creative Commons Attribution-NonCommercial 3.0 Australia License](https://creativecommons.org/licenses/by-nc/3.0/australia/), which permits non-commercial use, distribution, and reproduction in any medium, provided the original author and ACIS are credited.

## **Impact of IT Multisourcing on vendor opportunistic behaviour - A research framework**

### **Bhavya Peapully Shroff**

Information Systems area  
Indian Institute of Management Bangalore  
Bangalore, Karnataka  
India  
Email: bhavya.ps@iimb.ac.in

### **Rajendra K. Bandi**

Information Systems area  
Indian Institute of Management Bangalore  
Bangalore, Karnataka  
India  
Email: rbandi@iimb.ac.in

### **Abstract**

IT Multisourcing (ITM), the provision of IT services by multiple interdependent vendors to a single client, is widely prevalent now. ITM, in principle, is believed to mitigate both strategic and operational risks of IT outsourcing for client organizations. Yet there is limited research which systematically investigates the effects of ITM on different forms of risk. This paper develops a theoretical framework to understand the implications of ITM for the specific risk of vendor opportunistic behaviour, classified as a 'strategic risk' of outsourcing. The fundamental attributes of ITM are identified and mechanisms through which they influence vendor opportunistic behaviour are explained. The advantages and limitations of the framework are discussed, and future research directions are laid out.

**Keywords** IT Multisourcing, IT outsourcing risks, risk mitigation, opportunistic behaviour

## 1 Introduction

IT Multisourcing (ITM) is emerging as a prominent form of IT outsourcing (ITO), with several organizations moving from a single-vendor outsourcing arrangement to ITM (Everest 2018). IT Multisourcing refers to the provisioning of IT services to a client by multiple IT vendors where interdependencies exist between vendors with respect to their tasks and service delivery for the client (Bapna et al. 2010). ITM is perceived to offer various benefits such as access to specialized vendors and technologies, providing greater flexibility, and mitigation of strategic and operational risks of ITO for the client organizations (Bapna et al. 2010; Cohen and Young 2006). Researchers argue that the high perception of ‘vulnerability’ to cost escalation and inflexible services (Cross 1995), hidden service costs and lock-in experienced by a client in single-vendor settings of huge contract size (Aubert et al. 2005) has prompted client organizations to look for sourcing strategies involving more than one vendor. In principle ITM mitigates the strategic and operational risks of ITO (Bapna et al. 2010; Cohen and Young 2006). Strategic risks result from the deliberate opportunistic behaviour of the vendors, whereas operational risks arise from reasons other than deliberate behaviour such as complexity of operations, geographic separation between client and vendors and coordination difficulties (Aron et al. 2005). While there is evidence supporting the use of ITM for risk-mitigation by client organizations (Bahli and Rivard 2013; Currie 1998; Wiener and Saunders 2014), not much is known about the underlying mechanisms through which ITM mitigates risks. Also, there are contending arguments that ITM introduces some risks (Wiener and Saunders 2014), that it may not mitigate all forms of strategic risks (Aron et al. 2005; Clemons and Hitt 2004), and that it even aggravates operational risks (Su and Levina 2011). This calls for a need for further scrutiny of the implications of ITM on various risks of ITO and systematically evaluate the impacts of ITM for risks. Such an analysis is very important for organizations that are increasingly adopting ITM, to avoid the pitfalls of ITM as well as reap the intended benefits. The key objective of the current research is to get a more nuanced understanding of the implications of ITM for the risks of outsourcing by identifying the underlying mechanisms through which ITM impacts specific risks.

Su and Levina (2011) present a theoretical framework that explains the implications of ITM for strategic and operational risks of outsourcing and considers the role of the vendor-base. The risk implications of other important aspects of ITM such as vendor-interdependence, embeddedness and network governance, task visibility, vendor-client relationships, have been largely unexplored in ITM literature. Moreover IT Multisourcing exists in several forms involving different choices in vendor grouping, work division, distribution of hierarchy and authority, that can have different implications for various outcomes such as risk management (Cullen et al. 2005) and learning (Koo et al. 2017). However, from a risk perspective, literature has not considered the choices pertaining to the ITM forms in investigating the risk-mitigation impacts of ITM. Also, the conceptualization of the ITM attributes is fragmented with various studies using different sets of criteria to describe ITM making it difficult to get a comprehensive understanding of the ITM attributes or their implications for risks or any other outcomes. For instance, ITM has been described with respect to the size of vendor base and depth of client-vendor relationships (Su and Levina 2011), interaction among client and vendors being direct or mediated (Wiener and Saunders 2014), contracting between client and multiple vendors being direct or through sub-contracting (Koo et al. 2017) and choices in handling of service integration and management responsibilities (Goldberg et al. 2014). Such variety hinders a cumulative understanding of ITM and comparison of findings across studies. Any comparison across these different choices of an ITO arrangement requires a sound understanding of the differences in the overall structure and intent of IT outsourcing arrangements (Cullen et al. 2005). Lack of this understanding could drive an assumption of uniform impacts of all outsourcing forms on the outcomes of interest, subsequently leading to contradictory findings (Dibbern et al. 2004). Given the contradictory views expressed about ITM’s risk-mitigation effect, it is important to have a more comprehensive view of the fundamental attributes of ITM to better understand the implications of ITM for risks.

In this paper we address the two limitations identified from literature: (a) Lack of systematic inquiry into the implications of ITM for outsourcing risks, along with contending views on risk implications of ITM, and (b) fragmented conceptualization of ITM deterring the establishment of definite impacts of ITM on outsourcing risks. In particular, the paper focuses on the risk of vendor opportunistic behaviour, which is classified as ‘strategic risk’ of outsourcing for the client (Aron et al. 2005; Su and Levina 2011). Vendor opportunistic behaviour remains a key concern in ITO practice and is relevant across various IT services such as IT infrastructure (e.g., Chang et al. (2017)) and software development (e.g., Gefen et al. (2008)). Recent studies highlight various ‘vendor risks’ for clients including other behavioural risks arising in multisourcing such as vendors blaming each other for failures, scope for collusive activities of vendors and free-riding, which are yet to be fully understood (Bunker et al. 2016; de Sá-Soares et al.



2014; Wiener and Saunders 2014). Several forms of vendor opportunistic behaviour exist, and the mechanisms focussed to mitigate one form may be ineffective for the other forms (Clemons and Hitt 2004; Mathew and Chen 2013). It is important to understand what forms of opportunism are mitigated or aggravated in ITM settings, which will be useful in identifying the trade-offs in ITM. In this regard, the research question addressed by the current study is: *How does IT Multisourcing influence vendor opportunism risks?* The key contribution of the paper is a framework that describes the influence of various ITM attributes on vendor opportunistic behaviour. The fundamental attributes of ITM, mechanisms and various forms of vendor opportunistic behaviour are identified from ITO, ITM and other studies. The influences of various ITM attributes on vendor opportunistic behaviour are explained in the framework. This insight will be important for risk management in ITM.

## 2 Literature Background

Risk is the extent of exposure of a party (client or vendor) involved in a transaction to a chance of loss or damage (Lacity et al. 2016). Clients typically face several risks in ITO arising from vendors, the complexity of operations, technology, location and several other factors: There is significant evidence that risks can negatively impact ITO outcomes (Lacity et al. 2016). The current study will focus on one such category of risks, 'vendor opportunistic behaviour' as it is widely acknowledged as one of the major issues across several outsourced IT services. Vendor opportunism in ITO can result in significant loss for clients in the form of reworks, budget overruns, disputes, delays in service delivery to end-user, service disruptions, loss of proprietary assets and expertise to competitors and the eventual loss of competitive advantage (Clemons and Hitt 2004; Mathew and Chen 2013). Since ITM has been positioned as a risk-mitigation strategy, we investigate the effect of ITM on vendor opportunistic behaviour. Opportunism is an embedded and constitutive aspect of outsourcing and can be handled better only by understanding the constitutive elements of outsourcing engagements (Wüllenweber et al. 2008). The current study follows this approach by investigating the effects (such as mitigating, or aggravating) of specific attributes of ITM on vendor opportunistic behaviour. We first discuss the forms of vendor opportunistic behaviour and then provide a description of attributes of ITM and the mechanisms through which they influence vendor opportunism.

### 2.1 Strategic risks: Opportunistic behavior in IT outsourcing

Opportunism is a fundamental assumption of transaction cost economics (TCE). Opportunistic behaviour of partners in exchange can be defined as 'self-interest seeking with guile' which is detrimental to the others (Williamson 1975). This is a willful strategic behaviour corresponding to 'calculated efforts to mislead, distort, disagree, obfuscate, or otherwise confuse' (Williamson 1985), which includes lying, stealing and cheating (Williamson 1975, 1985). It is assumed that the economic agent knows that benefits will accrue to self by behaving opportunistically (Williamson 1975). Though it doesn't imply that most economic agents will behave opportunistically most of the time, ignoring opportunism from the analysis of organizational forms will lead to their uncritical assessment leaving out many economic problems (Williamson 1993). The notion of opportunism allows considering both ex-ante and ex-post settings, thereby subsuming under itself many economic issues or phenomena which have been defined in information economics and agency theory (Williamson 1993). In ITO research opportunism corresponds to wilful violation of contracts and relational norms (Ravindran et al. 2015). Vendor opportunistic behaviour includes shirking, misappropriation of assets, forced renegotiation or vendor holdup, vendor underinvestment and collusive behaviour of vendors (Aron et al. 2005; Lioliou and Zimmermann 2015; Loboda 2013, 2013; Mathew and Chen 2013; Su and Levina 2011; Wiener and Saunders 2014). It can be noted that these include risks from both individual vendors and the collective of vendors.

Recent studies in ITO have investigated how vendor opportunistic behaviour is mitigated in outsourced IT services in a single vendor setting (e.g., Lioliou and Zimmermann 2015; Mathew and Chen 2013). Vendor opportunism in an ITM setting goes beyond the client-vendor dyad into a network of client-vendor organizations. There is a potential for collusion of vendors when there are increased synergies and information exchange among vendors and with the client losing control over what information is exchanged among vendors (Choi et al. 2002; Wiener and Saunders 2014). Other risks can be vertical integration by vendors into client's business and competing with client, and collusive activities of vendors like price-fixing, anti-competitive conduct such as reduce competition by partitioning market which shift power and cost structure towards benefitting the vendors and lead to appropriation risks for client (Choi et al. 2002). Even though there is little empirical evidence for such risks in ITM setting, their possibility cannot be ruled out altogether. Such instances of vendor collusion have been noticed in buyer-supplier networks in manufacturing (Choi et al. 2002) wherein it could be detrimental to buyer

firm's performance and therefore is an important concern for buyers. Another kind of opportunistic behaviour that could prevail in multi-vendor network that caters to a single client is the manipulation of client's decisions by a dominant vendor in its favour with an intention to enhance its own position relative to the other vendors (Provan 1993). Table 1 provides a summary of different forms of vendor opportunistic behaviour as identified in the ITO & ITM literature and other studies. These forms are drawn from the theoretical perspectives of TCE, agency theory, incomplete contracts theory and power-dependence view which offer bases for identifying a variety of opportunistic behaviours and the associated drivers. Such a multi-theoretical approach has been used by several studies that have researched opportunism in a variety of settings, for instance, Aubert et al. (2005) uses TCE and agency theory in IT outsourcing; Crosno and Dahlstrom (2008) uses four theoretical perspectives namely institutional economics, resource dependence theory, relational contracting theory and behavioural perspective) in marketing, etc.

<b>Strategic risk/ opportunistic behaviour</b>	<b>Theory</b>	<b>Key contributing factors</b>	<b>Representation in Studies</b>
Withholding /distorting information	Agency theory, TCE	Information asymmetry	Can occur any time, ex-ante or ex-post. Overstating capabilities, hiding information (Bahli & Rivard 2013); sometimes subsumed under 'shirking' (Clemons et al. 1993)
Shirking	Agency theory	Low observability of effort  Low verifiability of output	Underinvestment in training, equipment and other facilities, lack of effort, assigning under-skilled staff (Aubert et al. 1999; Mathew and Chen 2013); Wilful underperforming (Clemons et al 1993); Refraining from making noncontractual specific investment; Complacency reflected in its attitude of 'take-it-or-leave-it' and not focusing on improving quality (Wiener and Saunders 2014)  Imperfect commitment – renegeing on explicit or implicit commitments, not fulfilling obligations and promises (Jap and Anderson 2003)
Misappropriation	TCE	Lock-in Asymmetric Dependence Resource dependence  Power asymmetries among vendors	Wilful exploitation of dependence (Nooteboom et al. 1997); Haggling, appropriation of surplus (Ravindran et al. 2015); Poaching, intellectual property issues, confidentiality breaches like leaking client's proprietary information to third parties, unapproved use for own benefit (Clemons & Hitt 2004; Mathew & Chen 2013)  Misuse of power by dominant or lead vendor (Provan 1993)
Maladaptation	TCE	Lack/loss of bargaining power  Small numbers bargaining Rigid contracts, incomplete specifications	Inflexibility, refusal by vendors to adapt (Wathne and Heide 2000)

<b>Strategic risk/ opportunistic behaviour</b>	<b>Theory</b>	<b>Key contributing factors</b>	<b>Representation in Studies</b>
Forced renegotiation / Price escalation	TCE	Lack/loss of bargaining power, Small numbers bargaining, Incomplete contracts-unforeseen contingencies	Haggling and negotiating for concessions, ex-post increase in costs (Wathne and Heide 2000)
Hold-up	TCE	Small numbers bargaining	Underinvestment and inefficient bargaining collectively called hold-up (Susarla et al. 2010)
Loss of flexibility	Incomplete contracts theory	Incomplete contracts - unforeseen contingencies; Lock-in	Losing the ability 'to change the extent, nature and scope of services' (Tan and Sia (2006)
Free-riding	Agency theory	Task interdependence, Low task visibility Low effort observability Low output verifiability	Vendors enjoying benefits by withholding effort in joint tasks (Bapna et al. 2010; Jones 1984)
Collusive activity of vendors	TCE	Goal congruence Small numbers bargaining Interrelated vendors	Price-fixing by vendors (Choi et al. 2002; Wiener and Saunders 2014); collusive activities by interrelated vendors (Su and Levina (2011); anti-competitive conduct (Choi et al. 2002)
Opportunism in networks of multiple suppliers	Power-dependence perspective	Client-vendor dependence; Power asymmetry	Vendor (dominant) influencing client decisions to enhance one's own position relative to others (Provan (1993))

Table 1. *Vendor Opportunistic Behaviour: Forms and Contributing Factors*

### 3 Role of IT Multisourcing in mitigating Vendor Opportunism

Risk-mitigation mechanisms help reduce the likelihood of occurrence of potential negative scenarios by reducing the intensity of risks or preventing the risks altogether (Bahli and Rivard 2003, 2013). In this regard, ITO literature has investigated the effectiveness of a variety of risk-mitigation mechanisms such as contractual safeguards, network embeddedness, relational mechanisms, psychological contract, social capital, monitoring and control in curbing opportunism in a dyadic setting (Chang et al. 2017; Lacity et al. 2009; Mathew and Chen 2013; Ravindran et al. 2015). Though a variety of risk-mitigation mechanisms have been discussed in ITO literature, ITM is essentially different as it moves beyond a dyad into a network of client-vendor organizations. ITM is based on the idea that competition between multiple vendors can be used to drive cost reductions for client (Porter 1985) thereby reducing the opportunistic rent appropriation by any one vendor (strategic risk) (Aron et al. 2005). It provides an opportunity to reduce client's dependency and vulnerability with respect to any single vendor without having to reduce the overall degree of outsourcing (Currie and Willcocks 1998; Levina and Su 2008). As noted earlier, risk implications of ITM is an understudied area and the only framework for

understanding the impact of ITM on strategic risks, by Su and Levina (2011), focuses on two dimensions of vendor-base (breadth and depth) while omitting other constituent elements of ITM. In the next section the constituent elements of ITM are identified from literature and the key mechanisms such as vendor competition, bargaining power, mutual monitoring and information exchange, which influence vendor opportunistic behaviour are explained. The focus of the paper is on those attributes of ITM that have a bearing on vendor opportunism. We identify these attributes as pertaining to strategy, division of work, network structure and governance.

### **3.1 Strategy**

Sourcing strategy reflects the choices made about IT services such as how they are sourced (from internal or external vendors), sourcing location, degree of outsourcing and pricing. In ITM additional choices include the number of vendors and their skillsets, and tiering of vendors according to their strategic importance for the client. In ITM, the use of multiple vendors induces vendor competition. It can enhance the power position of client with respect to the dominating vendor through engagement with multiple vendors who are alternative sources for acquiring resources (Huang et al. 2004). In outsourcing of IT services that require significant customization, the dependency on vendor is even more when it involves tacit knowledge and relationship specific investments. Overlap in vendor areas of expertise is found to be useful in inducing constant competition among vendors while also reducing the dependence of client on any single vendor (Wiener and Saunders 2014).

#### **3.1.1 Bargaining power as mechanism**

Bargaining power is defined with respect to contractual relationships as ‘the ability of one party to a contract to be able to influence the terms and conditions of that contract or subsequent contracts in its own favour’ (Argyres and Liebeskind 1999). From a TCE perspective ITM acts as a safeguard in situations where bargaining power is skewed towards vendors, and curbs the vendor opportunistic behaviours of holdup and thereby preventing cost escalations (Bahli and Rivard 2013). Vendor-base breadth or ‘number of vendors’ (Su and Levina 2011), has significant positive influence on the relative bargaining power of client (restricting vendor bargaining power) which in turn deters vendor opportunistic behaviours of ex-post renegotiation and vendor inflexibility.

#### **3.1.2 Vendor competition as mechanism**

Competition refers to a situation wherein several actors in a market produce and market similar products or services, and firms compete to achieve above-average profits and derive competitive advantage (Osarenkhoe 2010). Having more than one vendor leads to a more competitive environment for vendors. Price competition may be witnessed during bidding for client projects when vendors compete in acquiring new business opportunities from client. It leads to performance benefits in the form of lower IT service costs and improved quality (Wiener and Saunders 2014). It also safeguards against ex post forced renegotiations and price escalations when switching costs are low (Su and Levina 2011). Reduced contract size and duration along with frequent bidding will lead to ongoing vendor competition (Wiener and Saunders 2014). The number of vendors and the overlap in vendor expertise will have significant positive influence on the competition between vendors which deters ex post vendor opportunistic behaviour (Wiener and Saunders 2014) while also lowering the costs of negotiation for client, improving IT service quality and flexibility and reducing vendor dependency (Aubert et al. 2016).

### **3.2 Division of Work**

By dividing tasks among multiple vendors ITM brings transparency in the activities which were hitherto covered under a single vendor, by making tasks more visible and allowing for scrutiny by client (Wiener and Saunders 2014). On the other hand, vendors with interdependent tasks will be able to monitor one another even when their outputs are not measurable. In either way, shirking by vendors will be curbed. But such mitigating effects depend on whether or not tasks are divided in a way to increase observability of effort as well as outputs. The task interdependence between vendors is considered a key differentiating feature of ITM (Bapna et al. 2010).

#### **3.2.1 Task interdependence**

Task interdependence can be of three types that differ in terms of task relationships– pooled, sequential, reciprocal (Thompson 1967). Pooled interdependence among vendors in an ITM setting corresponds to ‘part-whole’ relationship between tasks carried out by vendors wherein the contributions of each vendor are discrete and the interactions between tasks may not be direct but rather each task has a role to play in contributing to the end-to-end service delivery to clients. In sequential interdependence, the output of one vendor’s task becomes input for another vendor in unidirectional way. In reciprocal

interdependence vendor's activities become inputs for each other's activities, which requires wider fit between their activities and extensive information exchange.

Varying levels of task interdependence are associated with varying levels of task visibility and information exchange for vendors and client (Jones 1984). Pooled, sequential and reciprocal interdependence correspond to increasing levels of interdependence. Two main risks that are associated with high task interdependence between vendors are shirking (underinvestment of effort) and free-riding (gaining rewards or consuming output without contributing to it) (Jones 1984). In pooled interdependence minimal communication is required between vendors and yet the effort of vendors is discrete and can be monitored. Sequential interdependence would need vendor interaction since inputs/outputs ensuing from one vendor flow to another. In reciprocal interdependence the effort of vendors is less discrete and may be difficult to measure, but observable to the other dependent vendors. Mutual monitoring and high information exchange are possible in reciprocal interdependence. Even when performance evaluation is not possible, shirking and free-riding can be curbed depending on how tasks are grouped to induce transparency. However, when joint effort is needed, high interdependence could lead to free-riding problems (Jones 1984). When the contributions of individual vendor with respect to the final product cannot be distinguished from group effort, it leads to the problem of free-riding. Therefore reciprocal interdependence could lead to free-riding and shirking, and pooled interdependence may be effective to curb shirking since it makes each vendor's distinct contribution more visible.

### **3.3 Network Structure**

#### **3.3.1 Effects of Vendor Embeddedness**

Another key characteristic of ITM is that it comprises of many client-vendor dyads forming a network of relationships among client and vendors. In such a network where all vendors are focussed on catering to a single client, any client-vendor relationship is 'embedded' in the larger network, and such embeddedness has the potential to limit opportunistic behaviour (Granovetter 1985). More specifically in buyer-supplier networks the embeddedness of vendor can occur in two ways - vendor's dependence on client and connectedness of vendor with other vendors (Provan 1993). The key argument in this regard, is that vendor embeddedness is high when both these are high thereby directly curbing any opportunistic behaviour of the vendors. Networks can allow high exchange of information (Ravindran et al 2015), thereby any opportunistic behaviour of vendors will be known across the network members. Under high dependence of vendors on the network and when their actions affect the entire network it creates 'outcome interdependence' among vendors and they refrain from opportunistic behaviour (Provan 1993). The position of vendor in the network will provide informational and reputational advantages (Kim 2014) which will be lost if vendor resorts to opportunistic behaviour. The network provides social monitoring benefits (Kim 2014) and flow of information about markets and vendor behaviour among the members of the network (Ravindran et al. 2015). Therefore, network acts as a safeguard against all forms of opportunistic behaviour caused by lack of observability of vendor effort, information asymmetry and violations of formal and informal norms. Vendor is likely to refrain from behaving opportunistically as this could lead to long-term repercussions in the form of exclusion from network and future deals, along with reputation damage (Provan 1993). But such high information exchange and the synergies that arise therein may prompt vendors to undertake collusive activities such as price fixing (Su and Levina 2011).

#### **3.4 Governance Structure**

The choice made in governing the network of client-vendors can also influence vendor opportunistic behaviour. Current literature loosely refers to two ways of organizing ITM – 'direct' and 'mediated' models. In a direct model the client directly interfaces with multiple vendors whereas in a mediated model the client chooses a vendor to act as a single point of contact to coordinate with other vendors (Bapna et al. 2010; Wiener and Saunders 2014). In this study we consider two broad options of direct and mediated ITM models, depending on whether a client, or a vendor (lead vendor) chosen by client, handles key governance activities of monitoring, implementation of standards and procedures, risk audit. A lead vendor provides services to client much like other vendors, but additionally coordinates governance activities. It influences the information flow between client and vendors as well as among vendors. When a lead vendor handles governance activities, there is a chance of the vendor resorting to manipulation of client decisions favouring oneself (Provan 1993). ITM research in this area of mediated models is scarce. In the context of ITM and ITO it refers to fostering overall coordination of the ITM arrangement by acting as a bridge between vendors and buyer, handling dispute resolution, monitoring and implementing standards and procedures. However, lead vendor doesn't have direct contracts with

other vendors, so the power of lead vendor mainly comes by being more closely associated with the client, controlling information flow and from holding high competencies, which are very essential for intermediaries (Mahnke et al. 2008). Different governance structures are likely to bestow different levels of power on client and vendors (Provan and Kenis 2008) which in turn could lead to different influences on the behaviour of network members as well as exert influence on the decisions of network members.

### 3.5 Summary

We have identified various ITM attributes corresponding to the ITM sourcing strategy, work division, network of client-vendors and governance of the network and provide a more comprehensive and generalized view of the constituent elements of ITM. While describing these attributes we have also identified their association with different mechanisms which in turn affect vendor opportunistic behaviour. Our analysis has revealed the dual effects i.e., mitigate and induce/aggravate, of ITM attributes on vendor opportunism risks. The findings are synthesized and presented as a research framework in the following section.

## 4 Research Framework

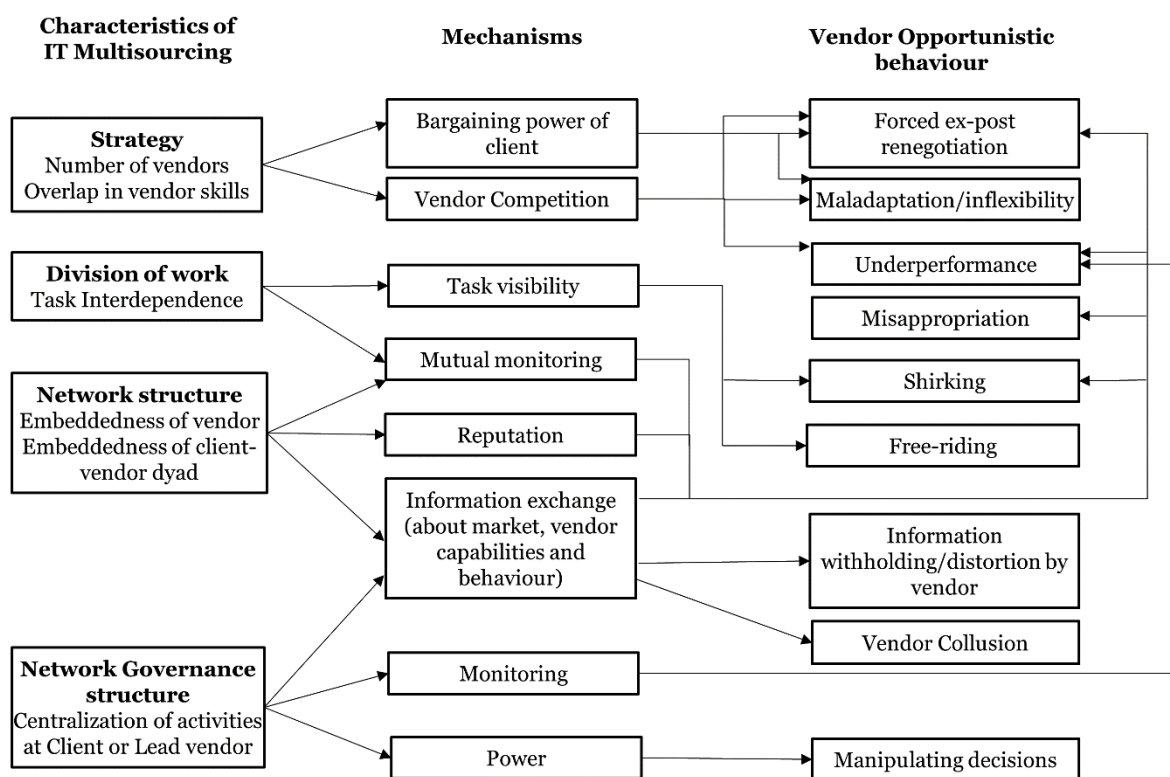

Figure 1: Research framework: Explaining the implications of ITM for vendor opportunistic behaviour

Literature on sourcing risks, in general, has extensively studied risk-mitigation mechanisms (Lacity et al. 2009) and qualitatively compared the risk-benefit implications of various forms of ITO (Angst et al. 2017; Currie and Willcocks 1998). But the effect of specific sourcing forms on risk mitigation has received less attention (Heide et al. 2014). Similar is the case of ITM where there is a lack of systematic analysis of the risk-mitigation mechanisms associated with it. By focussing on ITM attributes we have highlighted the multiple ways in which ITM can mitigate or induce vendor opportunistic behaviour. ITM improves the bargaining power of clients relative to vendors in asymmetric power situations (Bahli and Rivard 2013; Huang et al. 2004), induces competition among vendors (Wiener and Saunders 2014), can offer mechanisms of reputation and mutual monitoring by vendors, can provide information exchange conduits owing to its network characteristics, all of which act as safeguards against various forms of vendor opportunistic behaviour. Certain features of ITM, though, may lead to vendor opportunistic behaviours of free-riding, shirking and vendor collusion. Figure 1 presents the research framework summarizing the key characteristics of ITM attributes, their influence on risk mitigating mechanisms and how they impact specific types of vendor opportunistic behaviour.

The framework shows that there are many-to-many relationships between ITM attributes and

mechanisms and between mechanisms and forms of vendor opportunistic behaviour. While the number of vendors and overlap in their skills directly influence vendor competition, information exchange between vendors is influenced by the structures of task, network and governance. In cases where direct and extensive monitoring by clients is not feasible, these various structures in ITM enable mutual monitoring among vendors and information exchange both of which are crucial to curb several forms of opportunistic behaviour of vendors. However, it is also observed that some ITM attributes which are useful in curbing some forms of opportunism could aggravate other forms of vendor opportunism. The framework therefore presents the trade-offs involved with each of the ITM attributes.

## 5 Discussion

The framework presented several features of ITM that were hitherto unexamined in the context of mitigating vendor opportunistic behaviour and it can be used for setting a research agenda for ITM's impacts on vendor opportunistic behaviour. Many ITM attributes have been found to be under-researched in terms of their implications for vendor opportunism. The dual effects of various attributes in terms of mitigating and inducing various forms of vendor opportunism are to be clearly understood in order to make better choices for ITM. For instance, the effects of interdependence of vendors determine the extent of cooperation and coordination among vendors and yet such increased coordination through increased information exchange may potentially lead to vendor collusion. It can also expose vendors to input and output risks from other vendors (Bapna et al. 2010). This leads us to the question of the extent of desirability of vendor interdependence in ITM and how can this be managed to safeguard client and vendors against opportunism. Embeddedness effects in ITM are largely unexplored. With respect to governance a key question that remains to be addressed is-What is the effect on vendor opportunistic behaviour when a client is directly governing them or when governance activities are delegated to a vendor? The implications of power of buyers and lead vendor in controlling vendor opportunistic behaviour is an uncharted domain in ITM literature. Whether certain work division choices promote task visibility better than others, is to be studied in ITM. Although interdependence has been discussed from both the task design and network structure perspective and both views appear to have the potential to curb risks of opportunistic behaviour, the connection between the two is yet to be investigated in ITM setting. It requires further investigation to understand whether task interdependence is essential for forming ties between vendors since ITMs are often characterized by short contract durations, and if network structure and task structure can independently be effective safeguards in ITM settings. While an attempt has been made to include a comprehensive list of opportunism forms and ITM attributes, there are several concepts which couldn't be taken up in this study such as goal congruence of vendors, multiple valences of vendor-vendor relationships, to name a few. Setting individual and overall goals for vendors is also a key aspect of organizing ITM. In inter-organizational setting goal incongruence often leads to issues of non-commitment and non-cooperation. How individual and collective goals of vendors are set and how they influence opportunistic behaviour of vendors such as free-riding and shirking are to be studied in ITM. Several other such concepts related to ITM may be added to the framework when studying in depth the implications of a particular set of ITM attributes for risk. While the individual relationships between ITM features and mechanisms have been described in the framework, the interaction effects of these various ITM features have not been addressed in the framework. This is also an area open to research in ITM. For instance, when task interdependencies exist among vendors along with competition, it could lead to adverse effects by hampering vendor cooperation. More investigation is needed on the specific interactions among competition, interdependence and social ties among vendors and ways to balance these in order to achieve risk-mitigation.

The dual effects of ITM attributes call for research on which configuration of ITM attributes will provide optimal risk-mitigation. This framework could be used to further investigate the appropriate controls to be used without incurring huge costs to curb various risks that arise in ITM settings from both individual vendors and the collective of vendors. Problems of commitment that arise from incentive misalignment in vendors also pose risks to client. Though not considered in this study, it has been identified as a potential area of research (Bapna et al. 2010). Future studies could also use concepts from this framework to focus on other forms of risks such as loss of flexibility, operational and security risk; and other outcomes of interest.

## 6 Conclusion

The study takes a risk perspective of ITM and explains theoretically how ITM offers multiple ways to safeguard against some forms of vendor opportunistic behaviour while inducing some others. By using

a more comprehensive conceptualization of the constituent elements of ITM the framework offers a basis for developing a common ground to consolidate findings across seemingly different ITM arrangements. Thus it addresses the limitation of ‘fragmented conceptualization’ of ITM. It also offers nuances of differing implications of a given ITM attribute on various forms of vendor opportunistic behaviour. It thereby presents a more contrasting view of ITM than earlier studies and offers explanation for the contradictory views expressed about risk implications of ITM. Thus we have addressed both the limitations that we have identified earlier with ITM literature. This research can be extended to consider the operationalization of various concepts discussed in the framework and carry out multiple empirical studies focusing on risks or other outcomes of interest. Such studies will benefit from using a conceptualization of different ITM models in terms of their underlying attributes so that their findings can be comparable. Such studies can use these ITM attributes to study even other outcomes of interest like value. Our future empirical study will draw from this research framework and build a more nuanced empirical research model with the specifics of ITM governance and its implications for vendor opportunism.

## 7. References

- Angst, C. M., Wowak, K. D., Handley, S. M., and Kelley, K. 2017. “Antecedents of Information Systems Sourcing Strategies in US hospitals: A Longitudinal Study.,” *MIS Quarterly* (41:4), pp 1129-1152.
- Argyres, N. S., and Liebeskind, J. P. 1999. “Contractual commitments, bargaining power, and governance inseparability: Incorporating history into transaction cost theory,” *Academy of management review* (24:1), pp. 49–63.
- Aron, R., Clemons, E. K., and Reddi, S. 2005. “Just right outsourcing: understanding and managing risk,” *Journal of Management Information Systems* (22:2), pp. 37–55.
- Aubert, B. A., Dussault, S., Patry, M., and Rivard, S. 1999. “Managing the risk of IT outsourcing,” in *Systems Sciences, 1999. Proceedings of the 32nd Annual Hawaii International Conference on System Sciences*, , p. 10–pp.
- Aubert, B. A., Patry, M., and Rivard, S. 2005. “A framework for information technology outsourcing risk management,” *ACM SIGMIS Database : the DATABASE for Advances in Information Systems*, 36(4), pp.9-28. (36:4), pp. 9–28.
- Aubert, B. A., Saunders, C., Wiener, M., Denk, R., and Wolfermann, T. 2016. “How adidas Realized Benefits from a Contrary IT Multisourcing Strategy.,” *MIS Quarterly Executive* (15:3).
- Bahli, B., and Rivard, S. 2003. “The information technology outsourcing risk: a transaction cost and agency theory-based perspective,” *Journal of Information Technology* (18:3), pp. 211–221.
- Bahli, B., and Rivard, S. 2013. “Cost escalation in information technology outsourcing: A moderated mediation study,” *Decision Support Systems* (56), pp. 37–47.
- Bapna, R., Barua, A., Mani, D., and Mehra, A. 2010. “Research Commentary-Cooperation, Coordination, and Governance in Multisourcing: An Agenda for Analytical and Empirical Research,” *Information Systems Research* (21:4), pp. 785–795.
- Bunker, D., Hardy, C., Babar, A., and Stevens, K. J. 2016. “Exploring Practitioner Perspectives of Sourcing Risks: Towards the Development of an Integrated Risk and Control Framework,” *Australasian Conference on Information Systems, Adelaide, South Australia* .
- Chang, Y. B., Gurbaxani, V., and Ravindran, K. 2017. “Information Technology Outsourcing: Asset Transfer and the Role Of Contract.,” *MIS Quarterly* (41:3), pp. 959-973.
- Choi, T. Y., Wu, Z., Ellram, L., and Koka, B. R. 2002. “Supplier-supplier relationships and their implications for buyer-supplier relationships,” *IEEE transactions on engineering management* (49:2), pp. 119–130.
- Clemons, E. K., and Hitt, L. M. 2004. “Poaching and the misappropriation of information: Transaction risks of information exchange,” *Journal of Management Information Systems* (21:2), pp. 87–107.
- Clemons, E. K., Reddi, S. P., and Row, M. C. 1993. “The impact of information technology on the organization of economic activity: The ‘move to the middle’ hypothesis,” *Journal of management information systems* (10:2), pp. 9–35.



- Cohen, L., and Young, A. 2006. *Multisourcing: Moving beyond outsourcing to achieve growth and agility*, Harvard Business Press.
- Crosno, J. L., and Dahlstrom, R. 2008. "A meta-analytic review of opportunism in exchange relationships," *Journal of the Academy of Marketing Science* (36:2), pp. 191–201.
- Cross, J. 1995. "IT outsourcing: British Petroleum's Competitive Approach," *Harvard Business Review*.
- Cullen, S., Seddon, P. B., and Willcocks, L. P. 2005. "IT outsourcing configuration: Research into defining and designing outsourcing arrangements," *The Journal of Strategic Information Systems* (14:4), pp. 357–387.
- Currie, W. L. 1998. "Using multiple suppliers to mitigate the risk of IT outsourcing at ICI and Wessex Water," *Journal of Information Technology* (13:3), pp. 169–180.
- Currie, W. L., and Willcocks, L. P. 1998. "Analysing four types of IT sourcing decisions in the context of scale, client/supplier interdependency and risk mitigation," *Information Systems Journal* (8:2), pp. 119–143.
- Dibbern, J., Goles, T., Hirschheim, R., and Jayatilaka, B. 2004. "Information systems outsourcing: a survey and analysis of the literature," *ACM SIGMIS Database the DATABASE for Advances in Information Systems'*, (35:4)ACM, pp. 6–102.
- Everest. 2018. "Upcoming Contract Renewals-Application services," *Everest Group Research*, Everest Global, Inc. .
- Gefen, D., Wyss, S., and Lichtenstein, Y. 2008. "Business familiarity as risk mitigation in software development outsourcing contracts," *MIS quarterly*(32:3), pp. 531–551.
- Goldberg, M., Kieninger, A., and Fromm, H. 2014. "Organizational models for the multi-sourcing service integration and management function," in *Business Informatics (CBI), Geneva*, pp. 101–107.
- Granovetter, M. 1985. "Economic action and social structure: The problem of embeddedness," *American journal of sociology* (91:3), pp. 481–510.
- Heide, J. B., Kumar, A., and Wathne, K. H. 2014. "Concurrent sourcing, governance mechanisms, and performance outcomes in industrial value chains," *Strategic Management Journal* (35:8), pp. 1164–1185.
- Huang, R., Miranda, S., and Lee, J.-N. 2004. "How many vendors does it take to change a light bulb? Mitigating the risks of resource dependence in information technology outsourcing," In *Proceedings of Twenty-Fifth ICIS, 2004*, pp. 311–323.
- Jap, S. D., and Anderson, E. 2003. "Safeguarding interorganizational performance and continuity under ex post opportunism," *Management Science* (49:12), pp. 1684–1701.
- Jones, G. R. 1984. "Task visibility, free riding, and shirking: Explaining the effect of structure and technology on employee behavior," *Academy of Management Review* (9:4), pp. 684–695.
- Kim, D.-Y. 2014. "Understanding supplier structural embeddedness: A social network perspective," *Journal of Operations Management* (32:5), pp. 219–231.
- Koo, Y., Lee, J.-N., Heng, C. S., and Park, J. 2017. "Effect of multi-vendor outsourcing on organizational learning: A social relation perspective," *Information & Management* (54:3), pp. 396–413.
- Lacity, M. C., Khan, S. A., and Willcocks, L. P. 2009. "A review of the IT outsourcing literature: Insights for practice," *The Journal of Strategic Information Systems* (18:3), pp. 130–146.
- Lacity, M. C., Khan, S. A., and Yan, A. 2016. "Review of the empirical business services sourcing literature: an update and future directions," *Journal of Information Technology* (31:3), pp. 269–328.
- Levina, N., and Su, N. 2008. "Global multisourcing strategy: the emergence of a supplier portfolio in services offshoring," *Decision Sciences* (39:3), pp. 541–570.
- Lioliou, E., and Zimmermann, A. 2015. "Vendor opportunism in IT outsourcing: a TCE and social capital perspective," *Journal of Information Technology* (30:4), pp. 307–324.
- Loboda, B. 2013. "Motives for Multisourcing in the IT Sector," *International Journal of Management and Economics* (38:1), pp. 46–66.

- Mahnke, V., Wareham, J., and Bjorn-Andersen, N. 2008. "Offshore middlemen: transnational intermediation in technology sourcing," *Journal of Information Technology* (23:1), pp. 18–30.
- Mathew, S. K., and Chen, Y. 2013. "Achieving offshore software development success: An empirical analysis of risk mitigation through relational norms," *The Journal of Strategic Information Systems* (22:4), pp. 298–314.
- Nooteboom, B., Berger, H., and Noorderhaven, N. G. 1997. "Effects of trust and governance on relational risk," *Academy of management journal* (40:2), pp. 308–338.
- Osarenkhoe, A. 2010. "A study of inter-firm dynamics between competition and cooperation-A coopetition strategy," *Journal of Database Marketing & Customer Strategy Management* (17:3-4), pp. 201–221.
- Porter, M. E. 1985. "Competitive advantage: creating and sustaining superior performance. 1985," *New York: FreePress* (43), p. 214.
- Provan, K. G. 1993. "Embeddedness, interdependence, and opportunism in organizational supplier-buyer networks," *Journal of Management* (19:4), pp. 841–856.
- Provan, K. G., and Kenis, P. 2008. "Modes of network governance: Structure, management, and effectiveness," *Journal of public administration research and theory* (18:2) pp. 229–252.
- Ravindran, K., Susarla, A., Mani, D., and Gurbaxani, V. 2015. "Social capital and contract duration in buyer-supplier networks for information technology outsourcing," *Information Systems Research* (26:2), pp. 379–397.
- De Sá-Soares, F., Soares, D., and Arnaud, J. 2014. "Towards a theory of information systems outsourcing risk," *Procedia Technology* (16), pp. 623–637.
- Su, N., and Levina, N. 2011. "Global multisourcing strategy: Integrating learning from manufacturing into IT service outsourcing," *IEEE Transactions on Engineering Management* (58:4), pp. 717–729.
- Susarla, A., Subramanyam, R., and Karhade, P. 2010. "Contractual provisions to mitigate holdup: Evidence from information technology outsourcing," *Information Systems Research* (21:1), pp. 37–55.
- Tan, C., and Sia, S. K. 2006. "Managing flexibility in outsourcing," *Journal of the Association for Information Systems* (7:4), pp. 179–206.
- Thompson, J. D. 1967. *Organizations in action*, New York: McGraw-Hill.
- Wathne, K. H., and Heide, J. B. 2000. "Opportunism in interfirm relationships: Forms, outcomes, and solutions," *Journal of marketing* (64:4), pp. 36–51.
- Wiener, M., and Saunders, C. 2014. "Forced coopetition in IT multi-sourcing," *The Journal of Strategic Information Systems* (23:3), pp. 210–225.
- Williamson, O. E. 1975. "Markets and hierarchies," *New York* (2630).
- Williamson, O. E. 1985. *The Economic Institutions of Capitalism: Firms, markets, relational Contracting*, Free Press.
- Williamson, O. E. 1993. "Opportunism and its critics," *Managerial and decision economics* (14:2)Wiley Online Library, pp. 97–107.
- Wüllenweber, K., Jahner, S., and Krcmar, H. 2008. "Relational risk mitigation: the relationship approach to mitigating risks in business process outsourcing 2008 41st Annual Hawaii International Conference on System Sciences, 7-10 Jan. 2008," *Waikoloa, HI, USA* .

**Copyright:** © 2018 Shroff Bandi. This is an open-access article distributed under the terms of the [Creative Commons Attribution-NonCommercial 3.0 Australia License](https://creativecommons.org/licenses/by-nc/3.0/), which permits non-commercial use, distribution, and reproduction in any medium, provided the original author and ACIS are credited.

# Guidelines for Using Pilot Projects in the Fourth Industrial Revolution

## João Barata

CISUC, Department of Informatics Engineering; ESTGOH  
University of Coimbra  
Pólo II, Pinhal de Marrocos, 3030-290 Coimbra, Portugal  
Email: [barata@dei.uc.pt](mailto:barata@dei.uc.pt)

## Paulo Rupino da Cunha

CISUC, Department of Informatics Engineering  
University of Coimbra  
Pólo II, Pinhal de Marrocos, 3030-290 Coimbra, Portugal  
Email: [rupino@dei.uc.pt](mailto:rupino@dei.uc.pt)

## Sharon Coyle

Business Information Systems  
University of Sydney Business School  
Australia, NSW 2006  
Email: [sharon.coyle@sydney.edu.au](mailto:sharon.coyle@sydney.edu.au)

## Abstract

Pilot projects are popular in companies for experimenting with industry 4.0 concepts. However, few studies have addressed the specificities of piloting transformation, whose requirements are quite different than those for implementing a project with clear goals. Pilot projects can be used for the purpose of exploring, demonstrating, optimizing and disseminating solutions. In this paper we identify the role of pilot projects in digital transformation and define a successful pilot project so that it transcends to a full project. We provide accessible guidelines for the deployment of pilot projects in industry 4.0, drawing from a structured literature review and from lessons learned in an action research project implementing mixed reality in household ceramics production. A sound approach to pilot projects is important to reduce unknowns and risks in ensuing full projects and to contributing to organizational knowledge, offering an opportunity to rethink business strategies and train employees in digital transformation.

**Keywords** fourth industrial revolution, industry 4.0, digital transformation, pilot projects, mixed reality.

## 1 Introduction

The ongoing fourth industrial revolution (referred to as industry 4.0 or i4.0) promises radical transformations in industry worldwide. It can be defined as the phenomena of digital transformation in industry supply chains, focusing on the individualization and decentralization of production systems, the integration of intra/inter organizational business processes and the adoption of new emerging technologies, such as autonomous robots, mobile systems, big data, Internet of Things, cloud computing, or mixed reality (Moeuf et al. 2018). The adoption of industry 4.0 is priority for industry managers, who are pressured to implement pilot projects in their organizations in order to test and steer digital transformation efforts (Bauer et al. 2016; PwC 2016).

Pilot projects can be defined as “mini”, small scale projects with the aim of evaluating feasibility and steering for full project developments (Lancaster 2015; Zbrodoff 2012). The importance of pilots for large project deployment is well documented. For example, to explore opportunities for future developments, minimize the risk of unexpected events, identify the benefits/difficulties of a project, and to assess the impact of interventions (Dremel et al. 2017; Fosso Wamba and Takeoka Chatfield 2011). Nevertheless, industry transformations involve “high-tech” investments and supply chain integration, creating difficulties for the adoption of traditional project management practices that put excessive emphasis on planning and control (Pajares et al. 2017). Technological advances and the uncertainty of their utility in practice increases the emphasis of ‘emergent’ projects (rather than ‘predictive’) whereby the need to understand risks increases (Williams 2017). This reality has blurred the vision of traditional pilot projects as mere “antecedents” of full projects. In fact, the literature reveals that the ongoing fourth industrial revolution is being implemented in practice as a sequence of multiple projects due to a lack of a universal approach to deal with the phenomena (Ganzarain and Errasti 2016).

To overcome the limitations of traditional project management, agile approaches have been proposed in different areas, most notably of which is software development (Dybå et al. 2014). These approaches suggest collaborative, iterative, and incremental advances. However, there are risks associated with evolving iteratively through large-scale, eventually expensive, and sometimes unrelated projects with uncertain results. The plethora of technologies involved in Industry 4.0 (e.g. big data, 3D printing, mixed reality) and its novelty in some sectors requires testing potential impact and evaluating organizational impact (Lasi et al. 2014). This leads to an expanding number of pilot projects and a necessity to integrate their use in digital transformation efforts. Contrasting with the third industrial revolution that focuses on introducing computers and automating processes, i4.0 involves a deeper integration between physical and digital worlds. The increasing complexity of cyber-physical transformations and the social impacts in industry requires (1) feasibility studies in different sectors of the economy, (2) guidelines to assist full project deployments, and (3) a deeper cooperation between industry departments and external stakeholders.

The above mentioned challenges and the conviction that “*digital transformation cannot be mastered in waterfall mode nor in blind flight*” (Gimpel et al. 2017) have inspired our research questions:

- **RQ 1.** How can we classify pilot projects for digital transformation in industry 4.0?
- **RQ 2.** What defines a successful i4.0 pilot project so that it transcends to a full project?

The next section introduces our research approach. In section 3 we include a review of related literature in pilot projects and their adoption in digital transformation settings. Subsequently, we present a pilot project with the aim to adopt mixed reality in the traditional sector of household ceramic production. Section 5 discusses the results and proposes guidelines to deploy pilot projects in industry 4.0 transformation. We close with study limitations and opportunities for future research.

## 2 Method

We selected action research as our research approach to study pilot projects in industry transformation initiatives. Action research is suitable for multifaceted organizational problems, considering their social and technical nature (Baskerville and Wood-Harper 1996). We have followed its canonical format (CAR), characterized by the five phases of *Diagnosing, Action planning, Action taking, Evaluating, and Specifying learning* (Susman and Evered 1978). Action research is “(...) one of the few valid research approaches that researchers can legitimately employ to study the effects of specific alterations in systems development methodologies. It is both rigorous and relevant”

(Baskerville and Wood-Harper 1996). To ensure rigor and validity, we have relied on the principles proposed by Davison et al. (2004). One of these principles is the definition of a frame of reference before initiation, which we have established using a review of important literature about pilot projects. This is presented in the next section and supports the discussion of our first research question (RQ 1): “*how can we classify pilot projects for digital transformation in industry 4.0?*” and provides the foundations for action planning in section 4.

### 3 Literature Review

We performed a structured literature review in Web of Science, Scopus and Google Scholar. The combination of keywords included "pilot project", "industry 4.0" but also related terms such as "digital transformation" and "pilot study" (for example, "pilot project" AND "digital transformation" in Web of Science returned 24 results using topic search on July 9<sup>th</sup>, 2018). We have included papers written in English and excluded non-peer-reviewed articles. Our purpose was to identify pilot projects explicitly developed for industry 4.0 and gather inspiration to propose guidelines for their implementation. Subsequent sections identify key characteristics of pilot projects. Next, we discuss how this particular classification of projects has been used for digital transformation.

#### 3.1 Pilot Projects

A pilot project aims to evaluate feasibility, assess and assist process design and guide dissemination, by describing the situation in detail (Eldridge et al. 2016; Kistin and Silverstein 2015; Zbrodoff 2012). Therefore, pilot projects must be managed differently when compared to full, mature projects because the goals may be to identify opportunities for the main project or to test particular elements of a larger plan (Zbrodoff 2012). We agree with Bassi (2010) when she states that a “*pilot will be a success if executed correctly*” and provides “*results that are reliable (whether ‘positive’ or ‘negative’)*”. The author highlights that piloting is not a synonym of incremental deployment and that a pilot project is not the first phase of a larger scale project. In fact, pilots have a learning purpose, to be better positioned to adjust and improve a larger project, reduce associated risks and prepare project team members (Bassi 2010).

There are recommendations for the development of pilot projects in Australia’s local governments. For example, Moretti and Spoehr (2017) suggests a stage-by-stage proposal: consulting with key stakeholders, designing projects capable of producing evidence, and analysing available options (analysis, forecasting and impact), adopting a collaborative approach, sharing and promoting the findings. Experimental approaches in policy development can serve multiple purposes such as exploring directions, verifying the effect of specific policies, demonstrating/legitimizing, or promoting the results of specific policies (Ko and Shin 2017).

There are two ways to use a pilot study in social research: (1) as a feasibility study, preceding the larger project; and (2) a pre-test of a specific research instrument. Pilots have the advantage of reducing risks, and identifying potential problems and opportunities for the main project (Pajares et al. 2017; Zbrodoff 2012). Nevertheless, there are also potential limitations of pilots, such as the lack of funding and the risk of wrong predictions to guide future interventions. Some reasons to conduct pilot studies include feasibility analysis, guiding the main project design, collecting preliminary data, team training or convincing stakeholders about the project interest (Kaur et al. 2017; Lancaster 2015).

Pilot projects can be proposed at national, sectorial or company levels, as suggested in Feng et al. (2018) for the Chinese industrial revolution process. An example of pilots addressing the textile sector is presented by Kemper et al. (2017). There are also Universities creating pilot factories of the future, for example TU Wien Pilot Factory Industry 4.0 (PFI40) that serves as a platform for research (Ansari et al. 2018). The purpose and characteristics of pilot projects vary in each case. At a national level, large-scale scenarios can be used to test interactions between different elements of major supply chains, inter-organizational communications and the development of national policies (Li 2018). An example of a national pilot project in Australia for Industry 4.0 higher apprenticeships is presented by Loveder (2017), which involves industry and academic partners. Sector-specific pilots can also be used to identify the potential of digital transformations and disseminate the results to other companies. In the case reported by TU Wien, the purpose is to create a simulation environment to assist research, providing greater potential for company-level interventions, contributing to new business models and business process redesign.

Pilot studies are extensively used in healthcare. For example, Kistin and Silverstein (2015) discuss the importance and potential misuses of this type of intervention (e.g. testing hypothesis with insufficient sample sizes). According to the authors, the main goal of pilot studies in clinical trials include testing

logistical aspects of the main project, optimizing its design, identifying barriers and facilitators, as well as exploring opportunities (Kistin and Silverstein 2015). We can also find practical guidelines to deploy ICT with pilot projects in other sectors of the economy such as the education sector (Bassi 2010). However, despite its popularity for industry 4.0, we could not find publications that present guidelines for pilot project design in industry 4.0 transformation processes.

Project management literature extends the concept of “feasibility/decision to proceed” and considers other possible outputs of pilot projects, namely, “*a fully useable product, service or process; and/or a template to create or replicate*” (Zbrodoff 2012). In both cases – social research and traditional project management – it is possible to identify the perspective of “decision support” (decision to go further, test feasibility before or during main project execution) and “operational guidance” (templates, product/service output), with a key priority: produce knowledge and contribute to future developments (Zbrodoff 2012). However, this is not always the main priority for industry managers, whose focus is primarily on fast results and concrete improvements of their processes and products.

### 3.2 Pilot Projects in Digital Transformation Initiatives

Major consulting companies recommend pilot projects as an important step for digital transformation initiatives. For example PwC suggests how pilot projects can “*establish proof of concept and demonstrate business value*” (PwC 2016), while McKinsey highlights their importance for impact estimation (Bauer et al. 2016). One significant reason for using pilot projects is that “*a large-scale Industry 4.0 rollout requires major investments in the overall technology stack*” (Bauer et al. 2016). Nevertheless, the interference of external consultants / ICT companies in pilot projects also presents risks of biasing the results or turning the pilot into a “sales pitch” for new products (Bassi 2010).

An iterative approach for industry 4.0 is presented in Khan and Turowski (2016), starting with the definition of the goals that need to be achieved. A cycle evolves in nine phases that are aligned with the Plan-Do-Check-Act approach and includes proofs of concept and continuous learning (Khan and Turowski 2016). The year-long pilot project presented by Flatscher and Riel (2016) highlights the importance of creating the project team and a shared understanding of the topic. This initial phase (a) can be compared to the goals and strategy definition presented in Khan and Turowski (2016). The case evolves to (b): the design of the “to-be” situation; (c): describing “as-is”; (d): identifying the gaps between both b and c; (e): clustering the deviation causes, and (f): describing each field of action, resources, and specific actions for each field.

Pilot projects can be implemented *as controlled environments* for i4.0, for example, a pilot city (Li 2018) or a pilot factory (Ansari et al. 2018). Pilots can be implemented *for demonstration* purposes, describing situations or proofs of concept. Pilot projects can also be implemented *as a process* to achieve the desired transformation (Dremel et al. 2017). Finally, pilot implementations are important for *illustration/dissemination*, as it happens in Alexopoulos et al. (2016), to exemplify the proposal of context-aware computing. Although we see the interest and relevance of all these possible applications of pilot projects, there are also potential limitations in their use, for example, to prove the benefits of specific projects in all its extension (Kistin and Silverstein 2015).

There are differences in the various global initiatives aimed at revolutionizing the industry with i4.0. For example, Made in China 2015 has selected the Ningbo as a pilot city “*to speed up the construction of its own industrial and manufacturing capability, collaborate with regional innovation systems, personnel training systems, and policy support systems, to create a healthy ecological environment and achieve diversity in development*” (Li 2018). In the equivalent European Industry 4.0 initiative we could not find a similar approach. In fact, while the implementation phases of industry 4.0 are not clearly defined, Made in China 2025 has clear goals and indicators (Li 2018).

Pilot projects also play a crucial role at company level, for example, in the digital transformation of Audi AG (Dremel et al. 2017). In their five-year evolution towards big data analytics, the initial two stages (over four years) included proofs of concept. Short term pilots were used (1) to identify the data analytics demands of each business unit (stage 1), (2) as “*illustrative pilot cases presented at a steering committee for strategic sales initiatives*” (p.85) to demonstrate the potential of big data, (3) to prepare the business cases for digital services (stage 3 – leveraging), and (4) to analyse specific data, create predictive capabilities and leverage car data.

There are four main purposes to adopt pilot projects in i4.0, namely, (1) *explore* emergent scenarios, (2) *demonstrate* feasibility, (3) *optimize* a specific situation proposing design principles (e.g. tune project plans), or (4) *disseminate* results that are important to a specific target group (e.g. roll-out). The most prevailing perspective points to pilot projects as “contribution for knowledge creation” while full projects provide a “contribution for company strategy”. We also found a prevalence of

technological focus in current industry 4.0 pilot projects (test the adoption of technologies in specific contexts) lacking studies that evaluate the social and organizational implications and the definition of guidelines in conducting pilot projects. The next section presents a recent pilot project developed in our action research project (Susman and Evered 1978).

## 4 Piloting Mixed Reality Adoption in Household Ceramics

This pilot project is part of a larger program aimed at studying and implementing industry 4.0 in traditional sectors of the economy. In this cycle, our research interest was the adoption of three main industry 4.0 technologies in a household ceramic company (HC), namely, mixed reality, cloud and mobile. We knew this company from past projects and their interest in conducting industry 4.0 pilot projects provided an opportunity to contrast our literature findings with a real situation.

### 4.1 Research Setting: Digital Transformation in a Traditional Industry

HC is a small household ceramic company created twenty-eight years ago. Their production was entirely built to client specifications and they have only recently considered strategies in exploring their own design. They employ fifty-four persons and have revenue of 2.5 M USD / year, exporting the majority of their production. The company established partnerships to create innovative products that include a mixture of ceramics and other materials (such as cork). Industry 4.0 is now a priority to HC managers that seek opportunities to differentiate their offerings with new technologies. Examples of HC's portfolio of products are presented in Figure 1.



*Figure 1: Product portfolio of HC (examples of decorative household ceramics)*

Household ceramics are produced with moulds and follow a traditional process of conformation, drying, surface treatment, firing, glazing, finishing and packaging. There are hundreds of different product references and each customer requires specific adaptations. A significant percentage of the company's sales is obtained from contracts closed in international trade fairs. The commercial department is particularly interested in the adoption of new technologies to interact with the customers during requirements analysis (e.g. shapes and sizes, colours, decorations). Providing end-user support is also a possibility (e.g. allowing hotels to test how a specific product looks in their facilities) using mixed reality.

In spite of the vast research in mixed reality technologies we could not find research papers or commercial applications focusing on the use of mixed reality for simulation in traditional household ceramics. Our pilot project also had social goals because company managers needed to sell the idea of industry 4.0 internally (involving commercial department, production, and design), as well as to their customers. It was intended that the pilot project could assist in the (1) internal communication with the team, (2) evaluation of the cost of producing the virtual models (and the potential gains compared to the normal process using physical samples of their products), and (3) dissemination of an image of innovation to their market as leaders in industry 4.0 in ceramics.

### 4.2 Action Taking: Mixed Reality in Household Ceramics

Having defined the main purposes of the pilot project in the previous section, we created a cloud-based mobile app for mixed reality using six different models for testing purposes.



Figure 2: Pilot development of a mixed reality app to simulate ceramic models (simulating two different model shapes in specific product lines)

Figure 2 illustrates the use of mixed reality to simulate different models in a specific environment (e.g. to contrast with other forms of the same product line). A menu on the top of the smartphone display enables selecting a different shape that can be evaluated when placed in real context. HC does not yet have many products with 3D representations but this is expected to change rapidly since they have recently purchased a 3D printer which they will use to create samples (for their customers) from digital 3D files. Besides placing virtual models in real contexts, we also developed additional functionalities for simulation in the app which are represented in Figure 3.



Figure 3: Simulating Dimensions, Colours, and Patterns (green virtual model incorporated in a real showroom; changing dimensions on the leftmost image and simulating patterns on the right)

Figure 3 presents the option to change dimensions, colours or patterns that can be applied to the ceramic product. It is possible to compare the virtual models with existing real models and identify improvements. The interface is simple and accessible to the customers, enabling the creation of screenshots of the desired product to send to the factory. The development of this pilot project had social and technical implications as we describe in the next section.

### 4.3 Results and Recommendations

Having described the client system infrastructure, our action plan to implement a pilot project for mixed reality in ceramics, and conducting action to produce change (Davison et al. 2004; Susman and Evered 1978), it is now important to evaluate the research results and the implications for theory and practice. The results of our pilot project were fourfold, as illustrated in Figure 4, in a proposed matrix that clarifies the four types of outcomes that we have identified earlier in our research, namely, (1) exploration, (2) demonstration, (3) optimization, and (4) dissemination. Although it is not indispensable that all pilot projects include the four outcomes, evidence from these four dimensions can contribute to increase the pilot value and discussion of the results.



<b>Exploration</b>	<b>Demonstration (proof / benefits / concerns)</b>
To our knowledge, this is the first adoption of mixed reality in household ceramic industry supply chain for simulation that takes advantage of 3D printing proliferation. We have explored (1) specific technologies for cloud/mobile/mixed reality development, (2) potential ceramic model attributes to simulate in marketing actions and (3) customers' expectations.	We have demonstrated the project benefits in the specific context of these traditional products. On one hand, it is possible to adopt mixed reality in ceramic production, taking advantage of the increasing use of 3D printing (and, consequently, of a growing 3D digital model database), promoting the collaboration between the design department, production, and marketing. The technology simplifies simulation and use of digital portfolios, overcoming the obvious limitations of transporting multiple real products to limited space trade fairs. On the other hand, colour simulation is still artificial when compared to real samples of the materials. Pattern simulation may exhibit problems depending on the format of the source 3D model file and UV mapping.
<b>Dissemination (internal / external)</b>	<b>Optimization (social / technical)</b>
The pilot project was useful to communicate the company strategy for industry 4.0 and the potential of mixed reality technologies. Being a traditional company, some of the employees and other stakeholders (e.g. senior shareholders, some customers and suppliers of raw materials for ceramic decoration) were not aware of i4.0 potential.	The app was iteratively improved to include a model database for scalability, ensuring that the solution could be effective with a larger number of models. Moreover, we have tuned the source model format to facilitate pattern simulation. The pilot project was also useful to train specific departments in new tools and to consider digitalization as a form to improve the company processes (in particular, in the design and marketing departments).

Figure 4: Pilot project matrix: summarizing main outcomes

The results in each cell of the matrix can vary depending on the project characteristics and its maturity. The industry 4.0 strategy was still in the early stages in our case company (pre-full project) justifying a high focus on the topmost cells (exploration and demonstration), however, optimization and dissemination outcomes were also possible to achieve.

The action-taking phase of CAR involved the exploration of mobile and mixed reality technologies using different models that could represent the majority of the product portfolio. Different company experts were involved in the project meetings to prepare the team in industry 4.0, gather improvement feedback and ensure comprehensive evaluation and dissemination of the results.

We concluded that a full project to adopt a mixed reality strategy in ceramic process is viable but it is advisable to take advantage of European funds for research and development due to the potential innovation for SMEs, the possibility to use more advanced virtual reality tools (e.g. smart glasses and smart gloves) and the potential cooperation between academia and industry. A detailed cost-benefit analysis (for example, time consumed for creating 3D models, rework to prepare model files for the app) concluded that leaders in the use of this technology can achieve commercial gains (e.g. in exclusive markets and customers that are using 3D printing as their main prototyping technology), but there are also risks to consider. The recommendations for full project deployment are:

- **Process:** Integrate the creation of virtual models for 3D printing (during manufacturing) and for interaction with the customer (simulation) in later phases. When creating models for printing, prepare the file format to also be used in the simulations with patterns.
- **Social:** Train the design department in the manipulation of 3D models. Disseminate the new app via social networks. Create a video to assist the end users. Create a network of amateur designers – competition with a prize for the best model created with HC app.
- **Technical:** Deploy an integrated product database, including functionalities to manage, search, and classify 3D models. The full project requires dynamic configuration of the product database (we used six models for testing purposes) and a link to a database of models and decorations (patterns). Optimize the simulation including the real dimensions and the equivalent reference for the painting process, according to the selected colour.
- **Organizational:** Extend the use of mixed reality in different sectors of the factory – opportunity for a new pilot project (in parallel with the full project) to assess the potential of the technology for quality control. Since the organizational value of the solution is not yet totally confirmed (impact in sales, customer satisfaction) it is necessary to include other areas of the organization.

- **Communication:** Conduct a public presentation of the system in global ceramic trade fairs. There are also opportunities for external communication via social networks and corporate websites. A technical article is another option (e.g. architecture magazines, decoration magazines) to improve the company's brand in the eyes of the end customer. Internally, the pilot project results should be disseminated in workshops involving all the employees.

Our pilot project assessment included a reflection about the company strategy for industry 4.0. We confirmed the potential use of mixed reality, cloud, and mobile technologies for digital transformation of household ceramics. It also contributed to dematerialization of the product design and simulation. The selected technology can be introduced with minor implications for the work process (social, technical and organizational). The company decided to extend a to full project to create the complete system with (1) a 3D model database, (2) management platform (system to manage the product catalogue, decorations, shapes, files and so on) and (3) smartphone app that allows dynamic product selection.

## 5 Discussion

Learning is a continuous endeavour in action research. This section summarizes key lessons for the development of pilot projects. It is the result of a joint reflection between researchers and practitioners. Pilot projects have the potential to produce value (1) transcending to a full project and (2) contributing to organizational knowledge and strategic reflection. A successful i4.0 pilot project depends on its effective contribution for knowledge and practice, preparing and supporting the sequent actions.

### 5.1 Focus on the strategic intent

Strategy blindness was the term used by Arvidsson et al. (2014) to describe a failure to realize a strategic intent of an implemented system capability. The authors point to three factors that can contribute to this effect: *"mistranslation of intent, flexibility of the IT artifact and cognitive entrenchment"* (Arvidsson et al. 2014). Effective pilot projects must be aligned with company strategy and their contribution (explore, demonstrate, optimize, and disseminate) should be stated. In our CAR, industry 4.0 adoption was the overall strategic intent which allowed us to focus the pilot project on specific technologies and also across organizational changes (such as people training, process redesign). The mere test of mixed reality technologies in a household ceramic context, although potentially interesting for technology providers (e.g. selling 3D printers or mobile app development) would be a limited perspective for a pilot project. Since "creating knowledge" is one of the main goals of pilot projects, investments must be carefully evaluated and aligned with a strategic intent.

### 5.2 Understand the project domain and set up a controlled environment

It can be stated that *"without a thorough and complete understanding of a research domain, a researcher may ask the wrong questions or formulate a meaningless hypothesis"* (Nunamaker et al. 1990). Similarly, industry 4.0 pilot projects require a complete description of the industry context. Pilot projects require a controlled environment (preferably, a part of the full project setting). The initial phase of project preparation and design must identify the parameters to be monitored (e.g. product cost, performance, customer satisfaction) and the metrics upon which to assess its achievement during pilot/full project execution. A control group is suggested (e.g. team, process, product) in order to compare the results of pilot implementation. The project team must be trained and a document structure should be implemented (e.g. procedures, project records).

### 5.3 Balance full project with the intrinsic value of the pilot project

"Piloting" does not have to be a mere confirmation that a concept works on a small-scale implementation. Proving that a system can be created (feasibility) also does not mean that it should be done. A pilot project must be of use in guiding a potential full project implementation, preparing the team, the plan, and understanding the potential impact of the system. Therefore, the value of a pilot project transcends the specific purpose of the full project and gains an intrinsic interest when it is incorporated into organizational knowledge. In our case company, the pilot project was designed for a specific technological transformation (mixed reality) but its development produced a rich combination of social and organizational benefits, namely, (1) training, (2) process redesign, (3) marketing strategies and (4) communication of the company's new strategy around digital transformation.

Depending on the lifecycle stage of the full project (pre-during-after), the pilot project requires a distinct approach. Pre-project phase in i4.0 requires quick analysis of the results, comparison of

technological alternatives, and potential impact in the value chain. The priorities are the project plan and team preparation. During project execution, the priorities must be the results of system implementation and internal dissemination. Multiple pilot projects can provide better evidence of the system impact. Post-project should focus on the overall impact of the system and its integration in the i4.0 strategy. Nevertheless, the effect of “knowledge creation” makes pilot projects useful during all the remaining stages of the full project, having benefits in being integrated in a pilot project portfolio. Pilot projects create potential for training the project team in new technologies, preparing the full project execution but also testing technologies and minimizing the risk of errors in future actions.

#### **5.4 Conduct a multidimensional assessment**

Our pilot project considered three main assessments. First, we conducted a deep assessment of the intervention domain and related literature. Second, we used the pilot project matrix to identify outcomes for (1) exploring, (2) demonstrating, (3) optimizing, and (4) disseminating. Third, we made recommendations for the next phases. A successful i4.0 pilot project requires reflection about the process (how), social (e.g. people training), technical (e.g. which technologies), organizational (e.g. business model impact), and communication strategy (in some cases, it is important to conceal strategic information from business competitors). In our case company, the pilot project was useful to train the full project team, redesign the marketing process to include mixed reality technology and identify metrics to monitor full project execution (e.g. time to create a 3D model).

#### **5.5 Unleash the power of pilot projects for communication and dissemination**

Industry 4.0 is an emergent concept. Therefore, it is still necessary to clarify the importance of digital transformation inside the organization (e.g. to involve different departments in the process) and outside, for example, to specific partners and most importantly, to customers. A controlled environment facilitates the selection of relevant information and the selective dissemination of pilot project results. During our pilot project we have evidenced improvements in industry 4.0 awareness and the need to cooperate between departments (e.g. design, and production). The participative approach to marketing innovation strengthens the perception of the customers’ needs inside the factory, and the contribution of industry 4.0 achieves competitive advantages in the market. It was an opportunity to train the team in i4.0 technologies and prepare future projects to innovate in traditional products. The context of “knowledge creation” is more favourable for documenting and communicating the results when compared to the complexity of full project implementation with enormous pressure to achieve tangible results for the organization. Consequently, pilot projects can also be useful in later stages of full project deployment (e.g. a small segment of the main project) to disseminate specific results to target stakeholders. We also recommend the creation of a pilot project portfolio for industry 4.0 strategies. The lessons learned in past pilot projects can be valuable later, for example, to assist in the reflection about problems in full projects, opportunities/difficulties in teams’ cooperation or as a memorization system (Le Moigne 1975) of the digital transformation process of the organization.

## **6 Conclusion**

Our paper has two main contributions to the areas of project management and industry 4.0. First (RQ 1), it selects four key roles of pilot projects in digital transformation for (1) exploring, (2) demonstrating, (3) optimizing, and (4) disseminating. These roles were identified in our literature review and applied in a real situation. Second (RQ 2), we outlined guidelines for successfully transcending to full projects in industry 4.0 scenarios. The findings emerged in a canonical action research (Susman and Evered 1978) project in a traditional ceramics industry with the strategic intent to adopt industry 4.0. Three major assessments are suggested for pilot projects, namely, the complete domain, the pilot project matrix and the recommendations for the full project (if it is decided upon to proceed).

This study has limitations that must be stated. First, there are natural restrictions in the databases and search terms used in our literature review. The research about pilot studies is vast, but the focus in industry 4.0 is scarce. Second, the guidelines for pilot projects are based on a real case but it is a single case, thus other carefully selected cycles can contribute to improve generalization. Third, although we have conducted a joint assessment of the results, the benefits of the pilot project were mainly qualitative and we don’t yet have quantitative evidence of cost reduction in the marketing process or specific increases in sales data to report. The company however, considered the results sufficient to decide to proceed to a full project but other evaluations of the pilot project are possible. Industry 4.0 carries additional complexity for project management, especially when involving multiple stakeholders

(Pajares et al. 2017). This complexity was apparent in our project, which leads to the fourth limitation; we could only involve one customer in this pilot project (albeit an important one).

We identified avenues for future research. First, continue the full project and a parallel pilot project for mixed reality in quality management. The evaluation of customers' receptiveness to new forms of product interaction is another priority. Second, we plan to improve the proposed matrix with additional information to obtain a pilot project canvas. This artefact will aggregate the pilot project information, which is useful for the project team and for communicating with external stakeholders. We hope that the guidelines can assist future pilot projects in digital transformation and we suggest using the pilot project matrix to clarify contributions to the full project and to the intended strategy.

## 7 References

- Alexopoulos, K., Makris, S., Xanthakis, V., Sipsas, K., and Chryssolouris, G. 2016. "A Concept for Context-Aware Computing in Manufacturing: The White Goods Case," *International Journal of Computer Integrated Manufacturing* (29:8), pp. 839–849.
- Ansari, F., Erol, S., and Sihm, W. 2018. "Rethinking Human-Machine Learning in Industry 4.0: How Does the Paradigm Shift Treat the Role of Human Learning?," *Procedia Manufacturing* (23:2017), pp. 117–122.
- Arvidsson, V., Holmström, J., and Lyytinen, K. 2014. "Information Systems Use as Strategy Practice: A Multi-Dimensional View of Strategic Information System Implementation and Use," *Journal of Strategic Information Systems* (23:1), pp. 45–61.
- Baskerville, R., and Wood-Harper, A. T. 1996. "A Critical Perspective on Action Research as a Method for Information Systems Research," *Journal of Information Technology* (11:3), pp. 235–246.
- Bassi, R. 2010. "Practical Guide to Pilot Projects and Large Scale Deployment of ICTs in the Education Sector," *GESCI: Global e-Schools and Communities Initiative*, p. 48.
- Bauer, H., Baur, C., Mohr, D., Tschiesner, A., Weskamp, T., and Mathis, R. 2016. "Industry 4.0 after the Initial Hype - Where Manufacturers Are Finding Value and How They Can Best Capture It," *McKinsey Digital*, Whitepaper. ([https://www.mckinsey.com/~media/mckinsey/business\\_functions/mckinsey\\_digital/our\\_insights/getting\\_the\\_most\\_out\\_of\\_industry\\_4\\_0/mckinsey\\_industry\\_40\\_2016.ashx](https://www.mckinsey.com/~media/mckinsey/business_functions/mckinsey_digital/our_insights/getting_the_most_out_of_industry_4_0/mckinsey_industry_40_2016.ashx)).
- Davison, R., Martinsons, M. G., and Kock, N. 2004. "Principles of Canonical Action Research," *Information Systems Journal* (14:1), pp. 65–86.
- Dremel, C., Herterich, M. M., Wulf, J., Waizmann, J.-C., and Brenner, W. 2017. "How Audi AG Established Big Data Analytics in Its Digital Transformation," *MIS Quarterly Executive* (16:2), pp. 81–100.
- Dybå, T., Dingsøyr, T., and Moe, N. B. 2014. "Agile Project Management," in *Software Project Management in a Changing World*, Springer Berlin Heidelberg, pp. 277–300.
- Eldridge, S. M., Lancaster, G. A., Campbell, M. J., Thabane, L., Hopewell, S., Coleman, C. L., and Bond, C. M. 2016. "Defining Feasibility and Pilot Studies in Preparation for Randomised Controlled Trials: Development of a Conceptual Framework," *PLoS ONE* (11:3), pp. 1–23.
- Feng, L., Zhang, X., and Zhou, K. 2018. "Current Problems in China's Manufacturing and Countermeasures for Industry 4.0," *EURASIP Journal on Wireless Communications and Networking* (2018:1), p. 90.
- Flatscher, M., and Riel, A. 2016. "Stakeholder Integration for the Successful Product–process Co-Design for next-Generation Manufacturing Technologies," *CIRP Annals - Manufacturing Technology* (65:1), pp. 181–184.
- Fosso Wamba, S., and Takeoka Chatfield, A. 2011. "The Impact of RFID Technology on Warehouse Process Innovation: A Pilot Project in the TPL Industry," *Information Systems Frontiers* (13:5), pp. 693–706.
- Ganzarain, J., and Errasti, N. 2016. "Three Stage Maturity Model in SME 's towards Industry 4.0," *Journal of Industrial Engineering and Management* (9:5), pp. 1119–1128.
- Gimpel, H., Hosseini, S., Huber, R. X. R., Probst, L., Röglinger, M., and Faisst, U. 2017. "Structuring Digital Transformation - A Framework of Action Fields and Its Application at ZEISS," *Journal*

- of Information Technology Theory and Application* (4801:1), pp. 31–54.
- Kaur, N., Figueiredo, S., Bouchard, V., Moriello, C., and Mayo, N. 2017. “Where Have All the Pilot Studies Gone? A Follow-up on 30 Years of Pilot Studies in Clinical Rehabilitation,” *Clinical Rehabilitation* (31:9), pp. 1238–1248.
- Kemper, M., Gloy, Y. S., and Gries, T. 2017. “The Future of Textile Production in High Wage Countries,” *IOP Conference Series: Materials Science and Engineering* (254).
- Khan, A., and Turowski, K. 2016. “A Perspective on Industry 4.0: From Challenges to Opportunities in Production Systems,” *Proceedings of the International Conference on Internet of Things and Big Data (IoTBD)*, pp. 441–448.
- Kistin, C., and Silverstein, M. 2015. “Pilot Studies: A Critical but Potentially Misused Component of Interventional Research,” *JAMA - Journal of the American Medical Association* (314:15), pp. 1561–1562.
- Ko, K., and Shin, K. 2017. “How Asian Countries Understand Policy Experiment as Policy Pilots?,” *Asian Journal of Political Science* (25:3), pp. 253–265.
- Lancaster, G. A. 2015. “Pilot and Feasibility Studies Come of Age!,” *Pilot and Feasibility Studies* (1:1), pp. 1–4.
- Lasi, H., Fettke, P., Kemper, H. G., Feld, T., and Hoffmann, M. 2014. “Industry 4.0,” *Business & Information Systems Engineering* (6:4), pp. 239–242.
- Li, L. 2018. “China’s Manufacturing Locus in 2025: With a Comparison of ‘Made-in-China 2025’ and ‘Industry 4.0,’” *Technological Forecasting and Social Change* (135:October 2018), pp. 66–74.
- Loveder, P. 2017. “Australian Apprenticeship: Trends, Challenges and Future Opportunities for Dealing with Industry 4.0.”
- Moeuf, A., Pellerin, R., Lamouri, S., Tamayo-Giraldo, S., and Barbaray, R. 2018. “The Industrial Management of SMEs in the Era of Industry 4.0,” *International Journal of Production Research* (56:3), pp. 1118–1136.
- Le Moigne, J. L. 1975. “The Four-Flows Model as a Tool for Designing the Information System of an Organization,” in *Information Systems and Organizational Structure.*, N. Grochla E., Szyperki (ed.), Walter de Gruyter, Berlin, pp. 324–341.
- Moretti, C., and Spoehr, J. 2017. “Valuing Social Outcomes in South Australian Local Government Research Stage Final Report.”
- Nunamaker, J. F. J., Chen, M., and Purdin, T. D. M. 1990. “Systems Development in Information Systems Research,” *Journal of Management Information Systems* (7:3), pp. 89–106.
- Pajares, J., Poza, D., Villafañez, F., and López-Paredes, A. 2017. “Project Management Methodologies in the Fourth Technological Revolution,” in *Advances in Management Engineering*, Springer, Cham, pp. 121–144.
- PwC. 2016. “Industry 4.0: Building the Digital Enterprise - Engineering and Construction Key Findings.” (<https://www.pwc.com/gx/en/industries/industries-4.0/landing-page/industry-4.0-building-your-digital-enterprise-april-2016.pdf>).
- Susman, G. I., and Evered, R. D. 1978. “An Assessment of the Scientific Merits of Action Research,” *Administrative Science Quarterly* (23:4), pp. 582–603.
- Williams, T. 2017. “The Nature of Risk in Complex Projects,” *Project Management Journal* (48:4), pp. 55–66.
- Zbrodoff, S. 2012. “Pilot Projects—making Innovations and New Concepts Fly,” in *PMI® Global Congress 2012*, Newtown Square, PA: Project Management Institute.

**Copyright:** © 2018 Barata, Cunha, and Coyle. This is an open-access article distributed under the terms of the [Creative Commons Attribution-NonCommercial 3.0 Australia License](https://creativecommons.org/licenses/by-nc/3.0/), which permits non-commercial use, distribution, and reproduction in any medium, provided the original author and ACIS are credited.

# The impact of Business Analytics on organisations: An Information Processing Theory perspective

## Maryamalsadat Shamekhi

Faculty of Business and Law  
Swinburne University of Technology  
Melbourne, Australia  
Email: mshamekhi@swin.edu.au

## Helana Scheepers

Faculty of Business and Law  
Swinburne University of Technology  
Melbourne, Australia  
Email: hscheepers@swin.edu.au

## Ashir Ahmed

Faculty of Health, Arts and Design  
Swinburne University of Technology  
Melbourne, Australia  
Email: azahmed@swin.edu.au

## Abstract

Over the last few years, the number of organisations adopting business analytics (BA) has grown rapidly. Organisations adopt BA to gain better insights on their processes and structures that help them to make more informed business decisions. There are several studies that investigate how BA systems can improve decision-making, create competitive advantage and provide value. Mostly, the focus of these studies have been on the technical aspects of BA and its implementation in areas such as supply chain management, marketing, and finance. However, there is a lack of significant body of literature reporting on the impact of BA adoption on organisations. This study aims to develop a richer understanding of BA capabilities and organisational impact. Information processing theory (IPT) as a theoretical lens is used to investigate this phenomenon. This study will utilise an in-depth case study to provide rich explanations on the impact of BA adoption on organisations.

**Keywords** Business analytics, information processing theory, information processing needs, information processing capabilities, fit, performance.

## 1 Introduction

Relevant data, is a highly valuable, meaningful and reliable resource for organisations; if used properly. Managers use Business Analytics (BA) tools and techniques to get valuable insights from the data that could eventually help them to improve their business process, structures and decision-making processes (Watson and Wixom 2007). Organisations invest in BA to create competitive advantage (Peteraf and Barney 2003) and achieve business targets using less resources (Seddon et al. 2017). Reasons identified for the increased interest in BA are: information technology advances, organisations' need to find a way to gather data from all resources, and meeting new challenges (such as big data - "*high volume, high velocity, and high variety*"(Watson 2014, p. 1249)). To process big data, organisations need new technologies, and consequently, BA adoption has increased. In addition, organisations face tougher competition in the marketplace, so they need to improve their decision-making systems to be faster and more accurate.

For the purposes of this study, BA is defined as a set of systems, technologies and techniques which analyse data to support a better understanding of organisational situations and making valid decisions (Chen et al. 2012). A review of the BA literature shows that many published studies investigate how different models of BA can be built and deployed in organisations (Chen et al. 2012; Wixom et al. 2013). Some other studies focus on the impact that BA has on industries such as supply chain (Cotic et al. 2012) or transportation (Iovan 2017). Despite these studies establishing a relationship between BA adoption and operational and financial performance improvement (Bedeley 2017), there are fewer studies which investigate how BA adoption impact organisational design.

Most of the literature focus on technical aspects of BA. In this study we argue that organisations need to understand their information process and how BA impact these. This study is going to explore what information process changes needs to occur to take advantages of BA. Adoption of BA in organisations is considered as an evolutionary process which is executed over and over in different departments of organisations (Seddon et al. 2017).

There are many organisations that use BA techniques with a variation in the outcome. To explain this variance, this study takes a particular perspective using Information Processing Theory (IPT). Furthermore, a conceptual framework based on IPT is developed which is used as a framework to gather in-depth perspectives from decision-makers and managers. The following research question will be addressed: How does the adoption of BA impact organisational design? To gain this in-depth knowledge, an interpretive case study will be conducted using interviews, observations and document analysis to collect data.

The structure of this paper is as follows: a literature review outlining BA capabilities, IPT as a theoretical lens and contributions followed by the proposed methodology.

## 2 Literature review

### 2.1 Business Analytics (BA)

BA is the use of data to drive decision-making and business actions (Davenport and Harris 2007). Broadly defined BA is '*the techniques, technologies, systems, practices, methodologies, and applications that analyse critical business data to help an enterprise better understand its business and market and make timely business decisions*' (Chen et al. 2012, p 1166). Using BA, information is transferred at the right time to the right person in the right forms (Bose 2009) assisting supply and demand integration, improved processing power, and advanced customer behaviour knowledge among others (Ramanathan et al. 2017).

The purpose of BA is to support insight to manage and develop the business (Musumano 2016). In many publications BA refers to different approaches for modelling different business situations, predicting customer behaviours and preferences, feasibility studies, anticipating risks and market preferences (Ray et al. 2013). Davenport and Harris (2007) argue that high performing organisations like Walmart, Netflix, and Amazon use analytics to inform their decision-making 50% more than low performing organisations. These organisations have managers who know the value of analytics. In addition, the return on investment (ROI) in the companies which are using BA on their projects, was 56% more (Davenport and Harris 2007).

Seddon et al. (2017) has brought together from the literature a number of models to show how BA contribute to business value. They argued the factors that influences the adoption of BA and they assumed BA adoption as an evolutionary process which is executed over and over in each departments.

Since BA is not a transient concept, misunderstandings may impact its growth trend. This research tries to make a brighter view of BA as well as present definitions and some perspectives and categories of BA. BA implementation is a complex process engaging technical and social aspects of organisations. Therefore, technical knowledge and organisational capacities are as important as the manager's commitment and sponsorship (Yeoh and Koronios 2010). Some other critical factors include organisational culture, infrastructure, and system quality (Yeoh and Koronios 2010). In other words, if the organisational processing requirements do not fit with its IPCs, the organisation can be less successful in adopting and implementing BA systems. One of the information system theories that posit a fit between IPCs and IPNs is IPT, which is discussed in the following section.

## 2.2 Information Processing Theory (IPT)

IPT was originally developed by Galbraith in 1973 as a framework for organisational design. This theory describes four critical concepts: IPNs, IPCs, Fit and Performance. The following section explains these concepts in more details.

### 2.2.1 Information Processing Needs (IPNs)

Galbraith (1973) identified uncertainty as the root of IPNs. Uncertainty is the difference between the amount of information that organisations already have and the amount that they need (Galbraith 1973). He argued that to attain an acceptable level of performance task uncertainty should be reduced. Daft and Lengel (1986) extend Galbraith's theory to include equivocality. This element includes a complex task that is not well understood is characterised by equivocality, and a task's concept may not be entirely comprehensible due to its incompatibility with the history and the current situation of the organisation. According to their theory, organisations need to reduce both uncertainty and equivocality at the same time to perform effectively.

### 2.2.2 Information Processing Capabilities (IPCs)

There are many mechanisms that can be used by managers to increase IPCs. Bensaou and Venkatraman (1995) classified these mechanisms into three basic types: structural mechanisms, process mechanisms, information technology mechanisms. Structural mechanisms describe relationship differences between organisational departments. Structural mechanisms include "Rules and procedures, direct contacts, liaison roles, integral roles, task forces and teams" (Daft and Lengel 1986, p. 560) and have three dimensions: *multiplicity* of information exchange, the *frequency* of information exchange and the extent of formalization of the information exchange (Bensaou and Venkatraman 1995). Process mechanisms refers to the socio-political processes that "affect the extent to which information is freely exchanged between the dyad members because or in spite of the nature of the structural mechanisms" (Bensaou and Venkatraman 1995, p. 1475). Information technology mechanisms refer to the use of information technology that increase the IPCs of organisations. The increase in IPC can facilitate organisational coordination (Bensaou and Venkatraman 1995). BA as a specific information technology system will be the focal technology studied.

### 2.2.3 Fit

Fit plays the most important role in IPT (Premkumar et al. 2005). One of the primary goals of managers is achieving a fit between IPNs and IPCs to improve the organisational performance and decision-making process (Daft and Lengel 1986; Premkumar et al. 2005). There are few studies which focus on fit in information systems literature (Bensaou and Venkatraman 1995; Premkumar et al. 2005). Galbraith and Nathanson (1978) have posed that "*although the concept of fit is a useful one, it lacks the precise definition needed to test and recognise that organisation has it or not*". Umanath (2003) investigated the conceptual and methodological meaning of fit argued that there are two major perspectives for fit - congruence and contingency. He proposed some statistical methods to analyse expressions of fit and identified three types of fit: a) fit as congruence, b) fit as contingency and, c) fit as holistic configurations. Venkatraman (1989) argued that fit has played an important role in several theories and areas such as strategic management, and organisational design. He has classified fit in six alternative perspectives: fit as moderation, fit as mediation, fit as matching, fit as gestalts, fit as profile deviation, and fit as co-variation.

Tushman and Nadler (1978) proposed fit as matching and argued that if organisations could match IPNs and IPCs, they would be more effective. They proposed Table 3 to show the relation between IPNs and IPCs, arguing that if departments have high uncertainty in tasks, they should employ high IPCs to attain the fit (Cell A). On the other hand, if a department faced less uncertainty, information processing mechanisms do not need to be complex (Cell D). In cell B, IPCs are not adequate to manage the



uncertainty. Thus, managers would make decisions with the less-than-the-optimal amount of information. In the case of cell C, an organisation is faced extra-IPCs, which is excessive and costly. Following Tushman and Nadler (1978) effectiveness will be used as means to evaluate fit. Effectiveness can be evaluated in many ways (Chang and King 2005; Wang and Strong 1996). For this study accessibility and reliability of information will be used as a measure to evaluate effectiveness (Chang and King 2005).

Information processing needs	Information processing capabilities	
	High	Low
High	(A) Fit	(B) Not fit
Low	(C) Not fit	(D) Fit

- *Table 1. Relationships between IPNs and IPCs: (adopted from (Tushman and Nadler 1978))*

## 2.2.4 Performance

Fit or not-fit has an impact on the performance of organisations. Many studies investigate performance (Brancheau and Wetherbe 1987; Dickson et al. 1984). Some researchers focus on the operational level and others on the organisational level. It mostly depends on the types of questions which are addressed and the type of data being used (Hitt and Brynjolfsson 1996). Some information systems (IS) researchers use the balanced scorecard method to measure organisational performance and suggest several indicators such as cost control, investment return, and revenue generation (Martinsons et al. 1999). Krishnamoorthi and Mathew (2018) summarised performance measurement indicators in IS literature as productivity, enhancement, profitability improvement, cost reduction, competitive advantage, and inventory reduction. From a broad perspective, organisational performance in IS literature can be divided into financial performance and non-financial (operational) performance (Venkatraman and Ramanujam 1986). Financial performance focuses on the outcome and economic indicators while non-financial performance focuses on the technological and operational measurements (Krishnamoorthi and Mathew 2018). Weill (1990) argues that there are four basic parameters that determine the effectiveness of IT systems, namely management commitment, stable internal politics, proceeding experience, and user satisfaction.

This research investigates the organisational level of performance that includes financial indicators and measures of technological efficiency. Two fundamental dimensions are chosen to study organisational performance, which are 1) organisational benefits from the usage of BA, which refer to the intangible benefits of BA that are derived by organisations and 2) return of investment (ROI) as a financial indicator.

## 3 Proposed Research Framework

To address the research question, this study provides a theoretical framework of IPT adapted from models developed by Bensaou and Venkatraman (1995) and Cooper and Wolfe (2005). Bensaou and Venkatraman (1995) advanced Galbraith's thesis for an inter-organisational relationship, adding new concepts to IPNs and IPCs. They derived structural mechanisms, process mechanisms and information technology mechanisms as IPCs and identified three kinds of uncertainty (environmental uncertainty, partnership uncertainty and task uncertainty) to cover IPNs. Another IPT framework developed by Cooper and Wolfe (2005) highlight the intra-organisational perspective of IPT, arguing that appropriately fitting “*information processing volume and richness to uncertainty and equivocality reduction requirements of an IT innovation contributes to successful IT adaptation*” (Cooper and Wolfe 2005, p. 30). This framework takes an IT adaptation perspective and argue that uncertainty and equivocality play an important role. They have identified two elements have influence on uncertainty and equivocality. Organisational technology which includes task variety and task analysability and interdepartmental relations that includes departmental interdependence and differentiation.

Task variety is defined as the “*frequency of unexpected events*” while task analysability “*is related to the extent to which individuals are able to follow an objective, computational procedures in completing a task*” (Cooper and Wolfe 2005, p. 34). Interdepartmental relations refers to the extent of interdependence and differentiation in organisations. With the rise of interdependence, the stability of departments reduces and organisations should experience more uncertainty (Cooper and Wolfe 2005).

The degree of differentiation of the departments depends on the different goals, process, and procedures and communications of departments that leads to ambiguity (Allen and Cohen 1969).

On the basis of this literature, this study develops the following framework by combining the findings of Bensaou and Venkatraman (1995) and Cooper and Wolfe (2005). In this framework, solid lines present the relations between the main elements of the framework and dotted lines show the factors which are going to be used to evaluate the main factors.

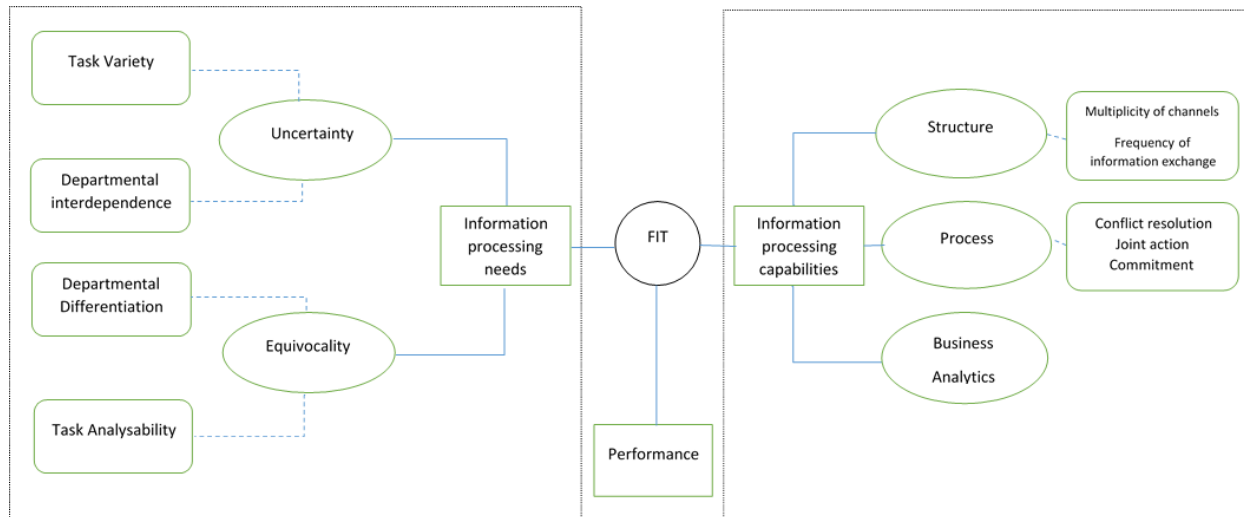

Figure 1. Conceptual framework based on literature

This study explores the impact of BA adoption on the components of the framework and will evaluate the following measures adapted from Bensaou and Venkatraman (1995) and Cooper and Wolfe (2005):

- Changes in the extent of similarity and variety of tasks after BA adoption
- Changes in the activities of department in relation to coordination and delegation of activities between departments.
- Changes in extent of data clarity and the type of data that are gathered and interpreted.
- Changes in task instructions, procedures and task descriptions.
- Changes in the extent of control versus coordination and the number of activities which are done by more than one departments.
- Changes in the way major conflicts are solved (by negotiation or opposition) as well as joint effort and collaboration between departments.

## 4 Research methodology

This research follows an in-depth case study approach to investigate the impact of issues in the natural setting (Walsham 2006). Documents, archival records, interviews, observation and physical artefacts are the resources of data for a case study research, and it is important to use multiple sources of data to increase the quality of the case study (Yin 2009). The interview method is selected as the main method of data collection in this research. Interviews are a critical source of data for case studies since most case studies are about human behaviour (Yin 2009). To ensure the consideration of all the aspects of behavioural issues, gathering documents and observation are chosen in this research.

This study will use a single case study of an organization that has already adopted business analytics and will conduct a total of 25 interviews with a range of key informants such as executives, senior managers, business analysts, IT analytics team, and range of business users. Interviews will be conducted in the location of the organisation. A copy of the semi-structured interview questionnaire will be provided to each interviewee before the interview to enable them to think about the best answers.

In the interpretive approaches analysing and gathering the data begin at the same time (Neuman 2013). Patterns and broad trends will be extracted from the data by organising, integrating, examining and coding of data. An integral part of data analysis is coding. "Codes are tags or labels for assigning units of meaning to the descriptive or inferential information compiled during a study" (Neuman 2013, p

510). Neuman (2013) defined three types of data coding and proposed to review the data on three occasions using a different coding each time which are open coding, axial coding, and selective coding. The three stages of coding qualitative data will be applied for data analysis. All the interviews will be categorised and summarised using concepts from IPT as a guiding framework, and NVivo software will be applied to manage and analyse the data.

## 5 Research gaps

A review of the existing literature has highlighted the following limitation:

- The early BA studies have focused on technical aspects, however some newer studies have focused on adoption and factors influencing BA adoption. To the best of our knowledge, few studies have investigated the changes of organisations due to this adoption.
- Despite the evidence of the value, business process improvement, and competitive advantage provided by BA technology in many studies (Seddon et al. 2017; Vidgen et al. 2017), there is a lack of theoretical underpinning of how and why this occurs.
- A review of several articles and studies in BA impacts on the organisational performance and decision making shows that they are mostly focused on quantitative factors and explain the impact of BA on some predicted indicators such as cost, financial indicators, price dynamics, and quality (IDC 2002; Schläfke et al. 2012).
- Academics have pointed out many challenges in the usability of BA due to complexity in outputs.

## 6 Conclusion and future directions

There are significant gaps in understanding of the impact BA has on organisational design. This study is going to collect and analyse the data in the next phase and it is expected to contribute to both theory and practice by addressing the research question and providing in-depth insight into the impact of BA adoption on organisational design. The findings of this study will increase understanding of organisational changes due to this adoption, therefore, pave the way toward meaningful and thoughtful adoption of BA technologies in the future. The IPT framework is used as means to evaluate the impact BA has on organisational design.

## 7 References

- Allen, T. J., and Cohen, S. I. 1969. "Information Flow in Research and Development Laboratories," *Administrative science quarterly*), pp. 12-19.
- Bedeley, R. T. 2017. *An Investigation of Analytics and Business Intelligence Applications in Improving Healthcare Organization Performance: A Mixed Methods Research*. The University of North Carolina at Greensboro.
- Bensaou, M., and Venkatraman, N. 1995. "Configurations of Interorganizational Relationships: A Comparison between U.S. And Japanese Automakers," *Management Science* (41:9), pp. 1471-1492.
- Bose, R. 2009. "Advanced Analytics: Opportunities and Challenges," *Industrial Management & Data Systems* (109:2), pp. 155-172.
- Brancheau, J. C., and Wetherbe, J. C. 1987. "Key Issues in Information Systems Management," *MIS quarterly*), pp. 23-45.
- Chang, J. C.-J., and King, W. R. 2005. "Measuring the Performance of Information Systems: A Functional Scorecard," *Journal of Management Information Systems* (22:1), pp. 85-115.
- Chen, H., Chiang, R. H. L., and Storey, V. C. 2012. "Business Intelligence and Analytics: From Big Data to Big Impact.(Special Issue: Business Intelligence Research)(Essay)," *MIS Quarterly* (36:4), p. 1165.
- Cooper, R., and Wolfe, R. 2005. "Information Processing Model of Information Technology Adaptation: An Intra-Organizational Diffusion Perspective," *Database for Advances in Information Systems* (36:1), pp. 30-48.
- Cosic, R., Shanks, G., and Maynard, S. 2012. "Towards a Business Analytics Capability Maturity Model," *ACIS 2012: Location, Location, Location: Proceedings of the 23rd Australasian Conference on Information Systems 2012: ACIS*, pp. 1-11.
- Daft, R. L., and Lengel, R. H. 1986. "Organizational Information Requirements, Media Richness and Structural Design," *Management Science* (32:5), pp. 554-571.

- Davenport, T., and Harris, J. G. 2007. *Competing on Analytics : The New Science of Winning*. Boston, Mass. : Harvard Business School Press.
- Dickson, G. W., Leitheiser, R. L., Wetherbe, J. C., and Nechis, M. 1984. "Key Information Systems Issues for the 1980's," *MIS quarterly*, pp. 135-159.
- Galbraith, J. R. 1973. *Designing Complex Organizations*. Addison-Wesley Longman Publishing Co., Inc.
- Galbraith, J. R., and Nathanson, D. A. 1978. *Strategy Implementation: The Role of Structure and Process*. West Pub. Co.
- Hitt, L. M., and Brynjolfsson, E. 1996. "Productivity, Business Profitability, and Consumer Surplus: Three Different Measures of Information Technology Value," *MIS quarterly*, pp. 121-142.
- IDC. 2002. "The Financial Impact of Business Analytics; an Idc Roi Study." p. NETH03124012002.
- Iovan, S. 2017. "Predictive Analytics for Transportation Industry.(Report)," *Journal of Information Systems & Operations Management* (11:1), p. 58.
- Krishnamoorthi, S., and Mathew, S. K. 2018. "Business Analytics and Business Value: A Comparative Case Study," *Information & Management*).
- Martinsons, M., Davison, R., and Tse, D. 1999. "The Balanced Scorecard: A Foundation for the Strategic Management of Information Systems," *Decision support systems* (25:1), pp. 71-88.
- Musumano, E. 2016. "4 Types of Sales Analytics: Gaining Insights to Help You Manage and Grow Business," *HMC Sales, Marketing and Alliances Excellence Essentials*).
- Neuman, W. L. 2013. *Social Research Methods: Qualitative and Quantitative Approaches*. Pearson education.
- Peteraf, M. A., and Barney, J. B. 2003. "Unraveling the Resource-Based Tangle," *Managerial and decision economics* (24:4), pp. 309-323.
- Premkumar, G., Ramamurthy, K., and Saunders, C. S. 2005. "Information Processing View of Organizations: An Exploratory Examination of Fit in the Context of Interorganizational Relationships," *Journal of Management Information Systems* (22:1), pp. 257-294.
- Ramanathan, R., Philpott, E., Duan, Y., and Cao, G. 2017. "Adoption of Business Analytics and Impact on Performance: A Qualitative Study in Retail," *Production Planning & Control* (28:11-12), pp. 985-998.
- Ray, S., Kumar, P., and Rao, P. H. 2013. "Business Analytics: A Perspective," *International Journal of Business Analytics and Intelligence* (1:1), pp. 1-12.
- Schläfke, M., Silvi, R., and Möller, K. 2012. "A Framework for Business Analytics in Performance Management," *International Journal of Productivity and Performance Management* (62:1), pp. 110-122.
- Seddon, P. B., Constantinidis, D., Tamm, T., and Dod, H. 2017. "How Does Business Analytics Contribute to Business Value?," *Information Systems Journal* (27:3), pp. 237-269.
- Tushman, M., and Nadler, D. 1978. "Information Processing as an Integrating Concept in Organizational Design," *Academy of Management. The Academy of Management Review* (pre-1986) (3:000003), p. 613.
- Umanath, N. S. 2003. "The Concept of Contingency Beyond "It Depends": Illustrations from Is Research Stream," *Information & Management* (40:6), pp. 551-562.
- Venkatraman, N. 1989. "The Concept of Fit in Strategy Research: Toward Verbal and Statistical Correspondence," *Academy of management review* (14:3), pp. 423-444.
- Venkatraman, N., and Ramanujam, V. 1986. "Measurement of Business Performance in Strategy Research: A Comparison of Approaches," *The Academy of Management Review* (11:4), pp. 801-814.
- Vidgen, R., Shaw, S., and Grant, D. B. 2017. "Management Challenges in Creating Value from Business Analytics," *European Journal of Operational Research* (261:2), pp. 626-639.
- Walsham, G. 2006. "Doing Interpretive Research," *European journal of information systems* (15:3), pp. 320-330.
- Wang, R. Y., and Strong, D. M. 1996. "Beyond Accuracy: What Data Quality Means to Data Consumers," *Journal of management information systems* (12:4), pp. 5-33.
- Watson, H. J. 2014. "Tutorial: Big Data Analytics: Concepts, Technologies, and Applications," *CAIS* (34), p. 65.
- Watson, H. J., and Wixom, B. H. 2007. "The Current State of Business Intelligence," *Computer* (40:9).
- Weill, P. 1990. *Do Computers Pay Off?: A Study of Information, Technology Investment and Manufacturing Performance*. International Center for Information Technologies.
- Wixom, B. H., Yen, B., and Relich, M. 2013. "Maximizing Value from Business Analytics," *MIS Quarterly Executive* (12:2).
- Yeoh, W., and Koronios, A. 2010. "Critical Success Factors for Business Intelligence Systems," *Journal of computer information systems* (50:3), pp. 23-32.
- Yin, R. K. 2009. *Case Study Research, Design & Methods 4th Ed.*

# Constructing Cooking Ontology for Live Streams

## **Shanlin Chang**

Department of Information Management  
National Sun Yat-sen University  
Kaohsiung, Taiwan  
Email: slchang@mis.nsysu.edu.tw

## **San-Yih Hwang**

Department of Information Management  
National Sun Yat-sen University  
Kaohsiung, Taiwan  
Email: syhwang@mis.nsysu.edu.tw

## **Yu-Chen Yang**

Department of Information Management  
National Sun Yat-sen University  
Kaohsiung, Taiwan  
Email: ycyang@mis.nsysu.edu.tw

## **Abstract**

We build a cooking domain knowledge by using an ontology schema that reflects natural language processing and enhances ontology instances with semantic query. Our research helps audiences to better understand live streaming, especially when they just switch to a show. The practical contribution of our research is to use cooking ontology, so we may map clips of cooking live stream video and instructions of recipes. The architecture of our study presents three sections: ontology construction, ontology enhancement, and mapping cooking video to cooking ontology. Also, our preliminary evaluations consist of three hierarchies—nodes, ordered-pairs, and 3-tuples—that we use to referee (1) ontology enhancement performance for our first experiment evaluation and (2) the accuracy ratio of mapping between video clips and cooking ontology for our second experiment evaluation. Our results indicate that ontology enhancement is effective and heightens accuracy ratios on matching pairs with cooking ontology and video clips.

## **Keywords**

Natural language processing, semantic query, ontology construction, ontology enhancement, live stream

## 1 Introduction

With the emergence of grassroots internet journalists, the era of self-media is coming (Gillmor 2006). The term “self-media” refers to independently operated social media accounts, usually run by individual users on social networking platforms (e.g., Blog, Facebook, Twitch, Twitter, WeChat, Weibo, YouTube). These platforms share a similar feature: live streaming (also referred to as “streaming”). Streaming allows users to broadcast live video content with a camera and a computer/smartphone through the Internet. Hence, the broadcast industry has been undergoing a dramatic change recently (Doyle 2010). People can make and broadcast their own media content, including news, games, cooking, travel, sports, shopping, drama, and commentary, among others. Also, users can produce and broadcast live video at any time and any place, and viewers can watch these videos via the web.

Compared to traditional live TV shows, streaming makes broadcast preparation easier. For example, a traditional live show usually takes much effort to prepare prior and/or post production work. As a result, audiences often find it challenging to view live shows when they join a stream video (Buykx and Petrie 2011; Hayashi et al. 2013; Oh et al. 2016). However, new technologies such as image recognition (He et al. 2016) and speech recognition (Hannun et al. 2014) offer new opportunities to address these challenges. Among these stream videos, cooking-related videos are quite popular. However, semantic information about cooking is hardly used to facilitate viewers’ understanding of a live stream. Hence, we aim to construct cooking ontology by collecting a large amount of recipe data on the Internet, and we align these recipe instructions with live cooking videos. We believe that our study will help viewers better understand live streaming, especially when they just begin to watch a particular show. Viewers will then be able to quickly understand not only how to cook, but also how to mutually communicate with video providers and other viewers.

Oh et al. (2016) addresses the video content alignment problem using a simple information retrieval approach, based on transcripts. Following Oh et al. (2016), we employ the technique of natural language processing (NLP) to construct cooking ontologies from recipes. We then solve the video content alignment problem by comparing the transcripts of video clips with the cooking ontology. Our results show that our proposed technique helps construct high quality cooking ontology. Furthermore, this technique more accurately maps video clips, based on our proposed method.

The rest of our paper is organized as follows. In Section 2, we describe related works on constructing cooking ontology from recipe and videos. In Section 3, we present the architecture of our approach. In Section 4, we describe our cooking ontology schema and detail our methods of construction, enhancement, and mapping live streaming to cooking ontology. In Section 5, we discuss our preliminary evaluations, which show the performance of our proposed method: ontology construction/enhancement and mappings of video clips. Finally, we conclude this paper with Section 6.

## 2 Related Work

### 2.1 Cooking Domain Knowledge Building using Ontology

A number of studies have investigated the construction of cooking ontology. Batista et al. (2006) describe a cooking ontology that includes four concepts: actions, food, recipes, and utensils. In addition to modules for constructing these four concepts, there are three auxiliary modules that construct auxiliary concepts, such as units and measures, equivalencies, and plate types. The resultant ontology is used subsequently to facilitate a generic dialogue system in home domains. The JColibriCook system (DeMiguel et al., 2008) is based on ontology and extends Case-Based Reasoning (CBR) for ColibriCook computer cooking contests. Its ontology contains not only ingredients, but also dish features, such as formal type, cuisine type, and dietary type. JColibriCook is built around four components in the CRB cycle: retrieval, reuse, revision, and retainment. Also, to test proposed systems, the Computer Cooking Contest provides five exercise queries to search for recipes and create new dishes. JColibriCook also maps ingredients and creates recipes. They propose to construct a domain ontology and extend query for different degrees of similarity. Several studies (Cordier et al. 2012; Cordier et al. 2009; Gaillard et al. 2014) have extended this JColibriCook system. A notable example is the TAAABLE system, which evolved into wikiTAAABLE by Cordier et al. (2009) and includes a semantic wiki for TAAABLE. Cordier et al. (2012) then use WikiTaaable to include user feedback and incorporate another adaptation knowledge (AK) resource. Collectively, these studies help construct domain knowledge to promote a better understanding of cooking ontology. Such concepts could be linked, extended, and reused.

## 2.2 Interaction on Cooking Video

Large numbers of cooking stream videos are available on the Internet, and it is imperative to identify knowledge from these video clips. Doman et al. (2011) apply image recognition techniques to identify cooking recipes from cooking videos, but they do not use any domain ontology to facilitate recipe identification. Their proposed method will generate recipe video tagging. Oh et al. (2016) establish Cooking Video Annotation (CVA) ontology for aligning videos and recipes. They apply information extraction techniques with lexicon-syntactic patterns to identify chef, ingredient, ingredient portion, and cooking tool from video captions by using Named Entity Recognition (NER). Doman et al. (2011) and Oh et al. (2016) both study tagging videos, but their approaches are not intended to be applied to streaming video.

## 3 Research Framework

In this section, we present the design of a cooking ontology and show how it can be used to annotate a video stream. As we show in Figure 1, our approach involves three steps: cooking ontology construction, ontology enhancement, and mapping between cooking live streams and recipe instructions in the cooking ontology.

With respect to the ontology construction step, we define the schema of a cooking ontology and then populate the ontology from a large corpus that contain the text data of recipes. We use Natural Language Processing (NLP) techniques (e.g., part-of-speech tagging, stemming, dependency parsing, n-gram search, NER) to identify entities and derive the various types of concepts in the ontology. We then employ semantic web queries to further instantiate concepts in the ontology. Finally, we map stream video clips to recipe instructions within the cooking ontology.

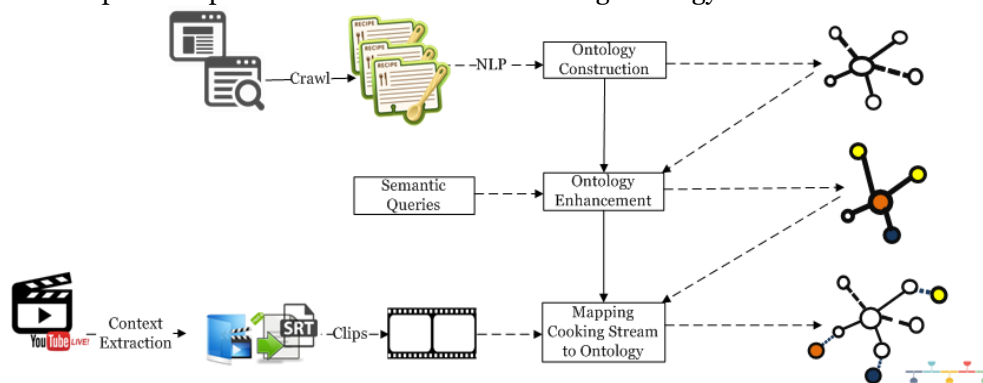

Figure 1: Skeleton of our approach

## 4 Building Cooking Ontology

### 4.1 Ontology Schema

Cooking ontology involves many concepts related to the cooking process, including culinary materials, the amount of units, utensils used, cooking instructions, and so forth. Our cooking ontology has six concepts and six properties, as we show in Figure 2. Batista et al. (2006) define four concepts related to cooking: food, actions, utensils, and recipes. Following the work of Batista et al. (2006), we separate the food concept into ingredients and raw food, since some ingredients are processed from raw food (e.g., cheese is defined as a *raw food* since it is an *ingredient* processed from “milk”). The following example shows how we construct the cooking ontology. A statement in a recipe is “60g/2¼oz shiitake mushrooms, sliced.” This statement can be divided into two parts: raw food (e.g., mushrooms) and processes to transform food into an ingredient (e.g., shiitake mushrooms, sliced). A recipe includes step-by-step *instructions*. Each instruction involves some action that incorporates ingredients and kitchen utensils. Consider the following instruction: “Place the chicken in a frying pan.” This instruction involves an action “place”, a utensil “frying pan”, and an ingredient “chicken”. Finally, a recipe may be followed by the cooking processes of several live video streams.

Each concept can be described by attributes. The *Recipe* concept records include five attributes: recipe title, serves, recipe description, and recipe URL. The *Instruction* concept illustrates recipe cooking processes and operational actions. The *Ingredient* concept describes culinary material and how this material is transformed from a raw product; this concept also includes any restrictions. The *Raw food*

concept includes various aspects about food, such as name, category, and nutrition. The *Kitchen utensil* concept includes attributes that describe cookers, kitchenware, and food preparation appliances. Finally, the *Video* concept, retrieved from either a video-sharing website or generated by users, describes video content, captions, and so forth.

Property specifies the directional relation between concepts. The Recipe concept has three properties--Ingredient, Instruction, and Video—that we name *hasIngredient*, *hasSteps*, and *playedBy*, respectively. As we previously mention, an ingredient may be processed by some raw food, signified by the property *processedFrom*. The *useIngredient* property specifies that an instruction uses a certain ingredient. Finally, the *useUtensil* property reflects that an instruction uses some utensils for processing food.

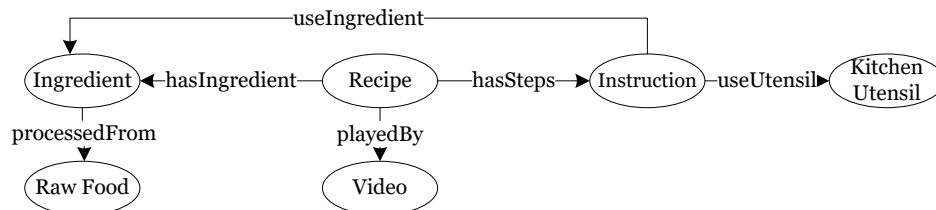

Figure 2: Cooking ontology

## 4.2 Cooking Ontology Construction

Prior studies (Buitelaar et al. 2005; IJntema et al. 2012) use NLP techniques to construct ontologies in various domains. NLP involves several techniques, including tokenization, part-of-speech (POS) tagging, sentence parsing, word dependencies, named entity recognition (NER), and so forth. Buitelaar et al. (2005) describe a six-layer approach for ontology learning, such as terms, synonyms, concepts, concept hierarchies, relations, and rules. Our study adopts a similar approach by using the pseudo-code that we list in Figure 3. We first collect recipes from some recipe websites. In Figure 4, we show one example of a BBC recipe, which has notable sections for ingredients and instructions. We first try to identify ingredient instances from the ingredient section by using NLP techniques. To do so, we consider two examples: “60g/2¼oz shiitake mushrooms, and sliced” and “2 x 7 g sachet of dried yeast.” We first apply a lexicon-based method to extract the names of ingredients and then use NER to identify measurements (e.g., 60g (grams), 2¼ oz (ounces)). However, in the second example, NER fails to identify the multiplication symbol, which means two packs of yeast. We thus prepare a set of rules to facilitate the identification of ingredients. In addition, we apply POS tagging to find verbs, nouns, adjectives, or quantifiers, which are part of ingredient attributes. In particular, a verb will serve as a label for the *processedFrom* property; for example, “sliced” is a label between the ingredient (mushroom) and the raw food (mushroom).

We then identify the other concepts from the method section, as we show in Figure 4. First, we extract ingredients described in the instruction by using *n*-gram ( $n=1, 2, \text{ and } 3$ ) and then compare them with the ingredient instances we just extracted. Thus, ingredients mentioned in the method section (e.g., “white wine vinegar”) can be preserved. We next identify kitchen utensils mentioned in the instruction by using some predefined rules as defined in (Oh et al. 2016). One such rule is “IN {DT} {JJ} {NN}”. If we apply this rule to “in a large pot”, then the noun (pot) will be identified as a utensil. In addition, we extract nouns with the suffix “-ware”(e.g., glassware, silverware), as demonstrated on the Wikipedia kitchen utensil webpage. Finally, we confirm the retrieved nouns using lexicon from several Wikipedia categories (e.g., food preparation appliances, cooking appliances, cooking vessels). Finally, we extract actions from instruction sentences to form 3-tuples for instructions in our ontology: action, ingredient, and kitchen utensil. We parse an instruction sentence into a dependency tree via a Stanford dependency parser. If the root of the dependency is a verb (which thereby reflects an action) and the dependency tree involves some ingredient terms and kitchen utensil terms, we can subsequently form the 3-tuples. For example, consider the following sentence: “For the pizza base, place the flour, oil, water, and salt into a food processor and blend together until a dough is formed.” After parsing the sentence, we obtain a dependency tree with the root “place” in a conjunction with “blend”:

root (ROOT-o, place-6)  
conj:and (place-6, blend-21)

As a result, we can form the following instruction tuples:

(place, flour, food processor)  
(place, oil, food processor)  
(place, water, food processor)



(place, salt, food processor)  
(blend, flour, food processor)  
(blend, oil, food processor)  
(blend, water, food processor)  
(blend, salt, food processor)

Let  $R=\{r_1, r_2, \dots, r_n\}$  // recipes  
 Let  $r_n=\{r_{ing}, r_{ins}\}$  // ingredient section and instruction section of recipes  
 Let  $V=\{v_1, v_2, \dots, v_m\}$  // video  
 Let  $c_r, c_{ing}, c_{food}, c_{ku}, c_{ins}, c_v$  be cooking ontology concepts  
 Let  $a_{ing\_measurement}, a_{ing\_multiplication}$  be attributes of ingredient concept  
 Let  $t(w_{action}, w_{ing}, w_{ku})$  be attributes of instruction concept  
 Let  $p_{hasIngredient}, p_{processedFrom}, p_{useUtensil}, p_{useIngredient}, p_{hasSteps}, p_{playBy}$  be cooking ontology properties  
 Let  $D_{ing}, D_{ku}$  be list // ingredient dictionary and kitchen utensil dictionary

**Input:**  $r_{ing}, c_{ing}, C_{ing}$   
**Output:**  $a_{ing\_measurement}, a_{ing\_multiplication}, p_{hasIngredient}, p_{processedFrom}, D_{ing}$

- 1 **for** each ingredient  $r_{ing}$  in recipe  $r_n$
- 2     A measurement of  $c_{ing}$  ingredients  $a_{ing\_measurement}=NER(r_{ing})$
- 3     A multiplication of  $c_{ing}$  ingredients  $a_{ing\_multiplication}=Rule(r_{ing})$
- 4     Property  $p_{processedFrom} = part-of-speech(r_{ing}) \cap verb\ of\ part-of-speech$
- 5     Build a dictionary of ingredient  $D_{ing}$  from  $C_{ing}$
- 6     Build a property  $p_{hasIngredient}$  between concept recipe  $r_n$  and ingredient  $c_{ing}$
- 7     Build a property  $p_{processedFrom}$  between concept ingredient  $c_{ing}$  and raw food  $c_{food}$

**Input:**  $r_{ins}, C_{ins}$   
**Output:**  $c_{ku}, D_{ku}, p_{useUtensil}$

- 1 **for** each instruction  $r_{ins}$  in recipe  $r_n$
- 2      $c_{ku\_temp}=Pattern(r_{ins})$
- 3     Concept kitchen utensil  $c_{ku} = c_{ku\_temp}$  in *Wikipedia* | *suffix check* ( $c_{ku\_temp}$ )= true
- 4     Build a dictionary of kitchen utensil  $D_{ku}$  from  $c_{ku}$
- 5     Build a property  $p_{useUtensil}$  between concept instruction  $c_{ins}$  and kitchen utensil  $c_{ku}$

**Input:**  $D_{ku}, D_{ing}, r_{ins}, C_{ins}$   
**Output:**  $p_{hasSteps}, p_{useIngredient}, T(w_{action}, w_{ing}, w_{ku})$

- 1 **for** each instruction  $r_{ins}$  in recipe  $r_n$
- 2      $w_{action}=\{w_{action\_root}, w_{action\_verb}\}$
- 3      $w_{action\_root}= part-of-speech(r_{ins}) \cap verb\ of\ part-of-speech \mid root\ of\ dependency\ parser$
- 4      $w_{action\_verb} = conj\ with\ w_{action\_root}\ in\ parser\ tree$
- 5      $w_{ing}=\max(n-gram(r_{ins}) \cap D_{ing})$
- 6      $w_{ku}=Pattern(r_{ins}) \cap D_{ku}$
- 7     **for** each *parser tree*( $r_{ins}$ )
- 8         Build attributes of  $C_{ins}$  instruction  $t(w_{action}, w_{ing}, w_{ku})$  by *parser tree* relation
- 9     Build a property  $p_{hasSteps}$  between concept recipe  $c_r$  and concept instruction  $c_{ins}$
- 10     Build a property  $p_{useIngredient}$  between concept instruction  $c_{ins}$  and ingredient  $c_{ing}$

**Input:**  $R, V$   
**Output:**  $c_r, c_v, p_{playBy}$

- 1 **for** each video  $v_m$  in  $V$
- 2     Stream video  $v_m$  has a recipe  $r_n$
- 3     Build a property  $p_{playBy}$  between concept recipe  $c_r$  and video  $c_v$

Figure 3: Pseudo code for ontology construction

Cooking ontology has six concepts and six properties, as we mention in the previous paragraph. To store the large number of ontology instances that we derived using NLP techniques, we choose Neo4j, a popular DBMS for storing graph data, as the storage server. Concepts correspond to nodes in Neo4j, and attributes are labels of Neo4j nodes. Properties are stored as relations in Neo4j.

### 4.3 Enhancing Cooking Ontology

We note that instruction sentences may mention some ingredients that are not exactly the same as the ingredients described in the ingredient section. Take a pizza making recipe, for example. Although the ingredient section may include “olive oil,” the instruction section may only use “oil” instead, as we show

in our previous example. In fact, both “plain flour” and “flour” refer to the same thing. In this subsection, we describe our method for both identifying these ingredients and enhancing the instruction 3-tuples.

Our goal is to determine if two terms are semantically similar. To do so, we utilize Sematch API (Zhu and Iglesias 2017), which is a knowledge graph search system that allows users to compare semantic similarity. Sematch API maintains a knowledge base derived from WordNet, DBpedia, and YAGO. We follow the work of Sematch API and set the similarity threshold at 0.5. For example, the similarity between oil and olive oil when we use Sematch API is 0.8187 ( $>0.5$ ). Therefore, we add the following 3-tuples to the recipe instruction ontology:

(place, plain flour, food processor)  
(blend, plain flour, food processor)  
(place, olive oil, food processor)  
(blend, olive oil, food processor)

#### 4.4 Mapping Live Stream to Cooking Ontology

In this subsection, we describe how we incorporate live streaming video into our ontology. To do so, we partition a video into several short video clips. Our goal is to establish a mapping between the instruction 3-tuples and the video clips. More formally, a recipe has a list of instructions, and each instruction is characterized by a set of 3-tuples  $(a, i, u)$ . Each video clip can be described as a transcript, derived from some audio-to-speech software. Our goal is to decide upon the closest instruction(s) for each video clip.

Given a set of 3-tuples  $AIU_t = \{(a_1, i_1, u_1), (a_2, i_2, u_2), \dots, (a_k, i_k, u_k)\}$  for an instruction  $t$ , we first form its action union, ingredient union, and utensil union, as denoted by  $A$ ,  $I$ , and  $U$ , respectively. Specifically,

$$A_t = \bigcup_{1 \leq j \leq k} a_j,$$

$$I_t = \bigcup_{1 \leq j \leq k} i_j,$$

$$U_t = \bigcup_{1 \leq j \leq k} u_j.$$

We then form three possible pairs:

$$AI_t = \bigcup_{1 \leq j \leq k} (a_j, i_j),$$

$$IU_t = \bigcup_{1 \leq j \leq k} (i_j, u_j),$$

$$AU_t = \bigcup_{1 \leq j \leq k} (a_j, u_j),$$

For a video clip transcript  $r$ , we first use NLP techniques to retrieve all tokens that are tagged as a verb, noun, or adjective. We then identify the actions, ingredients, and utensils, as denoted by  $A_r$ ,  $I_r$ , and  $U_r$ , respectively. To compare the similarities between a video clip transcript  $r$  and an instruction  $t$ , we propose three measures,  $S^1$ ,  $S^2$ , and  $S^3$ , as defined below:

$$S_{r,t}^1 = \frac{|A_t \cap A_r|}{|A_t|} + \frac{|I_t \cap I_r|}{|I_t|} + \frac{|U_t \cap U_r|}{|U_t|},$$

$$S_{r,t}^2 = \frac{|AI_t \cap (A_r \times I_r)|}{|AI_t|} + \frac{|IU_t \cap (I_r \times U_r)|}{|IU_t|} + \frac{|AU_t \cap (A_r \times U_r)|}{|AU_t|},$$

$$S_{r,t}^3 = \frac{|AIU_t \cap (A_r \times I_r \times U_r)|}{|AIU_t|}.$$

Note that  $S_{r,t}^1$  measures the overlap between the actions, ingredients, and utensils mentioned in the video clip  $r$  and the instruction  $t$ , and  $S_{r,t}^2$  measures the overlap between the pairs of actions, ingredients, and utensils mentioned in the video clip  $r$  and the instruction  $t$ . Finally,  $S_{r,t}^3$  shows how well the video clip  $r$  matches the complete 3-tuples in the instruction  $t$ .

For example, for an instruction “place the chicken in a frying pan” and a clip of “put garlic and chicken on a pan”, a cooking ontology tuple is (place, chicken, frying pan), and video content extractions are put, garlic, chicken, and pan. The instruction nodes include place, chicken, and frying pan. The instruction edges include (place and chicken), (place and frying pan), and (chicken and frying pan). Also, the instruction subgraph is (place, chicken, frying pan). Interconnection marks between cooking ontology and live streams reflect accurate rates more than 0.25. For this particular example, the accurate rate by nodes is  $2/3$  ( $0.67 > 0.25$ ), which namely reflects chicken and frying pan. We thus mark a relevance between the instruction and the clip. The next example for accurate rate by edge is  $1/3$  ( $0.33 > 0.25$ ).

## 5 Preliminary Evaluation

### 5.1 Dataset

We collect the recipes from two sources: a BBC Recipe website (<https://www.bbc.com/food/recipes>) and streamers' individual websites. Streaming videos are downloaded from YouTube live. The BBC recipe website includes more than 10,000 recipes. Some streamers provide cooking recipes on either their websites or YouTube description box. Recipes are stored in a Neo4j graph database. In Figure 4, we provide an example from a BBC recipe website.

With our proposed approach, we randomly extract 15 cooking videos from YouTube, and their recipes are from either the BBC Recipe site or streamers' websites. We obtain the transcript of a cooking live stream by using YouTube's auto-caption function. Because these transcripts may contain noisy data, we conduct a spelling check, POS, and stemming. Finally, we divide each streaming video transcript into several one-minute clip transcripts, and we show this video process in Figure 5. Meanwhile, we use Figure 6 to show the screenshot of a live streaming video example for roast chicken.

The screenshot shows a recipe page for 'Ten-minute pizza'. It includes preparation and cooking times (less than 30 mins and less than 10 mins), serving size (Makes 1), and the author (James Tanner). Below are interactive buttons for sharing, adding to favorites, creating a shopping list, and printing the recipe. The ingredients are listed in two sections: 'For the pizza base' (250g plain flour, 8 tbsp olive oil, 2 tsp water, 1 tsp sea salt) and 'For the topping' (4 tbsp tomato purée, 60g shiitake mushrooms, 4 slices prosciutto, 100g gorgonzola cheese, 1 free-range egg). A 'Method' section follows with seven numbered steps.

Figure 4. A recipe example from a BBC recipe website

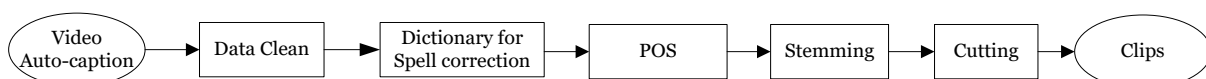

Figure 5. Stream video data process



Figure 6. Clips example from YouTube stream video

## 5.2 Ontology Evaluation

Our first evaluation concerns the recipes features from our constructed ontology. Specifically, we evaluate the ingredients and instructions in our ontology. To do so, we choose 9 recipes with a total of 65 instructions for evaluating instructions. We then manually tag ingredients sentences, which results in a set of ingredients for each recipe. We also manually inspect the instruction sentences and create 3-tuples, which involve actions, ingredients, and kitchen utensils.

To evaluate the instructions, we compare the 3-tuples manually notated by expert with those derived by our approach; we present these results in Table 2. We measure the hit ratio of the proposed methods, which is defined as the ratio of the corrected identified objects to the total number of correct objects. In addition to the hit ratio of 3-tuples, we also measure that of the ordered pairs (i.e., (action, ingredient), (ingredient, utensil), and (action, utensil)), as well as that of the single nodes (i.e., action, ingredient, and utensil). We then compare the performance of cooking ontology construction with and without enhancement. When we do so, we find that cooking ontology construction with (semantic) enhancement achieves a higher hit ratio across all three measures.

	Nodes( $S^1$ )	Ordered-pair( $S^2$ )	3-tuple( $S^3$ )
Cooking ontology construction	78%	58%	21%
Cooking ontology construction and enhancement	86%	63%	34%

Table 2. Average hit ratio of instructions tuples

## 5.3 Video Clip and Ontology Mapping Evaluation

The second evaluation is a mapping between video clips and ontology. To begin, we manually tag 15 cooking streams, and a total of 459 one-minute video clips. When we map pairs between clips and instructions, we obtain 151 observations. When we tag a true positive (TP) of a clip with an instruction by extracting a number of three methods (i.e., nodes, pairs or tuples), we find more than one quarter of our total amount of cooking ontology. For each method of nodes, pairs, or tuples, we subtract repetitiveness. On the contrary, we do find that others are true negative (FN) tagging. Also, we manually compare the False Positive (FP) and True Negative (TN) with respect to tagging and unequal system tagging, and we find that the number of true positives is less than false negatives. Finally, to evaluate mapping pairs, we use two implements: precision =  $TP / (TP + FP)$  and recall =  $TP / (TP + FN)$ .

Oh et al. (2016) examine a generation of interactive cooking videos by using semantic annotation by Wikipedia and DBpedia. In their study, they focus on creating semantic queries on ingredient and kitchen utensil terms. Their algorithm solves the mapping problem by means of LCS and sentence similarity over a threshold value. However, since closed cooking videos might have included post-production work and less video noise, their method is not suitable for analyzing the modern live streaming technique.

The result of our second evaluation, which we present in Table 3, may help account for ordered-pairs and tuples. Mapping video clips and cooking ontology results in ordered-pairs that are higher than nodes and close to 3-tuples. Also, the research methods that Oh et al. (2016) use are less effective for analyzing live video. Future work could consider memory benefits for identification antecedents and consequences. Because the video is continuous, the streamer must repeat the action.

	Precision	Recall
--	-----------	--------

Cooking ontology construction( $S^1$ )	0.372	0.539
Cooking ontology construction and enhancement( $S^1$ )	0.488	0.629
Cooking ontology construction( $S^2$ )	0.571	0.265
Cooking ontology construction and enhancement( $S^2$ )	0.690	0.589
Cooking ontology construction( $S^3$ )	0.545	0.199
Cooking ontology construction and enhancement( $S^3$ )	0.648	0.550
Oh et al. 2016	0.167	0.066

Table 3. Mapping pairs evaluation of three methods

## 6 Conclusion and Future Work

The interconnection function must discern cooking processes from video auto-captions and cooking features. This study builds a domain knowledge for recipes, thereby extending our knowledge about semantic webs. Specifically, the results of our could underscore the usefulness of this idea. Reviewing our method could strengthen the establishment of property in our research methods, such as building sentences between tuples or the benefits of memory. Complementary, knowledge expansion of this study influences instances of concept (e.g., node data). Among topics that could be explored in future research, some important ones include translation and terminology. The translation of a dish or ingredient title may, for example, include semantic translation, free translation, word-for-word translation, or faithful translation. As just one example, Japanese cuisine consists of batter, cabbage, anything from meat, seafood, and so forth, all ingredients that are pan fried. The name for this particular Japanese cuisine is okonomiyaki, also called a "Japanese pancake" or "as-you-like-it pancake." Aside from translation, the other area that future studies could explore is terminology issues. When cooking in live stream videos, a chef may clearly and faithfully present cuisine skills and use professional language. However, the terminology that chef uses may be too complex for novice chefs or viewers to understand. For example, the term "Julienne" refers to a kind of cutting or shredding of food into 2-3 inch long, thin strips, and this term may not be fully understood by novice chefs or viewers. Terminology issues also meant that we were unable to use our algorithm to match with recipe. Perhaps, then, future work could consider related issues, such as referencing multi-language translations and broadening professional language.

## 7 References

- Batista, F., Pardal, J. P., Mamede, P. V. N., and Ribeiro, R. 2006. "Ontology Construction: Cooking Domain," *Artificial Intelligence Methodology Systems and Applications* (4183), pp. 213-221.
- Buitelaar, P., Cimiano, P., and Magnini, B. 2005. "Ontology Learning from Text: An Overview," *Ontology learning from text: Methods, evaluation and applications* (123), pp. 3-12.
- Buykx, L., and Petrie, H. 2011. "What Cooks Needs from Multimedia and Textually Enhanced Recipes," *IEEE International Symposium on Multimedia, California, USA: IEEE*, pp. 387-392.
- Cordier, A., Gaillard, E., and Nauer, E. 2012. "Man-Machine Collaboration to Acquire Cooking Adaptation Knowledge for the Taaable Case-Based Reasoning System," *Proceedings of the 21st International Conference on World Wide Web: ACM*, pp. 1113-1120.
- Cordier, A., Lieber, J., Molli, P., Nauer, E., Skaf-Molli, H., and Toussaint, Y. 2009. "Wiki-Taaable: A Semantic Wiki as a Blackboard for a Textual Case-Based Reasoning System," *6th European Semantic Web Conference, Heraklion, Greece*, pp. 88-101.
- DeMiguel, J., Plaza, L., and Díaz-Agudo, B. 2008. "Colibricook: A Cbr System for Ontology-Based Recipe Retrieval and Adaptation," *The 9th European Conference on Case-Based Reasoning, K.-D. Althoff, Bergmann, R., Minor, M., Hanft, A. (ed.), Trier, Germany*, pp. 199-208.
- Doman, K., Kuai, C. Y., Takahashi, T., Ide, I., and Murase, H. 2011. "Video Cooking: Towards the Synthesis of Multimedia Cooking Recipes," *International Conference on Multimedia Modeling, Taipei, Taiwan: Springer*, pp. 135-145.
- Doyle, G. 2010. "From Television to Multi-Platform: Less from More or More for Less?," *Convergence* (16:4), pp. 431-449.

- Fabian, M., Gjergji, K., and Gerhard, W. 2007. "Yago: A Core of Semantic Knowledge Unifying Wordnet and Wikipedia," Proceedings of the 16th international conference on World Wide Web, Alberta, Canada, pp. 697-706.
- Gaillard, E., Lieber, J., and Nauer, E. 2014. "Case-Based Cooking with Generic Computer Utensils: Taaable Next Generation," 22nd International Conference on Case-Based Reasoning, Cork, Ireland, pp. 254.
- Gillmor, D. 2006. *We the Media: Grassroots Journalism by the People, for the People.* " O'Reilly Media, Inc."
- Hannun, A., Case, C., Casper, J., Catanzaro, B., Diamos, G., Elsen, E., Prenger, R., Satheesh, S., Sengupta, S., and Coates, A. 2014. "Deep Speech: Scaling up End-to-End Speech Recognition," arXiv preprint arXiv:1412.5567).
- Hayashi, Y., Doman, K., Ide, I., Deguchi, D., and Murase, H. 2013. "Automatic Authoring of a Domestic Cooking Video Based on the Description of Cooking Instructions," Proceedings of the 5th international workshop on Multimedia for cooking & eating activities, Barcelona, Spain: ACM, pp. 21-26.
- He, K., Zhang, X., Ren, S., and Sun, J. 2016. "Deep Residual Learning for Image Recognition," Proceedings of the IEEE conference on computer vision and pattern recognition, Las Vegas, USA, pp. 770-778.
- IJntema, W., Sangers, J., Hogenboom, F., and Frasincar, F. 2012. "A Lexico-Semantic Pattern Language for Learning Ontology Instances from Text," Web Semantics: Science, Services and Agents on the World Wide Web (15), pp. 37-50.
- Maedche, A., and Staab, S. 2001. "Ontology Learning for the Semantic Web," IEEE Intelligent systems (16:2), pp. 72-79.
- Miller, G. A. 1995. "Wordnet: A Lexical Database for English," Communications of the ACM (38:11), pp. 39-41.
- Nyarko, J. 2016. "Newspaper Review Show in the Broadcast Media Space in Ghana: An Exploratory Qualitative Study," Sage Open (6:2), p. 2158244016654952.
- Oh, K.-J., Hong, M.-D., Yoon, U.-N., and Jo, G. 2016. "Automatic Generation of Interactive Cooking Video with Semantic Annotation," Journal of Universal Computer Science (22:6), pp. 742-760.
- Zhu, G., and Iglesias, C. A. 2017. "Computing Semantic Similarity of Concepts in Knowledge Graphs," IEEE Transactions on Knowledge and Data Engineering (29:1), pp. 72-85.

# Deep Autoencoder for Recommender Systems: Parameter Influence Analysis

## Dai Hoang Tran

Department of Computing  
Macquarie University  
Sydney, Australia  
Email: dai-hoang.tran@hdr.mq.edu.au

## Zawar Hussain

Department of Computing Macquarie University  
Sydney, Australia  
Email: zawar.hussain@hdr.mq.edu.au

## Wei Emma Zhang

Department of Computing Macquarie University  
Sydney, Australia  
Email: w.zhang@mq.edu.au

## Nguyen Lu Dang Khoa

CSIRO Data61  
Sydney, Australia  
Email: khoa.nguyen@data61.csiro.au

## Nguyen H. Tran

School of Information Technologies  
The University of Sydney  
Sydney, Australia  
Email: nguyen.tran@sydney.edu.au

## Quan Z. Sheng

Department of Computing Macquarie University  
Sydney, Australia  
Email: michael.sheng@mq.edu.au

## Abstract

Recommender systems have recently attracted many researchers in the deep learning community. The state-of-the-art deep neural network models used in recommender systems are multilayer perceptron and deep autoencoder (DAE). In this work, we focus on DAE model due to its superior capability to reconstruct the inputs, which works well for recommender systems. Existing works have similar implementations of DAE but the parameter settings are vastly different for similar datasets. In this work, we have built a flexible DAE model, named FlexEncoder that uses configurable parameters and unique features to analyse the parameter influences on the prediction accuracy of recommender systems. Extensive evaluation on the MovieLens datasets are conducted, which drives our conclusions on the influences of DAE parameters. We find that DAE parameters strongly affect the prediction accuracy of the recommender systems, and the effect remains valid for similar datasets in a larger.

**Keywords** Recommender systems, Autoencoder, Neural network

## 1 Introduction

A recommender system is a system which recommends certain items to its users and those recommended items yield a better user response than the non-recommended items. Nowadays, recommender systems are playing an important role in the modern technology services. They help boost business and facilitate decision making for many companies in different industries such as Amazon book recommendation<sup>1</sup>, Spotify music recommendation<sup>2</sup>, Netflix movie recommendation<sup>3</sup> and Google Play Store mobile application recommendation<sup>4</sup>. Current technology services often provide their users the most relevant content to enhance engagement and reduce users' effort in finding the content of their interests. There are two major approaches for traditional recommender systems. The first one is Collaborative Filtering (CF) (Bell and Koren 2007), in which each user is recommended with items based on other users with similar preferences. The second approach is using content-based recommendation (Liu et al. 2010), in which each user is recommended with items that are similar to what he/she liked previously. Some techniques use a hybrid approach by combining both collaborative filtering and content-based methods (Burke 2002). All of these approaches perform well in many applications. However, they usually face certain limitations and challenges due to the increasing demand of high quality personalization and recommendation (Adomavicius and Tuzhilin 2005).

Recent developments have seen the rising of adopting the neural network model for recommender systems. There is a big focus on using autoencoder to learn the sparse matrix of user/item ratings and then perform rating prediction (Hinton and Salakhutdinov 2006). A large body of research works has been done on autoencoder architecture, which has driven this field beyond a simple autoencoder network. Many different techniques have been proposed such as *denoising* architecture or *dropout* to improve the system effectiveness (Kuchaiev and Ginsburg 2017) and combination of neural network with collaborative filtering methods (Strub et al. 2016) to improve prediction. Besides the differences in theory, all these techniques have quite similar implementations of the DAE network but there is no agreement on optimal parameters used to train the model efficiently. Each work has used different set of hyper-parameters and specific settings but the implementations are similar.

This has motivated us to build a flexible deep neural network model, where we can embed our features and techniques from other works, into one comprehensive DAE model, called FlexEncoder. FlexEncoder contains more than 15 configurable parameters for tuning, and can significantly affect the rating predictions. Our goal is not only to build a feature-rich autoencoder model for recommender systems but also to find out what kind of settings and what set of parameters will provide a better recommendation. By conducting an extensive evaluation on our FlexEncoder model, we want to answer an important question: how do parameters of DAE network influence the rating prediction?

Our main contributions in this work are as follows:

- We provide a fully open-source and feature-rich DAE network for recommender systems<sup>5</sup>. This will help new researchers to quickly understand the autoencoder-implemented recommender systems and test per their request.
- We implement unique features into our model, such as *prediction rounding* or *dense re-feeding rounding* (detailed in Section 3.1). This will help to enrich the set of features and ideas in the research area of autoencoder recommender systems.
- We perform an extensive evaluation of our model with various parameter's combinations, which help us to understand the effect of autoencoder parameters on influence the rating prediction.

## 2 Background

Recommender system is a well-known research field for the last few decades (Hill et al. 1995). It has gained huge attraction from industry in the modern age due to the problem of information overload. In recent developments, researchers are applying deep neural network to make recommender systems

---

<sup>1</sup> <https://www.amazon.com>

<sup>2</sup> <https://www.spotify.com>

<sup>3</sup> <https://www.netflix.com>

<sup>4</sup> <https://play.google.com>

<sup>5</sup> <https://github.com/heroddaji/SurpriseDeep>



more robust and to overcome the challenges such as cold-start problem and sparse rating matrix (Adomavicius and Tuzhilin 2005). In this section, we will overview recommender systems, introduce its basic models, and discuss the evolution of its architecture using deep neural network.

## 2.1 Overview of Recommender Systems

To understand what a recommender system is, let's look at an e-commerce service such as Amazon<sup>6</sup>, which lists and sells millions of items such as books and accessories to customers around the globe. Due to its massive size of catalogues and large user base, Amazon cannot show all of its products to a customer via the website. Instead, they want to tailor their services to each customer based on his/her purchasing history and pattern while browsing the website. As a result, each customer who visits Amazon, will see such items that are "recommended" to fit that user's taste, hence increasing the chance of that user to buy more items on Amazon. Therefore, the fundamental idea of a recommender system is to leverage difference sources of data to infer or predict customer interests.

For the terminologies, the products to be recommended are called *items*, and the entity to receive the recommendation is the *user*. The choice of recommended items is generally based on *rating prediction value*, in which *rating* is the user feedback on certain items. Figure 1 shows an example of a classical movie recommender system.

In Figure 1, we have five *users*, and each of them provides ratings for different movies, which are the *items* in this case. A rating value is the number of stars from total of 5 stars, thus the *rating* values are in range of 1 to 5. The objective of this system is to predict the missing ratings of each user, as you can see with red question marks. Additionally, the table containing the rating data is called the *rating matrix*. One particular interested property of a recommendation rating matrix is that it is very sparse. That means there are lots of missing entries, and dealing with sparse matrix is one of the fundamental challenges in recommender systems. What we illustrate here is a very simple recommender system. In the real world, there are large variety of products and recommender systems for different purposes such as music recommendation (Patrick et al. 2017) and news personalization (Domingos and Richardson 2001).











							
	<u>Movie</u>	Bob	Alice	Peter	Elen	Miki	Rating form:
	The Shawshank Redemption	5			4	?	★★★★★ Love it
	The Godfather		4			3	★★★★☆ Like it
	The Dark Knight	2		3	2		★★★☆☆ It was ok
	Pulp Fiction	?		?		1	★★☆☆☆ Didn't like it
	Schindler's List		1				★☆☆☆☆ Hated it

Figure 1: A movie recommender system

## 2.2 Basic Models of Recommender Systems

Most recommender systems are designed to work with two types of data, which are (i) the information of the users and items such as user profiles, user locations, item description or item keywords, and (ii) the interactions between item-user such as rating values. The models that use the first type of data are regarded as *content-based recommender* models, whereas models what use the second type of data are considered as *collaborative filtering* models. There are some recommender systems which leverage both data types and techniques to make a *hybrid* system (Adomavicius and Tuzhilin 2005).

- **Content-based recommendation:** The user will be recommended items similar to the ones that the user has preferred in the past, for instance: based on their own previous purchase

<sup>6</sup> <https://www.amazon.com>

history. For example, a user has bought several history books in the past. Thus, in her next visit to the online bookstore, she is recommended with history books. The system uses “description” data in those books to infer her interests.

- **Collaborative filtering recommendation:** The user will be recommended items based on other users who have similar tastes and preferences. For example, user *A* rated certain action genre movies highly and the system wants to infer whether user *A* will have any interest in romantic genre movies. To be able to do that, the system will find similar users who have given high ratings for action genre movies and have also given ratings to romantic genre movies. Then by combining those ratings from other similar users, the system can infer user *A*'s interest in romantic genre. The idea is that users who share similar interests may behave in a similar manner.

Regardless of which recommendation models being used, there are certain drawbacks that a good recommender system must overcome, and we list them as the following (Adomavicius and Tuzhilin 2005):

- **New user problem:** For a user to receive accurate recommendation, he/she needs to rate a sufficient amount of items before the recommender system can understand his/her preferences. As a result, new users who have few ratings, will get low accuracy recommendation.
- **New item problem:** The problem stems from the fact that collaborative methods work only on other users' preferences and previously rated items to make recommendation. As a result, new item which has not been rated yet, will not get recommended until some users discover and rate it.
- **Memorization and generalization:** Content-based recommender systems usually suffer from high *memorization* rate problem, i.e., users are recommended with only those items that are similar to their previously rated items, thus lacking the diversity. However, diversity or *generalization* of the recommended items is very important, which allows the user to explore more options and further improving the user's engagement. Ideally, the user should receive a range of diverse items and not only from homogeneous categories.
- **Sparsity:** In recommender systems, it often occurs that the number of rated items is very small as compared to the number of items that have not been rated. Therefore, making accurate rating based on small samples is a very challenging task.

### 3 Deep Autoencoder Model

In this section, we provide the details about related works and the implementation of our DAE model. We show the flexibility of our model when evaluating different sets of parameters, and how these configurations reflect upon the rating prediction.

#### 3.1 Neural Network Model of Recommender Systems

To overcome aforementioned challenges in Section 2.2, researchers are now exploiting neural network models for recommender systems. Particularly, the DAE model is the choice of several researchers because of its superior capacity in learning the reconstruction of rating matrix. Autorec (Sedhain et al. 2015) is the pioneer work in this area. In this work, the authors developed I-Autorec and U-Autorec for making prediction from user-based or item-based ratings, respectively, using one hidden bottle neck layer. Kuchaiev and Ginsburg (2017) applied dropout technique while Strub and Mary (2015) introduced denoising feature into their model. Suzuki and Ozaki (2017) applied a hybrid model using both autoencoder model and collaborative filtering method to calculate the hidden similarity for more serendipitous recommendation.

These researches provide promising models but what we have found so far is that besides the similarity of using autoencoder model, all of these researchers are using very different parameter settings on similar datasets such as MovieLens or Netflix. Autorec used a fix set of parameters and one hidden layer. Kuchaiev and Ginsburg (2017) did experiment with different parameters, but they limited to only activation functions, optimizer and hidden layers. Similarly, Strub and Mary (2015) also used one fix set of parameters with TANH activation function and SGD optimizer. We believe that understanding and tuning these parameters correctly, will have a huge impact on the correctness and robustness of the DAE model. This is the motivation behind this work to develop our own DAE model for recommender systems, called FlexEncoder.

### 3.2 FlexEncoder Design

Our FlexEncoder model is a DAE neural network. We have implemented different features originated from various works such as *denoising* feature from (Strub and Mary 2015), *dropout* from (Srivastava et al. 2014), *dense re-feeding* feature from (Kuchaiev and Ginsburg 2017) and autoencoder rating for user-based and item-based in (Sedhain et al. 2015).

An autoencoder is a neural network that has two functions during the training process, namely the encode function  $encode(x): R^n \rightarrow R^d$  and the decode function  $decode(z): R^d \rightarrow R^n$ . The main objective of autoencoder is to retrieve the data representation of  $d$  dimension so that the error between  $x$  and the reconstruct function given in Equation 1, is minimized (Hinton and Salakhutdinov 2006). This is the basic model for DAE network. There are other variants such as denoising autoencoder (Vincent et al. 2008) in which additional noises are added to the inputs to make hidden layers be able to discover more latent features and provide more robust results. Our model follows denoising autoencoder architecture:

$$f(x) = decode(encode(x)) \quad (1)$$

Figure 2 shows one example of our model with three hidden layers. Notice that the input layer can drop certain nodes for noise corruption. The bottleneck layer  $z$  also has *dropout* technique applied. Aside from that, FlexEncoder model is similar to feed-forward neural network with fully connected layers and each layer makes the computation of value  $c$  as given by Equation 2:

$$c = f(W * x + b) \quad (2)$$

Here  $f$  is the activation function,  $W$  is the weight,  $x$  is the input value and  $b$  is the bias. The decoder part is the reversed architecture of the encoder part and it comes after the bottleneck layer in the middle. There are certain manipulation techniques that can be applied to the decoder part, such as constrained decoder. If constrained decoder is used, the decoder weights  $W_d^l$  will be equal to the transpose of encoder weights  $W_e^l$ , and this restricts the weights freedom of the decoder. Additionally, we add several experimental features to our FlexEncoder model such as:

- *Prediction rounding*: After training our FlexEncoder, we run it on the test set where we mask out certain ratings to calculate the prediction accuracy. The FlexEncoder can predict rating value ranging from -2 to 6 or 7, whereas the actual valid rating from MovieLens dataset is in the range of [1, 1.5, 2, ... 4.5, 5]. This out-of-valid-range predicted ratings result is useful in many scenarios, such as when we want to get the top  $k$ -items with highest ratings for a target user. However, with *prediction rounding* feature enabled, any predicted ratings from our model will be rounded off to the nearest suitable rating range. For example, if the predicted rating is 2.34, it will be rounded off to 2.5 and if the predicted rating is 2.15, it will be rounded off to 2. Doing so will result in a higher number of items with highest rating (rating value 5). This technique can improve the diversity of the recommendation items, but it can affect the prediction accuracy. We will discuss this effect in the evaluation section.
- *Dense re-feeding rounding*: When this feature is enabled, *dense re-feeding* technique is activated (Kuchaiev and Ginsburg 2017). Like the *prediction rounding*, during the *re-feeding* phase, we round off all the output values in feeding layer to the range of 1 to 5. However, our analysis shows that enabling *dense re-feeding rounding* feature does not improve the prediction accuracy.
- *Mean normalization*: This is a process of averaging each user's ratings around value *zero*, which effectively removes the user biasness, since some users may be strict in rating than others. Each user's or movie's mean is calculated by Equation 3:

$$\mu_i = \frac{1}{n} \sum_{x=1}^n x_i \quad (3)$$

where  $x_i$  is the user or the movie rating. The new *normalized rating* is  $\bar{r}_i = r_i - \mu_i$ . Same idea of *mean normalization* is also used by (Strub et al. 2016) but we extended it by comparing both evaluations where we disable and enable *mean normalization* to see its effect on the accuracy of our model.

### 3.3 FlexEncoder Configurable Parameters

The name FlexEncoder means "flexible autoencoder". By reviewing the previous literature related to the autoencoder model, we found that each work used a very different set of hyper-parameters and other

settings on the same dataset. Their choice of parameters is mostly heuristic based and are selected through trial and error approach, doing multiple experiments until a suitable set of parameters is found. This final set of parameters is then used across the whole process for the evaluation. We want to analyse these parameter settings, as we are curious to know that whether certain choices of parameter can reveal any pattern that provides good accuracy in rating prediction, and if there is, why that particular choice works well but not the others. To meet this goal, we implemented our FlexEncoder with extensive configurable parameters. Table 1 gives an explanation for all of the parameters we currently have. Some of them are hyper-parameters, while others are enhancements with a purpose to improve the prediction accuracy. Each time the model is trained, a certain set of parameters get chosen to evaluate its effect on the prediction accuracy.

For the categorical parameters such as activation types, we chose six activation functions, which are *SELU*, *RELU*, *RELU6*, *ELU*, *LRELU*, *SIGMOID*, *TANH* and *SWISH*. For the optimization techniques, we chose *ADAM*, *ADAGRA*, *RMSPROP* and the typical *SGD*. Hidden layers parameter value is selected randomly from the list of  $2^1$  to  $2^{12}$  with a maximum of 5 hidden layers for the encoder. Thus, a full network can have up to a maximum of 10 hidden layers.

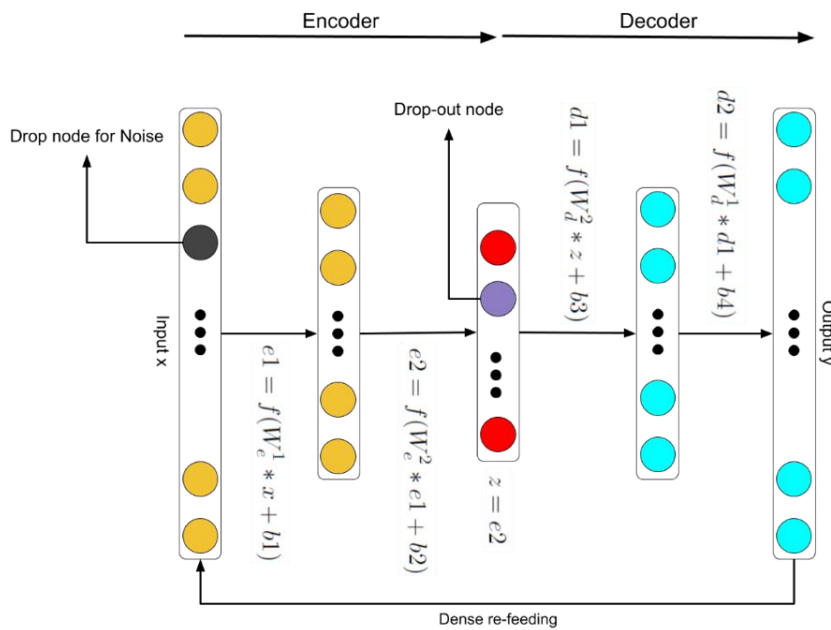

Figure 2: The FlexEncoder model

### 3.4 FlexEncoder Loss Function

In a neural network, the loss function is a very crucial piece for any good model. During the training process, missing ratings are represented with value 0. It is because, the valid rating are from 1 to 5 so when we calculate and optimize the loss during backward propagation, we ignore all the zero ratings at input layer and the common loss method for that is called Masked Mean Square Error loss (MMSE). Techniques like (Sedhain et al. 2015) and (Kuchaiev and Ginsburg 2017) have also used the same MMSE loss. We also employ this method in our model implementation. In addition, the model loss measurement unit, Root Mean Square Error (RMSE), has a direct correlation with MMSE that is  $RMSE = \sqrt{MMSE}$ . MMSE is given by Equation 4:

$$MMSE = r_i * \frac{(y_i - q_i)^2}{\sum_{i=0}^n m_i} \quad (4)$$

Here,  $y_i$  is the real user rating, and  $q_i$  is the reconstructed rating value from the model. To ignore the 0 value, we simply use a mask value  $r_i$  such that  $r_i = 0$ , if  $y_i = 0$  and  $r_i = 1$  otherwise. For the special case when we enable *mean normalization* parameter, we cannot ignore rating value 0. In that case, it can be fixed by setting  $r_i = 1$  for all  $y_i$ .

Count	Parameters	Meaning	Example
1	<b>LR</b> - Learning rate	Learning rate $\alpha$	0.001
2	<b>WeD</b> - Weight decay	Regularization term $\lambda$	0.001
3	<b>HLS</b> - Hidden layers	Number of layers and dimension for each layer. For example [512, 256] means 2 hidden layers each has size of 512 and 256 nodes respectively.	[512, 256]
4	<b>DrP</b> - Drop probability	Dropout rate for bottle neck layer.	0.3
5	<b>NoP</b> - Noise probability	Dropout rate for introducing noises into the inputs.	0.2
6	<b>TBS</b> - Train batch size	One batch including many rows of record to feed into the model for every training iteration. This is the size of one batch.	128
7	<b>Ep</b> - Epochs	The number training cycles we repeat for one dataset.	20
8	<b>Opt</b> - Optimizer	The optimization algorithm to optimize the model, such as ADAM or SGD.	ADAM
9	<b>Act</b> - Activation	The type of non-linear activation function, such as RELU.	RELU
10	<b>DeF</b> - Dense re-feeding	Use <i>dense re-feeding</i> technique for k times, for example if parameter value is 1, use <i>dense re-feeding</i> one time for each training batch.	1
11	<b>DeFR</b> - Dense re-feeding Rounding	If enabled, <i>dense re-feeding</i> values get rounded to range of 1 to 5	True
12	<b>DeC</b> - Decoder constraint	If enabled, put constraint on decoder weight as the transpose of encoder weight	False
13	<b>MeN</b> - Mean normalization	If enabled, apply <i>mean normalization</i> during the training and evaluation phases.	True
14	<b>PrR</b> - Prediction Rounding	If enabled, apply <i>prediction rounding</i> .	False
15	<b>PI</b> - Pivot indexes	If value is [0, 1], run model as user-based rating. If value is [1, 0], run model as item-based rating.	[0, 1]
16	<b>TMR</b> - Test masking rate	Percentage of test data get masked out (removed) for testing the model accuracy.	0.5
17	<b>TSR</b> - Test split rate	The pre-processing <i>test split rate</i> .	0.3

Table 1. The FlexEncoder parameters list

## 4 Evaluation

The main objectives of our research is to find out what parameter combinations provide the optimal loss, or strike a balance between loss and training time, and also to understand the reasons behind that. We have implemented our system in a flexible way using configuration files for dataset and model. Altogether, we have about 17 parameters that can be adjusted for training. To change these parameters, we simply alter the value in the configuration files, then retrain and test the model again. Table 1 shows the list of parameters and their meanings during the training phase of our FlexEncoder model. When comparing our implementation to other similar works, there are many enhancements in our FlexEncoder model. Autorec (Sedhain et al. 2015) implemented the standard DAE recommender system. However, they used default value 3 to fill in the missing entry while we actually calculate the mean for each user or each movie if *mean normalization* step is enabled in configuration file. We also implemented *dense re-feeding* feature from the work of (Kuchaiev and Ginsburg 2017) and added our tweak *dense re-feeding rounding*, where we mimic the actual user input and round off them to whole or half number such as 1 or 1.5 for the re-feeding process.

### 4.1 Dataset Processing

We used the MovieLens 100K dataset for the evaluation of our FlexEncoder model. MovieLens 100K is managed by GroupLens and contains 100,000 movie ratings for 9,000 movies by 700 users. During the pre-processing phase, we mapped all of original user and movie identification (ID) values into a new incremental set of ID values. This helps to break any gap within the original ID values and make the computation on sparse rating matrix in our model more efficient. Also, we calculated the rating mean of each user/movie accordingly, which is called *mean normalization*. We have seen that not many previous researches have mentioned *mean normalization* in their autoencoder models or it was applied by using

a fix value, such as Autorec (Sedhain et al. 2015). Autorec assigned missing entry a default rating score of 3. In our experiments, the use of *mean normalization* yields better prediction results. Other aspects such as the *split rate percent* of training and testing records are also among our parameters. The default split rate is 30% for test data but we varied it from 10% to 40% and applied randomization of records when splitting during our analysis. The rating score for MovieLens dataset is in the range of 1 to 5.

## 4.2 Environment Setup and Sample Results

To conduct our evaluation and investigate about the parameter effect, we collected large samples of our FlexEncoder model evaluation on 100K dataset with different parameter configurations. From Table 1, we have 17 parameters to choose from and each of them have their own set of values. We roughly estimated that the number of possible values for all parameter combinations is more than 10 billion. Hence, it is not feasible for us to check FlexEncoder model’s RMSE for all combinations. Therefore, we employed a randomized technique where each run returns a complete random set of parameters and we ran over 1000 iterations to collect the RMSE losses and analysed those results. Figure 3 shows the statistics of our evaluation results. We collected about 700 samples for user-based ratings and 300 samples for item-based ratings. The highest RMSE is 11.060 and the lowest RMSE is 0.833. The evaluation was done with PyTorch framework<sup>7</sup>, running on an Intel CORE i7 laptop with graphic card NVIDIA GTX 1080 and 16GB RAM for one week.

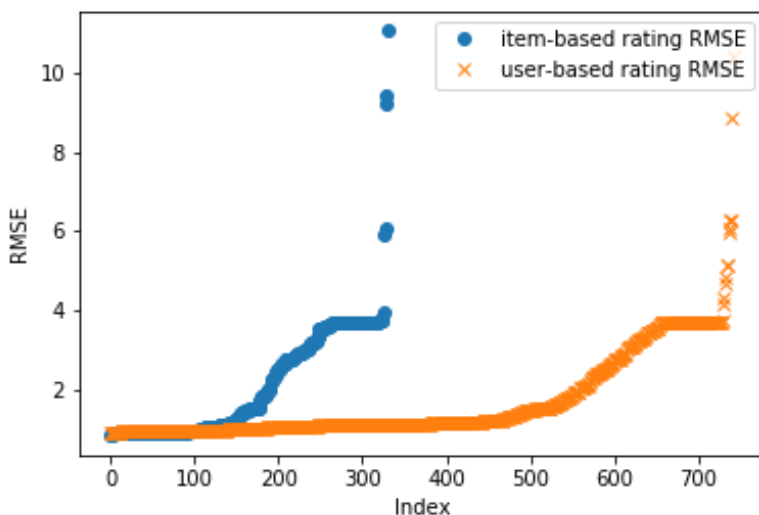

Figure 3: Evaluation results with 700 samples for user-based and 300 samples for item-based ratings.

## 4.3 Accuracy Influence

The first aspect that we investigated is that what kind of parameters provide the optimal value for our main evaluation metric, the RMSE loss. Table 2 shows the top 10 combinations that provide the lowest RMSE loss. It is noticeable that all of them are item-based with *PI* value of [1, 0] and all of them have *mean normalization* feature enabled. Other parameters do not really show a pattern except the *hidden layers* which shows an interesting property: its value is either in descending or ascending order. Moreover, we found that one hidden layer can also provide a low RMSE like the multiple hidden layers. It makes us to re-evaluate our initial assumption that more hidden layers would produce better prediction accuracy for autoencoder recommender systems.

We also compared our model with other existing methods for the same MovieLens 100K dataset and the results are shown in Table 3. As seen from Table 3, our FlexEncoder model has the lowest RMSE as compared to other state-of-the-art recommendation techniques. The lowest RMSE score for our FlexEncoder is achieved with parameter set 1 in Table 2.

<sup>7</sup> <https://pytorch.org>

Set	HLs	WeD	DrP	NoP	Opt	Act	DeC	MeN	PrR	PI	RMSE
1	[64, 4]	0	0.6	0.8	ADAGRAD	TANH	TRUE	TRUE	FALSE	[1, 0]	0.833
2	[8, 32, 64, 512, 1024]	0.001	0	0	SGD	RELU6	FALSE	TRUE	FALSE	[1, 0]	0.837
3	[4096, 4, 1024]	0.005	0.1	0.5	ADAGRAD	ELU	FALSE	TRUE	FALSE	[1, 0]	0.848
4	[2048, 256, 32, 2]	0.005	0.5	0.4	SGD	SELU	FALSE	TRUE	FALSE	[1, 0]	0.865
5	[16, 16, 128, 512, 1024]	0.01	0.3	0.5	SGD	SIGMOID	TRUE	TRUE	TRUE	[1, 0]	0.872
6	[2, 4, 32, 256, 2]	0.001	0	0.5	ADAGRAD	SELU	FALSE	TRUE	FALSE	[1, 0]	0.877
7	[16, 8]	0.001	0.7	0.6	SGD	SWISH	TRUE	TRUE	TRUE	[1, 0]	0.879
8	[128, 16, 256, 128]	0.1	0.9	0.4	ADAM	RELU6	TRUE	TRUE	FALSE	[1, 0]	0.884
9	[128]	0.01	0.8	0.4	SGD	ELU	FALSE	TRUE	TRUE	[1, 0]	0.885
10	[64]	0.1	0.9	0.5	SGD	ELU	TRUE	TRUE	FALSE	[1, 0]	0.886

Table 2: 10 parameters sets with the lowest RMSE for MovieLens 100K rating prediction.

Technique	RMSE	Improvement (%)
<b>FlexEncoder (base)</b>	<b>0.833</b>	<b>0</b>
AutoRec	0.887	-0.064
Slope One	0.937	-0.125
Regularized SVD	0.989	-0.187
Improved Regularized SVD	0.954	-0.145
SVD++	0.903	-0.08
NMF	0.944	-0.133
BPMF	0.901	-0.081
RBM-CF	0.936	-0.123
Autoencoder COFILS	0.885	-0.062
Mean Field	0.903	-0.084

Table 3: FlexEncoder scores lowest RMSE in comparison with other techniques. RMSE values are taken in the work of (Barbieri et al. 2017)

#### 4.4 Analysis of Autoencoder Parameters Influence

With over 1,000 collective evaluation results from various parameter combinations, we tried to investigate, if there are any interesting patterns in the parameter combination that affects the accuracy of the model. Some general observations are already given in Section 4.3 such as *mean normalization* and *item-based prediction* which give quite optimal RMSE loss. Moreover, we were looking for specific patterns that are closely related to DAE network. Our first attempt was to look at the correlation between FlexEncoder parameters which is shown in Figure 4. Unfortunately, there is no clear positive or negative correlation between any pair of parameters. As a result, we have to look deeper into our experiment results, and here are some apparent patterns that we found so far:

- Our experiments with *prediction rounding* and *dense re-feeding rounding* did not yield optimal results for the prediction accuracy, when we enabled them. However, if the *prediction rounding feature* was enabled, we received more movies with 5 stars rating. This increases the diversity of recommended item content. With this observation, we plan to remove *dense-refeeding rounding* but keep *prediction rounding* experimental parameters in the future development.
- Parameter combinations that include certain *dropout* rate and *noise* rate, make the model more robust and provide good predictions. However, there is no clear evidence that a high rate of *dropout* or *noise* will make it better, since a low rate of *dropout* or *noise* result is also good in our evaluation. We conclude that *dropout* and *noise* features are necessary when applying DAE in a recommender system.
- In (Kuchaiev and Ginsburg 2017), the authors suggested that *SELU* activation function with *SGD* optimizer provided the best result for their model. However, in our case, the experimentation shows that the choice of activation functions and optimizers is uncertain for item-based rating. As shown in Table 2, different types of activation functions and optimizers can still provide a comparable low RMSE loss.
- Since the top RMSE parameter sets are all item-based with *PI* value is [1, 0], we want to check the model performance on user-based ratings with *PI* value of [0, 1]. Unlike item-based rating, user-based rating shows consistent parameter patterns. The most common parameters that help

achieve the RMSE in the range of 0.90 to 0.91 are: ADAM optimizer, SELU activation function and 1 round of *dense-refeeding* with *mean normalization* enabled.

	LR	WeD	DrP	NoP	TBS	TMR	Ep	DeF	DeFR	DeC	MeN	PrR	TSR	RMSE
LR	1.000	0.079	0.169	0.162	0.043	0.033	-0.151	0.103	0.163	0.145	-0.125	0.157	-0.042	0.088
WeD		1.000	0.203	0.181	0.045	0.012	-0.197	0.053	0.129	0.115	-0.159	0.136	-0.039	-0.014
DrP			1.000	0.361	0.093	-0.007	-0.375	0.118	0.321	0.289	-0.335	0.295	-0.124	0.032
NoP				1.000	0.141	-0.006	-0.360	0.122	0.325	0.306	-0.323	0.325	-0.134	0.057
TBS					1.000	-0.044	-0.148	0.085	0.151	0.092	-0.148	0.183	-0.075	-0.017
TMR						1.000	0.024	0.012	-0.044	0.005	0.014	0.031	-0.013	0.040
Ep							1.000	-0.113	-0.345	-0.340	0.356	-0.309	0.115	0.012
DeF								1.000	0.137	0.093	-0.094	0.152	0.007	0.022
DeFR									1.000	0.271	-0.247	0.246	-0.107	0.056
DeC										1.000	-0.282	0.267	-0.066	-0.009
MeN											1.000	-0.337	0.135	0.010
PrR												1.000	-0.164	-0.027
TSR													1.000	0.031
RMSE														1.000

Figure 4: FlexEncoder parameters correlation matrix for over 1000 evaluation samples

#### 4.5 Influence Generalization to Bigger Datasets

After more than 1,000 experiments with different combinations of parameters, we want to know if the top parameter sets can generalize its prediction accuracy to bigger datasets in the same family which are MovieLens 1M and 20M. At current state, we did a preliminary testing on the MovieLens 1M dataset. The results are shown in Figure 5. We used the top 10 parameter sets in Table 2 and evaluated each of them on the MovieLens 1M.

In general, they do not provide as good RMSE loss values as the 100K dataset. However, all RMSE loss values are lower than 0.98 with mean of 0.961 and the best RMSE parameter set for 100K dataset (set 1) also provides the best RMSE loss for 1M dataset with RMSE loss at 0.894. These results are remarkable since we just applied the same model architecture of the dataset 100K to dataset 1M without going through many experiments to find a good set of parameters. From this observation, we conclude that FlexEncoder model does generalize well to bigger datasets to a certain extent. This can help tremendously when finding a good parameter set for a much bigger dataset such as MovieLens 20M.

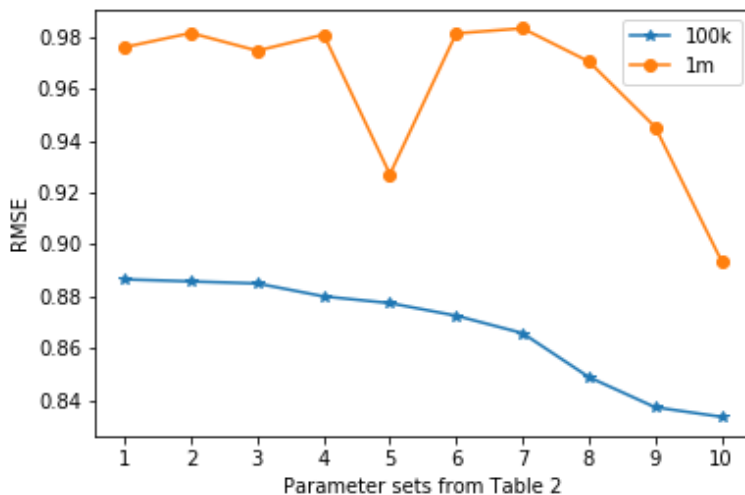

Figure 5: RMSE results from top 10 parameter sets (Table 2) for MovieLens 100k and 1M datasets

## 5 Conclusion

Deep Autoencoder for recommender systems shows its tremendous potential. In this work, we have presented and implemented our FlexEncoder model by embedding our own unique features and innovative features from other recent works. We argue that parameters for DAE significantly affect the model prediction accuracy and we validated this through an extensive evaluation and analysis. In addition to that, we also discover certain parameter patterns that help us to quickly identify how to tune



the model to make the best out of it and to be able to achieve better accuracy than other state-of-the-art techniques. This shows the potential of our model for future development.

Nevertheless, we are still improving our work on FlexEncoder. We plan to improve our model by adding more parameter values such as optimization algorithm ADADELTA as well as introducing more activation functions. Additionally, we plan to test our model with other datasets such as Netflix, to evaluate how well our FlexEncoder can adapt to other datasets. Finally, we want to understand why certain sets of parameters can provide an optimal RMSE loss, which will help us in further improving our model.

## 6 References

- Adomavicius, G., and Tuzhilin, A. 2005. "Toward the next Generation of Recommender Systems: A Survey of the State-of-the-Art and Possible Extensions", *IEEE Transactions on Knowledge and Data Engineering*.
- Barbieri, J., Alvim, L. G. M., Braida, F., and Zimbrão, G. 2017. "Autoencoders and Recommender Systems: COFILS Approach," *Expert Systems with Applications* (89), pp. 81–90.
- Bell, R. M., and Koren, Y. 2007. "Improved Neighborhood-Based Collaborative Filtering," *KDD Cup and Workshop*.
- Burke, R. 2002. "Hybrid Recommender Systems: Survey and Experiments," *User Modeling and User-Adapted Interaction* (12).
- Domingos, P., and Richardson, M. 2001. "Mining the Network Value of Customers," in *Proceedings of the Seventh ACM SIGKDD International Conference on Knowledge Discovery and Data Mining - KDD '01*.
- Hill, W., Stead, L., Rosenstein, M., and Furnas, G. 1995. "Recommending and Evaluating Choices in a Virtual Community of Use," in *Proceedings of the SIGCHI Conference on Human Factors in Computing Systems - CHI '95*.
- Hinton, G. E., and Salakhutdinov, R. R. 2006. "Reducing the Dimensionality of Data with Neural Networks," *Science*.
- Kuchaiev, O., and Ginsburg, B. 2017. "Training Deep AutoEncoders for Collaborative Filtering," *ArXiv:1708.01715 [Cs, Stat]*.
- Liu, J., Dolan, P., and Pedersen, E. R. 2010. "Personalized News Recommendation Based on Click Behavior," in *Proceedings of the 15th International Conference on Intelligent User Interfaces - IUI '10*.
- Sedhain, S., Menon, A. K., Sanner, S., and Xie, L. 2015. "AutoRec : Autoencoders Meet Collaborative Filtering," *WWW 2015 Companion: Proceedings of the 24th International Conference on World Wide Web*.
- Srivastava, N., Hinton, G., Krizhevsky, A., Sutskever, I., and Salakhutdinov, R. 2014. "Dropout: A Simple Way to Prevent Neural Networks from Overfitting," *Journal of Machine Learning Research* (15), pp. 1929–1958.
- Strub, F., Gaudel, R., and Mary, J. 2016. *Hybrid Recommender System Based on Autoencoders*, ACM Press, pp. 11–16.
- Strub, F., and Mary, J. 2015. "Collaborative Filtering with Stacked Denoising AutoEncoders and Sparse Inputs," *Nipsw*.
- Suzuki, Y., and Ozaki, T. 2017. "Stacked Denoising Autoencoder-Based Deep Collaborative Filtering Using the Change of Similarity," in *2017 31st International Conference on Advanced Information Networking and Applications Workshops (WAINA)*, March, pp. 498–502.
- Vincent, P., Larochelle, H., Bengio, Y., and Manzagol, P.-A. 2008. "Extracting and Composing Robust Features with Denoising Autoencoders," in *Proceedings of the 25th International Conference on Machine Learning - ICML '08*.
- Patrick, H., Dominik, S., Susanne, R. 2017, "Summer hot, Winter not! – Seasonal influences on context based music recommendations", in *Proceedings of the 28th Australasian Conference on Information Systems - ACIS '17*

## 7 Acknowledgements

The authors wish to thank Data61 (CSIRO) for a provision of the support for this research work.

**Copyright:** © 2018 Dai Hoang Tran, Zawar Hussain, Wei Zhang, Nguyen Lu Dang Khoa, Nguyen H. Tran & Quan Z. Sheng. This is an open-access article distributed under the terms of the [Creative Commons Attribution-NonCommercial 3.0 Australia License](#), which permits non-commercial use, distribution, and reproduction in any medium, provided the original author and ACIS are credited.

# Guidelines Supporting the Formulation of Design Principles

## **Stefan Cronholm**

School of Business and IT  
University of Borås  
Borås, Sweden  
Email: stefan.cronholm@hb.se

## **Hannes Göbel**

School of Business and IT  
University of Borås  
Borås, Sweden  
Email: hanne.gobel@hb.se

## **Abstract**

Design principles represent design knowledge and constitute a prescriptive component that is included in design theory. In design science research, the formulation of generalised and intelligible design principles that can be reused in new contexts is regarded as an important outcome. Our study has revealed that existing design principles vary in terms of structure, content, and level of abstraction. This variation and inconsistency may obstruct the reusability of the design principles. The purpose of this study is to suggest support for the formulation of design principles. In order to enhance the support for the formulation of design principles, we have suggested three guidelines, which are based on analyses of theoretical statements, existing guidelines, and existing design principles. The guidelines are illustrated by using material from a design science research project.

**Keywords** Design principles, design theory, guidelines, design science, design science research.

## 1 Introduction

The discipline information systems (IS) is concerned with designed artefacts (Orlikowski and Iacono (2001). Baskerville et al. (2018) add that the artefact should be a focal point in most IS research. Within the IS discipline, this concern has been paid attention to within the field of design science research (DSR) (e.g. Gregor and Hevner 2013). Venable and Baskerville (2012 p.141) define DSR as “Research that invents a new purposeful artefact to address a generalized type of problem and evaluates its utility for solving problems of that type”. One purpose of DSR is to develop design knowledge. Design knowledge can be represented in different ways and forms at different levels of abstraction. These representations include constructs, technological rules, models, methods, design principles, or full-blown design theories (Gregor and Jones 2007; Gregor and Hevner 2013; Chandra et al. 2015). In this paper, we have focused on the formulation of design principles. The reason is that design principles constitute a common research contribution within the IS domain. Gregor and Jones (2007, p.325) state that design principles “... define the structure, organization, and functioning of the design product or design method”. In other words, their purpose is to guide the design and evaluation of artefacts (Sein et al. 2011). Moreover, design principles should be generalised in order to solve a class of problems rather than a specific set of systems features to solve a specific problem (e.g. Walls et al. 1992; Hevner et al. 2004; Sein et al. 2011). Consequently, one purpose of design principles is to communicate design knowledge that can be reused in new situations.

Our literature review has revealed that there exists a vast amount of design principles that support various kinds of artefact development (e.g. Sein et al. 2011; Göbel and Cronholm 2016). A closer look reveals that they differ in the way they are formulated concerning structure, content and level of abstraction. This variation may obstruct appropriate reuse of the design principles due to lack of consistency and omission of important content. This variation may also obstruct comparison of design principles developed for the same purpose and/or the possibility to build further on them. Chandra et al. (2015) report two problems concerning the formulation of design principles: the problem of inconsistency (inconsistency in orientation towards action or material) and the problem of imprecision (incomplete or misleading). Consequently, their reusability cannot be taken for granted (Chandra Kruse and Seidel 2017). Moreover, existing design principles are rich in tensions and contradictions (ibid.).

Our literature review has also revealed that there exist few guidelines concerning the formulation of design principles (Walls et al. 1992; van den Akker 1999; Goldkuhl 2004; van Aken 2004; Heinrich and Schwabe 2014; Chandra et al. 2015) (see section 5). We claim that existing guidelines often suffer from an explicit and transparent theoretical and empirical grounding. Goldkuhl (2004) claims that grounding means presenting arguments in favour of this knowledge so actors can be more confident in using the knowledge. The need for an analysis of design principles is emphasised by Chandra et al. (2015, p.4039) who state “Although frameworks about the formulation of design knowledge or design theory have been proposed ... the formulation of design principles has not been given its deserved attention”. Another statement reads: “Despite their obvious relevance, however, there is a lack of convention as to how design principles should be formulated and what exactly a design principle is.” (p.4039). Consequently, there is a need for more rigorous guidelines concerning the formulation of design principles. We make a difference between design principles per se and support for the formulation of design principles. We use the term ‘design principles’ when we refer to support for the design of artefacts, while we use the term ‘guidelines’ when we refer to guidelines for the formulation of design principles. The purpose of this paper is to present guidelines which can be used to formulate design principles. The research question we ask reads: what guidelines can support the formulation of design principles with regard to structure, content, and level of abstraction?

The following section presents definitions and arguments for why design principles are an important component in design theory. Then, in section 3, we describe the research approach. Section 4 presents statements identified in theory concerning the formulation of design principles. In section 5, we present an analysis of existing guidelines and section 6 includes an analysis of existing design principles. In section 7, we present the main result of this paper, which consists of enhanced guidelines concerning the formulation of design principles. Section 8 contains a number of examples of design principles based on the guidelines. Finally, in section 9, conclusions are drawn.

## 2 Design principles: What and Why

Hevner and Chatterjee (2010) state that design principles are clear statements of truth that guide or constrain actions. Baskerville and Pries-Heje (2010) add that they are prescriptive in nature, and constitute the basis for action. Moreover, design principles represent design knowledge and constitute a

prescriptive component that is included in the design theory (Chandra et al. 2015). Meth et al. (2015) claim that design principles can be interpreted as explanatory statements, which help explain why a prescribed action leads to a specific goal. Seidel and Watson (2014) claim that design principles are essential in order for the theory to be applicable in practice. Göbel and Cronholm (2017) add that one purpose of design principles is to support designers in their tasks by informing them what to do and how to do it. Kolkowska et al. (2017) claim that design principles can be used by both practitioners and researchers. Another purpose of design principles is to communicate findings to both technology-oriented and management-oriented audiences (Hevner et al. 2004). Chandra Kruse and Seidel (2017) state that design principles are now a predominant form to capture, accumulate, and reuse design knowledge. Moreover, “One important vehicle to convey design knowledge that contributes beyond instantiations applicable in a limited use context is that of a *design principle*” (Chandra et al. 2015, p.4039). Consequently, design principles should include knowledge about creating instances of a class of artefact (Sein et al. 2011). This means that design principles can be formulated on different levels of abstraction. The level of abstraction and needed amount of detail are depending on the context (Chandra et al. 2015). As stated in section 1, the reusability of design principles cannot be taken for granted. In order to enhance the reusability, it is recommended to offer rich contextual descriptions of implementations based on the principles (e.g. Chandra Kruse et al. 2016; Lukyanenko et al. 2017).

### 3 Research Method

We regard guidelines supporting the formulation of design principles as a type of design knowledge. Goldkuhl (2004) states that design knowledge should be justified by theoretical, internal and empirical grounding. Theoretical grounding utilises existing external theoretical knowledge, which constitutes warrants for the emerging theory. Internal grounding includes an evaluation of knowledge cohesion. This means to check how different parts of the emerging theory are related to each other, and that there is logical consistency. Empirical grounding responds to the question ‘Is the prescribed action really successful in practice?’. This means that the emerging theory is observed in practical use and after that evaluated. We have adopted these recommendations, and more specifically we have analysed statements in theory concerning the formulation of design principles, analysed existing guidelines, analysed existing design principles and examples provided of the suggested guidelines by re-interpreting empirical data from a DSR project. Our research method has followed the research process suggested by Webster and Watson (2002): 1) identify relevant literature, 2) structure the review, 3) theory development and 4) evaluation of the theory.

*1) Identification of relevant literature.* We have analysed the eight top IS journals according to the AIS Senior Scholar’s Basket of Journals: European Journal of Information Systems (EJIS), Information Systems Journal (ISJ), Information Systems Research (ISR), Journal of Association of Information Systems (JAIS), Journal of Information Technology (JIT), Journal of Management Information Systems (JMIS), Journal of Strategic Information Systems (JSIS) and, Management Information Systems Quarterly (MISQ). Moreover, we have analysed relevant articles that are cited in these journals. We have searched for ‘DSR’ and ‘design principles’, ‘DSR and ‘guidelines’, and ‘DSR’ and ‘principles’. We have limited the literature review to include literature in the field of DSR that is related to guidelines and design principles. We have also limited the review to include formulations of design principles that are oriented towards designers or developers of artefacts.

*2) The structure of the review.* In order to gain knowledge that can support the development of guidelines, we have organised the literature review in three sequential steps: analysis of statements identified in theory concerning the formulation of design principles, analysis of existing guidelines, and analysis of existing design principles. In all the steps, we have been especially interested in knowledge concerning structure, content and level of abstraction. A ‘concept’ should be understood as a component of a design principle, while ‘structure’ defines the arrangements of and relationships between the concepts viewed from the perspective of the whole rather than from a single part. The ‘level of abstraction’ refers to whether the design principles can be regarded as high-level principles or more concrete context-bounded principles.

*2a) Analysis of statements identified in theory concerning the formulation of design principles.* The purpose of this step was to collect claims and statements concerning formulations of design principles. This analysis has been ‘concept-centric’ (Webster and Watson 2002), which means that we have grouped similar concepts presented by different scholars into categories. This step resulted in knowledge about the formulation of design principles that is theoretically informed and should be considered when developing guidelines (see section 4).

2b) *Analysis of existing guidelines supporting the formulation of design principles.* The purpose of this step was to gain knowledge of how to formulate enhanced guidelines by analysing existing guidelines. The result of the analysis of existing guidelines was compared to the categories identified in step 2a. The purpose of this comparison was to confirm or extend the categories identified in step 2a (see section 5).

2c) *Analysis of existing design principles.* In this step, we was inspired by the analysis conducted by Chandra et al. (2015) who analysed the eight top IS journals according to the AIS Senior Scholar’s Basket of Journals, from the start of the journals to the year 2013, concerning formulations of design principles. They have coded the content of design principles and claim that design principles are either materiality- or action-oriented or both. We have extended their literature review by analysing the same journals for the years 2014-2017. In this respect, our approach has been cumulative. We have explicitly searched for the term ‘design principle’. The first screening resulted in 43 publications. We could filter out 26 papers because they were either in press, did not present any design principles or the term ‘design principle’ was only mentioned in the reference list. This elimination process resulted in 27 remaining papers. Instead of using the predefined codes (materiality-oriented, action-oriented) identified by Chandra et al. (2015), our analysis was open-minded. We analysed the identified design principles by asking the questions: “What concepts are included in this principle?”, “What is the structure regarding arrangements between different parts of the design principle?” and “What is the abstraction level?”. In this way, we were able to induce categories from formulations of existing design principles. Walsham (1995) claims that, in interpretative approaches, the analyst makes various decisions about how to comprehend the data. Such risk can be reduced by involving two or more researchers when searching for and analysing the data (Seuring and Müller 2008). Consequently, the analysis of the design principles was individually conducted by two researchers. Then, the individual analyses were jointly compared and reconciled. Finally, we compared the result of the analysis to the identified categories in step 2a and 2b, in order to confirm existing categories or extend them (see section 6).

3) *Theory development.* The theory development included suggestion enhanced guidelines. The formulations of the guidelines were based on the categories identified in steps 2a-2c. This highly creative process was not linear. Rather, it was iterative, since we needed to go back and forth between the earlier steps in order to gain insights about how to formulate the guidelines (see section 7). This section includes the main result of this paper.

4) *Evaluation of theory.* To illustrate the application of the guidelines, we have re-interpreted a DSR project, which contains rich material that can be used to conduct a retro-perspective analysis. We have re-interpreted and re-formulated a design principle suggested in that DSR project by applying the enhanced guidelines suggested in this study. This re-analysis revealed a few critical changes concerning how the design principles were presented in the DSR project. In this way, we were able to provide concrete examples based on empirical findings gained from a previous DSR project (see section 8). The research project was reported in Göbel and Cronholm (2016).

## 4 Analysis of Statements Identified in Theory

The purpose of this section is to present statements identified in theory that can advise the development of guidelines concerning the formulation of design principles. As mentioned in section 1, the purpose of design principles is to support artefact development. Consequently, we have excluded statements that concern general development of design theory. The categories and the statements are presented in Table 1. In order to support traceability, we have added a reference to each statement. We have identified nine categories which are: action/process, building, evaluation, purpose/goal, artefact, artefact properties, boundary/context, justification, and level of abstraction. ‘Building’ and ‘evaluation’ are regarded as sub-categories of the category action/process.

Category	Statement
Action/ Process	<p>“The design process is a sequence of expert activities that produces an innovative product (i.e., the design artifact).” (Hevner et al. 2004, p.78).</p> <p>“Design science consists of two basic activities, build and evaluate.” (March and Smith, 1995, p.254).</p> <p>“In general, a professional will make ... a <i>process-design</i>, i.e. the professional's own plan for the problem-solving cycle, or, put differently, the method to be used to design the solution to the problem.” (Van Aken, 2004, p. 226).</p>

Building	“Building is the process of constructing an artifact for a specific purpose.” (March and Smith, 1995, p.254).
Evaluation	“Its products are assessed against criteria of value or utility – does it work? Is it an improvement?” (March and Smith, 1995, p.253). “... evaluation is the process of determining how well the artifact performs.” “ (March and Smith, 1995, p.254). “... evaluation is primarily concerned with evaluation of design science outputs, including ... design artefacts.” (Venable et al. 2016, p.77).
Purpose/ Goal	“Design theories must deal with goals as contingencies” (Walls et al. 1992, p.40) “... what the system is for” or the set of meta-requirements or goals that specifies the type of system to which the theory applies ...” (Gregor and Jones, 2007).
Artefact	“Purposeful artifacts are built to address heretofore unsolved problems.” (Hevner et al. 2004, p.78). “...the framework is based on design science research outputs or artifacts: constructs, models, methods, and instantiations.” (March and Smith 1995, pp.255-256) “... the term artifact is used in this paper to refer to a thing that has, or can be transformed into, a material existence as an artificially made object (e.g., model, instantiation) or process (e.g., method, software) (Goldkuhl 2002, p. 5). “(Gregor and Hevner, 2013, p.340).
Artefact properties (form and function)	“... the principles that define the structure, organization, and functioning of the design product or design method” (Gregor and Jones, 2007. P.325). “it [design theory] explains what properties an artefact should have” (Walls et al. 1992, p.41). “... principles governing the development or selection of system features.” (Markus et al. 2002, p.186). “These principles can be of a 'substantive' nature, referring to characteristics of the intervention (what it should look like) ...” (Van den Akker 1999, p.5).
Boundary/ Context	”The precision can be achieved by outlining boundary conditions, within which the design principle applies. The boundary conditions can be explained through a statement of relevant use context or intended user group.” (Chandra et al. 2015, p.4045).
Justification	“... the value of that knowledge will strongly increase when justified by theoretical arguments, well-articulated in providing directions, and convincingly backed-up with empirical evidence about the impact of those principles.” (Van den Akker 1999, p.9).
Level of abstraction	“... it is important that a design principle is formulated sufficiently abstract to leave some space for different instantiations in different contexts that share the defined boundary conditions. This, in turn, reduces the limit of generalizability previously lamented.” (Chandra et al. 2015, p.4045). “...the prescription is to be used as a <i>design exemplar</i> . A design exemplar is a general prescription which has to be translated to the specific problem at hand; in solving that problem, one has to design a specific variant of that design exemplar.” (van Aken 2004, p.227).

Table 1. Statements supporting the formulation of design principles

## 5 Analysis of Existing Guidelines

In total, we have identified six publications that suggest guidelines to support the formulation of design principles. The guidelines per se have constituted our analysis unit. We recognise that there often exists background knowledge, which can be explicit or implicit. The reason for not including background knowledge in our analysis is that the users of guidelines should be able to use them as stand-alone objects and not have to read the entire publications. We also recognise that several authors of guidelines did not have the purpose of suggesting extensive or complete guidelines. However, the identified

literature constitutes existing knowledge concerning guidelines for the formulation of design principles. First, we present the existing guidelines and then we conclude with a summary (see Table 2).

Walls et al. (1992, p.41) discuss guidelines in terms of design rules and suggest the following design rule: "If you want to achieve goal *X*, then make *Y* happen". The rule explicitly includes 'goal' which corresponds to our category with the same name. The phrase "then make *Y* happen" corresponds to the category 'action/process'. Moreover, the conjunction 'then' creates an explanatory relation between 'goal' and 'process'.

Van den Akker (1999, p.9) suggests the following meta-design principle: "If you want to design intervention *X* [for the purpose/function *Y* in context *Z*], then you are best advised to give that intervention the characteristics *A*, *B*, and *C* [substantive emphasis], and to do that via procedures *K*, *L*, and *M* [procedural emphasis], because of arguments *P*, *Q*, and *R*." Our interpretation is that the concept 'intervention' corresponds to the category 'artefact', 'purpose/function' corresponds to the category 'goal', 'characteristics' corresponds to the category 'artefact properties', 'procedures' corresponds to the category 'action/process', and 'argument' corresponds to the category 'justification'.

The meta-design principle suggested by Goldkuhl (2004, p.63) reads: "Perform act *A* in order to obtain goal *G*". We interpret that the concept 'act' corresponds to the category 'action/process' and that 'goal' corresponds to our category with the same name. Similar to Walls et al. (1992), there is a relationship in terms of cause and effect between 'act' and 'goal'. Inspired by Goldkuhl (2004), Heinrich and Schwabe (2014) suggest that design principles should be structured to include value grounding (corresponds to the category 'goals'), conceptual grounding (relationship between constructs and domain objects), explanatory grounding (explanation and justification), and prescriptive statement (formulation of action applicable in design). Their suggestion focuses both on structure and content but does not offer an explicit meta-design principle.

Another meta-design principle similar to the suggestions of Walls et al. (1992) and Goldkuhl (2004) is presented by Van Aken (2004, p.227). The meta-design principle reads: "If you want to achieve *Y* in situation *Z*, then something like action *X* will help". The terms 'achieve *Y*' corresponds to the category 'goal', situation *Z* corresponds to the category 'boundary/context' and 'action *X*' corresponds to the category 'action/process'. The expression 'something like' emphasises that the prescription is to be used as a design exemplar which is a general prescription that has to be translated to the specific problem at hand (ibid.).

The final identified meta-design principle is presented by Chandra et al. (2015) and reads: "Provide the system with **[material property—in terms of form and function]** in order for users to **[activity of user/group of users—in terms of action]**, given that **[boundary conditions—user group's characteristics or implementation settings]**. The concept 'material property' prescribes "*how* an artefact should be built or *what* it should comprise" (p.4042), while 'action' refers to prescriptions about *what* actions the artefact allows for. We interpret that the term 'material property' corresponds to the categories 'action/process' and 'artefact'. The term 'action' corresponds to the category 'goal'. Besides the material- and action-oriented content, the meta-design principle explicitly includes 'user/group characteristics' which we interpret as being an important part of the category 'context'. Chandra et al. (2015, p.4042) define user/group characteristics as follows: "the system should allow users to do this or that".

Our analysis shows that the categories 'action/process' and 'purpose/goal' are represented in all the suggested guidelines. It also shows that the categories 'building' and 'evaluation' are not represented in any meta-design principle. One can claim that these two categories are implicitly included in the category 'action/process'. We claim that these two categories represent the core of DSR and therefore they are significant to DSR and should be explicit. This claim is supported by Hevner et al. (2004), who states that "Much of the work performed by IS practitioners, and managers in general ..., deals with design" (p.78), and that "Evaluation is a crucial component of the research process" (p.85). Based on the statements identified in the literature review, we also consider all the other categories (artefact, boundary/context, justification, level of abstraction) important when formulating guidelines. These other categories are occasionally represented in the existing guidelines. We claim that guidelines that are not detailed enough can be too limited. A guideline such as a meta-design principle needs to be informative in order to lead and determine the course of action (Cronholm and Bruno 2008). Below, we present a summary of the six suggestions described above. The symbol 'X' means that the category is represented in the meta-design principle while the symbol '-' means that the category is omitted. We can conclude that the analysis of existing guidelines confirmed the categories identified in section 4, and did not result in new categories with respect to structure, content and level of abstraction.



	Walls et al. (2004)	Van den Akker (1999)	Goldkuhl (2004)	Van Aken (2004)	Heinrich and Schwabe (2014)	Chandra et al. (2015)
Action/ Process	X	X	X	X	X	X
Building	-	-	-	-	-	-
Evaluation	-	-	-	-	-	-
Purpose/ Goal	X	X	X	X	X	X
Artefact	-	X	-	-	-	X
Artefact properties	-	X	-	-	-	X
Boundary/ Context	-	X	-	X	-	X
Justification	-	X	-	-	X	-
Level of abstraction	-	-	-	X	-	-

Table 2. Summary of representation of categories in existing guidelines

## 6 Analysis of Existing Design Principles

Our analysis of existing design principles has revealed that they vary with respect to structure, content and level of abstraction. This variation includes design principles: a) between different studies and b) within the same study. We can also conclude that the existing guidelines (see section 5) have not explicitly been adopted in order to develop design principles. We have found that design principles are often presented as a set of design principles (e.g. Kolkowska 2017). However, we have observed that design principles included in the same set address different artefacts (e.g. Spagnoletti et al. 2015). For example, one design principle could guide process development and another could guide the development of the properties of a digital tool. We state that the rationality behind presenting design principles as a set is that they have a common ground or purpose. We claim that the common ground for a set of design principles is the artefact they address. Consequently, all the design principles that are members of the same set should address the same artefact. Individually, each design principle could be directed towards different aspects of the same artefact. In this way, the design principles that are included in the same set are logically connected and form a congruent wholeness.

We have also found that design principles that are included in the same set have different structures. One example is the study conducted by (Lukyanenko et al. 2017) who presents a set of design principles where some design principles are presented on a format similar to the meta-design principle suggested by Walls et al. (1992): “If you want to achieve goal X, then make Y happen”, while other design principles just include the ‘action’ and omit the ‘goal’. The problem of inconsistency is also reported by Chandra et al. (2015). However, they refer to inconsistency in the orientation of design principles, while we add that there is inconsistency concerning the structure of design principles.

With respect to content, we have found that design principles often include two basic parts: a short name and a description (Lee et al. 2018; Liu et al. 2017). The purpose of the name is to support the identification of the design principle, and the purpose of the description is to support an understanding of how to apply the design principle. We have also found that the most frequent categories included in the description part are: action/process, purpose/goal, artefact and justification. The other categories presented in sections 4 and 5 exist occasionally. The analysis of the design principles did not result in new categories. The analysis has also identified that the existing design principles include modal auxiliary verbs such as: ‘could’ (grants permission), ‘should’ (indicates a recommendation), and ‘must’ (indicates a requirement) (ISO 2018). These modal auxiliary verbs correspond well to the prescriptive nature of DSR.

With respect to the level of abstraction, we have found that a majority of the design principles are formulated on a high-level of abstraction. For example, Lee et al. (2018, p.74) state that “... our design principles can be regarded as a top-level prescriptive design specification”. One purpose of presenting

design principles on a high-level of abstraction is: “An artifact that is presented with a higher level degree of abstraction can be generalized to other situations and is more interesting than a simple descriptive case study of what happened in one situation.” (Gregor and Hevner 2013, p.352). The identified design principles on a high-level of abstraction provide general knowledge but lack detailed information or examples of how the design principles could be manifested in the artefact. We have also identified design principles formulated on low-levels of abstraction (e.g. Lukyanenko 2017). These design principles provide rich contextual descriptions and illustrations that support an understanding. Röstlinger and Cronholm (2009) add that usable principles always should be contextualised to support a specific focus of the phenomenon analysed. Consequently, they are intelligible, but there is also a risk that they are too limited to the specific context and that they do not support reusability in other contexts. To summarise, most design principles include *either* high-level abstractions *or* low-level abstractions. We claim that an interplay between formulations on high- and low-level of abstraction supports the understanding. Consequently, *the combination* of high- and low-level abstractions complement each other concerning generalisation and reusability vs intelligibility and contextual understanding. In other words, we claim that the possibility of reusing design principles increases if both abstraction and concretion support them.

The analysis of existing design principles extended the categories presented in sections 4 and 5. The following new categories were identified: logical connection, congruency, consistency, and, high and low levels of abstraction.

## 7 Enhanced Guidelines

In order to guide the formulation of design principles, we have formulated three guidelines. The guidelines have been created by using the knowledge gained from the analyses, including the identified categories, in sections 4-6. We claim that the guidelines together form a wholeness, which means that they all should be considered when formulating design principles. Moreover, we recognise that the suggested guidelines can be adjusted according to the situation at hand.

### *Meta-design principle 1: Content*

In order to formulate design principles for the purpose of gaining informative, intelligible and transparent content, the design principles should include prescriptions of:

- The purpose/goal of the artefact, justified with argument(s).
- The action/process concerning the building of the artefact, justified with argument(s).
- The boundary/context specifying where the artefact can be used, justified with argument(s).
- The artefact properties, justified with argument(s).
- The action/process concerning the evaluation of the artefact, justified with argument(s).

### *Meta-design principle 2: Structure*

In order to formulate design principles for the purpose of creating a homogenous structure, the design principles should be:

- Congruent (directed to the same artefact).
- Logically connected (directed towards different aspects of the artefact that together form a wholeness).
- Consistent (having uniformity).

### *Meta-design principle 3: High- and low-levels of abstraction*

In order to formulate design principles for the purpose of increased understanding and to support reusability, the design principles should:

- Be formulated on both high- and a low-levels of abstractions (including examples).
- Explicitly describe the class and the instance of the artefact.

## 8 Illustration of Guidelines

In this section, we have evaluated the suggested guidelines by illustrating how they can be used to formulate design principles. We have reinterpreted the original design principle ‘Design for co-problematization’ suggested by Göbel and Cronholm (2016) which aimed to support the design of a digital service

platform in the domain of IT Service Management (ITSM). The original design principle was formulated on a high-level of abstraction. The re-interpretation of the design principle has been supported by empirical evidence extracted from project documentation concerning improved process efficiency in ITSM. Based on the guidelines, the reinterpreted design principle is presented in Table 3 and called ‘Design a digital service platform supporting co-problematisation’. To support readability, we have chosen to present the design principle in the format of a table. We recognise that other formats can be used.

Category	High-level abstraction	Low-level abstraction	Justification of category
<i>Artefact</i>	The artefact belongs to the class of digital service platforms.	The instance of the artefact class is digital service platforms supporting co-problematisation.	To strengthen the relationship between service providers and customers, in order to support shared resources and value co-creation.
<i>Purpose/goal</i>	Facilitate service innovation concerning the delivery of IT services that are based on a shared understanding of problems.	Utilise a service-oriented perspective (operand and operant resources, resource integration and value co-creation).	Gained competitive advantages for both service providers and service customers.
<i>Action/process for building</i>	Review the literature. Collect data from all the actors involved.	Collect information concerning the different understanding of problems related to the delivery of IT services. Organise a workshop including all the involved actors to gain a shared problem understanding. Specify requirements of the artefact functionality. Collect feedback from the use of the artefact (iterative process).	A shared understanding of problems will create improved conditions for identifying solutions for an enhanced service delivery process (empirical argument), 2) the suggested action is supported by fundamental premises in service-dominant logic (e.g. Vargo and Lusch 2004) (theoretical argument).
<i>Boundary/context</i>	IT Service Management.	ITSM is characterised by process and customer orientation where IT is claimed to be delivered as a service.	The choice of context is motivated by a problem (lack of digital artefacts facilitating service innovation) formulated by practitioners.
<i>Artefact properties</i>	Develop a digital support for joint customer and service provider co-problematisation.	Develop digital functionality supporting service providers and service customers to identify different opinions of a problem, concerning IT service delivery (e.g. incident management).	An increased understanding of different perspectives will tighten the relationships between service providers and service customers.
<i>Action/process for evaluation</i>	Evaluate the implemented artefact properties in order to demonstrate utility, quality, and efficacy (c.f. Venable et al. 2016).	Use naturalistic evaluation episodes consisting of questionnaires and interviews.	An improved knowledge concerning the fulfilment of the goals will legitimise use of the digital service platform

Table 3. Design principle: Design a digital service platform supporting co-problematisation.

We claim that the reinterpretation of the original design principle has resulted in an informative design principle concerning content and prescriptions on high- and low-level of abstraction. Consequently, the use of the guidelines strengthened the design principle’s reusability. The original design principle: did not include all the suggested categories, was only formulated on a high-level of abstraction and did not include justification. Due to limited space, the illustration includes only one example of a reinterpreted

design principle. Consequently, we could not illustrate meta-design principle 2, since it guides a situation where two or more design principles are developed. However, when several design principles are developed, we claim that they should be congruent, logically connected and consistent.

## 9 Conclusion

In this paper, we have developed guidelines to support the formulation of rigour and reusable design principles. We claim that our enhanced guidelines can be regarded as a response to the criticism provided by Chandra et al. (2015) who state that design principles show inconsistency and imprecision. Based on our analyses, we have drawn three conclusions:

- Existing design principles vary concerning structure, content and level of abstraction.
- Existing guidelines are promising: However, essential categories are omitted, and support for formulations on high- and low levels of abstraction is not included.
- The enhanced guidelines have improved formulations of design principles.

The conclusions are based on knowledge gained from statements identified in theory, existing guidelines, existing design principles, and from empirical illustration. Consequently, they rest on solid ground. As future research, we suggest a naturalistic evaluation (e.g. Venable et al. 2016) of the guidelines, including the collection of empirical evidence from the use of the guidelines. We suggest that the evaluation focuses explicitly on how researchers and practitioners interpret and use the guidelines in practice. We are also welcoming future research about how design principles can deliver more generalisable knowledge that can be used in order to apply them in new settings.

## References

- Baskerville, R., Baiyere, A., Gregor, S., Hevner, A., and Rossi, M. 2018. "Design Science Research Contributions: Finding a Balance between Artifact and Theory", *Journal of the Association for Information Systems*, (19:5), pp 358-376.
- Baskerville, R., and Pries-Heje, J. 2010. "Explanatory design theory", *Business and Information Systems Engineering*, (2:5), pp 271-282.
- Chandra Kruse, L., and Seidel, S. 2017. "Tensions in design principle formulation and reuse". in *Designing the Digital Transformation: DESRIST 2017 Research in Progress Proceedings of the 12th International Conference on Design Science Research in Information Systems and Technology. Karlsruhe, Germany. 30 May-1 June*.
- Chandra, L., Seidel, S., and Gregor, S. 2015. "Prescriptive knowledge in IS research: Conceptualizing design principles in terms of materiality, action, and boundary conditions", in *System Sciences (HICSS), 2015 48th Hawaii International Conference on* (pp 4039-4048). IEEE.
- Cronholm, S., and Bruno, V. 2008. "Do you need general principles or concrete heuristics?: a model for categorizing usability criteria", in *Proceedings of the 20th Australasian Conference on Computer-Human Interaction: Designing for Habitus and Habitat* (pp. 105-111). ACM.
- Göbel, H., and Cronholm, S. 2016. "Nascent design principles enabling digital service platforms", in *Proceedings of International Conference on Design Science Research in Information Systems* (pp. 52-67). Springer, Cham.
- Göbel, H., and Cronholm, S.. 2017. "Guidelines for Service-Dominant Logic: empirical experiences from IT Service Management", in *Proceedings of the 5th Naples Forum on Service*, 6-9 June, Naples.
- Goldkuhl, G. 2004. "Design Theories in Information Systems – A Need for Multi-Grounding", *Journal of Information Technology Theory and Application (JITTA)*, (6:2), pp 59-72.
- Gregor, S., and Hevner, A. R. 2013. "Positioning and presenting design science research for maximum impact", *MIS Quarterly*, (37:2), pp 337-355.
- Gregor, S., and Jones, D. 2007. "The anatomy of a design theory", *Journal of the Association for Information Systems*, (8:5), p 312.
- Heinrich, P., and Schwabe, G. 2014. "Communicating nascent design theories on innovative information systems through multi-grounded design principles", in *International Conference on Design Science Research in Information Systems*, pp 148-163, Springer, Cham.

- Hevner, A.R., and Chatterjee, S. 2010. *Design Research in Information Systems*. Springer, New York.
- Hevner, A. March, S. T., Park, J., and Ram, S. 2004. "Design Science in Information Systems Research". *MIS Quarterly* (28:1), pp 75-105.
- Kolkowska, E., Karlsson, F., and Hedström, K. 2017. "Towards analysing the rationale of information security non-compliance: Devising a Value-Based Compliance analysis method", *The Journal of Strategic Information Systems*, (26:1), pp 39-57.
- Kruse, L. C., Seidel, S., and Purao, S. 2016. "Making Use of Design Principles". In *International Conference on Design Science Research in Information Systems* (pp. 37-51). Springer, Cham.
- Lee, J.K., Cho, D., and Lim, G.G. 2018 "Design and Validation of the Bright Internet", *Journal of the Association for Information Systems*, (19:2), article 3.
- Liu, D., Santhanam, R., and Webster, J. 2017. "Towards meaningful engagement: A framework for design and research of gamified information systems", *MIS Quarterly*, (41:4), pp.1011-1034.
- Lukyanenko, R., Wiersma, Y., Huber, B., Parsons, J., Wachinger, G., and Meldt, R. 2017. "Representing crowd knowledge: Guidelines for conceptual modeling of user-generated content", *Journal of the Association for Information Systems*, (18:4), p.297.
- March S T and Smith G. 1995. "Design and Natural Science Research on Information Technologies", *Decision Support Systems*, (15:4), pp 251-266.
- Markus, M. L., Majchrzak, A., and Gasser, L. 2002. "A design theory for systems that support emergent knowledge processes", *MIS Quarterly*, pp 179-212.
- Orlikowski, W. J., and Iacono, C. S. 2001. "Research commentary: Desperately seeking the "IT" in IT research—A call to theorizing the IT artifact", *Information systems research*, (12:2), pp 121-134.
- Röstlinger A. & Cronholm S. (2009). "Design Criteria for Public e-Services". In proceedings of the 17th *European Conference on Information Systems (ECIS)*. June 8-10, Verona, Italy.
- Seidel, S., and Watson, R.T., 2014. "Improving the Societal Effectiveness of IS Research: The Pursuit of Prescriptive Accuracy", [https://papers.ssrn.com/sol3/papers.cfm?abstract\\_id=2477917](https://papers.ssrn.com/sol3/papers.cfm?abstract_id=2477917). Retrieved 14 Jun 2018.
- Sein, M.K., Henfridsson, O., Purao, S., Rossi, M., and Lindgren, R. 2011. "Action Design Research". *MIS Quarterly*, (35:1), pp 37-56
- Seuring, S. and Müller, M. 2008. "From a literature review to a conceptual framework for sustainable supply chain management". *Journal of Cleaner Production*, (16:15), pp 1699-1710.
- Spagnoletti, P., Resca, A., and Lee, G. 2015. "A Design Theory for Digital Platforms Supporting Online Communities". *Journal of Information Technology*, (1-17).
- van Aken, J. 2004, "Management Research Based on the Paradigm of the Design Sciences: The Quest for Field-tested and Grounded Technological Rules", *Journal of Management Studies*, (41:2), pp 219-246.
- Van den Akker, J. 1999. "Principles and methods of development research". *Design approaches and tools in education and training*, pp 1–14. Springer.
- Venable, J., and Baskerville, R. (2012). "Eating Our Own Cooking: Toward a More Rigorous Design Science of Research Methods", *Electronic Journal of Business Research Methods*, (10:2), pp 141-153.
- Venable, J., Pries-Heje, J., and Baskerville, R. (2016). "FEDS: a framework for evaluation in design science research", *European Journal of Information Systems*, (25:1), pp 77-89.
- Walls, J.G., Widmeyer, G.R., and El Sawy, O.A. 1992. "Building an Information Systems Design Theory for Vigilant EIS", *Information Systems Research* (3:1), pp. 36-59.
- Walsham, G. 1995. "Interpretive case studies in IS research: Nature and method", *European Journal of Information Systems*, (4:2), pp 74-81.
- Webster, J., and Watson, R. T. 2002. "Analyzing the past to prepare for the future: Writing a literature review", *MIS Quarterly*, (26:2), pp. xiii-xxiii.

# Visualizing Business Ecosystems: Applying a Collaborative Modelling Process in Two Case Studies

## Anne Faber

Department of Informatics  
Technical University of Munich  
Garching bei München, Deutschland  
Email: [anne.faber@tum.de](mailto:anne.faber@tum.de)

## Adrian Hernandez-Mendez

Department of Informatics  
Technical University of Munich  
Garching bei München, Deutschland  
Email: [adrian.hernandez@tum.de](mailto:adrian.hernandez@tum.de)

## Sven-Volker Rehm

EM Strasbourg Business School, HuManiS (EA 7308)  
Université de Strasbourg  
Strasbourg Cédex, France  
Email: [sven.rehm@em-strasbourg.eu](mailto:sven.rehm@em-strasbourg.eu)

## Florian Matthes

Department of Informatics  
Technical University of Munich  
Garching bei München, Deutschland  
Email: [matthes@tum.de](mailto:matthes@tum.de)

## Abstract

Business ecosystems are increasingly gaining relevance in research and practice. Because business ecosystems progressively change, enterprises are interested in analysing their ecosystem, to identify and address such changes. In order to gain a comprehensive picture of the business ecosystem, various stakeholders of the enterprise should be involved in the analysis process. We propose a collaborative approach to model and visualize the business ecosystem and we validate four central roles in the modelling process. The process consists of six steps, namely the definition of the business ecosystem focus, instantiation of the model, data collection, provision of tailored visualizations, collecting feedback and adapting the models, and using the visualization ‘to tell a story’. In this paper, we report case studies of two companies that have instantiated ecosystem models.

**Keywords** Business Ecosystem, Collaborative Modelling, Visualization, Case Studies, Lessons Learned.

## 1 Introduction

Undoubtedly, companies increasingly recognize the relevance of their complex business environment in which they develop, produce and distribute their services and products. This environment is often referred to as business ecosystem. Addressing the associated challenges and opportunities is a reality for most companies (Peltoniemi and Vuori 2004). The growing relevance of business ecosystems substantiates through the perceived shift of the competitive environment from single companies and their supply chains towards ecosystems competing against each other (Bosch 2016).

Thereby, a business ecosystem extends the classic supply chain, consisting of suppliers and customer, by also including other entities within the business environment of the enterprise. We define business ecosystems as the holistic environment of a company covering current and potential future business partners, customers, suppliers, competitors, regulatory institutions, and innovative start-ups. It exhibits a high dynamic as continuously entities enter and leave the ecosystem. Peltoniemi and Vuori (2004) provide a comprehensive definition of business ecosystems. Analogously to the metaphor of a biological ecosystem, which served as a basis for the initial definition of business ecosystems (Moore 1997), the economic success of an enterprise can therefore depend on the health and ability to evolve their business ecosystem. The role of the enterprise within its ecosystem can range from a keystone to a niche player, with varying level of influence on the overall health of the ecosystem (Iansiti and Levien 2004).

Due to the influence on the economic success of the enterprise and the dynamic characteristics, enterprises increasingly realize the need to analyse their business ecosystem continuously, in order to identify and address changes within their ecosystem (Basole et al. 2016), adapt own business activities accordingly and to “learn what makes the environment tick” (Porter 1979).

Visualizations of business ecosystems have proven to support decision makers in their ecosystem related tasks (Basole et al. 2016; Huhtamaki and Rubens 2016, Evans and Basole 2016). Visualizing data can help to derive value from ecosystem data, e.g., in order to spot anomalies, identify keystone and niche players of the ecosystem, or recognize change patterns and trends (Vartak et al. 2016).

Ecosystem data is large and heterogeneous (Basole et al. 2015), ranging from technology-related data about applied standards and platforms to use, to market information and legal regulations. When focusing on business aspects of the company's business ecosystem, information about business partners, competitors, interesting start-ups and their strategies, partnerships and offered solutions, and cooperative initiatives become relevant (Faber et al. 2018). Data comprising this information can come from various sources, such as existing databases, newspaper articles or blogs addressing recent developments within the ecosystem, but also company and institutional web presences and publications. The issues associated to data collection in emergent business ecosystems are not yet resolved (Iyer and Basole 2016; Hao et al. 2015) which poses particular challenges for utilizing visualizations for ecosystem analysis or business development (Rehm et al. 2017).

In addition, not only various data sources but also stakeholders of several business units within the enterprise should be included in the business ecosystem analysis to involve diverse aspects and perspectives of the ecosystem. *Collaborative modelling* provides an approach to include a group of stakeholders into shared model creation and evaluation to improve the outcome of their cooperation (Dollmann et al. 2011). We thus aim at providing a collaborative approach to model and visualize business ecosystems from a company internal perspective. Thereby, we address the following research question:

*What are the challenges in collaborative approaches for modelling and visualizing business ecosystems and how does a model-driven approach address these challenges?*

Our contributions in this paper involve the description of 1) a process to initiate the modelling of business ecosystems, 2) important roles during the modelling process, and 3) lessons learned from two action research case studies we conducted with two companies targeting different business ecosystems.

The paper is structured as follows; in Section 2 we introduce related work of business ecosystem modelling, visualization and collaborative modelling targeting business ecosystems; in Section 3 the research methodology is described; this is followed by a description of the framework we used in both studies (Section 4). In Section 5, we present the two case studies in detail; and we summarize the lessons learned in Section 6. Finally, we provide a short discussion and an outlook (Section 7).

## 2 Related Work

**Business Ecosystem Modelling.** Since the introduction of business ecosystems by James Moore in the mid-1990s, who defined it as a collection of interacting companies (Moore 1997), the concept has been widely studied and used in Management Science (Guittard et al. 2015). The initial definition was enriched describing the role of companies as “suppliers, distributors, outsourcing firms, makers of related products or services, technology providers, and a host of other organizations” (Iansiti and Levien 2004), all affecting business success and failure of companies active within the business ecosystem. Furthermore, business ecosystems constantly evolve, exhibiting a dynamic structure (Peltoniemi and Vuori 2004), with not only companies but also human actors, entering and leaving the ecosystem, which “are interconnected through a complex, global network of relationships” (Basole et al. 2015).

The Internet of Things (IoT) business ecosystem modelling gained researchers’ attention, addressing business ecosystem design methods (Uchihira et al. 2016), presenting a framework to fully understand the complex IoT ecosystem. Current approaches further focus on frameworks to grasp the scope of ecosystem complexity (Iyer and Basole 2016), on visualizations to understand emerging structures and patterns (Iyer and Basole 2016; Leonardi 2011), or on policy contexts, e.g., smart city (Visnjic et al. 2016).

Recently, Sako (2018) defined three meta-characteristics of business ecosystems, sustainability, self-governance, and evolution, to contribute to a better distinction of the ecosystem concept from clusters or networks. Thereby, he focuses on “value-creating process (...) rather than an industrial sector”.

**Business Ecosystem Visualization.** Visualizations of business ecosystems have proven to enable ecosystem stakeholders to take better-informed decisions (Basole et al. 2016; Huhtamaki and Rubens 2016; Evans and Basole 2016). Research addressing ecosystem visualizations has used data sets collected from commercial databases on business and economic data or drawn from social or business media (Basole et al. 2012; Basole et al. 2015).

Similar to the framework we used in our studies, Park et al. (2016) present a visual analytic system for analysis of a supply chain management ecosystem. The authors identify three salient design requirements: (1) to support multiple views in an integrated interface, (2) to enable interactive investigation of supply networks, and (3) to provide data-driven analytic capabilities. System users are enabled to interactively explore the ecosystem model using multiple views, all integrated in one user interface. In addition, data-driven analytics are provided. The system introduces five network layouts, which are force-directed, circular or chord diagram, tree map, matrix, and substrate-based layout. Thereby, all visualizations provide interactive features, such as clicking, dragging, hovering, and filtering. This work is based on extensive research in the area of modelling, visualizing and analyzing of business ecosystems (Basole et al. 2015; Park et al. 2016; Park and Basole 2016; Basole 2009a; Basole 2009b; Visnjic et al. 2016).

**Collaborative Modelling of Business Ecosystems.** Although collaborative modelling originated in the 70's and has since increasingly gained relevance together with the increased need for collaboration amongst experts (Renger et al. 2008). Collaborative modelling has been applied to various research fields, such as business process modelling (Dollmann et al. 2011), enterprise architecture modelling (Roth et al. 2013), or group decision support system modelling (Liu and Zhang 2010), to name just a few. However, extant literature does not suggest *collaborative* processes that specifically address business ecosystem modelling and the instantiation of such models.

Roles essential for collaborative modelling have been identified as; the facilitator, the modeller, the process coach, the recorder, and the gatekeeper (Richardson and Andersen 1995), whereby these roles can be allocated to different persons – or several roles can be assigned to the same person (Renger et al. 2008). Richardson and Anderson (1995) describe the roles as, (a) *facilitator*, monitoring the group process and stimulating the model building effort; (b) *modeller*, focusing on the model outcome; (c) *process coach*, observing the process and the dynamics of the participants; (d) *recorder*, documenting the modelling process; and (e) *gatekeeper*, responsible for the process and major decision maker.

## 3 Research Methodology

We present results from two action research case studies with two different organizations. The work is part of a larger design science project, which we refer to as the *Business Ecosystem Explorer (BEE)* and which is explained briefly in Section 4. In this design science project, we develop a tool to



collaboratively model and visualize business ecosystems. The two action research case studies serve as evaluation studies for BEE<sub>x</sub> as design artefact.

We draw on the steps suggested by Yin (1994) for case study design and performed our study in seven consequent steps as illustrated in Figure 1. In this Section, we justify the design of our study and describe how it was followed to investigate a collaborative approach to model and visualize business ecosystems in two enterprise settings.

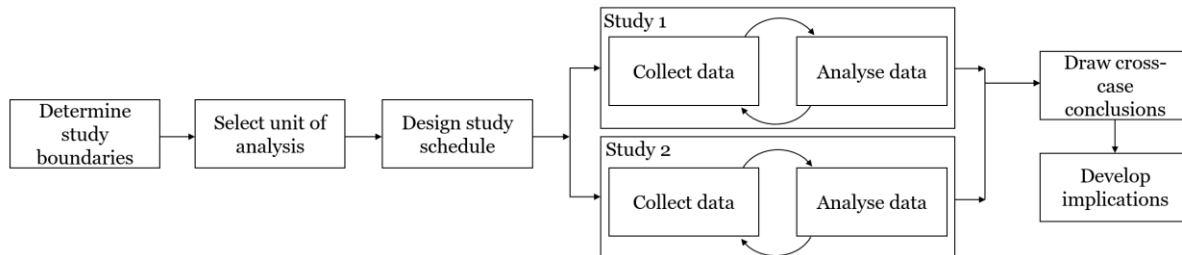

Figure 1: Multiple-case studies design steps (adapted from Yin (1994))

**Determine Study Boundaries.** Due to the lack of existing research and reports about a collaborative approach to model and visualize business ecosystems, in our studies we focus on the instantiation of such a process. We identified two companies, both with no business ecosystem model in place and interested in analysing a specific ecosystem.

**Unit of Analysis.** In the here presented work, we present results from two action research case studies. One organization is an automotive company, headquartered in Europe with approximately 120,000 employees. The other organization is a publishing company, headquartered in Europe with approximately 16,000 employees. Both organizations had a high interest in modelling and visualizing business ecosystems of their specific focus, one related to smart cities and the other to service and person landscape within their business area. For both, the ecosystem of focus was not yet modelled or visualized.

**Design Study Schedule.** With both organizations, several workshops were conducted in the period December 2017 to June 2018. For both studies, discussions about the study scheduled happened prior to the study period. In addition, previous work of the researchers was presented and discussed in advance of the study. We scheduled the workshops and meetings with the studies on an ad-hoc basis.

**Data Collection.** We follow Benbasat et al. (1987) to collect data through a) documentation, b) archival records, and c) direct observation. All involved stakeholders had access to the provided framework BEE<sub>x</sub> (see Section 4) and used it to model their business ecosystem of focus. Thus, we were able to observe documentation during the entire study period. Both companies provided the researchers access to existing company material, which contributed to a shared understanding of the addressed business ecosystems and were used as data sources. Finally, we conducted several workshops in both studies with a high degree of interaction and made direct observations. Each workshop was documented in form of a report, which was validated with company representatives.

**Data Analysis.** The study aims at identifying how the ecosystem data model and ecosystem view model were instantiated and how they evolved following a collaborative modelling approach. After each workshop session, the direct observation records were analysed and the model created or adapted within this session. For both studies final workshops with a larger group of stakeholders – including for both the respective gatekeeper – were conducted in which both the status-quo of the created model and resulting visualization were used to gain insights on the business ecosystems. The final two process steps – cross-contextual conclusion and implications – are included in the following sections.

## 4 Business Ecosystem Explorer (BEE<sub>x</sub>)

In the following, we describe the developed framework to collaboratively model and then visualize business ecosystems.

**The Hybrid Wiki Approach to Collaborative Work.** To address the dynamic structure of business ecosystems, we design an agile framework for modelling ecosystems as integrated, adaptive collaborative work system supporting the evolution of both the model and its instances at runtime by stakeholders and ecosystem experts (i.e., users without programming knowledge or skills). This framework rests on the Hybrid Wiki approach as presented in (Reschenhofer et al. 2016) that serves as

Knowledge Management System application development platform and contains features for data management as well as collaboration and decision support. All changes can be traced back to the user responsible for the changes, including the time of the change. To create the business ecosystem model we use the Hybrid Wiki metamodel.

The Hybrid Wiki metamodel contains the following model building blocks: Workspace, Entity, EntityType, Attribute, and AttributeDefinition. These concepts structure the model inside a Workspace and capture its current snapshot in a data-driven process (i.e., bottom-up process). An Entity contains a collection of Attributes, and the Attributes are stored as a key-value pair. The Attributes have a name and can store multiple values of different types, for example, strings or references to other Entities. The user can create an Attribute at run-time to capture structured information about an Entity. An EntityType allows users to refer to a collection of similar Entities, e.g., organizations, persons. The EntityType consists of multiple AttributeDefinitions, which in turn contain multiple validators such as multiplicity validator, string value validator, and link value validator. Additionally, an Attribute and its values can be associated with validators for maintaining integrity constraints.

**Business Ecosystem Explorer Model.** The agile framework relies on a) ecosystem data model, and b) ecosystem view model, each with respective features for creation and adaption. Both models are encoded using the Hybrid Wiki metamodel.

The ecosystem data model contains the EntityTypes of relevance for the business ecosystem in focus. The view model is encoded as one EntityType called visualizations. Each visualization has two elements: the first element is the link between the data model and the visualizations. The second element is the specification of the visualizations using a declarative language. The proposed approach provides the feature of adapting the models at runtime. In case of changes in the data model, such as adding a category of entities, changing or deleting existing categories, the visualizations are updated at runtime.

**Business Ecosystem Explorer Views.** The agile framework – used as a basis for the studies – currently consists of six views; a landing page, a list of all entities, detail view with company information, a relation view, a visualization overview, and several visualizations. For all views, a menu bar at the top of the page provides links to the other views available.

Within the studies, the framework was used to discuss the initial idea of business ecosystem modelling and visualization. At a later stage of the study, stakeholders of both enterprises used the framework to create their own workspace and selected appropriate visualizations.

## 5 Case Studies: Collaborative Business Ecosystem Modelling

For both studies we followed the approach to initiate modelling and visualizing of business ecosystems as illustrated in Figure 2. The process consists of overall six steps.

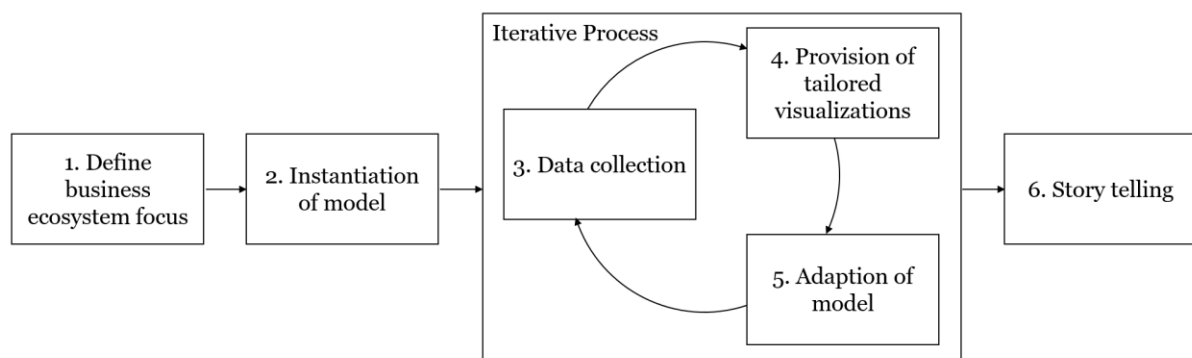

Figure 2: Approach to collaborative ecosystem modelling (adapted from Basole et al. (2016))

In the first step, the business ecosystem focus is defined. Examples for a business ecosystem focus are ecosystems established all around a technology platform, an ecosystem of a specific market exploiting specific digital technologies (Sako 2018) or ecosystems around one focal firm.

In the second step, initial models are created for both the data and the view model. Within the data model instantiation, the relevant entities of the ecosystem are defined, including attributes describing them. In addition, relation types between identified entities are preliminarily set. For the view model, the type of visualization including the specifications for this visualization are established. The requirements for both models should be collected – even in the instantiation phase of the models – by several stakeholders to ensure tailored visualizations in a later phase of the process.

Third, a process consisting of the data collection step, to gather data about the ecosystem according to the specified data model, the provision of tailored visualization according to the view model and the adaption steps in which both models are modified using feedback collected from involved stakeholders. This three-step process is conducted iteratively until the collected data and the tailored visualization fulfil the stakeholders' requirements and needs.

In the final process step, the created visualizations are used to extract knowledge about the ecosystem, which contributes to a better understanding of the ecosystem in focus.

We used the *BEE*x framework to instantiate the business ecosystem model for both studies. That is why for both studies prior to the actual modelling workshops, a dedicated workshop to explain the *BEE*x framework was conducted, explaining the concept of data and view model and the adaption in run-time. Within these workshops, the aims for both studies were set: Achieving an instance of the business ecosystem model of focus and using the framework to initiate the management of the model evolution by following the process described in Figure 2.

As our focus was on the initiation of the company-internal business ecosystem modelling and visualization, the iteration of process steps three to five was only conducted a limited number of times for both studies.

Through the usage of the Knowledge Management System, we were able to identify the contributions of different involved stakeholders both during the workshops through observations but also using the provided collaboration feature. In the beginning of the studies, each stakeholder received a dedicated user identity. Thereby, in case of changes of the models in between workshops, these were transparent to the researchers.

During the studies, we identified roles of the group model building, which were involved in different process steps. Here we report about the process applied, the roles identified and their influence in the modelling results.

## 5.1 Study 1: Innovative Mobility Services Business Ecosystem

The first study together with an automotive company took place over five months (December 2017 to April 2018). Within the entire study time, overall five representatives were involved, whereby two of these five were active in the modelling workshop. The three other stakeholder were included in major decisions. The action research consists of 11 workshops each lasting between 60 and 120 minutes. All workshops happened on the enterprise premise using laptops, a whiteboard and pen and paper.

**Course of the Study.** The definition of the business ecosystem focus was set prior to the first modelling workshop of the study happening after the organizational workshop. Purpose of this study was to model and visualize the business ecosystem of innovative mobility services. Of interest, a better understanding about which cities are providing innovative mobility services within their mobility offer landscape and which service might be relevant for a city allocating currently less mobility services. Also of interest was a better understanding of which service provider offers which mobility services and how well each service provider is interconnected with which city. Thereby, the business ecosystem of focus was superficially analysed prior to the conduction of the study. Information about the business ecosystem was collected by several company's stakeholders and documented in an unstructured form. The information was not processed any further, a tracking about who included which information and who accessed it in a later stage was not conducted, and no visualization was used.

Within the first three modelling sessions (December and January), the initial data model was created. As the Knowledge Management System within the *BEE*x framework provides the feature of supporting the evolution of models, the data model was in the following continuously updated and adapted.

In the following two months, the two company representatives implemented the already within the company collected data in the system and enriched it with additional data. Therefore, company external data sources such as newspaper articles, news feeds and free of charge online databases were used. The data collection process was conducted manually by enterprise representatives and not supported by the researchers. During this phase, four modelling workshops were conducted. Within these workshops, the involved researchers answered question about the usage of the Knowledge Management System. In addition, inconsistencies of the model were addressed and solved.

Simultaneously in three workshops in February and March, the view model was created and the initial visualization type defined: a force-layout view. This decision happened after two months of business ecosystem data modelling and data collection. In a dedicated workshop, the building blocks (marks, scales, and signals) of each visualization were discussed and aligned. After this aligned view model, the

researched created the visualizations accordingly. The tailored view were presented and discussed in the following workshops end of March. Collecting the feedback, the visualizations were adapted and further discussed in two workshops in April.

The final workshop happened end of April. Besides the gatekeeper, the two modellers and the two researchers, two additional enterprise stakeholders participated. The results of the previous modelling workshops were presented: Besides the two force layout views displayed in Figure 3, a list view of all entities, a detailed view for each entity and one additional force-layout view were presented and discussed. The feedback of the gatekeeper and additional modeller regarding the view model were incorporated immediately.

**Data and View Model.** The Hybrid Wiki metamodel was used to set up the data and view model. After the first data model creation workshop, the data model consisted of six EntityTypes and eight AttributeDefinitions. In the following session, the data model grew to finally eight EntityTypes and 26 AttributeDefinitions, a greater increase on the attribute level than on the entity level. As entities of the ecosystem, cities, organizations (e.g., services providers such as automotive OEMs), mobility services and mobility related projects were modelled. For example, the services comprised car sharing, bike sharing, ride sharing, to name just a few.

As described in Section 4, the view model consisted of the three entities describing the three force layouts. Two of the three views as visualized in Figure 3.

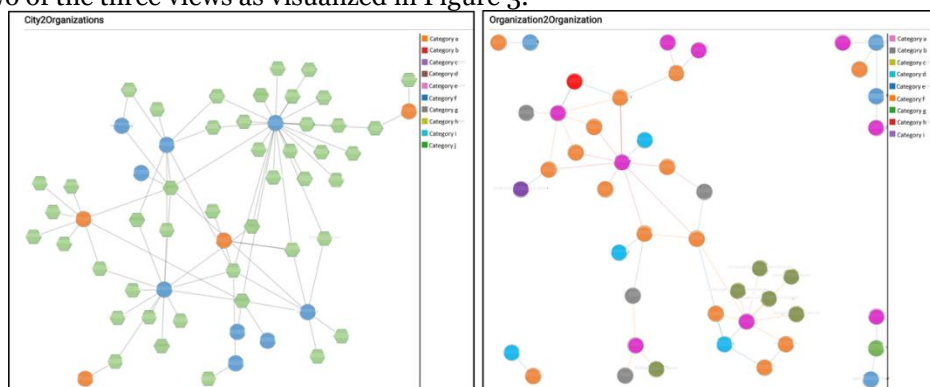

Figure 3: Two visualization created in the first study. Due to anonymization requirements, the entity names and categories are blurred.

**Roles of the Collaborative Process.** We validated four roles in this study: facilitator, modeller, recorder and gatekeeper. The gatekeeper was the most prominent participant in the beginning of the study. She decided on the business ecosystem focus and assigned stakeholders to participate in the modelling sessions. Within the second process step, one company representative established herself as the facilitator. She paid constant attention to the group process. She also took the lead in organizing all following modelling sessions. The facilitator was also the leading contributor in implementing existing data, enriching it with external data sources and thereby acting as a modeller especially between workshops. During this final workshop, she again took the lead explaining the results and the outcome.

The researchers present in the workshops fulfilled both the modeller and recorder role by documenting each workshop in form of a written report.

## 5.2 Study 2: Publishing Company Business Ecosystem

The second study was conducted with a publishing company. The study took place over six months (February to July). Overall, six enterprise representatives participated in the study in seven workshops each lasting between 90 and 120 minutes. All seven workshops took place on the enterprise premise using laptops, a whiteboard and pen and paper.

**Course of the Study.** Within the first workshop in February, the focus of the business ecosystem was set: German publishing business ecosystem with regard to key persons, publishing landscape and the services offered and consumed. Besides identifying the ecosystem focus, previous activities and relevant additional stakeholder to involve were discussed. Information of the ecosystem in focus had yet not been analysed and the ecosystem not yet modelled. A group of potential relevant stakeholder to contribute to the modelling process were identified.

In the next two workshops, the data model was aligned. The second workshop thereby contributed to enrichment of the data model, focusing on attributes for each ecosystem entity.

In a workshop in April, the view model including the building blocks was discussed and aligned.

For the next two workshops in May, two visualizations were provided by the researchers using the data implemented in the Knowledge Management System. Thereby, both company internal data sources but also news articles were used.

After adapting the models according to the discussion, in an additional workshop in May three further company representatives were invited to discuss the initially now available tailored instance of the *BEE*x framework. The visualizations are displayed in Figure 4. In addition to these two visualizations, a customized landing page was created.

**Data and View Model.** Within the study both the data and view model according to the previous described Hybrid Wiki metamodel were created. After the first data model creation workshop, three EntityTypes with seven AttributeDefinitions were defined. At the end of the study, the final data model consisted of nine EntityTypes. These EntityTypes included 24 AttributeDefinitions. The data model evolved during the modelling process, especially on the attribute level and during the initial phase of the project. For the data model, ecosystem entities such as key persons, publisher, and publishing groups were identified, including relation types such as role of the person within the ecosystem and type of service. The view model consisted of the two entities covering the visualizations displayed in Figure 4. After the visualizations were created, the data model on the entity level stayed the same.

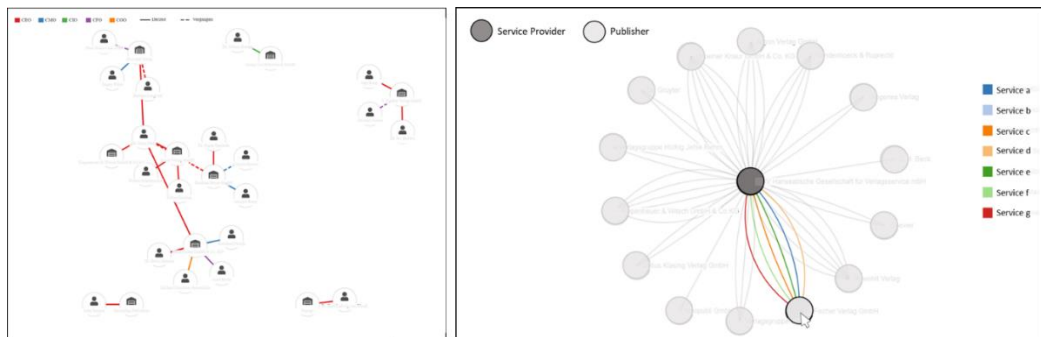

Figure 4: Two visualization created in the second study. Due to anonymization requirements, the entity names and categories are blurred.

**Roles of the Collaborative Process.** Similar to the first study, we could validate four roles in this study: facilitator, modeller, recorder and gatekeeper. Within this study, the composition of the modelling groups changed within the study period. All participants, which actively modelled, participated in the pre-study workshop and thus were familiar with the *BEE*x framework and the study aim. For all workshops, the group consisted of at least three participants.

Already in the first workshop, one of the company's representatives positioned herself as the facilitator. She kept this role over the entire study period and participated in all workshops. The facilitator also actively participated in the modelling as such, but acted as decision maker and discussion leader. One example is the decision to use a force-layout. The gatekeeper only participated twice in workshops in May and thus was identified at a late state of the process. Even though, not included in the previous workshops, her opinion and feedback to the provided and discussed visualizations were high prioritized by the facilitator. The researcher present in the workshops fulfilled the role of the recorder and documented each workshop in form of a written report.

## 6 Cross-case Conclusions: Findings and Lessons Learned

Even though in both studies different topics and ecosystem models have been instantiated, we can draw some cross-case conclusions. Following Patton (2001) who defines lessons learned as the knowledge which is derived from the screening of a situation and which can be applied in similar situations in the future, we will present our finding and lessons learned of both studies.

**Evolution of the Data Model.** We noticed for both case studies, that the data model evolved rather on the AttributeType Level than on the EntityType Level. That means, the entities visualized remained nearly untouched whereby for all entities the attributes changed during the modelling process. In our opinion, this is due to the user being accustomed to the provided visualization and thus is less willing to change it. A change of the attribute, which might also include adding or deleting an attribute, does not

involve changes of the force-layout view. Furthermore, as the attributes can be defined as mandatory attributes or not, the user is free in adding attributes for specific entities that are not available for others.

**Expertise of Modelling Participants.** Comparing both studies we noticed that the existing knowledge of the workshop participants has a great influence in the achieved results. The modellers involved in the first study were less experienced with modelling activities as such. One consequence was more time spent on the data and view model creation and thus receiving the implemented interactive visualizations at a later point within the process. To address this, an additional workshop prior to the study period focussing on how to create a model is recommendable. Our pre-study workshop solely focused on explaining the existing framework and the data and view model in use there but not on active participation of the study participants.

**Maintaining Motivation during Modelling Process.** Especially in the first study we noticed a decrease in motivation during the data and view model creation phase. As described above, the study participants – including the facilitator – were unfamiliar with modelling activities. Thus, reaching the fourth process step took longer than expected by the company representatives. This hold especially true, as the predefined outcome of the study was an instance of the *BEE*x framework including tailored interactive visualizations.

**Importance to Provide Visualizations.** The aforementioned findings led to the conclusion, that the visualizations play a crucial role in the perceived success of the modelling process. We noticed within both studies that as soon as the interactive visualizations were provided with the additional feature of adapting changes to the data model and the data collected in run-time contributed heavily to motivate the participants to collect and implement data.

**Story Telling.** As for both studies the focus was on the instantiation of the ecosystem model, the provided visualizations can be considered as early visualizations of the ecosystems. Within the studies, this process step was rather used to present the results of the study to the gatekeeper.

**Collaborative Modelling.** In both studies, several stakeholders were included in the modelling process. During the workshops, all participants contributed as modellers. Between the workshops, the overall contribution decreased, and only key team members, those we identified as facilitators, continued collecting and implementing data. Changes of the model were only implemented during the workshops, which might be due to the still rather unfamiliar framework in use. We recognized a lively discussion during the workshops, implying the relevance of managing the business ecosystem model in focus.

We identified four clear roles within both studies: The facilitator, the modeller, the recorder and the gatekeeper. As we conducted this process of instantiating a business ecosystem model first time, a process coach was missing.

## 7 Discussion and Conclusion

In this paper, we presented a process to model and visualize business ecosystems from a company internal perspective, which we applied in two company settings. This process supports several stakeholders to collaboratively contribute to the instantiation of a business ecosystem model.

The process consists of six steps, namely, the definition of the business ecosystem in focus, the instantiation of both the data and view model, the collection of relevant data, the provision of tailored visualization, feedback, which is fed into the iteration process of the two previous steps, and finally, the story-telling step. We report in detail about the study development, the involvement of participants and conclude with findings and lessons learned.

A noticeable limitation of the presented work is the usage of only manually implemented data, which is a time-consuming and tedious work. As visualizations are data-driven, the business ecosystem visualizations rely heavily on the availability and quality of data. Complementing the manual data collection with (semi-)automated data extraction process steps, such as provided with Natural Language Processing, could contribute to the availability of data and thus to richer visualization leading to improve possibilities to extract knowledge. For the quality of data, approaches to data governance are missing in the process presented. We envision the facilitator being a good starting point for such a role.

In addition, as this work focuses on the instantiation of an ecosystem modelling, we envision the iterative process steps to be conducted several time in future research. In our view this would lead to data enrichment and potential inclusion of additional stakeholders within the company.

As a major challenge, we realized the right balance between early providing tailored visualizations and following the process. As our focus was to establish a shared language within the modelling process, we first provided visualization after aligning the data and the view model, leading to a motivational decrease during the study. Nevertheless, we believe the presented process can be used as a reference by organizations interested in modelling their business ecosystem.

## 8 References

- Basole, R. C. 2009a. "Structural Analysis and Visualization of Ecosystems : A Study of Mobile Device Platforms," *Proceedings of the Fifteenth Americas Conference on Information Systems San Francisco California*, August, pp 1–10.
- Basole, R. C. 2009b. "Visualization of interfirm relations in a converging mobile ecosystem," *Journal of Information Technology* (24:2), pp 144–159.
- Basole, R. C., Huhtamäki, J., Still, K., and Russell, M. G. 2016. "Visual decision support for business ecosystem analysis," *Expert Systems with Applications*, (65), pp 271–282.
- Basole, R. C., Russell, M. G., Huhtamäki, J., and Rubens, N. 2012. "Understanding Mobile Ecosystem Dynamics: A Data-Driven Approach," *International Conference on Mobile Business*, (15) <http://aisel.aisnet.org/icmb2012/15/> Retrieved: 12 July 2018.
- Basole, R. C., Russell, M. G., Huhtamäki, J., Rubens, N., Still, K., and Park, H. 2015. "Understanding Business Ecosystem Dynamics: A Data-Driven Approach," *ACM Transactions on Management Information Systems* (6:2), June, pp 1–32.
- Bosch, J. 2016 "Speed, Data, and Ecosystems: The Future of Software Engineering," *IEEE Software* (33:1), January, pp 82–88.
- Benbasat, I., Goldstein, D. K., and Mead, M. 1987. "The Case Research Strategy in Studies of Information Systems Case Research," *MIS Quarterly* (11:3), pp 369–386.
- Dollmann, T., Houy, C., Fettke, P., and Loos, P. 2011. "Collaborative business process modeling with CoMoMod: A toolkit for model integration in distributed cooperation environments," *Proceedings of the 20th IEEE International Workshops on Enabling Technologies: Infrastructure for Collaborative Enterprises*, pp 217–222.
- Evans, P. C., and Basole, R. C. 2016. "Revealing the API ecosystem and enterprise strategy via visual analytics," *Communications of the ACM* (59:2), pp 26–28.
- Faber, A., Hernandez-Mendez, A., Rehm, S.-V., and Matthes, F. 2018. "An Agile Framework for Modeling Smart City Business Ecosystems," *Proceedings of the 20th International Conference on Enterprise Information Systems* (2), pp 39–50.
- Guittard, C., Schenk, E., and T. Burger-Helmchen, T. 2015. "Crowdsourcing and the Evolution of a Business Ecosystem," in *Advances in Crowdsourcing*, F. J. Garrigos-Simon, I. and Gil-Pechuàn, and S. and Estelles-Miguel, Eds. Springer International Publishing, pp 49–62.
- Hao, J., Zhu, J., and Zhong, R. 2015. "The rise of big data on urban studies and planning practices in China: Review and open research issues," *Journal of Urban Management* (4:2), pp 92–124.
- Huhtamäki, J., and Rubens, N. 2016. "Exploring innovation ecosystems as networks: Four european cases," *Proceedings of the Annual Hawaii International Conference on System Sciences*, March, pp 4505–4514.
- Iansiti, M., and Levien, R. 2004. "Strategy as Ecology," *Harvard Business Review* (82:3), <https://hbr.org/2004/03/strategy-as-ecology> Retrieved: 12 July 2018.
- Iyer, B. R., and Basole, R. C. 2016. "Visualization to understand ecosystems," *Communications of the ACM* (59:11), pp 27–30.
- Leonardi, P. M. 2011. "When Flexible Routines Meet Flexible Technologies: Affordance, Constraint, and the Imbrication of Human and Material Agencies," *MIS Quarterly* (35:1), pp 147–167.
- Liu, F., and Zhang, C. 2010. "Role-based collaborative model of group decision support system," *Seventh International Conference on Fuzzy Systems and Knowledge Discovery*, pp 1039–1043.
- Moore, J. F. 1996. *The Death of Competition: Leadership and Strategy in the Age of Business Ecosystems*. New York: HarperBusiness.

- Park H., and Basole, R. C. 2016. "Bicentric diagrams: Design and applications of a graph-based relational set visualization technique," *Decision Support Systems* (84), April, pp 64–77.
- Park, H., Bellamy, M. A., and Basole, R. C. 2016. "Visual analytics for supply network management: System design and evaluation," *Decision Support Systems* (91), pp 89–102.
- Patton, M. Q. 2001. "Evaluation, knowledge management, best practices, and high quality lessons learned," *The American Journal of Evaluation* (22:3), pp 329–336.
- Peltoniemi M., and Vuori, E. 2004. "Business ecosystem as the new approach to complex adaptive business environments," *Proceedings of eBusiness Research Forum*, pp 267–281.
- Porter, M. 1979. "How competitive forces shape strategy," *Harvard Business Review*, March, pp 102–117.
- Rehm, S.-V., Faber, A., and Goel, L. 2017. "Visualizing Platform Hubs of Smart City Mobility Business Ecosystems," *Proceedings of the Thirty Eighth Interantional Conference on Information Systems*, pp 1–10.
- Renger, M., Kolfshoten, G. L., and De Vreede, G. J. 2008. "Challenges in collaborative modeling: A literature review," *Lecture Notes in Business Information Processing* (10:10), pp 61–77.
- Reschenhofer, T., Bhat, M., Hernandez-Mendez, A., and Matthes, F. 2016. "Lessons learned in aligning data and model evolution in collaborative information systems," *Proceedings of the 38th International Conference on Software Engineering Companion*, pp 132–141.
- Richardson, G. P., and Andersen, D. F. 1995. "Teamwork in group model building," *System Dynamics Review* (11:2), pp 113–137.
- Roth, S., Hauder, M., and Matthes, F. 2013. "Collaborative evolution of enterprise architecture models," *CEUR Workshop Proceedings* (1079), pp 1–12.
- Sako, M. 2018. "Business Ecosystems: How Do They Matter for Innovation?," *Communications of the ACM* (61:4), March, pp 20–22.
- Uchihira, N., Ishimatsu, H., and Inoue, K. 2016. "IoT service business ecosystem design in a global, competitive, and collaborative environment," *Portland International Conference on Management of Engineering and Technology (PICMET)*, pp 1195–1201.
- Vartak, M., Huang, S., Siddiqui, T., Madden, S., and Parameswaran, A. 2017. "Towards Visualization Recommendation Systems," *ACM SIGMOD Record* (45:4), May, pp 34–39.
- Visnjic, I., Neely, A., Cennamo, C., and Visnjic, N. 2016. "Governing the City," *California Management Review* (59:1), pp 109–140.
- Yin, R. K. 1994. "Case study research: Design and Methods," *Applied social research methods series* (5), Sage Publications, London.

## Acknowledgements

This work has been sponsored by the German Federal Ministry of Education and Research (BMBF) grant BEE+ 01IS17049. This work is further part of the TUM Living Lab Connected Mobility (TUM LLCM) project and has been funded by the Bavarian Ministry of Economic Affairs, Energy and Technology (StMWi) through the Center Digitisation.Bavaria, an initiative of the Bavarian State Government

## Copyright

The following copyright paragraph must be appended to the paper. Author names MUST not be included until after reviewing. Please ensure the hyperlink remains for electronic harvesting of copyright restrictions.

**Copyright:** © 2018 authors. This is an open-access article distributed under the terms of the [Creative Commons Attribution-NonCommercial 3.0 Australia License](https://creativecommons.org/licenses/by-nc/3.0/), which permits non-commercial use, distribution, and reproduction in any medium, provided the original author and ACIS are credited.



# Critical Determinants for Mobile Commerce Adoption in Vietnamese SMEs: A Preliminary Study

**Ngoc Tuan Chau**<sup>1,2</sup>

<sup>1</sup>School of Business IT & Logistics  
RMIT University  
Melbourne, Australia  
Email: tuan.chau@rmit.edu.au

<sup>2</sup>University of Economics, The University of Danang  
Danang city, Vietnam

**Hepu Deng**

School of Business IT & Logistics  
RMIT University  
Melbourne, Australia  
Email: hepu.deng@rmit.edu.au

## Abstract

The critical determinants for e-commerce, e-business, and other enterprise information systems adoption in SMEs have been well-documented. The critical determinants for m-commerce adoption in SMEs, however, are still limited, especially in SMEs in developing countries. This paper develops a measurement instrument for investigating the critical determinants of m-commerce adoption in Vietnamese SMEs. A preliminary study is conducted for confirming the reliability and validity of the instrument based on the data collected from 172 managers of Vietnamese SMEs using an online survey. The Cronbach's alpha and the composite reliability values of the proposed variables strongly support their reliability. The results of the exploratory factor analysis confirm constructs' discriminant validity. The average variance extracted values confirm constructs' convergent validity. This study contributes to the identification of the critical determinants for m-commerce adoption in SMEs. It provides a new conceptual framework for assessing the critical determinants for m-commerce adoption in SMEs in developing countries.

**Keywords** Mobile commerce, critical determinants, adoption, SMEs, Vietnam.

## 1 Introduction

M-commerce is about buying and selling of goods and services through wireless handheld devices such as cellular phones and personal digital assistants (Smith 2006; Njenga, Litondo and Omwansa 2016). It provides organizations with many benefits including improving productivity, increasing customer satisfaction, and lowering operational costs (Varshney and Vetter 2004). As a result, m-commerce is becoming a cost-effective way for businesses to promote their products and services online (Mallat and Tuunainen 2008; Alfahl, Sanzogni and Houghton 2012; Njenga, Litondo and Omwansa 2016).

The popularity of m-commerce leads to its wide adoption in the world. A careful investigation of such adoption reveals that there is a huge difference in the adoption between the developed country and the developing country. While m-commerce has a high level of adoption in developed countries (Mbogo 2010), it has not been popularly adopted in developing countries (Chong 2013; Nafea and Younas 2014).

SMEs can be defined differently across countries with respect to the number of employees, the turnover, and the ownership structure (Poon 2002; Ayyagari, Beck and Kunt 2007). In Vietnam, SMEs are an independent business with the average number of permanent workers not exceeding 300 (Insides 2011). SMEs play an important role in the Vietnamese economy. They account for approximately 98% of the enterprises, contributing more than 40% of national gross domestic products and 30% of total export, and creating more than 500.000 workplaces annually (General Statistics Office of Vietnam 2016).

SMEs are a distinct group of organizations with their specific characteristics (Poon 2002; Ayyagari, Beck and Kunt 2007). These characteristics make them more flexible in adopting technological innovations. The flattened structure of SMEs enables much faster decision making. However, the lack of ICT skills (Barry and Milner 2002; OEDC 2004), the lack of financial resources (Tetteh and Burn 2001; Hamdan et al. 2016), and the dependence on business partners (Stockdale and Standing 2004) often pose numerous challenges for SMEs in their adoption of technological innovations.

The tremendous benefits of m-commerce for SMEs have not been fully utilized in developing countries (Nafea and Younas 2014). In Vietnam, for example, there are about 20% of SMEs that have websites for promoting their business. About 70% of these websites are difficult to access by mobile devices (VECITA 2017). This is because the adoption of m-commerce is a complex process (Stoica, Miller and Stotlar 2005). There are many factors such as individual attributes (Njenga, Litondo and Omwansa 2016), technological, organizational, and environmental aspects (Alfahl, Sanzogni and Houghton 2012; Njenga, Litondo and Omwansa 2016), and trust (Rahman 2013) which directly affect the adoption of organizational m-commerce. To have a successful adoption, an investigation of the critical determinants for m-commerce adoption in Vietnamese SMEs is significant. This paper conducts a preliminary study on the critical determinants for m-commerce adoption in Vietnamese SMEs by answering the following research question:

*Which critical determinants can be included for investigating the critical determinants for m-commerce adoption in Vietnamese SMEs?*

## 2 Literature Review

The lack of research in identifying the critical determinants for m-commerce adoption in organizations has attracted much attention in existing literature. There are several important attempts at developing various measurement models from different perspectives for identifying the critical determinants of adopting m-commerce in organizations. These studies can be categorized into the conceptualization of m-commerce adoption and the empirical validation of such conceptualization.

The conceptualization of m-commerce adoption focuses on the proposition of various conceptual frameworks for better understanding the adoption of m-commerce in organizations. Stoica, Miller and Stotlar (2005), for example, conceptualize a comprehensive framework consisting of organizational structure, business strategy, organizational culture, and environment for m-commerce adoption. Alfahl, Sanzogni and Houghton (2012) develop a framework related to technological factors, environmental & organizational factors, and policy & legal environment factors for m-commerce adoption. Njenga, Litondo and Omwansa (2016) present an integrated framework for m-commerce adoption consisting of organizational attributes and individual attributes. Alqatan et al. (2017) present a conceptual framework consisting of perceived usefulness, perceived ease of use, and the fit between mobile technologies and tasks for investigating the acceptance of m-commerce in tourism SMEs.

These studies propose various conceptual models for organizational m-commerce adoption. They, however, lack empirical evidences for the generalizability of the findings for the organizational m-commerce adoption.

Several studies empirically investigate the critical determinants for the adoption of m-commerce in organizations. Such studies employ various theories such as the technology acceptance model (TAM), the diffusion of innovation theory (DOI), and the technology-organization-environment (TOE) framework for investigating the adoption of m-commerce in organizations, leading to the identification of different critical determinants. The use of TAM, for example, assumes that the intention of an organization in adopting m-commerce is influenced by the perceived usefulness and the perceived ease of use. Snowden et al. (2006), for example, extend TAM for investigating the critical factors affecting the adoption of mobile technologies, leading to the identification of the critical determinants including the usefulness and ease of use of mobile technologies, the technology complexity, individual differences, facilitating conditions, social influences, and wireless trust environment. Shih et al. (2010) extend TAM to study m-commerce adoption in real estate organizations. The results show that perceived usefulness, perceived ease of use, and the tool experience are critical for the adoption of m-commerce. Mashagba, Mashagba and Nassar (2013) extend TAM for investigating the technological factors affecting m-commerce adoption in Jordan, leading to the confirmation of the critical determinants including perceived usefulness, perceived ease of use, IT trust, level of e-commerce adoption, security, and IT infrastructure.

The use of DOI in organizational m-commerce adoption studies assumes that the adoption of m-commerce in organizations is determined by relative advantage, compatibility, complexity, trialability, and complexity. Al-Qirim (2006), for example, employs DOI for investigating the adoption of mobile technologies in SMEs in New Zealand, leading to the confirmation of five critical determinants including relative advantage, compatibility, complexity, cost, and support from technology vendors.

The adoption of TOE for exploring the m-commerce adoption in organizations states that there are three main aspects of an organization that influence the adoption of m-commerce, namely technology, organization, and environment. Doolin and Ali (2008), for example, employ TOE for investigating the critical determinants for the adoption of mobile technologies in business in New Zealand, leading to the confirmation of the critical determinants including relative advantage, compatibility, top management support, information intensity, the degree of organizational readiness, competitive intensity and partner influence. Jain et al. (2011) employ TOE to explore the factors favouring m-commerce adoption in Indian micro, small and medium-sized enterprises. Their empirical results indicate that IS infrastructure, relative advantage, complexity, trialability, firm size, financial commitment, IS expertise, trading partner readiness, external IS support are the critical determinants for the adoption of m-commerce. Lu et al. (2015) adopt TOE for evaluating the critical factors affecting the decision to implement m-commerce in SMEs in Taiwan, leading to the identification of nine critical determinants including data security, network reliability, technology complexity, top management emphasis, employees' IS knowledge, firm size, competitive pressure, partner support, and regulatory support. Martin and Jimenez (2015) employ TOE to investigate the adoption of m-commerce in Spanish firms, leading to the identification of various critical determinants including motivation, perceived benefits, managers' and employees' support, impediments to implement, perceived customer value, competitive pressure, and the propensity to innovation and ICT.

An integration of several theories is commonly used for better understanding m-commerce adoption in organizations. Martin, Catalan and Jeronimo (2012), for example, integrate TOE and a relational context (Dyer and Singh 1998) to identify the critical factors for the adoption of m-commerce. Picoto, Belanger and Palma-dos-Reis (2014) combine TOE with DOI and the resource-based theory to investigate the use of mobile business. Alrawabdeh (2014) combines TAM with DOI and the theory of reasoned action to investigate the environmental factors affecting m-commerce adoption in telecommunication firms in Jordan. Otieno and Kahonge (2014) integrate TOE with DOI for investigating the adoption of mobile payment in Kenyan SMEs. Grandhi and Wibowo (2016) integrate TAM with DOI to examine the organizational factors affecting m-commerce adoption in Organizations in North America. Amegbe, Hanu and Nuwasiima (2017) combine TAM and DOI for investigating the use of mobile money and m-commerce. Alfahl, Houghton and Sanzogni (2017) integrated TOE with TAM, DOI, TRA, and TPB for exploring m-commerce adoption in Saudi organizations. These studies employ various theories as a theoretical basis for better understanding m-commerce adoption, leading to the confirmation of different determinants for m-commerce adoption in organizations.

The models above, however, have some limitations for adequately identifying the critical determinants for m-commerce adoption in SMEs in developing countries. First, they do not have a general

agreement on the critical determinants for m-commerce adoption in organizations. Second, they lack consideration of the unique characteristics of SMEs in the adoption of m-commerce. Furthermore, they have not considered the characteristics of developing countries in the adoption of new technologies. As a result, there is a necessity to develop and empirically validate a comprehensive measurement model for identifying the critical determinants for m-commerce adoption in Vietnamese SMEs – an example of SMEs in the context of developing countries.

### 3 A Conceptual Framework

The analysis of existing studies above shows that DOI and TOE are the dominant theories for investigating the critical determinants for the adoption of m-commerce in organizations. DOI is a process-based framework for explaining how, why, and at what rate the technology is adopted (Rogers 2010). It has become the most influential theory in adoption studies. As a result, the DOI theory is widely used as a theoretical basis in many empirical studies for identifying the critical determinants of technology adoption in SMEs (Seyal, Rahman and Mohammad 2007; Alam et al. 2008).

TOE is an organization-level theory of technology adoption that describes how the firm context influences the adoption of technological innovations (Baker 2012). It provides a solid theoretical basis for identifying the critical determinants of technology adoption in organizations (Oliveira and Martins 2010). As a result, it is widely employed in many adoption studies (Duan, Deng and Corbit 2010, 2012; Huy et al. 2012; Imre 2016).

Figure. 1 presents a conceptual framework for investigating the critical determinants of m-commerce adoption in Vietnamese SMEs. Such a framework integrates two most popular theories in technology adoption in organizations including DOI and TOE. This is because DOI and TOE are the most suitable theories for investigating the critical determinants for the adoption of m-commerce in organizations.

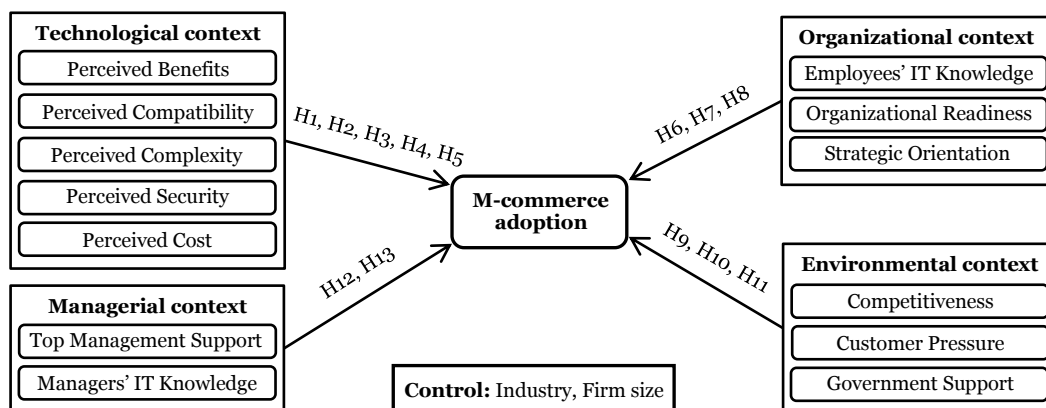

Figure 1: The conceptual framework

The proposed framework conceptualizes that factors affecting the adoption of m-commerce can be categorized into technological context, organizational context, environmental context, and managerial context. The perceived cost and perceived security are included for extending DOI, and the managerial context is added for extending TOE for having a comprehensive framework for a more robust explanation on the adoption of m-commerce in SMEs in the context of Vietnam.

The technological context is related to the characteristics of the technology (Rogers 2010). It represents the technologies available for the adoption of m-commerce (Lu et al. 2015). A review of the related literature shows that perceived benefits, perceived compatibility, and perceived complexity are the most important factors affecting m-commerce adoption in organizations. Additionally, the perceived cost and perceived security are included in the technological context for extending DOI for the context of Vietnamese SMEs. As a result, five following hypotheses are proposed:

*H1: The perceived benefits are critical for the decision to adopt m-commerce*

*H2: The perceived compatibility is critical for the decision to adopt m-commerce*

*H3: The perceived complexity is critical for the decision to adopt m-commerce*

*H4: The perceived security is critical for the decision to adopt m-commerce*

*H5: The perceived cost is critical for the decision to adopt m-commerce*

The organizational context is related to the characteristics of an organization in the adoption of innovation. It represents internal factors for the adoption of innovations (Lippert and Govindarajulu 2006). A review of the related literature shows that the most important organizational factors are employees' IT knowledge, organizational readiness, and strategic orientation. As a result, three following hypotheses are proposed:

*H6: Employees' IT knowledge is critical for the decision to adopt m-commerce*

*H7: The organizational readiness is critical for the decision to adopt m-commerce*

*H8: A firm' strategic orientation is critical for the decision to adopt m-commerce*

The environmental context constitutes the arena in which adopting organizations conduct their business (Depietro, Wiarda and Fleischer 1990). The literature review leads to the identification of several environmental factors including competitive pressure, customer pressure, and government support for m-commerce adoption (Vaithianathan 2010). As a result, three hypotheses are proposed:

*H9: The perception of competitive pressure is critical for the decision to adopt m-commerce*

*H10: The perception of customer pressure is critical for the decision to adopt m-commerce*

*H11: The perception of government support is critical for the decision to adopt m-commerce*

The managerial context is related to the characteristics of the manager of SMEs in technology adoption. Such characteristics are critical for adopting innovations. Rogers (2010) argues that innovation adoption is significantly correlated with the innovation-decision process, in particular, the attitude of managers. These lead to the proposition of the two following hypotheses:

*H12: Top management support is critical for the decision to adopt m-commerce*

*H13: Managers' IT knowledge is critical for the decision to adopt m-commerce*

## **4 Research Method**

A quantitative study was conducted using an online survey with a questionnaire. The target population is SMEs in Vietnam. The sampling frame was obtained from the Vietnam Association of Small and Medium Enterprises (VINASME) website using the probability sampling method. The sampling frame is the owners and managers of Vietnamese SMEs.

The questionnaire includes closed-ended questions and consists of three parts: the demographic questions about the SMEs and respondents, questions about the current patterns of the adoption of m-commerce in Vietnamese SMEs, and questions for assessing the determinants for m-commerce adoption in Vietnamese SMEs. The questionnaire was delivered online with the support from VINASME from April 2018 to June 2018. One-hundred and seventy-eight surveys were received and processed with data screening. This process excludes six surveys with many unfinished questions, resulting in one-hundred and seventy-two valid surveys for the statistical analysis using SPSS 25.0.

## **5 Preliminary Data Analysis**

### **5.1 Respondent Profile**

Table 1 presents a summary of the demographic data. With respect to the location of SMEs, 44.2% of SMEs are in North Vietnam, 40.1% of SMEs are in the Central and Highland Vietnam, and 15.7% of SMEs are located in South Vietnam. Regarding the duration of business, most SMEs have been running their businesses for more than 15 years (47.7%), 21.5% of SMEs have been running their businesses for less than 5 years, 18% between 5 to 10 years, and 12.8% between 10 to 15 years. With respect to the size of the enterprise, 26.2% of SMEs are very small enterprises with less than 10 employees, 56.3% of SMEs are small enterprises with 10 to 200 employees, and 17.5% of SMEs are medium enterprises with 201 to 300 employees. Regarding the industry, most of the SMEs are from trading and services industries with 22.1% and 21.5% respectively, followed by the enterprises in the construction industry (15.1%). There are 10.5% of SMEs in the manufacturing industry and 10.5% of SMEs in finance, insurance, and real estate. The rest are SMEs from other sectors such as transportation, information, media and communication, medicine and healthcare. Among these participations, 24.4% of SMEs have adopted m-commerce, and 75.6% of SMEs have not adopted this type of business model.

Category	Description	Frequency	Percent	Category	Description	Frequency	Percent
Location of SMEs	North Vietnam	76	44.2%	Duration of business	< 5 years	37	21.5%
	Central and Highland	69	40.1%		5 - 10 years	31	18.0%
	South Vietnam	27	15.7%		10 - 15 years	22	12.8%
			> 15 years		82	47.7%	
Industry	Construction	26	15.1%	Size (No. of employees)	< 10	45	26.2%
	Trading	38	22.1%		10 - 50	57	33.1%
	Services	37	21.5%		51 - 100	20	11.6%
	Manufacturing	18	10.5%		101 - 200	20	11.6%
	Healthcare	10	5.8%		201 - 300	30	17.5%
	Transportation	3	1.7%		> 300	0	0 %
	ICT	9	5.2%	Adoption	Adopter	42	24.4%
	Finance & insurance	18	10.5%		Non-adopter	130	75.6%
	Others	13	7.6%				

Table 1. Demographic characteristic of the SMEs

## 5.2 Reliability Analysis

A reliability analysis was conducted to assess the stability of the measurement instrument. As the constructs proposed in the framework were measured by multiple items, the internal reliability must be calculated to confirm their internal consistency (Creswell 2012). Thirteen proposed independent variables were estimated for internal consistency by calculating the Cronbach's alpha as shown in Table 2. The results indicate that the average of the Cronbach's alpha value is ranged from 0.836 for perceived complexity to 0.945 for employees' IT knowledge. Out of the thirteen variables, six variables have excellent reliability with the Cronbach's alpha value from 0.9, and seven variables have good reliability with the Cronbach's alpha value between 0.8 and 0.9. These results indicate that the internal consistency of the instrument is acceptable and reliable.

Dimensions	Variables	N.o of Items	Cronbach's Alpha	Reliability Strength
Technological factors	Perceived Benefits	8	0.912	Excellent
	Perceived Compatibility	6	0.888	Good
	Perceived Complexity	3	0.836	Good
	Perceived Security	3	0.848	Good
	Perceived Cost	3	0.891	Good
Organizational factors	Employees' IT knowledge	3	0.945	Excellent
	Organizational readiness	3	0.839	Good
	Strategic orientation	3	0.850	Good
Environmental factors	Competitiveness	3	0.887	Good
	Customer pressure	3	0.922	Excellent
	Government support	3	0.916	Excellent
Managerial factors	Top management support	3	0.926	Excellent
	Managers' IT knowledge	3	0.908	Excellent

Table 2. Cronbach's alpha reliability analysis

## 5.3 Discriminant Validity Assessment

Validity refers to whether the items of the scale correctly measure the relevant instrument without additional features. Although the constructs used in this study are adopted from previous studies, the translation process of the questionnaire from its original language, the difference in research contexts, and the purpose of generalizing findings for this study require a validity analysis. In this regard, the exploratory factor analysis (EFA) with the principal axis factoring extraction method and the Promax rotation method were used. First, the sample size is 172 that satisfies the minimum case to the variable ratio of 5:1. This supports the appropriateness to run EFA (Hair et al. 2010). Second, the Kaiser-Meyer-Olkin (KMO) test and Bartlett's test of sphericity (BTOS) are used to test the factorability of the data. The data are factorable if the KMO is between 0.5 and 1, and the BTOS is significant with the value below 0.05 (Hair et al. 2010). Third, the numbers of extracted factors are fixed for each dimension as proposed in the conceptual model so that they can achieve the acceptable eigenvalues from 0.7 (Field 2013). Finally, the minimum factor loading to allocate an item to a factor is set at 0.45 as the suggestion of Hair et al. (2010) for the sample size of 172.

Table 3 presents the results of EFA for the technological dimension. 18 items were retained from 23 initial items that were extracted into five factors. The KMO value is 0.875. The minimum eigenvalue is 0.831 that meets the rule of Field (2013). The total of explained variance is 76.467%. These offer strong evidence for the validity of the technological factors.

Items	Item details	F1	F2	F3	F4	F5
BEN4	Growth of revenue	.830				
BEN3	Increase in market share	.742				
BEN2	Simplification of the operating procedures	.741				
BEN5	Creation of marketing channels	.728				
BEN1	Operating costs savings	.667				
SEC2	Availability of industry security standards for m-commerce		.918			
CPL2	Availability of industry standards for m-commerce applications		.768			
SEC1	Company's awareness of the security of m-commerce		.762			
SEC3	Availability of laws and regulations for m-commerce		.710			
CPL3	Presence of experience to use m-commerce applications		.635			
CST2	Training cost requirements			.848		
CST3	Maintenance cost requirements			.824		
CST1	Infrastructure cost requirements			.823		
CPA1	Alignment with the internal ICT infrastructure				.921	
CPA2	Integration with current business processes				.762	
CPA3	Adaptability of existing distribution channels				.531	
BEN7	Improvement in competitiveness					.819
BEN8	Enhancement of customer services					.627
<b>KMO (Bartlett's Test)</b>		<b>.875 (.000)</b>				
<b>Eigenvalues</b>		<b>8.270</b>	<b>1.999</b>	<b>1.495</b>	<b>1.167</b>	<b>.831</b>
<b>Total variance explained</b>		<b>76.467%</b>				
F1=Perceived Direct Benefits, F2=Perceived Security, F3=Perceived Cost, F4=Perceived Compatibility, F5=Perceived Indirect Benefits						

Table 3. Factor analysis results for technological factors

Table 4 presents the results of EFA for the organizational dimension. 7 items were retained from 9 initial items that were extracted into three factors. The KMO value is 0.804. The minimum eigenvalue is 0.732 that meets the rule of Field (2013). The total of explained variance is 88.234%. These offer strong evidence for the validity of the organizational factors.

Items	Item details	F1	F2	F3
EMP2	Employees' proficiency to use IT	.972		
EMP1	Employees' understanding of m-commerce	.894		
EMP3	Employees' competence about new technologies	.879		
REA1	Financial readiness		.953	
REA2	Technological readiness		.762	
ORI3	Alignment between the business strategy and m-commerce			.783
ORI2	Alignment between IT strategy and business strategy			.779
<b>KMO (Bartlett's Test)</b>		<b>.804 (.000)</b>		
<b>Eigenvalues</b>		<b>4.082</b>	<b>1.361</b>	<b>.732</b>
<b>Total variance explained</b>		<b>88.234%</b>		
F1=Employees' IT Knowledge, F2=Organizational Readiness, F3=Strategic Orientation				

Table 4. Factor analysis results for organizational factors

Table 5 presents the results of EFA for the environmental dimension. The initial 9 items were extracted into three factors. The KMO value is 0.865. The minimum eigenvalue is 0.838 that meets the rule of Field (2013). The total of explained variance is 85.492%. These offer strong evidence for the validity of the environmental factors.

Items	Item details	F1	F2	F3
GOV3	Availability of training and educational programs	.923		
GOV2	Financial support from the government	.905		
GOV1	Legal considerations for m-commerce	.786		
CUS2	Customers' expectation to adopt m-commerce		.933	
CUS1	Customers' requirement to adopt m-commerce		.841	
CUS3	The need for maintaining customers' relationships		.802	
CPE2	Availability of similar products of new entrants			.996
CPE3	Availability of substitute products			.700
CPE1	Availability of similar products of competitors			.684
<b>KMO (Bartlett's Test)</b>		<b>.865 (.000)</b>		
<b>Eigenvalues</b>		<b>5.405</b>	<b>1.440</b>	<b>.838</b>
<b>Total variance explained</b>		<b>85.492%</b>		
F1=Government Support, F2=Customer Pressure, F3=Competitive Pressure				

Table 5. Factor analysis results for environmental factors

Table 6 presents the results of EFA for the managerial dimension. 5 items were retained from 6 initial items that were extracted into two factors. The KMO value is 0.710. The minimum eigenvalue is 1.223 that meets the rule of Field (2013). The total of explained variance is 90.894%. These offer strong evidence for the validity of the managerial factors.

Items	Item details	F1	F2
TMS3	Championship of management	.929	
TMS1	Managers' awareness of m-commerce	.895	
TMS2	Allocation of necessary resources	.870	
MIT2	Managers' proficiency to use IT		.962
MIT3	Managers' competence in new technologies		.954
<b>KMO (Bartlett's Test)</b>		.710 (.000)	
<b>Eigenvalues</b>		3.322	1.223
<b>Total variance explained</b>		90.894%	
<i>F1=Top Management Support, F2=Managers' IT Knowledge</i>			

Table 6. Factor analysis results for managerial factors

#### 5.4 Final reliability and validity assessment

The results from EFA support the discriminant validity of the constructs. To further assess the validity, the convergent validity of the construct should be considered by examining the average variance extracted (AVE) value for each latent construct. Furthermore, an examination of internal consistency for retained items resulting from EFA is required to ensure their reliability. As a result, Cronbach's alpha and composite reliability were applied to have a better reliability assessment for the constructs (Ifinedo 2011). Table 7 presents a summary of AVE, Cronbach's alpha and composite reliability of 13 retained constructs. The AVE values of all the constructs are greater than the suggested threshold of 0.5. This means that they are acceptable and adequate for convergent validity (Fornell and Larcker 1981). Additionally, the Cronbach's alpha and composite reliability exceed the minimum recommended a cut-off of 0.6 and 0.65 respectively (Geyskens et al. 1996), indicating the adequate reliability of the constructs.

Dimensions	Constructs	No. of items	AVE	Cronbach's Alpha	Composite Reliability
Technology	Perceived Direct Benefits	5	.553	.879	.898
	Perceived Security	5	.584	.887	.888
	Perceived Cost	3	.692	.891	.813
	Perceived Compatibility	3	.570	.842	.812
	Perceived Indirect Benefits	2	.532	.878	.776
Organization	Employees' IT Knowledge	3	.839	.945	.780
	Organizational Readiness	2	.744	.857	.717
	Strategic Orientation	2	.610	.780	.766
Environment	Competitive Pressure	3	.763	.916	.793
	Customer Pressure	3	.740	.922	.799
	Government Support	3	.650	.887	.797
Management	Top Management Support	3	.807	.926	.787
	Managers' IT Knowledge	2	.918	.957	.685

Table 7. AVE, Cronbach's alpha and Composite reliability for retained constructs

## 6 Conclusion

The benefits of m-commerce for businesses lead to its wide adoption in the world. The literature review indicates a huge difference in the adoption of m-commerce between the developed country and the developing country. While m-commerce has a high level of adoption in developed countries (Mbogo, 2010), it has not been fully utilized by SMEs in developing countries (Nafea and Younas 2014). This shows that an investigation of the critical determinants for organizational m-commerce adoption is significant for the successful adoption of m-commerce in SMEs in developing countries.

This study develops a conceptual framework for examining the critical determinants for m-commerce adoption in Vietnamese SMEs. The proposed framework is grounded from the TOE framework and the DOI theory, conceptualizing four dimensions including the technological context, the organizational context, the environmental context, and the managerial context.



The measurement instrument for the variables in the conceptual model was preliminarily tested for its reliability and validity with the empirical data collected from the online survey of the managers of 172 SMEs in Vietnam. The study confirms the extraction of thirteen variables including perceived direct benefits, perceived security, perceived cost, perceived compatibility, perceived indirect benefits, employees' IT knowledge, organizational readiness, strategic orientation, competitive pressure, customer pressure, government support, top management support, and managers' IT knowledge for investigating the adoption of m-commerce in Vietnamese SMEs.

This preliminary study supports an in-deep investigation of the critical determinants of m-commerce adoption in Vietnamese SMEs. It, however, has some limitations. First, the data were collected from the small sample size of 172. As a result, there needs to increase the sample size to have more robust data for significant results. Second, there needs to have more analysis such as confirmatory factor analysis to have strong support for the appropriateness of the measurement instrument and to ensure the significance of further results. Furthermore, the target population for data collection is SMEs in the case of the Vietnamese market that includes adopters and non-adopters. As a result, the differences in their perception on the critical determinants can create the bias for empirical results.

## 7 References

- Al-Qirim, N. 2006. "Mobile commerce technologies penetration in small to medium-sized enterprises in New Zealand," in *International Conference on Innovations in Information Technology*, Dubai, United Arab Emirates, November.
- Alam, S.S., Khatibi, A., Ahmad, M.I.S., and Ismail, H.B. 2008. "Factors affecting e-commerce adoption in the electronic manufacturing companies in Malaysia," *International Journal of Commerce and Management* (17:1/2), pp. 125-139.
- Alfahl, H., Houghton, L., and Sanzogni, L. 2017. "Mobile Commerce Adoption in Saudi Organizations: A Qualitative Study," *International Journal of Enterprise Information Systems* (13:4), pp. 31-57.
- Alfahl, H., Sanzogni, L., and Houghton, L. 2012. "Mobile commerce adoption in organizations: A literature review and future research directions," *Journal of Electronic Commerce in Organizations* (10:2), pp. 61-78.
- Alqatan, S., Noor, N.M.M., Man, M., and Mohamad, R. 2017. "A theoretical discussion of factors affecting the acceptance of m-commerce among SMTEs by integrating TTF with TAM," *International Journal of Business Information Systems* (26:1), pp. 66-111.
- Alrawabdeh, W. 2014. "Environmental Factors Affecting Mobile Commerce Adoption - An Exploratory Study on the Telecommunication Firms in Jordan," *International Journal of Business and Social Science* (5:8), pp. 151-164.
- Amegbe, H., Hanu, C., and Nuwasiima, A. 2017. "Small-Scale Individual Entrepreneurs (SIEs) and the Usage of Mobile Money (M-money) and Mobile Commerce (M-commerce) in Facilitating Business Growth in Ghana," *Management Science Letters* (7:8), pp. 373-384.
- Ayyagari, M., Beck, T., and Kunt, A.D. 2007. "Small and medium enterprises across the globe," *Small Business Economics* (29:4), pp. 415-434.
- Baker, J. 2012. *The Technology–Organization–Environment Framework*, in *Information Systems Theory*. London: Springer.
- Barry, H., and Milner, B. 2002. "SMEs and electronic commerce: A departure from the traditional prioritization of training," *Journal of European Industrial Training* (26:7), pp. 316-326.
- Chong, A.Y.L. 2013. "Predicting m-commerce adoption determinants: A neural network approach," *Expert Systems with Applications* (40:2), pp. 523-530.
- Creswell, J.W. 2012. *Educational research: Planning, conducting, and evaluating quantitative and qualitative research*. Boston: Pearson.
- Depietro, R., Wiarda, E., and Fleischer, M. 1990. "The context for change: Organization, technology and environment," *The Processes of Technological Innovation* (199), pp. 151-175.
- Doolin, B., and Ali, E.A.H. 2008. "Adoption of mobile technology in the supply chain: An exploratory cross-case analysis," *International Journal of E-Business Research* (4:4), pp. 1-15.

- Duan, X., Deng, H., and Corbitt, B. 2010. "An Empirical Investigation of the Critical Determinants for the Adoption of E-Market in Australian Small-and-Medium Sized Enterprises," in *21<sup>st</sup> Australasian Conference on Information Systems*, Brisbane, Australia, December.
- Duan, X., Deng, H., and Corbitt, B. 2012. "Evaluating the critical determinants for adopting e-market in Australian small and medium-sized enterprises," *Management Research Review* (35:3), pp. 289-308.
- Dyer, J.H., and Singh, H. 1998. "The relational view: Cooperative strategy and sources of inter-organizational competitive advantage," *Academy of Management Review* (23:4), pp. 660-679.
- Field, A.P. 2013. *Discovering statistics using IBM SPSS statistics*. London, UK: Sage.
- Fornell, C., and Larcker, D.F. 1981. "Evaluating structural equation models with unobservable variables and measurement error," *Journal of Marketing Research* (18:1), pp. 39-50.
- General Statistics Office of Vietnam 2016. "Statistical Handbook of Vietnam." <http://ntappdrfs01n01.rmit.internal/el3/e34243/Downloads/Ruot%20nien%20giam%20TT.pdf> Retrieved 17 August, 2017.
- Geyskens, I., Steenkamp, J.B.E.M., Scheer, L.K., and Kumar, N. 1996. "The effects of trust and interdependence on relationship commitment: A trans-Atlantic study," *International Journal of Research in Marketing* (13:4), pp. 303-317.
- Grandhi, S., and Wibowo, S. 2016. "Mobile Commerce Adoption in North American Organizations: An Empirical Study of Organizational Factors," *Communications of the IBIMA* (2016:2016), pp. 1-17.
- Hair, J.F., Black, W.C., Babin, B.J., Anderson, R.E., and Tatham, R.L. 2010. *Multivariate data analysis*. Upper Saddle River, NJ: Pearson Prentice Hall.
- Hamdan, A.R., Yahaya, J.H., Deraman, A., and Jusoh, Y.Y. 2016. "The success factors and barriers of information technology implementation in small and medium enterprises: An empirical study in Malaysia," *International Journal of Business Information Systems* (21:4), pp. 477-494.
- Huy, L.V., Rowe, F., Truex, D., and Huynh, M.Q. 2012. "An empirical study of determinants of e-commerce adoption in SMEs in Vietnam: An economy in transition," *Journal of Global Information Management* (20:3), pp. 23-54.
- Ifinedo, P. 2011. "Internet/e-business technologies acceptance in Canada's SMEs: An exploratory investigation," *Internet Research* (21:3), pp. 255-281.
- Imre, O. 2016. "Adopting Information Systems in a Small Company: A Longitudinal Study," *Journal of Applied Economics & Business Research* (6:4), pp. 269-283.
- Insides, B. 2011. "The development of small and medium enterprises in Vietnam." <http://businessinsides.com/development-vietnam-small-medium-enterprises.html> Retrieved 15 August, 2017.
- Jain, M., Le, A.N.H., Lin, J.Y.C., and Cheng, J.M.S. 2011. "Exploring the factors favouring m-commerce adoption among Indian MSMEs: A TOE perspective," *Tunghai Management Review* (13:1), pp. 147-188.
- Lippert, S.K., and Govindarajulu, C. 2006. "Technological, organizational, and environmental antecedents to web services adoption," *Communications of the IIMA* (6:1), pp. 146-160.
- Lu, M.T., Hu, S.K., Huang, L.H., and Tzeng, G.H. 2015. "Evaluating the implementation of business-to-business m-commerce by SMEs based on a new hybrid MADM model," *Management Decision* (53:2), pp. 290-317.
- Mallat, N., and Tuunainen, V.K. 2008. "Exploring merchant adoption of mobile payment systems: An empirical study," *E-service Journal* (6:2), pp. 24-57.
- Martin, S.S., Catalan, B.L., and Jeronimo, M.A.R. 2012. "Factors determining firms' perceived performance of mobile commerce," *Industrial Management & Data Systems* (112:6), pp. 946-963.
- Mashagba, F.F.A., Mashagba, E.F.A., and Nassar, M.O. 2013. "Exploring Technological Factors Affecting the Adoption of M-Commerce in Jordan," *Australian Journal of Basic and Applied Sciences* (7:6), pp. 395-400.

- Mbogo, M. 2010. "The impact of mobile payments on the success and growth of micro-business: The case of M-Pesa in Kenya," *Journal of Language, Technology & Entrepreneurship in Africa* (2:1), pp. 182-203.
- Nafea, I., and Younas, M. 2014. "Improving the performance and reliability of mobile commerce in developing countries," in *International Conference on Mobile Web and Information Systems*, Barcelona, Spain, August.
- Njenga, A.K., Litondo, K., and Omwansa, T. 2016. "A Theoretical Review of Mobile Commerce Success Determinants," *Journal of Information Engineering and Applications* (6:5), pp. 13-23.
- OECD 2004. "OECD Information Technology Outlook." <https://www.oecd.org/sti/ieconomy/37620123.pdf> Retrieved 16 August, 2017.
- Oliveira, T., and Martins, M.F. 2010. "Understanding e-business adoption across industries in European countries," *Industrial Management & Data Systems* (110:9), pp. 1337-1354.
- Otieno, E.O., and Kahonge, A.M. 2014. "Adoption of Mobile Payments in Kenyan Businesses: A Case Study of Small and Medium Enterprises (SME) in Kenya," *International Journal of Computer Applications* (107:7), pp. 5-12.
- Picoto, W.N., Belanger, F., and Palma-dos-Reis, A. 2014. "An organizational perspective on m-business: Usage factors and value determination," *European Journal of Information Systems* (23:5), pp. 571-592.
- Poon, S. 2002. "Have SMEs benefited from e-commerce?," *Australasian Journal of Information Systems* (10:1), pp. 66-72.
- Rahman, M.M. 2013. "Barriers to M-commerce adoption in developing countries – A qualitative study among the stakeholders of Bangladesh," *The International Technology Management Review* (3:2), pp. 80-91.
- Rogers, E.M. 2010, *Diffusion of innovations*. New York, USA: Simon and Schuster.
- Seyal, A.H., Rahman, M.N.A., and Mohammad, H.A.Y. 2007. "A quantitative analysis of factors contributing electronic data interchange adoption among Bruneian SMEs: A pilot study," *Business Process Management Journal* (13:5), pp. 728-746.
- Shih, Y.Y., Chen, C.Y., Wu, C.H., Huang, T., and Shiu, S.H. 2010. "Adopted Intention of Mobile Commerce from TAM Perspective: An Empirical Study of Real Estate Industry," in *2010 Portland International Center for Management of Engineering and Technology Conference*, Phuket, Thailand.
- Smith, A.D. 2006. "Exploring m-commerce in terms of viability, growth and challenges," *International Journal of Mobile Communications* (4:6), pp. 682-703.
- Snowden, S., Spafford, J., Michaelides, R., and Hopkins, J. 2006. "Technology acceptance and m-commerce in an operational environment," *Journal of Enterprise Information Management* (19:5), pp. 525-539.
- Stockdale, R., and Standing, C. 2004. "Benefits and barriers of electronic marketplace participation: An SME perspective," *Journal of Enterprise Information Management* (17:4), pp. 301-311.
- Stoica, M., Miller, D.W., and Stotlar, D. 2005. "New technology adoption, business strategy and government involvement: The case of mobile commerce," *Journal of Nonprofit & Public Sector Marketing* (13:1-2), pp. 213-232.
- Tetteh, E., and Burn, J. 2001. "Global strategies for SME-business: Applying the SMALL framework," *Logistics Information Management* (14:1), pp. 171-180.
- Vaithianathan, S. 2010. "A review of e-commerce literature on India and research agenda for the future," *Electronic Commerce Research* (10:1), pp. 83-97.
- Varshney, U., and Vetter, R. 2004. "Mobile commerce: framework, applications and networking support," *Mobile Networks and Applications* (7:3), pp. 185-198.
- VECITA 2017. "20% of SMEs have been ready for electronic commerce." <https://tintuc.inet.vn/chi-20-doanh-nghiep-vua-va-nho-tiep-can-thuong-mai-dien-tu.html> Retrieved 24 July, 2017.
- Welsh, J.A., and White, J.F. 1981. "A small business is not a little big business," *Harvard Business Review* (59:4), pp. 18-32.

# A capability based framework for customer experience focused digital transformation

## Neeraj Sahu

School of Business Information Technology and Logistics  
RMIT University  
Melbourne, Australia  
Email: [neeraj.sahu@student.rmit.edu.au](mailto:neeraj.sahu@student.rmit.edu.au)

## Hepu Deng

School of Business Information Technology and Logistics  
RMIT University  
Melbourne, Australia  
Email: [hepu.deng@rmit.edu.au](mailto:hepu.deng@rmit.edu.au)

## Alemayehu Molla

School of Business Information Technology and Logistics  
RMIT University  
Melbourne, Australia  
Email: [alemayehu.molla@rmit.edu.au](mailto:alemayehu.molla@rmit.edu.au)

## Abstract

*Digital transformation has a potential to deliver numerous values for an organisation through transforming its business models, organisational processes, products and services, and customer engagement. Such a transformation assists organisations to create new capabilities to better serve customers, leading to the improvement of customer experience. As a result, numerous organisations have been investing in digital transformation in today's dynamic environment. There is however, lack of a comprehensive framework for facilitating the implementation of digital transformation in organisations towards improving customer experience. This paper develops a capability based framework for digital transformation in organisations with respect to improving customer experience. Such a framework consisting of analytics, business, customer, and digital is developed through a thematic analysis of qualitative data collected from digital transformation experts in an organisation in Australia using semi-structured interviews. The paper contributes to digital transformation research by the development of a capability framework for better understanding digital transformation in organisations related to the improvement of customer experience.*

## Keywords

Digital transformation, customer experience, dynamic capability theory, conceptual framework

## 1. Introduction

Digital transformation is about the change in an organisation's structure, processes, functions, and business models due to the adoption of digital technologies for radically improving its performance (Matt et al. 2015; Sahu et al. 2018). It integrates digital technologies and organisational processes for generating significant improvements in organisational performance (Westerman et al. 2014a). Digital transformation can provide numerous benefits for an organisation including improving organisational processes, enhancing customer value propositions, improving the quality of customer services, empowering customers, reducing the costs of products and services, innovating new products and services, gaining competitive advantages, increasing customer retention, increasing revenue, and improving customer experience (Davenport 2013; Fitzgerald et al. 2014; Rajabi and Bolhari 2015; Westerman and Bonnet 2015). These benefits motivate organisations to invest in digital transformation.

Digital transformation is growing rapidly in organisations across the world (Kane et al. 2015). Many organisations that involve direct customer interactions are investing significantly in digital transformation (Bharadwaj et al. 2013; Kane et al. 2015; Ward and Peppard 2016). One of the most critical reasons for such a rapid adoption of digital transformation is due to its ability to improve the customer experience in organisations (Westerman et al. 2014b; Duan et al. 2012). Digital transformation equips organisations with various capabilities which assist organisations to enhance their customer processes, engage effectively with their customers, improve features of their products

and services, and provide better economical and emotional value offerings for their customers, leading to the improvement of customer experience (Piccinini et al. 2015; Sahu et al. 2018).

The implementation of digital transformation for improving customer experience in organisations is a complex process (Matt et al. 2015). It involves managing volatile customer behaviours, understanding complex customer information (Westerman and Bonnet 2015), optimising customer processes (Berman 2012), enhancing business models (Nwankpa and Roumani 2016), integrating various digital technologies (Bharadwaj et al. 2013), and adapting to changing business conditions (Matt et al. 2015). As a result, the development of a specific framework of digital transformation towards improving the customer experience would improve the implementation of digital transformation in organisations.

Many studies have examined the implementation of digital transformation towards improving customer experience in organisations (Kane et al. 2015). Hess et al. (2015), for example, evaluate the strategies and the procedures for implementing digital transformation towards improving customer experience in organisations. Klaus and Nguyen (2013) examine the customer engagement processes to implement digital transformation for improving customer experience. Berman (2012) analyses the critical factors for reshaping the customer value proposition for enhancing customer experience in digital transformation. These studies tend to focus primarily on the implementation of digital transformation for improving customer experience from the technical and process perspectives. Few attempts have been made to develop a comprehensive framework for facilitating the implementation of digital transformation for improving customer experience in organisations.

This paper develops a comprehensive framework of digital transformation for improving customer experience in organisations. The framework consisting of four dimension including analytics, business, customer, and digital is tested and validated through analysing the data collected from semi-structured interviews with digital transformation experts. The findings of this study can assist organisations to better implement digital transformation initiatives for improving customer experience in organisations.

The rest of the paper is organised as follows. Section 2 presents a review of the related literature on digital transformation for improving customer experience, therefore justifying the need for this study. Section 3 presents a conceptual framework for digital transformation. Section 4 describes the research methodology that this study has adopted. Subsequently, Section 5 presents a revised capability framework for facilitating digital transformation towards improving customer experience in organisations. Finally, Section 7 presents the conclusion for this research.

## 2. Related literature

The implementation of digital transformation in organisations is a complex process (Matt et al. 2015). It involves several phases including (a) strategy formulation in which long term strategies and policies for digital transformation are prepared (Hess et al. 2016; Kane et al. 2015), (b) organisational analysis in which the need for digital transformation is discussed (Berman 2012; Ward and Peppard 2016), (c) transformation implementation in which digital transformation strategies and policies are executed (Fitzgerald et al. 2014; Matt et al. 2015), (d) change management in which specific changes related to people, processes, and technologies, due to the adoption of digital transformation are managed (Beetham and Sharpe 2013; Berman 2012; Henfridsson et al. 2014), and (e) performance evaluation in which the outcomes from implementing digital transformation are evaluated (Ashurst and Hodges 2010; Kane et al. 2015).

The adoption of digital transformation in an organisation can impact various areas including (a) business models, (b) operational processes, (c) products and services, and (d) customer engagement (Berman 2012; Fitzgerald et al. 2014; Ward and Peppard 2016; Westerman et al. 2014a; Westerman et al. 2014b). Digital transformation changes the business model of an organisation by re-designing the cost and revenue structure in an organisation (Hellbe and Leung 2015; Westerman and Bonnet 2015). It often leads to the change of the operational processes in organisations by inducing agilities, improving reliabilities, and enabling transparencies (Becker et al. 2013; Westerman et al. 2014a). Digital transformation affects the offerings of products and services by embedding innovation and improving their features (Fitzgerald et al. 2014; Matt et al. 2015). It changes the customer engagement by improving customer interactions (Berman 2012; Westerman and Bonnet 2015; Westerman et al. 2014a). This shows that the effective implementation of digital transformation in organisations is critical for the prosperity even the survivability of individual organisations (Sahu et al. 2018).

Numerous studies have been conducted to investigate the implementation of digital transformation for improving customer experience in organisations (Kane et al. 2015). These studies primarily focus on four aspects including (a) the formulation of specific strategies for facilitating implementing digital transformation towards improving customer experience (Kane et al. 2015), (b) the development of

various processes of digital transformation for improving customer experience (Klaus and Nguyen 2013), (c) the integration of digital technologies for improving customer experience (Berman 2012), and (d) the evaluation of the performance of digital transformation for improving customer experience (Berman 2012).

Strategy-oriented research on digital transformation towards improving customer experience focuses on evaluating market situations, understanding customer needs, identifying drivers, defining the scope, and developing and implementing strategies (Matt et al. 2015). Palmer et al. (2015), for example, conduct a comprehensive analysis for evaluating specific strategies based on the identification of the critical drivers for digital transformation towards improving customer experience in organisations. Hess et al. (2015) develop the procedure for implementing the digital transformation strategy in organisations for improving customer experience. Tafti et al. (2013) investigate the strategy for digital transformation towards improving customer experience in organisations. These studies help individual organisations better develop specific strategies and policies for digital transformation towards improving customer experience.

Process-based research on digital transformation focuses on exploiting digital transformation capabilities for improving customer processes, increasing customer interactions, and expanding customer engagement (Greenberg 2010). Klaus and Nguyen (2013), for example, explore the processes of digital transformation for enabling multi-channel customer interaction towards improving customer experience in retail banking. Thirumalai and Sinha (2011) investigate the process of digital transformation for improving customer experience in online retailing. These studies help organisations re-design their processes of digital transformation for improving customer experience.

Technology-integrated research on digital transformation concentrates on an integrated use of digital technologies for developing specific organisational capabilities to improve customer experience. Andzulis et al. (2014), for example, examine the impact of integrating social media technologies in organisations for improving customer experience. Huang et al. (2011) investigate the impact of integrating web technologies in financial organisations for improving customer experience. These studies assist organisations better understand the capability of digital technologies and the impact of such technologies on organisations, leading to more effective integration of digital transformation.

Evaluation-based research on digital transformation for improving customer experience focuses on analysing the performance of digital transformation that can lead to the re-designing customer value offerings (Berman 2012). Berman (2012), for example, evaluates the critical factors for reshaping the customer value through better customer collaboration and enhanced customer experience. Hughes et al. (2013) examine the value of digital transformation by enabling customer self-servicing for improving customer experience in organisations. These studies lead to the identification of the critical factors that can create values for customers through examining the relationship between customer value and customer experience (Nylén and Holmström 2015; Spiess et al. 2014).

Overall existing studies have shown their importance of digital transformation for improving customer experience in organisations from different perspectives. There is, however, lack of a comprehensive framework for facilitating the implementation of digital transformation in organisations towards improving customer experience. This shows the need for developing such a framework of digital transformation for improving customer experience in organisations.

### **3. A digital transformation framework**

A conceptual framework for this research is developed based on the analysis of existing literature on digital transformation for improving customer experience in the context of the dynamic capability theory. The dynamic capability theory reflects the ability of an organisation to integrate, build, and reconfigure internal and external competences to address rapidly changing environments (Teece et al. 1997). Such a theory provides this research with a solid base to develop the framework consisting of several capabilities that an organisation can exploit for improving customer experience. Referring to dynamic capability theory helps this study in building the understanding of the new internal capabilities derived from digital transformation. It assists in investigating the adaptive nature of organisations towards changes caused by new internal capabilities generated by digital transformation. As a result, dynamic capability theory aids in presenting and evaluating the relationships between digital transformation and customer experience improvement. The proposed conceptual framework consists of four dimensions including (a) analytics, (b) business, (c) customers, and (d) digitalization as shown in Figure 1.

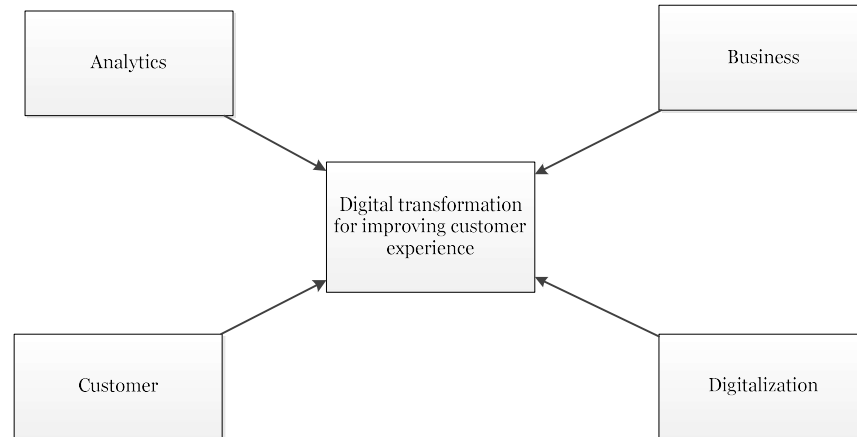

**Figure 1:** The conceptual framework

## Analytics

The analytics of digital transformation is related to the systematic analysis of customer data using digital technologies for discovering the embedded knowledge in organisations. Such knowledge can help organisations better collaborate with their customers for improving customer experience (Kiron et al. 2012). Analytics facilitate the improvement of the various organisational capabilities related to people, process, functions and technologies in an organisation which eventually triggers the improvement of customer experience. There are various factors that aid the construction of the analytics dimension of the conceptual framework including customer understanding (Fitzgerald et al. 2014; Zhu et al. 2006), digital customer data (Westerman and Bonnet 2015), customer insights (Berman 2012; Kiron et al. 2012), market trends (Andal-Ancion et al. 2012), customer segments (Andal-Ancion et al. 2012; Hess et al. 2016), customer engagement patterns (Ward and Peppard 2016), implementation of customer analytics (Ajmal et al. 2010), data reliability (Astri 2015) and data quality and usability (Olszak and Ziemba 2012). These factors play a very critical role in digital transformation for improving customer experience in organisations.

## Business

The business of digital transformation is about the change of business conditions for improving customer experience through digital transformation. The implementation of digital transformation leads to the change of internal conditions in an organisation including the change in decision making, financial conditions and business performance (Matt et al. 2015). In general, four critical factors including (a) the digital strategy, (b) the business model, (c) the customer value proposition and (d) the business strategy have to be considered in this aspect. There are various business factors that assist in forming the business dimension of the conceptual framework including value creation and delivery (Hess et al. 2016; Matt et al. 2015; Westerman and Bonnet 2015), value proposition (Berman and Marshall 2014; Berman 2012), cost optimisation (Sambamurthy and Zmud 2012), pricing strategy (Bharadwaj et al. 2013), cost reduction (Astri 2015), project management (Mathrani and Viehland 2010) and clear business vision and plan (Olszak and Ziemba 2012). The consideration of these factors in digital transformation is identified as significant towards the improvement of customer experience in organisations.

## Customer

The customer of digital transformation concerns about the entire customer interaction journey with the organisation through digital transformation. It focuses on bi-directional interactions between customers and organisations (Lemon and Verhoef 2016). The indirect interaction happens when customers reach out to an organisation using a generic digital platform such as social media (Straker et al. 2015). In relation to the business of digital transformation, the customer touch points and the customer engagement usually need to be considered. There are various factors that facilitate the development of the customer dimension of the framework including customer collaboration (Berman 2012; Fitzgerald et al. 2014), customer touch points (Berman 2012), customer engagement (Andal-Ancion et al. 2012; Berman 2012), customer feedback, customer servicing (Ward and Peppard 2016), personalised marketing (Kane et al. 2015; Ryan 2016), operational process improvement (Sambamurthy and Zmud 2012), service and product quality (Rajabi and Bolhari 2015; Westerman and Bonnet 2015) customer

self-serving (Berman 2012; Westerman and Bonnet 2015; Westerman et al. 2011), process transparency (Agarwal et al. 2010), scalability, collaboration, efficiency (Astri 2015), and customer relationship (Mathrani and Viehland 2010). The consideration of these factors is significant towards the success of digital transformation for improving customer experience.

## Digitalization

The digitalization of digital transformation refers to the adaptability, usability and integration-ability of digital technologies with respect to existing infrastructure in organisations (Kino 2011; Tassey 2012). It considers the capabilities of various digital technologies for improving customer experience in organisations. Digital transformation focuses on the adoption of digital technologies in the existing environment. This requires the organisations to carefully consider (a) digital applications, (b) digital platforms, (c) digital infrastructure, (d) functions, and (e) digital channels. There are several factors that enable the construction of the digital dimension of the conceptual framework including digital channels (Fitzgerald et al. 2014), infrastructure capacity (Kane et al. 2015), data security, integration quality (Westerman and Bonnet 2015), infrastructure support (Bharadwaj et al. 2013), and digital content (Kane et al. 2015), technological readiness (Low et al. 2011), scalability (Astri 2015), technology usability (Mathrani and Viehland 2010), technology integration (Ravesteyn and Batenburg 2010) and accessibility (Sahney 2015).

## Research methodology

This study uses a qualitative approach for the development of a digital transformation framework towards improving customer experience. This is because the nature of this study requires the understanding of the beliefs and perceptions of people working in digital transformation in organisations. The use of the qualitative approach enables this study to analyse various perspectives from the experts of digital transformation (Deng and Karunasena 2013). The study employs the Delphi technique based on semi-structured face-to-face interviews for three rounds of iterations for collecting data and sharing the results among the participants to build consensus towards the development of the framework (Hsu and Sandford 2007). The three iterations focus on capturing the critical data to analyse the participant's views and analysing the various perspectives of experts, leading to confirming the capability-based digital transformation framework (Deng and Gupta 2005).

The research is performed in an Australian organisation which has executed digital transformation programs for improving customer experience. The employees from this organisation are recruited to participate in the research. A total of 28 participants are contacted for the study, of which, 21 have accepted to participate in this study. The experience of participants in digital transformation is ranged from 5 years to 18 years. There are various roles that the participants take including executives, product managers, project managers, solution designers, business analysts, and technology developers. The interview questions are developed based on a comprehensive review of the related literature. Participants are first contacted through emails that contain a brief summary about the study. Once the participants accept to volunteer for the study, the details of the interview such as the time and location are communicated to the participant. For each round of iteration, a list of pre-identified questions is prepared for the interview. The average interview lasts for about 60 minutes.

Thematic analysis is adopted for analysing the qualitative data captured. This involves in five stages including transcribing data, organising data, coding data, theming data, and interpreting data (Miles and Huberman 1994). In the first stage, data related to the topic of the study is captured in different formats including notes, diagrams, files, pictures, and supporting reports from the participant. In the second stage, data is transcribed after the interview process. The third stage involves providing codes for performing thematic analysis. The fourth stage consists of three steps including (a) data reduction which focuses on deriving the most relevant data for the research (Alhojailan 2012), (b) data display which focuses on organising, compressing, assembling, and presenting data (Miles and Huberman 1994), and (c) data conclusion which focuses on summing up conclusions (Alhojailan 2012). The fifth stage involves revisiting the research question using the code and themes identified to answer the research question.

## 4. Research findings and discussion

The research findings are organised around four dimensions, namely, analytics, business, customer, and digitalization with the use of thematic analysis. Such dimensions and their sub-dimensions are extracted from the qualitative data collected. A strong linkage between each dimension and its sub-dimensions has been identified. This can ensure that the validated framework can be used for facilitating the implementation of digital transformation for improving customer experience in organisations.



## **Analytics**

Analytics reflect the characteristics of digital transformation in organisations. They relate to performing the computational analysis of customer-related data for identifying useful patterns. Most of the interviewees unanimously assert a positive influence of analytics on digital transformation for improving customer experience. An analysis of the interview data reveals that better analytics result in better customer satisfaction and improved customer experience. The analytics is explained by three sub-dimensions including (a) data analytics, (b) trends analytics and (b) process analytics.

### **Data analytics**

Data analytics is about processing customer data captured through various digital channels for better customer understanding. Such customer data is usually related to customers' demographics and attitudinal and purchasing behaviours. Interviewees coherently suggest that better data analytics enable organisations to understand customer trends to execute customer specific strategies for better customer experience. An interviewee states - "*...Better data analytics help organisations to target specific customer segments... This focused approach optimises the effort that an organisation makes to connect with their customers...making customers more valued*".

### **Customer trends analytics**

Customer trends analytics present key insights on the demographical and attitudinal behaviours of customers. They can help organisations to take customer-centric decisions. The study suggests that trend analytics improve customer segmentations, empower organisations with improved insights and showcase customer engagement patterns. An interviewee explains - "*using digital analytics capabilities for improving engagement understanding...we can take many tactical decisions...for our customers...making sure they are happy*".

### **Process analytics**

Process analytics is the systematic analysis of the processes for developing critical understanding of optimising customer processes, leading to the improvement of customer experience in organisations. The process analytics have an ability to provide better customer forecasting analysis, enable predictive marketing and services, integrate real-time information for customers, and trigger real time decisions. One of the interviewees states - "*we know what marketing strategies are useful for which customer segments and what services we can use for a particular customer segment... better predictive engagement helps raise financial performance and customer satisfaction*".

## **Business**

The business of digital transformation focuses on aligning the changes to internal and external business conditions with customer offerings for improving customer experience in organisations. An analysis of the interview data highlights the characteristics of the business conditions which make it critical for the organisation to react to the changes through digital transformation so that the customer experience can be improved. The thematic analysis of the business of digital transformation leads to the identification of three sub-dimensions, namely, (a) strategic execution, (b) business model, and (c) value proposition.

### **Strategic execution**

Strategic execution is related to the implementation of the strategic plan on digital transformation for improving customer experience. It focuses on utilising the digital transformation capabilities for planning the transformation. The study shows that effective strategic execution is reflected through understanding customer needs, providing a single view to customers, enabling customer-centric execution, and adapting to changing market situations. The following interview transcript highlights the importance of adapting to the changing market conditions - "*market is changing very rapidly and so is the competition. To retain customers, we need to adopt and change according to the market. We need to adopt new technologies and new ideas for keeping us competitive in market*".

### **Business model**

Business model focuses on streamlining the cost structure, the revenue model, and customer value proposition in digital transformation. It effectively uses the organisation's internal resources for creating optimal products and services. The study shows that the ability to create better business models helps organisations improve customer satisfaction. The following interview transcript presents the significance of having an effective costing model on customer experience - "*making the cost of product*".

*and services competitive and flexible by optimising various cost factors ..benefits end customer who is consuming it. This helps in achieving better customer experience”.*

### **Value proposition**

A value proposition is about the benefits that customers receive from the offerings of an organisation. The effectiveness of the value proposition is developed through creating unique products and services, innovating new products and services, offering better economic and emotional values to customers, and integrating recognitions and rewards for customers. An interviewee illustrates - *“customers are very much aware of the cost and the benefits...using digital transformation we can develop cost effective solutions for our customer ...making them satisfied”.*

### **Customer**

The customer of digital transformation considers the entire customer journey where a customer interacts with organisations through various processes and activities for improving their experience. An analysis of the interview data presents a descriptive picture of the attributes of the customer journey and their influence on customer's perception. Interviewees concordantly assert a positive correlation between the attributes of a customer journey and customer experience. This leads to the identification of four sub-themes including (a) processes, (b) collaboration, (c) services and (d) engagement.

### **Processes**

Processes focus on utilising the digital transformational capabilities to support all customer processes in the customer journey within an organisation. The effectiveness of customer processes is reflected by the automation of the process, the reduction of the operational cost, the simplification of customer processes, the transparency of customer processes, and the coherent customer experience across various channels and devices. The following interview transcript shows the impact of the process transparency on customer experience improvement - *“making customer aware of the products, and services and its conditions.....improve customer experience...it avoid misleading customers with non-relevant or technical jargons or incorrect information ...to maintain positive relationship”.*

### **Collaboration**

Collaboration focuses on managing customer perceptions and incorporating suggestions from customers about the products and services for improving the value offerings. The customer experience can be captured by focusing on integrating customer feedbacks, providing constant communication to customers, and conducting training for customers. An interviewee state - *“improving customer experience requires a lot of customer understanding. This is performed by taking feedback from customers using digital channels about what the customer wants”.*

### **Services**

Services are related to the set of tangible values that organisations offer to customers. The study suggests that digital transformation enables organisations with multiple capabilities that help organisations to enhance customer services by enabling better customer experience. Such capabilities are supported through 24x7 real time servicing, personalise servicing, and self-servicing. A customer experience expert illustrates the importance for inculcating self-services in organisations by digital transformation - *“customer self-service triggers three important elements of customer experience, it empowers customers, it gives customers flexibility, and it provides on-demand interaction”.*

### **Engagement**

Engagement focuses on utilising the digital transformation capabilities to understand customers and to reach out to them with most appropriate offerings based on their characteristics. The customer engagement is related to personalised marketing, proactive engagement, and integrated offline and online channels. An interviewee reveals the significance of proactive engagement as - *“connecting with customer proactively creates a big impact in their experience. ... It includes proactively monitoring their service behaviour, providing push notifications through application, and even reminding them of new offers or deadlines for payments”.*

### **Digitalization**

Digitalization is a global theme identified in this study. It reflects the key features, characterises, properties and capabilities of digital technologies for digital transformation. Organisations leverage the digital technology capabilities for better servicing customers. The study reveals that an effective integration of digital technologies allows organisations to generate better features, functions and

processes for customers, leading to better customer experience. The digitalization theme is abstracted from sub-themes including (a) digital integration, (b) digital capacities and (c) digital capabilities.

### Integration

Digital integration refers to the combination of digital technologies for improving customer experience in organisations. It focuses on better digital enterprise integration, integration with the 3<sup>rd</sup> party, and social media integration. An interviewee explains the importance of social media integration - *“We know our customers use a lot of social media platforms to share a view, or issue and seek information using these forum....integrating social media provides a very effective way to understand customer ...customer feel empowered when their problem solved using their own preferred medium”*.

### Capabilities

Capabilities are about the ability of digital technologies in supporting customer processes for improving customer experience in organisations. It is reflected through the ability of digital technologies for providing multiple digital channels, platforms and device independent digital services, high quality digital content, better usability, and data securities and reliabilities. An interviewee highlights the impact of usability - *“customer gets annoyed when they deal with complex functions which are difficult to navigate and over information which is irrelevant to them”*.

### Capacities

Capacities are the ability of digital transformation to provide the maximum level of output in organisations. The study reveals that digital capacities is defined by enhanced system capacities for handling large volumes of customer data, increased processes capacities for processing high speed customer data, improved service speed and performance, and uninterrupted system availability for the customers. An expert suggests the impact of performance and speed on customer experience as - *“any lag while accessing the digital content or any other services degrades the customer experience”*.

The discussion above leads to the development of a digital transformation framework consisting of four dimensions, namely, (a) analytics, (b) business, (c) customer, and (d) digitalization. Each dimension involves various sub-dimensions. The analytics dimension can be effectively influenced by three sub-dimensions, namely, (a) data analytics, (b) customer trends analytics and (c) process analytics. The business dimension is affected by three sub-dimensions, namely, (a) strategic execution, (b) business model and (c) value proposition. The customer dimension is derived by the effectiveness of four sub-dimensions, namely, (a) process, (b) collaboration, (c) services and (d) engagement. Finally, the digitalization dimension is reflected through the three sub-dimensions, namely, (a) digital integration, (b) digital capacities and (c) digital capabilities. Figure 2 presents the digital transformation framework.

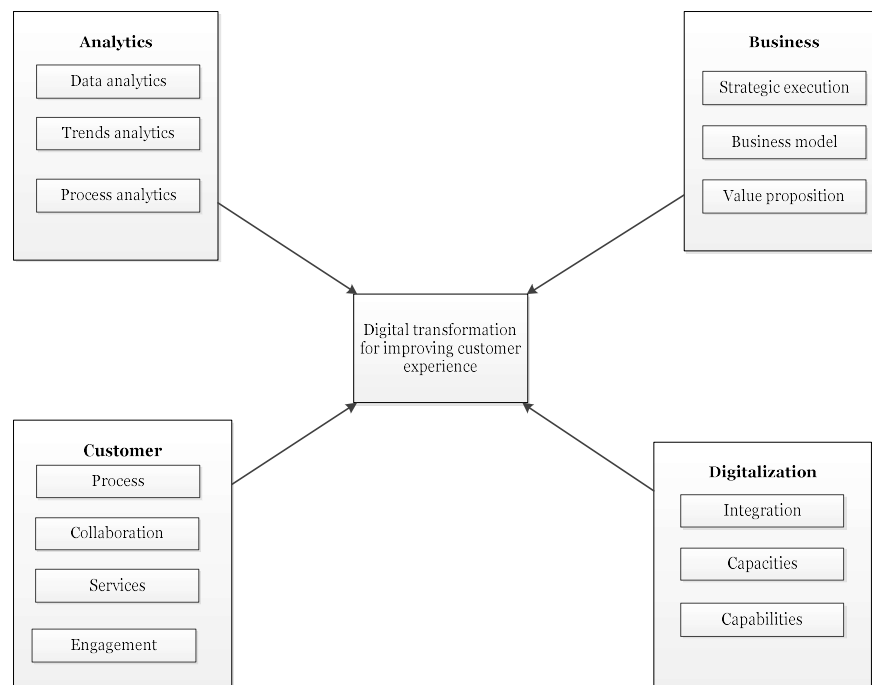

**Figure 2:** The digital transformation framework

## 5. Conclusion

This paper presents a capability-based framework for digital transformation towards improving customer experience in organisations. It unearthed several sub-dimensions within each dimension of the conceptual framework that can affect the outcome of digital transformation initiatives in organisations. The sub dimensions highlight various capabilities of digital transformation which enables organisations to improve customer experience, including data analytics, trends analytics, process analytics, strategic execution, business model, value proposition, process, collaboration, services, engagement, digital integration, digital capabilities, and digital capacities. Understanding the digital transformation framework would induce confidence to the leadership and senior management in organisations executing digital transformation.

This study contributes to the research of digital transformation from both the theoretical and the practical perspectives. From the theoretical perspective, this research contributes to the research related to digital transformation by developing a theoretical framework for implementing digital transformation for improving customer experience. From the practical perspective, this research would be helpful in organisations to facilitate implementing such initiatives effectively.

## 6. REFERENCES

- Agarwal, R., Gao, G., DesRoches, C., and Jha, A. K. 2010. "Research Commentary—the Digital Transformation of Healthcare: Current Status and the Road Ahead," *Information Systems Research* (21:4), pp. 796-809.
- Ajmal, M., Helo, P., and Kekäle, T. 2010. "Critical Factors for Knowledge Management in Project Business," *Journal of knowledge management* (14:1), pp. 156-168.
- Alhojailan, M. I. 2012. "Thematic Analysis: A Critical Review of Its Process and Evaluation," *West East Journal of Social Sciences* (1:1), pp. 39-47.
- Andal-Ancion, A., Cartwright, P. A., and Yip, G. S. 2012. "The Digital Transformation of Traditional Business," *Image*.
- Ashurst, C., and Hodges, J. 2010. "Exploring Business Transformation: The Challenges of Developing a Benefits Realization Capability," *Journal of Change Management* (10:2), pp. 217-237.
- Astri, L. Y. 2015. "A Study Literature of Critical Success Factors of Cloud Computing in Organizations," *Procedia Computer Science* (59), pp. 188-194.
- Becker, J., Kugeler, M., and Rosemann, M. 2013. *Process Management: A Guide for the Design of Business Processes*. Springer Science & Business Media.
- Beetham, H., and Sharpe, R. 2013. *Rethinking Pedagogy for a Digital Age: Designing for 21st Century Learning*. Routledge.
- Berman, S., and Marshall, A. 2014. "The Next Digital Transformation: From an Individual-Centered to an Everyone-to-Everyone Economy," *Strategy & Leadership* (42:5), pp. 9-17.
- Berman, S. J. 2012. "Digital Transformation: Opportunities to Create New Business Models," *Strategy & Leadership* (40:2), pp. 16-24.
- Bharadwaj, A., El Sawy, O. A., Pavlou, P. A., and Venkatraman, N. 2013. "Digital Business Strategy: Toward a Next Generation of Insights," *Mis Quarterly* (37:2), pp. 471-482.
- Davenport, T. H. 2013. *Process Innovation: Reengineering Work through Information Technology*. Harvard Business Press.
- Deng, H. and Gupta, P. (2005). Critical successful factors in information systems implementation: An end-user perspective. *Proceedings of the 2005 Information Resources Management Association International Conference*, May 15-18, San Diego, California, USA
- Ding, X. D., Huang, Y., and Verma, R. 2011. "Customer Experience in Online Financial Services: A Study of Behavioral Intentions for Techno-Ready Market Segments," *Journal of Service Management* (22:3), pp. 344-366.
- Duan, X., Deng, H., & Corbitt, B. (2012). Evaluating the critical determinants for adopting e-market in Australian small-and-medium sized enterprises. *Management Research Review*, 35(3/4), 289-308.

- Fitzgerald, M., Kruschwitz, N., Bonnet, D., and Welch, M. 2014. "Embracing Digital Technology: A New Strategic Imperative," MIT Sloan management review (55:2), p. 1.
- Greenberg, P. 2010. "The Impact of Crm 2.0 on Customer Insight," Journal of Business & Industrial Marketing (25:6), pp. 410-419.
- Hellbe, S., and Leung, P. 2015. "Digital Transformation: How Apis Drive Business Model Change and Innovation."
- Henfridsson, O., Mathiassen, L., and Svahn, F. 2014. "Managing Technological Change in the Digital Age: The Role of Architectural Frames," Journal of Information Technology (29:1), pp. 27-43.
- Hess, T., Matt, C., Benlian, A., and Wiesböck, F. 2016. "Options for Formulating a Digital Transformation Strategy," MIS Quarterly Executive (15:2).
- Hilton, T., Hughes, T., Little, E., and Marandi, E. 2013. "Adopting Self-Service Technology to Do More with Less," Journal of Services Marketing (27:1), pp. 3-12.
- Hsu, C.-C., and Sandford, B. A. 2007. "The Delphi Technique: Making Sense of Consensus," Practical assessment, research & evaluation (12:10), pp. 1-8.
- Kane, G. C., Palmer, D., Phillips, A. N., Kiron, D., and Buckley, N. 2015. "Strategy, Not Technology, Drives Digital Transformation," MIT Sloan Management Review and Deloitte University Press).
- Karunasena, K., Deng, H., and Harasgama, K. S. (2013). An investigation of the critical factors for evaluating the public value of e-government: A thematic analysis. Information Systems and Technology for Organizations in a Networked Society. IGI Global, 213-233.
- Kino, T. 2011. "Infrastructure Technology for Cloud Services," Fujitsu Sci. Tech. J (47:4), pp. 434-442.
- Kiron, D., Shockley, R., Kruschwitz, N., Finch, G., and Haydock, M. 2012. "Analytics: The Widening Divide," MIT Sloan Management Review (53:2), p. 1.
- Klaus, P., and Nguyen, B. 2013. "Exploring the Role of the Online Customer Experience in Firms' Multi-Channel Strategy: An Empirical Analysis of the Retail Banking Services Sector," Journal of Strategic Marketing (21:5), pp. 429-442.
- Lemon, K. N., and Verhoef, P. C. 2016. "Understanding Customer Experience Throughout the Customer Journey," Journal of Marketing (80:6), pp. 69-96.
- Low, C., Chen, Y., and Wu, M. 2011. "Understanding the Determinants of Cloud Computing Adoption," Industrial management & data systems (111:7), pp. 1006-1023.
- Mathrani, S., and Viehland, D. 2010. "Critical Success Factors for the Transformation Process in Enterprise System Implementation," PACIS, p. 13.
- Matt, C., Hess, T., and Benlian, A. 2015. "Digital Transformation Strategies," Business & Information Systems Engineering (57:5), pp. 339-343.
- Miles, M. B., and Huberman, A. M. 1994. Qualitative Data Analysis: An Expanded Sourcebook. sage.
- Mithas, S., Tafti, A., and Mitchell, W. 2013. "How a Firm's Competitive Environment and Digital Strategic Posture Influence Digital Business Strategy," Mis Quarterly (37:2), pp. 511-536.
- Nwankpa, J. K., and Roumani, Y. 2016. "It Capability and Digital Transformation: A Firm Performance Perspective,").
- Nylén, D., and Holmström, J. 2015. "Digital Innovation Strategy: A Framework for Diagnosing and Improving Digital Product and Service Innovation," Business Horizons (58:1), pp. 57-67.
- Olszak, C. M., and Ziemba, E. 2012. "Critical Success Factors for Implementing Business Intelligence Systems in Small and Medium Enterprises on the Example of Upper Silesia, Poland," Interdisciplinary Journal of Information, Knowledge, and Management (7:12), pp. 129-150.
- Piccinini, E., Gregory, R. W., and Kolbe, L. M. 2015. "Changes in the Producer-Consumer Relationship-Towards Digital Transformation," Wirtschaftsinformatik, pp. 1634-1648.
- Rajabi, M., and Bolhari, A. 2015. "Business Transformations: Inevitable Changes of the Era," Optimization of Supply Chain Management in Contemporary Organizations), p. 61.
- Ravesteyn, P., and Batenburg, R. 2010. "Surveying the Critical Success Factors of Bpm-Systems Implementation," Business Process Management Journal (16:3), pp. 492-507.

Ryan, D. 2016. *Understanding Digital Marketing: Marketing Strategies for Engaging the Digital Generation*. Kogan Page Publishers.

Sahney, S. 2015. "Critical Success Factors in Online Retail—an Application of Quality Function Deployment and Interpretive Structural Modeling," *International Journal of Business and Information* (3:1).

Sahu, N., Deng, H., and Molla, A. 2018. "Investigating the critical success factors of digital transformation for improving customer experience," *International Conference on Information Resources Management* 2018.

Sambamurthy, V., and Zmud, R. W. 2012. *Guiding the Digital Transformation of Organizations*. Legerity Digital Press.

Spiess, J., T'Joens, Y., Dragnea, R., Spencer, P., and Philippart, L. 2014. "Using Big Data to Improve Customer Experience and Business Performance," *Bell Labs Technical Journal* (18:4), pp. 3-17.

Straker, K., Wrigley, C., and Rosemann, M. 2015. "Typologies and Touchpoints: Designing Multi-Channel Digital Strategies," *Journal of Research in Interactive Marketing* (9:2), pp. 110-128.

Tassey, G. 2012. *Technology Infrastructure and Competitive Position*. Springer Science & Business Media.

Teece, D. J., Pisano, G., and Shuen, A. 1997. "Dynamic Capabilities and Strategic Management," *Strategic management journal*, pp. 509-533.

Thirumalai, S., and Sinha, K. K. 2011. "Customization of the Online Purchase Process in Electronic Retailing and Customer Satisfaction: An Online Field Study," *Journal of Operations Management* (29:5), pp. 477-487.

Ward, J., and Peppard, J. 2016. *The Strategic Management of Information Systems: Building a Digital Strategy*. John Wiley & Sons.

Westerman, G., and Bonnet, D. 2015. "Revamping Your Business through Digital Transformation," *MIT Sloan Management Review* (56:3), p. 10.

Westerman, G., Bonnet, D., and McAfee, A. 2014a. *Leading Digital: Turning Technology into Business Transformation*. Harvard Business Press.

Westerman, G., Bonnet, D., and McAfee, A. 2014b. "The Nine Elements of Digital Transformation," *MIT Sloan Management Review* (7).

Westerman, G., Calmédjane, C., Bonnet, D., Ferraris, P., and McAfee, A. 2011. "Digital Transformation: A Roadmap for Billion-Dollar Organizations," *MIT Center for Digital Business and Capgemini Consulting*).

**Copyright:** © 2018 authors. This is an open-access article distributed under the terms of the [Creative Commons Attribution-NonCommercial 3.0 Australia License](https://creativecommons.org/licenses/by-nc/3.0/australia/), which permits non-commercial use, distribution, and reproduction in any medium, provided the original author and ACIS are credited.

# Exploring the Impact of Augmented Reality and Virtual Reality Technologies on Business Model Innovation in Technology Companies in Germany

## Richard Hagl

The School of Business  
The Department of Graduate Business  
Waterford Institute of Technology (WIT)  
Cork Road, Waterford City, Ireland  
Email: [hagl@phaenom.eu](mailto:hagl@phaenom.eu)

## Aidan Duane

The School of Business  
The Department of Graduate Business  
Waterford Institute of Technology (WIT)  
Cork Road, Waterford City, Ireland  
Email: [aduane@wit.ie](mailto:aduane@wit.ie)

## Abstract

Newly-emerging, digitally-based technological innovations, such as augmented reality (AR) and virtual reality (VR), are new drivers for business model innovation. This study aims to develop a better understanding of the impact of AR/VR technologies on business model innovation in technology companies. The objective of the study is “to explore the impact of augmented reality and virtual reality technologies on business model innovation in technology companies in Germany”. This paper investigates the body of knowledge regarding contemporary business model innovation and presents a conceptual framework to guide the research. The philosophical underpinnings of the study are discussed, and the chosen research methodology is justified. A holistic multiple-case study design targets German business-to-business technology companies employing AR/VR technologies to innovate their business models. The paper concludes with a discussion of initial learnings garnered from the implementation of a pre-pilot case study test run, and a full pilot case study.

**Keywords** Augmented Reality, Virtual Reality, Business Models, Business Model Innovation, Case Studies.

**Copyright:** © 2018 authors. This is an open-access article distributed under the terms of the [Creative Commons Attribution-NonCommercial 3.0 Australia License](https://creativecommons.org/licenses/by-nc/3.0/), which permits non-commercial use, distribution, and reproduction in any medium, provided the original author and ACIS are credited.

## 1 INTRODUCTION

Digital technologies such as augmented reality (AR) and virtual reality (VR) are drivers for business model innovation (BMI) (Casadesus-Masanell and Ricart 2011), and business models themselves may be shaped by technological innovations (Teece 2006). This is especially true in the high velocity environment of the internet, where business models must be frequently altered to meet new challenges. These technologies are expected to offer significant revenue opportunities in numerous industries in the next few years (Ebert et al. 2017). However, new technologies – such as AR/VR – oftentimes have no obvious business case (Chesbrough 2010), and little is known about their impact on BMI. Zott et al. (2011) note that “academic research on business models seems to lag behind practice” (p.1022) and that “prior frameworks used in isolation cannot sufficiently address questions about total value creation” (p.1029). However, “it is ill-understood how changing market, technology and regulation conditions generally drive revisions in business models” (De Reuver et al. 2009, p.1). Helping close this gap is a valuable contribution to theory, aligning it closer to practice. Thus, the objective is “to explore the impact of augmented reality and virtual reality technologies on business model innovation in technology companies in Germany”.

## 2 LITERATURE REVIEW

Emerging technological innovations and business models are profoundly linked (Baden-Fuller and Haefliger 2013), and BMI can be driven by emerging digital technologies such as AR/VR (Euchner 2016). However, most entrepreneurs don't sufficiently understand what business models are, lack the skills to design appropriate models, and fail to innovate business models, as market conditions change. Hence, further research is needed. Our discussion starts with understanding AR/VR.

### 2.1 Augmented Reality and Virtual Reality: Business Model Innovation Drivers

A conservative prediction expects the market volume of AR/VR to jump from \$3 billion in 2016, to \$40 billion by 2020 (SuperData 2017). Gartner (2016) placing AR/VR on their Top Ten strategic technology trends, conclude that “transparently immersive technologies identified within this theme are at, or over, the Peak of Inflated Expectations, ... and they are now poised to achieve real productivity”. These forecasts are founded on an assessment that AR/VR have reached sufficient technological readiness (Ebert et al. 2017), “offering more opportunity than ever before to create compelling AR/VR experiences” (Billinghurst et al. 2015, p.3). Key is widespread application of AR/VR across industries. AR/VR are broadly seen as potential new training systems for maintenance and assembly tasks (Gavish et al. 2015). Similarly, AR/VR promise to be beneficial for education purposes. Many of the world's largest companies have already incorporated AR/VR into marketing strategies: “innovative marketers can now leverage AR to craft immersive brand experiences, create more interactive advertising, and enable consumers to experience products and spaces in novel ways.” (Scholz and Smith 2016, p.2). For destination marketing practitioners, theme parks are a potential market for AR (Jung et al. 2015). Employing AR/VR for remote collaboration also offers novel opportunities: who can a user interact with (e.g. remote people), and how can be interacted (Greenwald et al. 2017). Further promising fields are virtual showrooms and product configurators as pioneered by Audi and IKEA.

### 2.2 Business Models and Business Model Innovation

Companies may approach the commercialisation of new technologies, through the development of business models (Brettel 2015). However, before entrepreneurs can go about innovating their business model, they need to comprehend what a business model actually is (Chesbrough 2010). Business models can serve as communication tools (Morris et al. 2005), and “as a mediating construct between technology and economic value” (Chesbrough and Rosenbloom 2002, p.532). Business models can also be a source of competitive advantage (Lüdeke-Freund 2013), as they are more difficult to imitate than product-, service-, or process-innovations (Schallmo 2013). Ultimately, it may be that “a mediocre technology pursued within a great business model may be more valuable than a great technology exploited via a mediocre business model” (Chesbrough 2010, p.354). Business models are not static, but of dynamic nature (De Reuver et al. 2009), and companies striving for sustainability, need to continuously reinvent their business models (Sharma and Gutiérrez 2010). Furthermore, BMI “can provide significant opportunities both during periods of rapid economic growth and at times of turmoil” (Giesen et al. 2010, p.17). Furthermore, new digitally-based technological innovations coupled with innovative business models disrupt industry after industry (cf. Streibich 2017).

However, BMI is challenging (Euchner 2016), perhaps even more challenging than other innovation types, such as product, process, service, or management innovations (Schallmo 2013). As a result, many



BMI efforts fail (Christensen et al. 2016). On the one hand, these failures might be caused by the application of business model concepts which are too static (Euchner 2016). On the other hand, even innovative, fully-functional business models may fail to produce economic return for the initiator, if they don't successfully fend off (more powerful) imitators (Casadesus-Masanell and Ricart 2011). As suggested by "blue ocean strategy", "almost any business model will perform brilliantly if a company is lucky enough to be the only one in a market" (Casadesus-Masanell and Ricart 2011, p.4). Opposing, business models are likely to fail if surrounding market conditions and competitive settings are ignored.

More generally speaking, BMI refers to two different ideas: BMI in the sense of inventing or introducing entirely new business models (Christensen et al. 2016), or BMI in the context of innovating an existing business model. In the case of innovating an existing business model, the challenge arises that business models are generally designed to resist change (Christensen et al. 2016). This sends business models down a path of a potentially predictable business model life cycle or journey (Morris et al. 2015), thereby possibly failing to unlock the true potential benefits of active BMI. This is even more troubling, as continuous re-invention of an existing business is not optional these days, rather, failing to do so will debatably lead to business failure (Frery 2017). Brettel (2015) suggests that BMI might be created through the reconfiguration of business model components and business model design types. However, innovating a business model is significantly more than the mere development of a novel service or product (Frankenberger et al. 2013).

However, neither business model development nor BMI have been exhaustively investigated. The continuous rise of information and communication technologies results in the need for ever increasingly complex business models (Osterwalder and Pigneur 2004). Thus, not just technology, but business models for AR/VR must be innovative and continuously updated as well. This innovation-process however, needs to be managed, as a mal-fitting innovation-management-process may result in a lack of capturing value from innovation (Chesbrough et al. 2002). BMI is the next frontier for business model researchers, as it "represents a novel and more holistic form of organizational innovation" (Foss and Saebi 2016, p.201). Emerging technologies, such as AR/VR, trigger BMI (Casadesus-Masanell and Ricart 2011), and BMI is an essential task when attempting to capture the benefits of technology driven transformation (Lambert and Davidson 2013). Thus, BMI is defined as: *the continuous process of the creation of new business models or innovating any of the business model components or their interplay namely: value proposition, customer relations, value creation mechanism, value capture and finances; or innovating its business function capacity as a communication tool, mediator between strategic objectives and technology, and/or as a source of competitive advantage.*

### 2.3 Research Gap and Research Contribution

van Kleef et al. (2010) suggest there hasn't been a commercial breakthrough for AR. This perception changed somewhat as Pokemon GO resulted in surging Nintendo stock value. However, Zott et al. (2011) conclude firms need to do more than just forge technology onto products and services: if they wish to realise the commercial potential, they also need to design unique business models. Thus, digital technologies such as AR/VR are drivers for BMI (Casadesus-Masanell and Ricart 2011), and business models themselves may be shaped by technological innovations (Teece 2006). This is especially true in the high velocity environment of the internet, where business models must be frequently altered to meet new challenges. However, "it is ill-understood how changing market, technology and regulation conditions generally drive revisions in business models" (De Reuver et al. 2009, p.1). This gap motivates the authors to establish how business models of technology companies are impacted by AR/VR as it will be a valuable contribution to praxis.

## 3 RESEARCH METHODOLOGY

The research objective is "to explore the impact of augmented reality and virtual reality technologies on business model innovation in technology companies in Germany". To guide the research effort, a conceptual framework was developed, and the following four research questions were formulated:

- RQ1:** What types of AR/VR technologies are technology companies in Germany adopting?
- RQ2:** How are AR/VR technologies being applied by technology companies in Germany?
- RQ3:** How do AR/VR technologies impact BMI in technology companies in Germany?
- RQ4:** How can German technology companies maximise the benefits of AR/VR technologies for BMI?

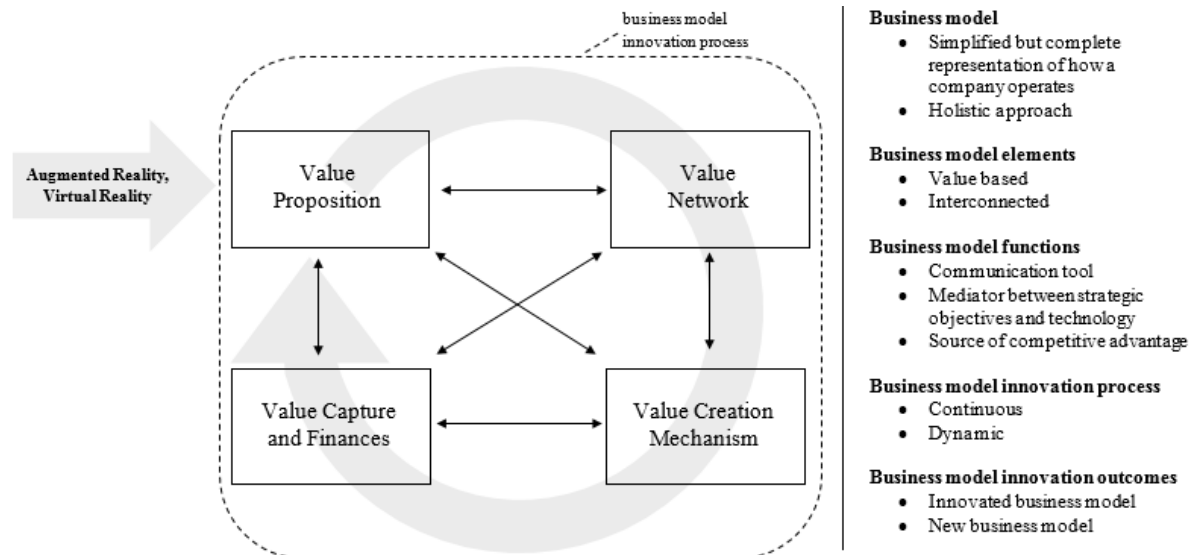

Figure 1: Conceptual Framework (adapted from Chesbrough and Rosenbloom 2002; Morris et al. 2005; Al-Debei and Avison 2010; Lüdeke-Freund 2013).

### 3.1 Philosophy

Saunders (2011) identifies three main angles to approach scientific research philosophy; namely ontology, epistemology, and axiology. Depending on the researcher's ontological position, two main knowledge-creating epistemological approaches may be taken: a positivistic or interpretivist approach. A strict positivist does not consider studying social phenomena a worthwhile effort (Bhattacharjee 2012), while strict interpretivists see no point in solely categorising phenomena in cause and effect (Holden and Lynch 2004). Axiology is concerned with the roles of the researchers' values regarding research choices (Saunders, 2011). Consequently, a researcher's philosophical approach reveals some of the researcher's values and beliefs (Saunders 2011). With reference to the two dimensions proposed by Burrell and Morgan (1979), "radical change" and "regulation", the authors hold a view of society of radical change. Furthermore, the 21<sup>st</sup> century is a time in which the pace of change accelerates, driven by technological innovations, and an ever more interconnected world. From an ontological perspective, the social world is to a large extent constructed in our minds, by observing phenomena and then attaching interpretations and meanings to them (*phenomenological*). Entrepreneurial opportunities can be created, rather than discovered, and whether a technological innovation finds extensive employment or not, ultimately is a choice made by humans. This in turn, is primarily influenced by the perceived importance that social actors give to the new technology and associated phenomena. This conviction places the author in the ontological camp of *subjectivism*. Oftentimes, and contrary to personal beliefs, technologically-driven changes unfold slower and are much less revolutionary. Similarly in this study, slower than expected growth is occurring in the AR/VR industry (Bastian 2017), and these "order-preserving-forces" perhaps indicate, that taking a regulatory view of society is a useful approach for the study. However, some reports suggest AR/VR has momentum and a market upturn is possible (Ebert et al. 2017) though the pace of change is unclear. Therefore, it's imperative to understand what is going on in practice as a practical and insightful first step (RQs 1 and 2), before understanding how AR/VR impacts BMI (RQ3) or proposing changes (RQ4). This aligns with the interpretive paradigm rather than the radical humanist paradigm (Saunders 2011). Therefore, an *interpretivist* paradigm is adopted. In summary, the study adopts a *phenomenological, subjectivist, interpretivist* philosophy.

### 3.2 Methodology

Saunders (2011, p.4) uses "methodology" to refer to the theory of how research should be undertaken, and "methods" to refer to techniques used to obtain and analyse data. Thus, having identified an interpretivist philosophical stance, from a methodology perspective, "it tends to be *nominalist, anti-positivist, voluntarist and ideographic*" (Burrell and Morgan 1979, p.28). The nominalist approach aims to obtain phenomenological insights, rather than attempting to build on positivistic science (Holden and Lynch 2004). Anti-positivism, employing qualitative methods, is a synonymous expression for the epistemological stance of interpretivism (Bhattacharjee 2012). Voluntarism postulates that humans can act independently and by freewill. The ideographic approach opposes the nomothetic approach and aims at highlighting the individual's interpretation of a phenomena, rather than striving to deduct law-like

statements about social life (Burrell and Morgan 1979) by utilising quantitative methods. Consequently, the author contends, that a *qualitative research methodology* is well suited for the research objective.

Case study research is suitable to investigate a contemporary phenomenon in its natural context and to answer “how” or “why” questions (Yin 2017). This study aims to explore the contemporary phenomenon of AR/VR and primarily strives to answer “how” questions. Therefore, this study adopts a *case study approach*. Defining and bounding the case is important (Yin 2017), so the researcher understands the chosen unit of analysis as it shapes the types of data, as well as the data collection approach (Bhattacharjee 2012). Thus, the authors identify AR/VR application deployments as the unit of analysis, to understand what impact this deployment has on BMI in technology companies. Examples of cases could be the deployment of AR/VR to innovate the marketing or training process in a company, or indeed, the creation of an entirely new firm. Thus, the study adopts a phenomenologist, subjectivist, interpretivist approach using holistic “Type 3” multiple case design (Yin 2017, p.48).

Creswell (2002) categorises qualitative data collection methods as observations; interviews; documents; and, audio-visual (AV) materials. The study notes all observations as field notes. Semi-structured interviews with key players in each case is the primary source of data. Data collected through observations or interviews is commonly done by preparing data collection protocols (Creswell 2002). An interview guide and case protocol has been designed around the four research questions, and the conceptual framework also guides interview questions. The researchers primarily examine web-based documentation, consisting of case descriptions, marketing and company background information, but will consider other relevant documentation that may emerge. AV materials are treated analogous to documents. To manage data collection, the researchers developed a BMI case study database folder, a case study log, a case study mind map, and installed Redmine Project Management System.

## 4 INITIAL FINDINGS

The author developed six criteria for pre-selecting cases: significant involvement in AR/VR; case completeness; case relevance for BMI; case general applicability; access; and relevant to Germany. An online search to identify cases applied 34 key phrases arising from literature, which when combined with the terms AR/VR, resulted in 68 English and 66 German search strings. The search took several days, resulting in 230 pages of data. Negotiating case access is time-consuming, however, interest in the research is significant due to its contemporary nature, opening doors in such innovative start-ups, as the pilot (Company #770001) and one of the largest German automotive consulting firms (#770005).

A pre-pilot test was conducted in April 2018 with a senior AR/VR developer. The interviewee chose a VR case rolled out to a client in 2017. The project created an innovative experience for exposition visitors. The project was accompanied by printed marketing materials and coordinated activities prior to/after the exposition. The pre-pilot resulted in minor changes to interview questions and ordering. The main benefit of the pre-pilot was psychological: the novice researcher’s confidence increased significantly.

The pilot case, focused on expert interviews to test and refine data collection, commenced in May 2018. In this instance, “the case” is the company itself, a Berlin-based start-up, established in 2017. Company A is seed-funded by an investment firm holding a majority share and focuses on emerging digital markets. Company A has developed innovative VR for industry collaboration but spotting the opportunities to use AR/VR to innovate its own business model, has now morphed from a product-orientated start-up into an AR/VR software as a service agency. Interviews were conducted on site with the CEO and CTO. Reflecting on the research objective and research questions, the pilot case study reveals the following. **RQ1:** Core technologies used by German organisations identified by interviewees include Microsoft HoloLens, Oculus Rift, ODB, Photon, Unity, Vuforia, and surprisingly, standard off-the-shelf PC gaming hardware. **RQ2:** AR/VR are primarily used for digital assistance, to change business processes, or to support new business models. One VR collaboration product enabled instant design review, eliminating travel needs. **RQ3:** It became very evident that AR/VR enables significant business process transformation for clients of Company A, enabling instant feedback from stakeholders, faster decision making, drastically reduces errors (see it before you build it), results in huge cost savings, and faster development cycles. **RQ4:** Initial evidence suggests organisations should (i) focus initially on projects, gaining experience with AR/VR, (ii) build a framework with re-usable elements, (iii) develop in-house, outsource non-core business (iv) run very short development cycles. Furthermore, some surprises surfaced (i) slow market development, (ii) unexpected value proposition: for some clients “innovativeness in itself” provides value (iii) a clear discrepancy between business model importance and business model competence, (iv) AR/VR requires a lot of explanation for clients.

## 5 CONCLUSIONS

The results of the pilot case and the initiation (early stages) of additional cases, lends itself to re-open the discussion on what VR/AR really is. Definitions of VR/AR are very technology-, and human-experience focussed. From a BMI perspective, it might be wise to rethink these definitions. A refined understanding of AR/VR from BMI perspectives may also emerge as an important finding from this study. When it comes to AR/VR, it seems like numerous businesses are betting on “technologically-less-ambitious” business models. Real estate agent (#770010A) states it is now common practice in the real estate industry to present 360° photographs of properties, which are for sale. These 360° photographs are not presented via a virtual reality headset; rather, numerous images are combined and linked together. The result is a virtual tour which can be taken in a web browser. From a technological viewpoint, creating 360° virtual tours in a web browser, is much less sophisticated than developing a fully-immersive virtual reality experience. A company thriving well on a “low-hanging-fruit approach” when deploying AR technology is INDE, who uses interactive, large-scale AR installations to “inspire, entertain, inform and educate”. These business examples are less focused on leading-edge technology; and seem to be primarily centred on an innovative approach to business modelling, thereby potentially underlining the observation previously made by O’Riordan et al. (2014, p.2), that “legendary firms that shape their industry structures are in fact business-model innovators”; rather than technology leaders.

## 6 REFERENCES

- Al-Debei, M.M. and Avison, D. 2010. “Developing a Unified Framework of the Business Model Concept”, *European Journal of Information Systems* (19:3), pp 359–376.
- Baden-Fuller, C. and Haefliger, S. 2013. “Business Models and Technological Innovation”, *Long Range Planning* (46:6), pp 419–426.
- Bastian, M. 2017. *Virtual Reality 2017: Das Waren Die Drei Wichtigsten Ereignisse*. <https://Vrodo.De/Virtual-Reality-2017-Das-Waren-Die-Drei-Wichtigsten-Ereignisse/> Retrieved 9 October 2018.
- Bhattacharjee, A. 2012. *Social Science Research: Principles, Methods, and Practices*. Textbooks Collection. 3. [http://scholarcommons.usf.edu/oa\\_textbooks/3](http://scholarcommons.usf.edu/oa_textbooks/3) Retrieved 9 October 2018.
- Billinghurst, M., Clark, A., and Lee, G. 2015. “A Survey of Augmented Reality”, *Foundations and Trends in Human–Computer Interaction* (8:2–3), pp 73–272.
- Brettel, M. 2015. *RWTH Aachen Video Lecture|Geschäftsmodell-Design*. [www.Management.Rwth-Aachen.De](http://www.Management.Rwth-Aachen.De) Retrieved 9 October 2018.
- Burrell, G. and Morgan, G. 1979. “Two Dimensions: Four Paradigms”, *Sociological Paradigms and Organizational Analysis*, pp 21–37.
- Casadesus-Masanell, R. and Ricart, J.E. 2011. “How to Design a Winning Business Model”. *Harvard Business Review*, (89:1/2), pp 100–107.
- Chesbrough, H. 2010. “Business Model Innovation: Opportunities and Barriers”, *Long Range Planning* (43:2-3), pp 354–363.
- Chesbrough, H. and Rosenbloom, R.S. 2002. “The Role of the Business Model in Capturing Value from Innovation: Evidence from Xerox Corporation’s Technology Spin-Off Companies”, *Industrial and Corporate Change* (11:3), pp 529–555.
- Christensen, C.M., Bartman, T. and Van Bever, D. 2016. “The Hard Truth About Business Model Innovation”, *MIT Sloan Management Review* (58:1), p 31.
- Creswell, J.W. 2002. *Educational Research: Planning, Conducting, and Evaluating Quantitative*. 4th Ed. Prentice Hall Upper Saddle River, NJ.
- De Reuver, M., Bouwman, H. and MacInnes, I. 2009. “Business Model Dynamics: A Case Survey”, *Journal of Theoretical and Applied Electronic Commerce Research*, (4:1), pp 1–11.
- Ebert, D., von der Gracht, H., Lichtenau, P. and Reschke, K. 2017. “Virtual & Augmented Reality: Neue Dimensionen der Realität”. <https://home.kpmg.com/content/dam/kpmg/pdf/2016/04/virtual-reality-exec-summary-de.PDF> Retrieved 9 October 2018.
- Euchner, J. 2016. “Business Model Innovation” *Research-Technology Management* (59:3), p 10.

- Foss, N.J. and Saebi, T. 2016. "Fifteen Years of Research on Business Model Innovation", <http://journals.sagepub.com/doi/abs/10.1177/0149206316675927>. Retrieved 9 October 2018.
- Frary, M. 2017. "Businesses Need to Reinvent or Fail", *Raconteur*, [www.Raconteur.Net/Business/Businesses-Need-To-Reinvent-Or-Fail](http://www.Raconteur.Net/Business/Businesses-Need-To-Reinvent-Or-Fail) Retrieved 9 October 2018.
- Gartner 2016. "Gartner's 2016 Hype Cycle for Emerging Technologies Identifies Three Key Trends that Organizations Must Track to Gain Competitive Advantage", <https://www.gartner.com/newsroom/id/3412017> Retrieved 9 October 2018.
- Gavish, N., Gutiérrez, T., Webel, S., Rodríguez, J., Peveri, M., Bockholt, U. and Tecchia, F. 2015. "Evaluating Virtual Reality and Augmented Reality Training for Industrial Maintenance and Assembly Tasks", *Interactive Learning Environments* (23:6), pp 778–798.
- Giesen, E., Riddleberger, E., Christner, R. and Bell, R. 2010. "When and How to Innovate your Business Model", *Strategy & Leadership* (38:4), pp 17–26.
- Greenwald, S., Kulik, A., Kunert, A., Beck, S., Frohlich, B., Cobb, S., Parsons, S., Newbutt, N., Gouveia, C., and Cook, C. 2017. *Technology and Applications for Collaborative Learning in Virtual Reality*, <http://Eprints.Uwe.Ac.Uk/32215> Retrieved 9 October 2018.
- Holden, M.T. and Lynch, P. 2004. "Choosing the Appropriate Methodology: Understanding Research Philosophy", *The Marketing Review* (4:4), pp 397–409.
- Jung, T., Chung, N. and Leue, M.C. 2015. The Determinants of Recommendations to Use Augmented Reality Technologies: The Case of a Korean Theme Park", *Tourism Management* (49), pp 75–86.
- Van Kleef, N., Noltes, J. and Van Der Spoel, S. 2010. "Success Factors for Augmented Reality Business Models", *Study Tour Pixel*, pp 1–36.
- Lambert, S.C. and Davidson, R.A. 2013. Applications of the Business Model in Studies of Enterprise Success, Innovation and Classification: An Analysis of Empirical Research from 1996 to 2010", *European Management Journal*, (31:6), pp 668–681.
- Lüdeke-Freund, F. 2013. *Business Models for Sustainability Innovation: Conceptual Foundations and The Case of Solar Energy*.
- Morris, M., Schindehutte, M. and Allen, J. 2005. "The Entrepreneur's Business Model: Toward a Unified Perspective", *Journal of Business Research* (58:6), pp 726–735.
- O'Riordan, N., O'Reilly, P., Duane, A. and Andreev, P. 2014 "Business Model Innovation: A Temporal Perspective. *The 25th ACIS, Auckland New Zealand, 8-10 December, 2014*. <http://researchrepository.ucd.ie/handle/10197/7268> Retrieved 9 October 2018.
- Osterwalder, A. and Pigneur, Y. 2004. "An Ontology for E-Business Models", *Value Creation from E-Business Models*, pp 65–97.
- Saunders, M.N. 2011. *Research Methods for Business Students, 5/E*. Pearson Education India.
- Schallmo, D. 2013. *Geschäftsmodell-Innovation*. Wiesbaden: Springer Fachmedien Wiesbaden.
- Sharma, S. and Gutiérrez, J.A. 2010. "An Evaluation Framework for Viable Business Models for M-Commerce in the Information Technology Sector", *Electronic Markets*, (20:1), pp 33–52.
- Scholz, J. and Smith, A.N. 2016. "Augmented Reality: Designing Immersive Experiences that Maximize Consumer Engagement", *Business Horizons* (59:2), pp 149–161.
- Streibich, H. 2017. *Who Needs Silicon Valley? Made in Digital Germany is Europe's Big Hope*. <http://www.europeanbusinessreview.com/Who-Needs-Silicon-Valley-Made-In-Digital-Germany-Is-Europes-Big-Hope/> Retrieved 9 October 2018.
- Superdata 2017. *Superdata Research | Games Data and Market Research*. <https://www.Superdataresearch.com> . Retrieved 9 October 2018.
- Teece, D.J. 2006. "Reflections on Profiting from Innovation", *Research Policy* (35:8), pp 1131–1146.
- Yin, R.K. 2017. *Case Study Research and Applications: Design and Methods*, 6<sup>th</sup> Edition. Los Angeles: SAGE Publications, Inc.
- Zott, C., Amit, R. and Massa, L. 2011. "The Business Model: Recent Developments and Future Research", *Journal of Management* (37:4), pp 1019–1042.

## Digital Capability Dissected

### Janne J. Korhonen

School of Science  
Aalto University  
Helsinki, Finland  
Email: [janne.korhonen@aalto.fi](mailto:janne.korhonen@aalto.fi)

### Asif Q. Gill

School of Software  
University of Technology Sydney  
Ultimo, NSW 2007, Australia  
Email: [asif.gill@uts.edu.au](mailto:asif.gill@uts.edu.au)

## Abstract

There is a growing interest in digital innovation and transformation among the researchers and practitioners. It has been recognised that being “digital” is not all about digital data and information technologies. The notion of “digital capability” has been increasingly embraced, but definitions of this concept have remained vague and elusive. A salient research question remains: what is digital capability? This question is explored in this paper from theoretical and practical perspectives in the form of a conceptual construct: the Digital Capability Framework (D-CaF). The framework distinguishes six levels and seven dimensions of digital capability. It is intended to provide a foundation to plan and execute digital capability driven innovation and transformation initiatives. Further, it helps identify and prioritise the research areas of high impact for further studies.

**Keywords** Digital capability, organizational capability, capability, framework, levels

## 1 Introduction

Helfat and Peteraf (2003) define an organizational capability as “the ability of an organization to perform a coordinated set of tasks, utilizing organizational resources, for the purpose of achieving a particular end result.” Assuming that organizational capabilities form a hierarchy (Nelson and Winter, 1982; Collis, 1994; Winter, 2003; Hine et al., 2013), this definition can be applied recursively: each level of capability would call for coordination of lower level capabilities.

Recently, the notion of digital capability has emerged, yet it has remained relatively poorly defined in the literature (Da Silva Freitas et al., 2017). An implicit consensus seems to prevail, however, that digital capability goes beyond mere IT skills (Westerman, Bonnet, and McAfee, 2012), involves digital assets (Sandberg, 2014), and creates value through digital outcomes (Srivasta and Shainesh, 2015). For the purposes of this paper, we define digital capability as *an enterprise’s capacity to integrate and utilize digital data and information technologies in its products, services, business processes, and organizational systems and practices to create added value to its constituents and beneficiaries.*

This capacity would manifest itself along distinct dimensions and be measured in terms of discernible levels of capability, each of which would coordinate and make use of capabilities one level down. In this paper, we identify the level structure and the dimensions of digital capability. An integrative literature review results in our proposed conceptual construct: the Digital Capability Framework (D-CaF) based on both theory and practice.

## 2 Levels of Capability

It has long been suggested that capabilities form a hierarchy (Nelson and Winter, 1982; Collis, 1994; Winter, 2003; Hine et al., 2013). However, there are few, if any, theoretically well-founded vertical typologies of capabilities. To suggest such a plausible basis, we draw on the Levels of Work (LoW) literature (e.g. Jaques, 1998; Rowbottom and Billis, 1987; Hoebeke, 1994; Macdonald et al., 2006; Olivier, 2010) and on the organizational capability literature. Levels of Work I–VI and the respective Levels of Capability (LoC) are summarized in Table 1 and described below<sup>1</sup>. We suggest that each level of capability calls for a progressively higher level of maturity to coordinate lower level capabilities.

LoW	Essence	LoC	Description
VI	Develop inter-organizational networks to institutionally legitimize the organization and to ensure its ecological viability.	Adaptive	The organization’s ability to enable quick responses to and proactive enactment of disruptive changes in its environment to sustain its viability and effectiveness.
V	Define and articulate the organization’s intent to provide internal coherence and to determine its position in the present and future.	Strategic	The organization’s ability to use and dynamically adjust its creative capabilities vis-à-vis the changing environment.
IV	Interrelate and coordinate a functioning set of products/services, structures, systems, internal and external relationships to maintain viability in a changing environment.	Creative	Organization-specific, dynamic bundles of systemic capabilities that underlie the organization’s strategic capability.
III	Integrate and manage a work system of people, technology, and processes to meet the current and foreseeable needs of known customers.	Systemic	Dynamic sets of interlinked routines that constitute responsive and relatively independent systemic functional wholes, or work systems.
II	Apply knowledge and experience to a particular situation within prescribed boundaries and available resources.	Routine	Relatively static routines that allow some degree of situational latitude.
I	Produce a specified output, which is largely prescribed, tangible and measurable.	Zero	Concrete and pre-specified elementary, atomic activities that underlie routine capabilities.

Table 1. Levels of capability (cf. Korhonen and Halén, 2017).

<sup>1</sup> We omit the customary Level VII, as it is of lesser practical relevance than the lower ones.

At the lowest level of work (I), the output of work is clearly prescribed (cf. Rowbottom and Billis, 1987). Work is concrete and geared towards completely specified goals in the most efficient way within defined means, technology and method (Hoebeke, 1994). Commensurate with this level are the *zero capabilities* at the lowest level of the capability hierarchy: elementary activities in the organization that are so pedestrian that they do not provide even a short-term competitive advantage (Hine et al., 2013).

Next level up (II), the response to each case of work is situational (cf. Rowbottom and Billis, 1987) and depends on judgment. Specific requirements of direct action tasks at Level I are moulded into minimal critical specifications regarding the output, the procedures, the tools and the input (Hoebeke, 1994). *Routine capabilities* at this level “reflect an ability to perform the basic functional activities” (Collis, 1994). These first-level capabilities (Hine et al., 2013) are static routines that the organization does at any given time given its stock of factors of production (Nelson and Winter, 1982). They are focused on everyday subsistence tasks of the organization using current resources (Hine et al., 2013).

At level III, work aims at systematic provision (Rowbottom and Billis, 1987), addressing the varying needs of today as well as those of tomorrow. *Systemic capabilities* at this level are dynamic functional capabilities (Hine et al., 2013) that pertain to “repeated process or product innovations, manufacturing flexibility, responsiveness to market trends and short development cycles” (Collis, 1994). They determine the period-by-period augmentation or diminution of the organization’s factors of production, which are fixed in short term (Nelson and Winter, 1982). These capabilities are focused on change and use less-patterned routines and more specialized resources (cf. Hine et al., 2013).

Work at level IV entails comprehensive provision (Rowbottom and Billis, 1987) – the means and ends of underlying work systems are adjusted to reshape profitability within the overall business purpose. *Creative capabilities* at this level operate to extend, modify or create ordinary capabilities (cf. Winter, 2003). These dynamic learning capabilities (Hine et al., 2013) are about organization-specific creative ability – “the more metaphysical strategic insights that enable firms to recognize the intrinsic value of other resources or to develop novel strategies before competitors” (Collis, 1994).

At level V, the scope of work extends to a framework that specifies a general field of need (cf. Rowbottom and Billis, 1987). The focus is on shaping and managing the organization vis-à-vis its environment (Macdonald et al., 2006). *Strategic capability* at level V would refer to the organization’s ability to use its creative capabilities. As such, the notion is comparable to that of organizational capability as defined by Moingeon et al. (1998) and Kangas (1999).

Level VI represents multi-field coverage (Rowbottom and Billis, 1987), where the task is to ensure that the output covers the whole complex of fields of need. Complexity is not so readily contained, but the “great organizational divide” is crossed to a “whole world” view and the perspective is widened from an individual organization to the larger ecosystem. *Adaptive capabilities* at level VI enable the organization to quickly respond to and effectuate change in its environment to ensure its effectiveness in the shifting context. They enable quick creation of new knowledge (cf. Eisenhardt and Martin, 2000), capacity for continuous innovation (Hamel and Välikangas, 2003; Gill, 2015), and improvised response to rapid, unpredictable, and novel events (cf. Pavlou and Sawy, 2010). As high uncertainty, high risk environments do not allow time to respond effectively, these capabilities often rely on the network (Villar and Miralles, 2014).

### 3 Discovery of Dimensions of Digital Capability

#### 3.1 Digital Dimensions: Literature Review

In their Digital Capability Framework, Uhl et al. (2014) identify six core capabilities for organizations to become sustainable and successful: 1) Innovation capability, 2) Transformation capability, 3) IT Excellence, 4) Customer centricity, 5) Effective knowledge worker, and 6) Operational excellence.

Soule et al. (2016) identify three clusters of digital capability: 1) Customer experience: “using technology to address customer expectations or integrate digital channels for customer communication and interaction,” 2) Operations efficiency: “optimizing, automating, or streamlining internal processes with more precise data,” and 3) Workforce enablement: “using digital tools to facilitate collaboration across boundaries, develop skills, or share knowledge across the organization.”

In their study of 150 executives in fifty companies around the world, Westerman, Bonnet, and McAfee (2014) found that “Digital Masters” excel in two critical dimensions: in leveraging technology (digital capabilities) and in leading change (leadership capabilities). The former pertains to how the organization 1) engages with customer, 2) excels in operational processes, and 3) innovates and applies new business models. The latter is about vision, engagement, and technology leadership.



Tumbas, Berente and vom Brocke (2017) interviewed 35 Chief Digital Officers and identified three domains in which successful CDOs build digital capabilities to drive business value: 1) digital innovation, 2) data analytics, and 3) customer engagement.

Matt, Hess, and Benlian (2015) identify four dimensions of digital transformation strategies: 1) use of technologies (attitudes towards new technologies as well as ability to use these technologies), 2) changes in value creation (the extent to which the use of new technologies has impact on core business activities), 3) structural aspects (such as placement of digital activities in the organizational structure), and 4) financial aspects (both a driver of and a bounding force of the transformation).

Digital business frameworks have also been proposed in industry. IBM Institute for Business Value conducted an early study on digital transformation (Berman and Bell, 2011), identifying the following digital transformation capabilities: 1) Business model innovation, 2) Customer and community collaboration, 3) Cross-channel integration, 4) Insights from analytics, 5) Digitally enabled supply chain, and 6) Networked workforce.

The digital business framework by SAP (2015) has the following five pillars: 1) Customer experience across all channels 2) Supplier collaboration, 3) Core business processes, 4) Workforce engagement, including employees and contractors, 5) Assets and the Internet of Things.

McKinsey's Digital Quotient® (cf. Catlin, Scanlan, and Willmott, 2015) diagnostic features 22 digital capabilities along six dimensions: 1) data-driven digital insights, 2) integrated customer experience, 3) digital marketing, 4) digitally-enabled operations, 5) next-gen technology, and 6) digital enablers (digital strategy, culture, and organization).

Based on the literature, we identified seven dimensions of digital capability as summarised in **Error! Reference source not found..**

Dimension	Uhl et al. (2014)	Soule et al. (2016)	Westerman, et al. (2014)	Tumbas, et al. (2017)	Matt, Hess, and Benlian (2015)	IBM: Berman and Bell (2011)	SAP (2015)	McKinsey: Catlin et al. (2015)
[IT] Information Technology	x				x			x
[DA] Data and Analytics				x		x	(x) <sup>2</sup>	x
[CE] Customer Engagement	x	x	x	x		x	x	x <sup>3</sup>
[CC] Collaboration and Connectivity		x <sup>4</sup>				x	x	
[BP] Business Process Excellence	x	x	x			x	x	x
[KW] Facilitation of Knowledge Work	x	x				(x) <sup>5</sup>	x	
[DB] Digitization of Business			x	x <sup>6</sup>	x <sup>7</sup>			

Table 2. Seven dimensions of digital capability derived from the literature.

<sup>2</sup> Assets and the Internet of Things.

<sup>3</sup> Manifested in the integrated customer experience and digital marketing dimensions.

<sup>4</sup> Addressed in Workforce enablement.

<sup>5</sup> This aspect is subsumed under Networked workforce, but not its core.

<sup>6</sup> Digital innovation: "Building digital capabilities for intense experimentation, pursuing strategic changes to organizational processes, products, services and business models."

<sup>7</sup> Changes in value creation.

### 3.2 Digital Dimensions: Practitioners Perspectives

To avoid any pre-emption and academic bias, we facilitated a discovery workshop, independent of the literature review, with industry experts in Sydney to define the concept of “Digital”. It took place on November 30, 2016, and was attended by twelve senior industry leaders and experts. In the workshop, the following themes, underpinning the concept of digital (capability), emerged:

- *Value Proposition*: Digitising the physical (e.g. less real state) and focusing more on business execution and outcomes (e.g. business agility, save time, ease of operations).
- *Digital Interactions*: Smooth and seamless multi-channel (e.g. omni-channel) customer experience or interactions or workflow of a networked business.
- *Connectivity*: Access from anywhere and anytime.
- *Digital Business*: Customer-centric digital business strategy, models, operating models, capabilities, processes, products and services.
- *Analytics and Information Management*: Sense-making and getting smart through effective and efficient analytics and information management for timely actionable insights.
- *Digital People*: Digital talent (e.g. competency), culture and mindset.
- *Digital Innovation and Transformation*: It is about digital innovation and transformations rather keep doing incorrect things differently.
- *Digital Technology*: Digital technology such as Agile, Analytics, APIs, Big Data, Blockchain, Cloud, IoT, Mobile, Social and Web enable above mentioned elements.

The findings of the workshop were found to be well in line with the literature study. Both academic and practitioners had similar understanding and perception of the digital dimensions.

It was found that the Information Technology dimension and Digital Technology theme both highlight the central role of (information) technology in the digital capability, albeit they differ in their focus: the former is more about the use and management of IT rather than technology itself. The Data and Analytics dimension seems to be identical to the Analytics and Information theme: how data and information are translated to actionable insights. The Customer Engagement dimension would be best reflected in the Digital Interactions theme, while the Collaboration and Connectivity dimension seems commensurate with the Connectivity theme. The Business Process Excellence and Facilitation of Knowledge Work dimensions that were strongly identified in the literature study did not emerge as clearly as themes in the roundtable discussion. However, they can be seen subsumed by the broad theme of Digital Business. Finally, the Digitizing Business dimension seems to cover aspects from both the Value Proposition and Digital Business themes.

## 4 Digital Capability Conceptual Framework

Based on the levels and dimensions identified and discovered above, we constructed a 6 x 7 conceptual Digital Capability Framework (D-CaF), as summarized in Table 3. Each of the dimensions is discussed by each level in the subsections below.

	IT	DA	CE	CC	BP	KW	DB
VI	Adaptive	Prescriptive	Real-time context	Coadunation	Intelligent BPM	Real-Time Decision-Making	Digitl Platform
V	Strategic Value	Predictive	Individualized	Collaboration	Inter-Enterprise BPM	Strategic Work	Digital Business Model
IV	Enablement	Descriptive	Profiling	Coordination	Collaborative BPM	Collaboration Work	Digital Product Line / Service Offering
III	Service	Reporting	Segmented	Cooperation	Organizational BPM	Expert Work	Digital Product / Service
II	Cost	Aggregation	Opt-in	Communication	Operational BPM	Integration Work	Digital Components
I	No IT	Query	Solicitation	Coexistence	Transaction Processing	Transaction Work	Non-digital

Table 3. The Digital Capability Framework (D-CaF).

## 4.1 Information Technology (IT)

The information technology dimension (IT) pertains to the extent to which the organization is able to leverage information technology and other technologies to support, enable, or drive its work.

The application of IT in organizations has evolved through recognizable eras (Ross and Feeny, 1999; Peppard and Ward, 2004). The respective capability and the institutional level of response seem to have transpired in sync with this evolution.

At the level of zero capabilities (I), IT has no formal presence, but users are purchasing and maintaining systems in a non-integrated ad-hoc manner (Curley, 2007).

At Level II, IT is formally organized to provide utility to the business, but it is viewed purely as a cost centre with key focus on reducing total cost of ownership and increasing return on investment (Curley, 2007). Operational efficiency is improved by automating information-based processes (Ward and Peppard, 2002). Basic IT processes are established and documented (Curley, 2007).

At the systemic (III) level, these routines are interlinked to a systemic functional whole, typically an IT unit that provides business with reliable services (Curley, 2007). The Management Information Systems (Peppard and Ward, 2004) at this level are relatively independent and specific to the work system, whose information requirements they satisfy.

Level IV denotes a shift from the supply-side to the demand-side (sensu Broadbent and Kitzis, 2005). The creative capabilities are about bundling systemic IT and business capabilities in VRIN<sup>8</sup> ways to create future value. Strategic Information Systems (Ward and Peppard, 2002) are leveraged to improve competitiveness by changing the nature or conduct of business. IT understands the business and proactively proposes solutions to key opportunities and problems (Curley, 2007). The emphasis is on IT effectiveness: maximizing opportunities from IT resources. IT is perceived as investment centre (Curley, 2007) that is focused on IT effectiveness: maximizing opportunities from IT resources.

Along the IT dimension, the strategic capability pertains to the ways in which the creative IT capabilities are built into the very fabric of the organization, enabling it to continuously identify, obtain and sustain IT-based competitive advantage (cf. organizational IS capability, sensu Ward and Peppard, 2002). IT is seen as a value centre (Curley, 2007): business case benefits and value of IT investments can be predicted with high confidence.

Adaptive IT capabilities pertain to how IT can be leveraged to sense and respond as well as to anticipate and pre-empt disruptive changes in the environment (Gill et al., 2014). The organization is “managed by wire” (Haeckel, 1999): IT is used to sense and to make sense of information and to enact pertinent actions more effectively. IT is intrinsically intertwined with business throughout the adaptive cycle of sensing, interpreting, deciding, and acting on data and information.

## 4.2 Data and Analytics (DA)

The Data and Analytics dimension (DA) is about the extent to and way in which the organization gathers, integrates, analyses and acts upon data and information.

At the zero level (I), data is not systematically collected and managed, but resides in task-specific silos,

At the level of routine capabilities (II), data is collected to support procedural decision-making and execution of workflows.

At the systemic (III) level, no advanced analytics are required for foresight. Data is integrated in data marts that typically support operational reporting that informs control decisions, such as assignment of resources to workloads, occur once and are re-used many times, often in a highly-automated system that guides the decision-makers (Saxena and Srinivasan, 2013).

The data challenge at the creative (IV) level calls for the creation of enterprise-wide infrastructure that supports descriptive analytics solutions: what has happened in the past rather than predicting the future. These Analytics 1.0 (Davenport, 2013) solutions typically support decisions to change capacity and set targets with a mix of a few repeatable and process-driven analyses that may be automated and ad-hoc analyses conducted upon request (Saxena and Srinivasan, 2013).

---

<sup>8</sup> Valuable, rare, inimitable, and non-substitutable (Barney, 1991).

The strategic (V) data and analytics capabilities pertain to Analytics 2.0 (Davenport, 2013): collecting “Big Data” from the organization’s transaction systems as well as from social media platforms, smart sensors, mobile “digital footprints”, etc. and providing in-depth predictive analyses that support strategic decisions that have long time-frames and large impact (Saxena and Srinivasan, 2013).

The adaptive (VI) D&A capabilities are embedded into virtually all operational and decision processes at the front lines of business. To enable quick decisions and actions without human intervention, Analytics 3.0 (Davenport, 2013) is prescriptive, automated and based on real-time stream computing.

### **4.3 Customer Engagement (CE)**

The Customer Engagement dimension (CE) is conceptualized as the extent to which customers are known; data on them are collected, integrated, and analysed; marketing messages can be targeted; and feedback be collected and integrated in business processes.

At the zero level (I), customer engagement takes place in encounters upon service interactions, but feedback of the customer on these interactions is not systematically collected nor integrated with relevant processes such as product/service development. There is also no effort to know about the identity of customer, to gather data on customers, or to target market messages to specific audiences.

Routine level (II) CE capabilities include ability to collect feedback from existing customers, to capture basic qualitative customer data (e.g. email address), and to address marketing to an opt-in audience.

At the systemic level (III), basic demographic data on customers is captured e.g. through site registration or social authentication, and integrated across channels to a single customer view. Customer segments can be formed, targeted for marketing, and surveyed for feedback.

Creative level (IV) CE starts with more nuanced customer profiles that can be created based on loyalty programs, data flows from transactions, indicated preferences, social profile information, etc. This data can be used to personalize marketing messages and customer experience. Customer behaviour and preferences can be analysed and forecast to inform new product/service design.

At the strategic level (V), customer understanding is based on demographic, social, transactional, and behavioural data compiled from registration/authentication data, transaction data, and customer engagement tools. The data informs marketing messages and CE at the level of a “segment of one.”

Adaptive level (VI) customer engagement is about real-time rendering of individual customer experience, driven by prescriptive analytics and optimization.

### **4.4 Collaboration and Connectivity (CC)**

The Collaboration and Connectivity dimension (CC) pertains to how digital data and technologies facilitate technical connectivity and collaborative relationships with external parties.

At the zero level (I), the parties coexist in relative isolation from each other. There are no formal links or roles pertaining to communication or collaboration between the parties.

At level II, connection between collaborating parties is about dialogue and common understanding (Hogue, 1993) to explore interests and to create a base of support (Gajda, 2004). Networking structure is non-hierarchical and based on loose communication links and roles (Hogue, 1993). Decision-making is minimal (Hogue, 1993). There is very little interpersonal conflict (Gajda, 2004).

At level III, fully autonomous collaborating parties share information to support each other’s organizational activities (Bailey and Koney, 2000). They match their needs and coordinate with each other to limit duplication of services (Hogue, 1993). A central body of people works as communication hub, within which the roles are somewhat defined. The network links are semi-formal and advisory in nature. (Hogue, 1993). Some collaboration tasks and strategies are identified (Gajda, 2004).

At level IV of Collaboration and Coordination, “otherwise autonomous groups align activities, sponsor particular events, or deliver targeted services in pursuit of compatible goals” (Bailey and Koney, 2000). The collaborating parties share resources to address common issues and merge them to create something new (Hogue, 1993). Links are formalized, roles are defined (Hogue, 1993); communication systems and group decision-making mechanisms are in place (Gajda, 2004). Strategies and tasks are developed and maintained (Gajda, 2004), and the group may leverage or raise money (Hogue, 1993).

At the strategic level (V), the collaborating parties work collectively through common strategies, and each party relinquishes some degree of autonomy for the joint-purpose (Bailey and Koney, 2000). They develop commitment for a minimum of three years (Hogue, 1993) and merge resources to create or support something new (Gajda, 2004). All members are involved in formal decision-making. Roles and time are defined, and links are formal with written agreements. The group develops new resources and joint budget. (Hogue, 1993).

At the adaptive level (VI), the collaborating parties form a unified “coadunation” relationship, in which “member organizations unite within an integrated structure to the extent that one or all relinquish their autonomy in favour of a surviving organization” (Bailey and Koney, 2000). They build interdependent systems to address issues and opportunities (Hogue, 1993). Strategies and tasks are permanently reorganized, highly formal, and legally complex (Gajda, 2004). Decision-making is based on consensus. Resources and joint budgets are developed. (Hogue, 1993).

#### **4.5 Business Process Excellence (BP)**

The business process excellence dimension (BP) is about the extent to which business process management and related technologies help automate, integrate, and optimize business processes.

Automation of business processes at the zero level of capability (I) is about performing and supporting day-to-day routine transactions. Transaction Processing Systems (TPS) such as order processing system or machine control are often very critical for the business (Laudon and Laudon, 2017).

At level II, workflow management or business process management systems are used to connect activities in relatively consistent and contained “operational business processes” (cf. Weske, 2007).

At level III, high-level “organizational business processes” (Weske 2007) often cross multiple domains. They can be implemented as either a hierarchy of traditional workflows or as a managed network of participant-specific processes (sensu third wave of BPM as put forward by Smith and Fingar, 2003).

At level IV, the process automation is extended to collaborative end-to-end business processes that involve a number of parties intra- or inter-enterprise. The required business process choreography (Smith and Fingar, 2003) can be achieved through executable BPMN (Business Process Modeling Notation) on sophisticated business process management systems (BPMS) or through formalisms specifically geared to irregular collaborative business processes, such as role activity diagrams (RAD; Ould, 2005) human interaction management systems (HIMS; Harrison-Broninski, 2005).

At the strategic level (V), business process management is integrally embedded in the digital enterprise and is extended throughout the end-to-end value chain to customers, suppliers, distributors and other stakeholders (Rosemann et al., 2006).

The adaptive level (VI) business process management is data-driven and analytics-infused. Real-time business activity monitoring on large volumes of event data is used to continually optimize business processes. Big Data technologies on a Cloud-based architecture are particularly amenable to enable such intelligent BPM (iBPM; sensu Gartner) (Vera-Baquero, Colomo-Palacios, and Molloy, 2016).

#### **4.6 Knowledge Work Support (KW)**

The knowledge work support dimension (KW) pertains to how and to what extent information technology supports the work of knowledge workers.

Knowledge workers define, analyse, create, maintain, manage, and advise on information resources (Davenport and Prusak, 1997). Davenport (2015) distinguishes four types of knowledge work: transaction work, integration work, expert work, and collaboration work.

Transaction work has a low degree of collaboration and judgment and can typically be scripted. As such, it would pertain to the zero level of capability (I). Computer-based applications can be used to bring the task-specific information to the fingertips of the worker, while measuring the work productivity (Davenport, 2015).

In integration work at the routine level (II), the process is relatively structured and documented for guidance as “standard operating procedures,” which the workers have more time and discretion to consult (Davenport, 2015).

Expert work at the systemic level (III) is highly autonomous and discretionary. Instead of specifying detailed aspects of the workflow, information systems support this type of work best through templates, sample outputs, and high-level guidelines (Davenport, 2015).

Collaboration work seems to be called for at Level IV. It is very unusual for this type of work to be fully mediated and structured by a computer (Davenport, 2015). The knowledge workers are better assisted through “informating” (sensu Zuboff, 1985) rather than automating the processes.

At level V, information systems can support work through hypotheses and tests that help refine the business concept (Cashman and Stroll, 1987). These “flexible organization design systems” must be flexible in the face of constantly changing and complex organizational systems (ibid.).

The adaptive level (VI) adds the requirement of real-time response. This would call for algorithm-based automated decision-making that augments, and partly substitutes, human knowledge work.

## 4.7 Digitization of Business (DB)

The digitization of business dimension (DB) pertains to the extent to which digital data and technologies are embedded in the products, services, and the business model of the enterprise.

At the zero level (I), products are physical and services delivered through non-digital channels. Digital data and technologies are limited to back office support, not interfacing the customer.

At the routine level (II), products have digital components (e.g. a car navigator with updates over the Internet) and services can be accessed through digital channels (e.g. online reservations).

Systemic level (III) digital products (e.g. music, e-books, software) and services (e.g. information services, digital self-service) are fully digital, i.e. they can have a definable market without a physical manifestation or container.

At the creative level (IV), not only some discrete products and services are digital, but entire product lines (e.g. e-books) or service offerings (e.g. digital travel agency) are digital.

At the strategic level (V), digitization is extended to the very business model, i.e. the entire business is purely digital. Examples would include pure-digital e-banks, on-demand video libraries, Cloud infrastructure providers with fully-digital provisioning, etc.

Finally, at the adaptive level (VI), the digital business model is based on digital platforms that provide a substrate for other business to build “planks” on.

## 5 Conclusion

In this paper, we have constructed the Digital Capability Framework (D-CaF), featuring six levels and seven dimensions. The framework is intended to help managers and other practitioners assess and address digital capability requirements to inform digital transformation initiatives. Providing further insights into the types of competencies, systems, structures, and respective investments that will be needed at a given stage of development, D-CaF has potential to inform the development of digital capability. The future work includes devising an interview protocol and/or a survey instrument to operationalise and measure digital capability against the vertical scale along different dimensions.

## 6 References

- Bailey, D., and Koney, K. 2000. *Strategic alliances among health and human services organizations: From affiliations to consolidations*. Thousand Oaks: Sage.
- Barney, J. 1991. “Firm resources and sustained competitive advantage,” *Journal of Management* (17:1), pp 99-120.
- Berman, S.J., and Bell, R. 2011. “Digital transformation: Creating new business models where digital meets physical,” IBM Global Business Services Executive report, IBM Institute for Business Value.
- Broadbent, M., and Kitzis, E. S. 2005. *The New CIO Leader*. Boston, MA: Harvard Business School Press.

- Cashman, P.M., and Stroll, D. 1987. "Achieving sustainable management of complexity: A new view of executive support" (3), pp 147-173.
- Catlin, T., Scanlan, J., and Willmott, P. 2015. "Raising your Digital Quotient," *McKinsey Quarterly*, June 2015.
- Collis, D. 1994. "How valuable are organizational capabilities?" *Strategic Management Journal* (15:S1), pp 143-153.
- Curley, M. 2007. "Introducing an IT Capability Maturity Framework." In: Filipe, J., Cordeiro, J., and Cardoso, J. (Eds.): *Enterprise Information Systems: 9<sup>th</sup> International Conference, ICEIS 2007*, Funchal, Madeira, June 2007, Revised Selected Papers, pp 63-80.
- Da Silva Freitas, J.C. Jr., Maçada, A.C.G., and Brinkhues, R.A. 2017. "Digital capabilities as key to digital business performance," *AMCIS 2017*, Paper #27.
- Davenport, T.H., and Prusak, L. 1997. *Information Ecology: Mastering the Information and Knowledge Environment*. Oxford University Press.
- Davenport, T.H. 2013. "Analytics 3.0," *Harvard Business Review*, (91:12).
- Davenport, T.H. 2015. "Process Management for Knowledge Work." In: vom Brocke, J., and Rosemann, M. (Eds.): *Handbook on Business Process Management 1*, International Handbooks on Information Systems, Second Edition.
- Gajda, R. 2004. "Utilizing collaboration theory to evaluate strategic alliances," *American Journal of Evaluation* (25:1), pp 65-77.
- Gill, A.Q. 2015. *Adaptive cloud enterprise architecture*. World Scientific Publications.
- Gill, A.Q., Smith, P., Beydoun, G., and Sugumaran, V. 2014. "Agile enterprise architecture: a case of a cloud technology-enabled government enterprise transformation," *PACIS 2014*, Chengdu, China.
- Haeckel, S. H. 1999. *Adaptive Enterprise: Creating and Leading Sense-and-Response Organizations*. Boston, MA: Harvard Business School Press.
- Hamel, G., and Välikangas, L. 2003. "The quest for resilience," *Harvard Business Review*, (8:9).
- Harrison-Broninski, K. 2005. *Human Interactions: The Heart and Soul of Business Process Management*. Tampa, FL: Meghan Kiffer Press.
- Helfat, C.E. and Peteraf, M.A. 2003. The Dynamic Resource-Based View: Capability Lifecycles, *Strategic Management Journal*, 24(10), 997-1010.
- Hine, D., Parker, R., Pregelj, L., and Verreynne, M.-L. 2013. "Deconstructing and reconstructing the capability hierarchy," *Industrial and Corporate Change* (23:5), pp 1299-1325.
- Hoebeke, L. 1994. *Making Work Systems Better: A Practitioner's Reflections*. John Wiley & Sons.
- Hogue, T. 1993. *Community-based collaboration: Community wellness multiplied*. Oregon Center for Community Leadership, Oregon State University.
- Jaques, E. 1998. *Requisite Organization: A Total System for Effective Managerial Organization and Managerial Leadership for the 21st Century*. Rev. 2<sup>nd</sup> edition. Baltimore, MD: Cason Hall & Co.
- Korhonen, J.J., and Halén, M. 2017. "Enterprise architecture for digital transformation," *The 19th IEEE Conference on Business Informatics (CBI 2017)*, 24-26 July, Thessaloniki, Greece.
- Laudon, K.C. and Laudon, J.P. 2017. *Management Information Systems: Managing the Digital Firm*. 15th ed. Harlow, UK: Pearson Education Limited.
- Macdonald, I., Burke, C., and Stewart, K. 2006. *Systems Leadership: Creating Positive Organizations*, Aldershot, UK: Gower.
- Matt, C., Hess, T., and Benlian, A. 2015. "Digital transformation strategies," *Business and Information Systems Engineering* (57:5), pp 339-343.
- Mulligan, P. 2002. "Specification of a capability-based IT classification framework," *Information & Management* (39), pp 647-658.

- Nelson, R., and Winter, S. 1982. *An Evolutionary Theory of Economic Change*, Cambridge, MA: Belknap Press.
- Olivier, A. 2013. *Organisational Design: What Your University Forgot to Teach You*. Xlibris.
- Ould, M.A. 2005. *Business Process Management: A Rigorous Approach*. Meghan Kiffer Press.
- Pavlou, P., and El Sawy, O.A. 2010. "The 'third hand': IT-enabled competitive advantage in turbulence through improvisational capabilities," *Information Systems Research*, (21:3), pp 443-471.
- Peppard, J., and Ward, J. 2004. "Beyond strategic information systems: Towards an IS capability," *Journal of Strategic Information Systems* (13), 167-194.
- Rosemann, M., de Bruin, T., and Power, B. (2006). "A Model to Measure Business Process Management Maturity and Improve Performance." In: Jeston, J., and Nelis, J. (2006): *Business Process Management*, Chapter 27. Butterworth-Heinemann.
- Ross, J.W., and Feeny, D.F. 1999. "The evolving role of the CIO." In: R. W. Zmud (Ed.): *Framing the Domains of IT Management, Projecting the Future... Through the Past*, Chapter 19, pp 385-402. Cincinnati, OH: Pinnaflex Educational Resources.
- Rowbottom, R., and Billis, D. 1987. *Organisational Design: The Work-Levels Approach*, Aldershot, UK: Gower.
- Sandberg, J. 2014. *Digital Capability: Investigating Coevolution of IT and Business Strategies*. Doctoral Dissertation. Umeå University.
- Saxena, R., and Srinivasan, A. 2013. *Business Analytics: A Practitioner's Guide*. New York: Springer.
- SAP. 2015. "Value creation in a digital economy: Adapt or die in a digital world where the consumer is in charge," SAP white paper. SAP.
- Smith, H., and Fingar, P. 2003. *Business Process Management: The Third Wave*. Tampa, FL: Meghan Kiffer Press.
- Soule, D.L., Puram, A.D., Westerman, G.F., and Bonnet, D. 2016., "Becoming a digital organization: The journey to digital dexterity," MIT Center for Digital Business Working Paper #301.
- Srivastava, S.C., and Shainesh, G. 2015. "Bridging the Service Divide Through Digitally Enabled Service innovations; Evidence from Indian Health Care Service Providers," *MIS Q*, (39:1), pp A1-A19.
- Tumbas, S., Berente, N., and vom Brocke, J. 2017. "Three types of chief digital officers and the reasons organizations adopt the role," *MIS Quarterly Executive* (16:2), 121-134.
- Uhl, A., Born, M., Koschmider, A., and Janasz, T. 2014. "Digital capability framework: A toolset to become a digital enterprise." In Uhl A., and Gollenia, L. A. (Eds.): *Digital Enterprise Transformation: A Business-Driven Approach to Leveraging Innovative IT*. Routledge.
- Vera-Baquero, A., Colomo-Palacios, R., and Molloy, O. 2016. "Real-time business activity monitoring and analysis of process performance on big-data domains," *Telematics and Informatics* (33:3), pp 793-807.
- Villar, E.B., and Miralles, F. 2014. "Beyond resources and dynamic capabilities during disaster response: Response organizations in turbulent and networked environment: The case of a disaster response organization's simulated response to chemical spill disaster," *2014 International Conference on Humanoid, Nanotechnology, Information Technology, Communication and Control, Environment and Management (HNICEM)*, IEEE.
- Ward, J., and Peppard, J. 2002. *Strategic Planning for Information Systems*. Wiley.
- Weske, M. (2007). *Business Process Management: Concepts, Languages, Architectures*. Springer.
- Westerman, G., Bonnet, D., McAfee, A. 2014. *Leading Digital: Turning Technology into Business Transformation*. Boston, MA: Harvard Business Review Press.
- Winter, S. 2003. "Understanding dynamic capabilities," *Strategic Management Journal* (24:10), pp 991-995.
- Zuboff, S. 1985. Automate/informate: the two faces of intelligent technology, *Organizational Dynamics* (14:2), pp 5-18.



## Acknowledgements

The author Janne J. Korhonen wants to thank The Foundation for Economic Education in Finland for a travel grant that partly enabled writing this contribution.

## Copyright

**Copyright:** © 2018 authors. This is an open-access article distributed under the terms of the [Creative Commons Attribution-NonCommercial 3.0 Australia License](#), which permits non-commercial use, distribution, and reproduction in any medium, provided the original author and ACIS are credited.

# M-government Adoption Research Trends: A Systematic Review

## **Thamer Alshammari**

Faculty of Information Technology  
Monash University  
Melbourne, Australia  
Email: thamer.alshammari@monash.edu

## **Yen Cheung**

Faculty of Information Technology  
Monash University  
Melbourne, Australia  
Email: yen.cheung@monash.edu

## **Chris Messom**

Faculty of Information Technology  
Monash University  
Melbourne, Australia  
Email: christopher.messom@monash.edu

## **Abstract**

Mobile government (m-government) adoption is a relatively new area in the field of information systems which has only started to attract research attention in the last few years. This paper presents a systematic review of m-government adoption to investigate its current and future research directions. This paper reviews 30 studies that were published in scientific journals and conferences during the last five years on the topic of m-government. It analyzes the research in terms of research methodology, theories used, stakeholders, limitations and recommendations. Results of this paper indicate that the quantitative approach is the most commonly used methodology and the Technology Acceptance Model is the most prevalent theory used in m-government research. A majority of reported limitations of the published research are related to samples and generalizability. Following an analysis of the results, more focus on stakeholders' roles in m-government adoption is suggested and this is believed to be a significant agenda for future research in this area.

**Keywords** m-government, adoption, stakeholders, literature review.

## 1 Introduction

M-government is defined as the delivery of public services including transactions on mobile devices like mobile phones, pagers and personal digital assistants (Misra 2009). To enhance their services to reach a wider population, governments around the world have adopted mobile technology as a new channel for the provision of services (Ahmed and Khalid 2017). For example, a main benefit of m-government is that public sector workers, like law enforcement officials and home healthcare providers, can complete some tasks with mobile devices whilst they are out in the field (Nguyen et al. 2015). On the other hand, citizens can benefit from real-time information access and personalized services (Abu-Shanab et al. 2016).

The literature shows a gap between governmental efforts to use mobile devices as platforms for providing public services and the adoption of these services by citizens. Scholars stated that many governments around the world have realized the importance of providing public services via mobile devices and have implemented m-government (Glood et al. 2016b). On the other hand, some studies have shown that the current adoption level of m-government by citizens is low in many countries, such as India (Saxena 2017) and Tanzania (Mandari et al. 2017). Furthermore, the World Bank (2012) reported that although about half of the world's population use the internet regularly, most fail to utilize m-government services (Alsbaiheen and Love 2015).

Recent studies have started investigating the adoption of m-government (Alotaibi and Roussinov 2016; Wang 2014). Current m-government research has considered the roles of stakeholders, like citizens and governments (Wang 2014). However, it is believed that other types of stakeholders particularly those who are involved in decision-making and those in the private sectors (e.g. mobile service providers) also play a significant role in m-government adoption (Carrol 2006). In this paper, we discuss the importance of different stakeholders such as business practitioners as well as government officials and citizens in m-government adoption. This study aims to conduct a systematic review of the adoption of m-government by examining and analyzing empirical studies that investigated the adoption of m-government in terms of publication dates, methodologies, theories, stakeholders, limitations and recommendations. Only empirical studies were included in the analysis so we can analyze the papers based on the type of research methodology used.

The results of this study will help researchers understand the development of studies that investigated the adoption of m-government, as well as future research trends in this area. The remainder of this paper is structured as follows. Firstly, it presents the literature search approach. Secondly, it reviews and analyzes the studies found in the literature. Thirdly, it discusses the main findings and future directions. Finally, it provides concluding remarks on the research.

## 2 Literature search approach

A combination of sets of keywords were used to search for the relevant studies. The keywords are as follows: "adoption of m-government", "adoption of mgovernment", and "adoption of mobile government" using the OR operator in Google Scholar, as it is the most powerful and comprehensive search engine for academic papers (Ortega 2015). The search setting was customized to search for studies that were published between 2012 and 2017. There are two reasons for choosing this period:

- (1) Due to the recent rapid changes in m-government services and the limited availability of m-government services seven years ago only the above-mentioned period is included. According to Galvez and Youngblood (2016) in 2012, governments in some countries rapidly implemented m-government services;
- (2) By 2012, mobile phones became the most popular devices to access the internet (Lee and Rotoloni 2013).

A total of 183 studies were retrieved based on the search criteria from scholarly journals and conferences. After the process of narrowing down the studies to those which empirically investigated the adoption of m-government, 30 studies were found to be relevant (see Figure 1). It is worth mentioning that, these studies are published in the Information Systems and Public Administration disciplines. These studies were reviewed and detailed information was extracted for analysis, which is discussed in the following section.

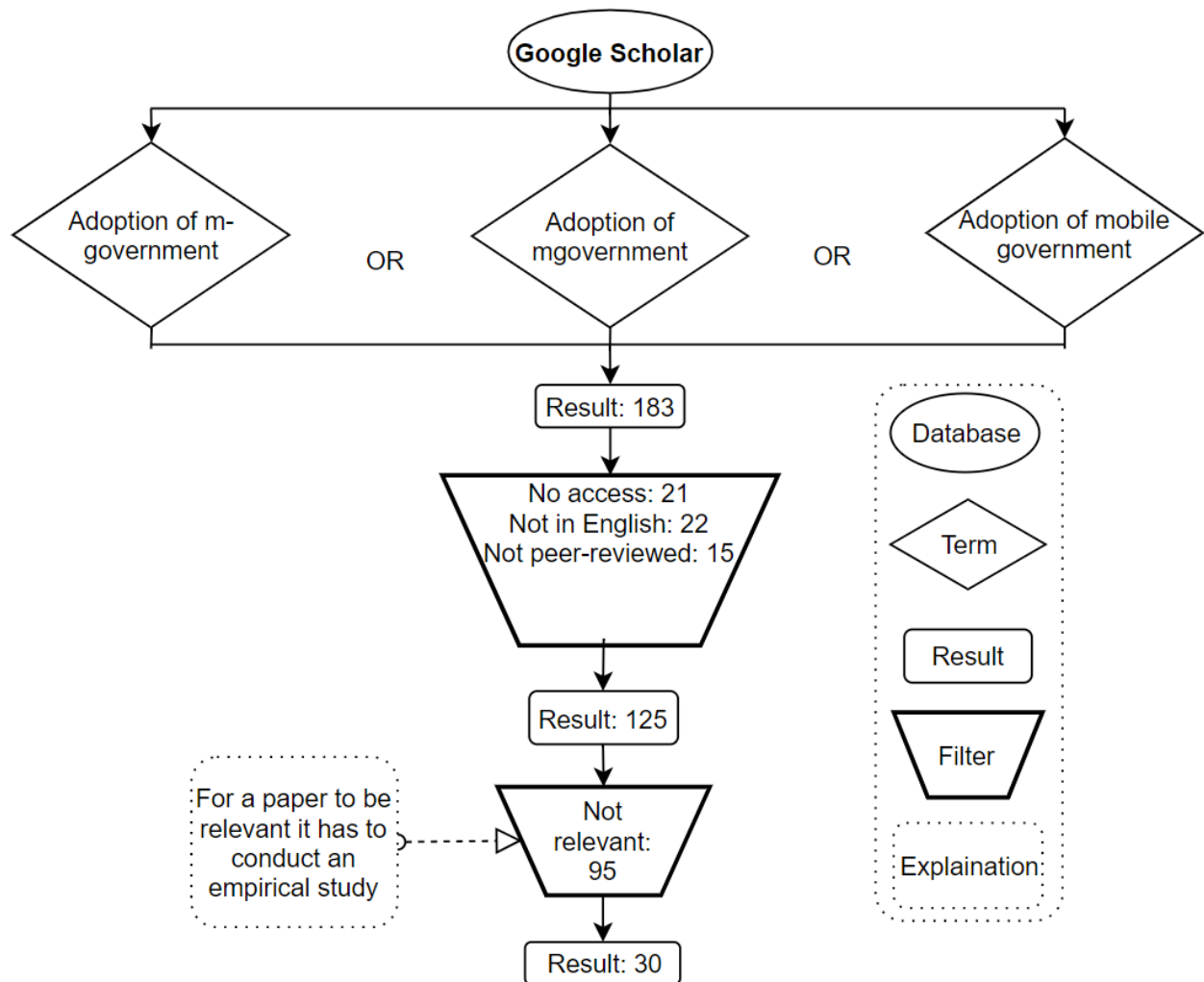

Figure 1: Flowchart of the search strategy

### 3 Literature analysis

This section presents the analysis of data extracted from 30 papers that are judged to be relevant to m-government empirical research. The analysis is based on the publication dates, the approaches applied, the theories used, and the types of stakeholders considered, as well as examining the limitations and trends in m-government studies.

#### 3.1 General analysis

##### 3.1.1 Dates analysis

A time analysis was performed to understand the developments and trends of studies in the research area.

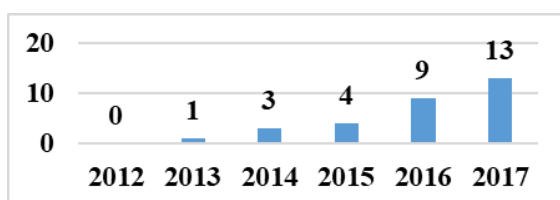

Figure 2: Number of publications per year (2012-2017)

As seen in Figure 2, the number of publications started to increase dramatically in 2016. 22 of the 30 studies were conducted in the last two years. This could be due to the increase in the number of m-government services and the reduction in the prices of mobile devices (Fontelo et al. 2015). In summary, research in m-government adoption is a relatively new and trending area of research.

### 3.1.2 Research methodologies

The quantitative research methodology is the most commonly employed research methodology in the context of the adoption of m-government (26 out of 30), whereas qualitative data were collected in only four studies. Although studies in related areas, such as electronic government (e-government), have adopted the mixed research methodology (Gil-García 2006), as yet no study has used the mixed research methodology in the field of m-government.

Interestingly, the qualitative methodology was not used in this area of research until 2016. This could be due to the limited use of m-government services prior to 2016, which might have influenced data collection.

### 3.2 Theories used

It has been noted that while 10 studies applied no theories, the other 20 studies used either theories (incorporating external factors) or a combination of theories. Amongst these 20 studies, 13 used the Technology Acceptance Model (TAM) and 3 studies used the Diffusion of Innovation (DOI). The Unified Theory of Acceptance Use of Technology (UTAUT) and Unified Theory of Acceptance Use of Technology 2 (UTAUT2) were used twice each. The Theory of Reasoned Action (TRA), Theory of Planned Behavior (TPB), Social Cognitive Theory (SCT), and Information System Success Model (IS Success Model) were each used only once in the group.

Theory	N	Source
TAM	13	(Ahmad and Khalid 2017; Jasimuddin et al. 2017; Alotaibi and Roussinov 2017a; Saadi et al 2017; Almuraqab 2017; Alotaibi et al. 2017; Baabdullah et al 2016; Alotaibi et al. 2016; Abu-Shanab et al. 2016; Abaza and Saif 2015; Alrowili et al. 2015; Ohme 2014; Wang 2014)
DOI	3	(Mandari et al. 2017; Saadi et al 2017; Almuraqab 2017)
UTAUT2	2	(Baabdullah et al 2017; Babullah et al. 2015)
UTAUT	2	(Migdadi 2013; Liu et al. 2014)
TRA	1	(Abu-Shanab et al. 2016)
TPB	1	(Ohme 2014)
SCT	1	(Abu-Shanab et al. 2016)
IS Success Model	1	(Glood et al. 2016a)

*Table 1. Theories used to investigate the adoption of m-government*

The most common combination of theories across these studies is TAM and DOI, as two studies incorporated both of these models. It has been observed that, apart from one study which applied DOI alone, all studies that used theories either incorporated a number of theoretical frameworks or added external factors to the applied theory. Interestingly, the second most used theory (DOI) is the newest emerging theory in the context of m-government adaption; it was adopted by three studies that were published in 2017 (see Table 1).

It has been noted that most theories emphasize the impact of users' beliefs, attitudes, and characteristics on successful m-government adoption. Given this, users themselves are an essential component of the success of m-government. Since m-government is a complex system that may not just involve end-users (citizens), but also other potential individuals/groups, we attempt to understand the different types of stakeholders who might also have some interests in m-government. The following section analyzes how the existing literature looked at the different types of stakeholders.

### 3.3 Stakeholders analysis

According to Freeman (1984), "A stakeholder in an organization is any group or individual who can affect or is affected by the achievement of the organization's objective" (p. 46). He also stated that for any business to be successful, it has to create value for its stakeholders. There is a rising recognition of stakeholders' roles in the adoption of new technologies, and considering stakeholders' perceptions is important to understand the acceptance or rejection of new technologies. Although stakeholder theory was established in the private sector, many researchers argued that it can also be used in the public

sector. For example, Scholl (2001) used this theory in the context of e-government to identify and understand the role of stakeholders in e-government projects.

Recent studies, in the field of m-government, have begun to address the role of stakeholders by introducing the concept of public value (Wang 2014). Public value is defined as “the value created by government through services, laws regulation and other actions” (Kelly et al. 2002, p. 4). Wang (2014) stated that the theory of perceived value attracts many researchers attention, as it is believed that creating value for stakeholders is the ultimate service goal. Therefore, “only the stakeholders, not the government, can determine what is truly of value to them” (Chatfield and AlHujran 2007, p. 54). As a result, we have analyzed the collected papers based on the identification and inclusion of stakeholders. In Figure 3 “Identified stakeholders” refers to studies that only mentioned a number of different stakeholders, while “Identified and Included stakeholders” refers to studies that mentioned a number of different types of stakeholders and included them in their research.

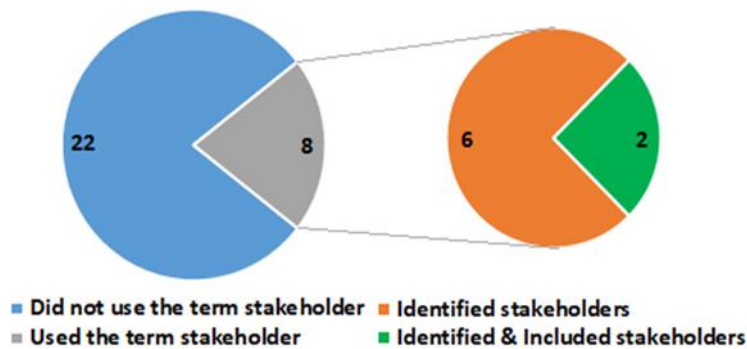

Figure 3. Classification of studies based on stakeholders' perceptions analysis

Figure 3 shows that even though m-government adoption is a topic which is beginning to attract an increasing amount of interest, few studies have looked into the stakeholders' perceptions with regard to providing governmental services through mobile devices. Eight out of thirty studies referred to stakeholders, but only two of those eight studies investigated the perceptions of stakeholders. Table 3 presents the development of the concept 'stakeholder' in the field of m-government over the last four years.

Year	Research development	Source
2014	The first use of the term to refer to citizens as stakeholders in m-government.	(Wang 2014)
2016	The first use of the term to refer to government officials, business practitioners, and ICT managers as stakeholders in m-government.	(Faisal and Talib 2016)
	The first time to consider perceptions of stakeholders other than citizens, namely government officials, business practitioners, and ICT managers.	(Faisal and Talib 2016; Chen et al. 2016)
2017	The first use of the term to refer to applications developers as stakeholders in m-government.	(Alotaibi and Roussinov 2017b; Saadi et al. 2017)

Table 2. Development of researches in terms of stakeholders' inclusion

Since 2014, the concept of stakeholder has developed in the area of m-government adoption, and more recent studies have emphasized the importance of the stakeholders (Alotaibi and Roussinov 2017b; Faisal and Talib 2016). Nevertheless, for two years after the importance of stakeholders was first acknowledged by scholars in 2014, none had considered examining the perceptions of any other stakeholders besides the citizens. In 2016, Faisal and Talib (2016) and Chen et al. (2016) were the first two studies to investigate the adoption of m-government from the perspectives of different stakeholders. In order to find some explanations for the delayed consideration of stakeholders' perspectives in the adoption of m-government, we studied the similar context of e-government. Misra (2015) argued that most of the earlier studies assessed e-government services in terms of efficiency and effectiveness; however, the provided services have recently evolved to a level of maturity where citizens and other stakeholders need to be involved in order to avoid digital divide.

To provide more supporting arguments for the importance of stakeholders, we further examined the e-government (Rowley 2011), electronic commerce (Hanna 2016), and electronic learning contexts (Aquino 2015) and found that these studies recognized the role of stakeholders in the adoption of new technologies. Therefore, we argue that the role of stakeholders is also important in m-government. Based on the stakeholder theory, a stakeholder in m-government is any group/individual who can affect or is affected by the achievement of a successful m-government. This is evident in the case of the telecommunication companies (as stakeholders); they directly affect the adoption of m-government, as they are the ones who run the network that connects citizens with governments. In other words, even if both citizens and governments are willing to adopt m-government, but the telecommunication infrastructure built by mobile operators is poor, then the m-government will not succeed. Moreover, telecommunication companies are indirectly affected by m-government because the adoption of m-government increases the use of mobiles, which will increase the companies' revenues (Nyemba-Mudenda and Chigona 2013).

### 3.4 Limitations of reviewed studies

The analysis of the collected papers revealed different types of limitations. Some of these limitations were specific to a study and were reported only once. Other limitations seemed to be common across different studies in the field. The frequency of these limitations differed from rare to very common. Table 3 presents the type and description of each limitation, as well as the studies that have reported the limitation.

Limitation	Description	N	Source
Sample and Generalizability	These studies included only a single group of users (e.g. students), sampled from one region, and had a limited number of participants. The non-random sample led to biased results, or the study was context specific.	15	(Ahmad and Khalid 2017; Alotaibi and Roussinov 2017b; Wirtz and Birkmeyer 2017; Alotaibi and Roussinov 2017a; Baabdullah et al 2017; Almarashdeh, and Alsmadi 2017; Abu-Shanab et al. 2016; Glood et al. 2016a; Glood et al. 2016b; ElSherif 2016; Alrowili et al. 2015; Ohme 2014; Liu et al. 2014; Wang 2014; Al-Hujran, and Migdadi 2013)
Factors and variables	These studies were either limited to a few factors or did not consider the demographic variables.	6	(Saxena 2017; Jasimuddin et al. 2017; Mandari et al. 2017; Almarashdeh and Alsmadi 2017; Saadi et al. 2017; Glood et al. 2016a)
Instrument validation	Instruments were used for the first time or translated into another language without validation.	2	(Abu-Shanab et al. 2016; Abu-Shanab and Haider 2015)
Analysis	Descriptive analysis rather than inferential analysis.	2	(Alotaibi and Roussinov 2017a; Babullah et al. 2015)

Table 3. Limitations found in the reviewed literature

It was found that seven studies did not report any limitation. On the other hand, fifteen studies (half of the studies) reported some type of limitations in their samples. This is problematic especially in the quantitative studies as none of the qualitative studies reported any limitations related to their sample. For instance, Omhe (2014) and ElSherif et al. (2016) surveyed only a specific group of people who are familiar with m-government services, which might have led to biased results and a higher acceptance of m-government. Some researchers also acknowledge the limitations of not incorporating sufficient factors, choosing the right factors, or considering demographic variables.

Moreover, we critique the practices and conclusions of the reviewed papers. Due to space limit, Table 4 summarizes some of the important limitations in the extant literature.

Study	Limitation
(Molnár et al. 2017)	The study investigated how usability can affect elderly people's acceptance of m-government. It is found that the higher the maturity level of m-government service, the lower the elderly people acceptance become. Although this can be seen as an interesting finding, however, the study fails to offer an adequate explanation for the relationship between elderly acceptance and m-government maturity level.

(Alotaibi and Roussinov 2017a)	They employed satisfaction as a determinant to actual use, assuming potential adopters can form satisfaction prior to using m-government. However, the authors did not take into account the pre-existing studies that prove satisfaction can only be derived from direct experience (Tian-Cole et al. 2002). In other words, although potential adopters can have an impression of the 'ease of use' of m-government they have never used, satisfaction can only be formed after using m-government.
(Almarashdeh and Alsmadi 2017; Abaza and Saif 2015)	Both studies tested trust in technology (TIT), but not trust in the government (TIG). While TIT is important, many other researchers proved that TIG is as important and it can predict citizens' acceptance of new technologies (Teo et al. 2008). Even though the studies were conducted in the same context (m-government), Almarashdeh and Alsmadi (2017) found that TIT significantly affects the intention to use m-government, while Abaza and Saif (2015) found that TIT has not affect the intention to use m-government. The findings would have been much more persuasive if the authors had considered investigating TIG, which may have explained the inconsistent results. Otherwise, the studies should have at least justified the exclusion of TIG.

Table 4. Some important limitations

### 3.5 Recommendations of reviewed studies

To identify which types of studies will make significant contributions to the field, a number of future research recommendations were extracted from the collected papers. The most common recommendations were related to the use of additional or more relevant factors and variables. For instances, demographic variables (Saxena 2017; Jasimuddin et al. 2017; Saadi et al. 2017; Almuraqab 2017), cost (Glood et al. 2016a; ElSherif et al. 2016; Abu-Shanab and Haider 2015) and security (Glood et al. 2016a; Glood et al. 2016b; Alrowili et al. 2015).

The second most common recommendation is related to the samples of the studies. Indeed, seven studies recommended increasing the number of participants or including participants from diverse groups like different age groups, education levels, and profession types (Almarashdeh, and Alsmadi 2017; Alotaibi and Roussinov 2017b). Other less common recommendations included testing the model in different contexts (Alotaibi et al. 2017), conducting a longitudinal study (Ahmad and Khalid 2017), utilizing a mixed-method approach (Baabdullah et al. 2017), and capturing the perceptions of stakeholders such as citizens, business practitioners, and ICT managers (Faisal and Talib 2016).

## 4 Discussion

The findings presented in the previous section indicate that empirical investigative studies concerning the adoption of m-government only started recently around 2013. The analysis also reveals that interest in m-government has dramatically increased over the last two years. It is apparent that m-government will attract even more attention, as both m-government and its associated technologies are evolving at a very fast pace. Availability and affordability of mobile technology will further influence interest in this field.

Analysis of the methodologies employed by past research indicated that little or no exploitation of the mixed methodology by current studies. As the mixed research methodology can provide a deeper insight and more explanations of the findings (Cao et al. 2006), there is a need for mixed methodology in m-government studies. According to Cao et al. (2006), the mixed research methodology is more efficient, in deriving information, than a single methodology (quantitative or qualitative). This is because the mixed research methodology combines the strengths of each quantitative and qualitative and overcomes the weaknesses of using a single methodology (Johnson and Onwuegbuzie 2004). With a broader coverage and greater affordability of mobile technology in the coming years, it may be possible to collect richer data sets for more in-depth analysis of m-government adoption.

In terms of theories applied to m-government research, the studies in m-government adoption favored the TAM over other theories. Despite, the fact that many researchers have criticized the TAM; for instance, Gillenson and Sherrell (2002) pointed out TAM's failure to account for social influence on the adoption of new technologies, and Chen and Huang (2006) are critical of this model's low explanatory power. This has led to further investigations of the studies that adopted TAM, in which we found that current studies have addressed these criticisms by incorporating other theories, such as DOI (Saadi et al. 2017), or considering external factors, such as social influence (Jasimuddin et al. 2017). Analysis of the current studies showed that TAM was the most used theory because of its flexibility in incorporating external factors and other theories. However, further investigations are needed to gain insight into the



reasons why other theories have not attained as much attention as TAM and what other theories outside the Information Systems discipline may be relevant for studying m-government adoption. Finally, to acquire a deeper understanding of the research topic, we need to investigate the adoption of m-government by considering theories that have not yet been tested. Also, a comparison of findings based on current theories with new external factors and emerging theories may also provide more insights into the research area.

The introduction of the concept of stakeholders in m-government studies can be attributed to rapid developments in m-government, as early studies seem to focus on service efficiency and effectiveness. However, interest has now shifted toward citizens and the value they can gain from m-government. Without citizen's adoption of the provided services, m-government will not be successful. Moreover, recent interest of private sectors, especially mobile service providers, in m-government has increased because successful adoption leads to the increase in mobile subscriptions and as a result their revenue will grow. Although the analysis indicated a growing recognition of the importance of stakeholders' perspectives in the context of m-government, insufficient work has included the perceptions of different stakeholders. In fact, this topic requires more in-depth studies that investigate the perceptions of the various stakeholders to develop a holistic view of the adoption of m-government.

Analysis of the limitations of the collected studies showed that the most reoccurring limitations were related to the samples and generalizability of the findings. To address these issues, future research needs to include larger samples from different groups. As further development and adoption of m-government take place over time, having a sufficient sample size for research will not be a problem. It was also found that some studies acknowledged the limitations of not incorporating sufficient factors, choosing the right factors, or considering demographic variables. Researchers must consider the types of factors, i.e. both dependent (such as intention to use and continue to use) and independent factors (such as cost and security) when studying m-government. Indeed, this is because there exist many alternatives, and researchers need to select the right factors depending on the context as the influence of these factors differs in different countries and cultures. The inclusion of demographic variables can also reveal new findings, for example the influence of gender and level of education on the adoption of m-government. Other studies reported a lack of instrument validation, which could be done by conducting a pilot test, or the use of descriptive analysis rather than inferential analysis, in which the findings can be generalized to a larger population.

The analysis also included investigations of the recommendations for future research. The findings illustrate the importance of investigating demographic variables as well as the factors like cost and security as they were the top most recommended factors by recent studies (Saxena 2017; Glood et al. 2016a). It was also recommended that the sample should cover a diverse group of end-users, as a number of studies focused on only a single type of end-users (e.g. students, elderly people, or youths), which might have led to biased results. Despite the fact that only one study (Faisal and Talib 2016) explicitly recommended stakeholders' inclusion, this is actually believed to be the most significant recommendation because it will provide a deeper picture of the factors that affect the adoption of m-government.

In summary, investigating the adoption of m-government by employing the mixed methodology will provide greater insights and therefore, contribute to the field of m-government. There is room for future studies to investigate the adoption of m-government incorporating theories with external factors such as cost and security. This is because these factors were the top recommendations by the current studies. Investigating the perceptions of different stakeholders is important for developing a holistic view of the adoption of m-government. It is also important for future research to address the limitations of current studies (e.g. sample and generalizability). Finally, future research can also contribute to the field by testing the effect of demographic variables on the adoption of m-government.

## **5 Conclusion and recommendations for further work**

This paper reviewed the literature of m-government adoption using a systematic review of studies published between 2012 and 2017. Out of 183 studies, 30 studies were found to be relevant for this study. The findings showed that the quantitative research methodology was the most adopted research approach, while only a few studies adopted the qualitative research methodology, and no study adopted the mixed research approach. While most studies employed TAM, other models, such as DOI and UTAUT, have not had as much attention. Results of the analysis showed that the role of stakeholders (e.g. mobile service providers) on the successful adoption of m-government has recently been considered and their perceptions are as important as those of governments and citizens. Therefore, future studies can make valuable contributions to the field by considering the perceptions of stakeholders like mobile

service providers. While most limitations were related to the sample and generalizability of the finding, most future research recommendations were related to factors and demographic variables.

Future research should widen the scope of the research to include studies in other disciplines, i.e. mobile health, mobile education, and mobile democracy. Future research should also consider investigating stakeholders' perceptions of the factors that affect m-government adoption. It is also worthwhile to consider other tested theories outside the realm of Information Systems besides those mentioned in this paper to provide more insights into the phenomenon. Last but not least another related area of research is to compare e-government research with m-government research to determine if knowledge learnt from e-government can also be applied to m-government research.

## 6 References

- Abaza, M., and Saif, F. 2015. "The Adoption of Mobile Government Services in Developing Countries," *International Journal of Computer Science Issues (IJCSI)* (12:1), p. 137.
- Abu-Shanab, E., and Haider, S. 2015. "Major Factors Influencing the Adoption of M-government in Jordan," *Electronic Government, an International Journal* (11:4), pp. 223-240.
- Abu-Shanab, E., and Shihadeh, S. 2016. "Factors Influencing G-SMS Adoption by Jordanian Citizens," *Humanitarian Technology Conference (R10-HTC), 2016 IEEE Region 10: IEEE*, pp. 1-6.
- Ahmad, S. Z., and Khalid, K. 2017. "The Adoption of M-Government Services from the User's Perspectives: Empirical Evidence from the United Arab Emirates," *International Journal of Information Management* (37:5), pp. 367-379.
- Al-Hujran, O., and Migdadi, M. 2013. "Public Acceptance of M-Government Services in Developing Countries: The Case of Jordan," *E-Government Implementation and Practice in Developing Countries* (242).
- Almarashdeh, I., and Alsmadi, M. K. 2017. "How to Make Them Use It? Citizens Acceptance of M-Government," *Applied Computing and Informatics* (13:2), pp. 194-199.
- Almuraqab, N. A. S. 2017. "M-Government adoption factors in the UAE: A Partial Least Squares Approach," *International Journal of Business and Information* (11:4).
- Alotaibi, R., Houghton, L., and Sandhu, K. 2016. "Exploring the Potential Factors Influencing the Adoption of M-Government Services in Saudi Arabia: A Qualitative Analysis," *International Journal of Business and Management* (11:8), p. 56.
- Alotaibi, R., Houghton, L., and Sandhu, K. 2017. "Factors Influencing Users' Intentions to Use Mobile Government Applications in Saudi Arabia: TAM Applicability," *International Journal of Advanced Computer Science And Applications* (8:7), pp. 200-211.
- Alotaibi, S., and Roussinov, D. 2017a. "User Acceptance of M-Government Services in Saudi Arabia: an SEM Approach," *The Proceedings of European Conference on Digital Government 2017*, p. 10.
- Alotaibi, S., and Roussinov, D. 2017b. "Using Focus Group Method to Identifying Citizen Requirements To Saudi Mobile Government Services," *19th International Conference on e-Business and e-Government*.
- Alrowili, T. F., Alotaibi, M. B., and Alharbi, M. S. 2015. "Predicting Citizens' Acceptance of M-Government Services in Saudi Arabia an Empirical Investigation," *Systems Conference (SysCon), 2015 9th Annual IEEE International: IEEE*, pp. 627-633.
- Alssbaiheen, A., and Love, S. 2015. "The Opportunities and Challenges Associated With M-Government as an E-Government Platform in KSA: A Literature Review," *International Journal of Management & Business Studies* (5:2), pp. 31-38.
- Aquino, K. C. 2015. "E-Learning and Disability in Higher Education: Accessibility Research and Practice by Jane K. Seale," *The Review of Higher Education* (38:2), pp. 305-307.
- Baabdullah, A., Nasseef, O., and Alalwan, A. 2016. "Consumer Adoption of Mobile Government in the Kingdom of Saudi Arabia: The Role of Usefulness, Ease of Use, Perceived Risk and Innovativeness," *Conference on e-Business, e-Services and e-Society: Springer*, pp. 267-279.
- Baabdullah, A. M., Alalwan, A. A., Rana, N. P., Dwivedi, Y., and Weerakkody, V. 2017. "Assessing Consumers' Intention to Adopt Mobile Internet Services in the Kingdom of Saudi Arabia," in: *Twenty-third Americas Conference on Information Systems*. Boston.

- Babullah, A., Dwivedi, Y. K., and Williams, M. D. 2015. "Saudi Citizens' Perceptions on Mobile Government (mGov) Adoption Factors," *UKAIS*, p. 8.
- Cao, J., Crews, J. M., Lin, M., Deokar, A., and Nunamaker Jr, J. F. 2006. "Interactions between System Evaluation and Theory Testing: A Demonstration of the Power of a Multifaceted Approach to Systems Research," *Journal of Management Information Systems* (22:4), pp. 207-235.
- Carroll, J. 2006. "'What's in It for Me?': Taking M-Government to the People," *BLED 2006 Proceedings*, p. 49.
- Chatfield, A. T., and AlHujran, O. 2007. "E-government Evaluation: a User-Centric Perspective for Public Value Proposition," in: *International Conference on e-Learning, e-Business, Enterprise Information Systems, and eGovernment*. pp. 53-59.
- Chen, C.-W., and Huang, E. 2006. "Predicting Taxpayers' Acceptance of Online Taxation Use," *Proceedings of the 5th WSEAS International Conference on E-Activities, Venice, Italy*: Citeseer.
- Chen, Z.-J., Vogel, D., and Wang, Z.-H. 2016. "How to Satisfy Citizens? Using Mobile Government to Reengineer Fair Government Processes," *Decision Support Systems* (82), pp. 47-57.
- Elsheikh, Y., and Hijjawi, M. 2016. "A Replicated Assessment of the Critical Success Factors for the Adoption of Mobile Government Services: the Case of Jordan," *International Journal of Computer Science & Information Technology (IJCSIT)* (8:4), pp. 41-53.
- ElSherif, H., Alomari, K., and Alkatheeri, A. 2016. "Mobile Government Services Satisfaction and Usage Analysis: UAE Government Smart Services Case Study," *International Journal of Computer Science and Mobile Computing* (5:3), pp. 291-302.
- Faisal, M. N., and Talib, F. 2016. "E-Government to M-Government: A Study in a Developing Economy," *International Journal of Mobile Communications* (14:6), pp. 568-592.
- Fontelo, P., Liu, F., and Yagi, Y. 2015. "Evaluation of a Smartphone for Telepathology: Lessons Learned," *Journal of Pathology Informatics* (6).
- Freeman, R. E. 1984. "Strategic Management: A Stakeholder Approach. 1984," *Boston: Harpercollins College Div.*
- Galvez, R. A., and Youngblood, N. E. 2016. "e-Government in Rhode Island: what effects do templates have on usability, accessibility, and mobile readiness?," *Universal Access in the Information Society* (15:2), pp. 281-296.
- Gil-García, J. R. 2006. "Enacting State Websites: A Mixed Method Study Exploring E-Government Success in Multi-Organizational Settings," *System Sciences, 2006. HICSS'06. Proceedings of the 39th Annual Hawaii International Conference on: IEEE*, pp. 76b-76b.
- Gillenson, M. L., and Sherrell, D. L. 2002. "Enticing Online Consumers: An Extended Technology Acceptance Perspective," *Information & management* (39:8), pp. 705-719.
- Glood, S., Osman, W., and Nadzir, M. 2016. "Mobile Government Services among Iraqi Citizens in Rural Areas: A Pilot Study," *Journal of Engineering and Applied Sciences* (100:3), pp. 497-504.
- Glood, S. H., Osman, W. R. S., and Nadzir, M. M. 2016. "The Effect of Civil Conflicts and Net Benefits on M-Government Success of Developing Countries: A Case Study of Iraq," *Journal of Theoretical & Applied Information Technology* (88:3).
- Hanna, N. K. 2016. "E-commerce as a techno-managerial innovation ecosystem: Policy implications," *Journal of Innovation Management* (4:1), pp. 4-10.
- Jasimuddin, S. M., Mishra, N., and A. Saif Almuraqab, N. 2017. "Modelling the Factors that Influence the Acceptance of Digital Technologies in E-Government Services in the UAE: A PLS-SEM Approach," *Production Planning & Control* (28:16), pp. 1307-1317.
- Johnson, R. B., and Onwuegbuzie, A. J. 2004. "Mixed Methods Research: A Research Paradigm whose Time has Come," *Educational Researcher* (33:7), pp. 14-26.
- Kelly, G., Mulgan, G., and Muers, S. 2002. "Creating Public Value," *London, Cabinet Office*.
- Lee, W., and Rotoloni, B. 2013. "Emerging cyber threats report," *Georgia Tech Cyber Secure Summit*.

- Liu, Y., Li, H., Kostakos, V., Goncalves, J., Hosio, S., and Hu, F. 2014. "An Empirical Investigation of Mobile Government Adoption In Rural China: A Case Study in Zhejiang Province," *Government Information Quarterly* (31:3), pp. 432-442.
- Mandari, H. E., Chong, Y.-L., and Wye, C.-K. 2017. "The Influence of Government Support and Awareness on Rural Farmers' Intention to Adopt Mobile Government Services in Tanzania," *Journal of Systems and Information Technology* (19:1/2), pp. 42-64.
- Misra, D. C. 2009. "Make M-government an integral part of e-government: An agenda for action," *Proceedings of TRAI conference on mobile applications for inclusive growth and sustainable development*, pp. 78-86.
- Misra, H. 2015. "Information Kiosk Based Indian E-Governance Service Delivery: Value Chain Based Measurement Modelling," *The Journal of Community Informatics* (11:1).
- Molnár, T., Kő, A., and Mátyus, B. 2017. "Exploring Usability and Acceptance Factors of m-Government Systems for Elderly," *International Conference on Electronic Government and the Information Systems Perspective: Springer*, pp. 175-188.
- Nguyen, T., Goyal, A., Manicka, S., Nadzri, M., Perepa, B., Singh, S., and Tennenbaum, J. 2015. *IBM MobileFirst in Action for mGovernment and Citizen Mobile Services*, (1st ed.). IBM Redbooks.
- Nyemba-Mudenda, M., and Chigona, W. 2013. "Stakeholder Management in a Community mHealth Initiative in Malawi," *Journal of Health Informatics in Africa* (1:1), pp. 27-41.
- Ohme, J. 2014. "The Acceptance of Mobile Government from a Citizens' Perspective: Identifying Perceived Risks and Perceived Benefits," *Mobile Media & Communication* (2:3), pp. 298-317.
- Ortega, J. L. 2015. "Relationship between altmetric and bibliometric indicators across academic social sites: The case of CSIC's members," *Journal of Informetrics* (9:1), pp. 39-49.
- Rowley, J. 2011. "e-Government stakeholders—Who are they and what do they want?," *International journal of Information management* (31:1), pp. 53-62.
- Saadi, M. R., Ahmad, S. Z., and Hussain, M. 2017. "Prioritization of Citizens' Preferences for Using Mobile Government Services: The Analytic Hierarchy Process (AHP) Approach," *Transforming Government: People, Process and Policy* (11:3), pp. 476-503.
- Saxena, S. 2017. "Enhancing ICT Infrastructure in Public services: Factors Influencing Mobile Government (M-Government) Adoption in India," *The Bottom Line* (30:4), pp. 279-296.
- Scholl, H. J. 2001. "Applying Stakeholder Theory to E-Government," in *Towards the E-Society*. Springer, pp. 735-747.
- Teo, T. S., Srivastava, S. C., and Jiang, L. 2008. "Trust and electronic government success: An empirical study," *Journal of management information systems* (25:3), pp. 99-132.
- Tian-Cole, S., Crompton, J. L., and Willson, V. L. 2002. "An empirical investigation of the relationships between service quality, satisfaction and behavioral intentions among visitors to a wildlife refuge," *Journal of Leisure research* (34:1), pp. 1-24.
- Wang, C. 2014. "Antecedents and Consequences of Perceived Value in Mobile Government Continuance Use: An Empirical Research in China," *Computers in Human Behavior* (34), pp. 140-147.
- Wirtz, B. W., and Birkmeyer, S. 2017. "Mobile Government Services: An Empirical Analysis of Mobile Government Attractiveness," *International Journal of Public Administration* (40:1), pp. 1-11.
- World Bank. 2012. "World Development Indicators 2012," World Bank, Washington, DC.

**Copyright:** © 2018 Alshammari, Cheung and Messom. This is an open-access article distributed under the terms of the [Creative Commons Attribution-NonCommercial 3.0 Australia License](https://creativecommons.org/licenses/by-nc/3.0/), which permits non-commercial use, distribution, and reproduction in any medium, provided the original author and ACIS are credited.

## **Supplying Innovation?: Investigating Impact of Suppliers on Innovation in IT Firms**

### **Ashish Kumar Jha**

Supply Chain and IS Department  
Rennes School of Business  
Rennes, France  
Email: [ashish-kumar.jha@rennes-sb.com](mailto:ashish-kumar.jha@rennes-sb.com)

### **Indranil Bose**

Management Information Systems Department  
Indian Institute of Management Calcutta  
Kolkata, India  
Email: [bose@iimcal.ac.in](mailto:bose@iimcal.ac.in)

## **Abstract**

Although IT has been widely recognized as one of the most important determinants of the innovation in firms yet the determinants of innovation within IT firms are very poorly understood. Higher cooperation with various players is widely believed to be an important determinant of innovation productivity. The players include suppliers, clients, competitors, universities etc. Amongst these supplier is a very intriguing class of partners more so because of its importance for manufacturing firms and almost a negligible presence in IT literature. We attempt to understand what impact a closer cooperation with suppliers has in innovation productivity in IT firms. Literature from traditional manufacturing firms' domain indicates that suppliers are very integral to innovation processes at a firm. Our research drawing from data of Chinese firms finds that suppliers are indeed a very critical determinant of IT innovation as well. The results from this paper sheds considerable light on suppliers and their integral role for IT firms' innovation development.

**Keywords:** Innovation, IT firms, China, Suppliers, Cooperation

## **1. Introduction**

The rapid advances in technology and knowledge is making it increasingly difficult for firms to be self-reliant in adapting to these advances. Firms are increasingly looking beyond their own boundaries for knowledge and skills which complement their capabilities (Becker & Dietz, 2004). These collaborations are an effort to augment their offerings to their clients and stay competitive in rapidly evolving market. Various types of cooperative innovation efforts are prevalent today which includes vertical collaboration with suppliers or with clients and horizontal collaboration with partners or even competitors. Many of these cooperative innovation techniques have got a lot of attention of academicians and practitioners alike and cooperation of some sort is considered as essential component of innovation program of firms (Chesbrough & Teece, 1996).

Various studies have analyzed multiple aspects of cooperation in innovation productivity at firms and presented frameworks addressing the issues related to innovation management in cooperative innovation regimes. However, most of these works focus on manufacturing firms and services firms have not been studied in similar depth (Tether & Tajar, 2008). This fact is in stark contrast to the world's overall productivity today which is predominantly a service dominant. Understanding the dynamics of service industries and the impact of higher innovation due to various types of cooperative arrangements thus becomes an important research topic.

In our current work we attempt to understand the dynamics of a specific cooperation effort on innovation outcome. We analyze the impact for IT firms, which constitute a dominant segment of service industry today, more so for developing countries. IT itself has been credited to being one of the most important tools for innovation productivity (Davenport, 2013), a typical innovation enabler. But the intricacies of innovation processes within IT firms are not so well understood (Bharadwaj, 2000). Manufacturing literature unequivocally argues that suppliers are one of the most important cooperation partners for increasing innovation (Bidault, Despres, Butler, 1998; Freel, 2003); however the concept of suppliers is a bit shaky in terms of modern IT firms. For IT product manufacturing firms, the traditional supplier definition and its understanding remains the same, however for services firms the term supplier generally refers to partners who provide inputs as services, knowledge or hardware for information processing. Another important aspect with IT firms is the prevalence of process innovations. In this paper we attempt to evaluate the impact of suppliers on innovation productivity of IT firms to take the innovation literature a step further and provide results applicable to a typical service sector firm in addition to existing manufacturing literature.

A second aim is to analyze the impact specifically in context of a developing economy. Liefner, Hennemann & Xin (2006) in their work on product innovation found that finer intricacies of developing new products differ in developing economies from the developed economies on account of different processes ingrained in the firm's collective culture. In our work we aim to extend this debate further on cooperation decisions in IT firms.

To this end, we empirically investigate the impact that coordination with suppliers has on IT firms' innovation outcomes. The results are based on analysis of Chinese firms' data provided by World Bank Enterprise Survey (Enterprise Survey, 2012). The analysis has been performed for both product and process innovation in IT firms. The results indicate that suppliers are very critical enablers for both these types of innovation. The results emerging out of analysis of Chinese firms do not vary too significantly from the earlier works based on manufacturing firms of Europe. The rapid rate of advancement in technology is present everywhere and coordination with suppliers to evolve more innovative products and service is a coping mechanism which has been adopted in different economies.

In the next section we present a brief overview of the extant literature of the field. This is followed by the data and its statistical analysis in the next section. In subsequent sections, we analyze the result and discuss its implications for academics and practitioners alike before concluding in final section.

## **2. Literature Review**

Firm level cooperation is increasingly been considered as an important determinant in firm's survival and success in today's networked economies (Abramovsky et al., 2008). Innovation is no exception to this trend and cooperative firms have been found to have higher R&D intensity (Sampson 2007). Increase in R&D intensity is not the only determinant leading to higher amount of cooperation amongst firms. Belderbos et al (2003) found in their work that higher cooperation increases firms' profitability from R&D activities. R&D activities, as is commonly known, are very resource intensive and cooperation amongst firms helps in sharing resources, investments along with knowledge thus increasing the success of these efforts while considerably reducing costs for the firms. One more aspect in the increasing clamor for cooperation in innovation is the influx of new perspectives to cater to higher demand for innovation from market. Various firms have consistently increased their R&D investments to create innovation units to develop new products for their customers and clients and external input in such efforts increases the outcome significantly. These factors also elucidate why the high technology intensive industries have a higher concentration of cooperative innovation (Miotti & Sachwald, 2003).

Cohen and Levinthal (1989) state that external input in a firm's organizational knowledge building capabilities is of significantly higher impact as the firm's internal R&D abilities increase. Due to these factors firms increasingly see innovation partnerships and sourcing of such innovation inputs being complementary to their own efforts and not as substitutes (Adams & Marcu, 2004; Arora & Gambardella, 1990). Firms invest in their own innovation unit development and also source a significant amount of knowledge from different kinds of partners including other firms, universities, independent R&D units etc.

While sourcing information from cooperation partners a game theoretic situation often emerges where each of the constituent partners of the innovation network aims to maximize their respective takeaways from the cooperation network. The amount of knowledge that an organization can appropriate within its organizational knowledge depends on its absorptive capacity (Cohen & Levinthal, 1989). Given the delicate nature of the cooperation arrangements possible, firms cooperate to create new knowledge when the aimed innovation outcome is not only new either of the participating firms but to the market itself (De Faria, Lima & Santos, 2010). Such arrangement ensures higher gain for all collaborating parties with minimum unwanted spillover of internal knowledge of firms.

Schmidt (2005) throws more light on this perspective in the decision to cooperate for firms on matters of R&D and innovation. This is the effort to maintain a balance between high knowledge growth via external acquisition and maintaining secrecy of the information internal to the firm. It is in these context that a firm chooses to cooperate with partners seen as very reliable for the focal firm. Thus reliability, trust and mutual benefit are very important constructs defining the possible partners for a firm. Based on these factors a firm may ally with one of the two kinds of knowledge alliance partners to develop innovation networks. These are either to increment the focal firm's existing knowledge base and build on its platform or to develop entirely new knowledge base by producing a radical shift in its innovation paradigm (De Faria, Lima & Santos, 2010; Bercovitz & Feldman, 2007).

Given these factors, it seems only natural that firms' would collaborate with other firms whose interests are closely tied to the focal firm and which might not be a potential competitor in the industry. Attallah (2002) also finds that gains from vertical spillovers with collaborators up or down the supply chain like suppliers or clients have higher impact on focal firm's R&D performance than horizontal collaborations with other firms. Belderbos, Carree & Lokskin (2004) also states that cooperation with suppliers help a firm in increasing not only its R&D productivity but also its labor productivity.

In light of this discussion, suppliers do seem to be one of the most important research cooperation partners. Various studies have independently corroborated the fact that suppliers are very important cooperation partner to achieve higher R&D productivity (Becker & Dietz, 2004; Belderbos et al, 2006; Cassiman & Veugelers, 2002; Quintana-farcia & Benavides-Velasco, 2004). While for manufacturing firms the impact of suppliers on the focal firm is well understood, not so much is known for services sector including IT firms. This research focuses on this gap to analyze the impact of supplier cooperation on IT firms and we base our analyses on Chinese firms' data to draw our conclusions.

### 3. Data and Results

The data set used in this research is the Enterprise Survey Data that is obtained from the World Bank. We have used data for year 2012 which is the latest year for which the data is available for firms in China. The innovation survey, which is conducted by the World Bank as a part of the Enterprise Survey, is designed using the guidelines that are provided in the Oslo manual for innovation (Oslo Manual, OECD Publishing, 1997). These surveys are conducted physically by World Bank representatives and are made available for use by researchers around the world on request.

For Chinese firms the analysis is performed on privately held as well as publicly traded firms. We exclude the state owned Chinese firms as these firms tend to invest disproportionately in research to uphold the public commitment of the government (Heath, 2013). Hence, such firms may not be a true representative of the firms that practice innovation in China.

For China the total number of IT firms is 290. These firms can be designated as small, medium and large firms on the basis of their employee count. The distribution criterion that is used is as follows: small firms have between 5 and 19 employees, medium firms have between 20 and 99 employees and large firms have more than 100 employees. This definition is adopted from the World Bank's definition of firm size. Table 2 provides a detailed breakup of the sample according to firm size (i.e., in terms of number of employees of the firm). Table 1 shows the summary descriptive statistics for the major variables used in this research. We use natural logarithms of the financial variables. The variable firm revenue is the revenue of the firm in the preceding financial year. The other two variables that are listed include the expenses internal and external R&D activities by the firms.

	China	
Firm size	<i>Freq.</i>	<i>Percentage</i>
<b>Small <math>\geq 5</math> and <math>\leq 19</math></b>	107	36.90%
<b>Medium <math>\geq 20</math> and <math>\leq 99</math></b>	102	35.17%
<b>Large <math>\geq 100</math></b>	81	27.93%
<b>Total</b>	290	

Table 1: Distribution of Chinese firms in the dataset according to firm size

Variable	Mean	Std. Dev.	Min.	Max
<b>Firm revenue</b>	16.69	1.69	12.33	22.11
<b>Average annual spend on intramural R&amp;D</b>	14.02	1.51	11.51	18.42
<b>Average annual spend on contracted R&amp;D</b>	12.47	3.58	0	15.42

Table 2: Descriptive statistics of properties for Chinese firms

All values are natural logarithms of respective values in US\$.

Table 1 and Table 2 show the firm distribution by size and their descriptive statistics respectively for Chinese IT firms. The data shows that the same is proportionate amongst small, large and medium firms and do not have any disproportionate representation. Table 2 also shows that for the expenditure on intramural R&D activities is greater than that on contracted R&D activities.

In our current work we test both product and process innovation separately for the impact of supplier cooperation since various studies have indicate fundamental differences in the way product and process innovations unfold at organization (Fritsch & Meschede, 2001; Avermaete et al., 2004). We have created logistic regression models to test these impacts.



Our dependent variables are product and process innovations which are binary variables. These variables are set to 1 for firms which have introduced a product or process innovation in last full year for survey (2011). The primary explanatory variable for our research is use of suppliers as innovation cooperation partners. The variable is also a binary variable which is set to 1 if suppliers were one of the major innovation cooperation partners for the firm's surveyed.

A host of control variables are necessary in any regression based analysis to understand the impact of the explanatory variable under the impact of existing variables. We have used the following variables as control variables for the purpose to analyze the impact of suppliers under their constraints:

- a. **Firm Revenue:** Revenue of a firm is the indicator of its size and thus its agility as well. It is one of the factors which can have a huge impact of firm's innovation capability. This is because innovation requires investment and larger firms would have higher capacity to invest in multiple processes for enhancing innovation. Firms that are smaller in terms of revenue have fewer resources to invest in multiple simultaneous activities (Tsai, 2001; Damanpour, 1991). In our current work to make the formulation linear, we have used natural logarithms of the firm's revenue as the variable.
- b. **Internal R&D Spending:** Expenditure on research and development is another critical control variable employed in this paper. Internal R&D spending is an indicator for processes set within the firm for enhanced innovation productivity (Parthasarathy & Hammond, 2002; Sampson, 2007). It is also an indicator of the kind of innovation activity that firm promotes. Here again, we have used the natural log of R&D expenses as a control variable.
- c. **External R&D Spending:** External R&D through licensing, procurement or contracted R&D is another important innovation style. Many firms indulge in this style of innovation primarily, though most firms use a mix of both internal and external R&D methods Parthasarathy & Hammond, 2002; Sampson, 2007). It is also an indicator of the kind of innovation activity that firm promotes in terms of bringing out of the box ideas for the firm from outside the firm's knowledge base. Here also, we have used the natural log of R&D expenses as a control variable.
- d. **Firm Age:** Firm's age is a signifier of both its legacy and maturity which defines how much agility the firm has in producing innovative products and processes (Almus & Nerlinger, 2006; De Jong & Vermeulen, 2006; Cefis & Marsili, 2006). That is particularly because lot of studies have concluded that younger firms are more agile with respect to use of new technology and thus on this account they tend to be more innovative than old and established firms (Baldwin & Lin, 2002; Heunks, 1998).
- e. **Workforce using computers:** One of the most important determinants of innovation in the digital age and more so in IT firms is the widespread use of IT within the firm. Various researches have established that workforce with higher access to digital resources are more suited to innovate rapidly (King, 2006; Zahra & George, 2002). The data has been used to control for firm's affinity for technology which might affect the way newer processes are introduced in firms and hence ability to align with suppliers' interests at all levels. The data is the percentage of workforce which actively uses computers in their day to day activities at the surveyed firms.

Table 3 given below shows the correlation matrix of all the variables being analyzed in the paper as discussed above

		1	2	3	4	5	6	7
1	Product Innovation	-						
2	Process Innovation	(0.105)**	-					
3	Firm age	(0.041)*	(0.042)	-				
4	Firm revenue	0.143**	0.147**	(0.022)	-			

5	Internal R&D spending	0.143**	(0.205)**	(0.048)	0.578**	-		
6	External R&D spending	0.092	(0.333)**	(0.194)*	(0.600)**	0.807**	-	
7	Workforce using computers	0.0791**	(0.020)	(0.027)	(0.037)	0.105**	(0.108)	-
8	Innovation in cooperation with suppliers	(0.035)	0.202**	(0.018)	(0.059)*	0.007	(0.169)*	(0.067)**

Table 3: correlation matrix of the variables of the study

\* p<0.05, \*\*p<0.01; ( ) denotes a negative number.

To analyze the impact of supplier cooperation on product and process innovation, we perform two different analyses, one with product innovation as dependent variable and another with process innovation as the dependent variable. For both these analyses, we create two different models. In the first model we have the dependent variables being regressed against the control variables to get a base result. We introduce the explanatory variable of supplier cooperation in model 2 in both the analyses and then analyze the impact it has on the overall results.

All the four models were highly significant with chi square values of all four tests being less than 0.01. Thus the tests were significant at 99% levels. The explanatory power being provided by the tests is also sufficiently high which increases in both cases after the addition of the variable for supplier cooperation.

The tables 4 and 5 given below show the results of the analyses as obtained.

	Model 1			Model 2		
	<u>Coefficient</u>	<u>Std. Error</u>	<u>P- Value</u>	<u>Coefficient</u>	<u>Std. Error</u>	<u>P- Value</u>
Firm age	0.019	0.012	0.464	0.011	0.017	0.328
Firm revenue	-0.185	0.111	0.44	-0.237	0.174	0.484
Internal R&D spending	0.17	0.013	0.032	0.385	0.087	0.042
External R&D spending	0.247	0.086	0.007	0.279	0.093	0.004
Workforce using computers	-0.006	0.005	0.18	-0.002	0.001	0.21
Innovation in cooperation with suppliers	-	-	-	0.316	0.0847	0.005
<b>Power of test (chi square)</b>	0.000			0.000		
Log Likelihood ratio	-143.647			-159.475		
_hat	0.805	0.237	0.003	0.918	0.447	0.002
_hatsq	0.178	0.029	0.048	0.057	0.034	0.098

Table 4: Logit results for product innovation at Chinese IT firms

	Model 1			Model 2		
	<u>Coefficient</u>	<u>Std. Error</u>	<u>P- Value</u>	<u>Coefficient</u>	<u>Std. Error</u>	<u>P- Value</u>
Firm age	0.103	0.174	0.664	0.115	0.123	0.628
Firm revenue	-0.249	0.128	0.39	-0.198	0.119	0.372

Internal R&D spending	0.299	0.081	0.002	0.283	0.091	0.002
External R&D spending	0.361	0.152	0.041	0.349	0.146	0.048
Workforce using computers	-0.008	0.041	0.271	-0.007	0.031	0.313
Innovation in cooperation with suppliers	-	-	-	0.125	0.043	0.031
<b>Power of test (chi square)</b>	0.000			0.000		
Log Likelihood ratio	-148.947			-152.741		
_hat	0.712	0.149	0.002	0.692	0.158	0.002
_hatsq	0.214	0.113	0.871	0.341	0.247	0.957

Table 5: Logit results for process innovation at Chinese IT firms

## 4. Analysis and Discussion

The logistic regression model results shown in table 4 and 5 throw some interesting results for analysis. For product innovation as well as process innovation it can be readily seen that the model is a very good fit for the data as evident by the Chi square value and its log likelihood ratios. The explanatory power has increased from model 1 to model 2 for both product and process innovation indicating the significance of supplier cooperation as an important variable for both product and process innovation. The analysis also indicates some interesting points where the product and process innovation paradigms slightly differ from each other. The results indicate that firm age and firm revenue are not a significant determinant for either the product or process innovation. These results are in line with prior research in this field which has more or less remained inconclusive on the impact of these two variables on innovation productivity. Internal R&D spending is a significant determinant of product R&D, although at 95% significance level but for process innovation internal R&D gains much higher prominence. It has a higher coefficient value at 99% significance level. The percentage of workforce using computers is not a significant determinant for any of the innovation models. One of the important reasons for this result is the fact that use of computers in IT firms is highly ubiquitous and use of computing resources in no way impacts the innovation outcome as it did in early years of IT boom. The results are consistent across both the innovation styles.

Adding our primary explanatory variable of supplier cooperation to the model 1 to receive model 2, we get that supplier cooperation is a significant determinant of innovation productivity for both product and process innovation. However, the results also indicate that supplier cooperation is much more significant for product innovation than it is for process innovation. This is consistent with the control variables which indicate that external R&D to be more significant for product innovation while internal R&D to be more significant for process R&D.

The following post estimation tests were performed to check for the robustness of the logit regressions performed

- a. Specification Test:- Specification test was performed to test the power of the models. The results as depicted in the last 2 rows of table 4 and 5 indicates that the model is correctly specified. The values for linear predicted value ( $\hat{\mu}$ ) are found to be statistically significant for all models. The values for linear predicted value square ( $\hat{\mu}^2$ ) were also within acceptable ranges indicating that model was not misspecified or that any variable was not omitted.
- b. Classification Test:- Classification test of the models indicated that in all the 4 models constructed there is no classification error. The percentage correctly classified for both the product innovation models are 88.24% and 89.49% and the corresponding values for process innovation models are 89.76% and 90.33%.

Both these tests indicate the robustness of the test and the correct specification of the models.

These results are extremely significant from point of view of both academicians and practitioners alike. Establishing the fact that suppliers are important partners for increasing innovation productivity, either product or process, for even IT firms extends the literature on innovation cooperation to IT firms. Managers at IT firms can better evaluate the possible tie-ups with the vertical partners in their effort to remain highly innovative and in turn competitive in the industry.

## 5. Conclusion

Although suppliers as a construct itself is very poorly understood and very faintly recognized for services firms and in particular for IT firms, the results show that they are important players in enabling higher innovation productivity. In times when higher innovation is the need of the hour and most firms have dedicated teams to find ways to improve innovation productivity, increased understanding of the innovation determinants would enable the managers at such firms to deploy better programs aimed at increasing innovation productivity. The results have been reached after a careful analysis of data of Chinese IT firms.

The results established in this paper are not without its own limitations. The generalizability of the result may be limited and a wider empirical investigation from different geographies needs to be conducted to establish the same. More exploratory works and cases from various firms indulging in innovation through supplier cooperation needs to be performed, to better understand the dynamics behind these. One more factor that needs to be explored in this domain is the impact of multinational firms vs. local firms and the impact of diversified supplier network on the innovation productivity.

However, even with its own limitations, the results of this paper are important, as it establishes the importance of suppliers and enables both practitioners and academicians to see the various cooperation partners as important determinant for IT innovations. The fact that suppliers are crucial innovation partners in both product and process innovations at IT firms shows the importance in sectors beyond traditional manufacturing. These results in this paper extend the extant literature in IS on determinants of various types of innovation. The importance of suppliers as a cooperation partner for fostering higher innovation indicate the impact of cooperation decisions in the domain of IT innovations.

## 6. References

- Abramovsky, L., Kremp, E., López, A., Schmidt, T., and Simpson, H., 2008. "Understanding co-operative R&D activity: evidence from four European countries". *Economics of Innovation and New Technology*
- Adams, J., and Marcu, M., 2004. R&D sourcing, joint ventures and innovation: a multiple indicators approach. *NBER Working Paper*, 10474.
- Almus, M., and Nerlinger, E. A. 1999. "Growth of New Technology-Based Firms: Which Factors Matter?". *Small Business Economics*. (13:2), pp. 141-154.
- Arora, A., and Gambardella, A., 1990. Complementarity and external linkages: the strategies of the large firms in biotechnology. *Journal of Industrial Economics*.(38:4), pp. 361-379
- Atallah, G., 2002. "Vertical R&D spillovers, cooperation, market structure, and innovation". *Economics of Innovation and New Technology* . (11:3), pp. 179-209.
- Avermaete, T., Viaene, J., Morgan, E. J., Pitts, E., Crawford, N., and Mahon, D. 2004. "Determinants of product and process innovation in small food manufacturing firms". *Trends in Food Science & Technology*, 15(10), 474-483.
- Baldwin, J., and Lin, Z. 2002. "Impediments to Advanced Technology Adoption for Canadian Manufacturers". *Research Policy*. (31:1), pp. 1-18.
- Becker, W., and Dietz, J. 2004. "R&D cooperation and innovation activities of firms—evidence for the German manufacturing industry". *Research policy*, (33:2), pp. 209-223.
- Belderbos, R., Carree, M., Diederer, B., Lokskin, B., and Veugelers, R., 2003. "The determinants of R&D cooperation: evidence from Dutch CIS Data 1996-1998". ZEW Workshop on the Empirical Economics of Innovation and Patenting, Mannheim, Germany, March pp. 14-15.
- Belderbos, R., Carree, M., and Lokskin, B., 2004. "Cooperative R&D and firm performance". *Research Policy*. (33:10), pp. 1477-1492.

- Belderbos, R., Carree, M., and Lokshin, B. 2006. "Complementarity in R&D cooperation strategies". *Review of Industrial Organization*, (28:4), pp. 401-426.
- Bercovitz, J., and Feldman, M., 2007. Fishing upstream: firm innovation strategy and university research alliances. *Research Policy* (36:7), pp. 930-948.
- Bidault, F., Despres, C., and Butler, C. 1998. "The drivers of cooperation between buyers and suppliers for product innovation". *Research Policy*, (26:7), pp. 719-732.
- Bharadwaj, A. S. 2000. "A Resource-Based Perspective on Information Technology Capability and Firm Performance: An Empirical Investigation". *MIS Quarterly*, (24:1), pp. 169-196.
- Cassiman, B., and Veugelers, R. 2002. "R&D cooperation and spillovers: some empirical evidence from Belgium". *American Economic Review*, pp. 1169-1184.
- Cefis, E., and Marsili, O. 2006. "Survivor: The Role of Innovation in Firms' Survival". *Research Policy*, (35:5), pp. 626-641.
- Chesbrough, H. W., and Teece, D. J. 1996. "When is virtual virtuous". *Harvard business review*, (74:1), pp. 65-73.
- Cohen, W., and Levinthal, D., 1989. Innovation and learning: the two faces of R&D. *The Economic Journal*. (99:397), pp. 569-596
- Damanpour, F. 1991. "Organizational Innovation: A Meta-Analysis Of Effects of Determinants and Moderators". *Academy Of Management Journal*, (34:3), pp. 555-590.
- Davenport, T. H. 2013. "Process Innovation: Re-Engineering Work Through Information Technology". *Harvard Business Press*.
- De Faria, P., Lima, F., and Santos, R. 2010. Cooperation in innovation activities: The importance of partners. *Research Policy*. (39:2008). Pp. 1082-1092
- De Jong, J. P., and Vermeulen, P. A. 2006. "Determinants of Product Innovation In Small Firms A Comparison Across Industries". *International Small Business Journal*, (24:6), pp. 587-609.
- Freel, M. S. 2003. "Sectoral patterns of small firm innovation, networking and proximity". *Research policy*, (32:5), pp. 751-770.
- Fritsch, M., and Meschede, M. 2001. "Product innovation, process innovation, and size". *Review of Industrial Organization*, (19:3), pp. 335-350.
- Heath, J. (Ed.). 2013. "Public Enterprise at The Crossroads". Routledge.
- Heunks, F. J. 1998. "Innovation, Creativity and Success". *Small Business Economics*, (10:3), pp. 263-272.
- King, W. R. 2006. "IT strategy and innovation: Recent innovations in knowledge management". *Information Systems Management*, (24:1), pp. 91-93.
- Liefner, L., Hennemann, S., and Xin, L. 2006. "Cooperation in the innovation process in developing countries: empirical evidence from Zhongguancun, Beijing". *Environment and Planning A*, (38:1), pp. 111.
- Miotti, L., and Sachwald, F., 2003. Cooperative R&D: why and with whom? An integrated framework of analysis. *Research Policy* (32:8), pp. 1481-1499.
- OECD. 1997. "The Measurement of Scientific and Technological Activities Proposed Guidelines for Collecting and Interpreting Technological Innovation Data: Oslo Manual". *OECD Publishing*.
- Parthasarthy, R., and Hammond, J. 2002. "Product Innovation Input and Outcome: Moderating Effects of the Innovation Process". *Journal of Engineering and Technology Management*, (19:1), pp. 75-91.
- Sampson, R., 2007. "R&D Alliances and firm performance: the impact of technological diversity and alliance organization on innovation". *Academy of Management Journal*. (50:2), pp. 364-386
- Schmidt, T. 2005. Knowledge flows and R&D co-operation: firm-level evidence from Germany. ZEW Discussion Paper, pp. 05-22.
- Tether, B. S., and Tajar, A. 2008. "The organisational-cooperation mode of innovation and its prominence amongst European service firms". *Research policy*, (37:4), pp. 720-739.
- Tsai, W., 2001. "Knowledge Transfer in Intra-organizational Networks: Effects of Network Position and Absorptive Capacity on Business Unit Innovation and Performance". *Academy of Management Journal*, (44:5), pp. 996-1004
- Quintana-Garcia, C., and Benavides-Velasco, C. A. 2004. "Cooperation, competition, and innovative capability: a panel data of European dedicated biotechnology firms". *Technovation*, (24:12), pp. 927-938.
- Zahra, S. A., and George, G. 2002. "The net-enabled business innovation cycle and the evolution of dynamic capabilities". *Information Systems Research*,(13:2), pp. 147-150.

## **Acknowledgements**

The authors like to thank the World Bank Enterprise survey for providing access to firm level micro data for this research to be completed (Enterprise Survey). The authors like to state that all inferences drawn in the paper and all views presented are authors' own and are in no way representative of World Bank's views or inferences.

## **Copyright**

**Copyright:** © 2018 Jha & Bose. This is an open-access article distributed under the terms of the [Creative Commons Attribution-NonCommercial 3.0 Australia License](#), which permits non-commercial use, distribution, and reproduction in any medium, provided the original author and ACIS are credited.

## Adoption of Digital Payments by Small Retail Stores

Ravi Seethamraju  
University of Sydney Business School  
Sydney, Australia  
Email: ravi.seethamraju@sydney.edu.au

Krishna Sundar Diatha  
Indian Institute of Management Bangalore  
Bangalore, India  
Email: diatha@iimb.ac.in

### Abstract

Entry of large supermarkets and online retailers, and widespread adoption of digital technologies are threatening the business models of small retail convenient stores in India. Using a qualitative methodology and the Technology-Organization-Environment framework, this study, investigated the challenges faced by these small retail stores in the context of a deliberate governmental push towards digital payments and increasing competition from large supermarkets and online retailers. Perceived loss of control, costs of technologies, customer's low socio-economic background, suppliers influence, tax and security implications, bureaucracy, and lack of trust in the regulatory and external environment are the challenges identified in the study. In addition, poor physical and digital infrastructure, inadequate access to and poor reliability of digital technologies, and the costs are constraining the adoption of digital technologies.

**Keywords** Digital payments, Small retail stores, TOE, Adoption

## 1 INTRODUCTION

Increasing competition from online retailers and large supermarkets and digitalization is rapidly changing the retailing landscape and hastening the decline and adaptation of small retail grocery stores (Corkery 2017, Peterson 2017). Although digital and mobile technologies are widely deployed in the retail sector, their uptake by the small retail stores, termed as 'kirana' stores in India is relatively slow. Next to agriculture, this sub-set of retail sector in India employs about 12 million people and contributes to 12% of GDP (Sinha et al 2015). Despite urbanization and the advent of supermarket chains and online retailers, these small retail stores still control 98% of the grocery retail market in India (KIE 2016). With most retail sales still taking place in physical stores and a huge economic significance of these small retail stores in India, the implications of digitalization for them are noteworthy. Though adoption is slow, there have been cases of adjustments, adaptations and new retailing concepts that have strengthened the role of the physical store (Hagberg and Fuentes 2018).

Small retail stores do not value technology as an enabler and are generally slow in adopting digital technologies (Corkery 2017; Peterson et al 2017; Ramakrishnan 2010). With their unrelenting focus on efficiency, large retailers and e-Commerce players have exhausted all the avenues of improving cost efficiencies and revenue generation. Small retailers, to survive, must take advantage of the digital technologies and refocus on flexibility and new forms of customer engagement enabled by those technologies. With declining market share and increasing competition, can these small retail stores cope with the emerging digitalization challenge? This study investigates the challenges these small retail stores face in the adoption of digital technologies in a developing country like India. It aims to analyse the costs and benefits of digitalization for small retail stores and will identify organizational, technological and environmental challenges faced by them. This paper first presents a review of the literature that explains the adoption of digital technologies in the retail sector and then explain the theoretical framework and research methodology adopted in this study. This is followed by the analysis of data and discussion of findings. The final section discusses the study's implications, limitations and conclusions.

## 2 LITERATURE REVIEW

Retail convenience grocery stores, similar to corner stores in Australia and other Western countries, are called 'kirana' stores in India. They are commonly owner managed with little hired help, small in size, and stock a very limited number of items (Ramakrishnan 2010). Spread across the country in cities, towns and villages and conveniently located in residential areas, these small retail stores stock products according to the needs of local consumers (Sathish and Raju 2010). Typically, they store a small range of essential food items, grains, processed food, dry goods, drinks, toys, fresh food, personal care items and household items (Maruyama and Trung 207) within an area less than 500 square feet (Goswami and Mishra 2009). Stocking around 1000 to 8000 SKUs of branded, unbranded and local products, these small retail stores localize their merchandise based on the ethnicity of their trading area in a diverse country like India and are more a source of livelihood for many owners rather than a vocation (Rani 2013). These stores are similar to corner grocery stores in western countries, which exist to meet emergency and fill-in requirements. These are significant, given that India has the highest retail density in the world with one retail store per 100 people (Kalhan and Franz 2009). Next to agriculture, this sub-set of the retail sector in India employs 12 million people and contributes to 12% of GDP (Sinha et al. 2015). Despite urbanization and the advent of supermarket chains and online retailers, these small retail stores still control 98% of the grocery retail market in India (KIE 2016).

The traditional business model of these small stores typically relies on low capital investment, family ownership (Yun et al. 2012), low margins (Rani 2013), low value but frequent purchases by customers, heavy dependence on cash-based transactions, easy credit terms to customers (Yun et al. 2012), and localization of the merchandise based on ethnicity, home delivery and personalized service (Sinha et al 2015). Characterized by low levels of technical and accounting standardization (Maruyama and Trung 2007), these stores operate more like a small supermarket and compete by meeting the needs of the local community with their unique service characteristics (Sinha et al. 2015).

This traditional model, in operation for over a century in Indian urban and rural areas, is being threatened by the entry of large retailers, malls, supermarkets and online e-commerce players. Growth in the middle-class consumer segment and high disposable income, together with changes in the Indian economy, have contributed to changes in retail preferences in India (Sathish and Raju 2010). In response, large retailers are aggressively establishing small format stores, like 'kirana' stores, aimed at taking away their market share (Business Standard 2015). Further, disruptive trends, such as the rise of



mobile and digital technologies, crowdsourcing, the Internet of Things (IoT), and the recent make-in-India movement have started having an impact on these small retail stores (Deloitte 2012).

Digitalization, defined as the adoption and use of digital and mobile technologies, involves not only investment in those technologies but also training and actual usage (Burton-Jones and Gallivan 2007). Digitalization thus involves changes in strategy, business processes, learning and knowledge, and involves the whole socio-technical system, potentially impacting organizational performance (Orlikowski 2009). Despite widespread adoption of mobile and digital technologies in every other sector in India, uptake of these technologies by these small retail stores and their supply chains is limited (Pantano and Viassone 2014). Although many retailers want to adopt technology, because it can help them understand consumer goals and better distribute instore information, not many do so in practice because of the delay in realizing the benefits of technology adoption (Pantano and Viassone 2014) and probably because of no positive link between adoption and store loyalty (Renko and Druzijanic 2014). Consumers, on the other hand, have been keen to adopt digital technologies and believe that doing so helps them make more informed choices in buying.

The literature on small retail/convenience stores has explored several issues relating to their operation and business models, including consumers' choice of store, antecedents to consumer behaviour, reaction to the entry of retail giants, services offered by retail stores and stores' supply chain management practices. For example, in a study of customer loyalty, Goswami and Mishra (2009) observed the strong positive influence on Indian semi-urban customers' loyalty to supermarket of location, helpful and trustworthy sales people, home shopping, cleanliness, special offers and quality. But, a negative influence in relation to travel convenience and location. In India, rural and suburban consumers prefer small retail stores because of the availability of credit (Saini and Sahay 2014). While semi-urban consumers are not influenced by the travel convenience and/or its location (Goswami and Mishra 2000) probably because of the higher density of retail stores in those areas and transportation, for rural and regional consumers, such choices are limited. Prior studies on mobile shopping have focused on attitudes (Fuentes and Svingsstedt 2017), acceptance of mobile technology (Agrebi and Jallais 2015), consumer motivation (Li et al. 2012) and consumers' reaction to mobile marketing (Goh et al. 2015).

These small retail stores are vulnerable to changes in the retail eco-system because of their heavy dependence on cash and credit-based transactions, low value transactions, poor or informal accounting and management processes (Sinha et al. 2015). Further historically they have a basic rudimentary infrastructure and low levels of adoption of technologies and therefore are vulnerable to the disruptive trends in the sector (Sinha et al. 2015). Governments are also encouraging the adoption of digital technologies, including cashless transactions and digitized processes in the retail sector, to counter the black economy and tax net. While large suppliers and/or distributors have been adopting digital technologies including mobile and internet, enterprise systems, digital payments, radio frequency identification (RFID) and supply chain management systems and achieved improved information visibility and sharing, small retail stores are slow.

There have been limited studies examining the adoption of digital technologies in the retailing context (Hagberg et al. 2016). Despite widespread adoption of mobile technologies, uptake of digital technologies such as digital payments are relatively low by small retail stores and studies on small retail stores in Indian context are limited. This study aims to fill this research gap, and investigates the challenges faced by the small retail stores. In particular, this study identifies the perceived challenges in the adoption of digital payments and identify the constraints and barriers – both internal and external – to their successful adoption and use. The next section outlines the theoretical framework and research methodology used in this study.

### **3 THEORETICAL FRAMEWORK & METHODOLOGY**

#### **3.1 Theoretical Framework**

Several theoretical models for the adoption of digital technologies have been used in the prior literature. Amongst them, most widely applied are Tornatzky and Fleischer's (1990) technology-organization-environment (TOE) framework and Davis et al (1989) the technology acceptance model (TAM). Several studies in the past have successfully used TOE framework for investigating the adoption of information technologies by SMEs (small and medium-sized enterprises) in several developing countries and demonstrated the value of TOE framework. Some of the examples include Pool et al. (2015) on the acceptance of RFID in Iranian SMEs, on cloud computing adoption in UK SMEs by Alshamaila et al (2013); and a study of adoption and impact of social media on Malaysian SMEs by Hisham et al (2017). Further, Idris et al (2017) and Tarhini et al (2015) demonstrated the value of TOE's sound theoretical

basis in explaining the adoption phenomenon in SMEs context, though antecedents and challenges varied from one industry sector to another and from one technology context to the other. It supports the investigation of opportunities, antecedents and constraints for technological innovation (Tornatzky and Fleischer 1990, p. 154) and integrates contingent organizational and environmental factors faced by firms (Kuan and Chau 2001).

TOE's focus on how the firm's context influences the adoption of innovations matches the focus of this study as against the implementation process itself and/or the characteristics of technology considered for adoption. This study is directed at the pre-adoption stage where the process is still nascent and retail stores owners can adjust the process to the digital technologies and their contexts. As a high-level analytical framework, TOE is highly adaptable (Yang et al 2015) to various technology contexts. It is an open systems model that allows incorporation of both technological and social features (Orlikowski 2007). Although specific factors across the three contexts (technology, organization and environment) vary from study to study, the TOE framework has been consistently applied to provide empirical support in various IT innovations study contexts (Oliveira and Martins 2011). The TOE framework was therefore considered suitable for this study.

### **3.2 Research Methodology**

Based on prior research and the TOE framework, our research question seeks to fill the current gap in research by identifying the technology, organization and environmental constraints that affect the adoption of digital technologies by the small retail stores in India. It will examine how these stores adapt to the new digital environment. Very little is known about the nature and extent of adoption of digital technologies such as mobile and Internet by these small retail stores (Bollweg et al 2016). Given the nature of the research questions and the emerging stage of the research in the Indian context, a qualitative methodology with TOE as a guiding framework is considered appropriate for this research. This cross-sectional qualitative study approach involves shorter, less intensive data collection on site with more complex 'how', 'what' and 'why' questions. This provides an opportunity to explore new areas (Klein and Myers 1999) and facilitates understanding of the multiple interpretations of the adoption of digital technologies by small retail stores from different perspectives of retailers, customers and suppliers (Yin 2009).

The adoption of digital technologies including digital payments by small retail stores takes considerable time and typically involves multiple actors, such as retail owners, customers and suppliers. Therefore, using semi-structured interviews, data was collected from multiple entities – the owners of these small retail stores, customers and suppliers (including distributors or wholesalers) in the retail eco-system in the state of Karnataka, India to understand and codify the phenomenon. This approach focuses on observable facts and events in sampled retail stores and scrutinizes the activities and experiences of those involved and the contexts. In addition to contributing to theory development in an innovation context, this approach informs practical knowledge.

Selection of respondents was non-random and based on location, accessibility and willingness of the respondents. A total of 44 respondents were interviewed. Of these, 12 were retail store owners/retailers (referred to R1 to R12), 11 were customers (referred to as C1 to C11) and 21 were suppliers (referred to as S1 to S21). The duration of each interview varied from 20 minutes to 45 minutes. These research interviews were recorded with permission and transcribed for further analysis. The data collected was analysed with reference to the themes discussed below. The interview questions were developed according to three major aspects. The first set of questions explored the respondent's general perception of the experience of digitalization and the extent and nature of the use of digital instruments. The second theme of questions relate to the environment (external), individual/organizational and technology related factors that have an influence on the adoption of digital technologies including digital payments. The final theme relates to the potential benefits, costs and challenges respondents perceive in the adoption and use of these digital technologies.

## **4 ANALYSIS & FINDINGS**

This section presents the findings using the adapted TOE framework.

### **4.1 External Challenges**

#### **4.1.1 Bureaucracy**

Lack of trust in the relevant regulatory environment and the associated bureaucracy with various external entities such as government and banks are also limiting the digitalization in the retail eco-

system. Enormous paper work while dealing with various government entities is a challenge, as explained by one respondent.

*“We need licenses from many departments for my shop – Shops Act, VAT, drug and food safety, parvaana license and others. I need to appoint one accountant – to look after bank works and ‘mathadi bhavan’. There are other things like income tax etc. Should shopkeepers do this work or should he do the business? They (government officials) are harassing us. They annoy us more. Who says that the corruption has ended?” (S13).*

Most Indian banks are national, but in a volatile reformist environment (where several banks are reorganized, merged and recapitalized in India) there is a fear that these entities may not guarantee the full amount (beyond the insured amount) and this acts as a barrier to digitalization. Some of the comments made by the retailers and suppliers are:

*“They (customers) don’t have any interest in it all, they don’t know what Paytm or BHIM (Bharath Interface Money – a payment application in India) app are and some people don’t have a mobile with a keypad ... can’t afford smart phones, can’t operate mobile and can’t use Internet” (R1).*

*“There is no account in banks, there is no money (for their customers)” (R10).*

*“The government is telling us to deposit money in the banks but who is giving guarantee that banks would not be bankrupt? They are giving us insurance of only Rs. 100,000 per account holder” (S13).*

*“They don’t have much trust ... (think that) some percentage of their amount will be cut ... (rely on being) shown the slip and as they the message in their mobile” (S16).*

The time taken by banks for processing online transactions and the consequent delay in ensuring regular updates for the receiver to check and confirm receipt of online payments is an issue for small retailers and involves a significant amount of their time and resources. For a small retailer, the time required to deal with these external entities is a time lost in selling and managing their stores, and therefore is a potential loss of sales and business. Several respondents raised this issue.

*“We do not have time to stand in bank queues to deposit cheques or withdraw” (R2). “we feel we need to hire an employee just to handle cashless transactions” (R4). “they feel it is difficult to learn the system and that consumes a lot of their time” (C4). “there is no awareness ... if the person (customer) wants to pay by cash then he will accept only cash” (C6).*

*“Most of them (retail customers) don’t have bank accounts. They have ‘Jan Dhan Yojana’ (a small savings account where in government benefits will be deposited) type of accounts – they have no cheque book facility. RuPay card (an Indian payment card that facilitates open loop, domestic and multilateral system of payments that will allow all Indian banks and financial institutions to participate in electronic payments [www.rupay.co.in](http://www.rupay.co.in)) is there, but they must go to a bank or ATM to use that. They need to go to the bank to deposit the sales proceeds of yesterday that may take an hour for them. (D6). “they have to go to the bank to stand in a queue? It is a big problem and the main problem. Go to the bank and see the queues? Suppose I do cashless transaction and I need 5000 rupees, I must pull down the shutters leaving the business and I have to go to the bank to withdraw money. (R8).*

Our study highlights the constraining role played by the regulatory environment. Inadequate trust in the regulatory environment and bureaucracy, whether it is with government entities complying with various regulations and the inefficient and unfamiliar processes, are observed to be major barriers for a move towards digital payments at the small retail stores level in our study.

#### 4.1.2 Tax implications

Potential tax implications if financial transactions are recorded and transparent is another challenge for retailers, as well as to other entities in the retail eco-system that are heavily dependent upon cash-based transactions. Tax rate in India is relatively low and the number of taxpayers per capita is also relatively low. Retailers and suppliers in the retail eco-system are reluctant to carry out financial transactions in a transparent way because of potential tax implications. As noted by a retailer,

*“In cashless everything gets recorded and that exposes us to taxes. Businessmen prefer cash for transactions. They don’t want transparency because they want to evade taxes” (R13).*

*“if they (suppliers/distributors) opt for cashless transaction they will have to pay more tax, one needs to show all the money and income, there will be huge tax deduction” (R2). Online*

bank transfers are also rare among suppliers. As noted by a retailer, “*they don’t accept online transfers. They are not ready to update themselves. They are content with whatever method they are following now. If they agree for online payment they should constantly check their account*” (R4).

#### 4.1.3 Security

The study respondents considered the security of transactions to be superior in a digital context than in a manual context. There is an implicit security risk in a cash-based environment, in which small retailers receive cash from customers and pay cash to suppliers/wholesalers. For example, respondents noted safety an important issue.

*“it is easy and safe for people and there is no chance of theft (C6). It would be beneficial if everything can be done through cashless transactions. We won’t need to carry cash with us. There would be no fear of theft that problem of fake notes would also be solved, as all transactions are cashless” (C8).*

Suppliers also have similar issue with the security of the handling cash and perceived it a risk.

*“if you sell goods to me and I give cash and if other people also give him (the supplier who distributes the goods to various kirana stores) cash, it is difficult to carry that cash all the way. Earlier I have to follow and ask them when they are coming. Sometimes workers (who transport cash) tell me that the money is lost or fallen off. It is problematic especially if it is a large amount. But if it is a cheque I can ask him to block that. So that fear is not there anymore. You don’t have to go to bank. You can put a cheque in drop box and it will be deposited” (S10).*

#### 4.1.4 Suppliers influence and power imbalance

Given the dependence of these small retail stores on distributors/wholesalers and/or suppliers who are typically large and powerful, their influence in the digitalization can be expected to be significant. Digitalization is expected to improve transaction efficiencies and accuracy in the retail supply chain, and especially between the retail stores and their suppliers. Suppliers noted the accuracy and speed as important drivers for pushing towards digitalization.

*“The goods previously were dealt with (paid) in rough calculation. We also are used to deal that way without demanding bills (receipts). Now we get the goods with their invoices in a proper manner” (S10).*

*“There is no need to wait and it goes from one account to another instantly. Market speed will be there. People also feel good because it will be easy and saves them time” (S16).*

These benefits, however, are limited by the volume of transactions between the suppliers and retail store owners. Value of individual transactions between individual small retail store and the large supplier and their frequency is relatively low when compared with those between the retailer and customers. Therefore, perceived benefits of digitalization are higher to these suppliers than retail stores. They therefore have an incentive to influence the small retail stores to digitalize their transactions. Therefore, they have the ability to force owners of small retail stores to adopt cashless systems and other digital technologies. A supplier explained it below.

*“It is easy to move those shopkeepers (retail store owners) to digital because they are dependent on us (distributors). Once we decide, we can give them one week to ten days’ time and after that we (can say that we) will not accept cash transaction. We will get the payment using a swiping machine and make them (retail store owners) understand that companies (manufacturing companies) are putting pressure on us and we cannot pay by cash. The shop keepers will be forcefully converted because they will not get goods from our company if they don’t (comply) (S10).*

Though not clearly articulated, a further benefit to the distributors/suppliers is the knowledge of the movement of a particular product in their local area if the information is digitalized and can be shared with them by the small retail store owners.

## 4.2 Internal Factors (Organizational)

### 4.2.1 Customers’ socio-economic background

Low levels of education and lack of awareness of the digital instruments and their potential benefits is another challenge limiting adoption. The extent of digitalization is influenced by individual socio-economic background, employment and education. Retail customers and owners who are more educated and have a regular stream of income processed through banks and other financial institutions

are aware of the digital instruments and can relatively easily adopt. Retail customers who belongs to the higher socio-economic strata (middle income groups in Indian context) have adopted mobile phones very well and are therefore comfortable with digital payments. But, most of the customers of these small retail stores are daily wage workers and people from low socio-economic background and therefore are comfortable to deal with cash on day by day basis. They earn a daily wage, buy their groceries for the day and there is no real gain for them to go digital. Some of the comments made by retailers and suppliers are given below to support this state.

*“People are not aware now. Only 10% of people are educated. If they tell me that they have made payment and I don’t receive payment after 4 days also, what would I do? Why would I go for transactions like these? Digital would not work until Indian public becomes educated. Eight out of 10 people don’t know what the digital transactions are” (S12).*

*“Most people would do cash transactions only. It is very difficult in India and especially in our state, because there are more uneducated people here and they can’t make cashless transactions” (R8).*

*“retail business is done in cash. We can’t do cashless transactions through Paytm etc. People say it takes four days to receive payment that way. It gets withdrawn from your account and it does not reach that person. Public is annoyed by that” (S2).*

*If everybody starts using it, I have to start using it. The theft and snatching will not happen to them if we go cashless” (S10).*

*“Though the number of people purchasing android phones is increasing day by day the number of people using cashless methods has not increased significantly” (S4).*

*Everything cannot be forced and implemented all of a sudden. People’s attitude should be changed. Many are not ready to pay through cashless methods even if I (a retailer) am ready to accept” (R4).*

The responses of participants suggest that digitalization in the retail sector is in its early stages and therefore a generic resistance to change is expected to limit technology adoption. Despite relatively widespread use of mobile technologies, general low socio-economic background and low levels of education constrain the adoption of digital technologies for retail transactions.

#### **4.2.2 Sense of control**

The respondents to the study indicated that consumers perceive a loss of control when they are dealing with digital transactions. Consumers and retailers feel they are in control when transactions are manual and when using cash, which is a tangible thing they can feel and see. Online payment is perceived as abstract and intangible and consumers view this as loss of control over expenditure and transactions. Because online payments are not visible, respondents argued that this may cause people to spend more than they can afford. As noted by a retailer, *“one major psychological issue is that in case of physical cash payments one feels the pinch of money spent. When it comes to digital payment we don’t feel that pinch. It is always the ‘necessity’ that teaches people to implement the things they have learnt” (R4).*

In fact, given an option, consumers do not prefer digital transactions. As noted by a retailer, *“cash transaction is more convenient. In cashless transactions I won’t be able to do anything, I would not get any money into my hand. If cashless transactions start in a big way, I have to get internet connection, and the government won’t give that free. While the customers are waiting, I can’t keep checking whether the money has gone in or not. I can’t see the money” (R8).*

Further, some believe cash is a useful tool to deal with contingencies and emergencies. There appears to be an implicit assumption that cash is needed during emergencies because other operators in the economy prefer cash and/or transactions with cash are easy when one is in urgent need and constrained for time. As noted by a respondent, *“if I need money urgently, how can I get that money? I can’t bring that money by selling my card? Anyone can transfer money to me, but I cannot get the cash. If I need money urgently to buy something in cash, I can’t get that” (S10).* While some respondents indicated above that digital financial transactions may be an incentive for people to spend on impulse others believe that digital payments are more secure and less emotional. As pointed out by a respondent *“when my customers have cash in their hand they don’t prioritize their spending. If they need something, without thinking twice they buy it if they have cash. Later to pay me or anyone else, they would not have money. This happens all the time. Now, all the customers’ money will be lying in their bank account, because they can’t draw it out immediately. In such case, customers do not have liquid cash to spend without thinking” (S5).*

Thus, this sense of control (or lack of it) in relation to digital transactions, is an important factor influencing the adoption of digital technologies. As discussed above, the relative influence of this factor is moderated by the level of education, awareness of the technology's benefits, and trust in the external digital environment.

#### 4.2.3 Costs of technologies

Resources constraint is a typical challenge for SMEs. Whether is a 'swipe card' machine or transaction fees for credit/debit card transactions, or access to the Internet – all costs money. Unless there is a commensurate benefit, small retail stores are reluctant to invest in digital equipment and processes. As noted by one consumer,

*“small provisional stores do not have card swiping option, cannot afford them, neither do they use mobile wallets nor do they have online/mobile banking; and accept cheque above a certain amount. Only a few large provisional stores own a POS (point of sale) device and other facilities” (C4).*

While online banking and cashless transactions are pushed as a cheaper and more cost-efficient option by the government and banks, there are costs associated with these transactions. These costs may eventually be passed on to consumers by the banks. For now, it appears consumers' choice to shift to digital payments is heavily dependent upon the technology being free. As noted by a wholesaler, no one will use the services if there is an extra charge for the cashless transaction and especially if a percentage is charged. As noted by a wholesaler,

*“the margins for the retailers are already low, no retailer would prefer to use digital transactions if they are charged extra (S14). Further,*

*“if bank people don't cut much amount then people will like cash less as time is saved. There will be a growth in business. But if bankers cut 20 rupees, people also will think why we should pay 20 rupees to the bank. If we go to cinema hall they say it is 160 for cashless and 150 for cash, then why will people listen and use cashless? If banks don't tax people, then people will go cashless. (S16).*

Though for some it is a burden, most of the suppliers, however, are willing to pay and prefer low fixed transaction costs rather than a percentage of the value. Participants also expressed concern about the temporary nature of current no-fee models of digitalization. As noted by a supplier,

*“people are afraid that the money from the ATMs (automatic teller machines) will be deducted automatically (a transaction fee) when money is withdrawn” (S13).*

Respondents believed that some fees – whether for using ATMs (automatic teller machines) or debit cards or online transfers or third-party payment gateways – will eventually be charged by financial institutions and/or governments. The main concern is the automatic withdrawal of their money without their knowledge if they go for digital payment systems.

### 4.3 Technology Itself a Challenge

Digital technologies themselves are a challenge. Though smart phones are increasingly sophisticated, reliable and extensively used by consumers, retailers and suppliers, applications designed for smart phones to facilitate digital payments do not always work well. For example, BHIM (Bharath Interface for Money), a payment application based on Unified Payment Interface (UPI) for digital financial transactions, is reportedly difficult to install and operate. While consumers would like to use digital wallets for payment purposes, there are challenges regarding infrastructure and availability. As noted by a supplier,

*“I have personally helped a few customers to install the app. It was not successful. Though some have installed it, they are not interested to use this (UPI) app. There must be some problem with the app too. A customer has to enter my account number and IFSC code every time to make the payment, but Paytm is comparatively easy” (S4).*

*“When I clicked a bank on the BHIM app (a payment application), I got a server down message ... after two or three days I realized there were some glitches. I am not sure what the exact problem was, but since there was a problem, I decided not to use it. (C1).*

Further, network effects are significant in digitalization and in the use of digital wallets such as BHIM and impacts their popularity. As reported by a customer,

*"BHIM does not work even though I have created the barcode and other necessary things in that app. If I have to make payment to anyone, the other person needs to have the BHIM app too. Otherwise it is useless"* (C5).

*"I have installed Paytm app as my friends have recommended it saying that they have many discount offers"* (C4). *"I had a friend who earned money by adding people. If you get less cash back in Paytm, then you can use Freecharge, another system"* (C1). As digitalization is in its early stages in a sector that is not technology-focused, some challenges are expected. As one respondent indicated *"one should be up-to-date with the technology to reap the benefits"* (S4).

In general, there is a recognition of the pros and cons of technology adoption. As aptly pointed out by one retailer *"it (technology) makes our life easy, in another way it makes us lazy, makes our life difficult; now it is a transition period."* (R4) and will pass.

## 5 CONCLUSIONS

Digitalization has both positive and negative consequences for small retail stores. Ongoing adoption needs to be managed carefully because individual small retailers' failure to adopt may be a threat to their business model and survival considering the changing consumer habits and preferences and increasing competition. Aggressive expansion of supermarket chains and their adoption of the format of small retail stores in residential areas is in direct competition with these small retail stores and may seriously threaten their business model. Given the low educational levels and relatively low socio-economic background of a many members of the retail eco-system (especially consumers and retailers in rural and semi-urban areas), overcoming external barriers is critically important if the full benefits of digitalization are to be experienced. Our findings provide insights into the significance of various external factors, as well as how excessive bureaucracy and inadequate trust in the regulatory environment impact adoption. In general, our study found that members of the retail eco-system are sceptical of digitalization initiatives and the temporary incentives offered by banks and governments. The findings of this study have practical implications for government agencies, financial institutions and technology companies seeking to simplify and build trust in relation to the regulatory environment, and to improve accessibility, reliability and ease of use of various digital applications.

Although this study offers new insights into the Indian context, there are limitations, such as the small sample size and lack of generalizability, which is common in case study research. Another limitation relates to the Technology-Organization-Environment (TOE) framework. Further studies could integrate constructs from other technology acceptance models, such as TAM, to help overcome some of these limitations and offer new insights when applied to complex environments such as the retail eco-system. Overall, our study contributes to the body of research on technology adoption in the retail sector and highlights the potential impact of digitalization on the business model of small retail stores. If small retail stores do not adopt digitalization, consumers may shift their loyalty. There, is however a recognition of the changing times and inevitability of the move towards digitalization by small retail stores to survive. It, however, is important for the governments, banks and large suppliers to introduce appropriate mechanisms and processes that would help small retailers to overcome the challenges. This is critically important given the economic and social significance of small retail stores in India. In time, small retail stores will recognize the inevitable impact on their business models and adopt digitalization to survive.

## 6 REFERENCES

- Agrebi, S., and Jallais, J. I. 2015. "Explain the Intention to Use Smartphones for Mobile Shopping," *Journal of Retail Consumption and Service* (22), pp. 16-23.
- Ajzen, I. 1991. "The Theory of Planned Behaviour," *Organizational Behaviour and Human Decision Processes* (50), pp. 179-211.
- Alshamaila, Y., Papagiannidis, S. and Li, F. 2013. "Cloud computing adoption by SMEs in the north east of England: A multi-perspective framework," *Journal of Enterprise Information Management*, (26:3), pp.250-275.
- Bollweg, L., Lackes, R., Siepermann, M., Sutaj, A., and Weber, P. 2016. "Digitalization of Local Owner Operated Retail Outlets: The Role of the Perception of Competition and Customer Expectations." In *PACIS 2016 Proceedings*, 348, <http://aisel.aisnet.org/pacis2016/348>.

- Burton-Jones, A., and Gallivan, M. J. 2007. "Toward a Deeper Understanding of System Usage in Organisations: A Multilevel Perspective." *MIS Quarterly* (31:4), pp. 657-680.
- Business Standard. 2015. "Kirana Stores the Inspiration for Big Retailers Small Stores: BCG." *Business Standard Reporter*, 16 September 2016, downloaded from [http://www.business-standard.com/article/companies/kirana-stores-the-inspiration-for-big-retail-s-small-stores-bcg-115091600023\\_1.html](http://www.business-standard.com/article/companies/kirana-stores-the-inspiration-for-big-retail-s-small-stores-bcg-115091600023_1.html), on 4 January 2018.
- Corkery, M. 2017. "Is American Retail at a Historic Tipping Point?" *New York Times*, 16 April 2017, downloaded from [http://www.nytimes.com/2017/04/15/business/retail-industry.html?\\_on](http://www.nytimes.com/2017/04/15/business/retail-industry.html?_on) 5 Jan 2018.
- Deloitte (2012). *Digital Disruption: Short Fuse or Big Bang*. Australia: Deloitte Touche Tohmatsu.
- Fuentes, C., Backstrom, K., and Svngstedt, A. 2017. "Smartphones and the Reconfiguration of Retailscapes: Stores, Shopping and Digitalization," *Journal of Retailing and Consumer Services* (39), pp. 270-278.
- Goh, K.-Y., Chu, J., and Wu, J. 2015. "Mobile Advertising: An Empirical Study of Temporal and Spatial Differences in Search Behaviour and Advertising Response," *Journal of International Marketing* (30), pp. 34-45.
- Goswami, P., and Mishra, M. S. 2009. "Would Indian Consumers Move from Kirana Stores to Organized Retailers When Shopping For Groceries?" *Asia Pacific Journal of Marketing and Logistics* (21:1), pp. 127-143.
- Hagberg, J., and Fuentes, C. (2018) "Retail Formations: Tracing the Fluid Forms of an Online Retailer." *Consumer Market Culture* (In Press).
- Hagberg, J., Sundstrom, M., and Egels-Zanden, N. 2016. "The Digitalization of Retailing: An Exploratory Framework," *International Journal of Retail Distribution Management* (44:7), pp. 694-712.
- Hisham, M., Sharif, M., Rosli, K. and Ahmi, A. 2017. "A Model of Social Media Adoption and Impact on Malaysian Small and Medium-sized Enterprises (SMEs)," in *Proceedings of the International Conference on E-Commerce (ICoEC 2017)*, 18-20 September, Putrajaya, Malaysia, pp.1-5.
- Idris, A., Edwards, H. and McDonald, S. 2017. "E-commerce adoption in Developing Countries SMEs: What Do the Prevailing Theoretical Models Offer Us?" in *Proceedings of the International Conference on E-Commerce (ICoEC 2017)*, 18-20 September, Putrajaya, Malaysia, pp.1-5.
- Kalhan, A. and Franz, M. 2009. "Regulation of Retail: Comparative Experience," *Economic & Political Weekly*, XLIV (32), pp.56-64.
- Klein, H. K., and Myers, M. D. 1999. "A Set of Principles for Conducting and Evaluating Interpretive Field Studies in Information Systems," *MIS Quarterly* (23:1), pp. 67-94.
- Kotak Institutional Equities (KIE). 2016. "98% of Grocery Retail Market is Controlled by Kirana Stores: Study." *Economic Times Brand Equity, PTI*, 1 February 2016, downloaded From <https://Brandequity.Economictimes.Indiatimes.Com/News/Business-Of-Brands/98-Of-Grocery-Retail-Market-Is-Controlled-By-Kirana-Stores-Study/50797310>, on 2 January 2018.
- Kuan, K. K., and Chau, P. Y. K. 2001. "A Perception-based Model for EDI Adoption in Small Business Using a Technology-Organization-Environment Framework," *Information and Management* (38:8), pp. 507-521.
- Li, M., Dong, Z. Y., and Chen, X. 2012. "Factors Influencing Consumption Experience of Mobile Commerce," *Internet Research* (22:2), pp. 120-141.
- Maruyama, M., and Trung, L.V. 2007. "Traditional Bazar or Supermarkets: A Probit Analysis of Consumer Perceptions in Hanoi," *International Review of Retail, Distribution and Consumer Research* (17:3), pp. 233-252.
- Oliveira, T., and Martins, M. F. 2011. "Literature Review of Information Technology Adoption Models at Firm Level," *The Electronic Journal Information Systems Evaluation* (14:1), pp. 110-121.
- Orlikowski, W. J. 2009. "The Sociomateriality of Organisational Life: Considering Technology in Management Research," *Cambridge Journal of Economics* (34:1), pp. 125-141.



- Pantano, E., and Viassone, M. 2014. "Demand Pull and Technology Push Perspective in Technology-Based Innovations for the Points of Sale: The Retailers Evaluation," *Journal of Retailing and Consumer Services* (21:1), pp. 43–47.
- Peterson, H. 2017 "The Retail Apocalypse has Officially Descended On America." *Business Insider*, 21 March 2017, downloaded From <http://Nordic.Businessinsider.Com/The-Retail-Apocalypse-Has-Officialy-Descended-On-Amercia-2017-3> on 5 Jan 2018.
- Pool, J.K., Arabzad, S.M., Asadi, A. and Ansari, M.R. 2015. "RFID acceptance in SMEs using TOE framework: an empirical investigation on Iranian SMEs. *International Journal of Logistics Systems and Management* (21:3), pp. 335-347.
- Ramakrishnan, K. 2010. "The Competitive Response of Small, Independent Retailers to Organized Retail: Study in an Emerging Economy," *Journal of Retailing and Consumer Services* (17:4), pp. 251–258.
- Rani, E. 2013 "Supermarkets vs. Small Kirana Stores," *Journal of Business and Management* (10:1), pp. 1-7.
- Renko, S., and Drujjanic, M. 2014. "Perceived Usefulness of Innovative Technology in Retailing: Consumers and Retailers Point of View," *Journal of Retailing and Consumer Services* (21:5), pp. 836-843.
- Saini, G.K. and Sahay, A. 2014. "Comparing retail formats in an emerging market: Influence of credit and low price guarantee on purchase intention," *Journal of Indian Business Research* (6:1), pp. 48-69.
- Sathish, D., and Raju, V. D. 2010. "The Growth of Indian Retail Industry," *Advances in Management* (3:7), pp. 15-19.
- Sinha, P. K., Gokhale, S., and Rawal, S. 2015. "Online Retailing Paired with Kirana – A Formidable Combination For Emerging Markets," *Customer Need and Solutions*, (2), pp. 317-324.
- Tarhini, A., Arachchilage, N. A. G., Masa'deh, R., and Abbasi, M. S. 2015. "A Critical Review of Theories and Models of Technology Adoption and Acceptance in Information Systems Research," *International Journal of Technology Diffusion* (6:4), pp. 58-77.
- Tornatzky, L. G., and Fleischer, M. 1990. *The Processes of Technological Innovation*. Lexington, MA: Lexington Books.
- Venkatesh, V., Morris, M. G., Davis, G. B., and Davis, F. D. 2003. "User Acceptance of Information Technology: Toward A Unified View." *MIS Quarterly* (27:3), pp. 425-478.
- Yang, Z., Sun, J., Zhang, Y. and Wang, Y. 2015. "Understanding SaaS adoption from the perspective of organizational users: A tripod readiness model." *Computers in Human Behaviour* (45), pp.254-264.
- Yin, R. 2009. *Case Study Research: Design and Methods*, London: Sage Publications.
- Yun, Z.-S., Pysarchik, D. T., and Dabas, C. S. 2012. "The Determinants of Retail Loyalty of Indian Consumers." *Journal of Food Products Marketing* (18:4), pp. 268-286.

**Copyright:** © 2018 Seethamraju, R. and Diatha, K. This is an open-access article distributed under the terms of the [Creative Commons Attribution-Non-commercial 3.0 Australia License](https://creativecommons.org/licenses/by-nc/3.0/australia/), which permits non-commercial use, distribution, and reproduction in any medium, provided the original author and ACIS are credited.

## Drivers' Tactics in Ridesharing Economy in the Philippines

### Laiza L. Limpin

College of Computer Studies  
De La Salle University – Manila  
Metro Manila, Philippines  
Email: laiza\_limpin@dlsu.edu.ph

### Raymund C. Sison

College of Computer Studies  
De La Salle University – Manila  
Metro Manila, Philippines  
Email: raymund.sison@delasalle.ph

### Abstract

Increasing mobility needs, coupled with the lack of adequate public transportation has led to the popularity of ridesharing services in the Philippines, which in 2015 became the first country to implement a regulatory framework for ridesharing through transportation network company (TNC) apps. This study aims to explore the participation of drivers in the ridesharing economy in Metro Manila. Employing thematic analysis, the driver tactics are viewed as falling under one of six categories: surge chasing, request skipping, dual driving, *colorum*, operator tactics and focusing. While many of the themes confirm the findings of earlier studies, some ridesharing tactics found in the Philippine context provide nuances that may offer insights on the drivers' use of ridesharing platforms. Specifically, these strategies suggest that users find new ways to use the technology to support their motivations, resulting in a notion deviant to the original purpose of ridesharing.

**Keywords** Ridesharing, Driver strategies, Tactics, Sharing Economy

## 1 INTRODUCTION

Ridesharing is one of the growing sharing economy which provided an alternative means of transportation in many developed and developing countries. It allows an individual to co-use a vehicle for a trip, arranged through a transportation network company (TNC) applications (e.g., Uber, Lyft, Grab), thereby sharing the costs with the owner. Ridesharing has played an important role in the transportation system today and new developments in technology and the social media has presented opportunities to increase ridesharing use worldwide.

The Philippines is one of the wide adopters of ridesharing services with an estimated 2.96 million users in 2018 and is expected to hit 5.4 million by 2022 (Statista 2018a). Consequently, the Philippines became the first country to develop nationwide ride-hailing regulations, which allowed app-based transportation services to operate legally anywhere in the nation (Toppa 2015). The increasing demand for mobility and the lack of adequate mass transport, especially in Metro Manila, was what apparently impelled the legalization of ridesharing services (Morales 2015).

As a result, several ridesharing companies have been established and created opportunities for partners, operators and drivers to provide transportation network vehicle services (TNVS). In October 2015, there were 3,499 applications for TNVS (Sauler 2015) and even with the stringent regulation for entry, TNVS applications pending the approval of the Land Transportation Franchising and Regulatory Board (LTFRB) have ballooned to 119,468 in 2018 (Yee 2018).

The proliferation of ridesharing services could be attributed to the economic benefits, in particular monetary gains, afforded to the drivers (Hamari et al. 2016; Hawlitschek et al. 2016; Malone and Dillahunt 2015; Tussyadiah 2015). For instance, about one-third of the Uber drivers in the United States engaged in the service to earn money while looking for a steady, full-time job (Frizell 2015). This is not inconsistent with the findings of Limpin (2018) who revealed that most Filipino drivers engage in ridesharing services because of the financial benefits they enjoy from the service.

Despite the confirmation of prior studies, there are limited researches that explores the various mechanisms employed by ridesharing drivers in order for them to achieve their goals. In particular, the studies concerning the ridesharing services in the Philippines focus on the comparison of the different ridesharing services with the conventional taxi services and other public means of transportation (Nistal 2016; Paronda et al. 2017, 2016) but did not further investigate the drivers' practices.

And so, this study asks: what are the tactics that the drivers employ in order to achieve their goals and decrease the hassles encountered in providing ridesharing services? By addressing this question, this study contributes to the growing literature on ridesharing applications by presenting findings of a series of research interviews with TNVS providers in Metro Manila Philippines, supplemented with a brief review of the academic literature on ridesharing.

## 2 REVIEW OF RELATED LITERATURE

### 2.1 Ridesharing

Ridesharing refers to a mode of transportation that allows an individual to co-use a vehicle for a trip thereby sharing the costs with the owner. Advantages of ridesharing for participants, to society, and to the environment include savings in travel cost and time while helping to eliminate traffic congestion, conserving fuel and reducing air pollution (Furuhata et al. 2013). It fills empty seats, maximizing vehicle occupancy and helps reduce vehicles on roadway (Shaheen 2014). Through ridesharing companies, non-professional drivers of private vehicles can now provide safe, reliable and affordable point-to-point rides and enable the riding public to efficiently get a ride with a tap on a smartphone.

A Statista report (2018b) shows that a worldwide user penetration rate of ridesharing services is at 9.8% in 2018 and is expected to hit 13.3% in 2022. In addition, the wide adoption of ridesharing services has gained a worldwide revenue of \$59,678 million in 2018 and is expected to show an annual growth rate of 16.3% leading to a market volume of \$109,050 million by 2022. The global revenue comparison also shows that most of the revenue is generated in China at a \$29,749 million in 2018.

### 2.2 Ridesharing in the Philippines

Ridesharing services has been gaining popularity as a viable means of transportation in many urban centers in the Philippines, particularly in Metro Manila which suffers from a severe transportation problem (Napalang and Regidor 2017). As a result of its wide adoption, the Philippines was one of the first countries to develop and implement a regulatory framework for TNCs on a national scale legalizing

app-based car-hailing operations in the country. Defined as “an organization using an online-enabled application or platform technology to connect passengers with drivers using their personal vehicles” (DOTC 2015), TNCs leverage on technology to provide on-demand transport services guaranteeing higher reliability and shorter wait times (Rayle et al. 2016).

### 2.2.1 TNCs in the Philippines

Founded in Malaysia, Grab is a smartphone-based hailing and booking service that operates in eight countries in South East Asia. It was introduced in Metro Manila, Philippines in 2013 and later on expanded its operations in other urban cities including Cebu City, Davao City, Baguio City and Iloilo City. Its services include GrabCar (private cars that can be booked through the platform), GrabTaxi (taxicabs booked through the platform), GrabShare (carpooling services) and GrabExpress (express delivery service) (Grab.com).

New players also entered the ridesharing market in the Philippines. Hype, a Filipino-owned company, launched its operations in Metro Manila in May 2018. The defining feature of Hype is that the public can book a ride through a Short Message Service (SMS), free of charge for both the rider and the driver. Similar with Grab, Hype also offers services such as carpooling, hailing private cars and taxicabs through the app (Hypetransport.com).

Owto, also a Filipino-owned company, started its operations in Metro Manila and parts of Bulacan, Cavite and Rizal in April 2018. Owto features a Silent Distress Signal which riders can use during emergencies while on trip, connecting the rider to the nearest law enforcement team. In addition, the Owto platform allows its riders to set a specific radius where they want to pick up and drop off riders (Owtoph.com).

To provide services in nearby cities and provinces, GoLag, short for “Go Laguna”, launched its operations in 2018 to provide services in Laguna, Bulacan, Cavite, Metro Manila and Rizal. GoLag promises lower rates compared to other TNCs, especially during the peak hours and a multi-tier incentive program with loyalty rewards that assures drivers a decent take-home pay (Golag.ph).

## 2.3 Driver Strategies

Ethnographic approaches have shed light on the different strategies made use of by ridesharing drivers. For instance, an ethnographic study on shared taxi drivers' orientations, concerns and practices has revealed the need to focus on the drivers' agency and tempo to allow them to locate passengers in a more ad hoc way (Kasera and Neill 2016). Anderson (2014) categorized drivers as incidentals (those who drive occasionally), part timers (those who use earnings from ridesharing to supplement their monthly income), and full timers (those who consider ridesharing as a job and use it as a primary source of income). In addition, the emergence of the ridesharing phenomenon has also created new labour opportunities and conditions of the driving work itself (Glöss et al. 2016).

Moreover, ridesharing promises to improve the livelihood of the drivers. A study on Chicago Uber partners showed that the use of ridesharing platform Uber helped them make more per hour, even after costs (\$16/hour after costs) compared to traditional taxi drivers (Hall and Krueger 2015). However, this does not necessarily apply for auto-rickshaw drivers in Bengaluru, India after adopting a P2P application, Ola (Ahmed et al. 2016). For this study, we look into qualitative data to make sense of the strategies and tactics used by ridesharing drivers in Metro Manila, Philippines as they make use of the service.

## 3 METHODOLOGY

This study used a qualitative, inductive approach to explore the different tactics employed by ridesharing drivers in the Philippines. Sampling was purposive. The respondents of this study must have an active registration with a TNC and must have had at least one year of experience as a TNVS provider in Metro Manila, Philippines.

A total of twenty (20) respondents participated in this study. Among the respondents, twelve (12) identified themselves as full time drivers which means that being a TNVS provider is their main job and they drive an average of 12 hours per day. Two (2) of the full time drivers were hired by operators and one (1) is both a driver and an operator. On the other hand, eight (8) among the respondents are driving part time, spending an average of five (5) hours per day working as a TNVS provider. All respondents were male. The respondents were recruited by requesting a ride using the Grab platform.

To collect information, in-depth interviews were conducted. This method was used following Seidman (1998) who stated “At the root of in-depth interviewing is an interest in understanding the experience of other people and the meaning they make of that experience” (p.3). Interviewing the varied experienced ridesharing drivers is expected to reveal the varying tactics they employ when providing ridesharing services. The interviews were semi-structured and participants were asked open-ended questions. Main questions were formulated by the researcher as a guide for the interview and further probing was done as needed. The questions focused on the perceptions, motivations, practices and tactics they employ when providing ridesharing services. The focus of the study are the drivers as an independent provider and did not include the perspective of the TNC where they are registered.

The interviews ranged from 30 minutes to one (1) hour in length. The interviews were audio-recorded with the consent of the participants while the researchers were taking down notes. The audio recordings were then fully transcribed and the researchers’ notes were prepared for data analysis.

The qualitative information obtained was coded, categorized, and analysed using “thematic analysis” (Braun and Clarke 2006). The process included familiarization of the data, coding, searching for themes, reviewing of the themes, defining and naming of the themes and reporting.

Q: What are your goals and how do you achieve them?	Codes
A: Right now, I need 50 trips to get the incentive. So in 3 days, I should do 20-20-10 or 15. If I want to rest on a Sunday, I need 20-25 trips per day from Monday to Saturday. But that’s difficult. Right now, I only have 19 trips and I started at 5:30AM. Once I complete 22 trips – I don’t like driving during the rush hour. I would rather drive beyond peak hours. You earn a lot during the rush hour because of the surge but you waste a lot of time. You’ll be stuck in traffic.	<ul style="list-style-type: none"> <li>• Incentives</li> <li>• Schedule</li> <li>• Target trips</li> <li>• Rush hour driving</li> <li>• Surge</li> <li>• Traffic congestion</li> </ul>

Table 1. Sample of initial coding of data

## 4 RESULTS

The following section presents the findings of this study.

### 4.1 Surge Chasing

To manage the fluctuating supply and demand for rides, TNCs implement surge pricing (Mankin et al. 2017). The surge pricing mechanism is a form of dynamic pricing which enables a temporary increase in the price in an area where the demand for rides is higher than the available cars on the road (Skjelvik et al. 2017).

*Surge chasing* is a strategy used by some ridesharing drivers to take advantage of the high surge prices. Three surge chasing tactics were identified including technology-assisted surge chasing, events-driven surge chasing and experience-based surge chasing.

#### 4.1.1 Technology-assisted Surge Chasing

Technology-assisted surge chasing is a tactic used by drivers to find surge areas using the ridesharing application. Many ridesharing platforms has a heatmap feature, a visualization tool which identifies areas in the city with higher current demand for rides. For instance, the Grab platform represents the heatmap in four different colors to represent the rider demand in a location. Areas shaded in red means that an area has a very high demand, yellow represents the high demand area, green has a medium-level need for rides and spots with no color mean that there are enough drivers in that area to meet the demand.

The drivers use the demand heatmap feature to identify the high demand area and drive to that location. For instance, Bernard (*all the driver names used in this paper are fictitious*), a full time driver, shares “I use this map to find the location with the highest surge rate. Here, I can see the surge multiplier and I know that the fares are higher in this area”.

#### 4.1.2 Events-driven Surge Chasing

Higher surge rates are observed during peak hours when fares increase up to twice its normal price. Marlon, a full time driver, takes advantage of this increased price as he relates, “I prefer driving during the rush hour. A lot of people book a ride during this time even if the surge rates are high.”

An increase in the surge rate is also apparent during the holiday season. Leo, a full time driver, is among the drivers who prefer driving during the Christmas season or other holidays as it guarantees a higher fare price. However, in December 2016, the LTFRB received complaints about outrageous price surges ranging from P2000 to P28000 during the holiday season (Dela Paz 2016). As a result, the LTFRB ordered an immediate cap on the surge pricing schemes implemented by the TNCs (Yee 2016).

Surge chasing drivers also keep track of major events like concerts, conventions, festivals, public parties, sporting events, etc. A significant number of people looking for rides during these events ensure a surge in rider demand. For instance, Ryan, a part time driver, relates that he stays in big malls where concerts are held. In addition, John, a part time driver shares, *“One of the best times to go online is during the wee hours of Saturdays where many party goers are trying to find a ride home and there are no other means of transportation available.”*

#### **4.1.3 Experienced-based Surge Chasing**

An availability check survey revealed that certain areas in Metro Manila such as Makati, Taguig, and Pasay has higher surge rates than other places (Paronda et al. 2016). While others use the demand heatmap feature of the app to identify the high demand areas, for full time and more experienced drivers like Nelson, finding these spots is easy as he shared, *“If you’ve been driving for a long time. You’ll know where to go to get more passengers.”*

In addition, ridesharing drivers are former taxi drivers for several years. With their experience, many of these drivers know the areas in the city where there is a guaranteed demand for trips. For instance, Khalid, a full time driver, relates that he used to be a taxi driver and knows the streets of Metro Manila well. He stays in certain areas like the big malls where he observed a high demand for cars especially during weekends.

## **4.2 Request Skipping**

Request skipping is a strategy used by drivers to avoid surge areas and times. The platform allows a driver to accept, cancel or skip a trip request. Cancelling a trip request, however, negatively affects a driver’s rating which may result to disqualification for cash incentives. Instead, drivers skip trip requests based on the traffic condition of an area, weather, and the distance.

### **4.2.1 Traffic Skipping**

While some drivers chase high surge areas, some opt to avoid them as these places are usually heavily-congested. Remigio, a part time driver, relates that drivers may get stuck because of the heavy traffic thus wasting time and fuel. In addition, some drivers prefer going active outside the peak hours when traffic has subsided even if it also means that the fares are back to its normal rate. Reynaldo, a part time driver, further shares, *“I only drive at night when traffic is lighter.”*

Drivers who avoid surge times take on the challenge of finding spots where there are few-to-no drivers around. These places may have lower rider demand but it gives them a steady business because there is little to no competition. Chinggem, a part time driver, indicates, *“I like staying in less busy areas. There are fewer requests but I’m not stressed and I can go home anytime because this is near my place.”*

### **4.2.2 Weather-related Skipping**

Habitual transit users are found to use ridesharing services in specific situations such as in bad weather (Nistal 2016). During these times, surge pricing is in effect to encourage more drivers to become available.

However, some drivers skip trip requests during a bad weather condition, in particular during a typhoon, as many streets in Metro Manila can be flooded. For example, Renato, a part time driver, shares that going out in a bad weather is a hassle. He further relates, *“It’s inconvenient to drive when it’s raining. My car might get trapped in the flood and it’s not worth the payment to have it fixed or cleaned.”*

### **4.2.3 Distance-based Skipping**

The drivers also tend to skip requests based on some factors like pick up location, destination and times of day. Many of the drivers indicate that at the end of their working day, they can set a *home* destination before finally going offline. With this, they only accept requests which are towards their *home* destination and skip those which are going to the opposite direction. Ryan, a part time driver shares, *“When I started as a partner, I got a request that was too far from my target home destination. I got home really late so I had to skip work the next morning... So now, I skip those requests.”*

Moreover, drivers also consider the pickup location of the rider. Most drivers are not willing to accept trips whose pickup location is more than 2kms. Leo, a full time driver, indicates, *"We were told that pick up location should only be within 1km. But sometimes, the pick up is 4km away."*

Lastly, drivers who avoid surge areas are those who drive for the enjoyment of driving, getting out of their routine, exploring the city and having some nice conversations. For instance, Raymond, a part time driver relates that he enjoys meeting different types of people when he's driving. Israel, on the other hand, drives part time and enjoys ridesharing because he can help and serve the riders.

### 4.3 Dual Driving

In the Philippines, there are four registered TNCs including Grab, Owto, GoLAg, and Hype (San Juan 2018). In order to entice more partners, these TNCs employ different marketing strategies such as weekly incentives, referral incentives, signup bonuses and other promotions.

To take advantage of these benefits and to ensure a higher income, drivers have devised a strategy called dual driving. Dual driving entails that a driver is registered to at least two TNC and uses their platforms simultaneously to earn more.

#### 4.3.1 TNC Hopping

TNC hopping is a common tactic ridesharing drivers use to ensure a higher income. A driver who hops from one TNC to another takes advantage of the TNC's offer, particularly weekly cash incentives. Benny, a full time driver, relates that he was pirated from another TNC. He further shares, *"I started in [TNC1] and then [TNC2] pirated us. They offered a big incentive so we were encouraged to join. My old TNC had a good incentive program, but this new TNC gave us two sets of incentives... The income was so good I was able to buy my own car."*

In addition, drivers hop to another TNC who deducts a lower commission rate. Israel indicates, *"I'm moving to TNC2 by the end of the month. Their commission rate is way lower than my current TNC. My take home pay will be better."*

#### 4.3.2 Dual-apping

Consequently, drivers who are registered in multiple TNCs employ a tactic called dual-apping. Dual-apping allows them to have at least two active ridesharing accounts using different platforms. Dual drivers enjoy more trip requests and a higher revenue, as they get the opportunity of serving more passengers from multiple platforms.

Drivers switch from one application to another for two reasons: 1. Trip requests in one app is low; 2. Another TNC offers a better cash incentive. Dual drivers activate the platform where he will enjoy more benefit. Francis, a full time driver, shares *"If the business is slow in [TNC1], I go online on another platform."* Roberto, another full time driver, further adds, *"We don't get topups from the other TNC that's why I moved here."*

### 4.4 Operator Tactics

The business model of many ridesharing companies allow individuals who owns a car to earn money by providing ridesharing services. Consequently, it lets people who needs a ride to book these drivers via a mobile platform. However, the business model of many TNCs in the Philippines has seemingly changed as operators have emerged and started embracing the regular taxi operator strategy to earn more income.

An operator is a private car owner who dispatches multiple cars for ridesharing hiring drivers who may be a relative, a peer, or in some cases, previous taxi drivers to drive their car and earn money for them. For instance, Francis shared, *"I registered two cars and let my cousins drive. Then I got another one and drive it myself."*

#### 4.4.1 Boundary System

Operators have also adopted the payment schemes employed by regular taxi operators to govern the compensation of their drivers. One common payment scheme is the boundary system. In the boundary system, the operator sets a daily quota which the driver has to meet by the end of the day. The driver's daily earnings are remitted to the operator less the excess of the boundary which represents the driver's compensation. For instance, Ruel, a full time driver hired by an operator, was given a P1000 daily boundary. Anything in excess of the P1000 will be Ruel's share of the income.

#### 4.4.2 *Hatian* System

On the other hand, in a *hatian* (translated as “sharing” in English) system, the operator and the driver gets into a sharing agreement. The agreement may be 50-50 where they equally divide the daily earnings and expenses or 60-40 scheme where the operator gets 60% of the earnings and will shoulder all expenses and 40% goes to the driver. Bernard, a full time driver, shares, “*I and my operator agreed to equally share all earnings, maintenance costs and incentives*”.

#### 4.5 *Colorum*

Although ride-sharing services has been legalized in the Philippines, the LTFRB has suspended the acceptance and approvals of new TNVS applications pending the review of the policies governing app-based hailing services in the country. More than 15,000 out of 32,000 TNVS transport franchise requests have been dismissed leaving thousands of pending applications (Cordero 2017). However, many TNCs have continued to accept applications and allowing their partners to operate which further introduced *colorum* partners. *Colorum* partners may be fined as much as P200,000 when apprehended.

##### 4.5.1 *Colorum* Driving

Similarly, *colorum* driving may also refer to drivers taking trips on the side to earn more money. Some drivers have established a patron-client relationship with their drivers. Because of this, the drivers encourage their patrons to reserve their ride by texting or calling the driver ahead of time and not by requesting using the ridesharing app. Such tactic allows the partners to save the TNC commission taken out from the total amount of the fare. Ronaldo, a full time driver, shares “*My neighbour rides with me every day without using the app. I pick her up on my way out and drops her off to her destination.*”

##### 4.5.2 *Kontrata* System

The *kontrata* (translated as “contract” in English) system is a tactic employed by drivers for trips whose destinations are outside Metro Manila. The long-distance trips are not beneficial to the drivers as there is no guarantee of having a rider on the return trip. The *kontrata* tactic may happen before or upon pick up. Negotiating before the pick up involves the driver sending a message to the rider through the app or SMS. Once the rider agrees to the terms, the driver goes to the pick up location and asks the rider to cancel the booking request.

On the other hand, other drivers negotiate upon picking up the passenger. Once the driver is in the pick up location, the driver and the passenger negotiates the terms and once an agreement has been reached, the driver asks the rider to cancel the booking request. Leo shares, “*I ask the rider if they could pay a little bit more than what the app showed. Because who will cover my expense going back? I might not get a rider.*”

Such tactic is deemed beneficial for both the driver and rider, but may be detrimental to the TNC. The platform determines the fare for the trip and is used as a basis for the negotiation. While both the driver and the rider may save from the negotiation, the TNC loses its commission from the trip. Ruel shares “*Sometimes, I get requests and the drop off is outside Metro Manila... I ask the rider if he/she is willing to cancel the booking and I will give a discount. If the rider agrees, I save the commission the TNC is supposed to deduct. It's a win-win.*”

#### 4.6 Focusing

Focusing is a strategy that involves limiting the driver's ridesharing activity based on factors like time, number of trips and area. The tactics that emerged include time-based focusing and area-based focusing.

##### 4.6.1 Time-based Focusing

For full time drivers, they consider ridesharing as their primary source of income and as a result, they spend an average of 12 driving hours per day. On the other hand, part time drivers who spend an average of five (5) hours per day, use their earnings in ridesharing to supplement their monthly income, to pay personal expenses or to share the costs of their daily trip to and from work. Raymond, a part time driver, shares, “*A relative encouraged me to sell my old car and to buy a new one which I can register to a TNC. I use whatever I earn from rideshare driving to pay the car's amortization.*”

Incentives are regularly given by TNCs to encourage its partners to make more trips. They set a quota which the partners must reach in order to qualify for the cash incentive. Consequently, drivers set their personal daily trip target to maximize their earnings and ultimately, to reach the required quota. Ronaldo shares, “*If I want to rest on a Sunday, I have to make 20-25 trips per day.*”



#### 4.6.2 Area-based Focusing

Area-based focusing is a tactic used by drivers to maximize high demand areas. Drivers focus their destination in common business districts where there are steady trip requests and where trips tend to be short and within the area only. Khalid shares *“I get a lot of pool requests in areas where the business process outsourcing (BPO) companies are. A lot of the call center agents book a ride especially at night.”* In addition, Ronaldo relates that the passenger turnover in these areas is fast which makes it easier for them to reach their daily trip target in a shorter period of time.

In addition, once the driver gains his momentum, staying online and in areas where he gets a continuous trip request is necessary. Marlon shares *“Once I drop a passenger off, another request comes in. Sometimes, even before I drop the passenger off... If you stop, you’ll lose your momentum and the chance to get more trips.* In addition, Darwin, shares *“Sometimes I drive for more than 24 hours. I rest a little bit then go out again. Sometimes, while waiting for a request, I’d pull over and take a nap – while the app is online. When I get a request, I go again.”*

## 5 DISCUSSION

This study conceptualized from interview data six themes that describe the different strategies and tactics drivers employ when providing ridesharing services. These themes include Surge Chasing, Request Skipping, Dual Driving, Operator Tactics, *Colorum* and Focusing. While some of the themes confirm the findings of earlier studies (see Table 2), ridesharing tactics in the Philippine context provide nuances that may offer insights on the use of ridesharing platform. Specifically, these tactics suggest that users find new ways to use the technology to support their motivations.

Driver Strategies	Driver Tactics	Tactics Found in the Literature
Surge Chasing	Technology-assisted surge chasing	Chen et al. 2016
	Events-driven surge chasing	Chen et al. 2016
	Experience-based surge chasing	Anderson 2014
Request Skipping	Traffic skipping	Ahmed et al. 2016
	Weather-related skipping	Brodeur and Nield 2018
	Distance-based skipping	Ahmed et al. 2016; Brodeur and Nield 2018; Kasera and Neill 2016
Dual Driving	TNC hopping	Jiang and Zhang 2018
	Dual-apping	Jiang and Zhang 2018
Operator Tactics	Boundary System	
	Hatian System	
<i>Colorum</i>	<i>Colorum</i> Driving	
	<i>Kontrata</i> System	
Focusing	Time-based focusing	Anderson 2014; Kasera and Neill 2016
	Area-based focusing	Ahmed et al. 2016; Kasera and Neill 2016

Table 2 Themes in the Qualitative Data: Driver Strategies and Tactics

Surge chasing has been observed amongst Uber drivers who further extend their sessions and provide significantly more rides as a response to higher surge rates (Chen et al. 2016). In addition, rickshaw drivers using the Ola platform in Bengaluru, India also prefer driving in locations where a higher passenger demand is observed. Some rickshaw drivers were also observed to avoid these locations depending on the traffic condition (Ahmed et al. 2016).

The result of this study also reveals that some drivers avoid driving during bad weather conditions. However, this result differs to observed increase in the number of Uber rides in New York City during rainy days (Brodeur and Nield 2018). In addition, Filipino riders tend to become undecided about booking a rideshare during rainy days because of the surge rate (Nistal 2016).

*Colorum* driving is one of the tactics that TNVS providers employ to supplement their daily earnings. The term *colorum* is a slang for illegal public land transport in the Philippines. However, in the context of ridesharing, *colorum* activities refer to a driver going offline and doing sideline trips. These trips are not recorded in the app thus allowing the drivers to save the 20-25% TNC fee and generate extra income.

In addition, the *kontrata* system, has emerged as a tactic amongst ridesharing drivers. The *kontrata* system is a common practice amongst taxi drivers in Metro Manila where a passenger pays a fixed and often excessively high fare. The *kontrata* system has been a common problem in riding a regular taxi in Metro Manila as most drivers refuse to use the meter and demand the passenger to get into a “*kontrata*” (Nistal 2016). With *colorum* driving and the *kontrata* system emerging in ridesharing services, the passengers may perceive the drivers as abusive and snobbish leading to the detriment of the service.

Moreover, ridesharing is assumed to reduce car use and ownership as it is a shared mode of transportation rather than purchasing new vehicles (Jin et al. 2018). However, the result of this study reveals that some of the practices do not conform with the true essence of ridesharing. The findings reveal that some ridesharing partners in the Philippines were encouraged to buy new cars with the intention to use them as transport network vehicle. As a matter of fact, a report reveals that TNVS has boosted the car sales in the Philippines (Lorenciana 2017), with small sedans being the most popular among prospect TNVS providers.

The adoption of ridesharing services in the country has further led to the emergence of operators who function similarly with regular taxi operators deploying multiple vehicles to provide ridesharing services. As such, the experience of ridesharing in the Philippines, particularly in Metro Manila, does not reflect one of the primary objectives of ridesharing services which is to reduce car use and ownership. In fact, it can be argued that the popularity of ridesharing services has led to the increase of vehicles roaming the streets of Metro Manila as the operations of TNCs does not differ from that of taxis with most ridesharing drivers driving full time rather than part time (Paronda et al. 2017).

The above-mentioned practices finally reveal that the drivers were primarily interested in increasing their earnings from ridesharing. Therefore, ridesharing in Metro Manila is considered as “entrepreneurial” (Nistal 2016). However, “entrepreneurial” drivers are not only true for developing countries like the Philippines but is also proliferated in developed countries such as the United States (Anderson 2014).

## 6 CONCLUSION AND FUTURE DIRECTION

In conclusion, this study has identified dominant driver strategies and tactics in the context of the Philippine ridesharing economy. Some of the strategies, including surge chasing, request skipping, dual driving and focusing, and their variants were found to confirm findings of previous studies.

Nevertheless, the novelty of this paper lies in the strategies and tactics that were found to be unique in the Philippine setting. These strategies suggest that users find new ways to use the technology to support their motivations, resulting in a notion deviant to the original purpose of ridesharing. In addition, the tactics like *colorum* driving, the *kontrata* system, the boundary system, *hatian* system are not unfamiliar for Filipino drivers and commuters as these are common tactics employed by conventional taxi drivers and other public utility vehicle providers.

Furthermore, the findings of this study may have implications towards the improvement of ridesharing services in the country. For instance, the result of this study could help the TNCs to provide better services to help their partners in achieving their goals and to ensure that tactics that negatively impact both the drivers and the riders will be avoided.

This study is not without limitation. The respondents of this study are limited to a small sample of ridesharing drivers within Metro Manila only. Therefore, further studies with a larger sample size including drivers in other urban areas where ridesharing services are available should be conducted. Finally, because this research is exploratory in nature, future research should test and verify the propositions in different contexts to support the applicability of the scales and generalizability of the findings in this study.

## 7 References

- Ahmed, S. I., Bidwell, N. J., and Neill, J. O. 2016. “Peer-to-Peer in the Workplace : A View from the Road,” *Proceedings of the SIGCHI Conference on Human Factors in Computing Systems*. (<https://doi.org/10.1145/2858036.2858393>).
- Anderson, D. N. 2014. “Not Just a Taxi? For-Profit Ridesharing, Driver Strategies, and VMT,” *Transportation* (41:5), pp. 1099–1117. (<https://doi.org/10.1007/s11116-014-9531-8>).
- Braun, V., and Clarke, V. 2006. “Using Thematic Analysis in Psychology,” *Qualitative Research in Psychology* (3:2), pp. 77–101. (<https://doi.org/10.1191/1478088706qp0630a>).

- Brodeur, A., and Nield, K. 2018. "An Empirical Analysis of Taxi, Lyft and Uber Rides: Evidence from Weather Shocks in NYC R," *Journal of Economic Behavior and Organization* (152), pp. 1–16.
- Chen, M. K., Sheldon, M., Bell, F., Chevalier, J., Hall, J., Nalebuff, B., Snider, C., and Spaeth, M. 2016. "Dynamic Pricing in a Labor Market: Surge Pricing and Flexible Work on the Uber Platform," in *EC '16 Proceedings of the 2016 ACM Conference on Economics and Computation*, pp. 455–455.
- Cordero, T. 2017. "LTFRB Dismisses 15,000 Franchise Applications for Uber and Grab | Money | GMA News Online," *GMA News Online*. (<http://www.gmanetwork.com/news/money/companies/594791/ltfrb-dismisses-15-000-franchise-applications-for-uber-and-grab/story/>, accessed March 2, 2018).
- Departemen Transportation and Communication Philippines. 2015. "Department Order No.97-1097 to Promote Mobility," *Department of Transportation and Communications (DOTC)*. (<http://dotr.gov.ph/index.php/2014-09-03-06-32-48/2014-09-03-06-44-58#y2015>).
- Frizell, S. 2015. "All the Things You Ever Wanted to Ask Your Uber Driver, Answered | Time.Com," *Time*. (<http://time.com/3678507/uber-driver-questions/>, accessed August 4, 2018).
- Furuhata, M., Dessouky, M., Ordóñez, F., Brunet, M.-E., Wang, X., and Koenig, S. 2013. *Ridesharing: The State-of-the-Art and Future Directions*.
- Glöss, M., Mcgregor, M., and Brown, B. 2016. "Designing for Labour: Uber and the On-Demand Mobile Workforce," in *CHI '16 Proceedings of the 2016 CHI Conference on Human Factors in Computing Systems*, pp. 1632–1643. (<https://doi.org/10.1145/2858036.2858476>).
- Hall, J. V., and Krueger, A. B. 2015. "An Analysis of the Labor Market for Uber's Driver-Partners in the United States."
- Hamari, J., Sjoikint, M., and Ukkonen, A. 2016. "The Sharing Economy: Why People Participate in Collaborative Consumption," *Journal of the Association for Information Science and Technology* (67:9), pp. 2047–2059. (<https://doi.org/10.1002/asi.23552>).
- Hawlitsek, F., Teubner, T., and Weinhardt, C. 2016. "Trust in the Sharing Economy," *Die Unternehmung* (70:1), pp. 26–44. (<https://doi.org/10.5771/0042-059X-2016-1-26>).
- Jiang, W., and Zhang, L. 2018. "Evaluating the Effects of Double-Apping on the Smartphone-Based E-Hailing Service: A Simulation-Based Study," *IEEE Access* (3536:c), pp. 1–1. (<https://doi.org/10.1109/ACCESS.2018.2797207>).
- Jin, S. T., Kong, H., Wu, R., and Sui, D. Z. 2018. "Ridesourcing, the Sharing Economy, and the Future of Cities," *Cities* (October 2017), Elsevier, pp. 0–1. (<https://doi.org/10.1016/j.cities.2018.01.012>).
- Kasera, J., and Neill, J. O. 2016. "Sociality, Tempo & Flow: Learning from Namibian Ride-sharing," *Proceedings of the First African Conference on Human Computer Interaction - AfriCHI'16*.
- Limpin, L. 2018. "Investigating the Factors Influencing the Participation in Ride-Sharing: The Case of the Philippines," in *Proceedings of 2018 the 8th International Workshop on Computer Science and Engineering (WCSE 2018)*, Bangkok, pp. 374–379.
- Lorenciana, C. 2017. "Business Uber and Grab Boost Car Sales," *The Freeman*. (<https://www.pressreader.com/philippines/the-freeman/20170316/282660392231134>).
- Malone, A., and Dillahunt, T. R. 2015. "The Promise of the Sharing Economy among Disadvantaged Communities," in *ACM Human Factors in Computing System*. (<https://doi.org/10.1145/2702123.2702189>).
- Mankin, J. A., Rivas, J. A., and Jewell, J. J. 2017. "Ride Sharing: A Good Choice for Entrepreneurs?," *Journal of Case Studies* (35:2).
- Morales, N. J. 2015. "Philippines Issues Rules on Ride-Sharing Services, as Taxis Threaten Court | Reuters," *Reuters*. (<http://www.reuters.com/article/us-philippines-uber-idUSKBN0NY15Y20150513>).
- Napalang, M. S., and Regidor, J. R. 2017. "Innovation Versus Regulation: An Assessment of the Metro Manila Experience in Emerging Ridesourcing Transport Services," *Journal of the Eastern Asia Society for Transportation Studies* (12).
- Nistal, P. D. 2016. "Comparative Study of Uber and Regular Taxi Service Characteristics," in *23rd Annual Conference Transportation Science Society of the Philippines*.

- Paronda, A. G. A., Regido, J. R. F., and Napalang, M. S. G. 2016. *Comparative Analysis of Transportation Network Companies (TNCs) and Conventional Taxi Services in Metro Manila*, (August).
- Paronda, A. G., Paronda, A. G. A., and Gaabucayan-napalang, M. S. 2017. *An Exploratory Study on Uber, GrabCar, and Conventional Taxis in Metro Manila An Exploratory Study on Uber, GrabCar, and Conventional Taxis in Metro Manila*, (September).
- Dela Paz, C. 2016. "LTFRB Warns Uber, Grab over Unreasonable Price Surge," *Rappler*. (<https://www.rappler.com/business/156495-ltfrb-grab-uber-price-surge>, accessed March 12, 2018).
- Rayle, L., Dai, D., Chan, N., Cervero, R., and Shaheen, S. 2016. "Just a Better Taxi? A Survey-Based Comparison of Taxis, Transit, and Ridesourcing Services in San Francisco," *Transport Policy* (45), Elsevier, pp. 168–178. (<https://doi.org/10.1016/j.tranpol.2015.10.004>).
- San Juan, A. D. 2018. "3 Local TNCs Set to Compete with Grab » Manila Bulletin News," *Manila Bulletin*. (<https://news.mb.com.ph/2018/04/05/3-local-tncs-set-to-compete-with-grab/>, accessed August 3, 2018).
- Sauler, E. 2015. "LTFRB Exec: Suspend Franchise Applications for App-Based Vehicles | Inquirer News," *Philippine Daily Inquirer*. (<http://newsinfo.inquirer.net/729239/ltfrb-exec-suspend-franchise-applications-for-app-based-vehicles>).
- Shaheen, S. A. 2014. *Introduction to Ridesharing : Overview of Definitions and Setting the Stage*.
- Skjelvik, J. M., Erlandsen, A. M., and Haavardsholm, O. 2017. "ENVIRONMENTAL IMPACTS AND POTENTIAL OF THE SHARING ECONOMY." (<https://www.diva-portal.org/smash/get/diva2:1145502/FULLTEXT01.pdf>).
- Statista. 2018a. "Ride Sharing - Philippines | Statista Market Forecast." (<https://www.statista.com/outlook/368/123/ride-sharing/philippines>, accessed August 5, 2018).
- Statista. 2018b. "Ride Sharing - Worldwide | Statista Market Forecast." (<https://www.statista.com/outlook/368/100/ride-sharing/worldwide#market-users>, accessed August 6, 2018).
- Toppa, S. 2015. "Uber Is Now Legal Everywhere in the Philippines | TIME," *Time*. (<http://time.com/3854958/uber-legal-philippines-ride-hailing/>).
- Tussyadiah, I. P. 2015. "An Exploratory Study on Drivers and Deterrents of Collaborative Consumption in Travel," in *Information and Communication Technologies in Tourism 2015*, Springer.
- Yee, J. 2016. "After LTFRB Warning, Grab, Uber Put Cap on Price Surges | Inquirer News," *Inquirer*. (<http://newsinfo.inquirer.net/856560/after-ltfrb-warning-grab-uber-put-cap-on-price-surges>, accessed March 15, 2018).
- Yee, J. 2018. "LTFRB Clarifies Who Can Apply First for TNVS Franchise | Inquirer News," *Inquirer*. (<http://newsinfo.inquirer.net/965903/ltfrb-clarifies-who-can-apply-first-for-tnvs-franchise>, accessed June 25, 2018).

**Copyright:** © 2018 Limpin & Sison. This is an open-access article distributed under the terms of the [Creative Commons Attribution-NonCommercial 3.0 Australia License](https://creativecommons.org/licenses/by-nc/3.0/), which permits non-commercial use, distribution, and reproduction in any medium, provided the original author and ACIS are credited.

# Self-organizing Service Ecosystems: Exploring a New Concept for Service Science

## **Maria Veronica Torres Pena**

School of Computing and Information Systems  
The University of Melbourne  
Melbourne, Australia  
Email: mtorres2@student.unimelb.edu.au

## **Christoph F. Breidbach**

School of Computing and Information Systems  
The University of Melbourne  
Melbourne, Australia  
Email: christoph.breidbach@unimelb.edu.au

## **Andrew Turpin**

School of Computing and Information Systems  
The University of Melbourne  
Melbourne, Australia  
Email: aturpin@unimelb.edu.au

## **Abstract**

The rapid advancements on digital technologies have positioned digital transformation as a central topic of interest to information systems (IS) researchers. However, our understanding of the nature, extent and dynamics of digital service ecosystems remains limited. This short paper contributes to IS and service science research by introducing the conceptualization of self-organizing service ecosystem as an analytical lens for understanding digital transformative phenomena in service ecosystems. To achieve this, we draw on the most recent narrative of value co-creation from service-dominant logic and on key definitions from the theory of self-organization. This paper also discusses future research directions emphasizing on the role and impact of technology in self-organizing service ecosystems.

**Keywords** self-organizing, service ecosystems, digital transformation, service-dominant logic, fintech

## 1 Introduction

Digitization is affecting every sector of every economy (Rai 2016). For example, in the case of financial services, new offerings like crowdfunding (e.g., GoFundMe) or peer-to-peer (P2P) lending (e.g. LendingClub) are two areas where information systems (IS) led to the rise of financial technology or ‘Fintech’ (Breidbach and Ranjan 2017). However, while digital transformation has been a topic of interest to IS researchers for a long time (Agarwal and Lucas Jr 2005), our understanding of the factors that enable the emergence of new digital service ecosystems like those prevalent in Fintech remains limited (Lusch and Nambisan 2015). For one, the conceptual boundaries of digital transformation itself are poorly understood (Nambisan et al. 2017), which makes it necessary to adopt novel research designs; for example through macro-lenses on digital transformation (Agarwal and Lucas Jr 2005), by deemphasizing the prevailing focus on IS artefacts (De Sanctis 2004), by utilizing theoretical lenses stemming from other disciplines (Rai 2016), or by adopting new research methods (Antons and Breidbach 2018). In fact, increasing the impact of IS research associated with digital transformation (Agarwal and Lucas Jr 2005) is such a significant challenge for our discipline that Rai recently called for future work to “be at the forefront of knowledge creation pertaining to transformative digital phenomena” (2016, p. v), especially as they pertain to the service sector (Rai 2016, p. iv). Here, we contribute to this challenge.

In the broadest sense, our short conceptual paper contributes to the discourse associated with the digital transformation of service firms in the IS and service science literature by developing and introducing the novel concept of self-organizing service ecosystems. Self-organizing service ecosystems are able to emerge, adapt, and evolve in the absence of any external impositions. We argue that self-organizing service ecosystems represent a novel conceptual lens that addresses the challenges currently associated with IS research related to digital transformative phenomena: self-organizing service ecosystems provide the much-needed macro-lens (Agarwal and Lucas Jr 2005), deemphasize the focus on IS (De Sanctis 2004), and accomplish this by building on self-organization theory (Haken 2006) and service science (Vargo and Lusch 2017), both of which stem from outside the IS discipline (Rai 2016). As such, our present work offers three distinct contributions to IS scholarship.

First, by developing and introducing self-organizing service ecosystems in the IS literature, we provide a new concept and terminology to study digital transformative phenomena in service contexts more broadly. Our present work relies on a mid-range theorizing approach (Vargo and Lusch 2017), which integrates self-organization theory (Haken 2006) with digital transformation research, and uses Fintech as our contextual setting. As such, we address gaps in knowledge related to the understanding of technology-enabled multi-actor service ecosystems highlighted in both, the service science (Ostrom et al. 2015; Vargo and Lusch 2017) and the IS literature (Lusch and Nambisan 2015; Nambisan et al. 2017). In addition, the Fintech context is uniquely suited for our research approach due to its complexity, IS-dependency, and transformative potential in reshaping the financial service industry more broadly.

Second, we outline the characteristics of self-organizing service ecosystems in a coherent conceptual framework, which is capable of explaining the societal and technological transformations driven by IS more generally. Our framework offers new insights into how IS, like those enabling Fintech platforms, may facilitate and transform value cocreation in service ecosystems (Storbacka et al. 2016), which addresses current gaps in knowledge related to the still limited understanding of technology in value cocreation (Ostrom et al. 2015), and especially in the context of technology facilitating the integration and coordination efforts required in complex service settings that consist of multiple actors and networks (Bharadwaj et al. 2013). Our third, and final contribution, stems from future research opportunities at the intersection of IS and service science.

This paper is organized as follows: first, we delineate a framework consisting of five characteristics underpinning self-organizing service ecosystems and, second, demonstrate its theoretical applicability using Fintech as a context. Finally, we discuss our findings and future research directions resulting from this perspective.

## 2 Characterizing Self-Organizing Service Ecosystems

Service-dominant (SD) logic (Vargo and Lusch 2008) is an evolving metatheoretical framework differing from the firm-centric, goods-dominant (GD) logic. It positions all economic activity as a service – for – service exchange and considers all interacting actors as co-creators of value (Vargo and Lusch 2008). SD logic introduced the service ecosystem concept into the Marketing discipline, and defined it as “system[s] of resource-integrating actors connected by shared institutional logics and mutual value creation through service exchange” (Vargo and Lusch 2016, p. 161). Although this definition is

increasingly used in IS research (Breidbach and Ranjan 2017; Lusch and Nambisan 2015), in-depth explorations of its underlying premises are scarce. Specifically, the underlying characteristics of self-containment and self-adjustment that Vargo and Lusch (2017) mention have only been referenced by Storbacka et al. (2016) to date. Here, we argue that exploring the self-organizing nature of service ecosystems (i.e., its self-containment and self-adjustment), is a fundamental prerequisite when examining the role and impact of technology within service ecosystems (Nambisan and Sawhney 2011; Storbacka et al. 2016; Vargo and Lusch 2016; Vargo and Lusch 2017). This is because self-organization provides an analytical lens that focuses on the integration and coordination efforts required for dealing with multiple actors, networks, and processes - common consequences of technology-infusion in service (Bharadwaj et al. 2013; Breidbach and Maglio 2016). Understanding the processes and mechanisms of self-organization in service ecosystems is therefore a key enabler to gain a better understanding of digital transformative phenomena in IS research, the orchestration of value co-creation (Breidbach et al. 2016), but also for improving the still limited understanding of the role of technology in value cocreation (Ostrom et al. 2015).

Understanding the characteristics of self-organizing service ecosystems is a significant research problem, requiring interdisciplinary research (Rai 2016). Here, we draw on insights from self-organization theory, which has already been applied in physics (Haken 1977), computer science (Musil et al. 2015), management (Coleman 1999), and the social sciences (Fuchs 2006). Taking from literature dedicated to self-organization theory, Table 1 provides an overview of existing definitions of self-organizing systems. We highlight key characteristics.

Definition of Self-Organizing System	Key Characteristic
“A system is self-organizing in the sense that it changes from ‘parts separated’ to ‘parts jointed’... changing from a bad organization to a good one” (Ashby 1962, pp. 266-267).	Local interactions, emergence
“Complex adaptive systems that display emergent behaviour” (Johnson 2002, p. 18).	Complexity, emergence, adaptiveness
“A system is self-organizing if it acquires a spatial, temporal or functional structure without specific interference from the outside... meaning that the structure or functioning is not impressed on the system, but that the system has acted upon from the outside in a nonspecific fashion” (Haken 2006, p. 11).	Emergence, distributed control
“System properties emerge due to the local interactions among the elements, without any external command, so the mechanism is called self-organization” (Erdi 2008, p. 19).	Local interactions, emergence, distributed control
“Self-organizing systems... change their internal structure and their function in response to external circumstances... elements of a system are able to manipulate or organize other elements of the same system in a way that stabilizes either structure or function of the whole against external fluctuations” (Banzhaf 2009, p. 2).	Adaptiveness, distributed control

*Table 1. Characteristics of Self-Organizing Service Ecosystems*

By identifying and exploring the characteristics of self-organization, we are able to refine the understanding of service ecosystems more broadly, and align the emerging discourse stemming from Marketing research with the IS discipline. In what follows, we analyze each characteristic of self-organizing service ecosystems (complexity, emergence rising from local interactions, adaptiveness and distributed control). Following suggestions by (Vargo and Lusch 2017), we accomplish this by using a mid-range theorizing approach, which bridges theory and practice by applying the meta-theories of self-organization to the empirical context of Fintech services.

## Complexity

Self-organizing service ecosystems are complex because they (1) have multiple elements; (2) are nested systems; and (3) their elements display nonlinear interactions due to feedback loops (Ashby 1962; Banzhaf 2009; Johnson 2002). The service science literature already characterizes service ecosystems as complex (Spohrer et al. 2007), however, it does not specify how individual components of complex systems are embedded in service ecosystems, nor how digital technology is affecting individual components. We now address this shortcoming.

Digitally-enabled service platforms like LendingClub allow previously disconnected economic actors to build, and interact via a digital service ecosystem. With its 2 million users that perform roles of borrowers and lenders (LendingClub 2018), it is evident that the service ecosystem underpinning LendingClub satisfies the first criteria of complexity. Furthermore, an individual user can simultaneously engage in multiple loan transactions, thus creating multiple, overlapping, and nested service ecosystems, thus satisfying the second criteria characterizing a complex system. Fast database technology allows easy tracking of these interactions. Finally, the service ecosystem displays non-linear dynamics due to feedback loops. Feedback occurs both (1) between actors on both lending and borrowing abilities and honesty, and (2) between actor and service ecosystem levels, as LendingClub changed the loan portfolio composition due to high levels of default in high risk loan categories. In this sense, feedback could take the form of institutions (rules, norms, practices, beliefs) and institutional arrangements (sets of institutions) (Vargo and Lusch 2016). This feedback is facilitated by modern social network infrastructure such as slick user interfaces, fast communications, and database back-ends. Thus, a service ecosystem fulfills the three key characteristics of a complex system.

## Local Interactions and Emergence

The second and third characteristics of self-organizing service ecosystems are the emergence of a self-organizing system that cannot be understood by aggregating the independent behavioural patterns of actors in the system, but must be analyzed by focusing on the interactions between each actor (Helbing 2012). Thus, we now demonstrate that service ecosystems have interactions amongst its actors, leading to the emergence of value cocreation processes and new service ecosystem's structures.

SD logic, states that "value is co-created by multiple actors, always including the beneficiary", and that "actors cannot deliver value but can participate in the creation and offering of value propositions" (Vargo and Lusch 2016, p. 8). Both SD logic and self-organization theory define value as a property that is emerging from the interaction of actors, rather than created by a single actor. In the context of P2P lending platforms, local interactions occur as individual lenders and borrowers interact through resource exchanges underpinning loan transactions. These interactions enable access by either investors or borrowers to value in terms of loan transactions; monetary returns for investors; and lower-interest loans for borrowers (Emekter et al. 2015; LendingClub 2018). Throughout this process, LendingClub facilitates interactions by matching borrowers with lenders, with borrowers requesting loans from lenders, and lenders making loan offerings while determining repayments and interest rates. So we see that it is almost by definition that service ecosystems have the emergence property, thus making them self-organizing systems.

## Adaptiveness

The fourth characteristic of a self-organizing service ecosystem is adaptiveness. Self-organizing service ecosystems adapt to their changing environment by altering, stabilizing and manipulating its internal structure and functioning (Heylighen 2001). This is achieved through the use of local rules (Johnson 2002), and positive and negative feedback loops (Helbing 2012). By integrating self-organization theory and SD logic, it is evident that a self-organizing service ecosystem is able to adapt to a changing environment as it self-adjusts in structure and ability to cocreate value.

Local interactions and feedback loops are fundamental for the adaptiveness of the self-organizing service ecosystem. First, local interactions among actors enable feedback loops that stimulate each actor to adjust its behaviour, role, and resource integration patterns. Second, feedback loops occurring between the system level (macro-level) and the actor level (micro-level) influence the adaptiveness of the self-organizing service ecosystem. Self-organization theory calls this feedback cycle between the macro and micro levels: circular causality. Institutions and institutional arrangements at the macro-level coordinate actors (micro-level) in such way that actors modify their own institutions and institutional arrangements related to roles and resource integration activities for adapting to a changed value cocreation process. Here, the service ecosystem is then an organizing logic of the value cocreation process (Lusch and Nambisan 2015). Closing the feedback cycle, institutions generated at the actor level (micro-



level) can contribute to shaping the institutions and institutional arrangements governing the service ecosystem (macro-level).

Technology is accelerating the adaptiveness and evolution of self-organizing service ecosystems. For example, the digital platform of LendingClub allows investors to restructure their investment portfolio by changing the investment criteria used to diversify it, and enabling selling and buying of loans at anytime depending on their financial goals (LendingClub 2018). This means that service ecosystems nested within the service ecosystem could easily form and reform while continuing to cocreate value. Hence, service ecosystems satisfy this requirement for self-organization. Additionally, this provides a new perspective into advancing knowledge on the emergence and evolution of institutions and institutional arrangements in value cocreation and on the role of technology facilitating the service ecosystem adaptiveness.

### **Distributed Control**

Finally, the fifth characteristic of self-organizing service ecosystems is the absence of external impositions on its structure or overall functioning. Instead, any outcomes result from interactions and resource integration activities of actors within the ecosystem. In this sense, the notion of control over structure fulfils two purposes. First, control is distributed across all actors within the ecosystem. Second, control is not imposed by an external entity, so that any value cocreating activities emerge from the actors themselves (Vargo and Lusch 2016). In the context of financial services, any value cocreating interactions are bound to heavy government regulations, rigid structures, and a slow pace of technology adoption. In fact, banks represent central actors who conduct the interactions of others with themselves, rather than allowing other actors in their service ecosystems to interact and integrate resources directly. In contrast, Fintech platforms possess a stronger ability to facilitate interactions between others due to less regulation and high centrality of technology-use. For example, Bitcoin operates on a distributed ledger with a decentralized structure where all changes have to be verified using consensus-based approaches without the need for transactions to be validated by a single actor such as a bank (Böhme et al. 2015). The structure and value cocreating processes changed considerably as actors participate in, validate, and broadcast transactions by interacting without the need of a central actor. P2P lending platforms also exhibit decentralized structures since the initiation and execution of loan transactions are completed by interdependent borrowers and lenders. Each of these actors have more control over how their resources are integrated for value co-creation. Enabled by technology, self-organizing service ecosystems display functions and structures that emerge from local and dynamic, instead of, rigid and centralized interactions.

We see, therefore, by examining the tenants of SD logic, and examples from the Fintech setting, that service ecosystems can fulfil the key requirements to be self-organizing systems: complexity, emergent behaviour from local interactions, adaptiveness and distributed control.

## **3 Discussion, Conclusion and Future Research**

Our short paper developed and introduced the concept of self-organizing service ecosystem into the IS and service science literature. We demonstrated that previous conceptualizations of service ecosystems common in Marketing (Vargo and Lusch 2008), and increasingly used in IS research (Barrett et al. 2015; Breidbach and Ranjan 2017), are limited in their explanatory power of digital transformative phenomena due to the absence of understanding on how these systems emerge, manage, and regulate themselves (e.g., self-organize). We used a midrange-theorizing approach and applied self-organization theory to identify and explain the characteristics of complexity, adaptiveness, as well as distributed control, local interactions and emergence; therefore, extending the notion of service ecosystem from Vargo and Lusch (2016). Our paper paves the way to understanding the complex dynamics, characteristics, and value-creating processes of service settings IS researchers are increasingly interested in (Rai 2016), while linking existing theories and disciplines - self-organization theory and IS - thus broadening the scope of thinking in IS research (Gilson and Goldberg 2015).

Self-organization in service ecosystems prompts future research on how technology empowers and guides the nature of service. Specifically, we envision for self-organizing service ecosystems to emerge as a useful conceptual lens for research at the intersection of IS and service science, and especially for understanding digital transformative phenomena. Technological developments trigger societal transformations at an unpredictable rate and scope, thus requiring new lenses, terminology and concepts to overcome challenges in traditional IS approaches that lacked impact to date (Agarwal and Lucas Jr 2005). For example, P2P platforms in the context of financial services enable disconnected economic actors to engage in service transactions previously controlled by, and only accessible through,

large financial institutions. It is undisputed that the emergence of new digital technologies has accelerated the formation and reformation of self-organizing service ecosystems. Thus, our conceptualization of self-organizing service ecosystems sets the stage to address existing knowledge gaps pertaining to the impact of technology on the structure and functioning of service ecosystems (Nambisan et al. 2017; Vargo and Lusch 2017).

While the benefits commonly associated with the formation of service ecosystems more broadly range from reduced cost for service customers to higher operational efficiency for firms (Breidbach et al. 2018; Lusch and Nambisan 2015), self-organizing systems can also get caught in a non-optimal configuration or functioning (Heylighen 2001). This is because the process of self-organization does not necessarily guarantee optimal results (Helbing et al. 2009). For instance, non-optimal structural configurations could be triggered by delayed or non-existent responses by actors in the system due to their limited processing capacity (Helbing 2012). To overcome this problem, Prokopenko (2009) refers to guided self-organization, and suggests this may be achieved either through signals that define desirable behavior to actors, or that can constrain systems. As it is the case in many sharing economy platforms (Breidbach and Brodie 2017), P2P lending platform LendingClub orchestrates the formation of actor-interactions including information about credit scores or potential returns, thus signaling prospective lenders whether or not to invest. Hence, it is important to better understand if, how, and to what extent the formation and functioning of self-organizing service ecosystems can initially be guided or orchestrated through technology (Breidbach et al. 2015). Particularly, this research call can contribute to understanding the role of technology within service ecosystems (Storbacka et al. 2016). Overall, this paper can serve as a starting point when investigating how to transform, assemble, and achieve coherence in service driven by technology (Breidbach and Maglio 2015; Lusch and Nambisan 2015).

As future steps, we plan to investigate if, how and to what extent coordination mechanisms guide self-organization in digital service ecosystems, in the context of Fintech. Adopting the analytical lens proposed, the study will use agent-based modelling (ABM) simulations to examine the impact of digital coordination mechanisms on the nature, co-creation activities, and performance of self-organizing service ecosystems. We will use ABM as it can better capture properties of self-organizing systems, when compared to other modelling approaches like system dynamics (Mollona 2008). The development process for the ABM simulations will follow the traditional approach according to Macal and North (2014). The study will contribute towards understanding the role of technology in the self-organization of digital service ecosystems.

## 4 References

- Agarwal, R., and Lucas Jr, H. C. 2005. "The Information Systems Identity Crisis: Focusing on High-Visibility and High-Impact Research," *MIS Quarterly* (29:3), pp. 381-398.
- Antons, D., and Breidbach, C. F. 2018. "Big Data, Big Insights? Advancing Service Innovation and Design with Machine Learning," *Journal of Service Research* (21:1), pp. 17-39.
- Ashby, W. R. 1962. "Principles of the Self-Organizing System," *Principles of Self-Organization: Transactions of the University of Illinois Symposium*, Illinois: Pergamon.
- Banzhaf, W. 2009. "Self-Organizing Systems." Memorial University of Newfoundland.
- Barrett, M., Davidson, E., Prabhu, J., and Vargo, S. L. 2015. "Service Innovation in the Digital Age: Key Contributions and Future Directions," *MIS Quarterly* (39:1), pp. 135-154.
- Bharadwaj, A., El Sawy, O., Pavlou, P., and Venkatraman, N. 2013. "Digital Business Strategy: Toward a Next Generation of Insights.," *MIS Quarterly* (37:2), pp. 471-482.
- Böhme, R., Christin, N., Edelman, B., and Moore, T. 2015. "Bitcoin: Economics, Technology, and Governance," *Journal of Economic Perspectives* (29:2), pp. 213-238.
- Breidbach, C., and Ranjan, S. 2017. "How Do Fintech Service Platforms Facilitate Value Co-Creation? An Analysis of Twitter Data," *ICIS 2017 Proceedings*.
- Breidbach, C., Sunmee, C., Ellway, B., Keating, B. W., Kormusheva, K., Kowalkowski, C., Lim, C., and Maglio, P. 2018. "Operating without Operations: How Is Technology Changing the Role of the Firm?," *Journal of Service Management*. <https://doi.org/10.1108/JOSM-05-2018-0127>.
- Breidbach, C. F., Antons, D., and Salge, T. O. 2016. "Seamless Service? On the Role and Impact of Service Orchestrators in Human-Centered Service Systems," *Journal of Service Research* (19:4), pp. 458-476.

- Breidbach, C. F., and Brodie, R. J. 2017. "Engagement Platforms in the Sharing Economy: Conceptual Foundations and Research Directions," *Journal of Service Theory and Practice* (27:4), pp. 761-777.
- Breidbach, C. F., and Maglio, P. P. 2015. "A Service Science Perspective on the Role of ICT in Service Innovation," *Proceedings of the 23rd European Conference on Information Systems (ECIS) (Paper 33)*.
- Breidbach, C. F., and Maglio, P. P. 2016. "Technology-Enabled Value Co-Creation: An Empirical Analysis of Actors, Resources, and Practices," *Industrial Marketing Management* (56), pp. 73-85.
- Breidbach, C. F., Reefke, H., and Wood, L. C. 2015. "Investigating the Formation of Service Supply Chains," *The Service Industries Journal* (35:1-2), pp. 5-23.
- Coleman, J., H.J. 1999. "What Enables Self-Organizing Behavior in Businesses," *Emergence* (1:1), pp. 33-48.
- De Sanctis, G. 2004. "The Social Life of Information Systems Research: A Response to Benbasat and Zmud's Call for Returning to the It Artifact," *Journal of the AIS* (4:7), pp. 360-376.
- Emekter, R., Tu, Y., Jirasakuldech, B., and Lu, M. 2015. "Evaluating Credit Risk and Loan Performance in Online Peer-to-Peer (P2p) Lending," *Applied Economics* (47:1), pp. 54-70.
- Erdi, P. 2008. *Complexity Explained*. Berlin: Springer Science & Business Media.
- Fuchs, C. 2006. "The Self-Organization of Social Movements.," *Systemic practice and action research* (19:1), pp. 101-137.
- Gilson, L. L., and Goldberg, C. B. 2015. "Editors' Comment: So, What Is a Conceptual Paper?," *Group & Organization Management* (40:2), pp. 127 - 130.
- Haken, H. 1977. *Synergetics: An Introduction Nonequilibrium Phase Transitions and Self-Organization in Physics, Chemistry and Biology*. Berlin, Heidelberg: Springer Berlin Heidelberg.
- Haken, H. 2006. "Information and Self-Organization: A Macroscopic Approach to Complex Systems ". Berlin, New York: Springer.
- Helbing, D. 2012. *Social Self-Organization - Agent-Based Simulation and Experiments to Study Emergent Social Behavior*. Springer Berlin Heidelberg.
- Helbing, D., Deutsch, A., Diez, S., Peters, K., Kalaidzidis, Y., Padberg-Gehle, K., Lämmer, S., Johansson, A., Breier, G., Schulze, F., and Zerial, M. 2009. "Biologistics and the Struggle for Efficiency: Concepts and Perspectives," *Advances in Complex Systems* (12:06), pp. 533-548.
- Heylighen, F. 2001. "The Science of Self-Organization and Adaptivity. ," *The encyclopedia of life support systems* (5:3), pp. 253-280.
- Johnson, S. 2002. *Emergence: The Connected Lives of Ants, Brains, Cities and Software*. England: Penguin Group.
- LendingClub. 2018. "Lendingclub." Retrieved July 2018, from <https://www.lendingclub.com/>
- Lusch, R. F., and Nambisan, S. 2015. "Service Innovation: A Service-Dominant Logic Perspective," *MIS Quarterly* (39:1), pp. 155-176.
- Macal, C., and North, M. 2014. "Introductory Tutorial: Agent-Based Modeling and Simulation," *Proceedings of the 2014 winter simulation conference: IEEE Press*, pp. 6-20.
- Mollona, E. 2008. "Computer Simulation in Social Sciences," *Journal of Management & Governance* (12:2).
- Musil, J., Musil, A., and Biffl, S. 2015. "Introduction and Challenges of Environment Architectures for Collective Intelligence Systems," in: *Agent Environments for Multi-Agent Systems IV* Springer.
- Nambisan, S., Lyytinen, K., Majchrzak, A., and Song, M. 2017. "Digital Innovation Management: Reinventing Innovation Management Research in a Digital World," *MIS Quarterly* (41:1).
- Nambisan, S., and Sawhney, M. 2011. "Orchestration Processes in Network-Centric Innovation: Evidence from the Field," *The Academy of Management Perspectives* (25:3), pp. 40-57.

- Ostrom, A. L., Parasuraman, A., Bowen, D. E., Patricio, L., and Voss, C. A. 2015. "Service Research Priorities in a Rapidly Changing Context," *Journal of Service Research* (18:2), pp. 127-159.
- Prokopenko, M. 2009. "Guided Self-Organization," *HFSP Journal* (3:5), pp. 287–289.
- Rai, A. 2016. "Editor's Comments: The Mis Quarterly Trifecta: Impact, Range, Speed," *MIS Quarterly* (40:1), pp. iii-x.
- Spohrer, J., Maglio, P. P., Bailey, J., and Gruhl, D. 2007. "Steps toward a Science of Service Systems," *Computer* (40:1), pp. 71-77.
- Storbacka, K., Brodie, R. J., Böhmman, T., Maglio, P. P., and Nenonen, S. 2016. "Actor Engagement as a Microfoundation for Value Co-Creation," *Journal of Business Research* (69:8), pp. 3008-3017.
- Vargo, S. L., and Lusch, R. F. 2008. "Service-Dominant Logic: Continuing the Evolution," *Journal of the Academy of Marketing Science* (36:1), pp. 1-10.
- Vargo, S. L., and Lusch, R. F. 2016. "Institutions and Axioms: An Extension and Update of Service-Dominant Logic.," *Journal of the Academy of Marketing Science* (44:1), pp. 5-23.
- Vargo, S. L., and Lusch, R. F. 2017. "Service Dominant Logic 2025," *International Journal of Research in Marketing* (34:1), pp. 46-67.

## Copyright

**Copyright:** © 2018 Maria Veronica Torres Pena, Christoph F. Breidbach, Andrew Turpin. This is an open-access article distributed under the terms of the [Creative Commons Attribution-NonCommercial 3.0 Australia License](https://creativecommons.org/licenses/by-nc/3.0/australia/), which permits non-commercial use, distribution, and reproduction in any medium, provided the original author and ACIS are credited.

# Organisational Transformation as a Consequence of Software-as-a-Service Usage by Small and Medium Enterprises

## **Khalid Alshammari**

School of Business Information Technology and Logistics  
RMIT University  
Melbourne, Australia  
Email: khha.alshammari@rmit.edu.au

## **Arthur Adamopoulos**

School of Business Information Technology and Logistics  
RMIT University  
Melbourne, Australia  
Email: arthur.adamopoulos@rmit.edu.au

## **Martin Dick**

School of Business Information Technology and Logistics  
RMIT University  
Melbourne, Australia  
Email: martin.dick@rmit.edu.au

## **Abstract**

Cloud computing, and particularly Software-as-a-Service, is now in widespread use, but how organisations are potentially transformed by Software-as-a-Service usage needs greater understanding. How do organisations, particularly Small and Medium Enterprises, change their processes and structures after a period of time of using Software-as-a-Service solutions? This study used a qualitative method of investigation. Sixteen semi-structured interviews have been conducted with participants from eleven different organisations. It was found that all the organisations experienced transformation to some extent. The types of organisational transformation observed included changes to organisational processes, changes to the structures within the organisations and also changes to the role played by IT departments. Relationships between these forms of transformation were also found. A greater understanding of these transformations can help organisations gain greater benefits from Software-as-a-Service solutions.

**Keywords** Software-as-a-Service, Organisational Transformation, Cloud Computing, SMEs, SaaS Consequences

## 1 Introduction

While there have been considerable studies into cloud computing adoption, relatively few studies have looked beyond the adoption phase to how longer-term usage of cloud computing, and Software-as-a-Service (SaaS) in particular, changes and impacts an organisations' business processes. Organisations can face challenges in fitting their processes to the SaaS solution. Does the software change to fit the organisation or does the organisation change to fit the software? Consequences are the changes and impacts that occur within organisations after adopting a cloud solution for a certain amount of time. Consequences could be both positive and negative.

While it will impact all firms, cloud computing is especially relevant to small and medium enterprises (SME). SMEs are more responsive to rapid changes in technologies and usually have simpler IT requirements and need less support compared to large enterprises. Also, many of them are happy to pass the IT operations on to third party providers, which make them more flexible and give them the ability to focus on their core business (Bose and Sugumaran 2008; Taylor et al. 2010; Vijeikis and Makstutis 2009). This study chose to focus on SMEs for these reasons.

Cloud computing is often classified into three service models: Software-As-A-Service (SaaS), Platform-As-A-Service (PaaS) and Infrastructure-As-A-Service (IaaS) (Liu et al. 2011). SaaS provides the end-user customer access to the providers' software applications, which can be accessed through client devices and interfaces such as web browsers (Low et al. 2011). SMEs are most likely to adopt SaaS cloud solutions over the other service models. Therefore, this study chose to focus on the consequences of SaaS usage by SMEs.

The main motivation of this paper is to present a clearer understanding of the organisational transformations that occur within SMEs after they have used SaaS solutions for a period of time. It presents three main categories of transformations and their conceptual relationships. These findings can assist organisations to anticipate, plan for and gain greater benefits from Software-as-a-Service solutions.

## 2 Background

Cloud computing has become a major solution that is now in wide use in the world. Gartner (2017) claims that by 2020 the projected revenues of cloud computing will exceed \$380B compared to \$246B in 2017. This innovation enables information to be stored, implemented, and retrieved online as a service to the customers in a pay-per-use manner (Taylor et al. 2010).

### 2.1 Consequences of Software-as-a-Service usage

Although most of the literature in SaaS adoption emphasises technologies and business models (Arya et al. 2010; Concha et al. 2010; Hudli et al. 2009), it does provide valuable elements such as technology understanding and business models which can lead to SaaS adoption understanding (Van Belle 2012). SaaS has been presented as a solution for small and medium enterprises (Dubey and Wagle 2007; Kern et al. 2002). Organisations do, however, have to weigh the benefits of SaaS (reliability, ease of deployment, scalability and security) with the drawbacks and risks associated with SaaS services (trust, availability, ownership, privacy and vendor lock-in) (Erdogmus 2009). The longer-term consequences of SaaS usage, however, have not been explored in depth.

### 2.2 Enterprise Systems

Studies into Enterprise Systems (ES) may provide insights into the potential consequences of SaaS usage. Small and medium enterprises can benefit from Enterprise Systems (ES) such as ERP systems as they serve as business tools to enhance enterprise growth. However, there is a need to distinguish between financial and non-financial benefits, which may occur when adopting ES in organisations (Reuther and Chattopadhyay 2004). Return on investment, cost reduction or other impacts that affect the spending positively can be considered as financial benefits. Whereas, efficiency and organisational effectiveness along with improvement in decision making process can be considered as non-financial benefits. Enterprise Systems generally make SMEs more responsive to market changes (Gupta 2000).

Enterprise Systems increase the enterprise's value and can make huge improvements to the enterprise business processes (Shaio Yan et al. 2009). Therefore, Enterprise Systems empower modern businesses with digital tools and information, which makes it hard to compete if they are not equipped with such systems. Also, an ES can integrate with the business' processes which make the exchange of information and data across the organisation more effective and in real time. Thus, efficiency and effectiveness are

associated with ES which helps organisations to be more flexible and competitive. ES also promote flatter organisational structures and decentralised decision making (Beheshti and Beheshti 2010; Madapusi and D'Souza 2012; Stuart et al. 2010).

Previously, SMEs were not able to obtain such ES to support their operations easily due to their cost. With Enterprise Systems now available as Software-as-a-Service solutions, small and medium enterprises can now compete with larger organisations. SaaS helps SMEs to focus more on their core business and lower the cost of ownership. Moreover, it gives SMEs the ability to get access to cutting-edge technologies with no upgrade obligation. It enhances the overall business process and enables organisations to carry out data transactions along the value chain (Low et al. 2011).

### **3 Organisational Transformation**

Organisations that move to cloud computing services such as Software-as-a-Service should expect some changes (Srinivasan 2013). Previous studies have primarily focussed on changes to the role of the IT department and personnel as well as how organisations change their structures and business models.

#### **3.1 Changing Role of the IT Department**

The roles and responsibilities of the IT department in an organisation will certainly be changed after adopting SaaS (Culley and Panteli 2015). These changes will impact every aspect of IT department operations. After SaaS adoption, many of the IT department's roles are shifted and transferred to the Cloud Service Provider (CSP). This is especially the case where previously, IT departments were full of employees who code, build, monitor and maintain systems. Culley and Panteli (2015) argue that IT departments should focus on information related to business rather than focusing on technology itself and maintaining it. Also, IT departments may take on new roles such as: governance, strategic business link, Design IT solution and delivery of the service.

Yanosky (2008) argues that cloud solution adoption will challenge the authority of the IT department. IT departments will lose power and influence over the user and other departments. Yanosky states that cloud adoption empowers the end user, "turning users into choosers". He encourages IT departments to redefine their roles and responsibilities in order to adapt to the change. They have to reassess their previous role of providing full support to a role of providing better control and monitoring of cloud services.

SaaS solutions can also impact the role of IT personnel directly. SaaS solution adoption transfers the burden of maintaining and supporting the organisation's systems and infrastructures to the CSP. So, SaaS solution can have a major positive impact as it offloads maintenance and other daily responsibilities to the SaaS providers which leads to a change in overall IT responsibilities (Azarnik et al. 2013; Berman et al. 2012). Offloading technical burdens helps the IT personnel to focus and pay more attention to supporting business functions efficiently (Al-lawati and Al-Badi 2016; Avram 2014). Therefore, SaaS solution adoption enables the IT department to change and to become more effective and efficient. Thus, it helps them to provide plans and strategies to the business in terms of technological solutions that serve the business needs (McKendrick 2011).

With the advent of SaaS, the abilities and skills of IT personnel could also be tested. IT department personnel need to improve their skills to keep up with the new advancements (Lin and Chen 2012). They need to update their knowledge in areas related to the cloud and understand cloud architecture, development, implementation and operation (Oredo and Njihia 2014).

Moving to cloud and SaaS services can also have major impacts on the role of IT management. McKendrick (2011) states that SaaS solution adoption "in many cases, it is elevating the role of IT-savvy managers within many enterprises". Delivering efficient and flexible IT systems is one of the Chief Information Officer's (CIO) major concerns to help the organisation to be more agile. With the SaaS solution capability to deliver flexible systems, the CIO can move their attention to the strategic level rather than operational level (Malladi and Krishnan 2012). Fisher (2014) argues that CIO role will receive huge and significant shift due to moving to the cloud, transforming the role from "Chief Information Officer" to "Chief Innovation Officer".

Lacity and Reynolds (2014) interviewed key personnel in four different SMEs that adopted cloud computing. They reported that the cloud adoption allowed in-house IT personnel to focus more on improving business processes. The change in duties and being free from technical support make them more strategic. One of the organisations, however, did not report major changes IT personnel duties. They swapped from an IT contractor to a cloud service provider.

### 3.2 Organisational Changes

Adopting Software-as-a-Service solutions allows organisations to have access to the latest and cutting-edge technology and Enterprises Systems such as ERP, CRM and HRM (Rajendran 2013). Adopting all these ES software or one of them will make a huge impact on an organisation's operations and processes (Shaio Yan et al. 2009; Stuart et al. 2010; Zhao et al. 2014). According to (Rajendran 2013) the change in business operation models may lead to a change in organisational culture and structure.

Hugos and Hulitzky (2010) argue that the business will shift from control over its' resources to a collaboration stage which will be more profitable as the business will work closely with partners and suppliers. A study conducted by Ahokangas et al. (2014) on two organisations which moved to the cloud found that changes to the business model was the biggest challenge, requiring changes to the existing business model, impacting the value proposition, delivery of service and basis of pricing (Ahokangas et al. 2014).

Organisational changes can come in many forms and may be positive or negative. It can partly depend upon how much existing business processes are aligned with the standardised business processes of the SaaS solution (Khajeh-Hosseini et al. 2010). Also, the changes can be influenced by organisation size and industry. According to Mabert et al. (2003), SMEs are more likely to be able to change and transform their business processes to adapt to the new system. In contrast, larger companies are more likely to customise the system to fit their needs. SMEs also tend to implement the entire new system whereas larger companies are more likely to follow an incremental approach (Mabert et al. 2003).

According to Saul et al. (2012), adopting cloud based ES solution can help to improve the organisation's value chain, by improving the organisation's ability to collaborate with partners and increase operational efficiency (Saul et al. 2012). Cloud ES solutions can also help with operational transparency, giving managers a clearer view of the organisation's performance. This allows managers to identify business processes that need to be improved (Hendricks et al. 2007; Lewandowski et al. 2013).

## 4 Methodology

The methodology chosen to conduct this study was a qualitative case study. Grounded Theory was used to understand and describe the real experiences of real organisations adopting Software-as-a-Service. In order to improve and increase the research's validity, a research plan for the case study was developed based on the research process described by Eisenhardt (1989). The research plan includes the following steps:

- Getting Started: Defining the research questions.
- Selecting Cases: Eleven Small and Medium Enterprises.
- Crafting Instruments and protocols: Development of the interview instruments.
- Entering the field: Conducting sixteen interviews with SaaS adopters.
- Data Analysis: Applying Grounded Theory data analysis techniques using Atlas.ti software.
- Shaping hypotheses: Multiple iterations of data analysis develop the concepts in the theory
- Building Theory: Hypotheses evolves into a cohesive theory

Case studies that were recruited for this study were small or medium enterprises in Saudi Arabia. In order to ensure adoption had already occurred, companies had to have implemented SaaS for at least six months. Permission was obtained to interview one or more decision-makers in each organisation. These included the owners/executives who made the final decision, and other employees. Those interviewed were involved either in the early stage of decision-making such as IT directors and managers, or they were current users of the solution.

Sixteen people who met the recruiting criteria were interviewed from eleven different organisations in late 2016. A diversity of organisational backgrounds allowed the researcher to explore the situation of SaaS adoption and consequences from different perspectives. Table 1 gives a detailed profile of the case studies recruited for this study.

All interviews were fully transcribed. Analysis was then performed using the Atlas.ti qualitative data analysis software. Grounded Theory as described by Strauss and Corbin (1998) was selected as the methodology for this study. The interviews were coded using open and axial coding.

These codes were then refined and categorised into three main categories of transformation. These categories were further explored by investigating the conceptual relationships between them. The next



section presents these transformational categories and relationships, with supporting quotations from the data.

#	Firm Size	Industry	SaaS Type	Number of Participants	Position	Years in Company	Degree of Involvement
1	Medium	Retail & Distribution	ERP	1	IT Director	6	High
2	Medium	Pharmaceutical	ERP	1	IT Mgr	10	High
3	Small	Training	Databases / Web Service	1	CEO	5	High
4	Small	Internet Portal	Web Services	1	CEO	4	High
5	Small	Business Incubator	ERP	2	IT Mgr / Shared Services Mgr	4/5	High/Medium
6	Medium	Software Development	ERP	2	Project Mgr / Product Mgr	5/4	High/High
7	Medium	Electric Company	CRM	1	IT Mgr	7	High
8	Small	Software Development	ERP/CRM	1	Co-Founder	6	High
9	Medium	Retail & Distribution	CRM	1	App Team Mgr	5	Medium
10	Medium	Retail & Distribution	CRM	3	Strategy & Business Development / GM / PMO	3/4/6	Medium / Medium / High
11	Medium	Agriculture Services	Tracking System	2	IT Staff	2/4	Low/Low

*Table 1. Sampling Profile*

## 5 Organisational Transformation

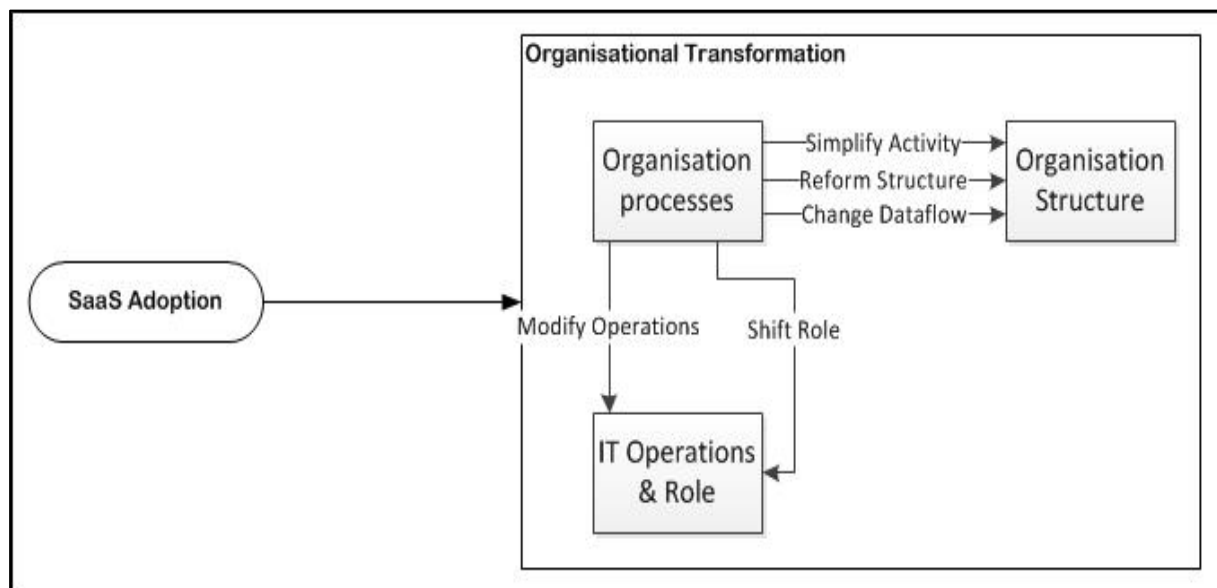

Figure 1 Organisational Transformation Model

Organisational transformation represents potential business transformations that may happen within the organisation after they have adopted SaaS. After a period of time of usage, they realise that due to new functionalities now available to them, they are able to transform their business structures and processes. The degree of the transformation is dependent on the level of diffusion of the system among the organisation's personnel and departments. So, the more the organisation embraces cloud solutions, the more they need to change their business processes, structure and roles. Figure 1. shows a model of the transformations found in this study.

### 5.1 Organisation Processes

These are the changes or transformations that occurred to the organisation's processes as a consequence of SaaS usage. Introducing SaaS based solution within the organisations helps to enhance and improve their processes. SaaS services offer a wide range of solutions targeting organisation such as ERP, CRM and other collaborative solutions. Implementing these solutions can change and improve the entire business process. These changes can be introducing completely new processes or could also be replacing an old process with an improved one.

It is not always the case that the organisations experience a radical or obvious change in their processes. Sometimes, the change simply occurs to the underlying work activities when then change the process itself. For example, the new SaaS solution might reduce the steps needed to accomplish a certain task and change the overarching business process. Change might also be in the form of switching from paper-based processes to electronic forms. Participants reported huge and desired changes in their organisations processes after adopting SaaS services.

*“Previously, some tasks had to go through multiple systems to be accomplished which cost us time and effort. Now, we are able to handle them quickly with ease. For example, in the old process if we received 5-6 new users we had to prepare their account and set up the environment then we had to check everything was correctly set up to make instances on our directory. This process was time and effort consuming. It took about 70% of the process just to setup an account. Now, this 70% is gone and everything now is a wizard through the application. The remaining 30% is to support the incubatees and to monitor the systems. We are now focusing on our main mission which is serving the incubatees and to control and develop our environment and network”.*

## 5.2 Organisation Structure

These are changes or transformations that occurred to the firms' organisational structure or management structure. Changes in organisational structure involve physical changes to how the firm is organised. These changes may involve adding or terminating departments or units. These changes may occur due to the shifting of duties from one department or unit to another or simply because of the change in the processes which were discussed earlier.

On the other hand, the changes in the firms' management structure can more be regarded as soft changes. These changes are about the reformation of the responsibilities and the workflow within the firm i.e. who reports to whom and who is responsible for whom.

SaaS solutions help to enhance firms' overall efficiency by optimising the firms' processes. Also, it can contribute to the firms' efficiency by helping them to change their organisational structure based on best practise in the industry. This will help the firms to assist the departments properly, so they can decide whether to initiate or terminate departments or to merge them. Similarly, it helps the firms to distribute the work and duties efficiently among the departments and apply policies and boundaries and define responsibilities more clearly.

According to the interviewees, implementing SaaS solutions within the organisation, along with provider's technical and consulting support, helped to change their firms' organisational structure.

*"It helps us to be a flatter organisation. For example, we used to have a product manager and a sales rep and they were reporting to what we call the segment manager who also had an area manager to report to, and then we had a division manager. Now, we have only the division, segment and product managers. We used to have 21 division managers in the organisation, now we have only 3 of them".*

As mentioned previously, these changes can lead to changes in the firms' management structure e.g. expand, reduce or shift on department's duties to other department/departments or simply to cancel the entire department.

*"We no longer need some departments such as Maintenance and Installation; we cancel these teams and shift some of their employees to other departments as needed"*

## 5.3 IT Department Role

These are changes or transformations that occurred to the organisation's IT department roles and responsibilities as a result of SaaS usage. From the IT department participants' point of view, cloud is a disruptive technology that is not just disruptive in a technology sense but is also a game changer that disrupts the IT department's job requirements, responsibilities and roles.

The IT department's main goal is to support the business processes. Therefore, any change or changes that happen to the IT department's role and responsibility will certainly affect the way the IT operates. Consequently, the IT department is going to operate differently when adopting SaaS services. Changes in IT operations are not directly because of SaaS adoption itself but rather because of the changes to organisation processes. The change in the process affect the IT role and responsibilities which in turn affect how IT operate based on the new role.

*"Now we said to our IT staff: you are going to be more flexible, more valuable and your responsibilities and roles will become to supervise and envision the quality of services and how to deliver the services effectively".*

*"So, we are existing here as an IT team mainly to rollout new processes, enhance the existing processes, implement the new features that come from the cloud and giving new ideas to SAP to build their strategy and vision".*

## 6 Relationships

Relationships between the categories of transformation were also observed in the analysis. These were primarily the different ways changes in organisation processes impact changes in organisation structures and also how changes in organisation processes influence changes in the role of IT department.

## 6.1 Organisation Processes Influence Organisation Structure

SaaS services offer a wide range of solutions such as ERP, CRM and other collaborative solutions. Introducing SaaS solutions in the organisation brings changes or transformations to an organisation's processes. These changes can be introducing completely new processes or improving the current ones.

Thus, changes in the organisation's processes influence changes in the organisation's departments and management structure. These changes can be actual changes i.e. adding or terminating departments or sections. Also, they can be a reformation of the organisation's departments i.e. responsibilities and/or employees shift from department to another.

The changes in reporting hierarchy and dataflow can also considered as changes in the organisation's managerial structure, which are influenced by changes in the organisation's processes. Hence, the influence of the organisation's processes on the organisation's structure can be seen as the following:

### 6.1.1 Simplify Employee Activities

Usage of SaaS solutions can change the way in which employees perform their activities. These changes can affect the way the employees perform certain task or sets of tasks. Implementing SaaS solution can help simplify and/or reduce steps of the tasks.

The change in employees' activities encourages the organisation to adjust its departments and units to adapt to the change brought by the solution so the work becomes more efficient.

*"I think it just removes some steps. It makes it more efficient, the process, removes the need for additional resource and handover. It should reduce the error rate because there's no converting of, in this case, orders from manual version into an electronic version. There's only one step. But it doesn't change the process itself, fundamentally"*

*"We no longer need some departments such as Maintenance and Installation; we cancel these teams and shift some of their employees to other departments as needed"*

### 6.1.2 Reform Organisational Structure

Change in the organisation's processes helps the organisation to automate more processes and adjust other processes. Adding, removing or altering processes requires changes in the organisational structure to maximise the benefits from the reformation.

These changes can lead the organisation to restructure the organisational units. Thus, changes in the organisation's processes influence changes in the firm's organisational structure.

*"Back office administration used to have a team to collect data on "data entry, balance, auditing" and we had to double check the errors because we didn't trust this department 100%. Now this department is shut down. Why? Because everything is live now and anyone from the head office can generate the needed reports."*

### 6.1.3 Changes in the Organisation Data Flow

Some changes in the organisation's processes do not necessarily lead the organisation to restructure its organisational units. However, they can affect the way the organisation deals with data flow and how data flows within and between organisational units. This involves changes in departments' duties and shifting responsibilities from one unit to another.

*"It's real time. So, also, the structuring of the Projects Department itself has streamlined a lot. What I mean by that is: previously before this application, people were scattered—so management doesn't know until it was reported specifically what prospective leads that we are waiting for, what's available in the market, what kind of projects we are waiting for. So now, all these kinds of information are flowing directly to management. So it's a big leap for us"*

## 6.2 Organisation Processes Change IT Department Role

Changes in organisation processes impact the IT role and operation. The IT department is structured to support the entire organisation's processes. However, when the organisation decided to change its processes to align with the new solution the IT department also needs to change in response. So, the change in the organisation's processes lead to a restructure of the role of the IT department and its operations.

### 6.2.1 Shift in IT Role and Responsibilities

Change in organisation's processes effect the IT department's role and responsibilities. As the IT role and responsibilities are set based on the needs of the organisation, these need to change when the organisation's needs have changed. IT role and responsibilities shift from being technical to be more strategic, from technical support to a business enabler. After adopting SaaS solutions, the IT department has fewer responsibilities and control over the solution. Therefore, the role changes from maintaining and developing the system to dedicating more time to support the organisation operations.

*"Today all our time is dedicated to the clients. The systems maintain themselves so we don't need to monitor the system for degradation, slowness, disconnect, failure"*

*"The IT department must act as a business enabler and stay away from complicated technical things"*

*"IT has less responsibility after they go live. Before they go live, for sure IT is there and IT is must. We are the implementer; we are the guys who do the implementation. But after they go live, you feel that there is less responsibility."*

### 6.2.2 Modify IT Operations

The IT department operates based on its role and responsibilities. When these roles and responsibilities have changed, the IT operations must change to suit. This will make the IT department operate differently by adding or eliminating some operations. For instance, maintaining the infrastructure, batch management and security threats operations are no longer needed. Instead, the IT department needs cooperate with SaaS provider and report problems.

*"So, we exist here as an IT team mainly to roll out new processes, enhance the existing process, implement the new features coming from the cloud and giving new ideas to SAP to build their upgrade and build their strategy vision"*

*"So Cloud will help us not to worry about backups, not to worry about disasters, not to worry about people who will be there, who will manage the systems; not to worry about the current structure—the current infrastructure we have. So mostly, Cloud will help us to—to, avail services only—and pay only for those services"*

## 7 Conclusion

This paper sought to understand how longer term SaaS usage can transform organisations, particularly SMEs. Previous studies into cloud computing adoption have focused on financial and strategic consequences, with relatively few studies exploring organisational transformation in depth. This paper has used a qualitative case study method by using semi-structured interviews. Then, analysing those interviews using a Grounded Theory methodology, developed a model of SaaS usage Organisational Transformation. The types of organisational transformation observed included changes to organisational processes, changes to the structures within the organisations and also changes to the role played by IT departments. Relationships between these forms of transformation were also found.

A greater understanding of these transformations can help organisations, and especially SMEs, to gain greater benefits from the adoption and usage of Software-as-a-Service solutions. Organisations could increase the success of their SaaS solutions by purposely aiming to achieve enhancements and improvements in their business operations as well as the technical benefits that are usually expected. By understanding the potential changes that may occur to their processes, structures and IT operations, organisations can pro-actively plan for and deal with these changes in their implementation plans. The provided conceptual model could benefit both organisations that wish to adopt or have already adopted SaaS solutions and also cloud services providers to assist the adoption process of their clients.

## 8 References

- Ahokangas, P., Juntunen, M., and Myllykoski, J. 2014. "Cloud Computing and Transformation of International E-Business Models," in *<Italic>a Focused Issue on</Italic> Building New Competences in Dynamic Environments*. pp. 3-28.
- Al-lawati, A., and Al-Badi, A. H. 2016. "The Impact of Cloud Computing It Departments: A Case Study of Oman's Financial Institutions," *2016 3rd MEC International Conference on Big Data and Smart City (ICBDSC)*, pp. 1-10.

- Arya, P. K., Venkatesakumar, V., and Palaniswami, S. 2010. "Configurability in SaaS for an Electronic Contract Management Application," *Proceedings of the 12th international conference on Networking, VLSI and signal processing: World Scientific and Engineering Academy and Society (WSEAS)*, pp. 210-216.
- Avram, M. G. 2014. "Advantages and Challenges of Adopting Cloud Computing from an Enterprise Perspective," *Procedia Technology* (12), pp. 529-534.
- Azarnik, A., Shayan, J., Alizadeh, M., and Karamizadeh, S. 2013. "Associated Risks of Cloud Computing for Smes," *Open International Journal of Informatics* (1:1).
- Beheshti, H. M., and Beheshti, C. M. 2010. "Improving Productivity and Firm Performance with Enterprise Resource Planning," *Enterprise Information Systems* (4:4), pp. 445-472.
- Berman, S. J., Kesterson-Townes, L., Marshall, A., and Srivathsa, R. 2012. "How Cloud Computing Enables Process and Business Model Innovation," *Strategy & Leadership* (40:4), pp. 27-35.
- Bose, R., and Sugumaran, V. 2008. "Challenges for Deploying Web Services-Based E-Business Systems in Smes," *International Journal of E-Business Research* (2:1).
- Concha, D., Espadas, J., Romero, D., and Molina, A. 2010. "The E-Hub Evolution: From a Custom Software Architecture to a Software-as-a-Service Implementation," *Computers in Industry* (61:2), pp. 145-151.
- Culley, G., and Panteli, N. 2015. "Exploring the Impact of Cloud Computing on It Departments," *ECIME2015-9th European Conference on IS Management and Evaluation: ECIME 2015: Academic Conferences and publishing limited*, p. 54.
- Dubey, A., and Wagle, D. 2007. "Delivering Software as a Service," *The McKinsey Quarterly* (6:2007), p. 2007.
- Eisenhardt, K. M. 1989. "Building Theories from Case Study Research," *Academy of management review* (14:4), pp. 532-550.
- Erdogmus, H. 2009. "Cloud Computing: Does Nirvana Hide Behind the Nebula?," *Software, IEEE* (26:2), pp. 4-6.
- Fisher, T. 2014. "The Cio as Chief Innovation Officer: How Cloud Is Changing the Cio Role." Retrieved 06/06/2018, from <https://www.oracle.com/assets/thecioaschiefinnovation-2192468.pdf>
- Gartner. 2017. "Gartner Says Worldwide Public Cloud Services Market to Grow 18 Percent in 2017,").
- Gupta, A. 2000. "Enterprise Resource Planning: The Emerging Organizational Value Systems," *Industrial Management & Data Systems* (100:3), pp. 114-118.
- Hendricks, K. B., Singhal, V. R., and Stratman, J. K. 2007. "The Impact of Enterprise Systems on Corporate Performance: A Study of Erp, Scm, and Crm System Implementations," *Journal of operations management* (25:1), pp. 65-82.
- Hudli, A. V., Shivaradhya, B., and Hudli, R. V. 2009. "Level-4 SaaS Applications for Healthcare Industry," in: *Proceedings of the 2nd Bangalore Annual Compute Conference*. Bangalore, India: ACM, pp. 1-4.
- Hugos, M. H., and Hultzky, D. 2010. *Business in the Cloud: What Every Business Needs to Know About Cloud Computing*. John Wiley & Sons.
- Kern, T., Kreijger, J., and Willcocks, L. 2002. "Exploring Asp as Sourcing Strategy: Theoretical Perspectives, Propositions for Practice," *The Journal of Strategic Information Systems* (11:2), pp. 153-177.
- Khajeh-Hosseini, A., Greenwood, D., and Sommerville, I. 2010. "Cloud Migration: A Case Study of Migrating an Enterprise It System to Iaas," *2010 IEEE 3rd International Conference on cloud computing: IEEE*, pp. 450-457.
- Lacity, M. C., and Reynolds, P. 2014. "Cloud Services Practices for Small and Medium-Sized Enterprises," *MIS Quarterly Executive* (13:1).
- Lewandowski, J., Salako, A. O., and Garcia-Perez, A. 2013. "SaaS Enterprise Resource Planning Systems: Challenges of Their Adoption in Smes," *e-Business Engineering (ICEBE), 2013 IEEE 10th International Conference on: IEEE*, pp. 56-61.

- Lin, A., and Chen, N.-C. 2012. "Cloud Computing as an Innovation: Perception, Attitude, and Adoption," *International Journal of Information Management* (32:6), pp. 533-540.
- Liu, F., Tong, J., Mao, J., Bohn, R., Messina, J., Badger, L., and Leaf, D. 2011. "NIST Cloud Computing Reference Architecture," *NIST special publication* (500), p. 292.
- Low, C., Chen, Y., and Wu, M. 2011. "Understanding the Determinants of Cloud Computing Adoption," *Industrial Management & Data Systems* (111:7), pp. 1006-1023.
- Mabert, V. A., Soni, A., and Venkataramanan, M. A. 2003. "The Impact of Organization Size on Enterprise Resource Planning (Erp) Implementations in the Us Manufacturing Sector," *Omega* (31:3), pp. 235-246.
- Madapusi, A., and D'Souza, D. 2012. "The Influence of Erp System Implementation on the Operational Performance of an Organization," *International Journal of Information Management* (32:1), pp. 24-34.
- Malladi, S., and Krishnan, M. S. 2012. "Cloud Computing Adoption and Its Implications for Cio Strategic Focus—an Empirical Analysis,").
- McKendrick, J. 2011. "Cloud Computing: Ticket to the Corner Office?", 14 May 2018, from <https://www.forbes.com/sites/joemckendrick/2011/10/19/cloud-computing-ticket-to-the-corner-office/>
- Oredo, J. O., and Njihia, J. 2014. "Challenges of Cloud Computing in Business: Towards New Organizational Competencies," *International Journal of Business and Social Science* (5:3).
- Rajendran, S. 2013. "Organizational Challenges in Cloud Adoption and Enablers of Cloud Transition Program." Massachusetts Institute of Technology.
- Reuther, D., and Chattopadhyay, G. 2004. "Critical Factors for Enterprise Resources Planning System Selection and Implementation Projects within Small to Medium Enterprises," *Engineering Management Conference, 2004. Proceedings. 2004 IEEE International: IEEE*, pp. 851-855.
- Saul, B., Lynn, K. T., Anthony, M., and Rohini, S. 2012. "How Cloud Computing Enables Process and Business Model Innovation," *Strategy & Leadership* (40:4), pp. 27-35.
- Shaio Yan, H., Shi-Ming, H., Tung-Hsien, W., and Wen-kai, L. 2009. "Process Efficiency of the Enterprise Resource Planning Adoption," *Industrial Management & Data Systems* (109:8), pp. 1085-1100.
- Srinivasan, S. 2013. "Is Security Realistic in Cloud Computing?," *Journal of International Technology and Information Management* (22:4), p. 3.
- Strauss, A., and Corbin, J. 1998. *Basics of Qualitative Research: Techniques and Procedures for Developing Grounded Theory*. Sage publications.
- Stuart, M., Udechukwu, O., and Al, S. 2010. "Erp Implementation in Omantel: A Case Study," *Industrial Management & Data Systems* (110:1), pp. 78-92.
- Taylor, S., Young, A., and Macaulay, J. 2010. "Small Businesses Ride the Cloud: Smb Cloud Watch-Us Survey Results," *Cisco Internet Business Solutions Group*, pp. 1-13.
- Van Belle, J.-P. 2012. "Factors Influencing SaaS Adoption by Small South African Organisations," *2012 Conference*.
- Vijeikis, J., and Makstutis, A. 2009. "Small and Medium-Sized Business Competitiveness in Lithuania," *Ekonomika ir vadyba: aktualijos ir perspektyvos* (2:15), pp. 328-338.
- Yanosky, R. 2008. "From Users to Choosers: The Cloud and the Changing Shape of Enterprise Authority," *The tower and the cloud*, p. 126.
- Zhao, F., Scheruhn, H.-J., and von Rosing, M. 2014. "The Impact of Culture Differences on Cloud Computing Adoption," in *Human-Computer Interaction. Applications and Services*; M. Kurosu (ed.). Springer International Publishing, pp. 776-785.

**Copyright:** © 2018 Alshammari, Adamopoulos and Dick . This is an open-access article distributed under the terms of the [Creative Commons Attribution-NonCommercial 3.0 Australia License](https://creativecommons.org/licenses/by-nc/3.0/australia/), which permits non-commercial use, distribution, and reproduction in any medium, provided the original author and ACIS are credited.

# A Confirmatory Investigation of the Factors Influencing the Cloud Adoption in Local Government Organisations in Australia.

Prasanna Balasooriya L.N.  
School of Engineering and Technology  
Central Queensland University  
Melbourne, Australia  
Email: p.balasooriya@cqu.edu.au

## Abstract

The purpose of this paper is to discuss major factors of two well-known theoretical frameworks namely Technology-Organization-Environment (TOE) and Technology Acceptance Model (TAM), and examine how those factors could influence the Organizational decision on Cloud technology adoption. The research underlining was carried out using quantitative research methodology based on a survey questionnaire distributed to IT professionals across Australia. The survey questionnaire was developed based on 12 hypotheses and 24 indicator variables. Around 200 responses were analysed by using two-tier approach (a) confirmatory factor analysis to confirm the reliability and validity of the latent variables, and (b) analysis of the structural model to confirm or reject the hypothesis. The final analysis of the results has revealed that only 8 hypotheses are significant and can be adopted. Furthermore, results have revealed that 4 hypotheses have a non-significant impact on the proposed framework and can be rejected from the framework.

**Keywords** Cloud adoption, Cloud technology, integrated framework, technology acceptance, structural equation modelling, SmartPLS



## 1 Introduction

Cloud technology is one of the innovations that deliver information technology services in modern world. This technology has an immense potential for improving Organizational service delivery and performance at a higher rate of the Cloud adoption (Abduljalil and Zainuddin 2015). The National Institute of Standards and Technology (NIST) defines Cloud technology as a model for enabling convenient, on-demand network access to a shared pool of configurable computing resources. Hence, this includes networks, servers, storage, applications, and services that can be rapidly provisioned and released with minimal management effort or service provider interaction (Alijani et al. 2014).

Organizations around the world recognize Cloud technology as an emerging technology available in the information technology domain at current. This is due to its capabilities to assist organizations in reducing their overall expenditure through improvement in their services. In addition, the use of Cloud technology increases the collaboration across the organization and the scalability acceptance up to an exceptional level (Balasoorya et al. 2016). The Cloud computing technology is an emerging technology that can be used to improve the way that organizations conduct their business. Cloud computing technology has capabilities to (a) reduce cost (b) improve performance (c) reduce maintenance (d) better storage, and (e) increased security (Maresova et al. 2017) which could certainly support organizations to transform their business operations to the Cloud. However, despite the emerging benefits of Cloud technology, Australian organisations are still far behind than the other countries in the world. Therefore, AlKharusi and Al-Badi (2016) found that the organizations who do not have prior experience and knowledge showed a negative attitude towards adopting this technology. Raza et al. (2015) explained that controversial view of the fear of job losses in the minds of the workforce is one of the major factors that have contributed slow growth of Cloud computing. Willcocks et al. (2013) believes that the adoption of Cloud technology beyond its IT operational benefits could be problematic and slow the adoption, and infrastructure failures could have contributed negatively to rethink about the decision to adopt this technology.

A significant number of empirical studies were found for Cloud adoption in general, but most of those studies were focused on general benefits and risks of Cloud adoption. Thus, there are limited academic focus on the Cloud Adoption in Local Government in Australia. Therefore, the focus of this paper is to integrate two well know theoretical frameworks, TOE and TAM frameworks together to study their impact on the Cloud adoption in Local Government environment Australia.

The paper is organised as follow: first we provide a comprehensive review of TOE and TAM models. We then present the conceptual research model with comprehensive review of factors with each model, which will provide the theoretical foundations for the research model and then propose the hypotheses. Thereafter, we discuss the research methodology and the results in details. Then we conclude the paper with summary of our contribution and discussion on the limitation of the research.

## 2 Review of the Research Framework

### 2.1 Technology, Organization, and Environment framework (TOE)

The TOE has been recognized as one of the organizational level theories that could help to describe its key elements: technology, organization and environment. The technology element will describe the internal and external technological context which is related to the organization. The organization element will describe the organizational context such as organizational size, scope, managerial structure and internal resources of the organization. Lastly, the environmental element will assist to identify the environmental area where organization conducts its business, its industry and technology dealings with the government. Therefore, TOE framework could be used to examine the influence of technological context (perceived benefits and costs), organizational context (organizational size, management support etc.) and environment context (trading partners, competitive advantages) on adoption of Cloud computing technology (Hsin-Pin and Hsiang-Ting 2014)

### 2.2 Technology Acceptance Model (TAM)

Organizations will be investing so much in information technology systems and projects for so many reasons such as cutting costs, reducing their pressure and improving the quality of services and products that they offer. Technology acceptance model (TAM) is one of the models that has been developed to predict the systems use (Legris et al. 2003). The TAM model has two key beliefs about a new technology, Perceived usefulness (PU) and Perceived ease of use (PEOU), determine a person's to adopt a new technology. Users acceptance of new technology depends primarily on its functions (PU) and secondarily

on the ease or difficulty with which its functions can be performed (PEOU). The perceived usefulness (PU) and user attitude towards usage (A) may influence the behavioural intentions (BI) of the user to use the new technology that has been adopted (FADor 2014). The predictive power and parsimony of TAM enables researchers to apply it to various settings and analyse and understand different user behaviours (Ashraf et al. 2014). Therefore, TAM is a useful theoretical framework that could be applied to understand and explain why users will accept or reject new technology (Legris et al. 2003).

### 3 Conceptual Research Model

Hsin-Pin and Hsiang-Ting (2014) and Lin (2014) have found that the TOE framework can only be used to categorize its variables and does not represent an integrated conceptual framework or will not produce a well-developed theory. Legris et al. (2003), FADor (2014), Wu and Chen (2017) and Ashraf et al. (2014) revealed that TAM will only be measuring the perceived adoption on the future behaviour of the adoption rather than measuring the actual behaviour of the adoption. Wu and Chen [25] further mentioned that TAM cannot be used to handle new technological solutions or services due its restricted constructs within the model. Thus, Ashraf et al. (2014) has concluded that due to the limitations that have been found, TAM framework could not provide consistent results of the measured variables. Ashraf et al. (2014) has suggested extending the initial scope of TAM model to include other factors which could be important in technology acceptance.

In this research, a following conceptual research framework (as illustrated in Figure 1) has been developed by combining the TOE and TAM frameworks. However, to limit the scope of this paper, the author has used only technology context of TOE with PU & PEOU of TAM model to investigate how factors could influence the technology acceptance and adoption of Cloud technology.

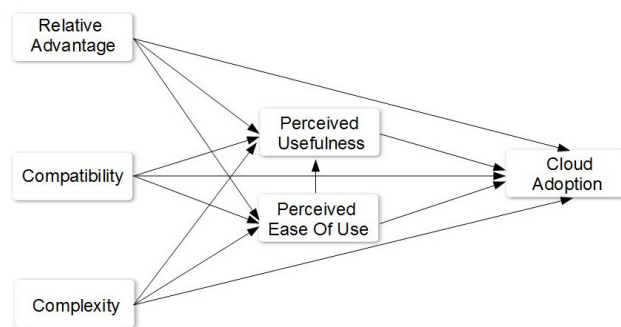

Figure 1: Proposed conceptual model

It has been found that Relative Advantage (RA), Compatibility (COMP) and Complexity (CLX) are major contributing factors of Technological context in the TOE. Furthermore, the literature has been revealed that PU (Perceived Usefulness) and Perceived Ease of Use (PEOU) are two main factors in TAM which could influence adoption intentions of Cloud technology. Thus, proposed model will extend the initial scope of both model and will eliminate some of the limitations that have been discussed in this paper. Most importantly, integration of major constructs of both frameworks in the proposed model will provide a more accurate view of the technology adoption.

#### 3.1 Relative Advantage

Rogers (2010) explained relative advantage as the degree to which an innovation is perceived as being better than the idea it supersedes. Thus, it is a reasonable expectation for organizations to take into considerations of the advantages stem from adopting it (Wang et al. 2010). Hence, the adoption of Cloud computing technology could be seen as an adopting innovation to the organization. In particular, adopting innovative technologies such as Cloud computing technology could bring the benefits that are associated with it and offer economical and political legitimacy (Wang et al. 2016) to the adoption. However, further analysis has revealed that tangible and intangible benefits such as increase of revenue, reduction of operational cost, increase of productivity, increase of efficiency of work processes, response time improvement, increased cash flow, competitive advantage, improved customer service, better relations with business partners and other opportunities are some of the major elements of relative advantage (Hameed and Counsell 2014, Premkumar et al. 1994). Thus, the relative advantage has a none-arguable significant influence on the decision of adoption of Cloud computing (Hung et al. 2010). As per previous findings, the researcher believes that adoption of Cloud computing technology could bring some valuable benefits such as reduced operating costs, improved response time, improved

productivity and provide a greater competitive advantage to the organization. Therefore, many studies suggested that relative advantage or perceived benefits as one of the top influencing factors to be considered to examine the Cloud adoption, and it could positively affect the Cloud adoption (Hameed and Counsell 2014).

### 3.2 Compatibility

Compatibility has been described as the degree to which an innovation is perceived as consistent with the needs, existing values, past experience and technological infrastructure of the adopter (Rogers 2010). If new technology is more compatible with the existing business process and systems, the less resistance will occur during the adoption process (Premkumar et al. 1994). Thus, resistance to the new technology has negative effects on the usage of the new technology. Thus, it could impact the adoption, and adopters most likely reject its adoption (Hameed and Counsell 2014). However, Tornatzky (2005) suggested that compatibility factor could positively impact the Cloud adoption in an organization.

### 3.3 Complexity

Complexity in new technology adoption can be seen as the degree to which an innovation is perceived as relatively difficult to understand and use (Rogers 2010, Haines et al. 2015). Thus, complexity factor could distance the Cloud adopters from adopting Cloud technology for their organizations, and it could have a negative impact on technology adoption decisions (Hameed and Counsell 2014). Tornatzky (2005) suggested that complex technologies could not be adopted successfully and thereby it could not bring the expected efficiency to the organization. Also, complexity factors expected to influence Cloud adoption decisions negatively, and people may not have confidence in the technology because it is relatively new to them (Hsin-Pin et al. 2014, Willcocks 2013).

### 3.4 Perceived Usefulness (PU)

Perceived Usefulness (PU) has been defined as the degree to which a person believes that using a particular system would enhance his performance at work (Ratten 2015, Balasooriya et al. 2017). Thus, usefulness can be seen as user's perception of the benefits of using a technology or technological services. Also, the usefulness may impact user's lifestyle and the way that they do work. The users who believe that the new technology leads them to have good results will see it as useful (Balasooriya et al. 2017, Awa et al. 2015). PU is one of the most powerful diagnostic lenses that can be used to see how to use and intentions to use are influenced. A PU is one of the most powerful indicators that can be used in technology acceptance to measure user behaviour (Balasooriya et al. 2017, Awa et al. 2015). Furthermore, PU can be seen as a positive influential factor in Cloud adoption (Balasooriya et al. 2017, Armitage and Conner 2001).

### 3.5 Perceived Ease of Use (PEOU)

PEOU is the degree to which a person believes that using a particular system would be free of effort (Balasooriya et al. 2017, Balasooriya et al. 2016). This element has been defined to measure the prospective users' assessment of the mental effort required for the use of target application (Balasooriya et al. 2017, Awa et al. 2015). Thus, this element will explain user's perception of how it is easy to use a new technology that they were willing to accept. Users always evaluate and accept the technology based on what kind skills, information and experiences are required to use the technology. Therefore, this indicator will predict the users' inner-feeling about the technology acceptance (Ratten 2015, Balasooriya et al. 2017). Thus, PEOU can contribute positively to influence PU.

### 3.6 Adoption (AI)

Sintonen and Immonen (2013) and Balasooriya et al. (2017) argued that user willingness to adopt modern technology can be measured by analysing the market due to individual's behavioural intention to adopt or start new services. Therefore, individual organizations are often needed act and incorporate new technologies into their organization to improve their business processes to be competitive to survive in the rapidly changing market. Furthermore, Balasooriya et al. (2017) and Tsai & Hsu (2012) stated that organizational readiness is used as an element to measure the capabilities of an organization for adopting common systems, where organizational readiness positively associated with the adoption.

As illustrated in Figure 2, twelve hypotheses were developed based on the above discussion. Furthermore, Figure 3 illustrate the visual representation of the hypothesis in the proposed model.

Hypothesis Identification	Hypothesis
H1	Relative advantage will directly influence the likelihood of Adoption Intention.
H2	Relative advantage will positively relate to the likelihood of Perceived Usefulness
H3	Relative advantage will positively relate to the likelihood of Perceived Ease of Use
H4	Compatibility will directly influence the likelihood of Adoption Intention.
H5	Relative advantage will positively relate to the likelihood of Perceived Usefulness
H6	Relative advantage will positively relate to the likelihood of Perceived Ease of Use
H7	Complexity will directly influence the likelihood of Adoption Intention.
H8	Complexity will positively relate to the likelihood of Perceived Usefulness
H9	Complexity will positively relate to the likelihood of Perceived Ease of Use
H10	Perceived Usefulness will positively relate to the likelihood of Adoption Intention
H11	Perceived Ease of Use will positively relate to the likelihood of Perceived Usefulness
H12	Perceived Ease of Use will positively relate to the likelihood of Adoption Intention

Figure 2: List of hypotheses

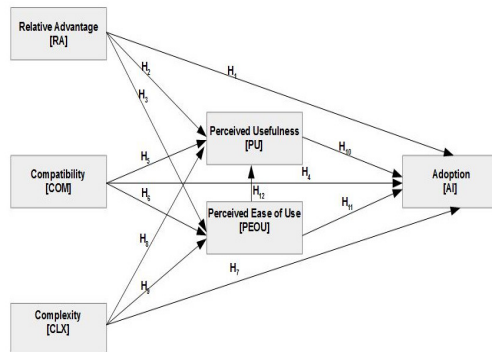

Figure 3: Visual representation of hypothesized relationships of the model

## 4 Research Background and methodology

### 4.1 Research Background

To evaluate the proposed conceptual framework illustrated in Figure 1 above, a well-designed survey questionnaire was distributed to information technology professionals across all Local government organisations in Victoria via Survey Monkey. Twenty eight individual variables have been used in this survey to gain a deeper knowledge of how technological factors of TOE and PU and PEOU of TAM could affect the adoption intention of Cloud technology.

The sample that has been used in this study represent the general population of professionals who are currently employed and located in different geographical locations across Australia. At the end of the data collection phase, 210 responses were collected and analysed for the statistical validity of the data. Therefore, it has been found that only 92% of the data is statistically valid and can be used for further analysis. Eight percent of incomplete or invalid data has been removed from the dataset.

### 4.2 Research Methodology

As Isma'ili et al. (2016) explained, Partial Least Squares – Structural Equation Modelling (PLS-SEM) is a multivariate method that could be used to identify the correlative relationships between multiple variables. The concepts that are not directly measured will be operationalized by compositing factor analysis, and path analysis can be used to expose the relationships between each concept. Furthermore, Völckner et al. (2010) strengthen Ismaill's argument by explaining that PLS-SEM is the most suiFi approach for researchers when their proposed model is complex. He further explained that PLS-SEM does not lead to a non-convergent result in the complex modelling environment and it is particularly appropriate to produce better results.

Isma'ili et al. (2016) and Balasoorya et al. (2017) further pointed out that PLS-SEM approach has a major advantage over other multivariate modelling techniques because PLS-SEM is a non-parametric method. Thus, PLS-SEM approach mainly helps researchers to (a) visualize the relationships exist between the indicator and latent variables, and (b) explore where organizations need to allocate more resources. Therefore, PLS-SEM has been chosen as an appropriate modelling technique for this study.

### 4.3 Results and Discussion

Based on the literature review, the following model has been used for this study as illustrated in Figure 4. Therefore, a factor loading coefficients indicate the strength and the direction of

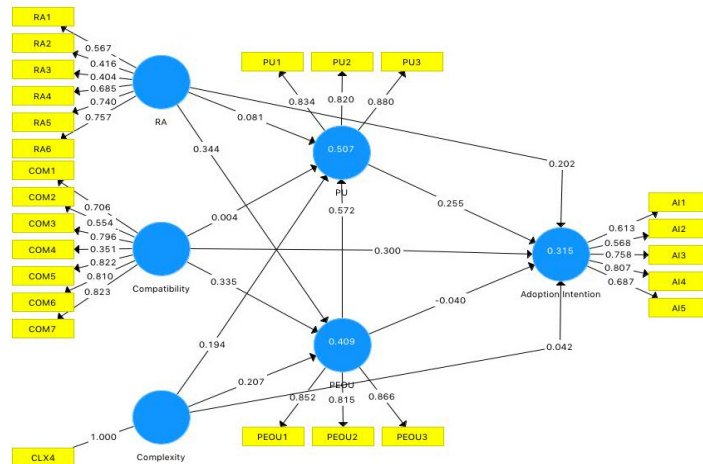

correlation between the indicator and latent variables. The relationship between each latent variable represents the structural model, which has been measured with PLS path coefficients.

Figure 4: Conceptual model with factor loadings

As described by Anderson & Gerbing (1998), the two-tier approach has been adopted in this research study to overcome the issues in single-tier approach. Therefore, Internal consistency, internal reliability, convergent validity, and discriminant validity of the model will be examined within confirmatory factor analysis. Furthermore, the coefficient of determination (R<sup>2</sup>), Predictive relevance (q<sup>2</sup>), size and significance of paths coefficient, f<sup>2</sup> effect size and q<sup>2</sup> effect size will be examined within the analysis of structural equation model.

#### 4.3.1 Approach 1 - Confirmatory factor analysis

The composite reliability varies between 0 and 1, which higher values indicate the higher level of reliability and lower values indicate the lower level of reliability. As suggested by Hair et al. (2014), composite reliability value of 0.50 will be an acceptable threshold value to evaluate the internal consistency reliability. Hair et al. (2014) further added that composite reliability values below the standard threshold of 0.50 will indicate a lack of internal consistency reliability of the model.

The coefficients of determination (R<sup>2</sup>) of Perceived Usefulness (PU) is 0.50, Perceived Ease of Use (PEOU) is 0.40 and Adoption intention (AI) is 0.30. Thus, this explains that relative advantage (RA), compatibility (COM), and Complexity (CLX) explain 50% of the variance of PU and 40% of the variance of PEOU.

Furthermore, RA, COM, CLX, PU and PEOU explain 30% variance of adoption intention (AI). Figure 5 illustrates the values of coefficients determination (R<sup>2</sup>) of the proposed model.

Values of coefficients determination (R <sup>2</sup> )		
	R Square	R Square Adjusted
PU	0.51	0.50
PEOU	0.41	0.40
AI	0.32	0.30

Figure 5: Values of coefficients determination (R<sup>2</sup>)

The values of inner-model suggest that PEOU has the strongest effects on PU (0.572), followed by RA → PEOU 0.344, COM → PEOU 0.335, COM → AI 0.300, PU → AI 0.225, CLX → PEOU 0.207, RA → AI 0.202 and CLX → PU 0.194. Furthermore, RA and COM have similar effects (0.34) on PEOU. Therefore, it suggests that hypothesized path relationships of H12, H3, H6, H4, H10, H9, H1, H8 have exceeded its standardized path coefficient threshold of 0.10, and are statistically significant. However, the hypothesised relationship between perceived ease of use (PEOU) and adoption intention (AI) has reported a strong negative effect. Furthermore, the relationship between RA → PU, CLX → AI, and COM → PU have reported weaker relationship, and are under its standardized path coefficient threshold value

of 0.10. Therefore, the test has confirmed that H2, H7, H5 and H11 are statistically non-significant in the proposed model.

As Isma'ili et al. (2016) concluded, it is an essential procedure to determine the reliability and validity of the latent variables to complete the examination of the model. Thus, it is important to examine the values of indicator reliability, composite reliability and average variance extracted in the proposed model. As illustrated in Table 1, indicators loadings of each indicator have reported positive values, which are greater than the minimum acceptable threshold value of 0.4, and all of them are closer to the preferred level 0.70. Therefore, this has concluded that all the indicators have a positive impact on the model.

Latent Variables	Composite Reliability	Average Variance Extract (AVE)	Adjusted AVE
RA	0.770	0.370	0.4
COM	0.870	0.510	0.5
CLX	1.000	1.000	1.0
PU	0.880	0.710	0.7
PEOU	0.880	0.710	.07
AI	0.820	0.480	0.5

Table 1: Summary of the composite reliability and average variance extracted

The composite reliability has been used to find the internal consistency reliability of the model (Hair et al. 2011). As illustrated in Table 1, the composite reliability values presented are greater than its standard threshold value of 0.6. therefore, this result has confirmed a higher level of internal consistency in the proposed model. Hair et al. (2014) argued that indicator loadings must be statistically significant, and it need greater than of its standard threshold of 0.80. therefore, the common method to establish convergent validity on a latent variable is Average Variance Extracted (AVE), and it has been defined as the grand mean value of squared loading of the indicators. A standard AVE threshold value of 0.50 or higher will explain more than half of the variance of the indicators in the model.

To explore the convergent validity of the mode, average variance extracted (AVE) are examined. It has been found that all the AVE values that are presented in Table 1, are greater than its threshold value of 0.50, and this result has confirmed that convergent validity of the proposed model. The latent variable RA which has reported .370, which is less than its threshold of 0.50 and indicated that it is not a valid factor in the model. However, Hair et al. (2014) argued that if composite reliability value is higher than 0.60, then the convergent validity of the construct still adequate, and can be accepted. Therefore, RA construct will be in the model as an individual construct and will not be removed or incorporate with another.

As explained by Hair et al. (2014), Discriminant validity explains that a construct is truly distinct from other construct by empirical standards. There are two methods of accessing discriminant validity as (a). examining cross-loadings, and (b). using Fornell-Lacker criterion. Therefore, in this study, the Fornell-Lacker criterion will be used to assess the discriminant validity. During the Fornell-Lacker process, it compares the square root of average variance extracted (AVE) with construct correlations.

Fornell and Larcker (1981) stated that the square root of AVE in each latent variable can be used to establish discriminant validity if this value is larger than other correlation values among the latent variables. Therefore, the results of the Fornell and Lacker's analysis that have been presented diagonally in Figure 6 have exceeded its standard threshold value of 0.50, which confirms the discriminant is well established in the model.

Latent Variable	AI	COM	CLX	PEOU	PU	RA
AI	0.690					
COM	0.440	0.710				
CLX	0.260	0.290	1.00			
PEOU	0.400	0.500	0.370	0.840		
PU	0.430	0.370	0.420	0.680	0.840	
RA	0.380	0.290	0.190	0.480	0.390	0.610

Figure 6: Values of coefficients determination (R<sup>2</sup>)

#### 4.3.2 Approach 2 – Analysis of structural equation model

Approach 1, the confirmatory factor analysis (CFA) has been designed to confirm the reliability and validity of the construct used in this study. Thus, approach 2, analysis of structural model is used to assess the results of the structural model, which will examine the model's predictive capabilities and the relationship between latent variables (construct).

Kock (2015) defined collinearity as a predictor-predictor phenomenon in multiple regression models. In this perspective, two or more predictors could measure the same underlining construct. Thus, path coefficients could be biased if the estimation involves significant level levels of collinearity among the predictor construct (Hair et al. 2014). Kock & Lynn (2014) suggested that if all VIF's values are equal to or lower than 3.3, the model will be free of common method bias. Furthermore, Hair et al. (2014) has suggested that if collinearity is indicated by the tolerance, then researchers need to consider eliminating construct, merging predictors into a single constructor or creating a higher-order construct to treat collinearity issues.

As illustrated in Figure 1 and Figure 3, the structural model relationship represents the hypothesized relation between construct in the model. The path coefficients of the model illustrated have a standardized value between -1 and +1. Therefore, estimated path coefficients close to +1 indicate a strong positive relationship that is always statistically significant. Furthermore, the estimated path coefficients closer to 0 indicate the weaker relationship, and statistically nonsignificant. However, Hair et al. (2014) argued that whether an estimated path coefficient is significant eventually depends on its standard error. Therefore, path coefficient is significant at a certain error probability, when t value is greater than the critical value. Hair et al. (2011) mentioned that commonly used critical values for two-tailed tests are 1.65 (significant level =10%), 1.96 (significance level =5%), and 2.57 (significance level =1%). As mentioned by both [46] and [51], critical value 1.96 with significance level = 5% has been adopted in this study.

The coefficient of determination or R<sup>2</sup> value measures the predictive accuracy, and calculate the squared correlation between endogenous construct's actual and predictive values of the proposed model of this study. Thus, the R<sup>2</sup> value ranges from 0 to 1, where a higher level of R<sup>2</sup> indicates the higher level of predictive accuracy of the construct in this model. Hair et al. (2014) suggested that scholarly research could use the R<sup>2</sup> values ranging from 0.75, 0.5 and 0.25. Therefore, the R<sup>2</sup> value of 0.50 has been adopted as a moderate value in this study.

In addition to evaluate the R<sup>2</sup> values of the endogenous construct in this study, it is an essential procedure to evaluate the change in R<sup>2</sup> values when a specified exogenous construct is omitted from the model. Thus, f<sup>2</sup> effect size will be used to examine whether omitted construct has a substantial impact on the endogenous constructs in the model.

In addition to evaluating the magnitude of R<sup>2</sup> values of predictive accuracy, it is an important procedure to examine the Q<sup>2</sup> value, which is an indicator of the model's predictive relevance. Hair et. al., (2011) mentioned that Q<sup>2</sup> accurately predicts the data points of indicators in reflective measurement model of endogenous constructs and endogenous single item construct. Hair et al. (2011) further extended his argument and concluded that Q<sup>2</sup> values greater than 0 for a reflective endogenous construct indicate the path model's predictive relevance of a construct.

To investigate the significance of inner-model and outer-models, T-statistic values are generated through the bootstrap procedure in SmartPLS. The means and standard errors of each coefficient were computed. The two-tailed statistics were used to determine if the mean value of each coefficient was significantly different from 0 at the conventional  $\alpha = .50$  level of statistical significance (Balasoorya et al. 2017, Isma'ili et al. 2016) Table 2, the T-statistic values of H<sub>1</sub>, H<sub>3</sub>, H<sub>4</sub>, H<sub>6</sub>, H<sub>8</sub>, H<sub>9</sub>, H<sub>10</sub> and H<sub>12</sub> have exceeded the standard threshold value of 1.96. This result has confirmed the outer loading of the proposed model is highly significant, and the validity of the H<sub>1</sub>, H<sub>3</sub>, H<sub>4</sub>, H<sub>6</sub>, H<sub>8</sub>, H<sub>9</sub>, H<sub>10</sub> and H<sub>12</sub>. Therefore, we can confirm that the hypotheses (H<sub>1</sub>, H<sub>3</sub>, H<sub>4</sub>, H<sub>6</sub>, H<sub>8</sub>, H<sub>9</sub>, H<sub>10</sub> and H<sub>12</sub>) that have been developed are true and they can be adopted. However, H<sub>2</sub>, H<sub>5</sub>, H<sub>7</sub> and H<sub>11</sub> are not highly significant in the proposed model, and thus, it cannot be adopted.

Paths	Hypothesis	Original Sample (O)	Sample Mean (M)	Standard Error	T-Statistics	P-Value
PEOU -> PU	H12	0.57	0.57	0.07	8.17	0
RA -> PEOU	H3	0.34	0.35	0.06	5.56	0
COM -> PEOU	H6	0.34	0.34	0.06	5.18	0
CLX -> PEOU	H9	0.21	0.19	0.06	3.68	0
COM -> AI	H4	0.3	0.29	0.09	3.29	0
CLX -> PU	H8	0.19	0.19	0.06	3.18	0
PU -> AI	H10	0.25	0.25	0.1	2.54	0.01
RA -> AI	H1	0.2	0.22	0.08	2.53	0.01
RA -> PU	H2	0.08	0.09	0.07	1.16	0.25
CLX -> AI	H7	0.04	0.04	0.06	0.65	0.52
PEOU -> AI	H11	-0.04	-0.04	0.1	0.41	0.68
COM -> PU	H5	0	0.01	0.06	0.07	0.94

Table 2. Summary of T-value significance

## 5 Significance of the study

Based on the results of the two-tier approach used in this study, it has been revealed that hypothesized relation between PEOU and PU is highly significant, and PEOU significantly affects the PU (0.572). Also, it has been revealed that relationship between PEOU and AI is non-significant, and PEOU has a strong negative effect on AI (-0.040). Furthermore, RA (0.344) and COM (0.335) will moderately impact PEOU but has a weaker impact on PU. In addition, it has been revealed that Compatibility (COM) has a strongest direct impact (0.344) on adoption Intention followed by Relative Advantage (0.202). Complexity (CLX) has indicated that it has the weakest direct influence (0.042) on adoption intention.

In addition to above findings, analysis of inner model demonstrated in Figure 4 expressed that Relative Advantage (RA), Compatibility (COM), Complexity (CLX) Perceived Ease of Use (PEOU) and Perceived Usefulness (PU) together can only explain 31% of the variance in adoption intention. Furthermore, Relative Advantage (RA), Compatibility (COM), Complexity (CLX) Perceived Ease of Use (PEOU) together have explained only 51% of the variance in Perceived Usefulness (PU), and together with Relative Advantage (RA), Compatibility (COM), Complexity (CLX) explained only 40% of the variance in Perceived Ease of Use (PEOU). However, despite uncaptured concerns in the inner model, Figure 4 suggests that Relative Advantage (RA), Compatibility (COM), Complexity (CLX) and Perceived Usefulness (PU) together is more significant in influencing adoption intention of new technologies, which is also not found in previous studies.

## 6 Conclusion and future direction

This paper has examined how organizations can improve Cloud adoption decisions by evaluating an integrated TOE and TAM frameworks. Thus, this paper has combined only technical component of the TOE with TAM framework and examined how those factors of the integrated framework could improve the adoption decisions. This study is empirically examined using 200 statistically valid samples, and results were validated for reliability and validity and confirmed the suitability of the hypotheses. The results of this analysis have provided the valuable insight and deeper understanding of the literature.

During the analysis, PLS-SEM technique has been used to analyse the data and it proved that the technique is fit for this type of research studies.

The scope of this research study was limited to an Australian organization and technology component of the TOE framework, and PU and PEOU of the TAM framework. As a future direction, the original scope of this study can be extended to other organizations and countries, and extend the scope of the TOE and TAM frameworks.



With the increasing popularity of Cloud services, Cloud security and privacy issues are gaining their importance. While there are several Cloud security issues, the one that is most worrisome for customers is data security, which includes data confidentiality and privacy protection. Stringent security measures must be used to protect the Cloud data from hacker attacks. Hackers target user data with the intention of identity theft or financial fraud, which are very serious problems. Furthermore, Cloud service providers must consider using service level agreements to provide an assurance to their customers about data protection and privacy.

In this review, applicable data and privacy protection laws have been discussed briefly, which is an important factor in the adoption or use of this Cloud computing technology. Thus, this area must be explored in detail in future studies.

## References

- Abduljalil, K.M., and Zainuddin, Y. 2015. "Integrating technology acceptance model and motivational model towards intention to adopt accounting information system", *International Journal of Management, Accounting & Economics*, vol. 2, no. 5, pp. 346-359.
- Alijani, G.S., Fulk, H.K., Omar, A., and Tulsi, R. 2014. "Cloud computing effects on small business", *Entrepreneurial Executive*, vol. 19, pp. 35-45.
- AlKharusi, M.H., and Al-Badi, A.H. 2016. "IT personnel perspective of the slow adoption of Cloud computing in public sector: Case study in Oman", 2016 3rd MEC International Conference on Big Data & Smart City (ICBDSC), pp. 1.
- Anderson, J.C., Gerbing, D.W., and Masters, J.C. 1998. "Structural Equation Modeling in Practice: A Review and Recommended Two-Step Approach," *Psy. Bull.*, vol. 103, pp.411-423.
- Armitage, C.J., and Conner, M. 2001. "Efficacy of the theory of planned behaviour: A meta-analytic review," *Br. J. Soc. Psychol.*, vol. 40, pp. 471-499.
- Ashraf, A.R., Narongsak, T., and Seigyoung, A. 2014 "The application of the technology acceptance model under different cultural contexts: The case of online shopping adoption", *Journal of International Marketing*, vol. 22, no. 3, pp. 68-93.
- Awa, H.O., Ojiabo, O.U., and Emecheta, B.C. 2015. "Integrating TAM, TPB and TOE frameworks and expanding their characteristic constructs for e-commerce adoption by SMEs", *J. Sci. Technol. Policy Manage.*, vol. 6, pp. 76-94.
- Balasoorya, P., Wibowo, S., and Wells, M. 2016. "Green Cloud computing and economics of the Cloud: moving towards sustainable future," *Proc.7th Annual Int. Conf. ICT: Big Data, Cloud Security, Singapore*.
- Balasoorya, P., Wibowo, S., and Wells, M. 2017. "Factors influencing Cloud technology adoption in Australian organizations" . In: *The 2nd International Conference on Information Technology, Nakhonpathom, Thailand*.
- FĂDor, A.G. 2014. "Innovation and technology acceptance model (TAM): A theoretical approach", *Romanian Journal of Marketing*, no. 2, pp. 59-65.
- Fornell, C and Larcker, D.F. 1981. "Evaluating structural equation models with unobservable variables and measurement error," *Journal of marketing research*, pp. 39-50.
- Haimes, Y., Horowitz, B., Guo, Z., Andrijeic, E., and Bogdanor, J. 2015. "Assessing Systemic Risk to Cloud Computing Technology as Complex Interconnected Systems of Systems". *Systems Engineering*, 18(3), pp. 284-299.
- Hair, J.F., Sarstedt, M., Hopkins, L., and Kuppelwieser, V.G. 2014. "Partial least squares structural equation Modeling (PLS-SEM): an emerging tool in business research", *European Business Review*, 26, pp. 106-121.
- Hair, J.F., Ringle, C.M., and Sarstedt, M. 2011. "PLS-SEM: Indeed a Silver Bullet", *The Journal of Marketing Theory and Practice*, 19(2), pp. 139-152.
- Hameed, M.A., and Counsell, S. 2014. "Establishing relationships between innovation characteristics and it innovation adoption in organizations : a meta-analysis approach", *International journal of innovation management*, vol. 18, no. 1, pp. 1-41.

- Hsin-Pin, F., and Hsiang-Ting, S. 2014. "A framework for a technology-organization-environment implementation model in taiwan's traditional retail supermarkets", *International Journal of Organizational Innovation*, vol. 6, no. 3, pp. 121-129.
- Hung, S.Y., Hung, W.H., Tsai, C.A., and Jiang, S.C. 2010. "Critical factors of hospital adoption on CRM system: Organizational and information system perspectives", *Decision Support Systems*, vol. 48, pp. 592-603.
- Isma'ili, A., Li, M.J., Shen, J., and He, Q. 2016. "Cloud computing adoption decision modelling for SMEs: a conjoint analysis" *International Journal of Web and Grid Services*, 12, pp. 296-327.
- Kock, N. 2015. "Common method bias PLS-SEM: a full collinearity assessment approach", *International Journal of e-Collaboration*, vol.11.
- Kock, N., and Gasking, L. 2014. "The mediating role of voice and accountability in the relationship between internet diffusion and government corruption in Latin America and Sub-Saharan Africa", *Information Technology for Development*, 20(1), pp. 23-43.
- Legris, P., Ingham, J., and Colletette, P. 2003. "Why do people use information technology? A critical review of the technology acceptance model", *Information & Management*, vol. 40, no. 3, pp. 191-204.
- Lin, H.F. 2014. "Understanding the determinants of electronic supply chain management system adoption: Using the technology-organization-environment framework", *Technological Forecasting & Social Change*, vol. 86, pp. 80-92.
- Maresova, P., Sobeslav, V., and Krejcar, O. 2017. "Cost-benefit analysis – evaluation model of Cloud computing deployment for use in companies". *Applied Economics*, 49(6), pp. 521-533.
- Premkumar, G., Ramamurthy, K., and Nilakanta, S. 1994. "Implementation of electronic data interchange: An innovation diffusion perspective", *Journal of Management Information Systems*, vol. 11, no. 2, pp. 157-186.
- Ratten, V. 2015. "International consumer attitudes toward Cloud computing: A social cognitive theory and technology acceptance model perspective", *Thunderbird International Business Review*, vol. 57, no. 3, pp. 217-228.
- Raza, M.H., Adenola, A.F., Nafarieh, A., and Robertson, W. 2015. "The slow adoption of Cloud computing and IT workforce", *Procedia Computer Science*, vol. 52, pp. 1114-1119.
- Rogers, E.M. 2010. "Diffusion of innovations", Simon and Schuster.
- Sintonen, S., and Immonen, M. 2013. "Telecare services for ageing people: Assessment of critical factors influencing the adoption intention," *Comput. Hum. Behav.*, vol. 29, pp.1307-1317.
- Tornatzky, L.G. 2005. "Innovation U: New practices, enabling cultures", *Creating Knowledge, Strengthening Nations: The Changing Role of Higher Education*.
- Tsai, L., and Hsu, L. 2012. "A study of the institutional forces influencing the adoption intention of RFID by suppliers", *Inform. Manage.*
- Völckner, F., Sattler, H., Hennig-Thurau, T., and Ringle, C.M. 2010. "The role of parent brand quality for service brand extension success". *Journal of Services Research*, 13, pp. 379-396.
- Wang, Y.M., Wang, Y.S., and Yang, Y.F. 2010. "Understanding the determinants of RFID adoption in the manufacturing industry", *Technological Forecasting & Social Change*, vol. 77, pp. 803-815.
- Wang, Y.S., Li, H.T., Li, C.R., and Zhang, D.S. 2016. "Factors affecting hotels' adoption of mobile reservation systems: A technology-organization-environment framework", *Tourism Management*, vol. 53, pp. 163-172.
- Willcocks, L.P., Venters, W., and Whitley, E.A. 2013. "Cloud sourcing and innovation: slow train coming?A composite research study", *Strategic Outsourcing (17538297)*, vol. 6, no. 2, pp. 184.
- Wu, B., and Chen, X. 2017. "Continuance intention to use MOOCs: Integrating the technology acceptance model (TAM) and task technology fit (TTF) model", *Computers in Human Behavior*, pp. 221.

**Copyright:** © 2018 P. Balasoorya. This is an open-access article distributed under the terms of the [Creative Commons Attribution-NonCommercial 3.0 Australia License](https://creativecommons.org/licenses/by-nc/3.0/australia/), which permits non-commercial use, distribution, and reproduction in any medium, provided the original author and ACIS are credited.

# Strategizing in Digital Application Marketplaces

## Ahmad Ghazawneh<sup>1,2</sup>

<sup>1</sup>School of Information Technology  
Halmstad University  
Halmstad, Sweden  
Email: [ahmad.ghazawneh@hh.se](mailto:ahmad.ghazawneh@hh.se)

<sup>2</sup>Department of Business IT  
IT University of Copenhagen  
Copenhagen, Denmark  
Email: [agha@itu.dk](mailto:agha@itu.dk)

## Osama Mansour

Jönköping International Business School  
Jönköping University  
Jönköping, Sweden  
Email: [osama.mansour@ju.se](mailto:osama.mansour@ju.se)

## Magnus Bergquist

School of Information Technology  
Halmstad University  
Halmstad, Sweden  
Email: [magnus.bergquist@hh.se](mailto:magnus.bergquist@hh.se)

## Abstract

Digital application marketplaces have become an important strategizing device for many product developing firms. However, creating and sustaining digital application marketplaces are challenging tasks and only little empirical evidence exists about the role and nature of strategy for these marketplaces and how such strategizing actually unfolds in practice. Drawing on a case study of Apple's App Store, we applied a strategy-as-process perspective to investigate the role of a digital application marketplace in the development of a digital platform. Our analysis identifies and describes three different strategies in the App Store case: monetizing, governing and enhancing, and demonstrates how they were enacted proactively or reactively to support the development of the platform.

**Keywords** digital platforms, digital application marketplaces, Strategy-as-Process, strategizing, AppStore

## 1 Introduction

Digital application marketplaces are rapidly transforming how product developing firms gather benefits from distributing, brokering, and operating applications by third-party developers (Meyer and Seliger, 1998; West and Mace 2010). Research has recently recognized the importance of such marketplaces for value creation in larger digital ecosystems (Ghazawneh and Mansour, 2015). These marketplaces act as foundational platforms that facilitate innovation in web systems and e-business portals (Evans et al. 2006) smart mobile phones (Tiwana et al. 2010; Yoo et al. 2010) and automotive technologies (Henfridsson and Lindgren 2010). In this way, they play a central role in building and sustaining the business of the platform (Evans et al. 2006; Messerschmitt and Szyperski 2003).

The success of digital application marketplaces is significant. Apple's AppStore, for instance, has generated more than 2.4 million apps, 180 billion downloads, and \$38.5 billion in revenues in less than ten years. Yet, developing and operating a digital application marketplace is not a guarantee for making it successful. In fact, firms such as Nokia, BlackBerry and Google have operated their own marketplaces without necessarily achieving the same level of success. This has stimulated significant interest in the strategic role of digital application marketplaces for digital platform business.

Different aspects of digital application marketplaces have been highlighted including marketplace typology which helps in tracing the underlying assumptions that underpin the object of interest for how different stakeholders generate value for the platform (Rudmark and Ghazawneh, 2011; Ghazawneh and Henfridsson, 2015). Also, the role of digital application marketplaces in value creation has been accounted for (Ghazawneh and Mansour, 2015). However, less is known about how a platform owner develops strategies for the digital application marketplace.

Strategizing practices are the activities through which an organization's resources are aligned (Whittington, 1996). Strategizing is a complex and partly messy process due to the fact that requirements and opportunities change and are difficult to anticipate (Galliers, 2007). A strategizing organization therefore develops practices and moves to deal with unforeseen incidents and build capacity to explore opportunities that are gradually aligned with the organization's goals (Besson & Rowe, 2012; Chia and MacKay 2007; Henfridsson and Lind, 2014). To understand how an organization strategizes a digital application marketplace, we are seeking to answer the following question: What characterizes the strategizing practices of a platform owner in attempts to create and sustain a digital application marketplace?

In order to address this research question, a single case study (Yin 2009) of Apple's digital application marketplace, AppStore, was designed, and a detailed empirical analysis of Apple's strategizing their AppStore was engaged. The remainder of this paper is structured as follows: the next section offers a review of related literature. It is followed by a presentation of the strategy-as-process perspective which is the theoretical basis in the paper. Then, an outline of the research methodology is provided. Later, the results from data analysis are presented. Finally, key conclusions and implications are developed.

## 2 Related Literature and Conceptual Background

### 2.1 Digital Platforms and Marketplaces

The concept of digital platforms is based on the development of complementary assets. It enables individuals/firms to harness software development technologies (Baldwin and Woodard, 2009; Franke and von Hippel, 2003; Ghazawneh, 2011; West, 2003) as a foundation to build complementary digital services (Gawer, 2008). Digital platforms can be found in various settings such as personal computers (Bresnahan and Greenstein, 1999), video game consoles (Iansiti and Zhu, 2007; Romberg, 2007), smartphones (Tiwana et al., 2010; Yoo et al., 2010), web systems (Evans et al., 2006), automotive technologies (Henfridsson and Lindgren, 2010) and music industry (Tilson et al., 2013)

The complementary digital services are designed, developed and employed by third-party developers (Boudreau, 2012; Evans et al., 2006; Messerschmitt and Szyperski, 2003; Ghazawneh and Henfridsson, 2015), and are in the form of applications, or "apps". These apps extend the functionality of digital platforms (Baldwin and Clark, 2000), address the needs of heterogeneous end-users, and shift the focus of the platform owner from producing software into distributing, brokering, and operating apps (Meyer and Seliger, 1998; West and Mace, 2010). The importance of developed apps and services is recognized in building digital platforms (Bergvall-Kåreborn et al., 2010; Bosch, 2009; Boudreau, 2012; Hanseth and Lyytinen, 2010). Therefore, platform owners attempt to sustain platform innovation by: (1) continuously attracting third-party developers (Bergvall-Kåreborn et al., 2010), (2) providing manifold of social and technical resources (Ghazawneh and Henfridsson, 2013), (3) establishing digital

distribution channels (Ghazawneh and Henfridsson, 2015), and (4) building healthy digital ecosystems that accommodate the stakeholders' needs (Bosch, 2009; Messerschmitt and Szyperski, 2003).

Digital application marketplaces, commonly known as App Stores, are essential parts of digital platforms. A digital application marketplace is defined as “*a platform component that offers a venue for exchanging applications between developers and end-users belonging to a single or multiple ecosystem*” (Ghazawneh and Henfridsson, 2015, p. 4). It primarily facilitates the distribution of apps and services as well as enables marketplace functionalities such as payments, commissions, and the execution of transactions (Amberg et al., 2010; Han and Ghose, 2012). It also allows users to search, browse, download, rate and review applications, and offers third-party developers the ability to publish, integrate, update and promote their apps (Magnusson and Nilsson, 2013).

## 2.2 Strategy-as-Process Perspective

It has long been acknowledged that both deliberate and emergent patterns of action drive and enable strategy content (Mintzberg, 1978). Within Information Systems, much literature has focused on deliberate strategizing (Henfridsson & Lind, 2014). The pervasiveness of digital application marketplaces along the evolution of digital ecosystems, however, makes deliberate strategizing more complex. This complexity is manifested in emergent interactions among multiple actors as they collaboratively engage in value co-creation in today's digital application marketplaces (Ghazawneh and Mansour, 2015). Strategy making in such an environment becomes a continuous process where flexibility, agility, and improvisation are increasingly necessary for devising strategic actions and practices (El Sawy, 2010) as focus shifts from strategy content (Henfridsson and Lind, 2014) into emergent strategy and strategy process (Pettigrew, 1992). This is not to say that the strong belief in deliberate strategizing is weakening, but rather to recognize strategizing complexity that may arise from messy, non-linear, and discontinuous interactions in a digital ecosystem (Besson and Rowe, 2012). Strategizing can then be seen as “*grounded in the ongoing practices of organizational actors and emerges out of their (tacit and not so tacit) accommodations to and experiments with the everyday contingencies, breakdowns, exceptions, opportunities, and unintended consequences that they encounter*” (Orlikowski, 1996, p. 65).

In seeking to understand strategizing in digital application marketplaces, strategy must thus be studied as process – strategy-as-process. This has been formulated in strategy research as the strategy-as-practice perspective which emphasizes strategizing as an ongoing activity (Jarzabkowski et al., 2007, Galliers, 2011) and recognizes practices (i.e. what actors actually do) as part of a strategizing process. The strategy process research is oriented towards the emergence of firms' strategies, which is different from strategy content research where the orientation is on strategic decisions and how they relate to the industrial context of firms (Henfridsson & Lind, 2014; Besson & Rowe, 2012; Chia and MacKay 2007). First, the adoption of a strategy-as-process perspective (Chia and MacKay 2007; Johnson et al. 2003; Jarzabkowski 2008; Whittington 2014) provides a basis for understanding the strategizing around digital application marketplaces. Second, the implementation of a strategy is viewed as a process of organizational becoming (El Sawy, 2010; Benson 1977; Orlikowski 2000), which is similar to our view of the implementation of a digital application marketplace strategy as a process of ecosystem becoming. Third, this view deals with the daily processes and practices of creating, sensing, and responding to emerging issues, rather than the content of the applied generic strategies such as cost-leadership, product differentiation, or segmentation (Porter 1980).

A strategizing process has three different interacting elements: strategic actors, strategic moves and strategic practices (Johnson et al. 2003; Whittington 2006). A process approach aims to unpack the interplay among these elements in the following way: First, strategy actors refer to actors in the ecosystem who strategize. They may be located at a firm level where the digital application marketplace owner may exercise control over the ecosystem, e.g., via administering strategies related to access to resources (Jarzabkowski 2008). However, other actors may respond to particular strategies and enact new strategic practices. Second, strategic moves are what strategy actors do i.e., “*all the various activities involved in the deliberate formulation and implementation of strategy*” (Whittington 2006, p.619), which become material for sensemaking of strategy actors (Weick 1979) and lead to new experiences, which, in turn, shapes the emergent praxis. Third, strategy practices refer to rules and resources that strategy actors draw on in their praxis (Whittington 2006). These practices can be implemented by firms (e.g., marketplaces owners) to gain advantage, either as a proactive act, or as a reactive act, i.e., as a response to other actors' strategic moves in an ecosystem (cf. Ackoff 1974).

### 3 Methodology

#### 3.1 Research Design

A single case study (Gerring 2007; Yin 2009) of Apple’s AppStore was conducted in this research. Case study research is a preferred strategy to understand contemporary and complex social phenomena (Yin, 2009), especially when the research and theory are “*at their early, formative stages*”, and research problems are practice-based where “*the experiences of the actors are important and the context of action is critical*” (Benbasat et al., 1987, p.369). There are a number of reasons why the study of Apple’s AppStore was initiated. First of all, Apple’s AppStore represents an extreme case (Yin, 2009), which is “*a case that is considered to be prototypical or paradigmatic of some phenomenon of interest*” (Gerring 2007, P. 101). Extreme cases are useful for theory generation as extremes typically define theoretical concepts (Gerring, 2007). This study engages in theory-generation, thus prototypical examples of the theoretical concepts are more important than having representative cases which are useful for theory-testing purposes. Second, Apple’s AppStore is the largest application marketplace worldwide in terms of applications, downloads, developers and revenues. Third, there exist substantial amounts of data on Apple’s AppStore, making detailed study of strategizing possible on the basis of publicly available data.

#### 3.2 Data Collection

Data from secondary sources were collected covering the period between January 2007 and February 2018 (see Table 1). Yet, the use of secondary data in case study research is unusual in information systems, and a typical concern would be a perceived distance between the researcher and the context in which the data originates (cf. Walsham, 1995). The promise in the use of secondary web-based data sources, however, is the valuable production of information for case study research (Yin, 2009). Secondary data contain a large volume of data that would be impossible to obtain using typical data collection techniques such as the qualitative interview (Romano et al., 2003) and observations (Creswell, 2003). It also provides a perspective that covers key stakeholders, whose input is often necessary for sensitizing why particular initiatives were taken as a response to environmental changes (cf. Hargadon and Douglas, 2001). In addition, it is powerful for building the extensive and longitudinal database needed for contextualization of the historical background and plot of the research setting (Klein and Myers, 1999).

Table 1. Data Sources	
Data Sources	Descriptions
Agreements and guidelines	All publicly available case documents such as: <ul style="list-style-type: none"> <li>- Registered iPhone developer agreement.</li> <li>- iOS human interface guidelines.</li> <li>- App Store Review Guidelines.</li> <li>- Guidelines for Using Apple Trademarks and Copyrights.</li> </ul>
Conferences, events, and workshops	Data collected from recorded and online-streamed Apple’s conferences and events: <ul style="list-style-type: none"> <li>- The Apple Worldwide Developers Conference (WWDC): WWDC 2007, WWDC 2008, WWDC 2009, WWDC 2010, WWDC 2011, WWDC 2012, WWDC 2013, WWDC 2014, WWDC 2015, WWDC 2016 and WWDC 2017.</li> <li>- Apple’s SDK events: iPhone SDK 2008, iPhone SDK 2009 and iPhone SDK 2010.</li> <li>- Apple’s special events: Rock and Roll event 2009, Tablet event 2010 and Special event 2011.</li> <li>- MacWorld Conference &amp; Expo: MacWorld 2007 and MacWorld 2008.</li> </ul>
E-mail conversations	- 18 messages between Apple and developers, Apple and Federal Trade Commission (FTC) and media.
Interviews	- Interview Philip Schiller, Apple’s senior vice president of worldwide product marketing with New York Times.
Online articles	1850 articles from multiple online sources: <ul style="list-style-type: none"> <li>- General magazines, newspapers and journals such as BusinessWeek.com, NYTimes.com and WSJ.com.</li> <li>- Technology-focused magazines and journals such as ComputerWorld.com, MacWorld.com, and TheRegister.co.uk.</li> <li>- Highly profiled Group-edited blogs about technology such as TechCrunch.com, GigaOM.com and Engadget.com.</li> </ul>
Press releases	- All press releases collected from Apple’s online press release library (January 2007 – February 2018). 17 press releases were selected for further analysis. - Developer news and announcements published by Apple at the iPhone Dev Center.

### 3.3 Data Analysis

Qualitative data collection often produces massive volumes of data. This is one key reason for the reputation that analyzing qualitative data is an overwhelming and cumbersome task (Patton, 2015), which happens to be especially true to the kind of data collected via secondary web-based sources in our paper. For this reason, a specialized methodology for analyzing web-based qualitative data proposed by Romano et al. (2003) was used in order to analyze our data. This generic methodology provides a structured approach to analyze dynamic, rich and large volumes of qualitative data and data that is collected via web-based sources. It consists of three key steps: elicitation, reduction and visualization.

First, relevant data segments in various formats (e.g., comments, quotes, etc.) were elicited from multiple and various data sources and then included into a database for recording study data. The elicitation process was based on the time period of January 2007 to February 2018. Data elicitation was done by careful and intensive review of all collected data types during which initial open coding (Charmaz, 2006) helped in identifying general patterns implying related themes captured as topical descriptive codes (Patton, 2015) such as AppStores, digital application marketplaces, digital distribution channels, etc. Initially, data elicitation was not deductively guided by predefined theoretical concepts from the strategy-as-process perspective. The ultimate aim was focused on organizing as much relevant data as possible to avoid chaos and confusion (Patton, 2015) that comes with a large data set like ours. Second, data reduction was done deductively using the strategy-as-process perspective as a sensitizing device for abstracting, simplifying, and transforming raw data (cf. Romano et al, 2003; Patton, 2015). To understand the process of strategizing, this step involved time-stamping selected relevant data segments that help in tracing the historical process and secure a correct timeline of events. The third and final step involved preparing time-stamped data into compressed assemblies (Romano et al., 2003) to finally draw conclusions and visualize outcomes from the data analysis process. Eventually three distinct strategies in digital application marketplaces were drawn and visualized.

## 4 Findings

### 4.1 Case Setting

Since the release of Apple’s AppStore in July 10, 2008, it was growing rapidly in terms of applications, download, number of third-party developers and revenues. The AppStore has become the largest applications store worldwide. Given this success, it can be considered useful to more closely examine the strategies applied by Apple to create and sustain its store. (see Table 2). In what follows, the strategizing around the AppStore is described.

Growth	2007	2008	2009	2010	2011	2012	2013	2014	2015	2016	2017
Apps	0	15k	120k	300k	500k	770k	1m	1.3m	1.5m	2m	2.4m
Dev	0	30k	80k	145k	190k	233k	248k	272k	310k	350k	400k
Dow	0	0.5b	3b	7b	18b	30b	60b	80b	110b	150b	180b
Rev	0	\$206m	\$769m	\$1.7b	\$3b	\$8b	\$10b	\$15b	\$20b	\$29b	\$38.5b

Apps: Applications, Dev: Developers, Dow: Downloads, Rev: Revenue, k: thousand, m: million, b: billion

### 4.2 Introducing the AppStore

After the release of the first iPhone [June 27, 2007], Apple decided to use Safari web browser as the main “hub” between users and third-party developers. This strategy enabled web applications and content on the iPhone. In his keynote at Apple Worldwide Developers Conference (WWDC 2007), Apple’s CEO, Steve Jobs, emphasized the main advantages of using Safari were the distribution and update process of applications:

*After you [third-party developers] write them [web “apps”] you have instant distribution, you don’t have to worry about distribution just put them on your Internet server. And they are really easy to update, just change the code on your own server, rather than having to go through this really complex update process.*

A growing list of companies ported their applications to the Safari web browser. Google, Twitter, Facebook, Flickr, New York Times, were among the first movers to bring their applications. Scott Forstall, the Senior Vice President of iPhone software at Apple, revealed that the number of ported iPhone web applications exceeded 1,000 in a short time. However, Apple’s strategy of not allowing native applications on the iPhone was criticized by huge number of developers. As a response, on October 17, 2007, Steve Jobs confirmed Apple’s new strategy of allowing native applications and an exclusive digital application marketplace for users to search, browse, buy and download iPhone applications. The digital



application marketplace was revealed at Apple's iPhone SDK event on March 06, 2008, officially released on July 10, 2008 and was called the AppStore. Steve Jobs explained the idea of the AppStore:

*This is an application we've written to deliver apps to the iPhone. And we are gonna put it on every single iPhone with the next release of the software. And so our developers are gonna be able to reach every iPhone user through the AppStore.....The AppStore is going to be the exclusive way to distribute iPhone applications*

### 4.3 Monetizing the AppStore

During the iPhone SDK event [March 06, 2008], the terms of the deal between Apple and applications developers was revealed. Apple shares 30% of application sales revenues and 70% go to third-party developers. Free applications will be determined by third-party developers and will be downloaded by end-users for free. Steve Jobs introduced the deal:

*We think we've got a great business deal for our developers. First of all, the developer picks the price, pick whatever price you wanna sell your app at, when we sell the app through the AppStore the developer gets 70% of the revenues right off the top, we keep 30% to pay for running the AppStore. There are no credit card fees for the developer... there are no hosting fees... there is no marketing fees.... Its paid monthly [revenues] ...This is the best deal going to distribute application to mobile platforms..... There is no charge for free apps at all, there is no charge to the users and there is no charge to the developer.*

Apple introduced a Developer Program that is designed to make resources available for third-party developers and enable the distribution of applications. The Developer Program annual fee was set at \$99 for individual developers and \$299 for enterprises. The number of developed applications exceeded 15,000, download rate 0.5 billion and \$206 million in revenue by the end of 2008. At Apple's iPhone 3.0 Press Conference [March 17, 2009], Apple's head of iOS Product Marketing, Greg Joswiak, revealed that over 50,000 individuals and development firms joined the paid Developer Program. Few days later, on March 25, 2009, Apple updated their refund policy. Apparently, if end-users decide that they want a refund for their applications within ninety days of the date of download, Apple requires the developers to refund the full sale amount and Apple keeps its commission. The clause in the contract reads:

*Apple may refund to the end-user the full amount of the price paid by the end-user for that Licensed Application. In the event that Apple refunds any such price to an end-user, You shall reimburse, or grant Apple a credit for, an amount equal to the price for that Licensed Application. Apple will have the right to retain its commission on the sale of that Licensed Application, notwithstanding the refund of the price to the end.*

The AppStore was growing rapidly and daily-added applications were extremely increasing. Gaming applications dominated the AppStore. Apple leveraged this opportunity and created a new viral revenue source by introducing a new service called Game Centre. The new service which was introduced at the iPhone 4.0 event [April 08, 2010] is a social gaming network that connects multiplayer and facilitates the process of sending invitations to other users to download and play games. Apple shares 30% of games sales revenues through Game Centre. Third-party developers usually maintain their free applications by making revenues through embedded advertisements. It was reported by [Gartner] that the worldwide mobile advertising revenue generated \$1.6 billion in 2010. Google and its subsidiary AdMob accumulated more than 50% of their ad revenues through iPhone, iPod touch and iPad devices. At the iPhone 4.0 event [April 08, 2010], Apple announced its own mobile advertising service. The service was called "iAd", officially released on July 1, 2010 and competed directly with Google's AdMob. Steve Jobs commented on the new service:

*Developers have to find way to make some money, and we would like to help them. Now what some of the developers are starting to do, is to put advertising into their apps... We think most of this mobile advertising really sucks, and we thought we might be able to make some contributions... It's all about helping our developers make some money through advertising so they can keep their free apps free.*

Apple retains 40% of the ad revenue and the rest 60% goes to third-party developers. The initial starting price of an iAd campaign was set at \$1 million [April 08, 2010]. In order to attract small advertisers, the price was lowered to \$0.5 million [February, 2011] and lowered up to \$300,000 [July, 2011]. To deal effectively with advertisers who have gone to other ad services and to encourage third-party developers to use the service, Apple slashed iAd pricing up to \$100,000 [February, 2012] and decided to retain 30% of the ad revenue rather than their previous 40% cut.

At Apple Tablet event [January 27, 2010] a new sales and delivery service of electronic books was announced. The service, called iBooks, enables users to purchase ebooks from an associated book store. Two years later [January 19, 2012], Apple released a tool for small publishers to create their own ebooks "iBooks Author". Apple demands 30% commission on all iBooks Author sales. Apple's end user license agreement for the iBooks Author specifically reads:

*If you charge a fee for any book or other work you generate using this software (a “Work”), you may only sell or distribute such Work through Apple (e.g., through the iBookstore) and such distribution will be subject to a separate agreement with Apple.*

Many major newspapers and magazines that are charging readers for full access to their applications in the App Store criticized this move. Apple responded by loosening its new media subscription rules.

#### 4.4 Governing the App Store

As to ensure the integrity of the AppStore, Apple set up an application review process. Each application submitted to the AppStore is subject to approval by Apple. Third-party developers submit their application to the AppStore and wait for approval or rejection by the AppStore review team. Third-party developers of rejected applications receive comments and feedback from the AppStore review team on the reason behind the rejection of their applications. AppStore review team gives third-party developers the chance to resubmit their rejected applications after being modified according to the review. Since the inception of the AppStore [July 10, 2008], Apple introduced a non-disclosure agreement (NDA) with third-party developers. The rejection notices and messages from the AppStore review team are covered by this agreement. The agreement prohibits third-party developers to publish or reveal their rejection notices. Apple later [October 1, 2008] dropped the (NDA), because, according to Apple statement:

*It created too much of a burden on developers, authors and others interested in helping further the iPhone’s success.*

All applications and their updates have to go through a lengthy review process before they are deployed into the AppStore. The review process was criticized by tons of third-party developers, technology analysts and firms. First, there was no specific time delay for applications to be approved. The approval process sometimes took few days, few weeks or even months. Second, no detailed feedback was given to developers, sometimes not rather than “approved” or “rejected”. Third, Apple did not publish any review guidelines that could be followed by third-party developers. MG Siegler, a well-known tech journalist commented on this:

*We’ve seen dozens of apps that are approved the first time, but later rejected for a seemingly small update. And we’ve seen others that are rejected, make almost no change, yet get in the next time they’re submitted. It would seem the life or death of an app is entirely in the hands of the App Store inspector who checks it out. Sometimes they catch things that they don’t want in the App Store, sometimes they do.*

As response to third-party developers’ concerns, Apple’s senior vice president of worldwide product marketing, Phillip Schiller, stated on one of his private messages to a third-party developer of a rejected application that [August 6, 2009]:

*Apple’s goals remain aligned with customers and developers – to create an innovative applications platform on the iPhone and iPod touch and to assist many developers in making as much great software as possible for the iPhone App Store. While we may not always be perfect in our execution of that goal, our efforts are always made with the best intentions, and if we err we intend to learn and quickly improve.*

Few months later [December, 2009], Apple started giving detailed feedback and comments to third-party developers. This was followed [January, 2010] by another action of speeding up the review process, which sometimes performed in less than three days. At the same time, AppStore review team was tightening the restriction on applications and banning any application that contained pornographic material. In an interview with New York Times [February 22, 2010], Philip Schiller, Apple’s senior vice president of worldwide product marketing, said:

*An increasing number of apps containing very objectionable content... It came to the point where we were getting customer complaints from women who found the content getting too degrading and objectionable, as well as parents who were upset with what their kids were able to see.*

Steve Jobs emphasized this at the iPhone 4.0 OS event [April 08, 2010] during a Q&A session:

*You know, there’s a porn store for Android. You can download nothing but porn. You can download porn, your kids can download porn. That’s a place we don’t want to go – so we’re not going to go there.*

On September 9, 2010, Apple released the first set of a set of guidelines to third-party developers. The introductory section started with:

*This is the first time we have published our App Store Review Guidelines. We hope they will help you steer clear of issues as you develop your app, so that it speeds through the approval process when you submit it.*

Less than a year later, Apple updated the AppStore guidelines to accommodate the new subscription models. The new guidelines document ended with clarification on why Apple isn’t governing the AppStore and submitted applications:

*Lastly, we love this stuff too, and honour what you do. We’re really trying our best to create the best platform in the world for you to express your talents and make a living too. If it sounds like we’re control freaks, well, maybe it’s because we’re so committed to our users and making sure they have a quality experience with our products. Just like almost all of you are too.*

#### 4.5 Enhancing the App Store

The greatest strength of the AppStore is its huge number of applications. However, this is turning it into a weakness for many third-party developers and users. In fact, the huge number of applications makes it harder for third-party developers to market and promote their applications and harder for users to find the appropriate application they are looking for. Through continuous service and feature enhancements Apple adapted the AppStore to its huge growth. As part of the iPhone 3.1 firmware upgrade, Apple enhanced the AppStore with a new feature that allows users to search for new applications based on their previous purchase history. This feature goes by the name “Genius” and works as a recommendation system. At Apple’s Rock and Roll special event [September 09, 2009], the “Genius” feature was one of two major services highlighted and praised by Steve Jobs:

*Wouldn't it be great if the AppStore could recommendations of apps to you... and that's what Genius does now.... and it is really nice.... and this will only get better and better as we get larger databases of people, what they buy, what they like.*

This was followed by enhancing the AppStore with another new feature labelled as “Top Grossing”. This new feature enables users to view and explore the top grossing apps. It helps high quality and expensive grossing apps to get more exposure. It initially shows the 25 top grossing apps with the option to view more. At the same month [September 29, 2009] Apple rolled out a new feature called “Apps for Everything”. The main concept behind is to allow users to find apps around certain categories of their interest and allow third-party developers to base their applications around certain relevant categories. One of the main concerns of users when purchasing from the AppStore is the workability and the quality of the app. Apple [December 11, 2009] redesigned the individual app description page. Instead of being text-heavy and one app screenshot, Apple changed the way third-party developers do their descriptions and allow multiple app screenshots. About a year later [August 05, 2010], Apple added a new section in the AppStore called “Try Before You Buy”, that would serve both users and third-party developers. This service enables users to try a demo lite of the app before deciding whether they want to purchase it or not.

In order to help third-party developers spreading their applications and boost their revenues, Apple released two main features for the AppStore. The first feature allows third-party developers to use promotional codes that can be redeemed later by users and give them the chance to use the application with no additional cost. The other is the “Gift This App” feature [March 22, 2010] for the AppStore. This feature enables users to buy and gift applications for friends or family. While the AppStore is growing and the number of applications reached 550,000 applications that were downloaded about 25 billion times [February, 2012], the functionality of searching and discovering applications remained the biggest problem. Most recently [February 23, 2012], Apple acquired app search and discovery platform “Chomp” for about \$50 million. This acquisition revamps the AppStore search and recommendations services.

### 5 Discussion

In this paper, the main aim was to provide empirically grounded understanding of strategizing practices used by platform owners in attempts to create and sustain their digital application marketplaces. The following table describes three key strategies including monetizing, governing, and enhancing together with proactive or reactive strategic practices and associated strategic moves.

<b>Strategy</b>	<b>Strategic Practice</b>	<b>Strategic Moves</b>
Monetizing	Proactive monetizing	<ol style="list-style-type: none"> <li>1. Applied the 30% transaction cut of application sales revenues.</li> <li>2. Introduced the developer program and set the registration at \$99 for individual developers and \$299 for enterprises.</li> <li>3. Released the In-App purchase service for paid applications and applied the 30% transaction cut.</li> <li>4. Released the In-App purchase service for free applications and applied the 30% transaction cut.</li> <li>5. Introduced the Game Center service and applied the 30% transaction cut.</li> <li>6. Introduced the iAd service and applied the 40% transaction cut.</li> <li>7. Set the initial starting price of an iAd campaign was set at \$1 million.</li> <li>8. Introduced the iBooks service and applied the 30% transaction cut.</li> <li>9. Introduced a new subscription service dedicated to publishers of media and applied the 30% transaction cut.</li> </ol>

	Reactive monetizing	<ol style="list-style-type: none"> <li>1. Updated the refund policy: requires developers to refund the full sale amount and Apple keeps its commission.</li> <li>2. Lowered the initial starting price of an iAd campaign to \$0.5 million.</li> <li>3. Lowered the initial starting price of an iAd campaign to \$300,000.</li> <li>4. Lowered the initial starting price of an iAd campaign to \$100,000.</li> <li>5. Lowered the iAd transaction cut to 30%.</li> </ol>
Governing	Proactive governing	<ol style="list-style-type: none"> <li>1. Set the initial applications review process.</li> <li>2. Introduced the non-disclosure agreement (NDA).</li> <li>3. Tightened the restriction on applications.</li> <li>4. Released the first set of a set of guidelines to third-party developers.</li> <li>5. Updated the AppStore guidelines to accommodate the new subscription models.</li> </ol>
	Reactive governing	<ol style="list-style-type: none"> <li>1. Dropped the non-disclosure agreement (NDA).</li> <li>2. Started giving detailed feedback and comments to third-party developers.</li> <li>3. Sped up the review process.</li> </ol>
Enhancing	Proactive enhancing	<ol style="list-style-type: none"> <li>1. Released the AppStore with the “Genius” feature.</li> <li>2. Released the “Top Grossing” feature.</li> <li>3. Rolled out the “Apps for Everything” service.</li> <li>4. Acquired app search and discovery platform “Chomp”.</li> </ol>
	Reactive enhancing	<ol style="list-style-type: none"> <li>1. Redesigned the individual app description page.</li> <li>2. Released the ““Try Before You Buy” service.</li> <li>3. Allowed third-party developers use promotional codes.</li> <li>4. Released the “Gift This App” service.</li> </ol>

**Monetizing:** It is defined as the generation of new business opportunities through the digital application marketplace. Monetizing can either be proactive or reactive. Proactive monetizing refers to the creation of new lines of business for enriching the digital application marketplace owner with new funding opportunities. It is observed how Apple built new sources of income by initiating nine different services. Apple requested 30%-40% transaction cut of the purchase each time applications, contents or subscriptions were sold through the AppStore. Further, they created another source of revenue by introducing the developer program and set memberships fees for thousands of individual third-party developers and developing enterprises. Apple lowered the initial starting price of an iAd campaign three times during the case to attract small advertisers or to deal with advertisers who have gone to other ad services. In this way, both reactive and proactive monetizing reflect flexible and agile strategizing process (El Sawy, 2010) by Apple as it accommodates opportunities (Orlikowski, 1996) and meets stakeholders’ needs (Bosch, 2009; Messerschmitt and Szyperski, 2003).

**Governing:** The analysis shows that governing is an important strategy for digital application marketplace owners. Controlling the digital application marketplace and being responsible of what applications and services can be deployed and distributed is referred to as Governing. In a digital application marketplace that involves multiple actors, it is necessary to emphasize on governing – a verb –, rather than governance, as a continuous process (Orlikowski, 1996) to act upon any possibility for messy interactions and relationships (Galliers, 2007, Besson & Rowe, 2012). Governing can therefore be either proactive or reactive. Governing is proactive if it involves actions that tighten the degree of accepting applications and dealing with them during the review process. Apple, for example, introduced the non-disclosure agreement (NDA) that made the review process very tough and the amount of comments and feedback very limited. Governing can also be reactive. In order to respond to third-party developers and authorities’ requests, Apple relaxed their review process, sped up response time and started giving detailed comments and feedbacks to third-party developers.

**Enhancing:** Enriching the digital application marketplace with new capabilities and features is another key strategy. This strategy is referred to as Enhancing. Such enhancing is proactive when it involves releasing new capabilities and features that affect the efficiency of the AppStore and facilitate its functionality. For instance, Apple released the “Genius”, “Top Grossing” and “Apps for Everything” features and managed to enhance the functionality of searching and discovering applications. The acquisition of the search and discovery platform “Chomp” is another strategic move towards the establishment of new and improved search environment for the AppStore. Enhancing can be reactive. Enhancing as strategizing practice embodies both deliberate and emergent strategizing (Whittington 2006; Mintzberg, 1978; Pettigrew, 1992). Digital application marketplaces are built on digital features and capabilities by the marketplace owner who strives to continuously monitor and evolve its digital infrastructure. This is necessary for initiating digital business and also sustaining the entire ecosystem.

## 6 Conclusions and implications

Our research offers a number of key conclusions and implications regarding the study of strategizing practices in digital application marketplaces. It was found that digital applications marketplace owners

identify, configure, enact, and practice several strategies in attempts to develop and maintain their business. Three main strategies that can be enacted either proactively or reactively were synthesized in this paper including monetizing, governing and enhancing. These strategies show that strategizing in digital application marketplaces is enabled by a series of different strategies that jointly determine its relative success together with the digital platform. This is why platform owners should continuously monitor the evolution of the digital application marketplace to be able to develop strategic moves for new opportunities or to react to other actors' strategic moves. These conclusions have a number of implications for advancing existing literature and future research: first, it complements and extends the literature on digital platforms (Baldwin and Woodard 2009; Franke and von Hippel 2003; Morris and Ferguson 1993; Tiwana et al. 2010; West 2003; Yoo et al. 2010) by applying a strategy-as-process perspective (Chia and MacKay 2007; Johnson et al. 2003; Jarzabkowski 2008; Whittington 2006) in digital application marketplaces. Second, this study identified three main strategies which offer a new perspective on the nature of strategy in the context of digital application marketplaces and platforms. Finally, future research is needed for comparing different digital application marketplaces and their strategizing practices.

## 7 References

- Ackoff, R.L. (1974). *Redesigning the Future: A Systems Approach to Societal Problems*. New York : John Wiley and Sons.
- Amberg, M., Thiessen, I., Lang, M., and Belkuis, B., (2010) *Mobile Application Marketplaces - an Investigation from Customers' Perspective*. In proceeding of MKWI 2010.
- Baldwin, C. and Clark, K. (2000), *Design Rules, Vol. 1: The Power of Modularity*, Cambridge, MA: MIT Press.
- Baldwin, C. and J. Woodard. (2009). *The Architecture of Platforms: A Unified View*. A. Gawer, ed. *Platforms, Markets and Innovation*. Edward Elgar, London, UK.
- Benbasat, I., Goldstein, D. K., and Mead, M. "The Case Research Strategy in Studies of Information Systems," *MIS Quarterly* (11:3), 1987, pp. 369–386.
- Benson, J. Kenneth 1977 "Organizations: A dialectical view." *Administrative Science Quarterly*, 22: 1-21.
- Bergvall-Kåreborn, B., and Howcroft, D. (2011) *Mobile Applications Development on Apple and Google Platforms*, *Communications of the Association for Information Systems*, 29 (1), Article 30.
- Besson, P. and Rowe, F., 2012. Strategizing information systems-enabled organizational transformation: A transdisciplinary review and new directions. *The Journal of Strategic Information Systems*, 21(2), pp.103-124.
- Bosch, J. (2009) *From Software Product Lines to Software Ecosystems*. The 13th International Software Product Line Conference (SPLC 2009), San Francisco, CA, USA.
- Boudreau, K. 2012. Let a thousand flowers bloom? An early look at large numbers of software app developers and patterns of innovation. *Organization Science*, 23(5): 1409 – 1427.
- Bresnahan, T. F., Davis, J. P., and Yin, P. 2013. "Economic value creation in mobile applications," *The changing frontier: Rethinking science and innovation policy* University of Chicago Press.
- Charmaz, K. *Constructing Grounded Theory: A Practical Guide through Qualitative Analysis*. Thousands Oaks, CA: SAGE Publications, 2006.
- Chia R. and McKay, B. (2007) 'Post-processual Challenges for the Emerging Strategy-as-Practice Perspective: Discovering Strategy in the Logic of Practice', *Human Relations*, 60(1): 217-242.
- Creswell, J.W., (2003). *Research Design: Qualitative, Quantitative, and Mixed Methods Approaches*, (2nd ed.) SAGE Publications, Thousand Oaks.
- El Sawy, O.A., Malhotra, A., Park, Y., Pavlou, P.A., 2010. Seeking the configurations of digital ecodynamics: it takes three to tango. *Information Systems Research* 21 (4), 835–848.
- Evans, D.S., Hagiu, A. and Schmalensee, R. (2006) *Invisible Engines: How Software Platforms Drive Innovation and Transform Industries*, Cambridge MA: MIT Press.
- Franke, N. and E. von Hippel., (2003). "Satisfying Heterogeneous User Needs via Innovation Toolkits: The Case of Apache Security Software," *Research Policy* 32(7) 1199-1215.
- Galliers, R. D. (2007). *Strategizing for Agility: Confronting Information Systems Inflexibility in Dynamic Environments*. In Desouza, K. C. *Agile Information Systems. Conceptualization, Construction, and Management*. Burlington, MA: Butterworth-Heinemann.
- Gerring, J., (2007) *Case study research: Principles and practices*. Cambridge, UK: Cambridge University Press.
- Ghazawneh A (2011) *The power of platforms for software development in open innovation networks*. *International Journal of Networking and Virtual Organisations*9(2):140–154.
- Ghazawneh, A., and Henfridsson, O. (2013) "Balancing Platform Control and External Contribution in Third-Party Development: The Boundary Resources Model," *Information Systems Journal*.
- Ghazawneh, A., Henfridsson, O. (2015) *A Paradigmatic Analysis of Digital Application Marketplaces*. *Journal of Information Technology*. 0, 1–11. doi:10.1057/jit.2015.16
- Ghazawneh, A. and Mansour, O., 2015. *Value Creation in Digital Application Marketplaces: A Developers' Perspective*. In *Thirty Sixth International Conference on Information Systems*, Fort Wort, Texas, 2015.
- Han, SP., and Ghose, A. (2012). *Estimating Demand for Applications in the New Mobile Economy*. In: *Proceedings of International Conference on Information Systems, ICIS*. Orlando Florida, USA. Dec 2012.

- Hanseth, O., and Lyytinen, K. (2010) "Design Theory for Dynamic Complexity in Information Infrastructures: The Case of Building Internet," *Journal of Information Technology* (25:1), pp 1-19.
- Hargadon, A.B., & Douglas, Y. (2001) When Innovations Meet Institutions: Edison and the Design of the Electric Light. *Administrative Science Quarterly*, 46, 476-501.
- Henfridsson, O. and Lind, M., 2014. Information systems strategizing, organizational sub-communities, and the emergence of a sustainability strategy. *The Journal of Strategic Information Systems*, 23(1), pp.11-28.
- Henfridsson, O., and Lindgren, R., (2010). "User involvement in developing mobile and temporarily interconnected systems." *Inform. Systems Journal*. (20:2) 119-135.
- Henfridsson, O., Yoo, Y., Svahn, F., (2009). "Path Creation in Digital Innovation: A Multi-Layered Dialectics Perspective," *Sprouts: Working Papers on Information Systems*, 9(20). <http://sprouts.aisnet.org/9-20>
- Huang, P., Ceccagnoli, M., Forman, C., and Wu, D.J., (2009) "When Do ISVs Join a Platform Ecosystem? Evidence from the Enterprise Software Industry". In *Proceedings of International Conference on Information Systems (ICIS)*, Proceedings. Paper 161.
- Iansiti, M., and Zhu, F., (2007) "Dynamics of Platform Competition: Exploring the Role of Installed Base, Platform Quality and Consumer Expectations" (2007 In *Proceedings of International Conference on Information Systems (ICIS) 2007*, Proceedings. Paper 38.
- Jarzabkowski, P. 2008. Shaping strategy as a structuration process. *Academy of Management Journal* (51:4).pp. 621-650.
- Johnson, G., L. Melin, and R. Whittington 2003 'Micro-strategy and strategizing towards an activity-based view'. *Journal of Management Studies* 40/1: 3-22.
- Klein, H. and Myers, M. (1999) A Set of Principles for Conducting and Evaluating Interpretive Field Studies in Information Systems, *MIS Quarterly*, and 23(1): 67-93.
- Magnusson, J. and Nilsson, A. (2013) Introducing app stores into a packaged software ecosystem: a negotiated order perspective, *Int. J. Business Information Systems*, 14 (2): 223-237.
- Messerschmitt, D.G., and Szyperki, C. (2003). "Software Ecosystem: Understanding an Indispensable Technology and Industry," MIT press.
- Meyer, M. H. and Seliger, R., (1998). Product platforms in software development, *Sloan Management Review*, Fall 1998, 40(1), 61-74.
- Mintzberg, H., 1978. Patterns in strategy formation. *Management Science* 24 (9), 934-948.
- Orlikowski, W.J., 1996. Improvising organizational transformation over time: a situated change perspective. *Information Systems Research* 7 (1), 63-92.
- Orlikowski, W. J. (2000). Using Technology and Constituting Structures: A Practice Lens for Studying Technology in Organizations. *Organization Science*, 11(4), 404-428.
- Patton, M. (2015). *Qualitative research and evaluation methods*.
- Pettigrew, A.M., 1992. The character and significance of strategy process research. *Strategic Management Journal* 13, 5-16.
- Porter, M.E. 1980. *Competitive Strategy: Techniques for Analyzing Industries and Competition*. New York: Free Press.
- Romano, N. C., Donovan, C., Chen, H., & Nunamaker, J. F. "A methodology for analyzing web-based qualitative data," *Journal of Management Information Systems*, (19:4), 2003, pp. 213-246.
- Romberg, T., (2007), Software platforms - how to win the peace, *Proceedings of the 40th Hawaii International Conference on System Sciences (HICSS-40)*, 1-10.
- Rudmark, D., Ghazawneh, A. (2011): Third-Party Development for Multi-Contextual Services: On the Mechanisms of Control. In: *European Conference on Information Systems (2011)*
- Tilson, D., Sørensen, C., and Lyytinen, K. (2013) "Platform Complexity: Lessons from the Mu-sic Industry". 46th Hawaii International Conference on System Sciences (HICSS). pp. 4625 - 4634.
- Tiwana, A., Konsynski, B., and Bush, A., "Research Commentary: Platform Evolution: Coevolution of Platform Architecture, Governance, and Environmental Dynamics," *Information Systems Research*, (21:4), December 2010, pp. 675-687.
- Walsham, G (1995) Interpretive case studies in IS research: nature and method, *European Journal of Information Systems*, 4(2): 74-81.
- Weick, K.E., (1979) *The Social Psychology of Organizing*, 2d ed. Reading, MA: Addison-Wesley.
- West, J. 2003. "How Open Is Open Enough? Melding Proprietary and Open Source Platform Strategies," *Research Policy* (32), pp 1259-1285.
- West, J., and Mace, M. (2010) Browsing as the Killerapp: Explaining the Rapid Success of Apple's iPhone. *Telecommunications Policy*, 34, 270-286.
- Whittington, R. (2006). Learning more from failure: Practice and process. *Organization Studies*, (27:12), pp. 1903-1906.
- Whittington, R. (1996). Strategy as practice. *Long range planning*, 29(5), 731-735.
- Whittington, R., 2014. Information systems strategy and strategy-as-practice: a joint agenda. *The Journal of Strategic Information Systems*, 23(1), pp.87-91.
- Yin, R.K. *Case Study Research: Design and Methods*, (2009). Thousand Oaks: SAGE Publications.
- Yoo, Y., Henfridsson, O., and Lyytinen, K., (2010) "Research Commentary: The New Organizing Logic of Digital Innovation: An Agenda for Information Systems Research," *Information Systems Research*, (21:4), December, pp. 724-735.

# **Business model innovation and strategic transformation when confronting digital disruption: The case of data-driven business models for professional services**

## **Erwin Fielt**

School of Information Systems  
Queensland University of Technology  
Brisbane, Australia  
Email: e.fielt@qut.edu.au

## **Peter Westerveld**

School of Information Systems  
Queensland University of Technology  
Brisbane, Australia  
Email: peter.westerveld@hdr.qut.edu.au

## **Kevin Desouza**

School of Management  
Queensland University of Technology  
Brisbane, Australia  
Email: kevin.desouza@qut.edu.au

## **Guy Gable**

School of Information Systems  
Queensland University of Technology  
Brisbane, Australia  
Email: g.gable@qut.edu.au

## **Abstract**

Most businesses and industries are undergoing significant disruption due to digital innovation. We focus our discussion on the rise of data-driven business models in the professional services industry. Big data, advanced analytics and artificial intelligence solutions are now diffusing across industries. Professional services firms are knowledge-intensive which may raise specific issues in relation to data analytics and artificial intelligence. In addition, these firms currently face high levels of potential disruption due to digital innovation by new start-ups. When trying to understand the impact of these developments on the professional services industry, two prominent issues need to be considered. Firstly, digital innovation often results in the creation of new business models. This raises questions about whether these models are more generic (digital), showing great similarities across industries, or specific to the professional services industry. Moreover, there are questions related to whether the initiators of business model innovation are new, digital start-ups, or well-established incumbents. Secondly, when an incumbent is required to transform due to digital disruption, we need a more nuanced understanding of the strategic transformation processes in relation to the nature of professional services and technology innovation. Our paper makes two major contributions to the literature. First, it takes a critical look at data-driven business models in the context of professional services firms. Second, it puts forth several research propositions that warrant further critical examination when it comes digital disruption barriers and enablers faced by incumbents and start-ups.

**Keywords:** Digital innovation, data-driven, professional services firms, business model innovation, strategic transformation.

## 1 Introduction

The ongoing proliferation of digital technologies, such as mobile technology, cloud computing, data analytics, and internet of things, is changing the way people live their lives, transforming the way organizations conduct their business, and creating new kinds of services and products. The World Economic Forum states that ‘the future of countries, businesses, and individuals will depend more than ever on whether they embrace digital technologies’ (Baller et al. 2016, p. v). These new digital technologies, and the disruptive innovations they enable and drive, often require novel, digital business models (Fichman et al. 2014). Business model innovation (Foss and Saebi 2017; Massa and Tucci 2014), which is targeting new ways for organizations to create and capture customer value (Chesbrough 2006; Fielt 2013), has become a prominent theme in the digital age. However, digital business model innovation and its relation with organization transformation is not well understood (DaSilva et al. 2013). Only a few studies have been conducted so far (e.g., Westerman et al. 2014) and these often do not address the specific challenges of business model innovation nor do they focus on particular industries, like professional services.

The objective of this paper is to examine business model innovation for digital innovation by looking at the specific case of data-driven business models in the professional services industry. Professional services firms (e.g., management consulting, accounting, legal, finance, etc.) are knowledge-intensive, which may raise specific issues in relation to how data analytics and machine learning innovations impact their operational and strategic postures. In addition, these firms currently face high levels of potential disruption due to digital innovations by new start-ups, frequently labelled nowadays as LegalTech, HR Tech, Accounting Tech, FinTech, etc. According to the World Economic Forum (2017, p. 4), “professional services appears to be approaching a tipping point, as disruptive technologies drive fundamental changes in the industry’s economics.”

When trying to understand the impact of digital innovation due to data analytics and artificial intelligence on the professional services industry, two prominent issues need to be considered. Firstly, digital innovation often results in the creation of new business models. This raises questions about whether these models are more generic (digital), showing great similarities across industries, or specific to the professional services industry. Moreover, there are questions related to whether the initiators of business model innovation are new, digital start-ups, or well-established incumbents. Secondly, when an incumbent is required to transform due to digital disruption, we need a more nuanced understanding of the strategic transformation processes.

The remainder of this research-in-progress paper is structured as follows. First we provide a brief overview of data-driven business models and the professional services industry. Next we explore some initial ideas for business model innovation and strategic transformation when confronting digital disruption. We end with presenting our concluding remarks and future research.

## 2 Data-driven business models and the professional services industry

With the advances of big data, analytics and algorithms (Chen et al. 2012; Günther et al. 2017; Newell and Marabelli 2015), business models have become data-driven (Hartmann et al. 2016). Data-driven business models are shaped by critical data-driven elements. Data is the key resource, the process of turning data into value as key activity, data-enriched or data-driven products and services as value proposition, and monetize data as revenue stream (Hartmann et al. 2016; Schüritz et al. 2017; Wixom and Ross 2017). Hartmann et al. (2016) have identified six types of data-driven business models differentiated by key data source and key data activity based on an empirical analysis of start-ups. Firms often have different options when it comes to creating data-driven business models. For example, the Climate Corporation started with using data analytics for providing weather insurance to agriculture firms as opposed to providing weather forecasting and planning services<sup>1</sup>. Next it moved out of the weather insurance and became a digital agriculture platform that supports agriculture firms to make data-driven decisions to maximize their return<sup>2</sup>.

Firms can use data, analytics and algorithms to improve and/or innovate (or disrupt) their business model (Günther et al. 2017; Loebbecke and Picot 2015; Woerner and Wixom 2015). To *improve* their business model, firms can use data, analytics and algorithms to refine and optimize their business

---

<sup>1</sup> Retrieved from <http://www.climate.com/growers/total-weather-insurance/> [7/9/2012]

<sup>2</sup> Retrieved from <https://climate.com/about> [25/7/2018]



processes and decision making (Woerner and Wixom 2015). To *innovate* their business model, firms can use data, analytics and algorithms to find new ways of generating revenues, enter new markets, and even explore new sources of competitive advantage through strategic renewal via data monetization and digital transformation (Woerner and Wixom 2015). According to a study from McKinsey (Chin et al. 2017), analytics can create new opportunities and disrupt entire industries. For example, some companies are now charging for the analytics-enabled service rather than directly selling the product. (e.g., Rolls-Royce's 'Power-by-the-Hour'). Günther et al. (2017) note that improvement and innovation approaches can be mixed and even happen in sequence. Loebbecke and Picot (2015) warn that traditional firms may fail to benefit from big data analytics as the improvement of business models will not be enough for lasting competitive advantage due to the commodization of big data 'solutions' and the innovation of business models may be a struggle for these firms when established business models get disrupted. The identification of appropriate approaches to take advantage of emerging digital technologies is concern faced by non-profit (Desouza and Smith 2014) and public agencies (Desouza and Jacob 2017) as well.

The professional services industry has emerged as one of the most rapidly growing, profitable, and significant sectors of the global economy (Empson et al. 2015). Professional services firms are knowledge intensive organizations that facilitate economic and commercial exchange by providing advice to business (Greenwood et al. 2006). They are comprised primarily of professionals and their key resources are intellectual capital and expertise. Empson et al. (2015) state that professional services firms are defined by four characteristics they all possess, to varying degrees: (1) the primary activity of applying specialist knowledge to create customized solutions to clients' problems, (2) specialist technical knowledge of professionals and in-depth knowledge of their clients as core assets, (3) governance arrangements with extensive individual autonomy and contingent managerial authority, where core producers own or control core assets, and (4) an identity where core producers recognize each other as professionals and are recognized as such by clients and competitors. Maister (1993) notes that professional services firms perform three types of work: (1) procedural work for which the solution/approach is (mostly) well-known and the focus is on efficiency, (2) grey hair work requiring skills and experience and (3) brain work requiring expertise and innovation.

With the increasing availability and access to data for anyone ('data democratization') and new ways of creating and leveraging knowledge (e.g., crowdsourcing), the strategic position of these firms as gatekeepers is potentially under threat. For example, in the legal service industry, established firms are confronted with new start-ups that are introducing new digital services such as legal decision predictions (e.g., Case Crunch<sup>3</sup>) and 'robot lawyers' (e.g., DoNotPay<sup>4</sup>). Data-driven business model for professional services firms may be different from other industries due to its specific characteristics, as noted above, and how data and technology play a role in the industry. For example, in some professional service industries there is data which is a shared resource. Take the legal service industry where predictive models have been developed that predict the behaviour of the Supreme Court of the United States, based on historical Supreme Court justice votes and case data (Katz et al. 2017). Moreover, today's technologies such as machine learning and the availability of databases is making it possible for new innovations (e.g. digital agents), autonomous tools to fill legal forms and even provide recommendations for simple queries and tasks.

### **3 Exploring ideas for business model innovation and strategic transformation**

When trying to understand the impact of digital disruption on the professional services industry, we propose that two prominent issues need to be considered based on our preliminary analysis. First, digital innovation often comes with new business models. This raises questions about whether these models are more generic (digital), showing great similarities across industries, or specific to the particular professional services industry. Moreover, there are questions related to whether the initiators of business model innovation are new, digital start-ups, or well-established incumbents. Second, when an incumbent is required to transform due to digital disruption, we need a more nuanced understanding of the strategic transformation processes in relation to the nature of professional services and technology innovation. Below we will further elaborate these preliminary ideas and develop some possible scenarios for business model innovation and strategic transformation.

---

<sup>3</sup> See <https://www.case-crunch.com/>

<sup>4</sup> See <https://www.donotpay.com/>

Starting-point for our reasoning is that digital disruption often come with new, digital business models (Fichman et al. 2014; Fielt and Gregor 2016). The disruptive impact of digital technologies on the business models of different industries is substantially highlighted in practitioner publications (e.g., Deloitte Australia 2012; Deloitte Australia 2014) and as such this could indicate that there is a need for more specific academic research in this area. The new, digital business models often rise to prominence in one or a few industries and from there spread to other industries. For example, the notion of crowdsourcing via digital platforms (McAfee and Brynjolfsson 2017) came to prominence in the late 1990s and early 2000s via examples like SETI@home, Wikipedia, and Innocentive. In the last years, we have seen crowdsourcing being introduced for legal services (e.g., Legal Services Link) and strategy consulting (e.g., Deloitte). The question rises if these models will work there too and if so, to what extent they may need to be adapted to the specific opportunities and threats of the industry and strengths and weaknesses of the firm.

When a particular industry is confronted with new business models due to digital disruption, we see two possible choices with respect to the new business models themselves as well and the initiators of these models based on ideas from, amongst others, Chesbrough (Chesbrough 2010; Chesbrough and Rosenbloom 2002), Christensen (Christensen 1997; Christensen and Raynor 2003) and Govindarajan and Trimble (2005; 2010). Firstly, the new business models themselves can be more generic, showing great similarities across industries, or be specific to a particular industry or organization. The generic business models emphasize the new idea (e.g., crowdsourcing) and the digital innovations enabled by digital technologies (e.g., easy access, automatic matching, global reach) as proven by their (initial) successful application in other industries. The specific business models will tap into proven practices and arrangements of the particular industry or even organization, which will result in major adaptations of the digital business model or even reinventing it. This will make the business model less disruptive, which can be both advantageous (as it is more aligned to the existing operating environment and strategic framework and will encounter less resistance) as well as disadvantageous (as it will less likely offer radical new benefits or appeal to new customers).

Secondly, the initiators of business model innovation in a particular industry can be new, digital start-ups or well-established incumbents. Existing professional services firms (e.g. McKinsey, Accenture, etc.) have key resources like their brand name, human capital, knowledge, project/matter/client databases and expertise that they can leverage in a digital world. However, other characteristics, like their traditional business model and their specific organizational form (partnership model), may hinder them in adapting to digital disruption. For example, when the professional logic (i.e., the interpretive schemes or institutional logics of a profession) is strong, professionals can be highly risk averse (Barratt and Hinings 2015). Moreover, they may have trouble in acquiring or integrating the digital capabilities required. While new start-ups may lack some of the reputation and brand recognition when compared to the incumbents, they do have the opportunity to access human and intellectual capital in the specific industry and then scale it through digital platforms that support intellectual asset re-use (Davenport et al. 2003), personalized delivery of knowledge resources and automated learning systems to predict and respond to future service needs.

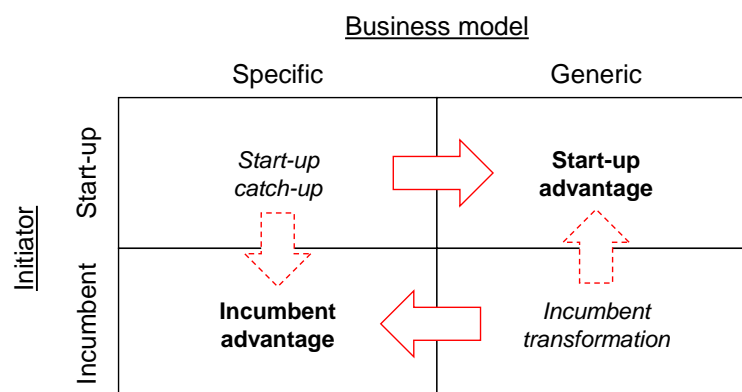

Figure 1: Business model innovation scenarios.

Looking across the new business models and the initiators of these models, we see 4 possible strategic positions as presented in Figure 1. We tentatively propose that when digital business models are more specific for the industry then the incumbents will more likely have a competitive advantage. In this case the strengths of incumbents are well aligned with some of the key characteristics of the digital business model. We also tentatively propose that when digital business models are more generic across industries

then the start-ups will more likely have a competitive advantage. The digital start-ups will benefit from their greenfield approach and their agility while the incumbents are hindered by their dominant logic and technological legacy (e.g., tech debt). Moreover, the uptake of new digital initiative may be hindered by the traditional business due to fear of revenue cannibalization.

In addition, we suggest that when the incumbent has a disadvantage, they need to transform and either find ways to leverage of their existing strengths and/or tap into the start-up advantage. This creates a paradox for the incumbent as these point to opposite approaches. On the one hand, they will be pulled towards finding ways to try to integrate their new data-driven initiative with their existing business, while on the other hand they will be pulled towards differentiating their new data-driven initiative from their existing business. When the start-up has a disadvantage, they need to catch-up with existing strengths of incumbents and either need to find ways to tap into the incumbent advantage and/or leverage start-up advantages. This creates a paradox for the start-up as these point to opposite approaches. On the one hand, they will be pulled towards collaborating with incumbents while on the other hand they will be pulled towards competing with them head on.

We are especially interested in the strategic transformation of incumbent professional services firms. While some general advice is available in relation to disruptive innovation (Christensen 1997; Christensen and Raynor 2003) and strategic innovation (Govindarajan and Trimble 2005), these approaches do not cover the knowledge-intensive nature of professional services nor the dynamics of technology innovation. As such, we intend to look deeper into how these two factors play a role in the strategic transformation as professional services firms come in a wide assortment of forms (Figure 2). As such, we may expect that their transformation approaches and barriers may depend on this. A critical dimension to classify these firms (or their business units) is in respect to their dependence on existing knowledge assets. A firm with high dependence on existing knowledge assets will have established high barriers to entry for their competitors. As an example, firms offering consulting services in the defence and security arena would meet these criteria. These firms depend on decades on knowledge assets that include social capital, prior project experiences, and specialized know-how that is not easy to acquire on the market instantly. A firm with low dependence on existing knowledge assets will need to continuously innovate to stay ahead of its competitors by keeping its knowledge assets fresh and relevant. Let us be clear, we are not arguing that a firm's existing knowledge assets are of no value. What we are saying that is that in order for the firm to compete, they cannot use their dependence on their existing knowledge assets as a measure of how insulated they are from competitor's actions (due to the history, costs, or resources required to acquire or replicate the knowledge).

With respect to the dynamics of technology innovation, IT can be an operational capability or a strategic (dynamic, improvisational) capability (Pavlou and El Sawy 2010). Of particular importance is that a strategic IT capability can support organizations with the transformation in moderately to highly turbulent environments. In addition, the IT architecture of the organization will also determine to which extent an organization can evolve and integrate new IT-based solutions (Alwadain et al. 2016). Figure 2 depicts a simple matrix that can be used to map professional services firms on the two dimensions. We expect that the more depended a professional services firm is on industry-specific knowledge assets the more complex and unique the technology and implementation of technological innovation required. And therefore, the more dynamic the role and capability of technology will need to be. The less dependent on industry-specific knowledge assets will allow for a more repeatable and less complex process driven approach where a less strategic but more continuous improvement role and technology capability is required.

**Dependence on Industry-Specific Knowledge Assets**

		Low	High
Dynamism of Technological Innovation	Low	Firm 1	Firm 2
	High	Firm 3	Firm 4

Figure 2: Strategic transformation scenarios.

## 4 Concluding remarks and future research

In this research-in-progress paper, we focussed on business model innovation and strategic transformation when professional services firms are confronting digital disruption driven by big data, advanced analytics and artificial intelligence. We in particular are interested in the barriers and enablers for incumbents and start-ups and the influence of industry-specific knowledge assets and technology innovation. We elaborate our preliminary ideas with the purpose of exploring this topic, not so predefining a theoretical framework.

For our future work, we propose to study business model innovation and strategic transformation in relation to the rise of data-driven business models within the legal services industry. This study will focus on the B2B legal market segment which typically operates in the higher value part of the legal professional services market, have a higher dependency on more complex knowledge assets and prior project experience and does not fit the more typical B2C digital disruption models. As a first study, we plan to do a multiple case study with one large international traditional law firm, one medium sized traditional national law firm and one new start-up law firm. This study has the objective to answer the question to what extent data-driven business model dimensions are already present (as-is) and compare incumbent traditional model law firms across different geographic footprint and size with a start-up firm in this context. In addition, we plan to compare our initial insights with the ideas and opinions of industry experts by performing a Delphi study in order to answer the question what the future opportunities of a data-driven business model for B2B law firms could be.

## 5 References

- Alwadain, A., Fielt, E., Korthaus, A., and Rosemann, M. 2016. "Empirical Insights into the Development of a Service-Oriented Enterprise Architecture," *Data & Knowledge Engineering* (105), pp. 39-52.
- Baller, S., Dutta, S., and Lanvin, B. (eds.). 2016. *The Global Information Technology Report 2016: Innovating in the Digital Economy*. Geneva: World Economic Forum.
- Barratt, M., and Hinings, B. 2015. "Service Innovation in Professional Service Firms: A Review and Future Research Directions," in *The Oxford Handbook of Professional Service Firms*, L. Empson, D. Muzio, J. Broschak and B. Hinings (eds.). Oxford, UK: Oxford University Press pp. 238-254.
- Chen, H., Chiang, R. H. L., and Storey, V. C. 2012. "Business Intelligence and Analytics: From Big Data to Big Impact" *MIS Quarterly* (36:4), pp. 1165-1188.
- Chesbrough, H. 2006. *Open Business Models: How to Thrive in the New Innovation Landscape*. Boston, MA: Harvard Business School Press.
- Chesbrough, H. 2010. "Business Model Innovation: Opportunities and Barriers," *Long Range Planning* (43:2-3), pp. 354-363.
- Chesbrough, H., and Rosenbloom, R. S. 2002. "The Role of the Business Model in Capturing Value from Innovation: Evidence from Xerox Corporation's Technology Spin-Off Companies," *Industrial and Corporate Change* (11:3), pp. 529-555.
- Chin, J. K., Hagstroem, M., Libarikian, A., and Rifai, K. 2017. "Advanced Analytics: Nine Insights from the C-Suite," McKinsey & Company.
- Christensen, C. M. 1997. *The Innovator's Dilemma: When New Technologies Cause Great Firms to Fail*. Boston, MA Harvard Business School Press.
- Christensen, C. M., and Raynor, M. E. 2003. *The Innovators Solution: Creating and Sustaining Successful Growth*. Boston, MA: Harvard Business School Press.
- DaSilva, C. M., Trkman, P., Desouza, K., and Lindič, J. 2013. "Disruptive Technologies: A Business Model Perspective on Cloud Computing," *Technology Analysis & Strategic Management* (25:10), pp. 1161-1173.
- Davenport, T. H., Thomas, R. J., and Desouza, K. C. 2003. "Reusing Intellectual Assets," *Industrial Management* (45:3), pp. 12-13.
- Deloitte Australia. 2012. "Digital Disruption: Short Fuse, Big Bang?," Deloitte Touche Tohmatsu.
- Deloitte Australia. 2014. "Digital Disruption - Harnessing the 'Bang': Stories from the Digital Frontline," Deloitte Touche Tohmatsu.
- Desouza, K. C., and Jacob, B. 2017. "Big Data in the Public Sector: Lessons for Practitioners and Scholars," *Administration & Society* (49:7), pp. 1043-1064.
- Desouza, K. C., and Smith, K. L. 2014. "Big Data for Social Innovation," *Stanford Social Innovation Review* (12:3), pp. 39-43.
- Empson, L., Muzio, D., Broschak, J., and Hinings, B. 2015. "Researching Professional Service Firms: An Introduction and Overview," in *The Oxford Handbook of Professional Service Firms*, L.

- Empson, D. Muzio, J. Broschak and B. Hinings (eds.). Oxford, UK: Oxford University Press pp. 1-22.
- Fichman, R. G., Dos Santos, B. L., and Zheng, Z. E. 2014. "Digital Innovation as a Fundamental and Powerful Concept in the Information Systems Curriculum," *MIS Quarterly* (38:2), pp. 329-353.
- Fielt, E. 2013. "Conceptualising Business Models: Definitions, Frameworks and Classifications," *Journal of Business Models* (1:1), pp. 85-105.
- Fielt, E., and Gregor, S. 2016. "What's New About Digital Innovation?," Paper presented at the Information Systems Foundations (ISF) Workshop, Canberra, AU.
- Foss, N. J., and Saebi, T. 2017. "Fifteen Years of Research on Business Model Innovation: How Far Have We Come, and Where Should We Go?," *Journal of Management* (43:1), pp. 200-227.
- Govindarajan, V., and Trimble, C. 2005. *Ten Rules for Strategic Innovators: From Idea to Execution*. Boston, MA: Harvard Business Review Press.
- Govindarajan, V., and Trimble, C. 2010. *The Other Side of Innovation: Solving the Execution Challenge*. Boston, MA: Harvard Business Review Press.
- Greenwood, R., Suddaby, R., and McDougald, M. 2006. "Introduction," in *Professional Service Firms (Research in the Sociology of Organizations, Volume 24)*, R. Greenwood and R. Suddaby (eds.). Emerald Group Publishing Limited, pp. 1-16.
- Günther, W. A., Rezazade Mehrizi, M. H., Huysman, M., and Feldberg, F. 2017. "Debating Big Data: A Literature Review on Realizing Value from Big Data," *The Journal of Strategic Information Systems* (26:3), pp. 191-209.
- Hartmann, P. M., Zaki, M., Feldmann, N., and Neely, A. 2016. "Capturing Value from Big Data: A Taxonomy of Data-Driven Business Models Used by Start-up Firms," *International Journal of Operations & Production Management* (36:10), pp. 1382-1406.
- Katz, D. M., Bommarito, M. J., and Blackman, J. 2017. "A General Approach for Predicting the Behavior of the Supreme Court of the United States," *PLoS One* (12:4).
- Loebbecke, C., and Picot, A. 2015. "Reflections on Societal and Business Model Transformation Arising from Digitization and Big Data Analytics: A Research Agenda," *Journal of Strategic Information Systems* (24:3), pp. 149-157.
- Maister, D. H. 1993. *Managing the Professional Service Firm* New York, NY: Free Press.
- Massa, L., and Tucci, C. L. 2014. "Business Model Innovation," in *The Oxford Handbook of Innovation Management*, M. Dodgson, D. Gann and N. Phillips (eds.). Oxford, UK: Oxford University Press, pp. 420-441.
- McAfee, A., and Brynjolfsson, E. 2017. *Machine, Platform, Crowd: Harnessing Our Digital Future*, (1 ed.). New York, NY: W. W. Norton & Company.
- Newell, S., and Marabelli, M. 2015. "Strategic Opportunities (and Challenges) of Algorithmic Decision-Making: A Call for Action on the Long-Term Societal Effects of 'Datification'," *The Journal of Strategic Information Systems* (24:1), pp. 3-14.
- Pavlou, P. A., and El Sawy, O. A. 2010. "The 'Third Hand': It-Enabled Competitive Advantage in Turbulence through Improvisational Capabilities," *Information Systems Research* (21:3), pp. 443-471.
- Schüritz, R., Seebacher, S., Satzger, G., and Schwarz, L. 2017. "Datatization as the Next Frontier of Servitization: Understanding the Challenges for Transforming Organizations," in *Proceedings of the 38th International Conference on Information Systems (Icis 2017)*. Seoul, South Korea.
- Westerman, G., Bonnet, D., and McAfee, A. 2014. *Leading Digital: Turning Technology into Business Transformation*. Boston, MA: Harvard Business Review Press.
- Wixom, B. H., and Ross, J. W. 2017. "How to Monetize Your Data," *Sloan Management Review* (58:3), pp. 10-13.
- Woerner, S. L., and Wixom, B. H. 2015. "Big Data: Extending the Business Strategy Toolbox," *Journal of Information Technology* (30:1), pp. 60-62.
- World Economic Forum. 2017. "Digital Transformation Initiative: Professional Services Industry," World Economic Forum, Geneva.

## Copyright

**Copyright:** Erwin Fielt, Peter Westerveld, Kevin Desouza and Guy Gable © 2018. This is an open-access article distributed under the terms of the [Creative Commons Attribution-NonCommercial 3.0 Australia License](https://creativecommons.org/licenses/by-nc/3.0/), which permits non-commercial use, distribution, and reproduction in any medium, provided the original author and ACIS are credited.

# Barriers for Digital Transformation: The Role of Industry

## Henrik CJ Linderoth

School of Engineering  
Jönköping University  
Jönköping, Sweden  
Email: [henrik.linderoth@ju.se](mailto:henrik.linderoth@ju.se)

## Mattias Jacobsson

School of Engineering  
Jönköping University  
Jönköping, Sweden  
Email: [mattias.jacobsson@ju.se](mailto:mattias.jacobsson@ju.se)

## Amany Elbanna

School of Management  
Royal Holloway University of London  
Egham, UK  
Email: [amany.elbanna@rhul.ac.uk](mailto:amany.elbanna@rhul.ac.uk)

## Abstract

Limited attention has been paid to why certain industries, like the AEC (Architectural, Engineering and Construction), is lagging behind in digital transformation. The question can be raised if there are characteristics on industry level that constrain digital transformation? The aim of the paper is to explore how the interactions among four industry key actors; architects, clients, contractors and consultants shape industry characteristics and the options for digital transformation through adoption and use of digital technology. The aim will be achieved through a combination of individual- and focus group interviews with representatives of the key actor groups focused on how they perceive Building Information Modelling (BIM). It is concluded that the characteristics of the industry; the focus on practical day-to-day action, a heterogeneous client side who have difficulties in putting demands on contractors and sub-contractors due to lack of competencies, and a product that raise barriers for process innovations do effectively constrain digital transformation.

**Keywords** Industry analysis, Digitalization, Transformation, Building and Construction, ICT, Adoption

## 1 Introduction

Digitalization is claimed to be one of the most prominent transformative forces in society. In an organizational context, digital transformation can be understood as the combined effects of digital innovations bringing about novel actors and actor constellations, structures, practices, values or beliefs that change, threaten, replace, or complement existing rules of the game in organizations, ecosystems, industries or fields (Hinings et al. 2018: 53). A digital innovation is described as the use of digital technology in a wide range of innovations, where digital is understood as the conversion of analogue information into binary language understood by computers (Nambisan et al. 2017:224).

However, not all industries can undertake digital transformation effectively. For example, the AEC (Architectural, Engineering and Construction) the industry is claimed to considerably lag behind other industries in the uptake of digital technologies (Agrawal et al. 2016). For example, the transformative, or disruptive potential of Building Information Modelling (BIM), the most predominant technology influencing the AEC industry to date, has been discussed for more than a decade without a significant increase in its adoption rate (see e.g. Eastman et al., 2011). Thus, the question can be raised if there are some features, or characteristics of the AEC industry that constrain digital transformation?

In 2005 Chiasson and Davidson (2005) claimed that industry has received little attention in IS-research when developing theory and stated that (2005:597): *“By focusing only on the organizational context, researchers may overlook elements in the industry that facilitate or constrain actors’ IT-related actions”*. Still, how industry shape IS-/IT-/ICT-/digital-related activities has received some attention in IS-research. To provide some examples, Chatterjee et al. (2001) argued that firms in very dynamic industries, whose business processes and product/service offerings are highly digitizable, are likely to engage in seemingly continuous stream of IT deployments. By focusing on industry type (general manufacturing, high-tech, banking/finance, and retailing service), Yeh and Chang (2007) showed how industry affects the motivation of firms to adopt security countermeasures. Cho and Mathiasen (2007) showed, by applying Van de Ven’s (2005) industry infrastructure framework, how the influence of different components of the industry infrastructure alters over time and how there is a necessity of engaging different stakeholders in order to develop and components in the industry infrastructure. In a study of adoption of internet-based innovations in two US industries, Melville and Ramirez (2008) showed that information processing requirements in an industry determines IT-adoption and diffusion. Muhanna and Stoel (2010) showed that IT capability appeared to be more relevant for the firm value in high tech industries, by investigating the relationships between IT capability, IT spending and market value, and Joshi et al. (2018) investigated how systematic variation in IT governance disclosure was influenced by the strategic role of IT in an industry.

while these studies, in different ways, focus on how industry shapes IT-related actions, the majority of them can be seen as taking their point of departure in variance theories (Markus and Robey 1988), where they, to a lesser extent, focus on the underlying mechanisms shaping the characteristics of an industry and how these influence IT-related activities. Based on Scott et al. (2000), Chiasson and Davidson (2005) identified “factors” in the material and resource respectively the institutional environment that shape the features of an industry. These features are in turn assumed to influence IT-related activities. However, no further analysis was done of how the interactions among the “factors” shapes industry characteristics, which could give a deeper understanding of why IT-related activities are conducted in certain modes. Jacobsson et al. (2017), developed the Chiasson and Davidson (2005) framework further in order to explain how interactions between industry features shape IT-related actions in the building and construction industry. The overall conclusion in that study is that interaction patterns among elements in the market and production environment, as well as institutional actors shape the socio-cognitive environment, where meaning is made of ICT, which in turn shapes the adoption and deployment of ICT (Jacobsson et al. 2017). However, their focus of their paper (*ibid*) was only on one key actor group, the contractors. In order to enhance the understanding of how characteristics of an industry is shaped and how these characteristics influence ICT-related activities, the role of different key actors has to be investigated. Accordingly, the aim of the paper is to explore how the interactions among four industry key actors; architects, clients, contractors and consultants shape industry characteristics and the options for digital transformation through adoption and use of digital technology. The aim will be achieved by a combination of individual- and focus group interviews with representatives of the key actor groups focused on how they perceive barriers and driving forces for adoption and use of Building Information Modelling (BIM).

## 2 Building Information Modelling (BIM)

At the bottom line, a building information model involves contains a combination of "objects" – vague and undefined, generic or product-specific, solid shapes or void-space oriented (like the shape of a room), that carry their geometry, relations and attributes. BIM design tools allow extraction of different views from a building model for drawing production and other uses. These different views are automatically consistent, being based on a single definition of each object instance. BIM software also defines objects parametrically; that is, the objects are defined as parameters and relations to other objects, so that if a related object is amended, dependent ones will automatically also change. Each model element can carry attributes for selecting and ordering them automatically, providing cost estimates as well as material tracking and ordering (Eastman et al. 2011). BIM use can be classified on a more conceptual level after its capabilities (see also Carlo et al. 2012). This is, BIM can be used for 3D visualization, analysis and simulation, co-ordination and communication, and data extraction and transfer. These capabilities are in turn build up by two underlying capabilities: object-based information and xyz co-ordination that helps to accurately triangulate the geometric position of each object in the design space. For example, visualization and the xyz co-ordination helps to accurately triangulate the geometric position of each object, and for example detect clashes between objects.

## 3 Analysing Industry

If industry is claimed to be an important element for the understanding of the deployment of ICT, a crucial question is how industry can be understood? When defining industry, a wide array of definitions can be identified depending on the perspective taken. With the focus on products, Porter's (1980) basic definition is that industry is a group of companies producing products that are close substitutes for each other. The point of departure for this perspective is similar to that of an organizational population, i.e. organizations facing similar environmental vulnerabilities that foster similarities in adaptive capabilities and structural form (Hannan and Freeman 1977). If other organizational populations and institutional actors are included in the analysis, industry can be considered as an organizational field (Scott et al. 2000), which according to DiMaggio and Powell (1983:148) includes "... *those organizations that in aggregate, constitute a recognized area of institutional life: key suppliers, resources and product customers, regulatory agencies and other organizations that produce similar services or products.*"

Regardless of the perspective chosen, it is important to understand that what is seen as industry is not static (Chiasson and Davidsson 2005). One such example is the nowadays blurred boundaries between the telecom, computer, and entertainment industry. Thus, when studying how industry shapes ICT related activities, it is of crucial importance for future theorizing that authors states their view on industry (*ibid*). Thus, in this paper industry is briefly considered as an organizational field, because the paper takes its point of departure from studies originating from this perspective.

### 3.1 The Building and Construction Industry

Major characteristics of the building and construction industry are for example that relations among actors are characterised by short-term market-based interactions (Gann 1996; Dubois and Gadde 2002). It is driven by the lowest price tender policy; a focus on action and short-term gains in operations (Jacobsson and Linderoth 2010) which result in actors optimising their own processes instead of the construction process as a whole (Love et al. 1998). The optimization of actors' own processes can be seen as a consequence of another central feature that distinguishes the building and construction industry from other industries: the way power is distributed (Harty 2005). A construction project may be coordinated by one actor, for example the main contractor, but each one of the organizations involved in a project has its own influence on the project and bring its own expectations and working methods (*ibid*). Even if contractual obligations are the mainstay of the formal coordination in the industry, in practice these are hard to enforce, especially when the work is underway (Earl 1996).

By drawing on Chiasson and Davidson (2005), Porac et al. (1989), and Orlikowski and Gash (1994), Jacobsson et al. (2017) developed a framework for analysing the building and construction industry, in order to give a plausible answer to the question of why the industry looks and functions as it does, and how characteristics of industry shape the adoption and use of ICT. In the overall framework, the interplay between the market and production environment, and institutional actors, shape the socio-cognitive environment. In this way ICT applications are given a meaning and made sense of in the socio-cognitive environment that in turns shape the adoption and use in certain directions (figure 1).



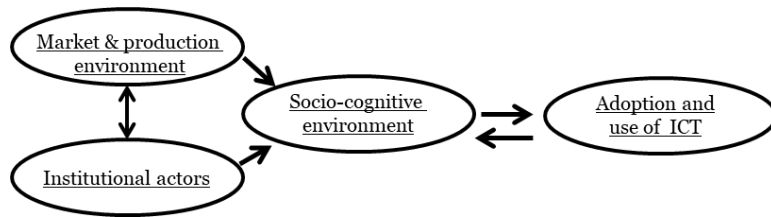

Figure 1: The shaping of adoption and use of ICT (Jacobsson et al. 2017)

The creation of the socio-cognitive environment, this is, the creation of interpretive frames that in turn shape the adoption and use of ICT, is further illustrated in figure 2. By starting the analysis in the market and production environment with demand-side factors, clients demand for unique designs and an immobile product imply that organising by projects becomes the most appropriate technology. Organizing by projects imply that time, cost, and scope will be of central importance in the governance system. While the project is a temporary endeavour governed by time, cost and scope, this does not imply *per se* that relations among actors in a project network become short-term and market-based. However, traditional demands from clients for a lowest price tender policy, force actors to form a project network with those who happen to have the lowest bid. This can be seen as a major reason for the short-term market-based relations characterising the industry. Thus, by drawing on Porac et al. (1989), it can be claimed that the focus on *actions*, in order to accomplish a project on time and within budget, is a central component in actors' interpretive frames regarding what it takes to compete successfully in the industry. These frames also have significant impact on the adoption and use of ICT, this is, benefits from ICT-use need to be fast and visible (Jacobsson and Linderoth, 2010). The focus on action is however not only present on the operational levels. Löwstedt and Räisänen (2014) describe how a practical and problem-solving focus, or "doer mentality", is a strong source of identity construction on all managerial levels in construction firms. In this sense, the client can be regarded as one of the most powerful institutional actor. As clients prioritise a lowest price tender policy, they reinforce both governance systems and short-term market-based relations among actors, and also the existing socio-cognitive environment where time and action are key characteristics.

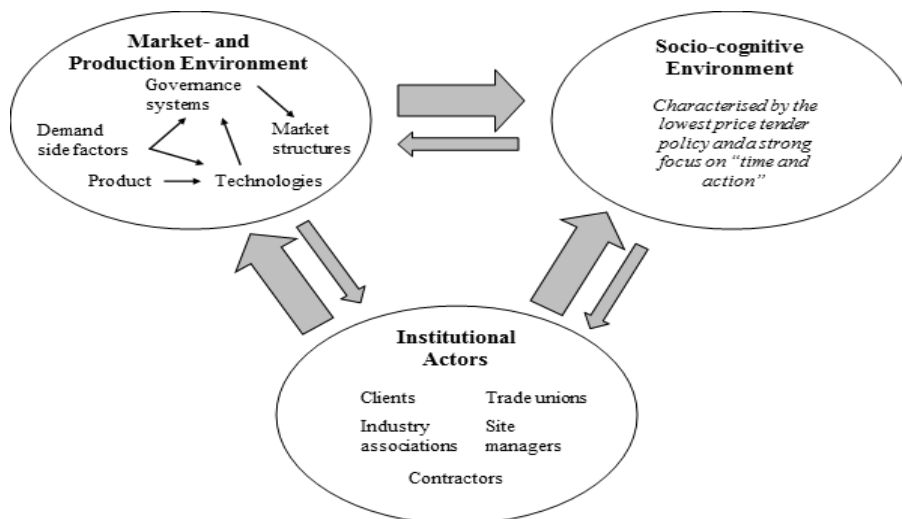

Figure 2: The creation of the socio-cognitive environment (Jacobsson et al. 2017)

Accordingly, the client and the product are central ingredients to understand how the characteristics of the building and construction industry have emerged over time. However, even if the client is powerful, its focus on investment costs is a bit paradoxical with regard to the life time of products and that the majority of costs are connected with operation and maintenance. Therefore, is it of interest to further investigate how the client view its operations and relations to other key actors in the industry.

## 4 Method and Data Collection

This research takes its basis in a qualitative oriented research project targeting experienced representatives of the Swedish building and construction industry. The empirical material collected can be divided into two interrelated parts; semi-structured interviews and focus group interviews. Selection of respondents was primarily guided by willingness and commitment to participate. This was of great importance due to the integrated study design and the fact that interviewees were later invited to participate in the focus group interviews. Without willingness and commitment, the overall design would run the risk of failing (Krueger and Casey 2014; Dahlin-Ivanoff and Holmgren 2017).

In line with the study design, a total of 20 semi-structured interviews were conducted with four actor groups; clients, architects, contractors, and consultants. Five interviews were undertaken with each actor group. Adhering to common recommendations, all interviews was carried out at the office of the respondents to promote openness and familiarity (see e.g. Bryman and Bell 2015). The interviews were carried out between January 2017 and May of 2018 and totaled more than 30 hours, which corresponds to approximately 700 pages when transcribed. The transcribed interviews were sent out to each respondent for validation and approval. At the time of the interviews, the respondents had an average industry experience of over 23,5 years.

Following the semi-structured interviews, focus group interviews were undertaken in five rounds. Following the practical suggestions by Krueger and Casey (2014), we opted for a multiple-category design which provides a possibility to compare perspectives and ideas. The first four rounds were done with homogeneous groups in terms of the respondents being representatives from the same actor group. The fifth and final focus group interview were heterogeneous to its design in that it included one representative from each of the four actor groups. In line with the general rationale behind conducting focus group interviews, all respondents were presented with a specific theme (Dahlin-Ivanoff and Holmgren 2017). The theme for the first four rounds related to the actors' views of existing barriers and drivers identified via the interviews, whilst the fifth focus group targeted possible solutions. In simple terms, one could argue that the first four rounds were problem oriented, whilst the final round was solution oriented. In essence, the focus group interviews complemented the semi structured interviews as they gave us an opportunity make sense of the identified barriers, and constructing meaning around it (Bryman and Bell 2015).

## 5 A Short-Sighted Practice Based Industry

In this section, the adoption and use of BIM and other digital technologies among the four industrial key actors will be described. In order to get an initial understanding of the adoption and use, key actors' perceptions of their daily operations and their interactions among each other will also be described. A major observation from the individual- and the focus group interviews is a perceived time pressure at all stages of the process, that is one constraint for exploring and exploiting BIM. In the following sub-sections, the major focus will be on the client and the contractor, for the simple reason that these are the two most powerful actors.

### 5.1 Client – BIM, What's in It for Us?

In the interviews and in the focus group with the client representatives, they were a bit ambivalent towards BIM. They see the benefits with clash controls in the detailed design stage, but when it comes to facility management they find it harder to see direct benefits. The project manager for the commercial facility management company express, however, some visions in the mixed focus group interview;

*“The dream scenario for me, linked to digitalization and BIM and all this, it is, I think we should do life cycle analysis on all our buildings before we start [to build]. How we do that? No idea? But if we have all the conditions ready and build virtual, completely, three, four models, then we could do calculation on, in principal, everything... and then chose one of the models”*

In the individual interviews and in the focus group interviews, there are not many concrete ideas expressed about the practical BIM use. But the managing director for the municipal housing company has become very positive towards BIM on the general level. Even if both companies do not have any digitalized information models of their buildings, they are highly digitalized in other areas. Both companies have very good control of the operation of the buildings. If an error occurs with some equipment, the janitor on duty get an alarm about what is malfunctioning. The facility manager for the housing company further state that they have very good control over what they have in the apartments.

They know when they have put new wallpaper in the rooms, how old the stoves are, and they can control ventilation and the temperature in the apartments. Managers from both companies further state that they get a lot of operational data from their facilities, but they never do any meta-analysis of the data. Thus, in both companies, most buildings are on-line in the sense that the operation of the buildings can be remotely controlled. The housing company also have rather encompassing information about the status of equipment in the apartments. When it comes to information about the physical building, the access to information is however rather poor. When the question is asked if they know how many windows there are and what features the windows have, in case they should change the windows in the buildings in a residential area, the manager laughs in response. He then explains that they send a janitor out to count the windows, because they should also have something to do! Moreover, the representatives for both companies confess that it is very difficult to get some good structure of the drawings of the buildings. One interviewee state that they lost the control when CAD appeared and they got the drawings on CD's. The facility manager explains that they had better control over drawings when they were on paper and put into binders.

The degree of digitalization of facility information can, however, be seen a bit paradoxical regarding the trust in the systems. On one side, both companies' facilities are more or less on-line with regard to operation of the facility and the housing company has systems for controlling the information about the status of the apartments and their equipment. On the other side, when BIM and the information about the physical building is discussed, a scepticism arises connected to the time horizon. The head of facility management states that their time perspective is 50 to 100 years, whereas in the IT-industry the time perspective might be one to two years, so he asks if it is possible to retrieve the information 10 years later? Another concern he raised is the investment of time:

*"If we should implement new systems like BIM, I feel that we must learn how it's functioning, but it might take ten years until we get some use for it. It's a big investment of time."*

The major reason mentioned for not having time to invest in learning new technologies is the daily operations. The facility manager claims that they deal with many daily happenings and emergencies in the 8 000 apartments they have. However, the managing director for the municipal housing company suggests that it might be easier to focus on the practical things in the daily operations:

*"It's damn good when it's snowing. Everyone knows what they should do. Now it's snowing, it is wonderful, so to say. But if nothing is happening, what should I do then? How should I then anticipate things? So that I don't end up in troubles later?"*

It is furthermore discussed if the excuse that there is a "lack of time" is just a defence mechanism because of a lacking of knowledge? One participant in the group interview states that people tend to prioritize less important, but urgent tasks before tasked that are important but less urgent. All participants in the group agree that there is a lack of competencies in the organization to explore new technologies. The managing director asks rhetorically how they can take advantage of BIM in a way that helps a janitor in his/her daily work? Another problem stressed by the managing director is the need for integrating all the different parts of the company before they can gain more power in their relations to the contractors. There are four major areas that have to be integrated: market, property development, technical support and facility management. In addition, they have four different districts for facility management with four managers who have their own ideas, as well as they have four project managers for property development who also have their own ideas about the operations. Moreover, the head of property development state that a former managing director thought that it was a problem if representatives for facility management was involved in the project development. He argued that they should not be allowed to have any influence on the construction of the buildings they would later on manage.

Furthermore, the representative for the commercial company states that there is a lack of understanding of the construction process from the tenants, even if he tries to be as pedagogical as possible and explain why things takes time. He states that people understand and accept that it takes time if windows cannot be delivered in 10-12 weeks, but other things that takes time, people neither understand nor accept. In the focus group with all four key actors, the client and contractor representative agreed that they are co-producing the time pressure. The client promises the potential tenant that the facilities can be available at a certain date. At the same time the contractor, who is time optimistic, promise to build the facilities on a tight time schedule. This will in turn put pressure on architect and consultants to speed up the process, which leads to a product with low quality.

## 5.2 Contractor – BIM, a Means for Internal Efficiency

During the interviews with representatives for the large contractor, it is revealed that they have managed to mobilize a stable "core" network where BIM is used. However, four of the interviewees, who works more or less close with BIM, state that the challenge is still to convince the very large majority about the advantages. A BIM-coordinator who manages the detailed design states that:

*"...in the detailed design, the revolution has already occurred, I think. Because even if we order a 2D-project today, we will in the most cases model it [...] in that way we achieve a much better quality assurance [...] but we have not reached out to the production. That is the big challenge. It is 'damned' difficult for us to answer what's wrong."*

The BIM-coordinator further states that the higher-level management see BIM as an issue of strategic importance. They are pushing for it and investing money in it. Then there is a layer of "BIM workers" who are rather knowledgeable and know how to work with BIM. But all four of the interviewees state that the middle management lacks knowledge about how BIM can develop operations. This view is partly confirmed when a middle manager for another large contractor is interviewed. He states that BIM is used in many projects, that it fills its purposes, and that they have a special group working with these issues. But he does not have so much more to say about BIM. Moreover, in the focus group interview it is also stated that the way BIM is used varies a lot between different locations and is dependent on enthusiastic individuals.

Beyond the top management willingness to support BIM-use with investments, additional initiatives are also taken. One such initiative is that the company each year has sent a number of employees to courses where they get training in working with BIM. In addition, based on the BIM-training, manuals for how to work with BIM has been developed where requirements are described for how to work with BIM, depending on how encompassing the BIM use should be in a project. The manuals function as support for the BIM coordinators when structuring the work, but a group of BIM "super users" is also established in order to modify manuals based on feedback from the projects. When working with BIM, one key activity is to work in BIM-studios, that basically is a kind of concurrent engineering. The BIM coordinators interviewed state that some senior consultants had difficulties in accepting the new roles of being present and working a whole day together with other consultants. But it is getting more and more accepted, and now at least the junior consultants stay for the whole day.

However, interviewees working with BIM states that there are some problems internally to get people to re-think how to work. A site manager says that they should build in the model and assemble on site. This claim has been rather controversial, because opponents' question what happens to the labour skills. But the site manager states that site worker just have to do things one time, instead of two when things go wrong. A BIM coordinator further relates this idea with an improved psycho-social work environment for site managers. He states that by solving as many problems as possible in the modelling stage, this would reduce the stress for site managers in the production stage. At the same time the manager states that they internally need to fight for getting enough time for preparing the detailed design. He says that if they get a contract on Friday, people want to start to build the week after. He explains that a number of issues have to be resolved before they can start to build:

*"First, we need to procure a structural engineer, we have to go with the architect through what we want to do. We need to procure sub-contractors for field installations, we have to investigate the building together with them and see what questions they have. Maybe they were procured on a price per square meter. So, this is a very complex process, and it is not even understood internally in the contractor company, I believe. It's more like; why haven't we started yet out there? We signed the contract on Friday, today is Monday."*

In the focus group interview with the contractors, they are asked about the biggest barriers for the information flow between the partners in the process. A site manager states rather quickly that the type of contract has the biggest influence, because it is where the money is:

*"If you have a design – bid – build contract, you don't give more information than necessary, because you can get paid extra for it. If it is a design – build contract, you don't give more information than you get paid for. But if it is a partnering contract you get paid for sharing information."*

### 5.3 Consultants – BIM, Not a Big Issue

The consultants have no joint view about BIM, more than it seems that consultants prefer another software than architects, which could lead to compatibility problems in the projects. The major reason is that different software fit, more or less, better for the different consultant groups. However, the responsible for IT, hardware and software, in one of the companies states that it has been a very rapid development in the last five years and the tools in the different software becomes more and more compatible.

As well as the architects and contractors, the consultants have opinions about the clients' long-term considerations. The senior consultants say that the documentation of information about the physical building is very poor. Especially if it is taken into consideration that the value of the buildings is rather high. The consultants think it would be in the interest of facility management to have total control over the building, by using systems to manage the information. A consultant says it would be possible to get information about how many light bulbs there are in a building by just pressing a button, or which material it is in the building and how everything looks like. But in the focus group interview, the opposite situation is described. One consultant says that even big clients sometimes implicitly expects that the consultants keep the drawings of the buildings, but when they (clients) come back twenty years later, the drawings are gone, and noting is regulated by contractual agreements.

The consultants also commented on the existing action mentality in the industry. A consultant gives the following example:

*“You can get a phone call on Friday afternoon. ‘We are working with the surveying and something is wrong’. Then you talk with someone, they are so upset and they screaming. It goes a while, you ask someone to contact them [with the problem], then it is no problem, everything is clear. But you start with screaming as your life were in danger. Then I think: calm down first.”*

The consultants also stress the problems when a client tries to save money in the early stages of a project. One consultant state:

*“... it will be wrong if you in the detailed design tries to save money by decreasing the time for the detailed design, because you think you can save money. In many cases the problems are coming anyhow, and it will be more expensive to fix them. And if you come to the facility management stage it will be even more expensive[...] But we might be bad at selling the idea, or we don't have time, because we are fully occupied.”*

Another issue that is discussed in the focus group is the need for knowledge and experience, and the lack of experienced consultants in different fields. One problem identified is that younger consultants do not have the necessary knowledge and experience, for obvious reasons, but they are very skilled in using new IT-tools, whereas the experienced consultants are not very skilled in using new IT-tools. One consultant state that the dream scenario would be if they could bring together these two competencies, which would leverage the performance of the industry.

### 5.4 Architects – Pay Us for Using it More

BIM has become the normal way of working among the architects with regard to information content. An architect interviewed state that there are only three people in their office who still have a drawing table, whereas in other architect offices there are no drawing tables left. The importance of working with BIM is further emphasized by the most experienced architect interviewed, who is close to retirement. He states that he nowadays feels incompetent when he wants to proceed from the sketching stage, because younger colleagues always have to help him.

However, when it comes to a more advanced use of BIM, for example adding more information to the model, the architects state that there is a lack of willingness among the clients to pay for the extra time required to add the information. One architect state that it is a long pedagogical journey to convince the client that they can use a model containing information about the facility. Another architect state that some clients understanding about what digital information is differs significantly from the architects understanding. For example, they are doubtful when the municipality consider digitalized 2D drawings as digitalization. The architects further state that the municipality work with very old-fashioned systems, and it is hard to convince them of the advantages of BIM. But one of the biggest problems identified by the architects is that the consultant with the lowest technical standard defines how (non)advanced the use of BIM can be in a project.

A further issue is the ownership of the model. The head of an architect office states that in many contracts with contractors, they must transfer the ownership of the model to the contractor. The architect questions what the contractor should do with the ownership and their legal adviser is not happy with that solution. The architects understand that contractors want the information in the model but questions why they should waive not only the artistic right, but also the rights to the whole solution. Moreover, the architects are also very frustrated of the cases when contractors switch architect during the process, because then the architect is losing control over the end product. In the interviews with the contractor, they say ownership is not an issue, it is stated in their BIM rules that they should own the model, if they want to change to another architect for some reason.

Common for the architects interviewed is that they feel cut off in the process and they are considered as someone just producing an attractive design. They state that they can contribute with much more knowledge in the process and add more holistic perspectives. One architect says that contractors are just interested in how they can build a house as efficient as possible, whereas the architects takes the whole urban space into consideration. During the interview it is also obvious that the architects in Sweden has a different (lower) status compared to other European countries where the architect has a much more central role during the whole building process. This is, in some European countries they have much more power and control over the final product, which their Swedish colleagues does not have. During the interviews a slight sign of frustration is noticed, when some architects state that their level of education is generally higher than the other key actors', and the architects have lot of ideas how BIM could be beneficial for the client, but clients do not want to pay for the extra time it takes to add more information into a model. This is, the clients do not see the benefits.

## 6 Concluding Discussion

The aim of the paper has been to explore how the interactions among four industry key actors; architects, clients, contractors and consultants shape industry characteristics and the options for digital transformation through adoption and deployment of digital technology. The result from the study confirms earlier observations that the project-based parts of the industry is highly action oriented and if innovations should be accepted, results has to be fast and visible (see Jacobsson and Linderoth 2010). But what has been less highlighted in previous studies and becomes obvious in this study, is the action orientation in the facility management part of the industry, this is, the focus on the "practical doings" in the daily work. This has also had consequences for the adoption and use of ICT. When clients in the study are closely scrutinized, it is revealed that their facilities are more or less on-line by monitoring them with a wide range of different sensors and alarms. This kind of information transfer is well aligned with the action orientation. The (financial) consequences are quite immediate if no one reacts on an alarm. The same logic can also be claimed to be behind the rather good control of the information about the conditions of equipments in apartments. The underlying reason for this is that most real estate companies have certain policies for when equipment should be changed and when apartments should be renovated. Hence, access to reliable information eases the argumentation with tenants' whether an apartment should be renovated, or if equipment should be changed. The consequences of not having this kind of information can be compared with the consequences of lack of control in other facility related information. For example when a drawing is missing. time will be spent for searching the drawing, but there are no immediate financial consequences in terms of an invoice from a supplier. Thus, even if technologies like BIM are recognized to have a wide variety of potential applications in facility management, the technology is not widely used in practice (see Pärn et.al. 2017) because it is difficult to see the immediate financial benefits. This focus on information connected to the practical day-to-day activities implies a low perceived need for information about the physical building, and information that is more rarely used. Thus, when the facility management is involved in the early stages of a project, the focus will be more on the implications of they lay-out of a physical building, then the eventual information content in a BIM-model.

The issue is where this focus on action in the daily practice is coming from? One plausible explanation might be given by the architects, when they state that there are differences in levels of education among the key actors in the industry. It can be argued that practice-based actors have their focus on what is happening in the day-to-day operations. In this sense it is also easier to understand, adopt and use ICT where the applications are rather practice based, instead of thinking about how new ICT, like BIM could redefine the business logic in the industry. However, this condition does not explain, why the [top] management do not think strategically about digital technologies like BIM. The question can be raised if managers in facility management companies have the same mental frames as managers in contractor firms, where a practical and problem-solving orientation is a strong source of identity construction on all managerial levels (see Löfstedt and Räisänen 2014).

Another potential barrier for digital transformation is the immobility of products that more or less reduces the pressure for process innovation. This is, contractor firms can buy material on a global market, but the assembly of the products is bounded to a specific physical location. This implies that there is a potential correlation between the size of the projects and the number of contractors who potentially have an interest in the project. Thus, there is a global competition for mega projects, but until present date, this situation has not increased the pressure for process innovation by means of digital transformation in order to stay competitive. Moreover, due to very heterogeneous client side, there is no rigid standard processes to be followed. Contractors, architects, and consultants constantly returning to the clients' lack of knowledge, or competence. Both with regard to what the construction process looks like, but also with regard to the client's knowledge about what it wants. The client organizations in the study may not be typical client organizations, because they are rather big, they have a rather high volume of construction projects, and they also have project managers with a contractor background in order to have the right competence to control contractors. Nevertheless, the representatives for the client organization do complain about an internal fragmentation and a lack of understanding for what others in the organization are doing. As the managing director for municipal housing company stated, it is their biggest challenge to be better integrated internally if they should be an even more professional client and be able to take the lead over the contractors. Against this background it is hardly surprising that a technology like BIM not has reached the expected break through. The basic idea behind BIM is a seamless information flow from the very early stages of the process to the demolition, or conservation of a building, which requires a client with very clear ideas of what kind of information they want in the models and who also have the power and knowledge to put the demands on contractors and sub-contractors.

To conclude, the characteristics of the industry, this is, the focus on practical day-to-day action, a heterogeneous client side who have difficulties in putting demands on contractors and sub-contractors due to lack of competencies, and a product that raise barriers for process innovations, do effectively constrain digital transformation. This is, the combined effects of digital innovations bringing about novel actors and actor constellations, structures, practices, values and beliefs that change, threaten, replace or complement existing rules of the game with in organizations, ecosystems, industries or fields (Hinings et al. 2018: 53).

## 7 References

- Agarwal, R., Chandrasekaran, S., and Sridhar, M. 2016. "Imagining construction's digital future", <https://www.mckinsey.com/industries/capital-projects-and-infrastructure/our-insights/imagining-constructions-digital-future>. Retrieved Oct 18.th 2018.
- Bryman, A., and Bell, E. 2015. *Business research methods*. USA: Oxford University Press.
- Carlo, J. L., Lyytinen, K. and Boland Jr., R.J. 2012. "Dialectics of collective minding: Contradictory appropriations of information technology in a high-risk project," *MIS Quarterly*, (36:4), pp 1081–1108.
- Chatterjee, D., Richardson, V. J. and Zmud, R. W. 2001. "Examining the shareholder wealth effects of announcements of newly created CIO positions," *MIS Quarterly*, (25:1), pp 43–70.
- Chiasson, M., and Davidson, E. 2005. "Taking industry seriously in IS research," *MIS Quarterly*, (29:1), 2–16.
- Cho, S. and Mathiasen, L. 2007. "The role of industry infrastructure in telehealth innovations: a multi-level analysis of a telestroke program," *European Journal of Information Systems*, (16:6), pp 738–750.
- Dahlin-Ivanoff, S., and Holmgren, K. 2017. Fokusgrupper. Lund: Studentlitteratur.
- DiMaggio, P. J. and Powell, W. W. 1983. "The iron cage revisited: Institutional isomorphism and collective rationality in organizational fields," *American sociological review*, (48:2), pp 147–160.
- Dubois, A. and Gadde, L. E. 2002. "The construction industry as loosely coupled system: implication for productivity and innovation," *Construction Management and Economics*, (20:7), pp 621–631.
- Earl, P. 1996. "Contracts, coordination, and the construction industry", in Management, marketing and the competitive process, in P. Earl, Cheltenham: Edward Elgar.

- Eastman, C. M., Teicholz, P., Sacks, R. and Liston, K. 2011. *BIM handbook: A guide to building information modelling for owners, managers, designers, engineers and contractors*. John, Hoboken, NJ: Wiley & Sons.
- Gann, D. M. 1996. "Construction as a manufacturing process? Similarities and differences between industrialized housing and car production in Japan", *Construction Management and Economics*, (14:5), pp 437–445.
- Hannan, M. T. and Freeman, J. 1977. "The population ecology of organizations," *American Journal of Sociology*, (82:5), pp 929–964.
- Harty, C. 2005. "Innovation in construction: a sociology of technology approach", *Building research & Information*, (33:6), pp 512–522.
- Hinings, B, Gegenhuber, T., and Greenwood, R. 2018. "Digital innovation and transformation: An institutional perspective," *Information and Organization*, (28:1), pp 52–61.
- Jacobsson, M. and Linderoth, C. J. H. 2010. "The Influence of Contextual Elements, Actors' Frames of Reference and Technology on the Adoption and Use of ICT in Construction Projects: a Swedish Case Study", *Construction Management and Economics*, (28:1), pp 13–23.
- Jacobsson, M., Linderoth, H. C., and Rowlinson, S. 2017. "The role of industry: an analytical framework to understand ICT transformation within the AEC industry," *Construction Management and Economics*, (35:10), pp 611–626.
- Joshi, A., Bollen, L., Hassink, H., De Haes, S., and Van Grembergen, W. 2018. "Explaining IT governance disclosure through the constructs of IT governance maturity and IT strategic role," *Information and Management*, (55:3), pp 368–380.
- Krueger, R. A., and Casey, M. A. 2014. *Focus groups: A practical guide for applied research*. USA: Sage publications.
- Love, P., Gunasekaran, A. and Li, H. 1998. "Concurrent engineering: a strategy for procuring construction projects," *International Journal of Project Management*, (16:6), pp 375–383.
- Löwstedt, M. and Räisänen, C. 2014. "Social identity in construction: Enactments and outcomes". *Construction Management and Economics*, (32:11), pp 1093–1105.
- Markus, M. L., and Robey, D. 1988. "Information technology and organizational change: causal structure in theory and research," *Management science*, (34:5), pp 583–598.
- Melville, N. and Ramirez, R. 2008. "Information technology innovation diffusion: an information requirements paradigm," *Information Systems Journal*, (18:3), pp 247–273.
- Muhanna, W. A. and Stoel, M. D. 2010. "How Do Investors Value IT? An Empirical Investigation of the Value Relevance of IT Capability and IT Spending Across Industries", *Journal of Information Systems*, (24:1), pp 43–66.
- Nambisan, S., Lyytinen, K., Majchrzak, A., and Song, M. 2017. "Digital innovation management: Reinventing innovation management research in a digital world," *MIS Quarterly*, 41, 223–236.
- Orlikowski, W. J. and Gash, D. C. 1994. "Technological frames: Making sense of information technology in organizations", *ACM Transactions on information systems*, (12:2), pp. 174–207.
- Pärn, E. A., Edwards, D. J., and Sing, M. C. P. 2017. "The building information modelling trajectory in facilities management: A review," *Automation in Construction*, (75), 45–55.
- Porac, J. F., Thomas, H., Baden-Fuller, C. 1989. "Competitive Groups as Cognitive Communities: The case of Scottish knitwear manufacturers," *Journal of Management Studies*, (26:4), 397–416.
- Porter, M. 1980. *Competitive strategy*, New York: The Free Press.
- Scott, W. R., Ruef, M., Mendel, P. and Caronna, C. 2000. *Institutional change and healthcare organizations: From professional dominance to managed care*, Chicago: Chicago University Press.
- Van de Ven, A. H. 2005. "Running in packs to develop knowledge-intensive technologies," *MIS Quarterly*, (29:2), pp 365–377.
- Yeh, Q. J., and Chang, A. J. T. 2007. "Threats and countermeasures for information system security: A cross-industry study," *Information & Management*, (44:5), pp 480–491.



## Acknowledgements

The authors want to thank Jönköpings läns byggmästareförening and Smart Built Environment who financed the study.

## Copyright

The following copyright paragraph must be appended to the paper. Author names **MUST** not be included until after reviewing. Please ensure the hyperlink remains for electronic harvesting of copyright restrictions.

**Copyright:** © Henrik Linderoth, Mattias Jacobsson, and Amany Elbanna. This is an open-access article distributed under the terms of the [Creative Commons Attribution-NonCommercial 3.0 Australia License](https://creativecommons.org/licenses/by-nc/3.0/australia/), which permits non-commercial use, distribution, and reproduction in any medium, provided the original author and ACIS are credited.

# Key Determinants of Enterprise E-banking Assimilation

## Ziqi Liao

School of Business  
Hong Kong Baptist University  
Kowloon, Hong Kong  
Email: victor@hkbu.edu.hk

## Xinping Shi

School of Business  
Hong Kong Baptist University  
Kowloon, Hong Kong  
Email: xpshi@hkbu.edu.hk

## Man Hei Yee

School of Business  
Hong Kong Baptist University  
Kowloon, Hong Kong  
Email: mhryee@gmail.com

## Abstract

This paper empirically examines key determinants of enterprise e-banking assimilation. The analytical results unveil that utilitarian value and usability positively affect trustworthiness and satisfaction of enterprise e-banking services. In particular, firms' satisfaction possesses a significant mediating effect on continuance intention to use enterprise e-banking services in business operations. The present study makes contributes to research and practice. The empirical findings enrich the understanding of enterprise e-banking assimilation and have managerial implications for the development of enterprise e-banking systems and services.

**Keywords** Enterprise e-banking, systems, services, assimilation, firms

## 1 Introduction

The commercial banks have been developing online banking services and utilizing electronic channels to deliver banking and financial information, enhance customer services, and reduce transaction costs. In general, the banks provide enterprises and consumers with online banking services respectively, because of different service requirements. As an important form of business-to-business services, enterprise e-banking refers to the online banking services that the commercial banks offer to firms in different industries, which include import and export document application, employee payroll, bill payment, fund transfer, and commercial loan services. As a matter of fact, enterprise e-banking services play an important role in facilitating firms to deal with banking tasks and transactions in relation to business operations. This paper aims at deepening the understanding of enterprise e-banking assimilation. Therefore, a conceptual model and several hypotheses are proposed to articulate the relationships between key determinants and enterprise e-banking continuance intention along the lines of the technology acceptance model (Davis et al., 1989) and e-service quality (Parasuraman et al., 2005), the theory of reasoned action (Fishbein & Ajzen, 1975; Ajzen & Fishbein, 1980), and the theory of planned behaviour (Ajzen, 1985, 1991). In addition, we carry out a survey to gather data from firms and test our conceptual model and hypotheses. The empirically-grounded findings to be presented in the following sections not only validate the causal effects and relationships of the constructs in the conceptual model, but also have implications for enhancing enterprise e-banking services. This paper includes the construction of a conceptual model in the next section. Thereafter, it explains the research methods and presents the empirical results. It then discusses the findings together with the theoretical and practical implications. Lastly, the paper is concluded by summarizing the findings and providing suggestions for future research.

## 2 Conceptual Model and Hypotheses

The present study empirically examines enterprise e-banking assimilation by extending the theoretical underpinnings of technology acceptance model (Davis et al., 1989) and e-service quality (Parasuraman et al., 2005). The theory of reasoned action (Fishbein and Ajzen, 1975; Ajzen and Fishbein, 1980) and

the theory of planned behaviour (Ajzen, 1985, 1991) are also applied to explain firm users' continuance intention to use enterprise e-banking systems and services. The theory of bounded rationality suggests that it is imperative to concentrate on a core subset of variables in evaluation of technology-based systems and services (Simon, 1972). Thus, we design a conceptual model, in which trustworthiness, utilitarian value, and usability are assumed to be antecedents that respectively affect firms' satisfaction with enterprise e-banking, while utilitarian value and usability may influence trustworthiness. At the same time, firms' satisfaction is assumed to mediate the relationships between the three antecedents and continuance intention to use enterprise e-banking. In particular, trustworthiness refers to the extent to which firm users perceive that the commercial banks have ability, integrity, and benevolence in provision of enterprise e-banking services (Mayer et al., 1995; Colquitt et al., 2007; Porter and Donthu, 2008), while utilitarian value and usability are respectively derived from perceived usefulness and perceived ease of use in the technology acceptance model. In line with the reasoning of Oliver (1997, 1999) and Parasuraman et al. (2005), firms' satisfaction refers to the extent to which firm users are satisfied with enterprise e-banking services, while continuance intention refers to firm users' willingness to repeatedly use enterprise e-banking services. The conceptual model aims at articulating the extent to which firms' satisfaction has a mediating effect on relationships between the antecedents and firms' continuance intention to use enterprise e-banking services.

## 2.1 Trustworthiness

It is meaningful to examine the trustworthiness of enterprise e-banking as it indicates the extent to which firm users perceive that the commercial banks can provide trustworthy enterprise e-banking services. In line with the theoretical underpinnings of trustworthiness (Mayer et al., 1995; Colquitt et al., 2007), this study articulates trustworthiness with regard to ability, integrity, and benevolence in enterprise e-banking service processes. It is imperative for the commercial banks to responsibly offer high quality e-banking services and fulfil meet clients' needs in order to make firm users be satisfied with the relevant services (Parasuraman et al., 2005). In addition to the development of e-banking systems, the commercial banks are expected to possess the expertise in the operations of enterprise e-banking services. In particular, the banks should be capable of providing enterprise e-banking services and tackling online transactions problems. The banks should also be fair to their firm clients when they perform transactions through enterprise e-banking systems. Moreover, the banks should quickly respond to service requests from firm clients and benevolently care about their interests and concerns throughout the service processes. The service providers with established trust usually do not behave opportunistically or take advantages of their customers in the service processes (Porter and Donthu, 2008). However, it is not uncommon that some users may feel that online services may involve risks, because they do not have direct face-to-face communication with service staff (Yousafzai et al., 2005). The banks need to consistently maintain and deliver trustworthy online banking and financial services to enhance firm users' satisfaction with enterprise e-banking. Therefore, we propose Hypothesis 1.

H1. Trustworthiness positively affects firms' satisfaction with enterprise e-banking services.

## 2.2 Utilitarian Value

In this study, utilitarian value is defined as the extent to which firm users perceive that enterprise e-banking can effectively and efficiently process payments and other banking activities in association with business transactions, which is conceptually consistent with perceived usefulness (Davis et al., 1989; Liao and Cheung, 2002, 2008; Liao and Wong, 2008; Luo et al., 2010; Changchit et al., 2017). The enterprise e-banking systems should enable firm users to perform banking activities and minimize costs and workload of relevant processes through the Internet. As using the enterprise e-banking is task-oriented, firm users should be rational in decision making when they utilize enterprise e-banking services. As a matter of fact, the functionalities of e-banking services for firms are relatively more complex than those for individual consumers. The enterprise e-banking systems should serve as an important platform, through which the commercial banks can effectively provide business clients with professional and trustworthy banking services. Apart from reliably managing accounts and processing transactions data, the enterprise e-banking systems must efficiently accomplish enterprise banking activities, streamline cash flows, and improve operational efficiency of business transactions. It is therefore imperative for enterprise e-banking services to possess utilitarian value which may enhance trustworthiness and business clients' satisfaction with the relevant online banking services (Porter and Donthu, 2008). Generalizing from these observations, we propose the following hypotheses.

H2a. Utilitarian value positively affects trustworthiness of enterprise e-banking services.

H2b. Utilitarian value positively affects firms' satisfaction with enterprise e-banking services.

## 2.3 Usability

In the present work, usability refers to the extent to which enterprise e-banking can be easily used to handle banking tasks in association with business operations, which is related to user experience in terms of ease of use (Davis et al., 1989; Liao and Cheung, 2002, 2008; Changchit et al., 2017). With regard to e-banking, the websites of a commercial bank serve as a platform for providing consumers and enterprises with online banking services, on which there are different logins that respectively enable consumers and companies to access e-banking services. Previous studies suggest that perceived ease of use or usability has an effect on consumers' behavioural intention to use e-banking (Kazi, 2013) and attitudes towards mobile banking (Changchit et al., 2017). In the case of enterprise e-banking, it is important to examine the effect of usability, as firm users may need to work on relatively complicated transactions such as import and export businesses, which are different from the banking activities of individual consumers. However, in practice, some users may not appreciate the functionalities of the enterprise e-banking systems. Thus, it is desirable that enterprise e-banking systems can facilitate firm users to easily use the relevant functions to perform banking tasks and process business transactions. The commercial banks should design and build user-friendly enterprise e-banking systems in order to enhance the trustworthiness of e-banking and enable users to gain satisfactory experience from online banking services (Porter and Donthu, 2008). Therefore, we propose the following hypotheses.

H3a. Usability positively affects trustworthiness of enterprise e-banking services.

H3b. Usability positively affects firms' satisfaction with enterprise e-banking services.

## 2.4 Mediating Effect of Satisfaction

The present conceptual model aims at articulating the extent to which firms' satisfaction mediates the effects of such antecedents as utilitarian value, usability and trustworthiness on continuance intention to use enterprise e-banking services. In line with Oliver (1997, 1999), satisfaction is a summary of psychological state resulting from prior feelings and experiences, which has a positive effect on continuance intention (Li and Liu, 2014). Firms are enterprise customers of the commercial banks. The firm users should possess rational attitudes towards the implementation and use of enterprise e-banking in dealing with the relevant banking jobs for their companies. Thus, in the present work, the psychological sense of customer satisfaction is adapted to define the construct of firms' satisfaction as the extent to which firms are satisfied with present enterprise e-banking services that are provided by the commercial banks. It is expected that firms' satisfaction can positively convey the effects of such antecedents as trustworthiness, utilitarian value, and usability on continuance intention to use enterprise e-banking. Actually, firm users of enterprise e-banking are task-oriented in the processes of managing cash flows and handling financial matters in relation to business operations for their companies. Therefore, the theoretical underpinnings of reasoned action and planned behaviour (Ajzen and Fishbein, 1980; Ajzen, 1985, 1991) can be appropriately applied to explain firm users' behaviour in association with the assimilation of enterprise e-banking. The effect of satisfaction on continuance intention has been explored in different online services (Wang and Du, 2014; Joo et al., 2017). With regard to enterprise e-banking services, it is meaningful to find out whether firm users feel that their expectations are fulfilled through testing the mediating effect of satisfaction. Generalizing from the above observations, we propose Hypothesis 4.

H4. Satisfaction mediates the effects of trustworthiness, utilitarian value, and usability on continuance intention to use enterprise e-banking services.

## 3 Method

We designed a preliminary questionnaire consisting of multiple question items to operationalize each of the constructs in the conceptual model. The question items or observable variables in relation to each construct were in line with the measurements in the existing literature. A seven-point Likert scale ranging from 1 'strongly disagree' to 7 'strongly agree' was used to obtain respondents' assessments of the relevant question items. In addition, the questionnaire included some items to obtain demographic data. As most managers in local small firms are Chinese speakers, they might feel more comfortable in responding to survey questions in Chinese. We translated the English version questionnaire to Chinese version. A backward translation of Chinese questions to English was also performed to ensure that the meanings of the relevant questions were consistent. Therefore, we formulated a bilingual version of the questionnaire. Meanwhile, we conducted a pilot study by requesting eight managers from different firms to review the preliminary version of the questionnaire. These managers offered constructive suggestions for improving the question items, since they were knowledgeable in business operations and had experiences in enterprise e-banking services. In line with the feedback obtained from the pilot

study, we refined and finalized the questionnaire for survey. Thereafter, we carried out a survey to gather empirical data from firms in different industries such as trading, manufacturing, and financial services. In the survey process, the questionnaire together with a cover letter and returned envelope was delivered to over one thousand enterprises. The survey resulted in the collection of one hundred and forty three questionnaires returned from responding firms that had less than fifty employees. The respondents included firm owners, partners, and managers having experiences in enterprise e-banking services. They responded to our survey and completed the questionnaire on behalf of their firms.

## 4 Results

We systematically test the survey data gathered from the responding firms using the AMOS software. In line with the analytical procedures suggested by Anderson and Gerbing (1988), Byrne (2010), and Hair et al. (2010), we examine the measurement model and conduct hypothesis testing.

### 4.1 Measurement Model

We test the internal consistency reliability of the measurement model. The test results show that the Cronbach's alpha ( $\alpha$ ) values are 0.87, 0.75, 0.86, 0.94, and 0.90 and the composite reliability (CR) values are 0.90, 0.83, 0.90, 0.96, and 0.94, respectively, which suggest that the measurement items are retained and the internal consistency reliability of the measurement model is justified (Hair et al., 2010). In addition, we test the construct validity in terms of convergent validity and discriminant validity. First, convergent validity indicates the extent to which the indicators or observable variables of a construct converge or share a considerable proportion of variance (Bagozzi et al., 1991; Hair et al., 2010). The measurement items of the constructs have loadings that are greater than the threshold (Hair et al., 2010), which suggest that the relevant observable variables are loaded onto a respective manifested construct. The average variance extracted (AVE) values of the five constructs are 0.65, 0.57, 0.65, 0.84, and 0.84, respectively. These AVE values are greater than the threshold suggested by Hair et al. (2010). The test results indicate that the convergent validity of the constructs in the conceptual model is justified. Second, discriminant validity indicates the extent to which a construct is distinct from the other constructs (Hair et al., 2010), which provides evidence that a unique construct can capture the propensity of the represented concept. It is assessed by comparing the square root of the AVE of a construct with the correlation coefficients between the tested construct and the other constructs. The values of the square root of AVE are greater than the correlation coefficients of the corresponding pairs of relevant constructs. Therefore, the discriminant validity of each of the constructs in the conceptual model is justified. Moreover, the test of multicollinearity results in variance inflation factors (VIF) ranging from 1.5 to 2.0, which are less than the suggested threshold of 10.0 (Hair et al., 2010). The test results show that there is no multicollinearity. Thus, the constructs are independent facets that represent different aspects of enterprise e-banking assimilation. Lastly, the confirmatory factor analysis (CFA) results in a series of indices such as  $\chi^2 = 343.674$ ,  $df = 177$ ,  $\chi^2/df = 1.942$ ,  $NFI = 0.863$ ,  $IFI = 0.928$ ,  $TLI = 0.914$ ,  $CFI = 0.927$ , and  $RMSEA = 0.079$ , which indicate that the measurement model significantly fits.

### 4.2 Model Analysis and Hypothesis Testing

We use the structural equation modelling to estimate path coefficients of the conceptual model ( $M_0$ ) and to test the hypotheses. As shown in Table 1, the test results indicate the goodness of fit of  $M_0$  ( $\chi^2 = 352.895$ ,  $df = 196$ ,  $\chi^2/df = 1.961$ ,  $NFI = 0.859$ ,  $IFI = 0.926$ ,  $TLI = 0.912$ ,  $CFI = 0.925$ ,  $RMSEA = 0.079$ ). In particular, we apply the mediating model analysis procedure and competing model approach to examine alternate models in search of the best parsimonious model (Baron and Kenny, 1986; Anderson and Gerbing, 1988; Hair et al., 2010) and test whether there is another model with better goodness of fit index and explanatory power. Thus, we suggest three alternate models ( $M_1$ ,  $M_2$ , and  $M_3$ ) on the basis of the conceptual model ( $M_0$ ) by adding a path from each of the two exogenous constructs such as utilitarian value and usability to the endogenous construct of continuance intention. In comparison with  $M_0$ ,  $M_1$  has an additional path from utilitarian value to continuance intention, while  $M_2$  has an additional path from usability to continuance intention. In addition,  $M_3$  is constructed by connecting both utilitarian value and usability to continuance intention. The three alternate models are tested by comparing  $\chi^2$  differences, goodness-of-fit indices, and p-values. Table 1 shows that the coefficients and t-values of the additional paths are insignificant in the three alternate models ( $M_1$ ,  $M_2$ , and  $M_3$ ), which indicate that either utilitarian value or usability has little direct effect on continuance intention. Therefore,  $M_0$  is an appropriate model to unveil the mediating effect of firms' satisfaction.

Path	M <sub>0</sub>		M <sub>1</sub>		M <sub>2</sub>		M <sub>3</sub>	
	Coefficients	t-value	Coefficients	t-value	Coefficients	t-value	Coefficients	t-value
UV ⇒ TR	0.276 *	2.463	0.254 *	2.278	0.277 *	2.467	0.255 *	2.290
UV ⇒ SAT	0.425 **	4.148	0.406 **	4.004	0.426 **	4.132	0.407 **	4.003
US ⇒ TR	0.565 **	4.928	0.580 **	5.036	0.563 **	4.911	0.579 **	5.029
US ⇒ SAT	0.323 **	3.129	0.318 **	3.034	0.318 **	3.367	0.316 **	3.010
TR ⇒ SAT	0.228 *	2.211	0.250 *	2.429	0.231 *	2.238	0.251 *	2.437
SAT ⇒ CI	0.778 **	10.884	0.664 **	5.221	0.748 **	6.264	0.648 **	4.282
M <sub>1</sub> : UV ⇒ CI			0.139	0.288				
M <sub>2</sub> : US ⇒ CI					0.036	0.756		
M <sub>3</sub> : UV ⇒ CI							0.135	1.029
M <sub>3</sub> : US ⇒ CI							0.022	0.193
χ <sup>2</sup>	352.895		351.159		352.802		351.859	
df	180		179		179		178	
χ <sup>2</sup> /df	1.961		1.966		1.971		1.977	
Δχ <sup>2</sup>			1.700		0.091		1.036	
NFI	0.859		0.859		0.859		0.859	
IFI	0.926		0.926		0.925		0.925	
TLI	0.912		0.912		0.911		0.911	
CFI	0.925		0.925		0.924		0.924	
RMSEA	0.079		0.080		0.080		0.080	

Notes: UV = Utilitarian Value; US = Usability; TR = Trustworthiness; SAT = Satisfaction; CI = Continuance intention; NFI = normed fit index; IFI = incremental fit index; TLI = Tucker-Lewis coefficient; CFI = comparative fit index; RMSEA = root mean squared error of approximation; Δχ<sup>2</sup> = (χ<sub>0</sub><sup>2</sup> - χ<sub>i</sub><sup>2</sup>; i = 1, 2, 3); \* p < 0.01; \*\* p < 0.001

Table 1. Analytical results of structural equation modelling

## 5 Discussion

The present empirical analysis results in meaningful findings and implications. First, the support of H1 suggests that trustworthiness significantly and positively influences firms' satisfaction with enterprise e-banking services. In addition, the empirical justifications of H2a, H2b, H3a, and H3b suggest that utilitarian value and usability have significant and positive effects on the trustworthiness of enterprise e-banking and firms' satisfaction with enterprise e-banking services. Moreover, the empirical support of H4 indicates that firms' satisfaction significantly mediates the effects of trustworthiness, utilitarian value, and usability on continuance intention to use enterprise e-banking services. The results suggest that trustworthiness, utilitarian value, and usability are key attributes of enterprise e-banking services. The firms tend to continually use online banking systems and services that can effectively help them manage financial matters, streamline cash flows, and reduce transactions costs in business operations.

This study makes contributions to research. The present empirical findings deepen the understanding of enterprise e-banking assimilation and enrich the knowledge of online business-to-business services. Given that small firms represent an important customer segment of the commercial banks, enterprise e-banking serves as a key distribution channel of banking services to these companies. Therefore, it is worthwhile to explore the mechanism that underlines the firms' adoption of enterprise e-banking. This study focuses on such a promising topic and extends the theoretical underpinnings of technology acceptance and e-service quality to elucidate such a technology-based service setting. It strives for advancing the present knowledge by operationalizing the relevant constructs in relation to enterprise e-banking. The present findings justify that the underpinnings of technology adoption and electronic service quality can be blended to examine the assimilation of enterprise e-banking services in the context of small firms. It has also been found that the theory of reasoned action and the theory of planned behaviour can be appropriately applied to explain firm users' behaviour in association with the use of enterprise e-banking services, because they use the relevant services in a planned and rational manner to accomplish business operations. The present empirical results rationalize that as key determinants of enterprise e-banking assimilation, utilitarian value, usability, and trustworthiness positively influence firms' satisfaction which in turn significantly mediates the relationships between these determinants and continuance intention to use enterprise e-banking. In summary, utilitarian value, usability, and trustworthiness of enterprise e-banking collectively explain firms' satisfaction with enterprise e-banking services. In particular, firms' satisfaction serves as an important mediator that conveys the effects and explanatory powers of the three key determinants on enterprise e-banking continuance intention. Therefore, the present empirical work lays a foundation for future research in relation to enterprise e-banking and other service innovations in different contexts.

In addition, the present study makes contributions to practice. The empirical findings have managerial implications for the development of enterprise e-banking services. The banks should further develop the enterprise e-banking systems that have more useful and user-friendly functionalities to effectively support firms' business operations. The banks should also devote to enhance the trustworthiness of enterprise e-banking services with regard to ability, integrity, and benevolence, since trustworthiness considerably affects firms' satisfaction. Moreover, the banks should efficiently respond to service requests from firm clients and quickly handle service interruptions and hidden transaction fees, as these matters may affect e-banking service quality and make firms cease using enterprise e-banking services. Lastly, it is imperative to establish and develop sustainable business relationships between the commercial banks and their firm clients. In practice, the firms are suggested to streamline banking tasks in association with business operations and pay attention to user training in order to efficiently use enterprise e-banking. The commercial banks are also suggested to collaboratively work with firm clients in the processes of online banking services. For instance, the banks may offer firm users some training in relation to the operations and information security of enterprise e-banking. Therefore, firm users have a better understanding of enterprise e-banking systems and innovative financial services.

## 6 Conclusion

The present study empirically justifies the relationships of antecedents and consequences of enterprise e-banking assimilation in small firms. The analytical results unveil that trustworthiness, utilitarian value, and usability positively and significantly influence firms' satisfaction and continuance intention, while satisfaction mediates the relationships between these determinants and continuance intention to use enterprise e-banking services. It has been found that the relevant theoretical underpinnings can be blended to build a conceptual model for examining enterprise e-banking assimilation. In addition, the theory of reasoned action and the theory of planned behaviour can be usefully applied to explain firm users' behaviour in association with the use of enterprise e-banking services, as they possess rational attitudes towards the technology-based service innovations. The present work makes contributions to research and practice. The empirically-grounded findings deepen the understanding of enterprise e-banking assimilation and provide managerial insights for improving enterprise e-banking services and implementing advanced information and communications technologies in service operations. Lastly, future research may explore relevant attributes in a particular context to identify the extent to which the improvement of different aspects can encourage firms to use enterprise e-banking services.

## 7 References

- Ajzen, I. 1985. "From Intentions to Actions: A Theory of Planned Behavior," in J. Kuhl and J. Beckmann, eds. *Action-Control: From Cognition to Behavior*. Heidelberg: Springer.
- Ajzen, I. 1991. "The Theory of Planned Behavior: Some Unresolved Issues," *Organizational Behavior and Human Decision Process* (50:2), pp. 179-211.
- Ajzen, I., and Fishbein, M. 1980. *Understanding Attitudes and Predicting Social Behavior*. Englewood Cliffs, NJ: Prentice-Hall.
- Anderson, J.C., and Gerbing, D.W. 1988. "Structural Equation Modeling in Practice: A Review and Recommended Two-step Approach," *Psychological Bulletin* (103:3), pp. 411-423.
- Bagozzi, R.P., Yi, Y., and Phillips, L.W. 1991. "Assessing Construct Validity in Organizational Research," *Administrative Science Quarterly* (36:1), pp. 421-458.
- Baron, R.M., and Kenny, D.A. 1986. "The Moderator-mediator Variable Distinction in Social Psychological Research: Conceptual, Strategic, and Statistical Considerations," *Journal of Personality and Social Psychology* (51), pp. 1173-1182.
- Byrne, B.M. 2010. *Structural Equation Modeling with AMOS: Basic Concepts, Applications, and Programming*. Second edition, New York: Routledge, Taylor and Francis Group.
- Changechit, C., Lonkani, R., and Sampet, J. 2017. "Mobile Banking: Exploring Determinants of Its Adoption," *Journal of Organizational Computing and Electronic Commerce* (27:3), pp. 239-261.
- Colquitt, J.A., Scott, B.A., and LePine, J.A. 2007. "Trust, Trustworthiness, and Trust Propensity: A Meta-analysis Test of Their Unique Relationships with Risk Taking and Job Performance," *Journal of Applied Psychology* (92), pp. 909-927.

- Davis, F.D., Bagozzi, R.P., and Warshaw, P.R. 1989. "User Acceptance of Computer Technology: A Comparison of Two Theoretical Models," *Management Science* (35:8), pp. 982-1003.
- Fishbein, M., and Ajzen, I. 1975. *Belief, Attitude, Intention and Behavior: An Introduction to Theory and Research*. Reading, MA: Addison-Wesley.
- Hair, J. F., Black, W.C., Babin, B.J., and Anderson, R.E. 2010. *Multivariate Data Analysis: A Global Perspective*. Seventh edition, New Jersey: Pearson Prentice Hall.
- Joo, Y.J., Park, S., and Shin E.K. 2017. "Students' Expectation, Satisfaction, and Continuance Intention to Use Digital Textbooks," *Computers in Human Behavior* (69), pp. 83-90.
- Kazi, A.K. 2013. "An Empirical Study of Factors Influencing Adoption of Internet Banking among Students of Higher Education: Evidence from Pakistan," *International Journal of Finance and Banking Studies* (2:2), pp. 87-99.
- Liao, Z., and Cheung, M.T. 2002. "Internet-based E-banking and Consumer Attitudes: An Empirical Study," *Information & Management* (39:4), pp. 283-295.
- Liao, Z., and Cheung, M.T. 2008. "Measuring Consumer Satisfaction in Internet Banking: A Core Framework," *Communications of the ACM* (51:4), pp. 47-51.
- Liao, Z., and Wong, W.K. 2008. "The Determinants of Customer Interactions with Internet-enabled E-banking Services," *Journal of the Operational Research Society* (59:9), pp. 1201-1210.
- Luo, X., Gurung, A., and Shim, J.P. 2010. "Understanding the Determinants of User Acceptance of Enterprise Instant Messaging: An Empirical Study," *Journal of Organizational Computing and Electronic Commerce* (20:2), pp. 155-181.
- Mayer, R.C., Davis, J.H., and Schoorman, F.D. 1995. "An Integrative Model of Organizational Trust," *Academy of Management Review* (20:3), pp. 709-734.
- Oliver, R.L. 1997. *Satisfaction: A Behavioural Perspective on the Consumer*. New York: McGraw-Hill.
- Oliver, R.L. 1999. "Whence Customer Loyalty?" *Journal of Marketing* (63:4), pp. 33-44.
- Parasuraman, A., Zeithaml, V.A., and Malhotra, A. 2005. "E-S-QUAL: A Multiple-item Scale for Assessing Electronic Service Quality," *Journal of Service Research* (7:3), pp. 213-233.
- Porter, C.E., and Donthu, N. 2008. "Cultivating Trust and Harvesting Value in Virtual Communities," *Management Science* (54), pp. 113-128.
- Simon, H. 1972. "Theories of Bounded Rationality," in C. McGuire and R. Radner, eds. *Decision and Organization*, Amsterdam: North Holland Publishing Company.
- Wang, R.B., and Du, C.T. 2014. "Mobile Social Network Sites as Innovative Pedagogical Tools: Factors and Mechanism Affecting Students' Continuance Intention on Use," *Journal of Computers in Education* (1:4), pp. 353-370.
- Yousafzai, S.Y., Pallister, J.G., and Foxall, G.R. 2005. "Strategies for Building and Communicating Trust in Electronic Banking: A Field Experiment," *Psychology and Marketing* (22:2), pp. 181-201.

## Copyright

**Copyright:** © 2018 authors. This is an open-access article distributed under the terms of the [Creative Commons Attribution-NonCommercial 3.0 Australia License](https://creativecommons.org/licenses/by-nc/3.0/au/), which permits non-commercial use, distribution, and reproduction in any medium, provided the original authors and ACIS are credited.



# A review of information privacy laws and standards for secure digital ecosystems

## **Memoona J. Anwar**

Faculty of Engineering and Information Technology  
University of Technology Sydney  
Ultimo, NSW 2007, Sydney, Australia  
Email: memoona.j.anwar@student.uts.edu.au

## **Asif Q. Gill**

Faculty of Engineering and Information Technology  
University of Technology Sydney  
Ultimo, NSW 2007, Sydney, Australia  
Email: asif.gill@uts.edu.au

## **Ghassan Beydoun**

Faculty of Engineering and Information Technology  
University of Technology Sydney  
Ultimo, NSW 2007, Sydney, Australia  
Email: ghassan.beydoun@uts.edu.au

## **Abstract**

Information privacy is mainly concerned with the protection of personally identifiable information. Information privacy is an arduous task, in particular, in the context of complex adaptive and multi-party heterogeneous digital ecosystems. There is a need to identify and understand the relevant privacy laws and standards for designing the secure digital ecosystems. This paper presents the results of our information privacy research in digital ecosystems through the lens of local and international privacy regulations and standards. A qualitative research method was applied to review a set of identified privacy laws across the four layers of digital ecosystem. The evaluation criteria has been applied to evaluate the applicability and coverage of the selected seven information privacy laws to people, process, information and technology layers of the digital ecosystems. The research results indicate that information privacy is a critical phenomenon; however, it is not adequately addressed in the context of end-to-end digital ecosystems. It is recommended that a multi-layered privacy by design approach is required by reviewing and mapping information privacy laws and standards to design the secure digital ecosystems.

**Keywords:** Information Privacy, Information Security, Privacy, Regulations, Digital Ecosystems, Cyber Security

## 1 Introduction

There are growing concerns about the privacy of information or data collected by the governments, private organizations and employers. Privacy includes concerns of collection, data transmission, data storage, access and rights, usage and disclosure of personal information (Moghe 2003). Technology, such as cloud (Gill et al. 2014), has allowed government and commercial entities to collect, use and disclose huge sets of personal identification information (PII) irrespective of the consent of information owners. The information is collected from multiple platforms. When managing multiple platforms, it is important to understand how they will interact to achieve the business goal. This is where digital ecosystems come into picture. A digital ecosystem (DE) is a comprehensive picture of how all digital and social components of an organisation interconnect and interact (Schmidt 2014). Hence, a digital ecosystem is a coordinated network of interacting platform such as business organisations, digital devices and consumers that create value. Common examples of digital ecosystem (DE) are healthcare ecosystem, financial services ecosystem etc. When the information is collected from multiple sources, the owner may not know its usage. Many business entities use this information for commercial gains e.g. email spam, marketing campaigns and cross selling of information or products. There has to be a well-defined check and balance mechanism, which can monitor and control the unwanted use of personal information. For that matter, we need some regulations through which this use or misuse of information can be controlled. The *Australian Constitution* defines a federal system of government according to which, powers are divided among the Commonwealth (national government), six states (New South Wales, Victoria, Tasmania, Queensland, South Australia and Western Australia) as well as two territories (the Australian Capital Territory and the Northern Territory). Under this system, specific Constitutional powers are conferred on the Commonwealth. Any other powers not specifically conferred on the Commonwealth are retained by the States (and, to a lesser extent, the territories). However, complying with Australian privacy laws is still challenging for private sector organizations.

Many laws have been formulated and amended over a period of time in order to ensure privacy of individuals. The **Privacy Act 1988** regulates information privacy in the Commonwealth public sector and the national private sector in Australia. It covers PII and other sensitive information (such as health information, ethnicity, sexual preference, trade union membership). The Privacy Act (1988) is based on thirteen **Australian Privacy Principles (APPs)**, which are applicable to most of the Australian and Norfolk Island government agencies as well as to some private sector organisations. The **Protective Security Policy Framework (PSPF)** provides assistance to Australian Government entities in protecting their people, information and assets, at both domestic and international (PSPF 2016). The Australian Signals Directorate (ASD) provided the Australian Government **Information Security Manual (ISM) [19]**. The standard oversees the security of government ICT systems (ISM 2017). It adds to the features of PSPF (Australian Cyber Security Centre (ACSC) 2018). The **NIST Cybersecurity Framework** provides a privacy guide in the form of a policy framework regarding the way private sector organizations in the US can measure and improve their ability for prevention, detection, and responding to cyber-attacks (NIST Framework for Improving Critical Infrastructure Cybersecurity 2018). Most recently, the **Mandatory Data Breach Notifications (MDBN)** laws followed by other laws coming into effect in Australia, to make sure that individual entities in the digital ecosystems, including federal entities, big businesses, small to medium-size enterprises (SMEs), and customers need fulfilling their responsibility in making Australia "cyber secure", according to Senator Bridget McKenzie (2017). Further, recent introduction of the **EU General Data Protection Regulation (GDPR)** is another requirement for the business to consider. The GDPR was aimed to blend data privacy laws across Europe, to guard and authorize all EU nationals' information privacy and to redesign the way organisations across the region interpret and address information privacy. Australians also need to have the assurance of information privacy. Thus, the management and ongoing maintenance of privacy provisions for digital data is very challenging, because of the wide range of interconnected yet often different laws that apply to different types of information and sectors (Holt and Malcic, 2015). Privacy regulators face a mass of challenges as well when dealing with the data that spreads outside legal boundaries in digital ecosystems (Sinha 2018). This draws our attention to the following research challenge.

RQ: What is the scope and relevance of key national and international privacy laws for digital ecosystems?

This paper presents a review and mapping of national and international information privacy laws and standards to inform the secure design of the digital ecosystems. The paper evaluates the relevance and

coverage of seven laws. Further, it recommends that there is a need for a complete end-to-end framework that should address privacy concerns throughout the information life cycle and is embedded in the design of all the layers of the digital ecosystem.

The paper is organized as follows. Firstly, it provides the research background to set the context for this study. Secondly it presents the research method and review criteria. Thirdly, it presents the review and mapping results. Fourthly, it discusses the review results and its implications. Finally, it concludes with key learnings and future research directions.

## 2 Background

Information privacy in Australia is protected by a combination of Commonwealth, State and Territory legislations, which often includes a collection of privacy principles that are based on the Organisation for Economic Co-operation and Development's Guidelines on the Protection of Privacy and Trans-border flows of Personal Information (OECD 2003). The protection of information privacy in Australia has been referred to as a 'patchwork' (Patchwork NSW 2014). Although, all of the relevant laws are based on the OECD principles, there are substantial dissimilarities in the approach they are applied from industry to industry and, in some cases (particularly for health privacy); there are overlaps between Commonwealth and State legislations. A brief summary (Table 1) on the legislation confirms these Australian patchwork-driven regulatory trends. To begin with, there is no public sector information privacy law or protection neither in South Australia nor in Western Australia (ALRC 2007). In New South Wales (NSW) the Privacy and Personal Information Protection Act 1998 (PIPPA Act) regulates information privacy in the NSW public sector (except health privacy). The Health Records and Information Privacy Act 2002 (HRIP) regulate health information in NSW. The HRIP applies to any public sector or private sector organisation that collects or handles health information in NSW (Croucher 2011). In Victoria, the Privacy and Data Protection Act 2014 regulates information privacy within the Victorian public sector (except health information). The Health Records Act 2001 regulates information privacy within the Victorian public sector and for any private sector organisation that collects and handles health information. In Queensland, the Information Privacy Act 2009 regulates privacy, including health privacy, in the Queensland public sector. The Personal Information and Protection Act 2004 regulates information privacy in the Tasmanian public sector. The Information Privacy Act 2014 regulates the collection and handling of personal information (but not health information) by Australian Capital Territory (ACT, Canberra) public sector agencies.

Table 1 summarises the Australian privacy laws and their corresponding sectors of applicability. Each of Australia's information privacy regimes are overseen by the Commissioner. Privacy Commissioners are, in broad terms, given responsibility for resolving privacy complaints – typically through a conciliation process.

Industry	Standard/Regulation
Healthcare	Privacy Act (1988) (applicable to private sectors only), Royal Australian College of General Practitioners (RACGP), Computer and Information Security Standards, National Health and Medical Research Council's "The Regulation of Health Information Privacy in Australia"., National Health Act 1953, Healthcare Identifiers Regulations 2010, Healthcare Identifiers Act 2012 (HI Act), My Health Records Rule 2016 , My Health Records Regulation 2012. Mandatory Data Breach Notifications (MDBN) ISO 270001/2, COBIT5
Internet services	Communication Alliance C650:2014 icode, Australian Communications and Media Authority's "Australian Internet Security Initiative" (ACMA, 2015), Telecommunications and Listening Device Amendment Act. ISO 270001/2 and COBIT5
Federal Government	Australian Government Protective Security Framework (PSPF), Privacy Act (1988), Information Security Manual(ISM), Mandatory Data Breach Notifications (MDBN), Australian Government Agencies Privacy Code (1 <sup>st</sup> Jul,2018)
Cross Border Information Sharing	APP 8, Australian Federal Police Act 1979 (Cth), Mutual Assistance in Criminal Matters Act 1987 (Cth), Anti-money Laundering and Counter-terrorism Financing Act 2006 (Cth)

Defence	Crimes Act 1914
Taxation	Australian Privacy Principles (APP), Taxation Administration Act 1953, Income Tax Assessment Act 1936, Superannuation Industry (Supervision) Act 1993, Retirement Savings Accounts Act 1997, Data-matching Program (Assistance and Tax) Act 1990
Education	Unique Student Identifier (USI),
Banking and finance	APRA CPG 235 and PPG 234, relevant subsections of section RG104 of AFSL license obligation (RG104.93 and RG 104.96), Anti-Money Laundering And Counter-Terrorism Financing Act (Cth), Financial Transaction Reports Act (Cth), ISO270001/2 and COBIT5
Human Rights & Social Behaviour	Australian Human Rights Commission Act 1986, Human Rights (Sexual Conduct) Act 1994, ALRC Report 123 (2014), s.15,
Digital Ecosystems	Partial Coverage. No industry specific law
Manufacturing	None, recommended to follow ISO270001/2 and COBIT5
State Government	Mostly states are using PSPF and ISM as baseline
Mining	No particular Law, Recommended to follow ISO270001/2, ISO 27019 and COBIT5
Utilities	No particular Law, Recommended to follow ISO270001/2, ISO27019 and COBIT5
Retailers	No particular Law, Recommended to follow ISO 270001/2, ISO 27019 and COBIT5
Telecommunications	Telecommunications and Listening Device Amendment Act, Australian Communications and Media Authority's "Australian Internet Security Initiative"(ACMA,2015), Telecommunications Act 1997, Telecommunications(interception and access) Act 1979 ISO270001/2 and COBIT5
Small Businesses	Do Not Call Register Act 2006 (Cth) , Anti-Money Laundering and Counter-Terrorism Financing Act 2006 (AML/CTF Act

*Table 1. Summary of Industries and Corresponding Laws*

Privacy Act is the primary element of federal legislation regulating privacy in Australia. The Act controls the management of personal information by the Australian Government, the ACT Government and the private sector. It covers personal information and sensitive information e.g. health records. It provides a higher level of protection for sensitive information. There are a number of exceptions, the most vital of which is that the private sector privacy protections do not apply to small business operators (unless they collect and handle health information). Another important exemption is that employers who collect and handle health information about an employee are not bound to comply with privacy compulsions in respect of that information (ALRC 2007).

Other federal legislations also regulate the handling of personal information. For example, the *Freedom of Information Act 1982* (Cth) (FOI Act) provides access rights to each individual to the documents held by government agencies or Ministers, other than exempt documents. The conduct of tax file numbers (TFNs) is controlled by different federal Acts including the *Income Tax Assessment Act 1936* (Cth) and the *Taxation Administration Act 1953* (Cth). The *Data-matching Program (Assistance and Tax) Act 1990* (Cth) regulates data-matching using TFNs. Federal legislation also contains a large number of secrecy provisions that impose duties on public servants not to disclose information that comes to them by virtue of their office (ALRC 2007). Each Australian state and territory controls the administration of personal data. In some states and territories, personal information is regulated by legislative schemes, in others by administrative regimes (ALRC 2008).

After review of the currently applicable information security laws and regulations, it is obvious that Australia has a few common information security laws but is missing some of the industry specific standards. For those missing regulations in Australia, Australian organizations can adopt related international frameworks. For example, Australian Securities and the investment corporation recommends adopting NIST cyber security framework (ASIC 2015). However, with digital ecosystems, there is no specific well-established privacy law that covers end-to-end lifecycle of data, locally as well as internationally. As discussed earlier, there are many privacy laws and regulations to choose from and thus need to be reviewed for digital ecosystems. Nonetheless, a single privacy law usually does not

provide end-to-end (high to low level) privacy as is required by digital ecosystem. In order to ensure privacy of information in digital ecosystem, there should be a complete privacy framework that covers the entire lifecycle of information, starting from its collection to destruction across all the architecture layers (e.g. people, process, information, technology) of the digital ecosystem (Gill 2015).

### 3 Research Method

This review uses the four layers (e.g. people, process, information, technology) of digital ecosystem in order to evaluate the relevance of selected regulations. The four layers were adapted from the adaptive enterprise architecture modelling by (Gill 2015). We adopted a document based qualitative research method to review a set of key privacy laws across the selected layers of digital ecosystem architecture (Bashir and Gill, 2016). The qualitative approach seems appropriate in the context of this paper as it allowed to review the seven well-known privacy regulations from high to low level, as required and fit in the context of research question in hand. Like other analytical methods in qualitative research, document analysis requires that data be examined and interpreted in order to elicit meaning, gain understanding, and develop empirical knowledge (Bowen 2009). Each regulation is measured against different attributes (Fig 3, Fig 4, Fig 5, Fig 6) of digital ecosystem's layers. The potential source of data for deriving the attributes of each layer; is official documents of mentioned compliance regulations (APP, Privacy Act, ISM, PSPF, MDBN, NIST, PSPF).

The *Privacy Act* and many other legislations (FoI Act, TFNs etc) were enacted before the rise of Big Data and neither adequately addresses the concerns of individuals or provides clarification for business regarding the steps that should be taken to manage the competing interests. There is no straight forward law that provides guidelines in balancing the protection of an individual's privacy against the business desire to use this valuable "new economic asset" that is Big Data (Christie and Saadati, 2013).

This paper reviews the most recent literature published on privacy laws in the context of digital ecosystems. Each layer of DE is further broken down into certain attributes and applicability of chosen laws is checked individually for each attribute. Table 2 summarises the selected laws and review criteria that is used in this study.

BDE Layer	Standard/Regulation
	APP Privacy Act(1988)
	P I N M G S S I D D P M S B P F T N R
People	How do these regulations and standards support privacy of people related to DE?
Process	How do these regulations and standards support processes involved to carry out functioning of DE
Information	How do these regulations and standards ensure privacy of information/data in DE
Technology	How do these regulations and standards ensure privacy through technology used in DE

Table 2. Review Criteria

### 4 Results

This section applies the review criteria mentioned in table 2, and presents the review and detailed mapping of seven well-known privacy regulations. As discussed earlier, the aim of this paper is to review these standards from digital ecosystem's perspective. This paper assembles many of the information security related legal and regulatory requirements of the federal government of Australia.

With so many interconnected devices and huge amount of data at stake, the need for cyber and data security has reached levels seen never before in the history of internet era. The more the data with an organization, the more valuable the organization is for an attacker (Joshi 2017). The generation and exploitation of big data is key element of digital ecosystems (Urbiola 2018). Digital ecosystems can improve the quality of their services by combining and exploiting big data properly. This allows DE to increase customer involvement and make new customers, obtaining yet more information and continuing to improve their worth. However, the application of key privacy principles, together with notice and consent, data collection and retention, as well as use limitation, is dealt with differently in big data domain (OAIC 2016). Other than privacy and spam acts, Australian laws do not currently regulate Big Data (Christie and Saadati, 2013). This paper reviews seven of the most recent privacy laws in Australia with reference to digital ecosystem and evaluates them according to all the layers. Figure 1 shows the collective coverage offered by seven laws under study for four layers of digital ecosystem. We have mapped each law, one by one to the attributes of each layer and turned the flag on if it was applicable to any particular attribute. Ideally, if there was a complete coverage of privacy offered by the laws under discussion; each attribute should have all seven flags on against each law. In the end, the total score of all the flags was taken and percentage was calculated. According to this calculation, people layer seems to have highest applicability from the laws with 28.6 percent whereas technology layer has least controls applicable to it with a percentage of 25.5%. The process and information layer both lie more or less at the same point with 27% and 28% controls. Figure 2 shows what percentage each laws has in each layers. For example, GDPR is applicable to 70% of people layer attributes, 34.6% of process layer attributes, 52% of information layer and 57% of technology layer.

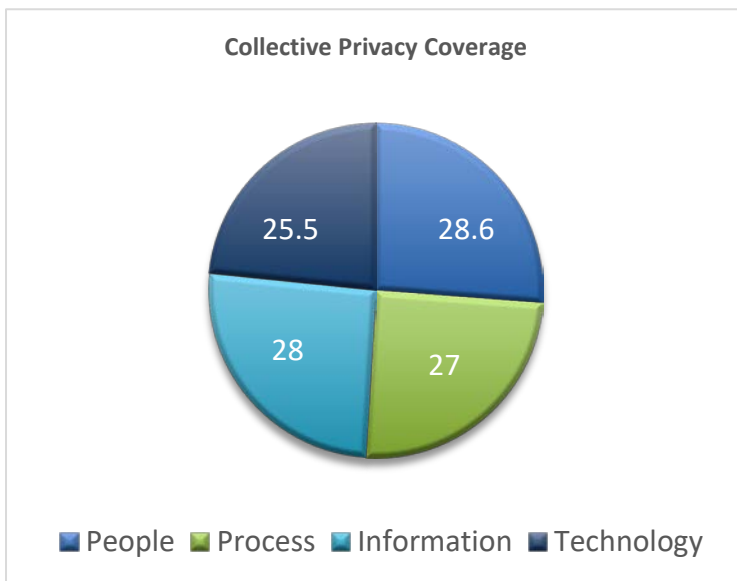

Figure 1: Collective Privacy Coverage

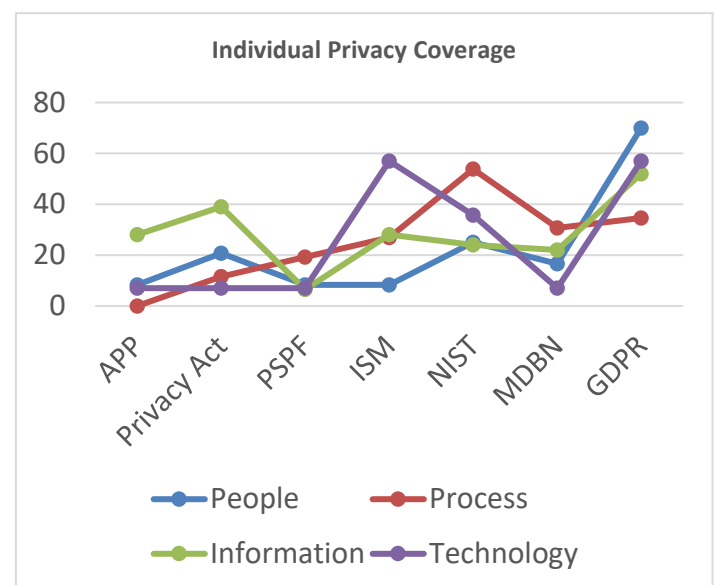

Figure 2: Individual Privacy Coverage

Figure 3, figure 4, figure 5 and figure 6 illustrate the mapping of Australian privacy laws on DE.

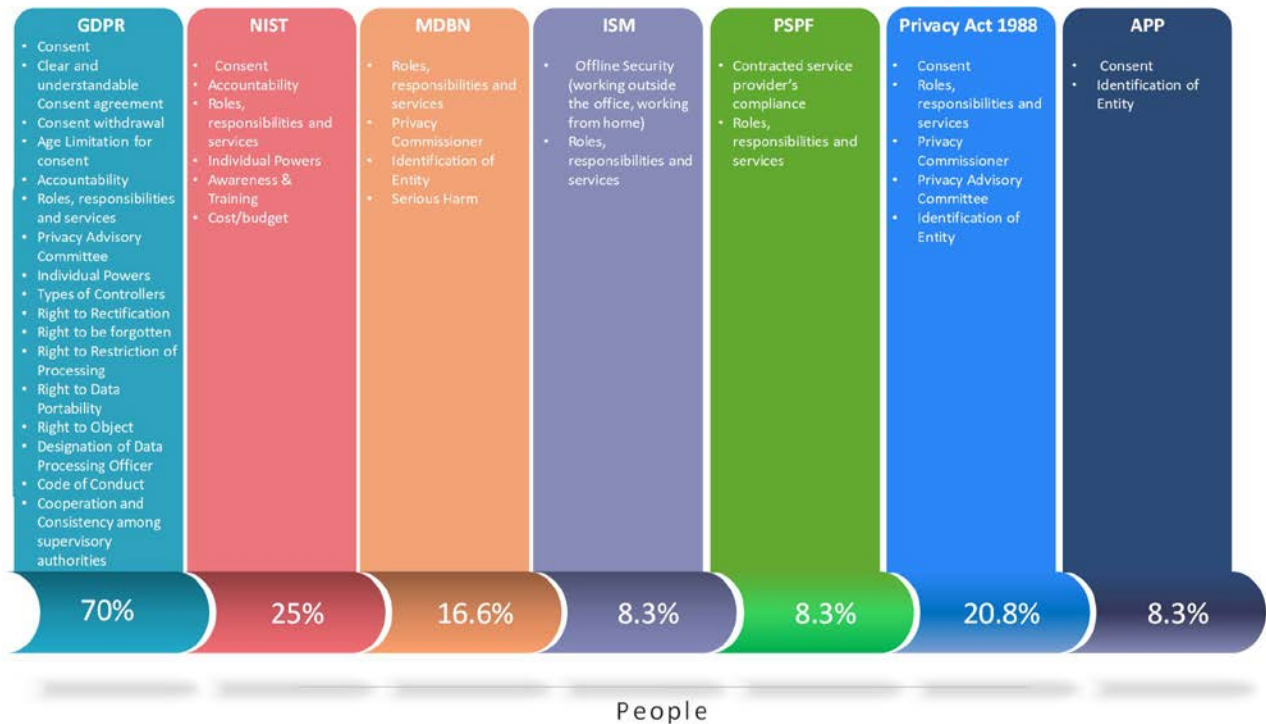

Figure 3: Division of People Layer and Applicability of laws

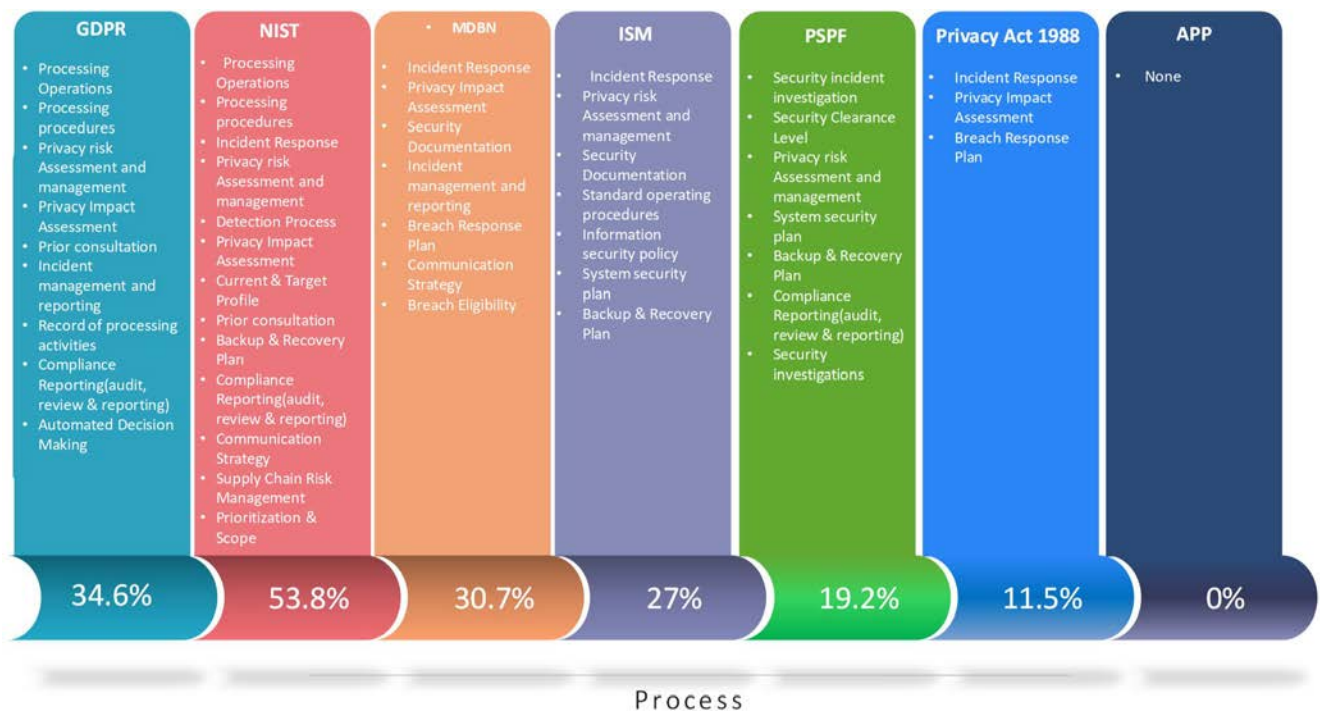

Figure 4: Division of People Layer and Applicability of laws

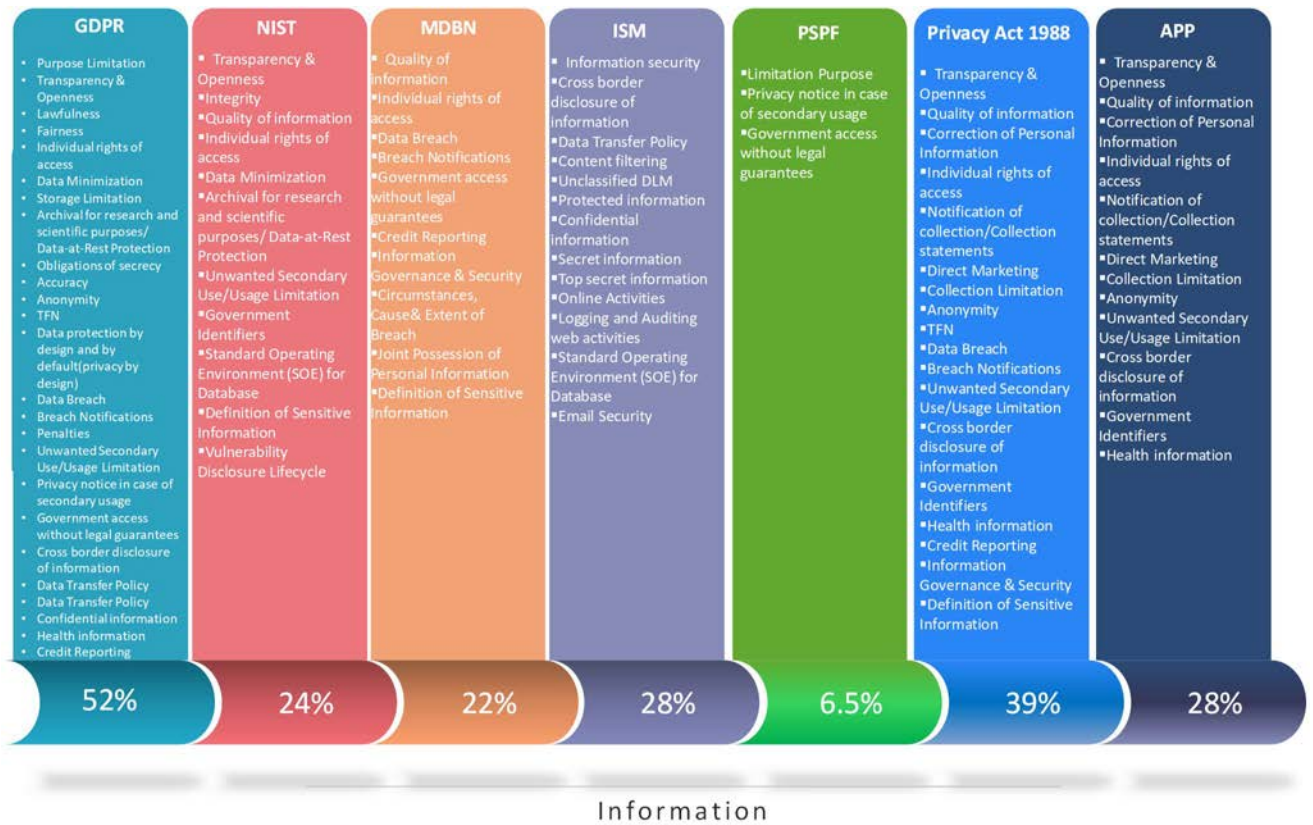

Figure 5: Division of People Layer and Applicability of laws

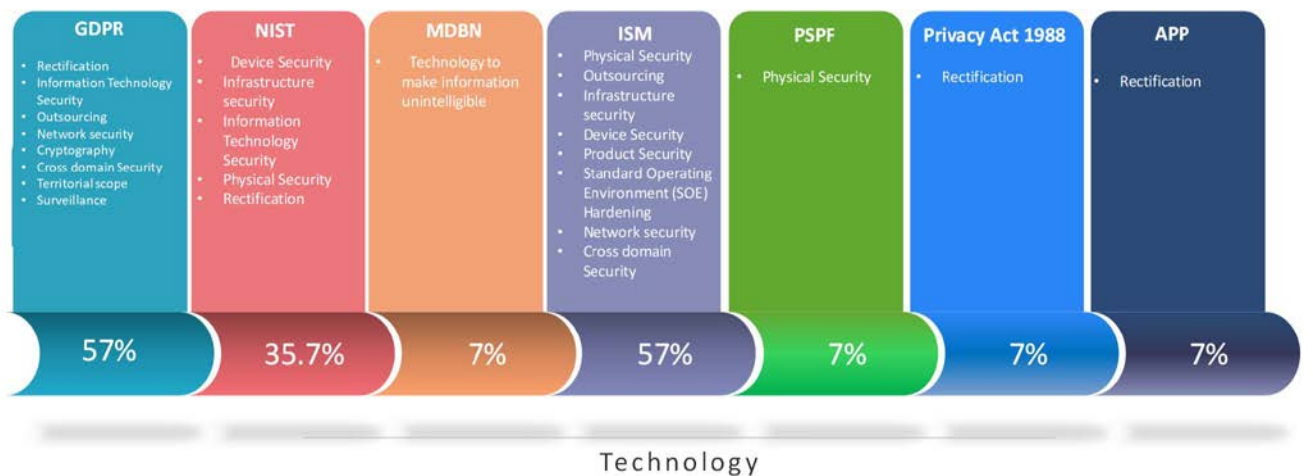

Figure 6: Division of People Layer and Applicability of laws

The score for each layer shows the number of attributes covered by individual law in those layers. For example, APP, PSPF and ISM provide privacy controls for only two attributes in people’s layer of digital ecosystem, thus constituting only 8.3% of the total listed attributes. Privacy Act 1988 provides controls for 20.8% attributes, NIST cybersecurity framework gives 25% coverage and MDBN provides solutions against 16.6% attributes. It is evident from the scores that GDPR is the only law that yields maximum coverage (70%). The laws under discussion cover process layer to a lesser extent. APP gives no coverage at all in this layer whereas privacy act has controls for around 11.5% attributes in process layer. PSPF,



ISM and MDBN are applicable to 19.2%, 26.9% and 30.7% of total attributes. In this layer, foreign laws (NIST and GDPR) seem to be more thorough and complete with NIST's applicability to 53.8% elements and GDPR to 34.6% attributes.

Information or data layer is the key layer in digital ecosystem and it provides foundation for many other layers. Hence, the attributes in this layer are multidimensional, some overlapping with the other layers too. For example, when it is being said that information needs to have a purpose limitation, this relates to some process that ensures purpose limitation. In order to attain this attribute information security policy is needed which is one of the attributes of process layer. However, the applicability of the laws under discussion in this study is almost same as it is for other layers. APP (28%), PSPF (6.5%), ISM (28%), NIST (24%) and MDBN (22%) gives coverage to less than 30% of the attributes in information layer. Privacy Act is a bit thorough covering 39% elements, whereas GDPR gives a score of 52% and proves to be the most widespread in this layer. GDPR and ISM possess controls and principles that apply mostly to the technology layer. GDPR has 57% and ISM has 61.5% controls targeting technology related attributes. Rest of the seven laws under review in this paper, i.e. APP, Privacy Act 1988, PSPF, NIST and MDBN each cover 7% of the technology layer attributes.

## 5 Discussion and analysis

Any business, once established the information to be collected, stored, used or disclosed that may be considered 'personal', 'sensitive' or 'health' information, it then needs to determine which (if any) privacy laws apply to the organisation. This is the most difficult part to figure out which law covers all the aspects of the organization and its business domain. With digital ecosystems, especially there is no law that perfectly covers all the areas throughout the lifecycle. In this study, a review of Australian Privacy laws is conducted according to the criteria mentioned in table 2. The general industry standards and government segments in Australia were analysed against the current information security related guidance, laws, regulations and legislations and a summarized description of the results is presented in figures 1 to figure 6. Researchers can use these figures as a starting point in their understanding of applicable regulation/standard for a specific privacy attribute. It must be taken into account that there are few information security related legal, legislative and regulatory obligations applicable for all layers of DE. Figure 1 highlights the collective coverage of privacy laws under review across the layers.

**Australian Privacy Principles (APP)** are part of the recent amendment to **Privacy Act 1988(Cth)**. This set of APPs upon which Privacy act is based, applies to federal government as well as to private sector organizations. It has ended the complexity and confusion in the application of privacy laws largely (The Privacy Act 1988). Unlike New Zealand, Australia's information privacy laws were not declared as providing 'an adequate level of data protection' under Article 25(2) of the EU Directive 95/46/EC and will not receive a similar declaration under the GDPR (Watts and Casanova, 2018). In this research, we have concluded that APP and privacy act 1988 does not cover many aspects of privacy in digital ecosystem. From the results we can see that APP and privacy act are applicable to 8.3% and 20.3% on people layer, 0% and 11.5% on process layer, 28% and 39% on information layer and 7% each on technology layer. Being a part of any Australian government agency, companies need to be compliant with the mandatory requirements of the **Protective Security Policy Framework (PSPF)** (Sinha 2018). It promotes a risk- managed perspective to privacy. The PSPF is believed to address many challenges impersonated by the recent rise of technology and prominently supplementary threats due to data deluge. Information Security manual is another government standard in Australia that complements PSPF. The manual is the standard that governs the security of government ICT systems. However, with digital ecosystem, there are certain areas where PSPF and ISM lack applicability. According to the results deducted in this study, PSPF and ISM give 8.3% applicability on people layer, which is very low figure. On process, information and technology layers, they offer 19.2% and 27% (process layer), 6.5% and 28% (information layer) and 7% and 57% (technology layers) applicability. **Mandatory data breach notification (MDBN)** laws that came in to effect in February 2018 do not cover most of the private sector and only require those affected to be notified within a reasonable time (OAIC 2018). This is a very recent law and offers a good coverage on digital ecosystem layers. It has 16.6% control for people layer, 30.7% for process layer, 7% for technology layer and 22% for information layer.

**NIST's** Cyber Security Framework is a US based framework used by many organisations. It is a prioritised, flexible, repeatable and cost-effective framework to help manage cyber security-related risks (NIST Framework for Improving Critical Infrastructure Cybersecurity 2018). According to our mapping, it is the second most thorough law that has reasonable percentage of controls applicable to each layers of digital ecosystem. It has been found that NIST is applicable to 52% of people layer attributes, 53.8%

of process layers, 24% technology layer and 35.7 percent technology layer. This is a very good percentage as compared to Australian laws. Even better coverage is provided by EU's GDPR. It has highest coverage on people with 70% attributes covers. Process layer has 34.6% applicability from GDPR, 52% on information layer and 57% on technology layer. Sanctions and penalties under Australian information privacy laws are comparatively weak when compared to the European Union, particularly when compared to the sanctions available under the **General Data Protection Regulation (GDPR)** (EU GDPR 2018). Compared to the GDPR, Australia's information privacy laws have not been refreshed by the conferral of additional rights that have become increasingly important for the protection of privacy in the context of digital ecosystem or similar technologies. For example: (i) There is no 'right to be forgotten', (ii) There are no 'data portability' rights, (iii) There is no right to object to the processing of personal information (such as profiling). Hence, at a Commonwealth level, Australia's information privacy laws have lagged behind European developments and the introduction of new technologies that challenge existing forms of protection. No reform activity has considered the impact of Big Data on Australia's privacy laws.

## 6 Conclusion and future work

This paper presented a comprehensive review and mapping of seven important regulations to clearly understand their support or coverage for designing the contemporary digital ecosystems. The results indicate that the reviewed regulations differ in nature and scope but have some common overlapping areas and gaps, which warrant further research. The results of this study have implications for both researchers and practitioners who have interest in designing and developing secure digital ecosystem, to ensure that important regulatory requirements are identified and are not overlooked. This research has also implications for regulators to make an informed decision about the review or modification of existing regulations to ensure the privacy of information in multi-party digital ecosystems. In a nutshell, this work is intended to help researchers, regulators and practitioners to understand the scope and relevance of each privacy law.

## 7 References

- Attorney-General's Department, A.G.2016. "Protective Security Policy Framework 2016-17 Compliance Report", Attorney- General's Department, Australia, pp.1-11
- Australian Cyber Security Centre (ACSC). 2018. Acsc.gov.au, <https://acsc.gov.au/> , retrieved: August 5, 2018
- Bashir, M.R., and Gill, A. Q. 2016. "Towards an IoT Big Data Analytics Framework: Smart Buildings Systems," *2016 IEEE 18th International Conference on High Performance Computing and Communications; IEEE 14th International Conference on Smart City; IEEE 2nd International Conference on Data Science and Systems (HPCC/Smart City/DSS)*, January, pp. 155-178.
- Bowen, Glenn A., 2009, 'Document Analysis as a Qualitative Research Method', *Qualitative Research Journal*, vol. 9, no. 2, pp. 27-40. DOI 10.3316/QRJ0902027. This is a peer-reviewed article.
- Christie, A. & Saadati, R. 2013. "Australia: Big Data, big issues? Is Australian privacy law keeping up?", <http://www.mondaq.com/australia/x/254100/data+protection/Big+Data+big+issues+Is+Australian+privacy+law+keeping+up> , Retrieved 23 July, 2018.
- Commission, A. L. R. 2007. "Review of Australian Privacy Law," *DP (72)*, pp. 51-52.
- Commission, A. L. R. 2008. "*For Your Information: Australian Privacy Law and Practice*", Report. Law Reform Commission.
- Commission, A.G.P. 2016." Productivity Commission Data Availability and Use Draft Report", pp.1-652
- Croucher, R. 2011. "Australian Privacy Law & Practice - Key Recommendations for Health Information Privacy Reform.", <https://www.alrc.gov.au/news-media/2011/australian-privacy-law-practice-key-recommendations-health-information-privacy-refor?print>, Retrieved: 13 July, 2018

- Cybersecurity, C. I. 2014. "Framework for Improving Critical Infrastructure Cybersecurity," *Framework* (1), p. 11.
- Department of Defence, A.G. 2017. "Australian Government Information Security Manual", Australia, pp. 1-340
- Duynstee, C.A.N.L., Haayen, M.J., Kyritsis, D., Ortega-Cordova, L.M. & Samat, S.N.N. 2016. "Synthesis Project Dordrecht Smart City Dordrecht – Identification of Pedestrian Movement Patterns with Wi-Fi Tracking Sensors." , TUDelft, May 23, 2016, pp.1-77
- EU. 2018, "General Data Protection Regulation", <https://gdpr-info.eu> , Retrieved: 5<sup>th</sup> June, 2018.
- Gill, A. Q. 2015. "Agile Enterprise Architecture Modelling: Evaluating the Applicability and Integration of Six Modelling Standards," *Information and Software Technology* (67), pp. 196-206.
- Gill, A.Q., Smith, S., Beydoun, G. and Sugumaran, V. 2014. Agile enterprise architecture: a case of a cloud technology-enabled government enterprise transformation.
- Holt, J., and Malčić, S. 2015. "The Privacy Ecosystem: Regulating Digital Identity in the United States and European Union," *Journal of Information Policy* (5), pp. 155-178.
- Joshi, H. 2017. "Security and Privacy in the Digital World", Deloitte, pp.1-27
- Moghe, V. 2003. "Privacy Management—a New Era in the Australian Business Environment," *Information Management & Computer Security* (11:2), pp. 60-66.
- NIST. 2018. "Framework for Improving Critical Infrastructure Cybersecurity", <https://doi.org/10.6028/NIST.CSWP.04162018> , Retrieved: July 2, 2018
- OAIC, A.G. 1988. "The Privacy Act (1988)", <https://www.oaic.gov.au/privacy-law/privacy-act> , retrieved: 12 June, 2018.
- OAIC, A.G. 2018. "Data Breach Preparation and Response", <https://www.oaic.gov.au> , Retrieved 1<sup>st</sup> June 2018.
- Patchwork, N.S.W. 2014. "Patchwork is a tool to share practitioner information, not to share client information", <https://www.patchworknsw.net.au/privacy> , Retrieved July 23, 2018.
- Schmidt, A. 2014. "What is the best definition for "digital ecosystem"?", Quora
- Sinha, G. 2018. "Governance, risk and compliance: 2018 trends and predictions." <https://www.itproportal.com/features/governance-risk-and-compliance-2018-trends-and-predictions> , Retrieved: July 16, 2018.
- Urbiola, P. 2018. "The power of digital ecosystems", BBVA Research, February, pp 1-3
- Watts, D. & Casanova, P. 2018, "Privacy and Data Protection in Australia: a Critical overview (extended abstract)", <https://www.w3.org/2018/vocabws/papers/watts-casanovas.pdf>, Retrieved: 5<sup>th</sup> June, 2018.
- YourCause, 2018. "Privacy Policy", May 2018, pp.1-13

## Acknowledgements

This research is funded by the Australian Govt. Research Training Program (RTP). Views expressed herein are however not necessarily representative of the views held by the funders.

## Copyright

**Copyright:** © 2018 authors. This is an open-access article distributed under the terms of the [Creative Commons Attribution-NonCommercial 3.0 Australia License](#), which permits non-commercial use, distribution, and reproduction in any medium, provided the original author and ACIS are credited.

# Internet of Things for improving Supply Chain Performance: A Qualitative Study of Australian Retailers

**Tharaka de Vass**

College of Business  
Victoria University  
Melbourne, Australia  
Tharaka.DeVass@vu.edu.au

**Himanshu Shee**

College of Business  
Victoria University  
Melbourne, Australia  
Himanshu.Shee@vu.edu.au

**Shah Jahan Miah**

College of Business  
Victoria University  
Melbourne, Australia  
Shah.Miah@vu.edu.au

## Abstract

Internet of Things (IoT) is a global platform of Internet connected smart devices that have been argued to improve the supply chain integration (SCI). While the positive effect of IoT capability on SCI influencing supply chain and firm performance is empirically validated, exploratory study in this context is limited. Drawing upon the organisational capability theory, this study investigates the use of IoT in enhancing the integration of suppliers, customers and internal activities of the retail supply chain. Interviews of managers across Australian retail industry were analysed using Nvivo. The thematic analysis reveals the added capability of IoT that improves supply chain visibility, auto-capture and information sharing for greater SCI. The IoT-enabled integration capability demonstrates a positive effect on cost, quality, delivery, and flexibility of the entire supply chain and improves retail firm's sustainable performance with financial, social and environmental outcomes.

**Keywords** Internet of Things (IoT), supply chain integration, supply chain performance, firm performance, organisational capability theory

## 1 Introduction

Internet of Things (IoT) is defined as a global platform of Internet connected smart objects that allows things to connect anytime, anywhere using any network or service (Atzori, Iera, & Morabito, 2010; Borgia, 2014; de Vass, Shee & Miah, 2018). It is viewed as an extension of legacy ICT systems (e.g. computers, ERP, email, fax, phone, and WMS) that traditionally facilitate information sharing among individuals, organisations, and industries (Borgia, 2014). Consequently, IoT act as emerging information service architecture facilitating the exchange of goods in global supply networks (Liu & Sun, 2011). The RFID tags, sensors, actuators, mobile phones and GPS services are reported to have the capability of conducting real-time data capture and monitoring of almost every link in contemporary supply chains (Ben-Daya, Hassini, & Bahroun, 2017).

In an era where supply chain performance is presumed as key enabler of firms' sustainability, supply chain integration (SCI) mechanism has emerged as a key driver in improving such performance (Alfalla-Luque, Medina-Lopez, & Dey, 2013). SCI is defined as collaborative internal and external management of strategic, tactical and operational business processes to achieve effective and efficient flows of products, information and funds to provide the maximum value to the end customer at the lowest cost and the greatest speed (Alfalla-Luque et al., 2013; Huo, 2012; Yu, 2015). Within the context, ICT is traditionally considered as a digital enabler of SCI, by facilitating inter- and intra-firm information flows (Rai, Patnayakuni, & Seth, 2006). Consequently, multitude of studies confirm the positive effect of ICT on SCI (Kim, 2017; Li, Yang, Sun, & Sohal, 2009; Rai et al., 2006).

However, the limitation of traditional ICT in sensing and capturing additional transactional data has paved the way to emerging services and applications such as IoT that facilitate interconnection of physical things with digital world (Constantinides, Kahlert, & de Vries, 2017; de Vass et al., 2018). Further, it offers a safe and trustworthy platform to exchange information related to goods and services in a global supply chain (Mishra et al., 2016). However, there is limited empirical evidence on its effect on supply chain and firm performance (Mishra et al., 2016), except the recent study done by de Vass, Shee, & Miah (2018).

Research on IoT is still emerging (Liu & Gao, 2014), and its potential benefits are seldom explored (Whitmore, Agarwal, & Da Xu, 2014). Despite conceptualisations (Ping, Liu, Zhou, and Wang, 2011) and laboratory experimentation (Yan et al., 2014), the use of IoT is still in its early stages for some retailers. Others are claiming to have IoT in some form or other for sometimes now. Further, literature calls for empirical evidence of IoT effect on SCI. To fill this knowledge gap, de Vass et al. (2018)'s survey-based empirical framework confirms the positive effect of IoT capability on three dimensions (i.e., supplier, internal and supplier integration) of SCI impacting supply chain and firm performance, from the Australian retail industry perspective. However, the study lacks descriptive insights to explain the ground reality of IoT in use.

Retail is an industry reported to be at the forefront in embracing IoT (Balaji & Roy, 2017), as it faces various challenges due to its dynamic nature and unexpected consumer expectation (Majeed & Rupasinghe, 2017). IoT use provides innovative approaches for retailers (Constantinides et al., 2017). From organisational capability perspective, IoT adoption can be viewed as an additional capability that can add to the current configuration of ICT capability for greater SCI (de Vass et al., 2018). However, the current state of IoT use is quite rhetoric and fragmented in discussion among practitioners and academics.

Hence, the aim of the qualitative study is to investigate the ground reality of IoT use in Australian retailers to drive their supply chain performance. The sub-objectives are: (i) to find out the extent IoT help in supplier process integration; (ii) the extent IoT help in customer process integration; (iii) the extent IoT help in internal integration, and (iv) extent it helps in performance improvement of supply chain firms. The research question developed to achieve these objectives is how IoT technologies drive supply chain processes with suppliers, customers and internal activities of the retail firms.

This paper is set out as follows. First, the literature on SCI, ICT and IoT is reviewed. The methodology of data collection via semi-structured interviews and analysis techniques is then outlined. Discussion, theoretical and managerial implications are presented. Finally, the study concludes with a summary and limitations of the study.

## 2 Literature background

### 2.1 Supply chain integration and performance

SCI is conceptualised as a significant contributor to supply chain performance (Alfalla-Luque et al., 2013; Huo, 2012). Although some scholars examined SCI as a single construct, multi-dimensional (e.g., internal, supplier and customer integration) approach has been the preferred alternative (Alfalla-Luque et al., 2013). Internal integration can break down cross-functional barriers and facilitate real-time information sharing across key functions; supplier integration involves collaboration between a focal firm and its suppliers in managing cross-firm business processes; customer integration enables a deeper understanding of market expectations and opportunities in response to customer requirements (Huo, 2012; Yu, 2015). These internal and external integrating capabilities directly and indirectly contribute to performance (Huo, 2012). Within this context, ICT is considered as a digital enabler for SCI, via enhanced information flows (Li et al., 2009; Rai et al., 2006).

### 2.2 Information and Communication Technologies and Supply Chain Integration

Ample studies confirm ICT as an enabler of SCI for performance gain (Kim, 2017; Li et al., 2009; Rai et al., 2006). The findings are consistent with organisational capability theoretical perspective, where ICT is considered as having an impact on performance through a higher-order capability, in this case integration (Rai et al., 2006). The conceptualisation is that ICT implementation itself cannot generate performance; its business alignment and application to facilitate SCI is what renders positive outcomes (Kim, 2017; Li et al., 2009; Rai et al., 2006). Incidentally, the SCI studies have been predominantly survey-based, conducted on legacy ICT systems (Kim, 2017; Li et al., 2009; Rai et al., 2006).

### 2.3 Internet of Things and Supply Chain Integration

The emerging IoT is expected to play a leading role in the Industry 4.0 era, where the integration of IoT into logistic digitalisation is becoming more and more relevant (Hofmann & Rüsçh, 2017). Thus, IoT is perceived to facilitate a technological shift in supply chain management (Ben-Daya et al., 2017). Supply chain information systems based on IoT are capable to coordinate and integrate internal and external activities of enterprises (Cui, 2015). Correspondingly, SCI is reported to be greatly enhanced with the proliferation of IoT (Haddud, DeSouza, Khare, & Lee, 2017).

Scholars have acknowledged the effect of IoT on SCI in their studies (Cui, 2015; Haddud et al., 2017). Ping et al. (2011)'s conceptualisation provides a detailed account on how IoT bridges the gap between physical objects and digital world, to establish a connection between the physical flow and the information flow. However, among the scant literature that validates IoT SCI attributes, Yan et al. (2014)'s study tested the relationship between IoT and SCI, in controlled laboratory conditions to confirm its integration capability. Later, de Vass et al. (2018) offer empirical evidence on IoT capability having a significant effect on internal, customer and supplier integration processes to impact supply chain and firm sustainable performance. However, despite surveys grant statistical generalisation, it has been criticised for over-simplification of reality (Wieland & Marcus Wallenburg, 2012). Since, empirical researchers primarily utilise quantitative approaches, demand is however rising for qualitative perspectives (Wieland & Marcus Wallenburg, 2012). In consequence, interview based qualitative studies on this theme is yet to be undertaken, a gap that this research seeks to address.

## 3 Study methodology

This study is exploratory in nature, thus a qualitative inquiry was conducted on firms representing a cross section of retail industry, to draw critical process information. The respondents possessed technology enabled supply chain management knowledge and represented various retail subdivisions or sectors (ABS\_ANZSIC, 2013). The interviewees' profiles are displayed in Table 1. The majority of the participant retailers (7) were large (>200 employees) and the rest (5) were medium (20 > & <200) and represented all retail subdivisions (ABS\_ANZSIC, 2013).

*Table 1: Summary profile of the interviewees (retailers)*

ID	Cod e	Work exp. (Yrs.)	Job role	Retail sector	Key retail form	Firm size	First adopted IoT
1	A	2	Supply chain manager	Cosmetic and toiletry	Multi-model	Medium	Less than 2 years ago

2	B	11	Supply chain manager	Department store	Bricks and mortar	Large	Over 11 years
3	C	3	Supply chain manager	Supermarket	Bricks and mortar	Large	4 years now
4	D	2	Supply chain manager	Pet products	Multi-model	Large	5 years at-least
5	E	3	Owner	Restaurant/café/take-away	Multi-model	Medium	3 years now
6	F	4	Supply chain manager	Telecommunication products / Electronics	Multi-model	Large	3 years at least
7	G	5	Supply chain manager	Clothing, footwear and personal accessories	Multi-model	Large	Over 15 years
8	H	10	IT manager	Motor vehicles parts and Electronics	Multi-model	Medium	5 years at least
9	I	5	Supply chain manager	Supermarket	Bricks and mortar	Large	10 years at-least
10	J	20	Store manager	Fuel and convenience stores	Bricks and mortar	Large	5 years now
11	K	5	IT manager	Security and surveillance/ Electronics	Multi-model	Medium	5 years now
12	L	7	General manager	Household goods	E-tail	Medium	6 years now

One-on-one semi-structured interviews were conducted with the selected volunteers following de Vass et al. (2018)'s survey study. Semi-structured interviews helped gain rich insights into the core themes. The selection was mainly based on the retail sector, firm size, the retail form and the level of IoT deployment in their respective supply chain operations. The interview schedule had 15 questions under two sections. Section 1 was to understand the firm and the respondent demographics. Section 2 reflected on IoT deployment in in-house, supplier and customer related operations and their respective performance outcomes. IoT-enabled supply chain performance was probed under traditional cost, quality, delivery, flexibility dimensions and firm performance was explored under prevailing triple-bottom-lines (i.e., economic, environmental and social) of sustainability. The interviews lasted 45 minutes to 1 hour for each case, and were audio recorded. Following the transcription of the 12 interviews, they were analysed using a typical open-coding process used in qualitative research (Creswell & Poth 2017). Nvivo 11 was used for thematic analysis. A data reduction process was conducted, using an inductive approach to transform data into orderly and simplified themes to develop a meaningful outcome. This process involved reducing and categorising the text into meaningful segments and labelling them with an appropriate title to best define the material (Creswell & Poth 2017).

## 4 Study findings

All managers had the understanding of IoT and its inherent potential that were harmonised with academic conceptualisations.

“It is an umbrella term used universally for the mechanism behind it. IoT are the devices that capitalise the power of Internet” [Retailer I].

All believed that they had IoT in place to a reasonable degree, as a mix of ‘things’ across the supply chain in different operational processes with different intensity. Many referred to retail industry as ‘very competitive’ and IoT as technologies can help them gain a competitive edge. All commended on IoT potential in supply chain operations.

### 4.1 IoT technologies in Australian retail supply chain

Many technologies that narrated under IoT umbrella currently coexist, providing added digital capabilities to supply chain retailers. RFID, one form of IoT, at unit-level (e.g., pallet, container) in warehousing and transportation is evident. Barcode scanners, PDA's (personal digital assistant), RF (radio frequency) scanners, Laser, LED scanners and camera-based scanners are widespread in practice.

In warehousing, hand-held devices (e.g., PDA's, RF scanners) would provide a picking order, conform the product picking by scanning. Also, pick-to-voice, Automatic guided vehicles (AGV), and automatic pallet mover or conveyor control systems are used in operations. In retail store environment, handheld sensors and devices, POS devices, video analytics, IP Cameras, barcoding (unique for some perishable



items) and mobile payments, including Apple Pay, are already in use. In transport, IoT-enabled (i.e. sensor) track and trace systems, fleet controlling devices, vehicle tracking, and route optimisation are ongoing. IoT-enabled sensor networks in cold-chain logistics track and trace temperature-sensitive products. In food industry, customer can log into a portal on their smartphone to order, pay and track deliverers (e.g., Uber eats).

## 4.2 How IoT enables supplier integration

IoT applications in upstream logistics processes were positively conversed by all.

“I definitely believe that these devices play a big role by bringing us and our suppliers together. Better connection between the partners will only improve the activities and its processes” [Retailer E].

The major themes were around suppliers’ operational improvement, communication, forecasting, inbound delivery, receiving and traceability.

The theme of how IoT can help suppliers fulfil retailers’ requirement, was discussed by ten retailers. The retailers described many IoT forms at the supplier end to improve their own processes while helping the retailers. The hand-held devices, scanners, labellers, QR codes, barcodes, NFC (near field communicators), smart phones, tablets, various sensors in manufacturing and warehousing environments, image recognition, scan picking, pick-ti-voice picking were some of the common IoT forms. Retailer F stated that IoT helped their manufacturers better understand their processes by evaluating performance of the machines, energy consumption, ambient conditions, status of inventory, the flow of materials via hand-held devices, sensors and RFID.

IoT is important in strengthening communication with suppliers in stock ordering and other upstream information exchanges, according to eight retailers. Apps, Tabs, portals, and hand-held devices in supplier dispatch with real-time updates are very common. Eight retailers discussed forecasting process in procurement. Retailer G cited that due to IoT data, they could provide visibility to the supplier, around two years in advance.

The most common theme in upstream integration, discussed by all retailers, was the role of IoT in inbound delivery process. Their transporters use IoT forms such as GPS telemetry to find locations, track and trace vehicles, fleet controlling, route optimization and consolidation. Some (7) spoke same thing about the international delivery tracking. Although upstream traceability was a theme discussed by four retailers, IoT (GPS tracking) has been helpful to trace and track up to first-tier supplier only [Retailers A and I].

Three Retailers spoke of cold-chain monitoring. It was discussed that more drivers used sign-on-glass devices and hand-held devices, instead of paper-run sheets, so that everything was transmitted in real-time. IoT in receiving is a theme discussed by nine retailers. Again, they emphasised on real-time connectivity. Upstream traceability is a theme discussed by four retailers. However, IoT potential role in traceability beyond first-tier supplier was only discussed by Retailer’s A and I.

In summary, all were optimistic about IoT potential in supplier integration.

## 4.3 How IoT enables internal integration

All except retailer K argued positively about IoT applications in their internal logistics processes. The major themes were around DC/inventory, store and HR operations.

The most common theme was the role of IoT in DCs with exception of retailer E and F who did not comment. Retailer A explained how picking was simplified efficiently ever before with the help of hand-held devices. Retailer C spoke of a hand-held device, which they called MDT (mobile data terminal), that helped the forklift driver to receive, identify, and retrieve SKUs (stock keeping unit). The MDT helps forklift driver to scan and ensure the picking matched. Some retailer’s location picking is mainly done through pick-to-voice, which is an Internet-connected voice recognition system. Retailer B stated about their “latest cutting-edge sortation system”, which could label, scan and move cartoons to the desired location, of course using RFID (only at unit level on boxes and pallets) and the barcoding information. Security and surveillance camera which is quite energy saving and convenient, and finger print scanning for payroll purposes were some of the other themes discussed within warehousing context. The majority (except Retailer G) thought they had further potential to improve their warehousing through IoT technologies deployment. Retailer K discussed about available technologies in motion tracking using surveillance camera to detect breach of parameters and alert mechanism. Retailer H agreed about safety cameras with image recognition that was capable to identify inventory by scanning barcodes on goods around it.

Except retailers A (no in-store IoT) and L (e-tailer), the other ten retailers discussed how IoT driven in-store technologies could help their operations. The in-store technologies vary according to the nature of the business and the industry sector. The barcoding (inner cutting, open barcodes for SKUs), POS (point of sale) devices and hand-held devices of various kinds are very common forms of in-store technologies that were used by retailers. Retailer B explained the PDA's ability to remotely scan product barcodes, allowing them to scan the price and other information, prepare price change tickets, print labels right-away via a Wi-Fi device. Retailers C, D, H and I have smartphone apps with autonomous reporting on sales, inventory, sales target by state, including Planograms (a visual representations of each retail store's products), and alerts in real time that was shared by cross functional teams. The Retailer I explained how much individual item barcodes (closed standard) have helped them in in-store environment, especially in pricing perishables (e.g., meat, deli products) to make it fast and easy for them and the customers. Retailer G stated that they were currently barcode driven, but their global team was contemplating moving on the direction of RFID soon to improve accuracy of data communication to improve service level.

Retailer J in fuel retail spoke of a unique IoT application. Their underground fuel tanks have sensors fixed in them to track the stock. The sensors automatically feed the computer in the store, as well as the central operations at the head-office to monitor the fuel availability. It will send alerts in an unusual event such as theft, the fuel level that gets below a predetermined level, and the system indicates that the order needs to be dispatched and calculates when the next fuel trip is needed.

In the restaurant industry Retailer E believed that IoT had revolutionised the industry, for example, by using iPads to take orders. The restaurant owner further went on to explain their reconciliation system, where they registered the incoming stock using their app connected with supplies and the sales of the day to figure out the stock in hand and even a planning for the day. They have a refrigerator that is connected so that the temperature can be monitored and controlled through the phone remotely.

Retailer G has people to count the number of people who come in and out, and "sale through information" by using facial recognition, which were monitored and analysed by the head offices in real time. Retailers G, K and J had motion tracking as surveillance. Incidentally all other retailers use the simpler remote video surveillance.

Utilisation of IoT devices for identification, tracking, payroll attendance and access control was discussed as a growing trend by many interviewees of which seven were of spoke on this same theme. Out of which four employed FOBs (keyless entry devices). Retailer K explained the advantage of such application as they could digitally identify, record, monitor, track and trace each register entry in a central database along with centrally update new identities for all scanners simultaneously. Retailer K (in security and surveillance technology trade) stated that they used facial recognition (one of their own products) for access control. Retailer D spoke of how IoT had improved its internal cross functional communication.

#### 4.4 How IoT helps in customer integration process

Retailers in general deliberated IoT as an application for them to connect with their customers and improved their services with lots of optimism about the future potential.

"In retail, IoT help interacting directly with the consumers. At the end, we can get the right data and communicate that effectively in terms of better service level for the customers" [Retailer G].

Customer integration generally seem to be well benefited by the current IoT disruption. The major themes were around in-store operations, understanding customers, promotions, improving the online presence, picking and despatch, deliveries, receiving and improving ratings.

IoT helps improving customer services in many forms. Except e-tailer L, all other retailers expressed the theme of IoT in store applications helping in customer interactions. Nine retailers discussed the barcoding and POS devices to improve speed and convenience for customers. Retailer I revealed that self-checkouts had made it fast and convenient to the customer. Retailers C and I explained that individual item barcodes on perishable products made the customer check-outs more convenient. Retailer J further mentioned about a self-checkout phone app that was piloted where, "You take your stuff, scan them and put them in the basket and walk out". Product availability due to real-time data sharing, lost sale reduction and customer retention were a theme discussed by six retailers. The way digital payment methods have had reduced the hard currency circulation was discussed by seven retailers. Retailers spoke of the role of EFTPOS machines to bring the digital currency in to the market and now the wireless version making it even more convenient. Some spoke of evolving options from a magnetic strip in bank cards to pay-wave via an electronic chip (tap and go options via NFC (near field

communication), while others spoke of payment via mobile phones such as *Apple Pay* and smart watches. Retailer J mentioned an app recently introduced by a competitor that enabled the customers to pay for the fuel at the pump without going into the teller.

Understanding customer needs captured by IoT devices is a theme discussed by seven retailers. Combining POS data with reward cards to analyse demographics of the customer was brought up by many. However, Retailer G's system seems to be very advanced, where it captures video data of people walking into the stores to identify their age and their product preference. Data captured via POS systems and people counters are used together to identify customer needs and conduct a thorough forecasting. Retailer G revealed that they used IoT based facial recognition to demographically customise in-store advertisements of their products. Retailer K explained the scenario and confirmed that they themselves had installed facial recognition to influence customer behaviour in many retail stores.

Eight retailers spoke of exploiting IoT, of which four specifically on smartphone apps, as a means to reach the potential customers for promoting products. Another key theme discussed by six retailers is about IoT location services, specifically on smartphones helping to find nearest or specific store locations and GPS directions to get there. Retailers A, D, E, G, H and L spoke of having pervasive devices (e.g. smart phone) in customer hands that positively affected their sales. When an online order has been received, IoT ensures accurate and timely picking to enable speedy despatch discussed by four retailers who ran online operations.

Eight retailers discussed that IoT helped their customer order delivery operations. All eight retailers had their delivery operations outsourced. Out of which six customers discussed about visibility as a key benefit IoT provided to the customers. Thus, four managers stated that the customers could track their delivery by logging in to the portal. Providing good route options to deliverers is another key feature discussed by four retailers. Shorter path, optimised destination sequence, avoiding traffic chaos, and order cancellation are some advantages discussed within this theme. Five retailers spoke on the theme of IoT as a tool to receive or improve customer ratings. The communication with consumers through smartphone app though in its infancy, its capabilities are increasingly exploited and engaged for customer integration.

#### 4.5 Additional capabilities of IoT in supply chains

The additional capabilities, IoT brought into supply chain operations for greater integration, were themed under visibility, auto-capture, intelligence and improved communication. The key value identified by ten retailers was improved visibility due to its pervasiveness. More importantly, six managers specifically emphasised IoT as an enabler for real-time visibility.

As retailer H stated, "Everyone is looking at getting real time information into the system. That's why IoT is so important for us". Seven retailers highlighted how IoT helped auto-capture data to reduce the labour requirement. Ten managers confirmed better understanding of suppliers and customers by extracting values (e.g. intelligence) from data captured by IoT. Five managers voiced positive on real-time streaming analytics, as a modern element of IoT platform. Incidentally six retailers declared that having IoT devices in their supply chain improved communication between supply chain partners.

"IoT is enabling us to communicate better with 3PLs, customers or supplies" [Retailer C].

It is evident that these additional capabilities of IoT perform beyond generic ICT on supply chain integration (SCI).

#### 4.6 How IoT-enabled SCI affects supply chain performance

All twelve (12) retailers spoke positively about the outcomes of IoT currently deployed in their retail stores and their transport to improve supply chain performance. These key performance outcomes were grouped under operational performance elements like cost, quality, delivery and flexibility. Cost reduction is a key supply chain objective discussed by all participating managers. Cost savings and efficiency improvement (10), productivity (9), optimisation (8), energy saving (6), time saving (7), reduction of inventory (5) and wastage reduction (3) emerged as key themes. All twelve interviewees cited quality improvement in the name of service quality (10), accuracy (8), customer service (8), convenience (6), safety (5) and product quality (5). Nine managers voiced delivery speed (5), and timely deliveries (4) as key themes under delivery standard improvement. Ten managers cited IoT having a positive effect on flexibility of their operations.

#### 4.7 How IoT-enabled supply chain performance affects firm sustainable performance

Interviewees suggest that IoT-enabled integration improves firm performance. All agreed about its effect on triple-bottom lines of firm sustainability. All managers thought IoT deployment in supply chains affected positively their economic performance like company growth (12), sales growth (9), customer satisfaction (7), lost sales reduction (6), customer trust (5), customer retention (5), brand reputation (4), cost reduction (10), return of investments (4), and competitive edge (4). Retailer I explained that integration of technologies such as IoT and blockchain into the logistics operations could improve brand integrity, credibility and brand trust.

All twelve managers believed that IoT deployment in their supply chain operations could make their firm more environmental friendly. IoT impact on environment was diverse with declining paper use as the most discussed theme (9), followed by reduction of carbon footprints (6), electricity saving (6) and wastage minimisation (3). Reverse supply chains discussion was sparse.

Eleven managers spoke of on social sustainability theme. Under the theme, safety (7) was the key theme, with job satisfaction (5) and ease of use (4). Retailers H and I spoke of having these technologies in place to take a pride among staff members. Creating communities, specifically via smartphones, was a theme surfaced by four retailers.

Five retailers discussed about freeing up time to focus on more productive and innovative activities. Ten managers spoke of IoT as tool to improving their planning.

### 5 Discussion

This exploratory study aims to investigate the use of IoT in integrating the supply chain processes across retailers. The findings indicate that IoT enables supplier, internal and customer processes in Australian retail firms influencing the performance. Thematic analysis shows that all participants had clear understanding of IoT technologies in their retail operations. Despite the IoT technologies being in its early stage of adoption (Xu, He, & Li, 2014), this qualitative study reveals that it has significant presence in select retail operations. These findings are in consistent with the earlier study by the authors, de Vass et al. (2018), where all interviewees denoted the promise of IoT as a valuable means to further integrate their supply chains. The findings of the earlier empirical study suggest that IoT capability positively affects the supplier, internal and customer integration processes that eventually improved the firm performance. The findings support several IoT related conceptual discussions, notions and arguments in the literature on its affirmative effect on SCI. For example, Ping et al. (2011)'s conceptual discussion; Yan et al. (2014)'s proposal on intelligent supply chain integration; Reaidy, Gunasekaran, and Spalanzani (2015)'s study on order fulfilment in warehouse, and more importantly de Vass et al. (2018)'s survey-based empirical study.

The study also finds that IoT-enabled SCI positively affects supply chain performance via cost, quality, delivery, and flexibility dimensions that can be attributed to IoT added capability of auto-capture, visibility (real-time), intelligence and improved communications. The exploratory findings back up the earlier scholars' arguments that emerging IoT platform is capable of improving the performance of supply chains. However, when it comes to IoT conceptualised capabilities of intelligence and automation (Constantinides et al., 2017), the potential is yet to be realised by the sampled retailers.

The thematic findings indicate that IoT-enabled supply chain performance has positive effect on firms' sustainable performance. Therefore, IoT deployment can be considered as a supply chain strategy with environmental, social, and economic goals to allow organisations to achieve its triple bottom lines of sustainability (Carter & Rogers, 2008; Elkington, 1997).

These findings are in consistent with the findings of prior organisational capability perspectives (Huo, 2012; Rai et al., 2006), where strengthening of a higher-order integration capability has an impact on performance. This study argues that IoT deployment can enhance digitally enabled SCI, improves supply chain performance, and eventually the firm's triple bottom lines of sustainability. This study offers an understanding of IoT technologies the way operates, progresses and benefits the business operations. IoT represents a next big leap in ICT system and likely to open up exciting opportunities through the vast deployment of embedded devices (Miorandi, Sicari, De Pellegrini, & Chlamtac, 2012).

Theoretically, this qualitative study is first of its kind so far in dealing with interviews to investigate the IoT use across retail sector. The study contributes to a small cluster of qualitative interdisciplinary exploratory body of knowledge that explains the complex role of IoT across multitude of supply chain processes. While the literature is extravagant with the potential benefits of IoT, no studies so far investigated the ground reality of IoT use. This fills the knowledge gap at the intersection of supply chain

and IS literature by establishing the fact that IoT-enabled SCI improves firm performance. Practically, the qualitative findings from the retailers provide interesting insights to practitioners in the field of supply chain and IS. The thematic findings offer insights and intelligence that arise from the investment of IoT where managers, industry associations and policy makers are highly benefited. Managers need to understand the power of IoT while deciding on any investment on logistics operations. Policy makers' understanding of IoT technologies will influence a sound public investment of these emerging pervasive technologies.

## 6 Conclusion

The effect of IoT on SCI and firm performance is quantitatively validated in a prior framework-based study. However, descriptive evidences to explain the role of IoT in current supply chain context is vital to better understand the phenomenon. The findings of this semi-structured interview-based qualitative study of 12 retailers provided detailed support for how IoT-enabled SCI influences supply chain and firm performance. The confirmation that IoT not only integrates internal logistics but also external partner (i.e. suppliers and customers) integration that influences positively on cost, quality, delivery, and flexibility of the entire supply chain to improve firm's sustainable performance with financial, social and environmental outcomes. The study opens up status quo of IoT technologies in Australian retail supply chains, and how they are deployed to strengthen SCI. IoT additional capabilities of supporting visibility, auto-capture, intelligence, and inter-and intra-firm communication are perceived to be accountable for this performance improvement in the current supply chain context.

There are some limitations in this study. First, the drivers, constraints and enablers of IoT adoption were given a little consideration. Although twelve retail cases are adequate enough to consolidate a phenomenon, the current findings are generalizable within the cases only. The equitable cases from each retail group are proposed in a study ahead to get a more evidence for generalisation. Second, even though IoT is discussed for its potential to track and trace entities throughout the supply chain (Kiritsis, 2011; Lianguang, 2014), the study explored its ability only from the unilateral focal retailers perspective. Therefore, exploring IoT capability from other firms in the supply chain (e.g. distributors, transporters) will reveal its most touted capability of sensing, capturing, and communicating data with others. A survey study grounded on qualitative findings will be appropriate for this purpose.

## References

- ABS\_ANZSIC. 2013. Australian and New Zealand Standard Industrial Classification (ANZSIC), 2006 (Revision 2.0). Retrieved from <http://www.abs.gov.au/ausstats/abs@.nsf/Latestproducts/42D687FA072ACCC6CA257B9500133B9B?opendocument>
- Alfalla-Luque, R., Medina-Lopez, C., & Dey, P. K. 2013. 'Supply chain integration framework using literature review'. *Production Planning & Control*, 24(8-9), 800-817.
- Atzori, L., Iera, A., & Morabito, G. (2010). 'The Internet of Things: A survey'. *Computer Networks*, 54(15), 2787-2805.
- Balaji, M., & Roy, S. K. 2017. 'Value co-creation with Internet of things technology in the retail industry'. *Journal of Marketing Management*, 33(1-2), 7-31.
- Ben-Daya, M., Hassini, E., & Bahroun, Z. 2017. 'Internet of things and supply chain management: a literature review'. *International Journal of Production Research*, 1-24.
- Borgia, E. (2014). 'The Internet of Things vision: Key features, applications and open issues'. *Computer Communications*, 54, 1-31.
- Carter, C. R., & Rogers, D. S. 2008. 'A framework of sustainable supply chain management: moving toward new theory'. *International Journal of Physical Distribution & Logistics Management*, 38(5), 360-387.
- Constantinides, E., Kahlert, M., & de Vries, S. A. 2017. 'The relevance of technological autonomy in the acceptance of IoT services in retail'. Paper presented at the 2nd International Conference on Internet of Things, Data and Cloud Computing, ICC 2017.
- Creswell, JW & Poth, CN 2017, *Qualitative inquiry and research design: Choosing among five approaches*, Thousand Oaks: SAGE Publications.
- Cui, Y. 2015. 'Improving Supply Chain Resilience with Employment of IoT'. Paper presented at the International Conference on Multidisciplinary Social Networks Research.
- de Vass, T., Shee, H., & Miah, S. J. 2018. 'The effect of "Internet of Things" on supply chain integration and performance: An organisational capability perspective'. *Australasian Journal of Information Systems*, 22.
- Dweekat, A. J., & Park, J. 2016. *Internet of Things-Enabled Supply Chain Performance Measurement*

- Model*. Paper presented at the Industrial Engineering, Management Science and Application (ICIMSA), 2016 International Conference on.
- Elkington, J. (1997). Cannibals with forks. *The triple bottom line of 21st century*.
- Haddud, A., DeSouza, A., Khare, A., & Lee, H. 2017. 'Examining potential benefits and challenges associated with the Internet of Things integration in supply chains'. *Journal of Manufacturing Technology Management*, 28(8), 1055-1085.
- Hofmann, E., & Rüsçh, M. 2017. 'Industry 4.0 and the current status as well as future prospects on logistics'. *Computers in Industry*, 89, 23-34.
- Huo, B. 2012. 'The impact of supply chain integration on company performance: an organizational capability perspective'. *Supply Chain Management: An International Journal*, 17(6), 596-610.
- Kim, H. J. 2017. 'Information technology and firm performance: the role of supply chain integration'. *Operations Management Research*, 10(1), 1-9.
- Kiritsis, D. 2011. 'Closed-loop PLM for intelligent products in the era of the Internet of things'. *Computer-Aided Design*, 43(5), 479-501.
- Li, G., Yang, H., Sun, L., & Sohal, A. S. 2009. 'The impact of IT implementation on supply chain integration and performance'. *International Journal of Production Economics*, 120(1), 125-138.
- Lianguang, M. 2014. Study on supply-chain of modern agricultural products based on iot in order to guarantee the quality and safety. *Advance Journal of Food Science and Technology*, 6(4).
- Liu, W., & Gao, Z. 2014. 'Study on IOT based architecture of logistics service supply chain'. *International Journal of Grid and Distributed Computing*, 7(1), 169-178.
- Liu, X., & Sun, Y. 2011. 'Information Flow Management of Vendor-Managed Inventory System in Automobile Parts Inbound Logistics Based on Internet of Things'. *Journal of Software*, 6(7), 1374-1380.
- Majeed, A. A., & Rupasinghe, T. D. 2017. 'Internet of things (IoT) embedded future supply chains for industry 4.0: An assessment from an ERP-based fashion apparel and footwear industry'. *International Journal of Supply Chain Management*, 6(1), 25-40.
- Miorandi, D., Sicari, S., De Pellegrini, F., & Chlamtac, I. 2012. 'Internet of things: Vision, applications and research challenges'. *Ad Hoc Networks*, 10(7), 1497-1516.
- Mishra, D., Gunasekaran, A., Childe, S. J., Papadopoulos, T., Dubey, R., & Wamba, S. F. 2016. 'Vision, applications and future challenges of Internet of Things'. *Industrial Management & Data Systems*, 116(7), 1331-1355.
- Ping, L., Liu, Q., Zhou, Z., & Wang, H. 2011. *Agile supply chain management over the internet of things*. Paper presented at the Management and Service Science (MASS), 2011 International Conference on 2011 Aug 12.
- Rai, A., Patnayakuni, R., & Seth, N. 2006. 'Firm performance impacts of digitally enabled supply chain integration capabilities'. *MIS Quarterly*, 30(2), 225-246.
- Ready, P. J., Gunasekaran, A., & Spalanzani, A. 2015. 'Bottom-up approach based on Internet of Things for order fulfillment in a collaborative warehousing environment'. *International Journal of Production Economics*, 159(1), 29-40.
- Whitmore, A., Agarwal, A., & Da Xu, L. 2014. 'The Internet of Things—A survey of topics and trends'. *Information Systems Frontiers*, 17(2), 261-274.
- Wieland, A., & Marcus Wallenburg, C. 2012. 'Dealing with supply chain risks'. *International Journal of Physical Distribution & Logistics Management*, 42(10), 887-905.
- Xu, L. D., He, W., & Li, S. 2014. 'Internet of Things in industries: A survey'. *Industrial Informatics, IEEE Transactions on*, 10(4), 2233-2243.
- Yan, J., Xin, S., Liu, Q., Xu, W., Yang, L., Fan, L., . . . Wang, Q. 2014. 'Intelligent supply chain integration and management based on Cloud of Things'. *International Journal of Distributed Sensor Networks*, 10(3), 1-15.
- Yu, W. 2015. 'The effect of IT-enabled supply chain integration on performance'. *Production Planning & Control*, 26(12), 945-957.

**Copyright:** © 2018 authors. This is an open-access article distributed under the terms of the [Creative Commons Attribution-NonCommercial 3.0 Australia License](https://creativecommons.org/licenses/by-nc/3.0/), which permits non-commercial use, distribution, and reproduction in any medium, provided the original author and ACIS are credited.

# Impacts of Digital Natives on Technology Acceptance: A Conceptual Analysis

## Tim Hamelmann

University of Duisburg-Essen  
Essen, Germany

Email: [tim.hamelmann@uni-due.de](mailto:tim.hamelmann@uni-due.de)

## Andreas Drechsler

School of Information Management  
Victoria University of Wellington  
Wellington, New Zealand

Email: [andreas.drechsler@vuw.ac.nz](mailto:andreas.drechsler@vuw.ac.nz)

## Abstract

We seek to identify the impacts Digital Natives (DN) – as the first generation that has grown up with new digital technologies such as the Internet from their childhood – have on technology acceptance (TA) by investigating the effect of DN' specific traits, abilities, and experiences on TA factors and variables. We conduct two literature reviews: the first about TA factors and variables and the second about DN and generational differences. We find that some TA factors and variables that prior research has pointed out as significant are likely to change in importance: DN do not question the use of technology itself and may be at least partially familiar with it but simultaneously have higher demands for the quality and usefulness of technology. Researchers can draw on our findings to validate them empirically in the future or problematize the current state of TA research. Practitioners can apply our findings to develop information systems that DN find attractive to use.

**Keywords** technology acceptance, information systems acceptance, digital natives, digital immigrants, generational differences

## 1 Introduction

Today, information systems (IS) are an essential component of every enterprise's architecture. However, an IS cannot be successful if the users do not use it (Davis et al. 1989). Thus, technology acceptance (TA) is an important aspect for the success of IT investments, which is why a plethora of prior research has addressed TA (Marangunić and Granić 2014). Davis et al. (1989) have published their initial Technology Acceptance Model (TAM) almost 30 years ago and it has become the most widely used theory IS researchers draw on to investigate the human behaviour with respect to TA (Bradley 2012), despite numerous criticisms directed at TAM itself and TA research in general (Bagozzi 2007; Lee et al. 2003).

Not covered by these criticisms, however, is generation research's tenet that human behaviour does not stay invariant over generations (Hurrelmann and Albrecht 2014). Generation research tries to group people by their age or life circumstances in order to assign them to a certain generation. It also tries to elucidate specific traits of these generations and makes assumptions about their behaviour and thinking in order to identify generational differences and societal changes. In generation research, Digital Natives (DN) is a term used to describe all people that grew up with new digital technologies (e.g., the Internet) and therefore "process information fundamentally different from their predecessors" (Prensky 2001a, p. 1). Prensky also introduced a complementary term – the Digital Immigrants (DI) – for people during whose life technologies such as the Internet have just been established and who had to learn how to deal with them (Günther 2007; Prensky 2001a). DN represent a technology-savvy generation that appreciates using digital technology (Ferri-Reed 2014). It is normal for them to use digital technology to solve problems, to manage their everyday life, and to communicate with other people. The literature posits that this generation is fundamentally different from previous generations, especially with respect to their acceptance of digital technology. Prensky (2001a) speaks of a 'digital language' which DN learn early in their life, while DI had to learn it later and always retain a 'DI accent'. Some researchers even postulate the end of technology denial in this new generation (Solnet et al. 2012).

Therefore, it is at least questionable if prior TA findings – which are mainly based on the DIs' behaviour and also make up quite a substantial body of IS research – will retain their validity in the future. More fundamentally, as digital technology may even become part of DN's individual identities (Carter and Grover 2015), the question arises whether the traditional assumptions of TA research (e.g. individuals encounter unfamiliar technology) are still valid. To investigate this issue further and to contribute to closing the gap between IS TA research of the past and upcoming generational change, we set out to answer the following three research questions:

*RQ1: What are DNs' characteristic personality traits and attitudes?*

*RQ2: What factors and variables influence TA that could be affected by DNs' traits and attitudes?*

*RQ3: How do the identified DNs' traits and attitudes affect these TA factors and variables as well as the underlying assumptions, and what are implications for future TA research?*

We conduct two literature reviews to answer our research questions, which follow Webster and Watson's (2002) and Okoli's (2015) suggestions. The first one in Section 2 identifies DNs' personality traits and attitudes by searching for different terms from generation research such as "Digital Natives", "Generation Y", or "Millennials" across databases that span disciplines such as IS research, computer science, business administration, management, psychology, and sociology. Search results that were not conducive to be linked to TA research in the organisational context were not pursued further.

For the second one, we first draw on a literature review paper that already summarizes major parts of TA research in a comprehensive model (Sorgenfrei et al. 2014). We then extend their literature coverage in Section 3 by searching for topics like DN, generation issues, or social aspects in connection with TA, in order to gain further insight into TA factors that are related to personality traits and attitudes. Here, TA theories that do not contain factors based on personality, emotion, or the organizational situation were excluded from our scope.

Following Rowe's (2014) suggestions, we then match our synthesized findings in the form of the variables and factors that influence TA and the DNs' personality traits and attitudes with each other and critique the former against the latter in Section 4. We then discuss our findings and the implications of considering DN for future TAM research and TA theorizing in Section 5. We conclude and give a brief outlook towards future research in Section 6.

## 2 Digital Natives – Traits, Personality, and Behaviour

This section synthesizes the results of our literature review about DN and their traits across several areas we identified to be emphasized in the literature. We start with aspects related to the individual and move



on further to work environments, and DN's roles in and general fit to organizations. Note that the term 'Digital Native' is related to other terms from generation research: 'Generation Y', 'Millennials', 'Generation Me', or 'Net Generation' (Appel 2013; Butler and Sauser 2013; Hurrelmann and Albrecht 2014; Parment 2013; Twenge 2010). However, the terminology and birth years to delimit these generations from others vary among authors. For this reason, we follow Appel (2013) and use the term DN to highlight this group's most important trait: their changed way to use technology, irrespective of their exact birth years. Table 1 summarises key DN characteristics from the literature.

<b>Digital Natives...</b>	
and technology	<ul style="list-style-type: none"> <li>• are more well-educated and technophile than previous generations (Han and Su 2011).</li> <li>• are more impatient and have a higher need of instant response (Andone et al. 2006; Butler and Sauser 2013).</li> <li>• have their strategic thinking shaped by technology being a key part of their personal and social life (Andone et al. 2006).</li> <li>• have mastering digital technology as a natural, special, distinctive, and sustainable skill that encompasses learning-by-doing and internet searches (Prensky 2001a).</li> </ul>
and information processing	<ul style="list-style-type: none"> <li>• value instant access to information, preferably visualised (Prensky 2001a).</li> <li>• like to receive information little by little (Han and Su 2011).</li> <li>• can process information more quickly than previous generations (Butler and Sauser 2013).</li> <li>• strew their attention to scan contents very fast in order to find the important and relevant pieces of information (Ziehe 2013).</li> <li>• may have difficulty focusing on a single task but can cope with information overload and a volatile and fast-changing world (Ziehe 2013).</li> <li>• tend to be better at multitasking than DIs (Andone et al. 2006; Prensky 2001b).</li> </ul>
and personality traits and values	<ul style="list-style-type: none"> <li>• live in a globalized world and face higher pressure and increasing uncertainty than previous generations (Hurrelmann and Albrecht 2014).</li> <li>• tend to seek at least a small amount of security and stability (Günther 2007).</li> <li>• tend to be alert, attentive, aware of their problems, concentrated, and like to have things under control (Tapscott 1998).</li> <li>• have a higher IQ than DI on average (Günther 2007) and tend to be more well-educated (Han and Su 2011; Hurrelmann and Albrecht 2014).</li> <li>• have an inquisitive mind due to having grown up in an environment in which they were allowed to ask questions, to provoke, and to express individual opinions (Tapscott 1998).</li> <li>• tend to be very self-confident, and more selfish and even narcissistic compared to previous generations (Ahn and Etnner 2014; Twenge and Campbell 2008).</li> <li>• are therefore good at critical thinking and being more outspoken than DIs (Tapscott 1998).</li> <li>• have developed a comparably higher degree of sovereignty and self-reliance due to facing problems and uncertainty earlier in life (Tapscott 1998).</li> <li>• may have experienced taking different roles early in their life (for example in chatrooms or online games) but are also less able to reflect their own behaviour and to learn from their experiences (Prensky 2001b).</li> <li>• perceive themselves to be different from DI (Butler and Sauser 2013).</li> </ul>
and work attitudes and behaviour	<ul style="list-style-type: none"> <li>• value a good work-life-balance including free time more highly than DI (Twenge 2010).</li> <li>• seek to find more satisfaction, meaningfulness, and fulfilment in their work than previous generations (Günther 2007; Hurrelmann and Albrecht 2014; Parment 2013).</li> <li>• are impatient and live in a "quick-payoff world" (Prensky 2001b).</li> <li>• may be seen as having a weaker work ethic and being more difficult to motivate than previous generations (Twenge 2010).</li> <li>• tend to be satisfied with their job and are loyal until they find a better offer (Hurrelmann and Albrecht 2014; Kowske et al. 2010; Twenge 2010).</li> <li>• are flexible, able to adapt to change quickly (Günther 2007), and innovative (Tapscott 1998). They tend to ask "Why not?" rather than "Why?" in the face of change.</li> <li>• appreciate diversity and collaboration (Han and Su 2011) and care less about gender and social differences (Tapscott 1998) than previous generations.</li> <li>• prefer collaborative decision-making and teamwork (Hernaus and Vokic Pološki 2014) but are also good in doing things on their own (Martin 2005).</li> <li>• tend to assess other persons by their contribution and the ideas they bring in and thus decrease classic barriers of team work (Tapscott 1998).</li> <li>• take electronic collaboration for granted (Andone et al. 2006; Solnet et al. 2012).</li> <li>• have a low affinity to assume management responsibility positions (Twenge 2010).</li> </ul>
and organisational	<ul style="list-style-type: none"> <li>• want to work in highly motivated, committed and goal-oriented teams (Martin 2005).</li> <li>• value friendship and good relationships with their colleagues more highly than previous generations (Solnet et al. 2012) and are less rivalry-oriented (Tapscott 1998).</li> <li>• can adapt to continuously changing teams over their working life (Günther 2007).</li> </ul>

structures and culture	<ul style="list-style-type: none"> <li>• may have trouble working in multi-generational teams (Anantamula and Shrivastav 2012).</li> <li>• may not necessarily fulfil tasks without asking questions as it is necessary for them to understand what they do and why they do it. They may simply say “no” if they are not sufficiently convinced (Parment 2013).</li> <li>• value employee engagement, transparency, and an emotional and intellectual openness more highly than DI, and managers must be willing to explain tasks and answer questions (Parment 2013; Solnet et al. 2012; Tapscott 1998).</li> <li>• require a more emotional component to their management (Günther 2007).</li> <li>• want to be independent and work on their own authority (Czichos 2014).</li> <li>• struggle in strong hierarchies (Hurrelmann and Albrecht 2014).</li> <li>• want to keep learning things during their work life (Hurrelmann and Albrecht 2014) or they may become easily bored (Solnet et al. 2012).</li> <li>• prefer interactive and physically or virtually connected learning opportunities (Andone et al. 2006).</li> </ul>
------------------------	---

Table 1. Key characteristics of Digital Natives

### 3 A Technology Acceptance Analysis Framework

In this section, we now synthesize the current state of TA research into an analysis framework, which we use subsequently to contrast antecedents and contextual factors for TA with DNs’ characteristics.

There is a considerable amount of literature reviews on TA research (Bradley 2012; Hwang et al. 2015; Lee et al. 2003; Legris et al. 2003; Marangunic and Granic 2014; Sorgenfrei et al. 2014; Venkatesh et al. 2003; Williams et al. 2009). Our challenge therefore is finding an adequate focus on relevant aspects for our research scope. After careful consideration, we draw on Sorgenfrei et al.’s (2014) TA reference framework, which synthesizes different TA and adoption-related research streams into one comprehensive framework. Their framework’s scope encompasses the most relevant theories for TA: Theory of Reasoned Action, Theory of Planned Behaviour, the Technology Acceptance Model (TAM), Innovation and Diffusion Theory, Model of Computer Self-Efficacy, Unified Theory of Acceptance and Use, IS Continuance Model, IS Success Model, and Task-Technology-Fit Model. However, we need to tailor their framework further to make it suitable as an analysis framework to answer our RQ2 and RQ3.

First, Sorgenfrei et al.’s (2014) framework distinguishes between different acceptance stages. However, for us, the preconditions and beliefs are most relevant because they are based on personality traits and social aspects, which then can be linked to DNs’ traits. Therefore, we omit any distinction between different acceptance stages. Second, their framework distinguishes five categories of antecedents and contextual factors for TA: task-related characteristics, technology-related characteristics, individual characteristics, interpersonal factors, and situational factors. The category of task-related characteristics is very distant from social aspects that can be matched with generational traits. Therefore, we do not consider antecedents and contextual factors from this category. Third, our literature review revealed relevant factors that were not part of the original framework, and we add these to our framework.

Figure 1 shows the adapted framework that we will subsequently rely on and call the technology acceptance framework (TAF). We highlight additions over Sorgenfrei et al.’s (2014) framework in italics.

### 4 Matching Digital Natives’ Characteristics and Behaviour with Technology Acceptance Findings

In this section, we now contrast the results of the literature review on DNs from Section 2 with the elements of the TAF from Section 3 to identify the effects DN have on TA.

#### 4.1 Technology-related impacts

First, we analyse the DNs’ impact on their individual beliefs and, subsequently, TA with respect to the technology-related characteristics contained in the TAF. Technology-oriented characteristics focus on the properties of the particular IS that to be accepted.

**Complexity of technology.** Complexity is seen as a characteristic of the technology as perceived by its users (Aizstrauta et al. 2015). As DN are said to have an increased IQ and are well educated, one can expect them to generally fulfil the cognitive requirements to understand a reasonably complex IS. It should also be helpful for the TA process that they are curious, open-minded, process information very

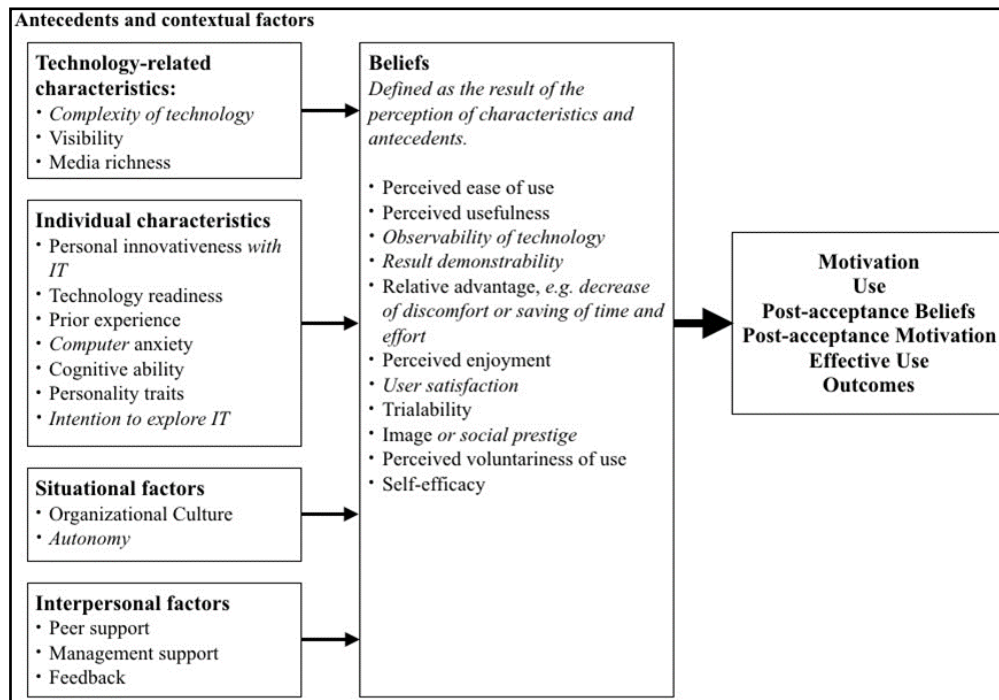

Figure 1. Sorgenfrei et al.'s (2014) TA reference framework adapted for our purposes

quickly, and tend to like exploring IS learning-by-doing. However, a prerequisite for this is that the IS needs to be easy to use – especially with respect to the possibility to explore the system without reading any instructions in a manual. This is important because DN are also attentive and think critically with a questioning attitude. While DI may have learned to arrange themselves with less-than-intuitive user interfaces or workflows, DN expect seamless interactions with technology and can therefore be expected to put up higher and more principled resistance against IS complexity they perceive to be unnecessary. Due to their innovative thinking, they can also be expected to be more willing participants in efforts to redesign and improve IS that they use further. A disadvantage may be that DN strew their attention and maybe perform other tasks in multitasking while they explore a new IS. One option to keep their attention could be enjoyment. Therefore, designing an IS so that using it can be perceived as ‘fun’ may foster DN’s TA, despite the IS’ complexity.

**Visibility.** This factor refers to the degree to which a novel technology is visible or discernible as such in an organization (Karahanna et al. 1999). DN not only value transparency but they also seek to understand what they do and why they do it. Consequently, they will carefully consider to use or not to use an IS and the benefits of using it. Therefore, one would expect that making an innovative and relevant nature of an IS visible to DN would be particularly conducive to foster their TA.

**Media richness.** To catch the DN’s attention, an IS should contain graphics and other visual elements instead of text wherever it makes sense – especially for important data or information the IS displays (Tilvawala et al. 2011). Because DN direct their attention to graphical elements first, their implementation may contribute to avoid the DN’s habit of strewing their attention and to receive information little by little, so that they do not miss out on important data or information. Due to the fact that DN do not always succeed in reflecting their own behaviour this seems to be easier than trying to make DN change the way they process the information that is displayed by the IS.

Taken together, these implications mean that we would expect DN to appreciate IS with particular characteristics over others. In other words, the overall impact of DN’s characteristics on TA seems to be highly dependent on the characteristics of the IS in question, such as its hedonic value or media richness.

## 4.2 Impacts of individual characteristics

Individual characteristics refer to individual traits such as personality traits, experiences, and attitudes. Obviously, these characteristics are of major importance for our analysis because they facilitate establishing a direct link between DN’s personality traits and attitudes and TA (Agarwal and Prasad 1998; Ahuja and Thatcher 2005; Carter et al. 2012; Immonen and Sintonen 2015; Nambisan et al. 1999; Petter et al. 2013).

**Personality traits.** Many of DN's common personality traits foster TA. They are curious, open-minded, innovative, flexible, and used to adapt to change.

**Cognitive abilities.** DN tend to be well-educated and are said to have an increased IQ compared to previous generations. Therefore, they should possess the necessary cognitive abilities to operate unknown IS, which contributes to increased TA.

**Prior experience.** DN use technology extensively, not only in their work life, but also in their free time and their social life. Many DN learn to deal with IT at home and in school before they start their working life, and therefore already possess ample prior experience in using and learning new technology.

**Computer anxiety.** The previously discussed aspects combined with high levels of self-confidence and a willingness to learn lead to an overall low level of computer anxiety for DNs.

**Intention to explore IT.** DN are curious, they like to experience new technology, are self-reliant, and like learn to deal with technology learning-by-doing. Therefore, they possess a predisposition towards exploring new technology.

**Personal innovativeness.** DN have an innovative attitude so they tend to explore technology – especially in order to find new ways to deal with their tasks in a more efficient and enjoyable way.

**Technology readiness.** In sum, we would expect that the DNs' abilities and personality traits make them technology-ready and therefore foster TA.

### 4.3 Impacts of the organizational culture and autonomy

Situational factors represent the outer circumstances and the work environment. Ahuja and Thatcher (2005) emphasize that work environment characteristics can benefit TA.

**Organizational culture.** Jordan and Burn (1997) and Dasgupta and Gupta (2005) highlight the importance of the organizational culture for successful TA. There are several general factors that foster TA within an organization: high motivation, high commitment, collaborative decisions, and an innovative climate. Here, DN demand a transparent organizational culture with good relationships with colleagues, and a flat hierarchy. Their collaborative decision-making can increase network effects as DN tend to accept IS that their colleagues accept as well. Simultaneously, DN struggle with hierarchies and a command-and-control culture. For TA, this points towards a particularly important role of the organizational culture.

**Autonomy.** DN value work autonomy. They want to get tasks done but also want to decide on their own when and how they fulfil them. While a high autonomy can foster individual innovativeness with technology, this DN trait makes managerial control over TA more difficult and may ultimately lead to self-reinforcing positive or negative circles among a peer group of DN users who evaluate the pros and cons of adopting a new technology among themselves while being resistant to external influence by change agents, for instance.

Especially autonomy therefore seems to be a factor of particular importance for TA in the context of DN, while the factors of the organizational culture that DN appreciate also benefit TA and thus one would expect these factors to be aligned with increased TA.

### 4.4 Impacts of interpersonal factors

Interpersonal factors concentrate on the relationships to others as well as on communication and interaction between people and belong to the most important factors for potential technology adopters and users (Karahanna et al. 1999). In particular, positive relationships to managers and co-workers and other social aspects like the team composition are important and should be considered when implementing a new IS (Magni and Pennarola 2008).

**Peer support.** Peer support refers to the degree to which users receive support from their peers for using a particular technology (Petter et al. 2013). Niehaves et al. (2012) emphasize that TA can be increased by network effects in organizations which can be achieved by a strong peer support. Park et al. (2011) point out that facilitating conditions to benefit TA are much more effective on a group-level rather than on an individual level. Here, DN value good relationships to colleagues and prefer collaborative decision-making and working. They are not overly competitive and they assess people by their contribution. All these factors foster a constructive work climate, peer support, and thus TA as well. However, managers should also be aware of possible problems like narcissism, generational differences in teams, and selfish attitudes among DN.

**Management support.** DN demand their managers to be empathic and engaged, but not too overbearing since they demand work autonomy and flat hierarchies, while they are not too comfortable with taking responsibility themselves. This leads to an almost paradoxical situation for managers who may have to find the right balance of attention and 'benign neglect' for their DN employees during TA.

**Feedback.** Answering their questions quickly and giving them instant feedback can be a particularly good way how managers can support TA for DN.

In sum, the interpersonal factors do not only remain important for TA, but the DNs' traits point to a certain configuration of interpersonal factors that may be particularly conducive to TA for DN.

#### 4.5 Impacts of individual beliefs

As mentioned before all the antecedents and contextual factors lead to particular individual beliefs. These beliefs can be seen as a result of preconditions and shape the foundation for the whole process of TA and all its stages.

**Perceived ease of use.** Compared to DI, one can expect DN to perceive using a given IS to be easier, due to their prior experience, high extent of technology use, and good education. DN have been using many different IS over the course of their life, so they know different user interfaces and handling concepts. However, they may also be particularly critical towards not well-designed IS or IS that do not fit their information seeking and processing behaviour. As outlined among the technology-related factors above, one can expect IS design characteristics to influence DNs' perception of ease-of-use.

**Perceived usefulness.** DN work goal-oriented and value efficiency. Therefore, we can expect an IS' usefulness to be very important to them. When they use or even just try out a new piece of technology, they seek a quick pay-off, think strategically, and handle time resources well. Consequently, we would expect the perceived usefulness to continue to play an important role for TA, perhaps even more so than for DI. Moreover, it is likely that DNs' particular information seeking and processing behaviour influences their perception of usefulness compared to DI.

**Observability of technology.** This factor refers to how visible technological benefits are to potential users (Aizstrauta et al. 2015). DNs are inquisitive and curious, especially about technology, and they also process information quickly, with a shortened attention span. To foster TA, IS therefore need to 'advertise' their benefits to DN users quickly to capture their attention and convince them that they are indeed useful for them.

**Result demonstrability.** DNs highly value peer-support and a transparent organizational culture, and they are used to sharing information quickly with their peers. One would therefore expect for result demonstrability to play a noticeable role among DN in affecting TA.

**Relative advantages.** This factor comprises the extent to which technology can decrease its users discomfort or save them time and effort (Aizstrauta et al. 2015). As said before, DN work efficiently, goal-oriented, and can handle time resources well. Thus, they will highly value savings of time and effort. Therefore, we would expect that DNs value relative advantages that new technology brings at least as high as DI, if not even higher, as prerequisites for TA.

**Perceived enjoyment.** DN are curious and want to learn new things. So exploring a new IS could be fun for them. They like enjoyment during work, especially because they seek sense and fulfilment in their work life and not a job with boring tasks. Compared to DI, one could expect DNs placing higher value of the hedonic nature (Van der Heijden 2004) of work-related IS, and therefore for perceived enjoyment to play a bigger role for TA.

**User satisfaction.** Compared to DI, we would expect user satisfaction to play a more important role for DN, as it is influenced by other factors which also could play a more important role such as perceived usefulness or perceived enjoyment. And even after an initial acceptance of an IS, user satisfaction should be monitored throughout the post-adoption phase because DN have a questioning attitude and will criticize the IS or even their managers if they are not satisfied. For instance, a volunteer use could foster satisfaction, too.

**Trialability.** This factor refers to the degree to which potential users can experiment with a new technology before an adoption decision (Karahanna et al. 1999). DN really like to explore new technology and they prefer doing this learning-by-doing. Therefore, they will obviously require trialability of a new IS, which also benefits their habit to explore things little by little and autonomously. Furthermore, they are curious and want to keep learning, so trying out new things without any coercion will make them happy and the increase the chance of TA. To support this process, managers should enhance the

**perceived voluntariness of use**, which is a new separate construct we would like to propose in the context of DN to be examined separately.

**Image or social prestige.** These factors capture how adoption and usage of a technology is compatible with a potential user's social and cultural values and beliefs and how potential users believe it to enhance their social status (Aizstrauta et al. 2015; Karahanna et al. 1999). As opposed to the previous factors, image or social prestige are candidates for factors that may have lost some of their meaningfulness for DN users. DN want to have good relationships to colleagues and do not strive for internal rivalry. They are also more self-confident and not afraid to say what they think and to bring in new ideas. Thus, we would expect DN to care less about these factors during their consideration of new technology than DI.

**Self-efficacy.** This factor addresses how self-confident users feel about their ability to use a particular technology or technology in general (Petter et al. 2013). Many of the previously discussed factors point out that DN will believe in their abilities to use an IS in an efficient and in the intended way. Examining DNs' self-efficacy's role in TA therefore may yield less interesting results than for DI.

## 5 Discussion and Limitations

Our matching of DNs' generational traits with the current state of TA research indeed indicates that several factors influencing TA may have a changed importance in the future for DN than for DI.

On the technological side, the inherent system quality and perceived usefulness, visibility and observability of results and benefits, the system's hedonic value, trialability, and media richness are factors that we posit to play an increased role contributing to TA. These factors highlight that the type of IS that is investigated in a TA study matters. Is it – simply put – an IS developed by DI for DI, which is now to be used by DN? We would presume that the results would be strikingly different if one investigated an IS developed by DN for DN, which is being used by the same group of DN in the same context. On the social side, DNs particularly value the right organizational culture, autonomy, peer support, and feedback, and we posit that these factors increase in importance for TA as well.

For a second group of TA factors, the implications for TA appear more nuanced. While the DNs' increased technology-savviness allows them to handle complex IS more easily, their pragmatic attitude contributes to the rejection of complexity they perceive as unnecessary. For managerial support, the right type of support seems to matter – support that fosters the aforementioned social factors, is ready to supply answers to DNs' critical questions, and refrains from taking a too strong control attitude. The challenge for TA research here will be to (re-)operationalize existing constructs into items that can adequately capture these nuances. In particular, the discussion in the previous section highlights that a mono-dimensional measurement of factors from first two groups may not be sufficient anymore – e.g. one can consider splitting use into hedonic versus instrumental use, or managerial control into a beneficial and a restrictive component.

A third group of TA factors may be of lesser importance in the future – particularly many individual characteristics such as computer anxiety, prior experience, intention to explore technology, technology readiness, self-efficacy, or image / social prestige. Moreover, given that a diminishing importance of at least some of these factors can be empirically supported in the future, the rise of DN in the workforce will at least help simplify TA research models and allow researchers to put the more important and more nuanced factors under closer scrutiny. Simultaneously, given the ongoing technological innovation, even today's DNs will encounter *new types* of digital technology (e.g. wearables, cyborg technologies) they will be initially entirely unfamiliar with based on their upbringing. Therefore, we posit that TA research will keep its general relevance although its emphasis may need to shift to distinguish familiar from unfamiliar aspects of a new technology in case it is not of a fundamentally different technology *type*.

We can also contribute several practical contributions as advice for information systems designers and managers concerned with designing or introducing information systems into organizations with DN:

1. Information systems for DN should be easy to use and designed in accordance with their demand of media richness, quick information processing, and enjoyable use.
2. Managers and change agents should carefully highlight the usefulness of an IS, and be prepared for DNs' critical attitude and relentless questioning.
3. Giving DN work autonomy, trialability and the possibility to learn and evolve can contribute to technology acceptance more so than for DI.
4. Beyond TA, DN generally prefer an organizational culture that fosters good relationships between colleagues, innovativeness, and flat hierarchies.

Of course this advice will not guarantee a successful acceptance of an IS, as individual DN – like DI – are not all the same and situational factors still play a big role. Therefore, managers still have to know their employees, find out about their particular needs, and introduce new IS accordingly. Our four managerial implications above can therefore only inform managerial and IS design decisions.

However, our findings also come with several limitations, some of which are inherited from generation research. A central problem of research about generational differences is the lack of reliable data. While there are a lot of surveys and studies, it is difficult to put them into context. There is simply little comparable and reliable data available about previous generations. Moreover, it is difficult to ascribe particular behavioural or attitude changes to a different generations, because those could also be consequences of general societal changes that affect all generations (Deal et al. 2010). We tried to mitigate this issue by relying not on birth years, but on the use of and familiarity with technology to delineate DN from DI, and by relating the differences to technological influences. Moreover, there are voices that DN-related research is somewhat of a hype and, in sum, too unreliable to truly identify differing traits and values (Bennett et al. 2008; Deal et al. 2010; Matthes and Fülbeck 2014). For instance, there are indications that the extent of ‘digital nativeness’ of an individual depends on the extent of the media exposure in their household and therefore not all millennials are DN (Helsper and Eynon 2010). Furthermore, there may be different ‘sub-generations’ among the DN – first those that have grown up with a computer, then those that have experienced the internet right from the earliest ages, and lastly those that do not know a world without smartphones. Finally, it is difficult to study DNs’ workplace behaviour since many DNs have not fully arrived in the workplace yet. Interestingly, the tendency in IS to rely on student samples may have inadvertently helped to already incorporate DN beliefs and attitudes into TA research, but, again, current TA research does not distinguish DN and DI.

We also inherit common TA research limitations. For instance, most TAM studies focus on a single IS in a specific context at a single point in time (Lee et al. 2003). Thus, generalizability across time and other IS is questionable. There are also doubts about the general accuracy of much TA-related research (Bagozzi 2007). Moreover, we relied on one particular TA framework as a foundation for our TAF (Sorgenfrei et al. 2014). While their model is reasonably comprehensive, it does not cover TA research in its entirety. While our additional literature review may have compensated for this to a certain extent, we are far from claiming complete coverage. Moreover, the different theories underlying the integrated perspectives have different assumptions, perspectives, and boundaries, and the corresponding findings may therefore be incommensurable. Lastly, reducing the findings of generational as well as TA research to their essence carries the danger of over-simplification and reductionism.

## 6 Conclusion and Outlook

We identified characteristic DN personality traits and analysed them with respect to implications for factors affecting technology acceptance. While we could not confirm the postulation that DN will indeed end the denial of TA (Solnet et al. 2012, p. 47), our findings highlight that DNs’ particular traits, abilities and attitudes may nevertheless have a considerable effect on the acceptance of IS and other technology. Investigating whether our conceptual findings and postulations indeed hold true empirically, how the more nuanced consideration of some factors can be empirically operationalised and integrated into the established type of TA research models, and whether some established factors are indeed of lesser importance for DNs’ TA all remain tasks for future research. These tasks, however, may be required to keep TA research findings up-to-date in the light of generational change. Moreover, future TA research can benefit from more expanded perspectives that address the extent of a technology novelty (just a new web app for a routine purpose or a fundamental new technology type such as cyborg technologies?) or acknowledge that some digital technologies may even have become part of DI’s identity and self.

## References

- Agarwal, R., and Prasad, J. 1998. “A Conceptual and Operational Definition of Personal Innovativeness in the Domain of Information Technology,” *Information Systems Research* (9:2), pp. 204–215.
- Ahn, M. J., and Ettner, L. W. 2014. “Are Leadership Values Different across Generations?,” *Journal of Management Development* (33:10), pp. 977–990.
- Ahuja, M., and Thatcher, J. 2005. “Moving Beyond Intentions and Toward the Theory of Trying: Effects of Work Environment and Gender on Post-Adoption Information Technology Use.,” *MIS Quarterly* (29), pp. 427–459.
- Aizstrauta, D., Ginters, E., and Eroles, M.-A. P. 2015. “Applying Theory of Diffusion of Innovations to Evaluate Technology Acceptance and Sustainability,” *Procedia Computer Science* (43), ICTE in Regional Development, December 2014, Valmiera, Latvia, pp. 69–77.

- Anantatmula, V. S., and Shrivastav, B. 2012. "Evolution of Project Teams for Generation Y Workforce," *International Journal of Managing Projects in Business* (5:1), pp. 9–26.
- Andone, D., Dron, J., and Pemberton, L. 2006. *A Dual Device Scenario for Digital Students - DIMPLE*, presented at the IADIS International Conference on Cognition and Exploratory Learning in Digital Age (CELDA 2006).
- Appel, W. 2013. *Digital Natives: Was Personaler über die Generation Y wissen sollten*, Wiesbaden: Springer Fachmedien Wiesbaden.
- Bagozzi, R. P. 2007. "The Legacy of the Technology Acceptance Model and a Proposal for a Paradigm Shift.," *Journal of the Association for Information Systems* (8:4), p. 3.
- Bennett, S., Maton, K., and Kervin, L. 2008. "The 'Digital Natives' Debate: A Critical Review of the Evidence," *British Journal of Educational Technology* (39:5), pp. 775–786.
- Bradley, J. 2012. "If We Build It They Will Come? The Technology Acceptance Model," in *Information Systems Theory*, Springer, pp. 19–36.
- Butler, D. D., and Sauser, W. I. 2013. "Millennials Break Out as the Me Generation: Their Attitudes, Expectations and Fears," in *Managing Human Resources for the Millennial Generation*, W. I. Sauser and R. R. Sims (eds.), IAP, pp. 23–52.
- Carter, M., and Grover, V. 2015. "Me, My Self, and I(t): Conceptualizing Information Technology Identity and Its Implications," *MIS Quarterly* (39:4), pp. 931–957.
- Carter, P. E., Thatcher, J. B., Chudoba, K. M., and Maret, K. 2012. "Post-Acceptance Intentions and Behaviors: An Empirical Investigation of Information Technology Use and Innovation," *Journal of Organizational and End User Computing* (24:1), pp. 1–20.
- Czichos, R. 2014. *Erfolgsfaktor Change Management: Den Wandel im Unternehmen aktiv gestalten und kommunizieren*, (1. Aufl.), Freiburg ua: Haufe.
- Dasgupta, S., and Gupta, B. 2005. "Role of Organizational Culture in Internet Technology Adoption: An Empirical Study," *AMCIS 2005 Proceedings*.
- Davis, F. D., Bagozzi, R. P., and Warshaw, P. R. 1989. "User Acceptance of Computer Technology: A Comparison of Two Theoretical Models," *Management Science* (35:8), pp. 982–1003.
- Deal, J. J., Altman, D. G., and Rogelberg, S. G. 2010. "Millennials at Work: What We Know and What We Need to Do (If Anything)," *Journal of Business and Psychology* (25:2), pp. 191–199.
- Ferri-Reed, J. 2014. "Building Innovative Multi-Generational Teams," *Journal for Quality & Participation* (37:3), pp. 20–22.
- Günther, J. 2007. *Digital natives & digital immigrants*, Innsbruck ua: Studien-Verl.
- Han, D., and Su, X. 2011. "Managing Generation Y: Recruiting and Motivating," in *2011 International Conference on Management and Service Science (MASS)*, , August, pp. 1–4.
- Helsper, E. J., and Eynon, R. 2010. "Digital Natives: Where Is the Evidence?," *British Educational Research Journal* (36:3), pp. 503–520.
- Hernaus, T., and Vokic Pološki, N. 2014. "Work Design for Different Generational Cohorts Determining Common and Idiosyncratic Job Characteristics," *Journal of Organizational Change Management* (27:4), pp. 615–641.
- Hurrelmann, K., and Albrecht, E. 2014. *Die heimlichen Revolutionäre: Wie die Generation Y unsere Welt verändert*, Weinheim: Beltz.
- Hwang, Y., Al-Arabi, M., and Shin, D.-H. 2015. "Understanding Technology Acceptance in a Mandatory Environment A Literature Review," *Information Development* 32(4), pp. 1266–1283.
- Immonen, M., and Sintonen, S. 2015. "Evolution of Technology Perceptions over Time," *Information Technology & People* (28:3), pp. 589–606.
- Jordan, E., and Burn, J. 1997. "Information Systems Acceptance: A Consequence of Cultures," *PACIS 1997 Proceedings*.
- Karahanna, E., Straub, D. W., and Chervany, N. L. 1999. "Information Technology Adoption Across Time: A Cross-Sectional Comparison of Pre-Adoption and Post-Adoption Beliefs," *MIS Quarterly* (23:2), pp. 183–213.
- Kowske, B. J., Rasch, R., and Wiley, J. 2010. "Millennials' (Lack of) Attitude Problem: An Empirical Examination of Generational Effects on Work Attitudes," *Journal of Business and Psychology* (25:2), pp. 265–279.



- Lee, Y., Kozar, K. A., and Larsen, K. R. T. 2003. "The Technology Acceptance Model: Past, Present, and Future," *Communications of the Association for Information Systems* (12:1).
- Legris, P., Ingham, J., and Colletette, P. 2003. "Why Do People Use Information Technology? A Critical Review of the Technology Acceptance Model," *Information & Management* (40:3), pp. 191–204.
- Magni, M., and Pennarola, F. 2008. "Intra-Organizational Relationships and Technology Acceptance," *International Journal of Information Management* (28:6), pp. 517–523.
- Marangunić, N., and Granić, A. 2014. "Technology Acceptance Model: A Literature Review from 1986 to 2013," *Universal Access in the Information Society* (14:1), pp. 81–95.
- Martin, C. A. 2005. "From High Maintenance to High Productivity," *Industrial and Commercial Training* (37:1), pp. 39–44.
- Matthes, S., and Fülbeck, T. 2014. "Ex-Telekom-Manager Sattelberger Warnt: 'Die Jungen Menschen Laufen Den Falschen Göttern Nach,'" *The Huffington Post*, , November 8.
- Nambisan, S., Agarwal, R., and Tanniru, M. 1999. "Organizational Mechanisms for Enhancing User Innovation in Information Technology," *MIS Quarterly* (23:3), pp. 365–395.
- Niehaves, B., Gorbacheva, E., and Plattfaut, R. 2012. "Social Aspects in Technology Acceptance: Theory Integration and Development," in *2012 45th Hawaii International Conference on System Science (HICSS)*, , January, pp. 3149–3158.
- Okoli, C. 2015. "A Guide to Conducting a Standalone Systematic Literature Review," *Communications of the Association for Information Systems* (37:1).
- Park, S.-H. "Sunny," Lee, L., and Yi, M. Y. 2011. "Group-Level Effects of Facilitating Conditions on Individual Acceptance of Information Systems," *Information Technology and Management* (12:4), pp. 315–334.
- Parment, A. 2013. *Die Generation Y: Mitarbeiter der Zukunft motivieren, integrieren, führen*, (2., vollst. überarb. u. erw. Aufl. 2013.), Wiesbaden: Gabler Verlag.
- Petter, S., DeLone, W., and McLean, E. R. 2013. "Information Systems Success: The Quest for the Independent Variables," *Journal of Management Information Systems* (29:4), pp. 7–62.
- Premsky, M. 2001a. "Digital Natives, Digital Immigrants Part 1," *On the Horizon* (9:5), pp. 1–6.
- Premsky, M. 2001b. "Digital Natives, Digital Immigrants Part 2," *On the Horizon* (9:6).
- Rowe, F. 2014. "What Literature Review Is Not: Diversity, Boundaries and Recommendations," *European Journal of Information Systems* (23:3), pp. 241–255.
- Solnet, D., Kralj, A., and Kandampully, J. 2012. "Generation Y Employees: An Examination of Work Attitude Differences," *The Journal of Applied Management and Entrepreneurship* (17:3), pp. 36–54.
- Sorgenfrei, C., Ebner, K., Smolnik, S., and Jennex, M. E. 2014. "From Acceptance to Outcome: Towards an Integrative Framework for Information Technology," *ECIS 2014 Proceedings*.
- Tapscott, D. 1998. *Net kids: die digitale Generation erobert Wirtschaft und Gesellschaft. Growing up digital <dt.>*, Wiesbaden: Gabler.
- Tilwawala, K., Myers, M., and Sundaram, D. 2011. "Design Of Ubiquitous Information Systems For Digital Natives," *PACIS 2011 Proceedings*..
- Twenge, J. M. 2010. "A Review of the Empirical Evidence on Generational Differences in Work Attitudes," *Journal of Business and Psychology* (25:2), pp. 201–210.
- Twenge, J. M., and Campbell, S. M. 2008. "Generational Differences in Psychological Traits and Their Impact on the Workplace," *Journal of Managerial Psychology* (23:8), pp. 862–877.
- Van der Heijden, H. 2004. "User Acceptance of Hedonic Information Systems," *MIS Quarterly* (28:4), pp. 695–704.
- Venkatesh, V., Morris, M. G., Davis, G. B., and Davis, F. D. 2003. "User Acceptance of Information Technology: Toward a Unified View," *MIS Quarterly* (27:3), pp. 425–478.
- Webster, J., and Watson, R. 2002. "Analyzing the Past to Prepare for the Future: Writing a Literature Review," *Management Information Systems Quarterly* (26:2).
- Williams, M. D., Dwivedi, Y. K., Lal, B., and Schwarz, A. 2009. "Contemporary Trends and Issues in IT Adoption and Diffusion Research," *Journal of Information Technology* (24:1), pp. 1–10.
- Ziehe, T. 2013. "Mutmaßungen über die Tiefenwirkung der digitalen Vernetzung," in *Digital Natives*, W. Appel and B. Michel-Dittgen (eds.), Springer Gabler, Wiesbaden, pp. 205–212.

## Copyright

**Copyright:** © 2018 Hamelmann & Drechsler. This is an open-access article distributed under the terms of the [Creative Commons Attribution-NonCommercial 3.0 Australia License](https://creativecommons.org/licenses/by-nc/3.0/au/), which permits non-commercial use, distribution, and reproduction in any medium, provided the original author and ACIS are credited.

# You are now an Influencer! Measuring CEO Reputation in Social Media

## **Julian Marx**

Professional Communication in Electronic Media/Social Media  
University of Duisburg-Essen  
Duisburg, Germany  
Email: julian.marx@uni-due.de

## **Milad Mirbabaie**

Professional Communication in Electronic Media/Social Media  
University of Duisburg-Essen  
Duisburg, Germany  
Email: milad.mirbabaie@uni-due.de

## **Stefan Stieglitz**

Professional Communication in Electronic Media/Social Media  
University of Duisburg-Essen  
Duisburg, Germany  
Email: stefan.stieglitz@uni-due.de

## **Abstract**

We know that reputation in organisational contexts can be understood as a valuable asset that requires diligent management. It directly affects how a firm is publicly perceived, and indirectly, how a firm will perform economically. The establishment of social media as ubiquitous tools of communication have changed how corporations manage their reputation. Particularly CEOs face novel responsibilities, as they deal with their personal image, which at the same time affects the reputation of their firm. Whereas CEO and corporate reputation have been researched isolated from each other, little is known about how a CEO's social media reputation management affects corporate reputation. This research in progress paper aims to emphasise this research gap with a literature review on the current status of reputation management and measurement by means of social media. We further propose a research design that combines sentiment analysis, frequency detection, and content analysis and discuss further research prospects.

**Keywords** Reputation Management, Social Media, Social Media Analytics, IT Strategy

## 1 Introduction

Reputation in an organisational context is noted as an intangible, yet valuable asset that requires management as it directly impacts the stakeholders' perception of a firm (Puncheva 2008). A favourable reputation is a crucial objective for a company. From a business-to-consumer perspective, a positive reputation can offer advantages such as enabling firms to charge higher prices (Klein and Leffler 1981; Roberts and Milgrom 1986), attract more professional applicants (Stigler 1962) and incentivise private investors (Beatty and Ritter 1986). Eventually, a combination of those factors may result in increased financial performance (Deephouse 2000). Scholars have defined corporate reputation as a "perceptual representation of a firm's past actions and future prospects that describes the firm's overall appeal to all of its key constituents when compared with other leading competitors" (Fombrun 1996, p. 72).

The advent of social media has compelled the market to rethink the way in which it organizes business communication (Trainor 2012). As a consequence, reputation management has partly moved from the traditional news media settings towards communication through social media, where customers and patrons can be reached conveniently and cost efficiently (Stieglitz et al. 2014). From a management perspective, firms now face the challenge to oversee and guide these opinions to build, maintain, or protect a favourable reputation. It is therefore imperative that executive managers learn how to steer corporate reputation using social media strategies (Floreddu et al., 2014). This applies not only to their employer's reputation, but also to their own image. CEOs are often perceived as the professional face of the company and an expert in their field (Kietzmann et al. 2011). Scholars have acknowledged that a CEO's reputation affects not only their own career opportunities, but also the reputation of their firm (Hayward et al. 2004; Pamuksuz and Mourad 2016). However, little is known about how a CEO's reputation management in social media affects corporate reputation. Previous studies have concerned either CEO reputation in traditional news media settings (Deephouse 2000), or corporate reputation in social media (Benthaus 2014). Literature about CEO reputation management in social media is immensely underrepresented. Hence our research in progress pursues following research questions:

**RQ1:** *To what extent do dimensions of corporate reputation apply to CEO reputation in social media?*

**RQ2:** *How does CEO reputation in social media deviate from corporate reputation?*

In order to approximate a complete study on the above issue, we have conducted a literature review to map out the state of the art. This research in progress paper aims to put our current status up for discussion, and eventually form the basis of a comprehensive data-driven case study.

The paper is structured as follows: In section 2, we present our literature review on reputation management in social media, with particular consideration of CEOs. Subsequently, in section 3, we propose our research design, which consists of mixed methods to determine reputation indicators using social media data. In section 4, we reflect upon our current progress and share ideas for further research.

## 2 Background

### 2.1 Corporate Reputation Management in Social Media

Reputation covers polarised public opinions about a person or organisation. From a strategic point of view, it can be a valuable non-material asset (Hall 1992) and may shape an enterprise's approach on how to orient further actions (Wernerfelt 1984). Being positively perceived is difficult to imitate by competitors, therefore a strong reputation establishes and maintains competitive advantages (Madhani 2010). Potential customers view it as a crucial factor for the selection of their supplier (Walsh et al. 2009), and are willing to pay more for products and commodities (Dijkmans et al. 2015). Moreover, a positive corporate reputation creates market entry barriers for competitors, nurtures customer loyalty and retention (Nguyen and Leblanc 2001). This enables a firm to attract a wider customer base (Fombrun et al. 2000), which consequently translates into higher earnings (Smith et al. 2010). Stakeholders show increased willingness to purchase company shares, since a good reputation enables the firm to attract higher quality employees and to gain better returns (Chun 2005; Vergin and Qoronfleh 1998). In times of crisis, reputational capital holds the capacity to protect a company (Shamma 2012). According to Fombrun et al. (2000), reputation is a dyadic concept, as it consists of an emotional (affective) and a rational (cognitive) component. Therefore, as shown in figure 1, the authors subdivided corporate reputation into six dimensions, which mirror the spectrum of corporate communication on a content-level.

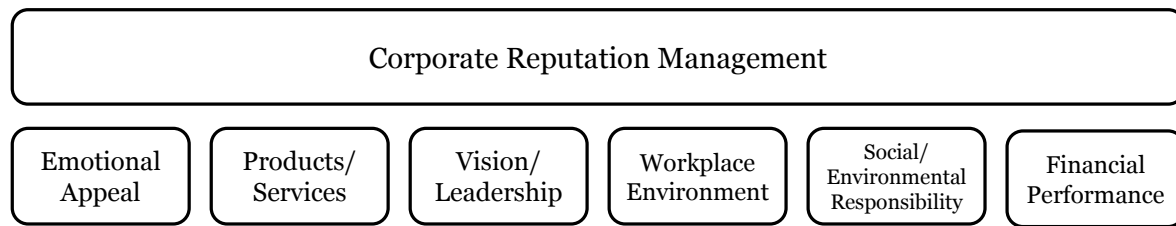

Figure 1: Dimensions of Corporate Reputation (Fombrun et al. 2000)

These dimensions provide a framework for approaching the key components of corporate reputation. Conveying *Emotional Appeal* in a communication strategy may result in positive feelings and respect for the company and eventually increase trust. Presenting *Products and Services* is rather oriented toward marketing and holds the capacity to lead consumers to perceiving an organisation as innovative, expecting high product quality, or to express identification with those products and services. *Vision and Leadership* represents the corporate mission as well as a goal-oriented execution of a company's activities. The impression of a firm to be a popular workplace is part of the Workplace Environment dimension. Addressing *Social/Environmental Responsibility* reflects a firm's commitment to good causes and responsibility towards environment and society. *Financial Performance* indicates an organization to be profitable, and to be capable to outperform competitors. Therefore, it is expected to grow and be of value to shareholders. Scholars have transferred those dimensions into social media settings as they have proven to be eligible segments to categorise social media content (Benthaus 2014). Kaplan and Haenlein (2010) noted that "social media allow firms to engage in timely and direct end-consumer contact at relatively low cost and higher levels of efficiency than can be achieved with more traditional communication tools" (p.67). Facebook, Instagram or Twitter are among the most popular social media platforms for those interactions (Berthon 2012; Funk 2011). Karjaluoto et al. (2016) analysed the relationship between a company's social media reputation and firm performance. Results indicate that companies with an active social media presence tend to have better reputations than companies forgoing social media. As a matter of fact, organisations focus on promoting themselves positively on such channels to support their reputation (Aral et al. 2013). Entering social media as a novel realm of corporate communication comes with several challenges, e.g. the bidirectional communication with the public and low control over what is part of public conversations (Karjaluoto, Mäkinen and Järvinen 2015). A study of Stieglitz et al. (2018a) investigated the reputation management in social media of VW during the rise of the "Dieselgate" scandal. Their results revealed that VW kept silent instead of actively managing their reputation. This emphasises missing confidence to be able to control public opinions and the need for empowering firm's communication strategies. Utilising social media for reputation management results in higher volatility of reputation, as opinions, ideas, or contradictory viewpoints circulate in online social networks with amplified velocity (Dijkmans et al. 2015). Hence, corporate reputation becomes a much more fragile factor than in the pre-social media era. The unexpected virality of user-generated content may either be a blessing or a curse for a company's reputation (Colleoni et al. 2011).

## 2.2 CEO Reputation Management in Social Media

With increasing popularity of social media platforms, companies not only appear with their corporate branding, but also personified in brand pages of their managers, in particular CEOs (Aral et al. 2013). Same as companies, CEOs are entities which seek to convey a positive image of themselves (Mohamed et al. 1999). Through individual social media profiles, CEOs do not only transmit expertise but can also resonate sympathy and become approachable to their stakeholders (Pamuksuz and Mourad 2016). Personal reputation building enables an emotional connection with others, a mechanism which works for CEOs to compete in the internal hierarchy and the external job market (Arruda and Dixson 2007; Chen et al. 2015). CEO reputation differs from corporate reputation as they establish themselves independently. A personal image already exists solely through social interaction and a career prior to the employment in the current profession (Rangarajan et al. 2017). On the one hand, positive personal reputation can be empowering for their managerial authority, and thus, increase their career prospects (Hayward et al. 2004). But on the other hand, negative reputation might reduce managerial power and harms their image (Wiesenfeld et al. 2008). According to Mohamed et al. (1999) there are distinctive tactics how managers balance their reputation, also referred to as *impression management*. Assertive and defensive tactics deal with the active management of positive or negative perceptions. Disclosing private information that mirrors personal viewpoints or the social connection to others are represented as direct and indirect tactics. In general, CEOs utilise these tactics to shape their own image and

minimise the risk of a harmful reputation. As a result, executives such as CEOs experience great responsibility as their personal reputation might not only impact their career, but also the public impression of their firm.

Reputation management of CEOs in social media differs from a traditional media setting. CEOs may pursue an individual publishing strategy, e.g. to regulate the frequency of public appearances rather than depending on editorship. Social media allows them constantly communicate and network on a more customised level (Pamuksuz and Mourad 2016). The impact of social media logics applied to CEOs' reputation poses a number of crucial questions to be examined. Kietzmann et al. (2011) presume a positive CEO reputation to be highly associated with the standing of an executive in a social network. Apart from that, little is known about what metrics define a CEOs reputation in social media. Previous studies have concerned CEO reputation in traditional media settings. Deephouse (2000), for instance, examined the consequences of reputation from a resource-based perspective, such as financial performance and executive compensation, using the volume of coverage in news media as a reputation score. Francis et al. (2008), too, examined CEO reputation in traditional print media and revealed an impact on the earnings quality of a company. However, current literature does not provide sufficient dimensions to characterise the role of CEOs in social media settings, as well as consideration for their impact on corporate reputation.

### 3 Proposed Methods for Researching Reputation in Social Media

In order to approximate an eligible research design to measure CEO reputation and its impact on corporate reputation, we propose a single case study design. The comparative element lies in the superimposition of (1) corporate reputation and (2) CEO reputation over a time period of 16 weeks to oversee short-term volatility. On a conceptual level, we turn to Yin (2003) for an explorative design and to Hays (2004) for validation, e.g. through triangulation. The case should involve a large corporation (e.g. listed as Fortune 500) with corporate and CEO social media branding (>100.000 platform-specific followers). An ideal timing would presuppose a corporate crisis setting as reputation is often socially re-evaluated during times of corporate crisis (Deephouse and Suchman 2008). Our study employs a mixed methods approach, including quantitative sentiment analysis and qualitative content analysis, as shown in figure 2.

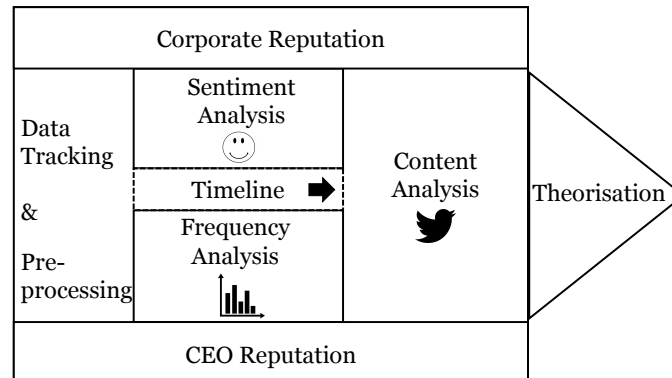

Figure 2: Framework for reputation measurement using social media data

#### 3.1 Sentiment Analysis

To determine the conversational tone about CEOs and their apposite corporation, we suggest conducting sentiment analyses as an initial point of our study. To this end, we require a dataset consisting of a representative set of social media postings. Twitter qualifies as a suitable source of data due to the fact that it frequently hosts bidirectional communication between public figures or organisations and private individuals (Stieglitz et al. 2018b). Moreover, thanks to an open search API, Twitter data is publicly available for research endeavours and other purposes. Using a self-developed Java crawler in combination with an open source library (e.g. Twitter4J) allows it to obtain large tweet samples. Collected data may include original postings as well as forwarding messages that include relevant keywords pointing to the subjects of research, e.g. the name of the CEO/company or synonymous brands or expressions. Extracted data subsequently need further (pre-processing) to be suited for sentiment analyses. An automated analysis with SentiStrength<sup>1</sup> yields values for positive sentiment (1 to 5) and

<sup>1</sup> <http://sentistrength.wlv.ac.uk/>

negative sentiment (-1 to -5). This lexicon-based approach allows to show strong indicators for the overall sentiment of a tweet. As an additional metric, the frequency of mentions should be taken into account. This includes the mere occurrence of keywords as well as Twitter mentions (@username). Using this frequency analysis as an indicator for reputation transfers the approach of Deephouse (2000) onto a social media setting. Once sentiment and frequency are determined, a visualisation in form of two parallel timelines promises valuable findings. If overlapping sentiments follow a similar graph, one could draw conclusions about the correlation of corporate and CEO reputation.

### 3.2 Content Analysis

To achieve a more valid index of reputation and to understand possible fluctuations in the sentiment and frequency graphs, we propose a content analysis of a tweet sample. The tone of voice in public media as measured by means of a sentiment analysis is crucial to assess reputation. However, there are additional dimensions to it such as leadership, strategy, culture, and innovation (Cravens et al. 2003). Following the guidelines of Mayring (2000, 2014), categories for the qualitative assessment of opinions about the corresponding firms may be derived from Fombrun et al. (2000) and Cravens et al. (2003). Since our study approaches the measurement of reputation from a social media data perspective, we target to grasp those dimensions through conducting a content analysis of tweets. If the same categories are applied for classifying the mentions of CEOs, the analysis may reveal whether the dimensions of corporate reputation suit CEO reputation or if additional categories are needed. On Twitter, especially the retweet count indicates the reach and impact of a message (Pal and Counts 2011). Therefore, a ranking of most retweeted postings qualifies as a selection procedure for relevant tweets to build a subsample.

## 4 Conclusion and Further Research

This research in progress paper aims to lay the foundation for a study on CEO reputation management in social media. At the current stage of our project, we propose a mixed method design to approach our research questions. First, a sentiment analysis should be employed to determine the tone of public opinions about a corporation and its CEO, respectively. This analytical step should incorporate the frequency of mentions following the groundwork of Deephouse (2000). In a subsequent step, a content analysis of representative tweets test existing dimensions of corporate reputation (Fombrun et al. 2000) with regards to their applicability for CEO reputation. From analysing sentiments within our case study, we expect findings that mirror CEO reputation to be unattached to the reputation of the respective corporate brand. The textual analysis, however, would allow us to determine additional dimensions of CEO reputation. We expect those dimensions to be based upon the individual characteristics of a CEO as opposed to a corporate brand, e.g. personality, authority, or authenticity.

The proposed study design comes with limitations as a method mix may lead to more valid results, but does not guarantee the appropriateness of this mix for measuring reputation. However, using sentiment analysis allows to process larger data samples than, for instance, surveying a sample customers to assess reputation. Our intended research design suggests Twitter as a suitable platform to retrieve data from. However, going beyond a single data source might enhance the significance of results and enables researchers to gain a broader view on reputation management strategies and a holistic picture of circulating opinions in social media.

Our suggestions for further research are to determine a suitable set of company and CEO pairs who are actively building their reputations in social media. Current best practices of high executives in social media, we argue, show lots of unused potential. Addressing CEO-specific dimensions in social media reputation management may endow CEOs with the standing of opinion leaders. Both their corporation and personal career may reap benefits from such social standing.

## 5 References

- Aral, S., Dellarocas, C., and Godes, D. 2013. "Introduction to the Special Issue - Social Media and Business Transformation: A Framework for Research" in *Information Systems Research* (24:1), pp. 3-13.
- Arruda, B. W., and Dixson, K. 2006. "Build Your Brand in Bits and Bytes" in *Business Week* (40:4), pp. 1-15.
- Beatty, R. P., and Ritter, J. R. 1986. "Investment Banking, Reputation, and the Underpricing of Initial Public Offerings" in *Journal of Financial Economics* (15:1-2), pp. 213-232.

- Benthaus, J. 2014. "Making the Right Impression for Corporate Reputation: Analyzing Impression Management of Financial Institutions in Social Media", *Proceedings of the European Conference on Information Systems*, Tel Aviv: Israel, pp. 1–17.
- Chun, R. 2005. "Corporate Reputation: Meaning and Measurement" in *International Journal of Management Reviews* (7:2), pp. 91–109.
- Colleoni, E., Arvidsson, A., Hansen, L. K., and Marchesini, A. 2011. "Measuring Corporate Reputation Using Sentiment Analysis", *Proceedings of the International Conference on Corporate Reputation*, New Orleans: USA, pp. 1-25.
- Cravens, K. S., Oliver, E. G., and Ramamoorti, S. 2003. "The Reputation Index: Measuring and Managing Corporate Reputation" in *European Management Journal* (21:2), pp. 201–212.
- Deephouse, D. L. 2000. "Media Reputation as a Strategic Resource: An Integration of Mass Communication and Resource-Based Theories" in *Journal of Management* (26:6), pp. 1091–1112.
- Deephouse, D. L., and Suchman, M. C. 2008. "Legitimacy in Organizational Institutionalism" in *The SAGE Handbook of Organizational Institutionalism*, pp. 49–78.
- Dijkmans, C., Kerkhof, P., and Beukeboom, C. J. 2015. "A Stage to Engage: Social Media Use and Corporate Reputation" in *Tourism Management* (47:4), pp. 58–67.
- Floreddu, P. B., Cabiddu, F., and Evaristo, R. 2014. "Inside Your Social Media Ring: How to Optimize Online Corporate Reputation," in *Business Horizons* (57:6), pp. 737–745.
- Fombrun, C. J. 1996. *Reputation: Realizing Value from the Corporate Image*, Cambridge: Harvard Business School Press.
- Fombrun, C. J., Gardberg, N. A., and Sever, J. M. 2000. "The Reputation Quotient<sup>SM</sup>: A Multi-Stakeholder Measure of Corporate Reputation" in *Journal of Brand Management* (7:4), pp. 241–255.
- Francis, J., Huang, A. H., and Zang, A. M. Y. Y. 2008. "CEO Reputation and Earnings Quality" in *Contemporary Accounting Research* (25:1), pp. 109-147.
- Hall, R. 1992. "The Strategic Analysis of Intangible Resources" in *Strategic Management Journal* (13:2), pp. 135–144.
- Hays, P. A. 2004. "Case Study Research" in *Foundations for Research*, London: Lawrence Erlbaum Associates, pp. 217–234.
- Hayward, M. L. A., Rindova, V. P., and Pollock, T. G. 2004. "Believing One's Own Press: The Causes and Consequences of CEO Celebrity" in *Strategic Management Journal* (25:7), pp. 637–653.
- Kaplan, A. M., and Haenlein, M. 2010. "Users of the World, Unite! The Challenges and Opportunities of Social Media" in *Business Horizons* (53:1), pp. 59–68.
- Karjaluoto, H., Mäkinen, H. ;, and Järvinen, J. 2016. "A Firm's Activity in Social Media and Its Relationship with Corporate Reputation and Firm Performance" in *Blurring the Boundaries Through Digital Innovation*, pp. 161–172.
- Kietzmann, J. H., Hermkens, K., McCarthy, I. P., and Silvestre, B. S. 2011. "Social Media? Get Serious! Understanding the Functional Building Blocks of Social Media" in *Business Horizons* (54:3), pp. 241–251.
- Klein, B., and Leffler, K. B. 1981. "The Role of Market Forces in Assuring Contractual Performance" in *Journal of Political Economy* (89:4), pp. 615–641.
- Madhani, P. M. 2010. "Resource Based View (RBV) of Competitive Advantage: An Overview" *Journal of Research of Prestige Institute of Management* (1:1), pp. 43-55, pp. 1–22.
- Mayring, P. 2000. "Qualitative Content Analysis" in *Forum Qualitative Research* (1:2), p. 1-10.
- Mayring, P. 2014. "Qualitative Content Analysis: Theoretical Foundation, Basic Procedures and Software Solution", Klagenfurt.
- Mohamed, A. A., Gardner, W. L., and Paolillo, J. G. P. 1999. "A Taxonomy of Organizational Impression Management Tactics" in *Journal of Competitiveness Studies* (7:1), pp. 1–7.
- Nguyen, N., and Leblanc, G. 2001. "Corporate Image and Corporate Reputation in Customers' Retention



- Decisions in Services” in *Journal of Retailing and Consumer Services* (8:1), pp. 227–236.
- Pal, A., and Counts, S. 2011. “Identifying Topical Authorities in Microblogs”, *Proceedings of the ACM International Conference on Web Search and Data Mining, Hong Kong: China*, p. 45-54.
- Pamuksuz, U., and Mourad, M. 2016. “Analysis of Executive Reputation in Social Media Networks”, *Proceedings of the International Conference on Information Systems*, Dublin: Ireland, pp. 1–9.
- Puncheva, P. 2008. “The Role of Corporate Reputation in the Stakeholder Decision-Making Process” in *Business & Society* (47:3), pp. 272–290.
- Rangarajan, D., Gelb, B. D., and Vandaveer, A. 2017. “Strategic Personal Branding—And How It Pays Off” in *Business Horizons* (60:5), pp. 657–666.
- Reilly, A. H., and Hynan, K. A. 2014. “Corporate Communication, Sustainability, and Social Media: It’s Not Easy (Really) Being Green” in *Business Horizons* (57:6), pp. 747–758.
- Shamma, H. M. 2012. “Toward a Comprehensive Understanding of Corporate Reputation: Concept, Measurement and Implications” in *International Journal of Business and Management* (7:16).
- Smith, K. T., Smith, M. L., and Wang, K. 2010. “Does Brand Management of Corporate Reputation Translate into Higher Market Value?” in *Journal of Strategic Marketing* (3:18), pp. 201–221.
- Stieglitz, S., Dang-Xuan, L., Bruns, A., and Neuberger, C. 2014. “Social Media Analytics. An Interdisciplinary Approach and Its Implications,” in *Business & Information Systems Engineering* (6:2), pp. 89–96.
- Stieglitz, S., Mirbabaie, M., and Potthoff, T. 2018. “Crisis Communication on Twitter during a Global Crisis of Volkswagen – The Case of ‘Dieselgate’”, *Proceedings of the Hawaii International Conference on System Sciences*, pp. 513–522.
- Stieglitz, S., Mirbabaie, M., Ross, B. & Neuberger, C. 2018. "Social Media Analytics - Challenges in Topic Discovery, Data Collection, and Data Preparation" in *International Journal of Information Management* (39:1), pp. 156-168.
- Stigler, G. J. 1962. “Information in the Labor Market” in *Journal of Political Economy* (5:10), pp. 94–105.
- Trainor, K. J. 2012. “Journal of Personal Selling and Sales Management” in *Journal of Personal Selling and Sales Management* (32:3), pp. 317–331.
- Walsh, G., Mitchell, V. W., Jackson, P. R., and Beatty, S. E. 2009. “Examining the Antecedents and Consequences of Corporate Reputation: A Customer Perspective” in *British Journal of Management* (20:2), pp. 187–203.
- Wernerfelt, B. 1984. “A Resource-Based View of the Firm” in *Strategic Management Journal* (5:2), pp. 171–180.
- Wiesenfeld, B. M., Wurthmann, K. A., Hambrick, D. C., and Wiesenfeld, B. A. 2004. “Stigmatization And Devaluation Of Elites Associated With Corporate Failure: A Process Modell” in *Academy of Management Proceedings* (33:1), pp. 231–251.
- Yin, R. K. 2003. *Case Study Research: Design and Methods*, Thousand Oaks: Sage Publications.

**Copyright:** © 2018 Julian Marx, Milad Mirbabaie, Stefan Stieglitz. This is an open-access article distributed under the terms of the [Creative Commons Attribution-NonCommercial 3.0 Australia License](https://creativecommons.org/licenses/by-nc/3.0/australia/), which permits non-commercial use, distribution, and reproduction in any medium, provided the original author and ACIS are credited.

# Risky Donation for Rewarding Innovation? Examining Transformation of Technology Consumers into Crowdfunding Patrons

## Shankhadeep Banerjee

Management Information Systems  
Indian Institute of Management Calcutta  
Kolkata, India  
Email: shankhadeepb15@iimcal.ac.in

## Indranil Bose

Management Information Systems  
Indian Institute of Management Calcutta  
Kolkata, India  
Email: bose@iimcal.ac.in

## Abstract

Reward-based crowdfunding platforms transform technophilic consumers into technology patrons by enabling them to donate for technology development in lieu of receiving the finished product as reward in future. Literature specifically on crowdfunding of technologies is tenuous, and researchers have not yet established the causal factors which entice technology consumers to donate. Using Elaboration Likelihood Model as theoretical base, we conduct a 2x2x2 mixed-design experiment to examine the effects of three core elements of crowdfunding (value of reward, waiting time to receive technology, and affective cues in donor appeal) on a potential consumer's likelihood to donate. Our results show positive impact of reward, and negative impact of waiting time, but surprisingly no effect of affective cues. Significant interaction between reward and waiting time has also been observed. Apart from theoretical contributions, the findings have tactical implications for technology start-ups planning to raise funding through donations, and design implications for crowdfunding platforms.

**Keywords** Reward-based crowdfunding, Donation, Technology Patron, Technology Funding, Elaboration Likelihood Model

## 1 Introduction

Crowdfunding refers to “the efforts by entrepreneurial individuals and groups—cultural, social, and for-profit—to fund their ventures by drawing on relatively small contributions from a relatively large number of individuals using the internet, without standard financial intermediaries” (Mollick, 2014). Based on what the beneficiaries are willing to give to their backers in exchange of funding, and the amount of risk involved for the backers, crowdfunding can be classified into different models like private equity (e.g. EquityNet.com), royalty (e.g. Sellaband.com), microfinance (e.g. Kiva.com), peer-to-peer (e.g. LendingClub.com), rewards (e.g. Kickstarter.com), and donation (e.g. Experiment.com) (Beaulieu et al., 2015). In this paper, we focus on the reward-based crowdfunding model, where the backers get some non-monetary reward from the beneficiaries in exchange of their contribution. The reward can be small (thank you card, key chain, t-shirt, etc.) or big (one or more products and/or accessories) based on the amount of contribution. Reward-based crowdfunding platforms have grown in popularity over last years and they have pumped billions of dollars into thousands of innovative projects; e.g. from its conception to mid-2018, Kickstarter has successfully funded 145K projects with 14M backers contributing US\$ 3.7B (Kickstarter, 2018). These projects can fall into several categories like Music, Film, Art, Food, Photography, Publishing, etc. and typically researchers even in the domain of Information Systems include all of them in studying crowdfunding phenomenon (Bretschneider and Leimeister, 2017; Kim et al., 2017; Zhao et al., 2018; Zheng et al., 2018). However, we choose to focus on the category of Technology, not just because it is directly relevant to IS but also because, interestingly, it has got the lowest success rate of raising money (just 20% in Kickstarter compared to overall average of 36%) among all categories and hence deserves special attention.

Reward-based crowdfunding of technologies is itself a multi-billion dollar phenomenon with US\$ 0.7B funding just in Kickstarter (Kickstarter, 2018), and yet research on it is scarce. It has been argued that the lack of a coherent research agenda, and standardized concepts have led to missing out on examining various core aspects of this phenomenon, and it has been proposed to start off with differentiating between backers who participate in crowdfunding for financial returns (technology investors) and those who receive non-financial or no returns (technology patrons) (Banerjee and Bose, 2017). In the literature relating to technology patrons, specific themes have been covered, e.g. effects of project quality signals and e-word-of-mouth on contribution decision (Bi et al., 2017), overfunding for technology projects (Cordova et al., 2015), impact of funding patterns on the performance of technology entrepreneurs (Jung et al., 2014), etc. However, most of the fundamental questions centred on the patron psychology and behaviour are yet to be investigated. For instance, what propels technology consumers to become technology patrons in the context of reward-based crowdfunding, especially when the reward itself is receiving the technology in future? Consumers can easily take the risk-free path of waiting for the targeted technologies to launch and then decide whether to purchase them or not. Is it because of intrinsic motivations like altruism, or extrinsic ones like rewards, or a mix of both? Also, do the core characteristics of reward-based crowdfunding process (like reward proposition) significantly trigger these motivations? The answers to these are important to the businesses interested in raising adequate funding from reward-based crowdfunding platforms. And so to investigate these, we frame our overarching research question as:

*RQ1: How do certain core elements of reward-based crowdfunding impact a business' likelihood of receiving donation (for developing technology) from a potential consumer promised of being rewarded with the technology in future?*

We chose three critical aspects of reward-based crowdfunding: proposed reward/discount (relative difference between expected retail price and requested donation), waiting time (temporal distance between the time of donation and the proposed delivery of technology), and affective cues in the donation request to evoke altruistic and technophilic emotions. Using Elaboration Likelihood Model, we expected the first two factors to affect a potential consumer's likelihood to donate through central route (high cognitive processing of information), while the last factor to affect the same via peripheral route (heuristics-based low cognitive processing). Since, in reality, these factors act simultaneously, there is a chance of significant interaction effects among them as well. Hence, we used a 2x2x2 mixed-factorial experiment with Latin Square design (Grant, 1948) to test the individual and collective impact of the three factors on the donation likelihood. We included adequate controls related to product, demographics, psychographics, and experiment design to ensure sufficient internal and external validity. We used a general linear mixed-effects model with random and repeated effects for subjects to analyse the data collected from a sample (N=114) of students and professionals (each presented with 4 within-subjects treatment scenarios, leading to 456 observations in total). Our results show positive impact of reward, and negative impact of waiting time, but surprisingly no effect of affective cues. Significant interaction between reward and waiting time has also been observed.

This study makes several theoretical contributions: first, it extends the nascent but growing research on technology patrons and reward-based crowdfunding context; second, using experiment it establishes certain causal factors and their interactions that affect donation likelihood; third, it demonstrates an application of ELM theory in crowdfunding context; fourth, it introduces technology-based variables like technology attractiveness and technology complexity which can be used in innovation/technology-centric studies in various contexts. The findings have potential tactical implications for technology start-ups planning to raise funding through donations as they can tailor their crowdfunding request plans based on the significance of various factors. Similarly, the identification of certain critical factors for converting consumers to patrons also has design implications for crowdfunding platforms.

The upcoming sections would elaborate on the theoretical background, hypotheses development, experiment design, analyses, and results, and finally conclude with a discussion on findings, implications, limitations, and future research.

## 2 Theory and Hypotheses

Our research aims to understand how potential technology consumers process certain information presented to them in the context of reward-based crowdfunding and get persuaded to make donations. Hence, we chose a persuasion-related theory of Elaboration Likelihood Model (ELM) which explains different ways of people process information for decision-making (Petty and Cacioppo, 1983). Elaboration refers to “the extent to which a person scrutinizes the issue-relevant arguments contained in the persuasive communication” (Petty and Cacioppo, 1986). ELM proposes two routes of persuasion: the central route where “persuasion will likely result from a person's careful and thoughtful consideration of the true merits of the information presented in support of an advocacy”; and the peripheral route where “persuasion results from a person's association with positive or negative cues in the stimulus” (Petty and Cacioppo, 1984). Thus, the central route involves much more cognitive efforts (elaborations) as compared to the peripheral route. Factors in both these routes can not only directly affect decision making and attitudinal change, but even some of the interactions among those factors have also been found to be significant in various studies (Kim and Benbasat, 2009; Ma et al., 2013). ELM has been mostly used in marketing domain, however few studies have applied it to crowdfunding as well (Bi et al., 2017; Zheng et al., 2016).

In attempting to persuade potential consumers to donate for technology development in reward-based crowdfunding platforms, the value of reward is definitely expected to play a central role. Businesses promise to deliver the technology sometime in future to those patrons who donate a certain amount of currency (less than the expected retail price of the technology when launched in future). So from another perspective, it could be stated that the patrons are basically pre-buying the technology at a certain discount. However, there is always the risk of not getting the technology at all, so the proposed discount should be alluring enough for the consumers to turn into patrons. Given the calculations involved in processing the reward information, decision-making based on reward definitely falls under the central route of ELM. Although not specifically in the technology context, rewards have been found to be a significant motivator for crowdfunding backers (Bretschneider and Leimeister, 2017; Kunz et al., 2017; Weinmann et al., 2018). So we expect the value of reward (or the percentage discount on technology in our context) to be a positive factor in converting a consumer to patron, and hence propose the following hypothesis:

*H1: On promising to deliver technology in future as reward for current donations, a high relative difference between expected retail price and requested donation leads to a higher likelihood of receiving donation from potential consumer compared to low relative difference.*

When receiving the crowdfunded technology as a reward for donation, another related element of crowdfunding which can be expected to be a significant influencer of donation likelihood is the estimated waiting time of receiving the technology. It is possible that a high waiting time might signal a long development process where many things may go wrong and this may increase the risk perceived by the patron. The consideration of waiting time would require significant cognitive exertion and hence it would also be a central route factor under ELM. While the estimated time of delivery of rewards have been found to have a negative impact on the successful completion of a crowdfunding campaign in general (Kunz et al., 2017), the case of technology projects might turn out to be different as technology development is expected to be a complex process and patron expectations on delivery time may be set accordingly. However, we still expect that low waiting time to receive the technology as reward would be preferred over high waiting time, and hence we propose:

*H2: A high temporal distance between the time of donation and the proposed delivery of technology (as reward) leads to a lower likelihood of receiving donation from potential consumer compared to low temporal distance.*

Apart from extrinsic motivation from rewards, it has found that crowdfunding backers are also pro-socially motivated and develop feelings for the projects (Bretschneider and Leimeister, 2017). It could be possible that inclusion of affective cues (emotional request, show of gratitude, inspirational quotes on charity, etc.) within donation request context may trigger emotional reactions of altruism and technophilia and lead to higher likelihood of donation. Of course, this would entail heuristic information processing and thus take the peripheral route of ELM. The theme of reward vs. philanthropic motivation (Ryu et al., 2016) along with pro-social behaviour (Bretschneider and Leimeister, 2017) has been touched upon in general crowdfunding as well. With the expectation that affective cues would positively influence potential consumers to donate, we propose the following:

*H3: In the donation request context, a high presence of affective cues leads to a higher likelihood of receiving donation from potential consumer compared to low presence of affective cues.*

Being closely intertwined, we also expect an interaction effect between the value of reward and the waiting time to receive the reward. In case of low discount on technology as reward, proposing high waiting time should act as further dampener in the motivation to donate. This should lead to a big difference in the donation likelihood between high and low waiting time scenarios in case of low reward. However, when the reward proposed is high, it should provide a cushioning effect and hence we do not expect a huge difference in donation likelihoods of low and high waiting time. Based on this argument, we propose a positive interaction effect between reward and waiting time, and state the following hypothesis:

*H4: The difference in the likelihood of receiving donation from potential consumer between low and high temporal distances (to deliver reward) is higher for low reward compared to high reward.*

### 3 Research Design

To ensure a thorough testing of the hypotheses, we design a 2 x (2x2) mixed factorial experiment using two levels (Low/High) for each of the three factors: Affective Cues x (Discount x Waiting Time), where first factor is treated between-subjects and rest two are treated within-subjects (4 repeated measures). The details of the experiment is provided in subsections below.

#### 3.1 Pre-tests

We started with conducting multiple pre-tests on 13 doctoral students (aged 25 to 46) familiar with latest trends in technology for developing proper treatment conditions for the experiment. Our first aim was to identify some new technology products to be used in the experimental scenarios as product controls, and second aim was to fix low/high levels for the reward/discount and waiting time. A consumers' evaluation of reward/discount could be affected by the price and attractiveness of the technology. Even the evaluation of waiting time could be dependent upon how complex the technology development process would be as per consumer expectation. Hence, in our pre-tests, we gave the respondents a list of 10 trending technologies of different price points (prices not shown to respondents to avoid bias), and asked them to rate them (Likert scale 1-7) based on perceived attractiveness and complexity. In other pre-tests we asked them to imagine pre-ordering a new technology (under development) and asked them to rate their opinions on attractiveness of different discount ranges (in %ages), price ranges (in US\$) and estimated waiting times for product delivery (in months). Based on the results from all the pre-tests, we judiciously selected 4 technology products ranging from low to high in terms of price, attractiveness, and complexity. And for each technology, we also fixed respective low and high values for discount and waiting time to be used in the experimental scenarios. All these values are provided in Table 1.

	Smart Bluetooth Speaker	Long Lasting Smartwatch	Virtual Reality Headset	3D Printer
Perceived Attractiveness (1-7)	3.27	3.47	4	4.4
Perceived Complexity (1-7)	2.2	2.47	3.67	4.13
Price (in USD)	\$50	\$100	\$200	\$300

Low Waiting Time (in months)	1	1.5	2	2.5
High Waiting Time (in months)	9	10	11	12
Low Patron Discount (in %age)	12	15	18	22
High Patron Discount (in %age)	50	55	60	65

Table 1. Technology products and treatment levels selected based on pre-tests

### 3.2 Experiment Design

The overall design of our 2x (2x2) mixed factorial experiment is shown in Table 2. Affective cues were kept as a between-subjects factor and not within-subjects since emotional effects tend to stay for longer periods and a high-affect treatment in one scenario may distort responses for other low-affect scenarios. So all participants were divided into two major groups, with entire Group A being treated with low levels of affective cues, and Group B treated with the high level. Each group was further divided into 4 blocks where participants in each block were presented with 4 different scenarios, each with a different technology and different combination of treatment levels (LL, LH, HL, HH) for discount and waiting time. However, the sequence of these treatments varied cyclically in each block, thus creating a Latin square experimental design as could be seen in Table 2. This is considered to be a much more powerful design compared to just presenting a single sequence of within-subjects treatments. By presenting different sequences to the subjects it systematically eliminates the issue of carry-over effects common with repeated measures designs (Grant, 1948). The design also presents all the treatment combinations to be tested for each technology as well, thus controlling a lot of unknown error-inducing factors related to the interaction of a certain treatment condition with a certain technology.

Group A (L Affect)	Smart Bluetooth Speaker	Long Lasting Smartwatch	Virtual Reality Headset	3D Printer
Block 1	LL	LH	HL	HH
Block 2	LH	HL	HH	LL
Block 3	HL	HH	LL	LH
Block 4	HH	LL	LH	HL

Note: All scenarios display L/H Waiting Time followed by L/H Discount

Table 2. The 2 x (2x2) mixed factorial Latin Square design chosen for our experiment

### 3.3 Scenarios and Measures

For the overall context of the study, the participants were told that their help was required to improve product launch plans and donor rewards proposed by 4 technology startups as presented in the four scenarios. A sample screenshot of an experimental scenario is provided in Appendix 1. In each scenario, the participants were asked to imagine their interest in owning a certain genre of technology and were presented with the proposed plan of a startup to launch a product in that genre sometime in the future. Two options were offered to the subjects: A) be a consumer: Wait till product launch and purchase at full retail price; B) be a donor: Provide the requested donation (discounted price of product) right now and the technology will be delivered as reward after launch. The within-subject low/high levels of proposed discount and estimated waiting times were varied in each scenario based on the design discussed earlier. The between-subject factor of affective cues was varied as follows: the low level consisted of the phrase "Kindly donate to support us" and offering a card with "Thank you Patron!" as a mark of gratitude. The high level scenarios had the same abovementioned phrase but also had two additional inspirational quotations (one on altruism and charity, and another on love of technology). Also, instead of a card, the patrons were offered a plaque with "Thank you Patron! You made this possible!"

For measuring the dependent variable of our study, for each scenario we asked the participants to rate (in Likert scale from 1: extremely unlikely to 7: extremely likely) the following: "Based on the given scenario, kindly rate your likelihood of taking the following action: Go with Option B (Donor)". We also used bipolar scales (1: extremely low to 7: extremely high) gauge subjects' opinions on five aspects to be used for manipulation checks and controls: waiting time, discount percentage, attractiveness of

technology, technology complexity, and price. On completion of the four scenarios, subjects were asked some probing questions to understand their decision-making process, e.g. rate (from 1: strongly disagree to 7: agree) the following statement: “Feeling good about helping startups influenced my likelihood to be a donor”. However, given the space and scope restrictions, we won’t cover the details and analyses of these questions in this paper. Few more measures for demographic controls were also taken, such as age, gender, and occupation. Further, some psychographic controls were also measures where we asked the subjects to rate themselves on taking risk, helping others, attitude towards technology, donation regularity, and familiarity with technologies.

### 3.4 Sample

Since we essentially intend to study decision-making of technology consumers who may engage in crowdfunding to become patrons, we wanted to ensure that our experimental subjects were not only technology users but also open-minded and favourable towards the idea of donating for development of technologies. Hence, for recruiting our participants, we sent out email invitations to a pool of university students as well as a class of professionals (attending a techno-management course) with a real promise that for every completed response we would donate a certain sum to Wikipedia. Based on the completed responses, our final sample consists of 114 participants with 72% males and 28% females. 46.5% of them are students, 48.25% are employed professionals, and rest 5.25% belong to other occupations (self-employed, unemployed, etc.). The average age of participants is 32 years from a minimum of 22 years to maximum of 50 years. Since each subject were given 4 different treatments, the total number of observations we had to analyse was 456.

## 4 Analyses and Results

As part of data checks on the 456 observations, we removed those having any missing values. Also, to reduce possibility of spurious data (respondents marking answers without even reading questions), we removed observations where respondents have marked same values for multiple consecutive questions even where it is not possible logically. Next, to test whether the manipulations worked as per intentions, we had included manipulation check questions (on a scale of 1: extremely low to 7: extremely high) related to respondents’ perceptions of waiting time and discount. So that in case the perceptions did not match with our intended treatment levels, we could remove the observation. Accordingly, we excluded observations where the treatment level of independent variables is low but their perceived values are greater than 4, and also where the treatment level of independent variables is high but their perceived values are less than 4. Ultimately, we were left with 327 observations having correctly applied treatments for conducting our analysis.

We used a linear mixed model to analyse the data since it gives us the flexibility not just to estimate the fixed effects of the manipulated and control variables, but also the random effects (found significant) arising from the subjects and repeated effects (also found significant) for using multiple observations from each subject according to the Latin Square design (West et al., 2014). Table 3 summarizes the Type III fixed effects of the independent variables, product controls, demographic controls, psychographic controls, and design controls on the donation likelihood. Significant interaction effect was observed between Waiting Time and Discount ( $F(1, 230.635) = 0.33, p < 0.05$ ), but all other interaction effects were found to be insignificant. As for the main effects, increasing Waiting Time from low to high had a significant negative impact ( $F(1, 232.168) = 59.53, p < 0.05$ ) with a decrease in donation likelihood by 1.304 (on a scale of 1 to 7). Increasing Discount from low to high was found to significantly ( $F(1, 226.454) = 131.694, p < 0.05$ ) improve the DV by 1.914. The presence or absence of affective cues in the scenarios did not significantly influence the donation likelihoods of the respondents. Thus, all the hypotheses pertaining to the central route of ELM (H1, H2, and H4) are supported, whereas impact of peripheral route (H3) is not supported.

DV: Donation Likelihood	Numerator df	Denominator df	F	Sig.
Intercept	1	153.767	12.961	.000
<b>Independent Variables:</b>				
IV1_ WaitingTime	1	232.168	59.530	.000
IV2_ Discount	1	226.454	131.694	.000

IV3_AffectCues	1	111.452	.149	.700
IV1_WaitingTime * IV2_Discount	1	222.664	7.291	.007
IV1_WaitingTime * IV3_AffectCues	1	230.635	.330	.566
IV2_Discount * IV3_AffectCues	1	224.714	.344	.558
IV1_WaitingTime * IV2_Discount * IV3_AffectCues	1	225.255	.513	.475
<b>Product Controls:</b>				
Product	3	241.398	3.566	.015
PercAttractiveness	1	314.558	16.143	.000
PercComplexity	1	286.959	.360	.549
PercPricing	1	295.891	2.824	.094
<b>Demographic Controls:</b>				
Gender	1	100.028	.570	.452
Age	1	107.697	4.012	.048
Occupation	2	101.154	1.889	.157
<b>Psychographic Controls:</b>				
TakesRisk	1	96.615	3.346	.070
HelpsOthers	1	95.375	1.034	.312
LikesTech	1	100.832	.631	.429
DonatesFreq	1	95.613	1.004	.319
TechFamiliarity	1	103.725	.431	.513
<b>Design Controls:</b>				
Block	3	98.621	2.861	.041

Table 3. Fixed effects of factors using linear mixed models

To investigate exactly how the donation likelihoods changed at different levels of waiting time and rewards, we looked at the estimated marginal means (EMM) of the DV on a scale of 1 to 7 using Bonferroni adjustment (Dunn, 1961). In case of low waiting time, the EMM for donation likelihood was found to be 4.211 (Standard Error: 0.243) for low reward scenario, and 5.677 (0.189) for high rewards; whereas in case of high waiting time, the EMM for donation likelihood was found to be 2.459 (0.222) for low reward scenario, and 4.822 (0.225) for high rewards. Fig. 1 plots the points to visually depict the findings. It could be seen that while the donation likelihood rises up as expected on increasing the reward, the increase is higher for high waiting time scenario. This is what caused the interaction effect between waiting time and discount to be significant.



Figure 1: Estimated Marginal Means of Donation Likelihood



## 5 Discussion

Our research goal was to understand how certain core elements of reward-based crowdfunding impact a business' likelihood of receiving donation (for developing technology) from a potential consumer promised of being rewarded with the technology in future. Our findings show that potential consumers are influenced more by the central extrinsic factors like value of reward and time to receive reward than the peripheral intrinsic factors like altruism and technophilia, when considering whether to indulge in reward-based crowdfunding. This practically implies that technology start-ups should focus more on the *deal* offered to potential consumers rather than making emotional pitches to affect their decisions. Also, from the significant interaction effect between waiting time and reward we could infer that technology start-ups should be cautious and calculative in designing their crowdfunding offerings as high rewards becomes critical in case of high waiting time scenario without which the crowdfunding campaign would most definitely fail; whereas for low waiting time offering a low to moderate reward is enough to raise donations. Additionally, from looking at the control variables in our model we could gauge that certain technology-related characteristics also play important roles with a significant influence ( $p < 0.1$ ) of the product, its perceived attractiveness, and the expected retail price. So start-ups cannot expect unattractive high-priced products to succeed in crowdfunding campaigns even when offering attractive rewards.

This study makes several theoretical contributions, specifically to the literature on crowdfunding of technologies, and to the IS domain in general. Firstly, this is the first study to investigate the conditions under which technology consumers may prefer to partake in reward-based crowdfunding and thus play the role of technology patrons. There is a dearth of literature on technology patrons, and the findings of this study make a fundamental contribution to this nascent area. Secondly, this study uses a controlled experiment to establish causal links (to the extent practically possible) of certain manipulated factors and their interactions with donation likelihood of potential consumers. Thus, the findings are more focused and reliable compared to association-based studies using secondary data. Thirdly, very few studies have applied the ELM theory to the crowdfunding context (Bi et al., 2017; Zheng et al., 2016), and this study demonstrates yet another application of ELM in reward-based technology crowdfunding context. Our findings showing a clear influence of central route and non-influence of peripheral route provide significant theoretical contributions with potential for further research. Fourthly, rare technology-based constructs like technology attractiveness and technology complexity have been introduced, measured, and used in this paper. These can be further used in technology-centric studies in various contexts. Fifthly, in the IS literature, although experiments are increasingly being used, the more complex designs have rarely been seen. We hope our methodological novelty - mixed designs with Latin Square (Grant, 1948) and using linear mixed models (West et al., 2014) for analysis - would also help other IS researchers understand and consider delving into the richness of experiment designs and analyses.

The findings of this research also have potential tactical implications for technology start-ups planning to raise funding through reward-based crowdfunding and donations. It shows that given the right conditions, a consumer may choose to donate instead of purchase the technology. So the companies can use their sales leads to also find potential patrons. They can tailor their crowdfunding request plans by focusing more on the offerings, like highlighting on how with a small waiting time the consumers can get the same technology at a good discount. Also, they can create interesting product demo videos to enhance technology attractiveness. However, trying to include more affective content in videos or showing how complex the technology development process is, may not bear expected fruitful results (although no negative result as well). Given the interaction between factors, it might be a good idea for companies to pilot test various combinations of their offerings before going to crowdfunding market. For another stakeholder, the crowdfunding platforms, similar implications can be drawn but from a different perspective. They can (re)design their campaign forms and display pages focusing on the significant factors, along with providing guidelines to start-ups on what works.

Finally, we acknowledge certain limitations of this study and the potential areas of future research stemming out of them. Firstly, we could only capture the donation intention and not the actual behaviour of a limited sample. Future studies may try to make the experiment more realistic by actually offering consumers some budget and then propose the options of patronizing or purchasing the product. Secondly, we could only investigate few factors owing to the methodology of our study. However, there are many other factors like reputation of start-ups, peer influences in crowdfunding community, etc. which could be studied in future. Thirdly, we could only provide one reward option for each scenario. However, practically, a technology company can offer a tiered-reward system based on the amount of donation. This complexity can be added in future. Fourthly, we mostly focused on what was happening but not much into the why, which would require delving deeper into the psychology of patrons.

## 6 Conclusion

We focused on the phenomenon of how reward-based crowdfunding transforms potential consumers into technology patrons by enabling them to donate for technology development in lieu of receiving the finished product as reward in future. Given the dearth of literature specifically on crowdfunding of technologies, not much is known regarding the core factors which convince technology consumers to donate instead of purchase the product. We used the Elaboration Likelihood Model which proposes central and peripheral routes of information processing as our theoretical base, and conducted a 2x2x2 mixed-design experiment to examine the effects of three core elements of crowdfunding (value of reward, waiting time to receive technology, and affective cues in donor appeal) and other control variables (technology attractiveness, complexity, price, etc.) on a potential consumer's likelihood to donate. We found positive impact of reward, and negative impact of waiting time, both of which fall into central route of ELM. There was no observed effect of affective cues which falls into peripheral route. Significant interaction between reward and waiting time was also observed. We presented several theoretical and methodological contributions in IS domain, along with tactical implications for technology start-ups planning to raise funding through donations, and design implications for crowdfunding platforms. We hope this study would encourage other IS researchers to take interest into this nascent but growing field of patronage of technologies.

## 7 References

- Banerjee, S. and Bose, I. (2017), "Patronizing Technology: An Emergent Technophilic Behavior", *ICIS 2017 Proceedings*.
- Beaulieu, T.Y., Sarker, S. and Sarker, S. (2015), "A Conceptual Framework for Understanding Crowdfunding", *Communications of the Association for Information Systems*, Vol. 37, pp. 1–31.
- Bi, S., Liu, Z. and Usman, K. (2017), "The Influence of Online Information on Investing Decisions of Reward-based Crowdfunding", *Journal of Business Research*, Vol. 71, pp. 10–18.
- Bretschneider, U. and Leimeister, J.M. (2017), "Not Just an Ego-trip: Exploring Backers' Motivation for Funding in Incentive-based Crowdfunding", *Journal of Strategic Information Systems*, Vol. 26 No. 4, pp. 246–260.
- Cordova, A., Dolci, J. and Gianfrate, G. (2015), "The Determinants of Crowdfunding Success: Evidence from Technology Projects", *Procedia - Social and Behavioral Sciences*, Vol. 181, pp. 115–124.
- Dunn, O.J. (1961), "Multiple Comparisons among Means", *Journal of the American Statistical Association*, available at:<https://doi.org/10.1080/01621459.1961.10482090>.
- Grant, D.A. (1948), "The Latin Square Principle in the Design and Analysis of Psychological Experiments", *Psychological Bulletin*, available at:<https://doi.org/10.1037/h0053912>.
- Jung, E.J., Susarla, A. and Sambamurthy, V. (2014), "Evolutionary Fundraising Patterns and Entrepreneurial Performance in Crowdfunding Platforms", *ICIS-RP*, pp. 1–10.
- Kickstarter. (2018), "Kickstarter Stats", available at: <https://www.kickstarter.com/help/stats>.
- Kim, D. and Benbasat, I. (2009), "Trust-Assuring Arguments in B2C E-commerce: Impact of Content, Source, and Price on Trust", *Journal of Management Information Systems*, Vol. 26 No. 3, pp. 175–206.
- Kim, T., Por, M.H. and Yang, S.-B. (2017), "Winning the Crowd in Online Fundraising Platforms: The Roles of Founder and Project Features", *Electronic Commerce Research and Applications*, Vol. 25, pp. 86–94.
- Kunz, M.M., Bretschneider, U., Erler, M. and Leimeister, J.M. (2017), "An Empirical Investigation of Signaling in Reward-based Crowdfunding", *Electronic Commerce Research*, Vol. 17 No. 3, pp. 425–461.
- Ma, X., Khansa, L., Deng, Y. and Kim, S.S. (2013), "Impact of Prior Reviews on the Subsequent Review Process in Reputation Systems", *Journal of Management Information Systems*, available at:<https://doi.org/10.2753/MISO742-1222300310>.

- Mollick, E. (2014), "The Dynamics of Crowdfunding: An Exploratory Study", *Journal of Business Venturing*, Vol. 29 No. 1, pp. 1–16.
- Petty, R.E. and Cacioppo, J.T. (1983), "Central and Peripheral Routes to Persuasion: Application to Advertising", *Advertising and Consumer Psychology*, pp. 3–23.
- Petty, R.E. and Cacioppo, J.T. (1984), "Source Factors and The Elaboration Likelihood Model of Persuasion", *Advances in Consumer Research*, available at:<https://doi.org/10.1558/ijssll.v14i2.309>.
- Petty, R.E. and Cacioppo, J.T. (1986), "The Elaboration Likelihood Model of Persuasion", *Advances in Experimental Social Psychology*, available at:[https://doi.org/10.1016/S0065-2601\(08\)60214-2](https://doi.org/10.1016/S0065-2601(08)60214-2).
- Ryu, S., Kim, K. and Kim, Y. (2016), "Reward versus Philanthropy Motivation in Crowdfunding Behavior", *PACIS 2016 Proceedings*.
- Weinmann, M., Simons, A., Tietz, M. and Brocke, J.V. (2018), "Get It before It's Gone? How Limited Rewards Influence Backers' Choices in Reward-Based Crowdfunding", *ICIS 2017: Transforming Society with Digital Innovation*.
- West, B.T., Welch, K.B. and Galecki, A.T. (2014), *Linear Mixed Models: A Practical Guide Using Statistical Software, Second Edition*, available at:<https://doi.org/10.1201/b17198-2>.
- Zhao, Y., Qin, Y., Zhao, X. and Shi, L. (2018), "Relationship Between Entrepreneurial Motivation and Crowdfunding Success Based on Qualitative Analysis-Based on Kickstarter Website Data", *Wireless Personal Communications*, pp. 1–12.
- Zheng, H., Hung, J.-L., Qi, Z. and Xu, B. (2016), "The Role of Trust Management in Reward-based Crowdfunding", *Online Information Review*, Emerald Group Publishing Limited, Vol. 40 No. 1, pp. 97–118.
- Zheng, H., Xu, B., Zhang, M. and Wang, T. (2018), "Sponsor's Cocreation and Psychological Ownership in Reward-based Crowdfunding", *Information Systems Journal*, available at:<https://doi.org/10.1111/isj.12190>.

## Appendix 1

A scenario presented to the respondents of experiment is provided here as an illustration. Each respondent got 4 such scenarios along with several questions to answer.

*"Giving is not just about making a donation. It is about making a difference." Kathy Calvin*

*"The art challenges the technology, and technology challenges the art." John Lasseter*

Imagine that you are interested in owning a long-lasting *Virtual Reality Headset*. A startup company *VR Tech* has recently announced their plan to launch a state-of-the-art *Virtual Reality Headset* as shown below:



*Product prototype (under development). Kindly donate to support us!*

Top Features:

- Amazing immersive 3D virtual reality experience
- Extremely light weight and comfortable to wear

The technology is *still under development* and has an **estimated launch target of 11 months** (*subject to the risks/uncertainties inherent in any new technology development process*).

The company offers you two options –

**Option A: Be our Consumer**  
Wait till product launch and then purchase it at **full retail price (\$200)**.

**Option B: Be our Donor**  
Donate **\$164 (18% discount on retail price)** right now to support us, and get the product after its launch, along with our heartfelt gratitude (*a plaque engraved with 'Thank You Patron! You made this possible!'*).

## Acknowledgements

We thank Prof. Saravana Jaikumar (Marketing Department, Indian Institute of Management Calcutta) for helping us with his expert counsel on designing the experiment presented in this paper.

## Copyright

**Copyright:** © 2018 Shankhadeep Banerjee and Indranil Bose. This is an open-access article distributed under the terms of the [Creative Commons Attribution-NonCommercial 3.0 Australia License](https://creativecommons.org/licenses/by-nc/3.0/australia/), which permits non-commercial use, distribution, and reproduction in any medium, provided the original author and ACIS are credited.

# **A study of influential factors in designing self-reconfigurable robots for green manufacturing**

**Research-in-progress**

## **Mahdi Fahmideh**

School of Information, Systems and Modelling  
University of Technology Sydney  
Australia, Sydney  
Email: Mahdi.Fahmideh@uts.edu.au

## **Thorsten Lammers**

School of Information, Systems and Modelling  
Australia, Sydney  
Email: Thorsten.Lammers@uts.edu.au

## **Abstract**

There is incremental growth in adopting self-reconfigurable robots in automating manufacturing conventional product lines. Using this class of robots adapting themselves with ever-changing environmental conditions has been acclaimed as a promising way of reducing energy consumption and environmental impact and thus enabling green manufacturing. Whilst the majority of existing research focuses on highlighting the efficacy of self-reconfigurable robots in energy reduction with technical driven solutions, the research on exploring the salient factors in design and development self-reconfigurable robots that directly enable or hinder green manufacturing is non-extant. This interdisciplinary research contributes to the nascent body of the knowledge by empirical investigation of design-time, run-time, and hardware aspects which should be contingently balanced when developing green-aware self-reconfigurable robots.

**Keywords** Green manufacturing, self-reconfigurable robots, robot design, green awareness

## 1 Introduction

The idea of *green manufacturing* is stimulated by increasing CO<sub>2</sub> gas emissions, scarcity of raw material resources, and increasing levels of air pollution. Green manufacturing refers to a new manufacturing paradigm in which various green principles, policies, strategies, and technologies are employed to become more environmentally friendly and substitute input production materials with non-toxic and renewable ones Deif (2011). The notion of green manufacturing ranges from green purchasing to receiving customer orders and delivering the product Zhu and Sarkis (2004). Green manufacturing is augmented by green technologies along with more environmentally friendly product designs. By 2020, 60% of plant floor workers at top 2,000 ranked public companies in the world will work alongside automated assistance technologies such as robotics, 3D printing, artificial intelligence, and virtual reality Knickle (2016). Self-reconfigurable robotics is a new and emerging field of robotic systems. They consist of modular components that can automatically change their configuration to achieve different tasks based on environmental conditions.

The design and development of self-reconfigurable robots in alignment with the requirements of green manufacturing such as less energy consumption is a challenging task Brossog et al. (2015). In fact, adherence to green manufacturing is undergone by reducing the energy consumption of robots, which enable and support manufacturing processes. Hence, the design of green-aware self-reconfigurable robots can contribute to more energy-efficient production lines. An understanding of the relationship between key factors in the design and development of self-reconfigurable robotic systems that are important to address green requirements would significantly help to maximise the business impact of this technology. It would not only allow for a more efficient utilisation of robotic systems, but could also increase manufacturers' capabilities to design, develop, and increase the usability of self-reconfigurable robots for the service and consulting sectors, which play an important role to get a competitive advantage such as productivity, safety, and saving. To close this gap, the goal of this research is to answer the following research question: "What are key influential factors to be taken into account in a self-reconfigurable robot design with respect to green manufacturing requirements?" The key contributions of this study are to (i) identify and analyse design factors to be taken into account when building or purchasing self-reconfigurable robots aligned with green manufacturing requirements and (ii) reflect on domain experts' opinions about how such factors can be applied during the design process. To date, little, if any research has explored and matched design factors of self-reconfigurable robots with green requirements and thus this portion of the literature is weak with respect to theoretical foundations. The results of this research benefit (i) researchers looking for understanding and unpacking factors in green-aware self-reconfigurable robots to derive new hypotheses to be tested and to identify the areas of future research and (ii) practitioners looking for detailed advice on key design factors in the implementation of self-reconfigurable robots. The context in which this research is applied is the agriculture sector. We found that, in contrast to other fields such as industrial processes, the agriculture field has complex tasks which cannot be simply organised and modularised to be performed in simple actions via self-reconfigurable robots. Hence, we choose the greenhouse farming as it needs more investigation on how self-reconfigurable robots can be applied Roldán et al. (2018).

The rest of this paper is organized as follows. Section 2 provides some backgrounds on green manufacturing and self-reconfigurable robots. Section 3 presents the development of research hypotheses followed by the discussion of the research methodology. The paper ends with the discussion on future research, limitations, and a conclusion.

## 2 Background and literature review

The word *green* is used to reflect higher environmental awareness. In the context of manufacturing, it refers to adopting strategies and technologies that are more eco-efficient Deif (2011). The green manufacturing process covers the whole product lifecycle such as creating products/systems that consume less material and energy, substituting input materials (e.g. non-toxic for toxic, renewable for non-renewable), reducing unwanted outputs, and converting outputs to inputs (recycling).

It is commonly accepted that robots, among others, are a key integral part of manufacturing product lines to perform namely dumb, dangerous, dull, and/or dirty operations. A self-reconfigurable robot, a sub-class of robot systems, is one that is capable of adapting its functions and behavior to changing environments with minimum or without any external help Murata and Kurokawa (2007). Potentially, they are more adaptive than conventional robots to perform fixed tasks. A self-reconfigurable robot refers to the ability of the robot to adapt its functions at run-time based on changing user needs or operational environment, occurring intrusions or faults, and resource variability to cope with the

complexity of today's environments. Self-reconfigurable robots can dynamically reconfigure, optimize, protect, and recover their components and functionalities while covering their internal complexity from users. Self-reconfigurable robots have been viewed as an effective way to move from a less green into a greener and more efficient manufacturing Murata and Kurokawa (2007). In general, there are a few motivations in designing self-reconfigurable robots Yim et al. (2007): (i) *Versatility*: Self-reconfigurable robots are able to disassemble and reassemble themselves to form new morphologies that are better suited for new tasks, for example changing from a legged robot to a snake robot and then to a rolling robot, (ii) *Robustness*: Self-reconfigurable robots can replace faulty components autonomously, leading to self-repair, (iii) *Low cost*: Self-reconfigurable robots can potentially lead to lower overall cost through creating and reusing copies of its components to bring economies of scale and mass production.

Reconfigurable robots have been identified as a key technology to keep the manufacturing industry green Pellicciari et al. (2015). Due to the fact that many of today's manufacturers are relying on robots in automating their product lines, improving green awareness of robots will subsequently lead to better green awareness of manufacturing Brossog et al. (2015). Hence this stream has received a significant attention from both researchers and industries seeking robots' design improvement. The development of green-aware self-reconfigurable robots is a challenging task Nielsen et al. (2017). That means, unleashing the capabilities of self-reconfigurable robots to achieve green-aware manufacturing implies a process including several stages, implementation activities, and principles for design and development of robots or reengineering existing ones. The development of robots should be analysed so as to select the adequate implementation techniques and technologies or a combination of them to achieve the desired green-awareness. This faces manufacturers with a challenge to design greener self-reconfigurable robotic systems. These challenges are better understood when a self-reconfigurable robot is characterized by its constituents.

There is a bunch of research on drivers of using green practices Vachon and Klassen (2006), models towards enabling green manufacturing Deif (2011), and frameworks/techniques to develop self-reconfigurable robots Edwards et al. (2009). Some other research intends to develop technical frameworks to increase the level of process automation Nakabo et al. (2009; Stasse et al. (2009), reduce the cost of production Quigley et al. (2011), and energy consumption Brossog et al. (2015; Brossog et al. (2014; Riazi et al. (2016). Such studies relating to this research have generally shown some insights of the effectiveness of robotic systems in the manufacturing process and propose useful techniques to reduce the energy consumption of robots associated with manual business processes.

Nevertheless, specific research on the quality design of self-reconfigurable robots to be accommodated in manufacturing to make them more green aware is more limited and inconclusive. Existing studies are rather technical-centric and focused on very specific robot design. As such it can hardly be generalized to get a theoretical ground. In designing and adopting self-reconfigurable robotic systems, incorporating the design factors influencing the environment is important Ahmad and Babar (2016; Pellicciari et al. (2015). From the perspective of empirical evidence, unpacking the influential factors in design and development of self-reconfigurable robots which subsequently positively/negatively contribute to improving green-awareness of manufacturing is hardly to find in the existing studies. The mixed results from the literature point to possible contingency factors that might be used in theory development in the effective green-aware robot design.

### 3 Hypothesis development

Like typical robots, a self-reconfigurable robot, regardless of its application domain, is a combination of two distinct components, i.e. hardware/physical for assembling and software for operations in a seamless way Jackson (2007). Software components aim to coordinate hardware components and to provide some advanced functionalities. Software components are typically embedded, real-time, distributed, and data-intensive and must meet specific requirements, such as safety, reliability, and fault-tolerance. Typically, developers implement software components through a software engineering lifecycle including common stages such as modelling, architecture designing and programming, testing and deploying. In developing green-aware self-reconfigurable robots, the aspects of software and hardware design are two key issues. In fact, designing green-aware self-reconfigurable robots can be viewed as balancing among software/hardware components design and their consequences on the environment. These two distinct aspects can be contradictory. For instance, the capability of a robot to reconfigure its components at the run-time may contrast high learning algorithm costs with low hardware setup costs or vice versa. We do not claim these aspects are complete, however, at this stage of our research, we found them as overarching for other independent fine granular variables in the literature. In the following, these constructs in relation to green manufacturing are delineated.

**Software design-time aspect.** The design-time aspect deals with writing codes and interfaces for robots in an efficient way. The research by Mahmoud and Ahmad (2013) argues that the way of coding for software systems influences the level of carbon emissions and hence has an indirect impact on the environment. In this manner, for example, Appasami and Suresh Joseph (2011) and Lo and Qian (2010) develop algorithms for compacting codes and data structures, reducing parallelism overhead, and routing data, which helps to control the power consumption by software applications. In the context of writing codes for robots, there are several design time aspects for robot software that should be taken into the account such as the choice of selecting algorithms for managing and allocating resources e.g. sensors, actuators, memory, processors, and robot motions. The generalised positive contributions of applying green practices during the architecture design have been extensively validated in the software engineering and accordingly can be extended to self-reconfigurable robots to postulate the positive impact of applying green practices. If applying the design-time principles for the robot's software is viewed as being relatively important to optimise energy usage and minimise negative impacts on the environment, they are required to be adequately addressed in designing the software components of a robot. Hence, we derive the following hypothesis:

*H1a: Applying green practices during the development of a self-reconfigurable robot's software components positively contributes to greener manufacturing.*

**Software run-time design aspect.** This aspect deals with implementing capabilities in software components of robots to cope with uncertain operating conditions of the environment. Software components which perform robots' functions may need to change their behaviour due to occurrence of faults, resource limitation, or user preference. Self-reconfigurable robots can dynamically reconfigure, optimize, protect, and recover their components and functionalities. Furthermore, the run-time aspects of a robot's software deal with enabling software components to monitor their resource utilisations at the run-time and - if necessary - to improve it. For example, a robot may need to change a resource intensive image processing algorithm in its sensor to a low-energy consuming algorithm if the robot battery is getting low. The run-time adaptation in self-reconfigurable robots can be in the form of changes in the physical environment (e.g. the loss of a power source), changes in the underlying hardware and network infrastructure (e.g. such as a device failure), changes in the available software resources (e.g. update to a behaviour control component) and changes in the scenario goals (e.g. a switch from object following to wall mapping) Edwards et al. (2009). For example, cloud computing-based self-reconfigurable robotics can discover and utilise distributed, virtually unlimited, and powerful hardware/software components on the internet Diaconescu and Wagner (2014; Riazuelo et al. (2014). This means, a robot's components can be dynamically swapped or combined with new ones that have lower energy consumption rates. This is realised through the learning ability of components (e.g. energy-efficient motion planning using machine learning techniques) to acquire knowledge from the environment and to learn how to adapt themselves to new situations. Nevertheless, the fundamental trade-off lies between rearranging the connectivity of a robot's components in order to adapt to new situations and the energy consumed for the execution of tasks by the robot Hu et al. (2012). If dynamic component replacement and resource allocation are not provisioned quickly, effective energy consumption may not be achieved. Moreover, the robot capability in learning and adaptation is constrained by its processing power, storage space, and the number and type of sensors it carries. This may cause developers to ignore incorporating green practices into the run-time aspects of a robot design. The usefulness of applying run-time aspects of the robot's design aspect may have a positive effect on energy consumption. Hence, we hypothesize:

*H1b: The capability of a robot in changing its software components at run-time for efficient energy consumption can positively contribute to greener manufacturing.*

**Hardware design aspect.** Beyond the robot software design, the hardware design may subsequently incur carbon emissions during operation and wasting. For example, a robot may rely on traditional energy sources such as electricity or petroleum oil which may not be an effective energy source in all conditions and presents threats of pollution to the environment Grau Saldes et al. (2016). In addition, one should not be surprised that the raw physical material used for building hardware components of robots is also a major factor for carbon emissions, recycling and even the safe disposal phase of robotic components after their retirement. Hardware components such as processors, memories, actuators, sensors, camera, and other mechanical components, that are controlled and manipulated via software components, can be procured from different suppliers. The substances used in these components may cause excessive carbon emission during high workload Kannan et al. (2014). Hence, eco-design principles should be integrated with the robot hardware design. For example, in the selection of robot hardware components it is advised to find suppliers avoiding the use of illegal



materials, complies with the environmental laws, and offering components that do not contain dangerous and toxic substances. Following this logic, we define that:

*H2a: The use of environmentally friendly material for building hardware components of robots positively contributes to greener manufacturing.*

The research model presented in Figure 1 is preliminary and parsimonious. It integrates predictors for designing green-aware self-reconfigurable robots from different design perspectives. At this stage of the research, we do not claim the presented research model is exhaustive and there may be other predictors of a typical robot design which are left unexplored for future research.

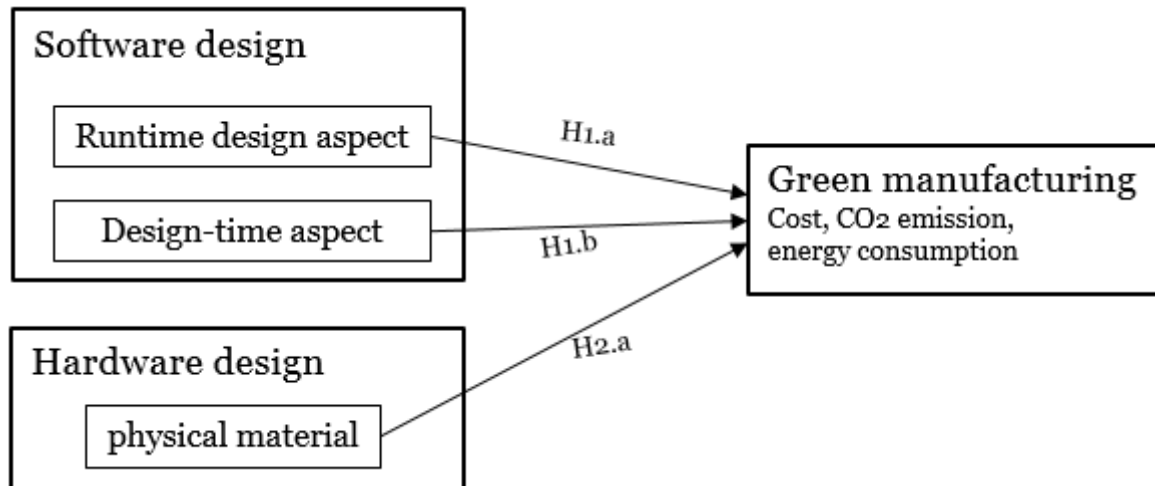

Figure 1: Research model of green-aware robot design for manufacturing

## 4 Research methodology

The next step involves testing the presented research model. We plan to validate the research model in a two-phase study. Firstly, we will conduct semi-structured interviews assessing practitioners' views of the importance of the constructs in addressing green manufacturing requirements. This enables us to initially investigate our contingency constructs for the external validity. Then, our hypothesized model of self-reconfigurable robot design will be tested empirically using a longitudinal survey of engineers with experience in building self-reconfigurable robots for the agriculture sector. Using self-reconfigurable robots in agriculture is aimed at building intelligently efficient farming systems performing repetitive and cumbersome operations such as seeding, weeding, irrigation, culling fruits, and removing those failed to thrive Roldán et al. (2018).

**Survey design and construct measurement.** We have already designed a web-based survey using Qualtrics (Snow and Mann, 2013), a survey designer software able to capture survey results, which is ready to be sent to participants. Our survey has two parts. In the first part, the common terminologies used in the survey including green manufacturing and self-reconfigurable robots are introduced. The second part constitutes a list of questions asking respondents to rate the level of the importance of design aspects in achieving green-aware self-reconfigurable robots. For the rating of importance level of each construct, we use a 1–7 Likert scale: 1 for not-at-all-important, 2 for very unimportant, 3 for somewhat unimportant, 4 for neither important nor unimportant, 5 somewhat important, 6 important, and 7 extremely important. The constructs defined in the research model are measured using multiple-items and seven-point scales. For each construct, a definition including an example is provided to help respondents to get a better understanding of the aspect and the scope of the questions. The respondents can provide additional comments and suggest any missing green design that had to be covered in the model. As mentioned in Section 3, the software design is a two-dimensional construct comprising of two sub-dimensions, i.e. design-time and run-time aspects. The software design-time construct of the self-reconfigurable robot is measured using Mahmoud and Ahmad (2013), Appasami and Suresh Joseph (2011), and Lo and Qian (2010). The software run-time construct is measured using Diaconescu and Wagner (2014; Riazuelo et al. (2014) and Hu et al. (2012). The hardware design construct is measured using variables adapted from Kannan et al. (2014).

**Data collection and analysis.** This voluntary survey will be public and shared through sending email to qualified experts who have a profile in both green manufacturing enablement and robotic systems. An eligible respondent to participate in the survey is a person who has real-world experience

in enabling green awareness using robotic systems. Prior to the recruitment of each participant and through an inquiry email, we ask each participant if he/she has had experience on operationalisation of green practice through utilising capabilities of self-reconfigurable robotic systems. Once the response and profile are found satisfactory, an invitation letter along with the link to the survey is sent through a second email. We also use the purposeful sample technique Kitchenham and Pfleeger (2002) to increase the credibility of the collected responses. That is the first respondent will help us to identify other respondents who may have a satisfactory profile to complete the survey. To test the validity of the model measurements confirmatory factor analysis will be used.

## 5 Research summary, contributions, and limitations

A green aware self-reconfigurable robot design can minimise the overall environmental impact and mitigate the manufacturer's future environmental risks. Understanding the impact of design aspects of self-reconfigurable robots is of practical importance in achieving more environmentally friendly manufacturing and how it can be effectively addressed. We have proposed that self-reconfigurable robot design is involved with the three main constructs of design-time, run-time design, and hardware design. We discussed that all these constructs are equal, even though there can be some trade-offs, for example in terms of cost, or contradictory situations among the constructs. We developed propositions to be attested in further research. More research required to identify the contingencies where self-reconfigurable design can more effective.

This study theorises and empirically attest key factors in designing green-aware self-reconfigurable robots. Through addressing this research question we hope to make both theoretical and practical contributions. Given the rapid growth of utilizing robots in automating manufacturing systems to reduce operating costs and to increase the productivity, we expect the following contributions. First, our research aims to theoretically unpack the critical factors that are to be balanced and taken into account when designing self-reconfigurable robots for making advanced green-aware manufacturing systems. We conceptualise the green-aware design that accordingly has an effect on advanced green manufacturing and Industry 4.0. This connection between self-reconfigurable robots and manufacturing systems can demystify why some manufacturers are better in the realisation of green strategies compared to other others. Secondly, the results of this research provide insights into the important design factors for manufactures interested in utilising or improving existing robotic systems. Moreover, we strengthen the empirical evidence in the literature via collecting and analysing data from the industry sector. So far empirical findings regarding the impact of effective robot design in addressing green manufacturing requirements have not been received attention by researchers. This research also contributes to engineering practice to design or acquire green-aware robots. That is, we expect to demonstrate how companies are able to govern their data analytics related resources to become innovative using available data sources.

Our research findings should be seen in view of some limitations. Firstly, besides of identified constructs presented in the research, there might be many others and hence we do not claim the model completeness. Instead, we developed the first step towards better understanding of efficient self-reconfigurable robot design in the light of green manufacturing. Therewith, we inform scholars and practitioners aim at improving existing or building new green-aware robotic systems. The second limitation is that our data will mainly be collected from agriculture companies designing self-reconfigurable robots. Future research should consider data collection from other industry sectors.

## 6 References

- Ahmad, A., and Babar, M.A. 2016. "Software Architectures for Robotic Systems: A Systematic Mapping Study," *Journal of Systems and Software* (122), pp. 16-39.
- Appasami, G., and Suresh Joseph, K. 2011. "Optimization of Operating Systems Towards Green Computing," *International Journal of Combinatorial Optimization Problems and Informatics* (2:3).
- Brossog, M., Bornschlegl, M., and Franke, J. 2015. "Reducing the Energy Consumption of Industrial Robots in Manufacturing Systems," *International Journal of Advanced Manufacturing Technology* (78).
- Brossog, M., Kohl, J., Merhof, J., Spreng, S., and Franke, J. 2014. "Energy Consumption and Dynamic Behavior Analysis of a Six-Axis Industrial Robot in an Assembly System," *Procedia Cirp* (23), pp. 131-136.
- Deif, A.M. 2011. "A System Model for Green Manufacturing," *Journal of Cleaner Production* (19:14), pp. 1553-1559.

- Diaconescu, I.-M., and Wagner, G. 2014. "Towards a General Framework for Modeling, Simulating and Building Sensor/Actuator Systems and Robots for the Web of Things," *First Workshop on Model-Driven Robot Software Engineering (MORSE)*.
- Edwards, G., Garcia, J., Tajalli, H., et al. 2009. "Architecture-Driven Self-Adaptation and Self-Management in Robotics Systems," *Software Engineering for Adaptive and Self-Managing Systems, 2009. SEAMS'09. ICSE Workshop on: IEEE*, pp. 142-151.
- Grau Saldes, A., Bolea Monte, Y., and Sanfeliu Cortés, A. 2016. "Solutions to Reduce Co2 Emissions for Autonomous Robotics," *World Academy of Science, Engineering and Technology: International science index (vol. 3, núm. 9, 2016): World Academy of Science, Engineering and Technology (WASET)*, pp. 1173-1176.
- Hu, G., Tay, W.P., and Wen, Y. 2012. "Cloud Robotics: Architecture, Challenges and Applications," *IEEE network (26:3)*.
- Jackson, J. 2007. "Microsoft Robotics Studio: A Technical Introduction," *IEEE Robotics & Automation Magazine (14:4)*.
- Kannan, D., de Sousa Jabbour, A.B.L., and Jabbour, C.J.C. 2014. "Selecting Green Suppliers Based on Gscm Practices: Using Fuzzy Topsis Applied to a Brazilian Electronics Company," *European Journal of Operational Research (233:2)*, pp. 432-447.
- Kitchenham, B., and Pfleeger, S.L. 2002. "Principles of Survey Research: Part 5: Populations and Samples," *ACM SIGSOFT Software Engineering Notes (27:5)*, pp. 17-20.
- Knickle, K. 2016. "10 Predictions for the Manufacturing Industry – Idc Futurescape," *Availavle at: [https://idc-community.com/manufacturing/manufacturing-value-chain/10\\_predictions\\_for\\_the\\_manufacturing\\_industry\\_\\_idc\\_futurescape](https://idc-community.com/manufacturing/manufacturing-value-chain/10_predictions_for_the_manufacturing_industry__idc_futurescape) (last access 2018/07/13)*.
- Lo, C.-T.D., and Qian, K. 2010. "Green Computing Methodology for Next Generation Computing Scientists," *Computer Software and Applications Conference (COMPSAC), 2010 IEEE 34th Annual: IEEE*, pp. 250-251.
- Mahmoud, S.S., and Ahmad, I. 2013. "A Green Model for Sustainable Software Engineering," *International Journal of Software Engineering and Its Applications (7:4)*, pp. 55-74.
- Murata, S., and Kurokawa, H. 2007. "Self-Reconfigurable Robots," *IEEE Robotics & Automation Magazine (14:1)*, pp. 71-78.
- Nakabo, Y., Saito, H., Ogure, T., Jeong, S.H., and Yamada, Y. 2009. "Development of a Safety Module for Robots Sharing Workspace with Humans," *Intelligent Robots and Systems, 2009. IROS 2009. IEEE/RSJ International Conference on: IEEE*, pp. 5345-5349.
- Nielsen, I., Dang, Q.-V., Bocewicz, G., and Banaszak, Z. 2017. "A Methodology for Implementation of Mobile Robot in Adaptive Manufacturing Environments," *Journal of Intelligent Manufacturing (28:5)*, pp. 1171-1188.
- Pellicciari, M., Avotins, A., Bengtsson, K., et al. 2015. "Areus–Innovative Hardware and Software for Sustainable Industrial Robotics," *IEEE International Conference on Automation Science and Engineering (IEEE CASE 2015): IEEE*, pp. 1325-1332.
- Quigley, M., Asbeck, A., and Ng, A. 2011. "A Low-Cost Compliant 7-Dof Robotic Manipulator," *Robotics and Automation (ICRA), 2011 IEEE International Conference on: IEEE*, pp. 6051-6058.
- Riazi, S., Bengtsson, K., Bischoff, R., et al. 2016. "Energy and Peak-Power Optimization of Existing Time-Optimal Robot Trajectories," *Automation Science and Engineering (CASE), 2016 IEEE International Conference on: IEEE*, pp. 321-327.
- Riazuelo, L., Civera, J., and Montiel, J.M. 2014. "C2tam: A Cloud Framework for Cooperative Tracking and Mapping," *Robotics and Autonomous Systems (62:4)*, pp. 401-413.
- Roldán, J.J., del Cerro, J., Garzón- Ramos, D., et al. 2018. "Robots in Agriculture: State of Art and Practical Experiences," in *Service Robots*. InTech.
- Stasse, O., Ruland, R., Lamiroux, F., et al. 2009. "Integration of Humanoid Robots in Collaborative Working Environment: A Case Study on Motion Generation," *Intelligent Service Robotics (2:3)*, p. 153.
- Vachon, S., and Klassen, R.D. 2006. "Extending Green Practices across the Supply Chain: The Impact of Upstream and Downstream Integration," *International Journal of Operations & Production Management (26:7)*, pp. 795-821.
- Yim, M., Shen, W.-M., Salemi, B., et al. 2007. "Modular Self-Reconfigurable Robot Systems [Grand Challenges of Robotics]," *IEEE Robotics & Automation Magazine (14:1)*, pp. 43-52.
- Zhu, Q., and Sarkis, J. 2004. "Relationships between Operational Practices and Performance among Early Adopters of Green Supply Chain Management Practices in Chinese Manufacturing Enterprises," *Journal of operations management (22:3)*, pp. 265-289.

# Information Transparency Matters in Relation to Consumer Trust in Food Safety

## **Tri Lam**

UQ Business School  
The University of Queensland  
Queensland, Australia  
Email: t.lam@business.uq.edu.au

## **Jon Heales**

UQ Business School  
The University of Queensland  
Queensland, Australia  
Email: j.heales@business.uq.edu.au

## **Nicole Hartley**

UQ Business School  
The University of Queensland  
Queensland, Australia  
Email: n.hartley@business.uq.edu.au

## **Chris Hodkinson**

UQ Business School  
The University of Queensland  
Queensland, Australia  
Email: c.hodkinson@business.uq.edu.au

## **Abstract**

The purpose of this article is to provide an integrative conceptual model and propositions to assist in understanding whether information transparency matters under the support of traceability systems and online social networking information in relation to consumer trust in food safety. Extant literature forms the foundation for this article. A conceptual model resulting from this proposes that information on food products provided by traceability systems is proposed to stimulate consumers' perceived knowledge of food products. Furthermore, online social networking information advances consumer trust in food product safety. The conceptual model proposes three testable propositions and provides insights into food information that consumers find useful for developing trust in food products.

**Keywords** Food safety management information systems, consumer trust, online social networking information.

## 1 Introduction

This article examines the provision of information along the supply chain from inception to consumption and the influence of information on consumer trust in food products. Repeated scandals about food safety have focused public attention on these issues (Marucheck et al. 2011). Food product safety is related to supply chain risk management, and product safety has recently attracted numerous scholarly studies (e.g. De Boeck et al. 2016, Lee and Whang 2005, Marucheck et al. 2011, Pyke and Tang 2010, Tang 2008). Supply chain risk is typical of a disruption or negative result, and in particular, food safety incidents can be triggered by unforeseeable events throughout a global supply chain (Narasimhan and Talluri 2009). On the one hand, considerable risks to a product involve a sufficiency of information in its packaging and labelling (Marucheck et al. 2011). On the other hand, product safety is associated with the process of decreasing the probability of causing infection, harm, or negative consequences to the consumers (Marucheck et al. 2011). Marucheck et al. (2011) suggest that regulated standards, product management, tracking management and relationships management provide comprehensive and optimal solutions to product safety issues.

In fact, food safety scandals are still recurrent on a regular basis. In 1996, mad cow disease was uncovered in Britain through the effects of the disease-ridden meat that resulted in consumers' distrust in food products (Berg 2004). In December 2010, a food scandal across Germany was uncovered when commercial feed containing high concentrations of the toxic chemical dioxin was used in cattle and egg manufacturing processes (Rieger et al. 2016). In the summer of 2014, Shanghai-based Husi Food Co. Ltd was involved in a food-safety scandal using expired meat, and the scandal extended to some American companies including the Starbucks coffee chain and the Burger King food chain because Shanghai Husi Foods was their supplier in China (Xie and Yao 2016). In September 2014, left-over oil, reprocessed oil, and animal feed oil were sold as edible oil in Taiwan, which created a negative impact on Taiwan's food reputation internationally (Ko 2015). Prior to this, between April and July of 2011, a phthalate-tainted food scandal was revealed in Taiwan in which phthalates were deliberately added to several types of food (Tsai et al. 2016). Consequently, food fraud damaged the reputation of food producers (e.g. see Xie and Yao 2016), and created consumer distrust (Spink and Moyer 2011). As a result of these instances, it is debatable whether information retrieved from food traceability systems and online social networks is enough to enhance consumer trust in food products.

Information concerning food quality and safety, and the provision of information relevant to food supply chain are a necessity for food consumers (Lehmann et al. 2011). Chen (2011) found that many consumers were reliant on food product information as it assisted them in food purchase decision making. Therefore, the first research question (RQ1) is: "How food product-related information provided by food traceability systems influences consumer trust in food safety?" When information on food products is provided, communication about the matters of food safety through social media has an influence on product beliefs (Mou and Lin 2014). Based on that, the second research question RQ2 is: "How does online social networking food product-related information intensify consumer trust intentions?" This article continues the progressive research into the factors which influence consumer's trust in food safety and fills a gap in the literature by integrating the extant information systems management and consumer behaviour literatures.

This research project commences by reviewing previous literature on food traceability, consumer trust, food product communication and social media. The application of Social Cognitive Theory (SCT) is then used to integrate perceived knowledge of food products provided by traceability systems with online social networking food product-related information and consumer trust intentions in food safety. Theoretical and practical contributions and implications conclude the paper.

## 2 Previous Literature

In relation to food safety management, information systems refer to data collection, storage, assessment and retrieval (McMeekin et al. 2006). Information systems influence and frame the way for users to make decisions on the safety of food (McMeekin et al. 2006). Specifically, information systems can facilitate Hazard Analysis of Critical Control Points (HACCP), an organised approach that is entailed in carefully documenting all information and actions on food processing and operations (McMeekin et al. 2006). Szymanska (2015) also suggested that electronic information systems were a tool supporting food processing at all stages of formation and supervision. The computer-based tool provides information on farmers and food producers to customers, and shows a product's origin and its composition (Szymanska 2015). Thus food safety management systems (FSMSs) instrument providing food producers with information via reports of authentication and corroboration have been developed (Kirezieva et al. 2013).

FSMSs refer to the accountability of both the safety of foods and transparency in processing foods (Motarjemi and Mortimore 2005). Food safety management and the control of risks should be approached proactively through efficient FSMSs (Zwietering et al. 2016). Swoffer (2009) indicated that food safety management included raw materials management, usage delineation, and the scrutiny of final products. However, product safety has been perceived as resulting from technical issues such as risks from flawed operational processes that may cause negative consequences for internal and external stakeholders (Lewis 2003) – Table 1 shows stakeholders in food processing and supply chain.

Stakeholders	Role	Information relevant to food processing and supply chain	Supporting literature
Food producers	Ensuring consumers the safety of foods	Information of food processing and supply chain	Motarjemi and Mortimore (2005), Govindan (2018)
Consumers bodies or organisations	Providing guidance	Information about guidance on food safety	Motarjemi and Mortimore (2005), Govindan (2018)
Governments	Formulating, implementing and following policies on food safety	Information about the occurrence of any foodborne illness	Motarjemi and Mortimore (2005), Govindan (2018)
	Communicating and educating	Information on up-to-date foodborne issues via mass media and on the Internet	Motarjemi and Mortimore (2005), Govindan (2018)
Various middlemen including distributors, wholesalers and retailers	Coordinating with manufacturers	Information about actions such as distribution and storage	Motarjemi and Mortimore (2005), Manders et al. (2016)
Consumers	Consuming food products	Information concerning blame and/or experience	Barbarossa et al. (2016), Manning (2015)
		Information about discussions on food safety and risk issues	Mou and Lin (2014), and Wu (2015)

Table 1. The extant literature on stakeholders in food processing and supply chain

From a safety perspective, food safety has causal relationships with food supply chains which typically have numerous vulnerabilities, e.g. warehouse and transportation management (Whipple et al. 2009). As a result, the analysis of information concerning FSMSs in a produce chain is likely to provide insights as to quality assurance, and elicit appropriate responses to product safety concerns (Kirezieva et al. 2013). The fundamental component of FSMSs is traceability systems to collect information about activities.

## 2.1 Traceability systems and Food Producer Trust

According to Mattevi and Jones (2016), the main purpose of traceability relates to the safety and quality of products. Wang and Huang (2010) proposed that a traceability system can ameliorate food supply chain performance by monitoring information about potential vulnerability. Traceability or tracing systems can help diagnose the problem and provide information about suppliers, competent authorities and customers (McMeekin et al. 2006). In addition, traceability systems assist in tracking potentially unreliable products in order to take timely preventative and corrective actions (Jansen-Vullers et al. 2003). Therefore a study conducted by Bánáti (2014) recommends that an amalgamation of producer's responsibility, trackability, risk analysis, risk evaluation and risk management is capable of reviving consumers' lost trust but only if it is visible to the consumer.

Due to globalisation, food supply chains necessitate traceability systems to ensure safety and to identify failures in food processing; and many countries have imposed a requirement for traceability systems (King et al. 2017). The integration of traceability systems into information systems assists product

traceability, and facilitates the development of mobile application for users (Cagliano et al. 2017). For instance, the application of radio-frequency identification (RFID) technology helps track and monitor farm produce and transform the conventional ways of food chain management (Ruiz-Garcia and Lunadei 2011). As a result, tracking and tracing systems throughout the food processing and supply chain are advantageous to stakeholders as they provide on time data collection and thus information transparency (Li et al. 2017). The retention of transparency in a food chain makes consumers feel safe, and aids in restoring consumer trust for food product brands (Chiu 2016).

## 2.2 Consumer Trust

From social theory perspective, the underlying assumption of trust is the belief of a trustor (e.g. food consumers) in a trustee (e.g. food producers) who has competence in satisfying a trustor requirement honestly in a given context (Grandison and Sloman 2003). According to Chen (2008), actors in a food system, monitoring bodies, and truth telling are determinants in consumer trust in food safety. De Jonge et al. (2010) found that optimism and pessimism about food safety were strongly related to trust in food manufacturers. A recent study also shows that perceived country of origin is positively associated with consumers' perception of the reliability and controllability of food incidents, thus lessening consumers' ascription of untrustworthy brands (Barbarossa et al. 2016). Another approach developed by Lassoued and Hobbs (2015) indicates that consumers' perceived brand competence is positively associated with brand trust, i.e. confidence in the safety and quality of food products. A summary of the existing literature on consumer trust in food safety is in Table 2.

Theory & Literature	Independent Variable(s)	Dependent Variable(s)	Supporting Literature
From culture perspective	1. Actors in a food system 2. Monitoring bodies 3. Truth telling	Consumers' trust in food safety	Chen (2008)
Consumer confidence in the safety of food	Trust in food manufacturers	Optimism and pessimism about food safety	De Jonge et al. (2010)
The combination of attribution theory, country of origin and national stereotypes frameworks	Perceived country of origin	Consumers' attributions of blame	Barbarossa et al. (2016)
Perceived brand competence	Perceived brand competence for quality and safety in food	Brand trust	Lassoued and Hobbs (2015)

Table 2. The extant literature on consumer trust in food safety

As seen, consumer trust in food safety is scrutinised from different approaches including culture and marketing perspectives. However, the concept of trust is multi-dimensional, and providing truthful information is generally regarded as a prominent characteristic of trust (Frewer et al. 1996).

## 2.3 Food Product Communication and Online Social Networking

Yiannas (2009) recommended the use of multi-media for communicating food safety information such as leaflets, video and websites. A variety of information sources exert a positive and significant influence on consumer trust (Liu et al. 2014). Consumers' trust in food information communicated by public organisations is greater than by private associations (Nocella et al. 2014). For example, Zhang et al. (2016) found that government was the most trustworthy source of information concerning food safety, compared to private certification schemes, e.g. the Safe Quality Food (SQF) Program, a civil-society organisation. In addition, promotional materials related to food safety and health risks increase consumers' awareness of food safety issues (Verçuni et al. 2016).

Social networking sites have provided users with a unique platform for sharing and discussing food safety information (Mou and Lin 2014). Online social networking (OSN) refers to social interactions between individuals about their everyday experiences by providing a venue with appropriate online tools (Merchant 2012). According to Wu's (2015) findings, social media users having positive emotions and concerns about food safety issues tend to search for food safety information and to learn from others. The use of social networking websites for risk consultation pertinent to food safety issues is influenced

by risk awareness, sentiment, social trust, and social assistance factors (Wu 2015). As such, information and discussions about food products and food safety matters between consumers through social media helps to develop trust intentions in food products.

### 3 Conceptual Development

Food product-related information comes from a wide variety of sources and channels, especially with the support of the Internet and social media. This article aims to develop a conceptual model to predict cognitive perceptions which follows the associations between individual perceived knowledge, social information, and attitude intentions via Social Cognitive Theory (SCT). SCT focuses on cognitive factors (knowledge about a particular fact gained by each individual), environmental elements (facilities and tools designed for a person's eagerness for certain behaviours), and behavioural capabilities (a person's behaviour shaped by their beliefs, attitudes, and perception) that influence each other (Bandura 1986). SCT suggests that personal perceived behaviour (intentions) beliefs (perceive knowledge) and facilities (social information) have interactive associations.

Based on SCT perspective, perceived knowledge of food product provided by food traceability systems, food product-related discussion facilitated by social media, and consumer trust intentions interact each other. A conceptual model is proposed as follows, which focuses on the use of traceability systems and OSN food product-related information that support consumers' trust intentions in food safety. The following subsections will refer to the derivations of the propositions.

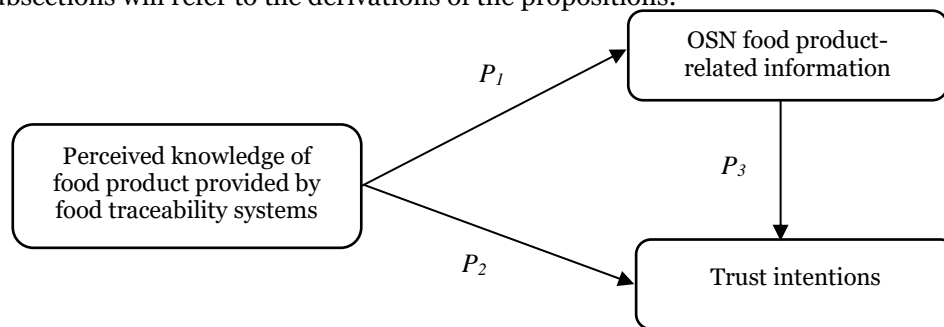

Figure 1. Conceptual model

#### 3.1 Perceived Knowledge of Food Product Provided by Traceability Systems and OSN Food Product-Related Information

Derived from SCT, a person's perceive knowledge is in association with their social information need (Bandura 1986). To diminish food contamination and incidents, firms and partners connect each other by accessing reliable and well-timed information concerning supply chain disruptions and outcomes (Premkumar et al. 2005). For instance, the information about date, health benefits, nutrition information, country of origin, and ingredients on food packaging is what can be communicated to consumers with the intention of increasing customer trust (Chan et al. 2012). The above food-related information is managed by FSMSs (Kireziova et al. 2013). Based in part upon such product information, consumers' knowledge of food products is constructed.

However, to lower perceived risk, consumers require more information to support their food safety perceptions which, in turn, increase their behaviour towards food products (Eiser et al. 2002). With the support of the Internet, communication is easier for consumers who can search for information through online channels (Lee et al. 2000). Statements made by consumers on the Internet and related to a product or corporate brand are considered as electronic word-of-mouth (eWOM) communication (Stauss 2000). Word-of-mouth (WOM) refers to information communications between informal parties as regards assessment of goods and services (Singh 1988; Westbrook 1987). Electronic word-of-mouth communication refers to and includes the following: 'writing', 'liking', 'sharing', 'recommending', 'commenting on', and 'tweeting' brand-related messages on Facebook, Twitter, and other social network media (Wolny and Mueller 2013). These constitute nuanced measures of WOM from a giver's perspective upon goods and services for a particular firm given in the electronic environment (Harrison-Walker 2001). Notably, online communication presents a large volume of information that is disseminated in cyberspace, which has no geographical limitations, and many-to-many online relationships (Wolny and Mueller 2013). These arguments lead to the proposition that:



*P1: A high degree of perceived knowledge of food products provided by traceability systems will be associated with OSN food product-related information.*

### **3.2 Perceived Knowledge of Food Product Provided by Traceability Systems and Trust Intentions**

The second association proposed by Bandura (1986) is between a person's perceived knowledge and behavioural intentions. Consumer trust in food safety is created when they think food items are safe to eat (Chen 2008). Food is safe when it will not cause sickness or harm to people who consume it, provided that the food is consumed as instructed (Australia New Zealand Food Authority 2016). As mentioned in Table 2, the food supply chain, government involvement, optimism and pessimism, country of origin, and brand competence are pertinent to gaining consumer trust in food products. However, there are still other elements to consider.

Smigic et al. (2015) indicated that there was a need for transparency between various legal authorities and food business operators. Information asymmetry increases consumers' perceived risk, in turn which is likely to use traceability systems (Yoo et al. 2015). Consumers' motives for using traceability systems are reducing perceived risk due to information asymmetry. Producers must retain sufficient records including processing operations, systematic examination, harvesting areas, storage, transportation, and food receipts to corroborate food products are safe by traceability systems (Australia New Zealand Food Authority 2016). To decrease perceptions of risk, the more information provided by food traceability systems to consumers increases their trust in food products (Eiser et al. 2002).

*P2: A high degree of perceived knowledge of food products provided by traceability systems will be associated with trust intentions.*

### **3.3 OSN Food Product-Related Information and Trust Intentions**

The third association based on SCT (Bandura 1986) is the relation between social information facilitated by social media and consumer trust intentions. Trust is aroused by cognition, and evoked by emotion through interpersonal dynamics with the support of information technology (Komiak and Benbasat 2006). Hobbs (2004) showed that consumers preferred to know the safety of food before eating it, otherwise, information asymmetry (e.g. quality attributes known only to producers) can result in market failure. Information asymmetry can frustrate consumers and lead to a loss of confidence in food products among consumers.

The development of the Internet and social network sites, aka online communication, have assisted in reducing information asymmetry and its negative effects by allowing buyers to communicate information on product quality and share their experiences (Izquierdo and Izquierdo 2007). The use of microblogs is associated with generating public awareness of food safety scandals, and they are deemed as a stronger predictor of food safety risk perception compared to other offline media such as television, newspapers and magazines (Mou and Lin 2014). Consumers provide feedback on a product, and in turn, a receiver builds up a personal judicious perception of product or service features (Allsop et al. 2007). Consumers are subjected to a variety of positive and negative information about food to influence their trust in a food product (Scholderer and Frewer 2003). This leads to:

*P3: OSN food product-related information will be associated with consumer trust intentions.*

## **4 Discussion and Conclusion**

Transparency and accountability in the food production chain are desired by consumers so as to know the sources and processes from farm to fork. Incomplete information disclosure of the attributes of food product production is deemed as misspecification, and has the potential to ruin trust between consumers and producers (Mishra et al. 1998). A dearth of reliable information on the market such as dishonest and cheating behaviours could result in a failure in gaining consumer trust (Granovetter 1985), whereas providing trustful information about food products could greatly augment consumer trust (Adler 2001). Traceability systems enable consumers to retrieve information regarding food safety along the processing and supply chain. Traceability assists in tracking any food product through all stages from production, processing to distribution. Traceability also supports mechanisms for tracing backwards and forward at any point in the supply and processing chain (Australia New Zealand Food Authority 2016).

The disclosed information in food traceability systems influences consumer's trust in choosing food products at the point of sale. Additionally, OSN food product-related information bolsters (undermines) consumer trust in a firm's food product. This pragmatic and holistic approach to food chain information

is important to consumers due to potential information asymmetry between producers and consumers. FSMs attempt to close this gap. Thus, accurate and readily available information disclosure is a value-added process for both producers and consumers.

Online feedback mechanisms are corroborated to develop trust in sellers' credibility (Ba and Pavlou 2002). Positive feedback results in both a trustworthy signal and a good feedback profile (Greif 1989; Milgrom et al. 1990). On the other hand, negative feedback leads to not only brand detriment but also financial loss (Lee et al. 2000; Webster and Sundaram 1998). For instance, eBay's Feedback Forum is a channel where buyers provide feedback or reviews about their transactions with sellers. OSN product-related information is able to affect the user's judgement and facilitate credibility trust.

This research seeks to enhance SCT by examining how technology-supported information influences consumer trust in the context of food safety. Technologies here include traceability systems and social media. The associations between perceived knowledge of food products provided by traceability systems, OSN food product-related information and consumer trust in food safety are articulated. Definitively, the relationships between variables are proposed to be testable.

Food producers can know which factors have positive/negative associations with consumer trust intentions. In addition, food producers can use the constructs and relationships proposed in this model to ameliorate their own FSMs and OSN communication strategy to increase consumer trust intentions. Finally, there is a possible application to influence consumer purchase behaviour and win consumer loyalty when consumers trust in a product.

The integrated model facilitates cognitive elaboration of consumer trust in food products. The most far-reaching implication is the identification of consumers' information need so that some means of communication, such as mobile phone applications, company websites, and social network sites, can be developed to provide appropriate and useful food product information to consumers. Contingent on the food producer's situation, they can work out their own internal and external information systems and decide how their food product information will be disseminated. This will offer valuable assistance in gaining consumer trust. Information on food products is also useful for developing policy on food safety management to prevent foodborne diseases. This might also help reduce societal healthcare costs due to the reduction of food-induced illnesses and industry costs associated with product recalls.

There are several limitations in this article that need consideration. Firstly, other aspects of consumer trust such as consumer practices (Zhang et al. 2016) have not been included in this article. Further research may consider the association between consumers' trust intention and their actual purchasing behaviour. Secondly, this research only considers the effects of OSN food product-related information on consumer trust. Future research could examine the influence of the general mass media on consumer trust in food products. Lastly, this is a conceptual paper that has not proposed any empirics. Hence, the testable model can be further evaluated by using quantitative methods e.g. survey methods.

## 5 References

- Adler, P. S. 2001. "Market, hierarchy, and trust: The knowledge economy and the future of capitalism," *Organization Science*, (12:2), pp. 215–234.
- Allsop, D. T., Bassett, B. R., and Hoskins, J. A. 2007. "Word-of-mouth research: Principles and applications," *Journal of Advertising Research*, (47:4), pp. 398–411 (doi: 10.2501/S0021849907070419).
- Australia New Zealand Food Authority. 2016. *A Guide to the Food Safety Standards Safe Food Australia*, (3rd editio., Vol. 2), Creative Commons Attribution 3.0 Australia (available at [https://www.foodstandards.gov.au/publications/documents/complete\\_safefood.pdf](https://www.foodstandards.gov.au/publications/documents/complete_safefood.pdf)).
- Ba, S., and Pavlou, P. a. 2002. "Evidence of the effect of trust building technology in electronic markets: Price premiums and buyer behavior," *MIS Quarterly*, (26:3), pp. 243–268 (available at <http://www.jstor.org/stable/4132332>).
- Bánáti, D. 2014. "European perspectives of food safety," *Journal of the Science of Food and Agriculture*, (94:10), pp. 1941–1946 (doi: 10.1002/jsfa.6611).
- Bandura, A. 1986. *Social Foundations of Thought and Action: A Social Cognitive Theory Social Foundations of Thought and Action: A Social Cognitive Theory*, Prentice-Hall series in social learning theory, Englewood Cliffs, N.J.: Prentice-Hall.
- Barbarossa, C., De Pelsmacker, P., Moons, I., and Marcati, A. 2016. "The influence of country-of-origin

- stereotypes on consumer responses to food safety scandals: The case of the horsemeat adulteration,” *Food Quality and Preference*, (53), Elsevier Ltd, pp. 71–83 (doi: 10.1016/j.foodqual.2016.05.015).
- Berg, L. 2004. “Trust in food in the age of mad cow disease: A comparative study of consumers’ evaluation of food safety in Belgium, Britain and Norway,” *Appetite*, (42:1), pp. 21–32 (doi: 10.1016/S0195-6663(03)00112-0).
- De Boeck, E., Jacxsens, L., Bollaerts, M., Uyttendaele, M., and Vlerick, P. 2016. “Interplay between food safety climate, food safety management system and microbiological hygiene in farm butcheries and affiliated butcher shops,” *Food Control*, (65), Elsevier Ltd, pp. 78–91 (doi: 10.1016/j.foodcont.2016.01.014).
- Cagliano, A. C., De Marco, A., and Rafele, C. 2017. “E-grocery supply chain management enabled by mobile tools,” *Business Process Management Journal*, (23:1), pp. 47–70 (doi: 10.1108/BPMJ-01-2016-0002).
- Chan, C., Kam, B. H., Coulthard, D., and Button, P. 2012. “Consumer Trust of Food Product Information & Its sources,” (available at <https://www.gs1au.org/WorkArea/DownloadAsset.aspx?id=2147484565>).
- Chen, M. F. 2008. “Consumer trust in food safety—A multidisciplinary approach and empirical evidence from Taiwan,” *Risk Analysis*, (28:6), pp. 1553–1569 (doi: 10.1111/j.1539-6924.2008.01115.x).
- Chen, M. F. 2011. “Consumer’s trust-in-food-safety typology in Taiwan: Food-related lifestyle matters,” *Health, Risk & Society*, (13:6), pp. 503–526.
- Chiu, H. K. 2016. “Exploring the factors affecting consumer boycott behavior in Taiwan: Food oil incidents and the resulting crisis of brand trust,” *International Journal of Business and Information*, (11:1), pp. 49–66.
- Eiser, J. R., Miles, S., and Frewer, L. J. 2002. “Trust, perceived risk, and attitudes toward food technologies,” *Journal of Applied Social Psychology*, (32:11), pp. 2423–2433 (doi: 10.1111/j.1559-1816.2002.tb01871.x).
- Frewer, L. J., Howard, C., Hedderley, D., and Shepherd, R. 1996. “What determines trust in information about food-related risks? Underlying psychological constructs,” *Risk Analysis*, (16:4), pp. 473–486 (available at <http://www.ncbi.nlm.nih.gov/pubmed/8819340>).
- Govindan, K. 2018. “Sustainable consumption and production in the food supply chain: A conceptual framework,” *International Journal of Production Economics*, (195:March 2017), Elsevier Ltd, pp. 419–431 (doi: 10.1016/j.ijpe.2017.03.003).
- Grandison, T., and Sloman, M. 2003. “Trust management tools for Internet applications,” in *Proceedings of the 1st International Conference on Trust Management*, P. Nixon and S. Terzis (eds.), Heraklion, Crete, Greece: Springer-Verlag Berlin Heidelberg NewYork, pp. 91–107.
- Granovetter, M. 1985. “Economic action and social structure: The problem of embeddedness,” *American Journal of Sociology*, (91:3), pp. 481–510 (available at <http://www.jstor.org/stable/2393756>).
- Greif, A. 1989. “Reputation and coalitions in Medieval trade: Evidence on the Maghribi traders,” *Journal of Economic History*, (49:4), pp. 857–882.
- Harrison-Walker, L. J. 2001. “The measurement of word-of-mouth communication and an investigation of service quality and customer commitment as potential antecedents,” *Journal of Service Research*, (4:1), pp. 60–75 (doi: 10.1177/109467050141006).
- Hobbs, J. E. 2004. “Information asymmetry and the role of traceability systems,” *Agribusiness*, (20:4), pp. 397–415 (doi: 10.1002/agr.20020).
- Izquierdo, S. S., and Izquierdo, L. R. 2007. “The impact of quality uncertainty without asymmetric information on market efficiency,” *Journal of Business Research*, (60:8), pp. 858–867 (doi: 10.1016/j.jbusres.2007.02.010).
- Jansen-Vullers, M. H., Van Dorp, C. A., and Beulens, A. J. M. 2003. “Managing traceability information in manufacture,” *International Journal of Information Management*, (23:5), pp. 395–413 (doi: 10.1016/S0268-4012(03)00066-5).
- De Jonge, J., van Trijp, H., Renes, R. J., and Frewer, L. J. 2010. “Consumer confidence in the safety of food and newspaper coverage of food safety issues: A longitudinal perspective,” *Risk Analysis*,

- (30:1), pp. 125–142 (doi: 10.1111/j.1539-6924.2009.01320.x).
- King, T., Cole, M., Farber, J. M., Eisenbrand, G., Zabaras, D., Fox, E. M., and Hill, J. P. 2017. “Food safety for food security: Relationship between global megatrends and developments in food safety,” *Trends in Food Science and Technology*, (68), Elsevier Ltd, pp. 160–175 (doi: 10.1016/j.tifs.2017.08.014).
- Kirezieva, K., Jacxsens, L., Uyttendaele, M., Van Boekel, M. A. J. S., and Luning, P. A. 2013. “Assessment of food safety management systems in the global fresh produce chain,” *Food Research International*, (52:1), Elsevier Ltd, pp. 230–242 (doi: 10.1016/j.foodres.2013.03.023).
- Ko, W. H. 2015. “Food suppliers’ perceptions and practical implementation of food safety regulations in Taiwan,” *Journal of Food and Drug Analysis*, (23:4), Elsevier Ltd, pp. 778–787 (doi: 10.1016/j.jfda.2015.05.006).
- Komiak, S. Y. X., and Benbasat, I. 2006. “The effects of personalization and familiarity on trust and adoption of recommendation agents,” *MIS Quarterly*, (30:4), pp. 941–960 (doi: 10.1002/fut).
- Lassoued, R., and Hobbs, J. E. 2015. “Consumer confidence in credence attributes: The role of brand trust,” *Food Policy*, (52), Elsevier Ltd, pp. 99–107 (doi: 10.1016/j.foodpol.2014.12.003).
- Lee, H. L., and Whang, S. 2005. “Higher supply chain security with lower cost: Lessons from total quality management,” *International Journal of Production Economics*, (96:3), pp. 289–300 (doi: 10.1016/j.ijpe.2003.06.003).
- Lee, J., Kim, J., and Moon, J. Y. 2000. “What makes Internet users visit cyber stores again? Key design factors for customer loyalty,” in *Proceedings of the SIGCHI conference on Human Factors in Computing Systems*, pp. 305–312 (doi: 10.1145/332040.332448).
- Lee, Z., Im, I., and Lee, S. J. 2000. “The effect of negative buyer feedback,” in *Twenty-first International Conference on Information Systems*, W. J. Orlikowski, S. Ang, P. Weill, H. Krcmar, and J. I. DeGros (eds.), Brisbane, pp. 286–287.
- Lehmann, R. J., Hermansen, J. E., Fritz, M., Brinkmann, D., Trienekens, J., and Schiefer, G. 2011. “Information services for European pork chains - Closing gaps in information infrastructures,” *Computers and Electronics in Agriculture*, (79:2), Elsevier B.V., pp. 125–136 (doi: 10.1016/j.compag.2011.09.002).
- Lewis, M. 2003. “Cause, consequence and control: towards a theoretical and practical model of operational risk,” *Journal of Operations Management*, (21:2), pp. 205–224 (doi: 10.1016/S0272-6963(02)00071-2).
- Li, Z., Liu, G., Liu, L., Lai, X., and Xu, G. 2017. “IoT-based tracking and tracing platform for prepackaged food supply chain,” *Industrial Management & Data Systems*, (117:9), pp. 1906–1916 (doi: 10.1108/IMDS-11-2016-0489).
- Liu, R., Pieniak, Z., and Verbeke, W. 2014. “Food-related hazards in China: Consumers’ perceptions of risk and trust in information sources,” *Food Control*, (46), Elsevier Ltd, pp. 291–298 (doi: 10.1016/j.foodcont.2014.05.033).
- Manders, J. H. M., Caniëls, M. C. J., and Ghijsen, P. W. T. 2016. “Exploring supply chain flexibility in a FMCG food supply chain,” *Journal of Purchasing and Supply Management*, (22:3), Elsevier, pp. 181–195 (doi: 10.1016/j.pursup.2016.06.001).
- Manning, L. 2015. “Determining value in the food supply chain,” *British Food Journal*, (117:11), pp. 2649–2663 (doi: 10.1108/BFJ-02-2015-0049).
- Marucheck, A., Greis, N., Mena, C., and Cai, L. 2011. “Product safety and security in the global supply chain: Issues, challenges and research opportunities,” *Journal of Operations Management*, (29:7–8), Elsevier B.V., pp. 707–720 (doi: 10.1016/j.jom.2011.06.007).
- Mattevi, M., and Jones, J. A. 2016. “Food supply chain: Are UK SMEs aware of concept, drivers, benefits and barriers, and frameworks of traceability?,” *British Food Journal*, (118:5), pp. 1107–1128 (doi: <http://dx.doi.org/10.1108/MRR-09-2015-0216>).
- McMeekin, T. A., Baranyi, J., Bowman, J., Dalgaard, P., Kirk, M., Ross, T., Schmid, S., and Zwietering, M. H. 2006. “Information systems in food safety management,” *International Journal of Food Microbiology*, (112:3), pp. 181–194 (doi: 10.1016/j.ijfoodmicro.2006.04.048).
- Merchant, G. 2012. “Unravelling the social network: Theory and research,” *Learning, Media and*

- Technology*, (37:1), pp. 4–19 (doi: 10.1080/17439884.2011.567992).
- Milgrom, P., North, D., and Weingast, B. 1990. “The role of institutions in the revival of trade: The medieval Law Merchant,” *Economics and Politics*, (2:1), pp. 1–23 (doi: doi:10.1111/j.1468-0343.1990.tb00020.x).
- Mishra, D. P., Heide, J. B., and Cort, S. G. 1998. “Information asymmetry and levels of agency relationships,” *Journal of Marketing Research*, (35:3), pp. 277–295 (doi: 10.2307/3152028).
- Motarjemi, Y., and Mortimore, S. 2005. “Industry’s need and expectations to meet food safety, 5th International Meeting: Noordwijk Food Safety and HACCP Forum 9-10 December 2002,” *Food Control*, (16:6 SPEC. ISS.), pp. 523–529 (doi: 10.1016/j.foodcont.2004.10.014).
- Mou, Y., and Lin, C. A. 2014. “Communicating food safety via the social media: The role of knowledge and emotions on risk perception and prevention,” *Science Communication*, (36:5), pp. 593–616 (doi: 10.1177/1075547014549480).
- Narasimhan, R., and Talluri, S. 2009. “Perspectives on risk management in supply chains,” *Journal of Operations Management*, (27:2), pp. 114–118 (doi: 10.1016/j.jom.2009.02.001).
- Nocella, G., Romano, D., and Stefani, G. 2014. “Consumers’ attitudes, trust and willingness to pay for food information,” *International Journal of Consumer Studies*, (38:2), pp. 153–165 (doi: 10.1111/ijcs.12080).
- Premkumar, G., Ramamurthy, K., and Saunders, C. S. 2005. “Information processing view of organizations: An exploratory examination of fit in the context of interorganizational relationships,” *Journal of Management Information Systems*, (22:1), pp. 257–294 (doi: 10.1080/07421222.2003.11045841).
- Pyke, D., and Tang, C. S. 2010. “How to mitigate product safety risks proactively? Process, challenges and opportunities,” *International Journal of Logistics Research and Applications*, (13:4), pp. 243–256 (doi: 10.1080/13675561003720214 <http://www.informaworld.com>).
- Rieger, J., Kuhlgatz, C., and Anders, S. 2016. “Food scandals, media attention and habit persistence among desensitised meat consumers,” *Food Policy*, (64), Elsevier Ltd, pp. 82–92 (doi: 10.1016/j.foodpol.2016.09.005).
- Ruiz-Garcia, L., and Lunadei, L. 2011. “The role of RFID in agriculture: Applications, limitations and challenges,” *Computers and Electronics in Agriculture*, (79:1), Elsevier B.V., pp. 42–50 (doi: 10.1016/j.compag.2011.08.010).
- Scholderer, J., and Frewer, L. J. . 2003. “The biotechnology communication paradox: Experimental evidence and the need for a new strategy,” *Journal of Consumer Policy*, (26:2), pp. 125–157.
- Singh, J. 1988. “Consumer complaint intentions and behavior: Definitional and taxonomical issues,” *Journal of Marketing*, (52:1), pp. 93–107 (doi: 10.2307/1251688).
- Smigic, N., Rajkovic, A., Djekic, I., and Tomic, N. 2015. “Legislation, standards and diagnostics as a backbone of food safety assurance in Serbia,” *British Food Journal*, (117:1), pp. 94–108 (doi: 10.1108/BFJ-08-2013-0228).
- Spink, J., and Moyer, D. C. 2011. “Defining the public health threat of food fraud,” *Journal of Food Science*, (76:9), pp. 157–163 (doi: 10.1111/j.1750-3841.2011.02417.x).
- Stauss, B. 2000. “Using New Media for Customer Interaction: A Challenge for Relationship Marketing,” in *Relationship Marketing: Gaining Competitive Advantage Through Customer Satisfaction and Customer Retention*, T. Hennig-Thurau and U. Hansen (eds.), (1<sup>st</sup> ed.), Berlin, Heidelberg: Springer Berlin Heidelberg, pp. 232–253 (doi: 10.1007/978-3-662-09745-8).
- Swoffer, K. 2009. “GFSI and the relationship with Codex,” in *Presentation made at CIES International Food Safety Conference*, Barcelona.
- Szymanska, K. 2015. “Information system as a tool guaranteeing food safety and controlling food market,” in *10th International Scientific Conference on Economic and Social Development*, Miami, pp. 95–102.
- Tang, C. S. 2008. “Making products safe: Process and challenges,” *International Commerce Review*, (8:1), pp. 48–55 (doi: 10.1007/s12146-008-0028-2).
- Tsai, H. J., Chen, B. H., Wu, C. F., Wang, S. L., Huang, P. C., Tsai, Y. C., Chen, M. L., Ho, C. K., Hsiung,

- C. A., and Wu, M. T. 2016. "Intake of phthalate-tainted foods and microalbuminuria in children: The 2011 Taiwan food scandal," *Environment International*, (89–90:100), Elsevier B.V., pp. 129–137 (doi: 10.1016/j.envint.2016.01.015).
- Verçuni, A., Zhllima, E., Imami, D., Bijo, B., Hamiti, X., and Bicoku, Y. 2016. "Analysis of consumer awareness and perceptions about food safety in Tirana , Albania," *Albanian Journal of Agricultural Sciences*, (15:1), pp. 19–26.
- Wang, D., and Huang, D. 2010. "Food supply chain management under conditions of food safety," in *2010 International Conference on Management and Service Science*, IEEE, August, pp. 1–4 (doi: 10.1109/ICMSS.2010.5577267).
- Webster, C., and Sundaram, D. S. 1998. "Service consumption criticality in failure recovery," *Journal of Business Research*, (41:2), pp. 153–159.
- Westbrook, R. A. 1987. "Product/consumption-based affective responses and postpurchase processes," *Journal of Marketing Research*, (24:3), pp. 258–270 (doi: 10.2307/3151636).
- Whipple, J. M., Voss, M. D., and Closs, D. J. 2009. "Supply chain security practices in the food industry: Do firms operating globally and domestically differ?," *International Journal of Physical Distribution & Logistics Management*, (39:7), pp. 574–594 (doi: 10.1108/09600030910996260).
- Wolny, J., and Mueller, C. 2013. "Analysis of fashion consumers' motives to engage in electronic word of mouth communication through social media platforms," *Journal of Marketing Management*, (29:5–6), pp. 562–583 (doi: 10.1080/0267257X.2013.778324).
- Wu, C. W. 2015. "Facebook users' intentions in risk communication and food-safety issues," *Journal of Business Research*, (68:11), Elsevier Inc., pp. 2242–2247 (doi: 10.1016/j.jbusres.2015.06.005).
- Xie, Y., and Yao, X. 2016. "A content analysis of the image repair discourses of OSI Group in China's food-safety scandal," *Asian Agricultural Research*, (8:2), pp. 68–72.
- Yiannas, F. 2009. "Communicating Food Safety Effectively," in *Food Safety Culture: Creating a Behavior-Based Food Safety Management System*, New York: Springer, pp. 49–55 (doi: 10.1007/978-0-387-72867-4).
- Yoo, C. W., Parameswaran, S., and Kishore, R. 2015. "Knowing about your food from the farm to the table: Using information systems that reduce information asymmetry and health risks in retail contexts," *Information and Management*, (52:6), Elsevier B.V., pp. 692–709 (doi: 10.1016/j.im.2015.06.003).
- Zhang, L., Xu, Y., Oosterveer, P., and Mol, A. P. J. 2016. "Consumer trust in different food provisioning schemes: Evidence from Beijing, China," *Journal of Cleaner Production*, (134), Elsevier Ltd, pp. 269–279 (doi: 10.1016/j.jclepro.2015.09.078).
- Zwietering, M. H., Jacxsens, L., Membré, J. M., Nauta, M., and Peterz, M. 2016. "Relevance of microbial finished product testing in food safety management," *Food Control*, (60), pp. 31–43 (doi: 10.1016/j.foodcont.2015.07.002).

**Copyright:** © 2018 Lam, Heales, Hartley & Hodkinson. This is an open-access article distributed under the terms of the [Creative Commons Attribution-NonCommercial 3.0 Australia License](#), which permits non-commercial use, distribution, and reproduction in any medium, provided the original author and ACIS are credited.

# A Conceptual Framework for the Adoption of E-Government in Indonesia

## **Alvedi Sabani**

School of Business IT and Logistics  
RMIT University  
Melbourne, Australia  
Email: [alvedi.sabani@rmit.edu.au](mailto:alvedi.sabani@rmit.edu.au)

## **Hepu Deng**

School of Business IT and Logistics  
RMIT University  
Melbourne, Australia  
Email: [hepu.deng@rmit.edu.au](mailto:hepu.deng@rmit.edu.au)

## **Vinh Thai**

School of Business IT and Logistics  
RMIT University  
Melbourne, Australia  
Email: [vinh.thai@rmit.edu.au](mailto:vinh.thai@rmit.edu.au)

## **Abstract**

The rapid development of e-government across the world has opened the discussion on how governments can improve citizens' adoption of their online public services. As a result, the adoption of e-government has become a fundamental issue that needs to be adequately addressed. This paper presents a conceptual framework for examining the adoption of e-government from the perspective of citizens. Through semi-structured interviews conducted in Indonesia, the conceptual framework was validated using thematic analysis, which indicates that performance expectancy, effort expectancy and social influence are interrelated critical factors for the adoption of e-government. In terms of academic contribution, this research provides a better understanding of the critical factors for the adoption of e-government from the perspective of citizens. With regards to practical implications, this research provides the Indonesian government and public organisations with relevant suggestions on how the adoption of e-government can be improved.

## **Keywords**

E-Government, Adoption, Framework, Critical Factors, Indonesia.



## 1 Introduction

Electronic government (e-government) is about the use of information and communication technologies (ICT) for improving the delivery of public services to citizens and businesses (Mirchandani et al. 2008). It can be approached from different perspectives. Nam (2014), for example, considers e-government as the delivery of public services through the adoption of digital technologies. Hwang and Syamsuddin (2008) perceive e-government as a way of improving communication between governments and citizens. Meanwhile, Pudjianto et al. (2011) view e-government as a process of enhancing the relationship between governments and their stakeholders including citizens and businesses.

There are various benefits from the development of e-government. For example, it enables seamless two-way communications between governments, citizens, and businesses (Susanto and Goodwin 2013). E-Government improves the quality of public service delivery (Nam 2014) and the transparency of public decision making (Deng et al. 2018), while encouraging citizens' involvement in the public administration (Heeks and Bailur 2007). It also enhances information sharing between government institutions (Puspitasari and Ishii 2016). Besides, the development of e-government streamlines processes in public organisations, therefore improving their efficiency and effectiveness (Debjani et al. 2012). As a result, numerous countries have introduced various initiatives for the development of e-government (United Nations 2016).

Like many other countries, the government of Indonesia recognises the importance of e-government in making public services more accessible and transparent to the public. In 2001, the government officially introduced the 'e-Indonesia' initiative for facilitating the development of e-government (Republik Indonesia 2014). The government has committed to spending US\$6.78 billion for e-government development from 2014 to 2019 (Republik Indonesia 2014). With the implementation of such an initiative, e-government in Indonesia has been developed progressively (United Nations 2016). As a result, Indonesia National Single Window is established, Indonesia Online Immigration Service is introduced, and the National Online Taxation system is developed (Obi and Naoko 2016).

Despite the rapid development of e-government in Indonesia, the adoption of e-government is still far from satisfactory (Deden et al. 2017). The slow adoption of e-government in Indonesia has been widely acknowledged. Maslihatin (2016), for example, find that the average citizen satisfaction index for e-government across the country is poor. Prahono and Elidjen (2015) show that there are only 15.6% of e-government services in Indonesia that are fully accessible and work properly. Puspitasari and Ishii (2016) discover that most e-government services in Indonesia are only accessible from computers whereas mobile phones are the preferred communication channel. All these studies show that the adoption of e-government in the country is ineffective.

This study, therefore, proposes a conceptual framework for examining the adoption of e-government in Indonesia from the perspective of citizens. Specifically, this study aims to examine the key factors that influence citizens on their decisions to adopt e-government. To fulfil this aim, the research question for this study is formulated as follows: "*what are the key factors that influence e-government adoption in Indonesia?*". Such a study can help the government of Indonesia to better plan their e-government initiatives. Moreover, as several other developing countries are within the comparable stages of e-government development (United Nations 2016), findings from this research in the context of Indonesia might provide a useful reference for them.

## 2 E-Government Adoption

The adoption of e-government generally refers to the intention of citizens to engage in e-government for accessing public services (Mirchandani et al. 2008). Research in this area mainly focuses on the awareness, motivation, and trust of citizens to adopt e-government (Kurfali et al. 2017). Such research becomes vital given the potential of e-government to reduce costs and improve public service delivery compared with the traditional paper-based services (Karunasena and Deng 2012).

Numerous studies have been conducted for better understanding the adoption of e-government from different perspectives in the literature. Susanto and Goodwin (2013) for example, highlight the importance of having multiple access platforms to support the adoption of e-government. Bertot et al. (2010) study the effect of transparency on the adoption of e-government. Meanwhile, Mirchandani et al. (2008) find that citizens of closely related countries have a very different expectation of their e-government, which means every country needs a specific e-government adoption strategy.

These studies have shown their merits in investigating the adoption of e-government from different perspectives. None of these studies, however, have made any further attempt to fully examine the critical factors which may influence citizens' decision to adopt e-government, especially in the context of developing countries such as Indonesia. Furthermore, most studies mainly focus on the performance aspect of e-government, whereas the social influence factor in adopting e-government is often completely neglected. Therefore, this research would be essential in developing more socially acceptable e-government.

Indonesia is a Southeast Asian nation made up of thousands of volcanic islands. It is one of the biggest developing countries with over 257 million citizens. Internet penetration has reached over 40% of the total population (Statista 2018). Due to these facts, the government of Indonesia believes that e-government is the most suitable platform to serve the large numbers of citizens distributed in the archipelagic country (Republik Indonesia 2014).

E-Government is being developed rapidly in Indonesia. The 'e-Indonesia' initiative was officially introduced by the Presidential Order No 6/2001. This initiative acts as a backbone of the current e-government strategy under the supervision of the Ministry of Communication and Information Technology. Following the implementation of the initiative, the government of Indonesia provides a various range of e-government services including Indonesia National Single Window to take care of export and import activities, Indonesia Online Immigration Service to manage visa and passport applications, and National Online Taxation to handle tax number registration and mandatory tax information submission (Obi and Naoko 2016; Republik Indonesia 2014).

The adoption of the above e-government services, however, is still low (Prahono and Elidjen 2015). This is reflected by the world's e-government ranking, as Indonesia has continuously fallen in their position for the past five consecutive years (United Nations 2016). The current study on the critical factors which may influence citizens' adoption of e-government in Indonesia is therefore needed.

### 3 Theoretical Foundation and Conceptual Framework

This research adopts the Unified Theory of Acceptance and Use of Technology (UTAUT) model which examines the user's intention in the adoption of technologies (Venkatesh et al. 2003). With the use of this model, three relevant dimensions including performance expectancy, effort expectancy, and social influence are identified. Performance expectancy is described as the degree to which an individual believes that adopting e-government will result in better public service performance. Effort expectancy is referred to the degree of ease in using e-government. Social influence is defined as the degree to which individuals perceive the importance of others' perceptions on the adoption of e-government.

The UTAUT model is one of the most widely used theoretical lenses for investigating the adoption of specific technologies due to its simplicity, consistency and robustness (Williams et al. 2015). It has been adopted in several e-government adoption studies across the world. Among these, for example, Rana et al. (2017) review the indirect impact of anxiety in the adoption of e-government in India. Kurfali et al. (2017), meanwhile, investigate the role of trust in citizens' decision to adopt e-government in Turkey. These studies show that the UTAUT model is appropriate for examining the adoption of e-government from different perspectives. This study, therefore, also adopts the UTAUT model for investigating the adoption of e-government from the perspective of Indonesian citizens.

It is hypothesised, as illustrated in the conceptual framework (Figure 1), that the intention to adopt e-government is influenced by performance expectancy, effort expectancy, and social influence.

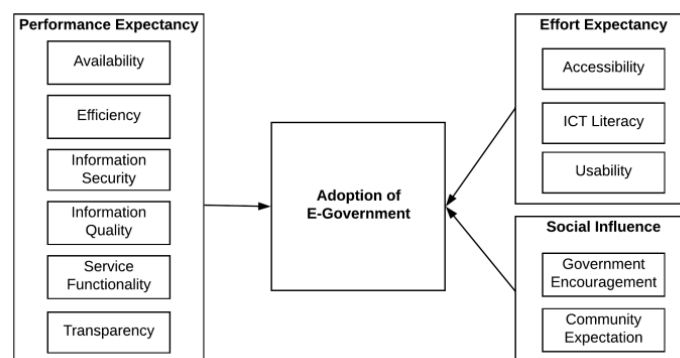

Figure 1: Conceptual Framework

## Performance Expectancy

Performance expectancy is about the degree to which citizens believes that adopting e-government would result in better public service performance (Venkatesh et al. 2003), measured by their perception of whether the adoption of e-government would be beneficial to them. Performance expectancy is expected to significantly influence the intention to adopt e-government (Kurfalı et al. 2017). Table 1 presents an overview of the measurement variables and indicators for performance expectancy.

Variables	Indicators	Definition	References
<b>Performance Expectancy</b>			
<b>Availability</b> is about the state of e-government being available.	(a) System availability. (b) Information availability. (c) Service availability.	(a) The availability of e-government system (e.g. online medicare). (b) The obtainability of e-government information (e.g. information on how to contact medicare office). (c) The availability of e-government services (e.g. online medicare claim submission).	Mirchandani et al. (2008), and Papadomichelaki and Mentzas (2012).
<b>Efficiency</b> is about the ability to accomplish a certain task through the use of e-government with a lesser expenditure of cost, time and effort.	(a) Process simplicity. (b) Process timeliness. (c) Process efficiency.	(a) The process of obtaining information and services from e-government is easily understood. (b) The process of obtaining information and services from e-government is done faster than the traditional approach. (c) The process of obtaining information and services from e-government is less expensive than the traditional approach.	Deden et al. (2017), Nam (2014), and Venkatesh et al. (2003).
<b>Information security</b> is about the protection of information from unauthorized access, by ensuring that information is only accessible to the right users.	(a) Availability of law. (b) Organisation compliance. (c) Perceived risks. (d) Information security awareness. (e) Trust in information security. (f) Confidence in submitting credentials.	(a) The existence of security policies in relation to e-government. (b) The implementation of policies for securing the information in e-government. (c) The uncertainty a user has when using e-government. (d) The degree of awareness of citizens to security policies in e-government. (e) The degree of trust from citizens to the security of e-government. (f) The degree of willingness of citizens to submit sensitive information to e-government.	AlKalbani et al. (2017), Debjani et al. (2012), and Posthumus and Von Solms (2004).
<b>Information quality</b> refers to the value of the information provided by e-government.	(a) Information accuracy. (b) Information relevancy. (c) Information promptness. (d) Information understandability.	(a) The degree of errors in the information. (b) The degree of match between the information provided and the information requested. (c) The measurement of whether the information is provided at the right time. (d) The quality of comprehensible information.	Papadomichelaki and Mentzas (2012), and Wangpipatwong et al. (2009).
<b>Service functionality</b> refers to the degree of usefulness between the services provided and the services required.	(a) Service reliability. (b) Service usability. (c) Fitness for purpose.	(a) The quality of e-government services being consistent. (b) The extent of e-government services in fulfilling the citizens' requirements. (c) The extent of e-government services works as expected.	Deden et al. (2017), Idris (2016), and Yasar and Giovanni (2007).
<b>Transparency</b> refers to the quality of being open or transparent.	(a) Information transparency. (b) Process transparency. (c) Public participation.	(a) The availability of information in e-government including the contact information of public officials, and the timely information about policies, laws and regulations. (b) The availability of clear procedures in using e-government. (c) The capability of citizens to be involved in public decision-making through the use of e-government.	Ionescu (2013), Kim et al. (2009), and Prahono and Elidjen (2015).

Table 1. Measurement Variables and Indicators for Performance Expectancy

## Effort Expectancy

Effort expectancy is referred to as the degree of ease in using new technologies (Venkatesh et al. 2003). It is recognised to influence the intention to adopt e-government (Williams et al. 2015). Effort expectancy is often measured by the degree of ease associated with learning the technology (Venkatesh et al. 2003). In the current study, effort expectancy is employed to examine if citizens perceive that the benefits of adopting e-government outweigh the efforts of learning the system. Table 2 presents an overview of the measurement variables and indicators for effort expectancy.

Variables	Indicators	Definition	References
<b>Effort Expectancy</b>			
<b>Accessibility</b> is about the quality of being able to reach e-government.	(a) Access easiness. (b) Availability of ICT devices. (c) Availability of internet. (d) Availability of multiple platforms (e) Availability of access points.	(a) The quality of being easy to access e-government services and information. (b) The level of effort that the individual must take to access ICT devices. (c) The level of effort that the individual must take to access internet. (d) The ability to access e-government from multiple devices (e.g. personal computers and mobile phones). (e) The ability to access e-government from public places.	Ahmed and Shirley (2014), Idris (2016), and Puspitasari and Ishii (2016).
<b>ICT Literacy</b> is about the ability of individuals to the use of ICT devices at an adequate level to perform a certain task.	(a) ICT self-efficacy. (b) ICT exposure. (c) Internet self-efficacy. (d) Internet exposure.	(a) The degree of individuals' beliefs about their abilities to use ICT devices. (b) The extent of experience of individuals to the use of ICT devices. (c) The degree of individuals' beliefs about their abilities to use internet. (d) The extent of experience of individuals to the use of internet.	Maslihatin (2016), Puspitasari and Ishii (2016), and van Deursen and van Dijk (2011).
<b>Usability</b> is about is the level of effort that citizens must make to learn and use e-government.	(a) User friendliness. (b) User intuitiveness. (c) System navigation. (d) Learnability.	(a) The quality of e-government systems being easy to use. (b) The quality of e-government systems being self-explanatory. (c) The quality of e-government systems being easy to navigate. (d) The quality of e-government systems being easy to learn.	Puspitasari and Ishii (2016), and Susanto and Goodwin (2013).

Table 2. Measurement Variables and Indicators for Effort Expectancy

### Social Influence

Social influence is the external dimension that affects an individual's decision to adopt new technologies (Venkatesh et al. 2003). This dimension has not been popularly examined in the context of e-government adoption studies. Table 3 presents an overview of the measurement variables and indicators for social influence.

Variables	Indicators	Definition	References
<b>Social Influence</b>			
<b>Government Encouragement</b> refers to the actions taken by the government to support the adoption of e-government.	(a) Awareness support. (b) Availability of support centres. (c) Availability of financial incentive. (d) Availability of ICT training.	(a) The level of support from the government to maintain the timely information to the presence of e-government. (b) The level of support from the government to assist citizens in using e-government (e.g. phone and web support centres). (c) The availability of financial benefits provided by the government to citizens for adopting e-government systems. (d) The availability of ICT training provided by the government to citizens.	Furuholt and Wahid (2008), Hwang and Syamsuddin (2008), and Nurdin et al. (2012).
<b>Community Expectation</b> is defined as compression by a person's proximity to take certain actions or adopt certain values.	(a) Community adoption. (b) Community encouragement. (c) Community opinion. (d) Community influence.	(a) The level of e-government acceptance from individuals' community. (b) The level of encouragement from individuals' community to adopt e-government. (c) The belief of individuals' community in the e-government system. (d) The degree to which individuals perceive that the importance of others' perceptions on the decision to adopt of e-government.	Deden et al. (2017), Kurfali et al. (2017), Rana et al. (2017), and Voutinioti (2013).

Table 3. Measurement Variables and Indicators for Social Influence

## 4 Research Methodology

This study takes the qualitative approach, using in-depth interviews, to empirically validate the proposed conceptual framework for the adoption of e-government in Indonesia from the perspective of citizens. The interview questions were developed based on a comprehensive review of the related literature. Such questions are divided into three parts. The first part focuses on the demographic information of the participant. The second part includes general questions about the experience and motivation of participants in their adoption of e-government. The third part consists of specific questions on the critical factors for the adoption of e-government from the perspective of citizens. The

interview questions were pre-tested with the help of academics, higher degree research scholars, and e-government users.

This research employed purposive and snowball sampling and recruited 15 participants across three provinces in Indonesia, namely Banten, Jakarta, and West Java. The selection criteria include Indonesian citizen of more than 18 years of age and have previously used e-government services. Participants were chosen based on their knowledge and experience in using e-government services. These participants have diverse demographic characteristics as shown in Table 4.

#	Age Group	Gender	Education	Occupation	Frequency of Using E-Government
1	21-30	Male	Bachelor Degree	Private Sector Employee	Rarely (once in a year)
2	21-30	Male	Bachelor Degree	Medical Doctor	Often (once in 3 months)
3	21-30	Female	Master Degree	Private Sector Employee	Sometimes (once in 6 months)
4	31-45	Male	Master Degree	Self-Employed	Very often (once in a month)
5	21-30	Male	Diploma	Self-Employed	Often (once in 3 months)
6	21-30	Female	Bachelor Degree	Private Sector Employee	Sometimes (once in 6 months)
7	21-30	Male	High School	Student	Very rarely (less than once in a year)
8	21-30	Male	Bachelor Degree	Public Sector Employee	Often (once in 3 months)
9	46-60	Female	Bachelor Degree	Public Sector Employee	Very often (once in a month)
10	46-60	Male	Master Degree	Academic	Often (once in 3 months)
11	21-30	Male	Master Degree	Public Sector Employee	Often (once in 3 months)
12	21-30	Male	Bachelor Degree	Private Sector Employee	Rarely (once in a year)
13	31-45	Male	Diploma	Private Sector Employee	Rarely (once in a year)
14	31-45	Female	Bachelor Degree	Private Sector Employee	Sometimes (once in 6 months)
15	18-20	Female	High School	Private Sector Employee	Very rarely (less than once in a year)

Table 4. Profile of Participants

The thematic analysis is utilised in this research, due to its simplicity, less demanding obligation of only a few constraints on the data collection and analysis (Braun and Clarke 2006). The approach is to summarise a large volume of data into meaningful and descriptive themes (Howitt 2013). This method entails several phases. The first phase is familiarising with the transcribed text to get a better understanding of the whole data set. The second phase is the initial coding which involves assigning specific codes to the transcribed text. In this study, codes are created in a deductive manner by reviewing the data with specific classifications based on pre-existing theoretical concerns (Howitt 2013). The third phase involves searching for themes based on the initial coding. Themes are identified by reviewing each code to sort into meaningful clusters (Attride-Stirling 2001; Howitt 2013). The fourth phase is to review the themes by splitting certain themes into two or more themes, and converging overlapping themes (Braun and Clarke 2006). The fifth phase is to define and name themes based on the essences of what each theme is about (Braun and Clarke 2006). The sixth phase is to produce the report by developing thematic networks that show the important themes at multiple levels and their relationships (Attride-Stirling 2001). In short, the thematic analysis uncovers insights, and reveals the similarities and differences between the responses of participants.

## 5 Research Findings

Figure 2 summarises the research findings around the three dimensions identified in the conceptual framework, namely, performance expectancy, effort expectancy, and social influence. Each dimension consists of factors with the level of influence that has been assessed from the thematic analysis.



Figure 2: Thematic Research Findings

## **Performance Expectancy**

The thematic analysis unanimously confirms that all factors under performance expectancy are influencing the citizens' decision to adopt e-government. Furthermore, eleven out of fifteen interviewees believed that the performance of e-government is the most vital aspect towards the adoption of e-government. It was further indicated that efficiency, service functionality and transparency are the three most influencing factors, followed by availability, information security, and information quality.

Efficiency is about the ability to accomplish a specific task through the use of e-government with a lesser expenditure of cost, time and effort (Deden et al. 2017). It is perceived to be the most influencing factor for nine interviewees to adopt e-government. Interviewees believe that e-government has enabled them to access public services without time and space constraints, as explained by one interviewee as follows:

“Efficiency is the main reason why I am using e-government. With e-government, I do not have to take a day off to report my annual tax, as the online service is available 24/7 whereas taxation offices only open on standard working hours.”

It is also shown that e-government streamlines public services to become simpler, faster and more cost effective. Citizens can reduce the number of physical visits to government offices by using e-government services. Interviewees, therefore, believed that e-government saves their time and money, as well as makes their lives easier. Another interviewee explained this as follows:

“E-Government makes it (government-related services) simpler, cheaper and faster, as we do not need to come and waste our time in the long queue. In that regards, it is very efficient.”

Service functionality refers to the degree of usefulness between the services provided and the services required (Nam 2014). It can be assessed by measuring the extent that e-government services fulfil the citizens' requirements (Yasar and Giovanni 2007). From the interviews, service functionality is perceived to influence the intention to adopt e-government, in which a bad experience of service functionality can significantly demotivate citizens to adopt e-government. This view is elaborated by an interviewee as follows:

“I have a horrible experience with using e-government. For me, to use e-government again, the system has to be proven working properly; otherwise, I will not touch the system. When I tried to lodge my tax online last year, the server kept crashing, and I had to resubmit all my data as there was no autosave function. It was such a terrible experience. I ended up lodging it manually, which took me a whole day, but at least it got the job done.”

Transparency refers to the quality of being open or transparent. It is measured through the availability of information in e-government including the contact information of public officials, the information to government budgets and expenditures, the operational guidelines of e-government, the timely information about policies, laws and regulations. This factor was confirmed to influence the adoption of e-government (Karunasena and Deng 2012), and it was also echoed in this research. This is reflected through the opinion of an interviewee as follows:

“Before the introduction of e-government, it was very difficult to find a clear procedure on how to upgrade my land and building development permits. Now, with this mobile application, I can track the progress of my application and contact the responsible personnel for my query easily.”

Availability refers to the extent of e-government systems including services and information being available (Williams et al. 2015), and this factor was also confirmed to influence the adoption of e-government in the literature. It was found through the thematic analysis of this research that there is a nexus between the perception of citizens on the availability of e-government and government encouragements on public awareness. This shows that there is a need for an integrated one-stop portal to all kind of e-government services, as elaborated by an interviewee in the following:

“I am not quite sure what e-government services are available due to low publicity... the government should create a one-stop portal for citizens to check and find all kind of e-government services available.”

Information security is about the implementation of policies for securing the information in e-government (Debjani et al. 2012). It is about the protection of information from unauthorised access,

by ensuring that information is only accessible to the right users (Posthumus and Von Solms 2004). It is envisaged that issues relating to information security may ruin the trust of citizens in adopting e-government, as illustrated by an interviewee as follows:

“I have seen a potential misuse due to mishandling of data from the department of education. The department implemented an online database of students from primary to university level to subdue fake certificate issues. When my child was graduating from elementary school, I searched up by his name and school. The system somehow displayed all his details including home address and landline. It was a concern to me, although the department has now fixed it.”

It is argued that citizens are concerned about the information security breach, such as those in the above potential misuse of information stored in e-government. Consequently, citizens may hesitate to adopt e-government due to security concerns. Another interviewee, however, counter-arguing that paper-based services might carry similar or even more risks compared to the online counterpart, expressed his view as the following:

“I have no problem with submitting my sensitive information online, as sometimes you have to live with your personal data at risk. For example, if we are talking about the manual submission directly to the office, the file can be misplaced, misused and other problems.”

In addition, findings from the interviews highlight the importance of having an official account for information security confidence in using e-government services. An interviewee believed that establishing an official developer account for e-government applications can increase citizens' confidence, and eliminate confusions from third-party applications. This view is illustrated as follows:

“The government should have an official account at App Store, so we know the application is secured and legit.”

Last but not least, information quality refers to the value of the information provided by e-government (Wangpipatwong et al. 2009). It can be assessed by measuring the value of the supplied information, based on its accuracy, relevancy, and timeliness. Specifically, accuracy refers to the degree of errors relating to the information provided; relevancy refers to the degree of match between the information provided and the information requested; and timeliness measures if the information is provided at the right time (Wangpipatwong et al. 2009). In this research, the interviews confirmed the importance of information quality and how this factor positively influences the intention to adopt e-government. An interviewee remarked as follows:

“For e-government to be successful, it has to provide up-to-date and accurate information. I have to be able to trust the information I receive from e-government before I want to use the system.”

It was also revealed that having access to the latest and accurate information provided in an understandable manner increases citizens' confidence in adopting e-government as it could affect the level of trust, which is crucial to the adoption. An interviewee elaborated this as follows:

“When I browse a government website, the first thing I check is whether they have a new post or announcement. If there is no recent update, I am very sceptical of using the service or believing that the information provided is still relevant.”

### **Effort Expectancy**

Effort expectancy is widely argued and validated in the literature as one of the three dimensions having a significant influence on the adoption of e-government. In this research, it was specifically evidenced through thematic analysis that usability is the most influencing factors, followed by accessibility and ICT literacy.

In the current study, usability is about the quality of being easy to use e-government (Debjani et al. 2012). It can be assessed by measuring the level of effort that citizens must make to access e-government. Usability plays a significant role especially in the early stage of e-government adoption as humans by nature often hesitate to adopt a new system (Puspitasari and Ishii 2016). The adoption of e-government is found to be improved when the usability is enhanced (Susanto and Goodwin 2013). A majority of the interviewees further stressed that usability is the most prominent component to support the adoption of e-government, as illustrated by an interviewee as follows:

“I have seen a few potentially great e-government services without clear information on how to use it, thus I ended up not using the system, which is not good. The government should provide a clear procedure or a video to educate on how to use the particular service. Otherwise, it is a waste of development as no one will use it.”

In the context of e-government, accessibility refers to the quality of being able to reach e-government (Idris 2016). This includes the ability to access e-government from multiple devices including personal computers and mobile phones, and public places such as public libraries and government offices. This factor is confirmed to influence the adoption of e-government in this research, in line with what was reported in the literature. It was indicated through thematic analysis that mobile phones are the preferred communication channel for the majority of the interviewees in accessing e-government, as explained by an interviewee as follows:

“Mobile phone is my preferred device to access e-government, as I spend most of the time away from computers.”

However, for specific services involving a significant amount of data entry such as online tax lodgement, personal computers are the preferred device. It was also perceived that there is a need for public access at libraries and government offices as indicated by an interviewee in the following:

“The government should provide computers for public use at immigration and taxation offices.”

Meanwhile, ICT literacy, often defined as the ability to use ICT peripherals at an adequate level to perform a specific task (van Deursen and van Dijk 2011), has also been identified as one of the influencing factors for e-government adoption. Despite the fact that Indonesia is a country with the high use of internet and technology, there are still many citizens in the country that lack computer literacy (Furuholt and Wahid 2008) and may not be able to fully access and utilise e-government services. This is demonstrated in a quote by an interviewee as follows:

“I believe the current e-government is designed for intermediate ICT users, whereas it should be designed to cater all kind of people including those who are not literate with ICT.”

Nevertheless, it was found through the thematic analysis in this research that ICT literacy is the least influencing factor for the adoption of e-government in Indonesia.

### **Social Influence**

Apart from performance expectancy and effort expectancy, findings from the current research also establish that social influence also affects the adoption of e-government. Social influence is seen to comprise two factors that stimulate the adoption of e-government, namely, government encouragement, and community expectation. It was revealed through the thematic analysis that government encouragement has a stronger influence than that of community expectation when it comes to e-government adoption in Indonesia.

Government encouragement refers to the actions taken by the government to support the adoption of e-government (Furuholt and Wahid 2008). It can be assessed by measuring the level of effort taken and incentives provided by governments to encourage the citizens to adopt e-government.

Failures in the adoption of e-government are often due to the lack of government encouragement for citizens to adopt e-government (Nurdin et al. 2012). In this research, it was also evidenced through the thematic analysis that government encouragement is a strong factor which influences the adoption of e-government. In this respect, an interviewee shared his opinion about the poor publicity of e-government services in Indonesia as follows:

“The socialisation of e-government services aside from e-filing for the tax is very poor, how are we supposed to adopt the service if we do not know the existence of them in the first place.”

Findings from this research highlight the need for a frequently updated official portal to integrate and showcase all e-government services. The use of social media and mass media channels such as YouTube and TV is also necessary to raise the awareness of the available e-government services. This is demonstrated by an interviewee in the following:

“The government might have provided several e-government services, but the awareness is very low due to the lack of publicity. YouTube and social media advertisement should be utilised to raise awareness.”



Meanwhile, community expectation is defined as the compression by a person's proximity to take specific actions or adopt certain values (Rana et al. 2017). It can be measured by the degree to which an individual perceives the importance of others' opinions on the adoption of e-government. Findings in this research specifically indicate that the influence of family, friends and co-workers has some impact on an individual's intention to adopt a socially acceptable system such as e-government. This is demonstrated by an interviewee who stated as follows:

"I am actively encouraging the use of e-government to my friends and families."

Under these social pressures, individuals are encouraged to recognise the advantage of innovation and embrace the need to adopt e-government to satisfy their needs of public services.

## 6 Discussion and Conclusion

This study makes several significant contributions and has implications for theory building and management practice. From the theoretical perspective, this paper presents a conceptual framework for examining the adoption of e-government from the perspective of Indonesian citizens. The use of the UTAUT model is extended by incorporating variables established from the critical factors that are relevant to the adoption of e-government in developing countries such as Indonesia. Apart from the common belief which focuses predominantly on performance expectancy and effort expectancy for examining the adoption of e-government, findings from this study also suggest that it is necessary to capture the social influence factors, which are in line with the cultural aspect of collectivism which is evidenced in the Indonesian society. This contributes to advancing current understanding of the critical factors which influence the adoption of e-government by emphasising the effect of external factors such as those from the cultural perspective. Meanwhile, in terms of managerial and policy implications, findings from this research provide the government and public organisations in Indonesia with relevant suggestions on how the adoption of e-government can be improved, focusing on the factors which are perceived by citizens as having strong influence on their adoption of e-government. Such suggestions can lead to the formulation of better strategies and policies for the continuous development of e-government in Indonesia.

Since the framework of this research was only validated by fifteen in-depth interviews, its generalisability remains limited. As a result, future work would be to test this conceptual framework with a large-scale quantitative survey.

## 7 References

- Ahmed, I., and Shirley, G. 2014. "A Comparative Analysis of Strategies for E-Government in Developing Countries," *Journal of Business Systems, Governance and Ethics* (2:3).
- AlKalbani, A., Deng, H., Kam, B., and Zhang, X. 2017. "Information Security Compliance in Organizations: An Institutional Perspective," (1:2), p. 104.
- Attride-Stirling, J. 2001. "Thematic Networks: An Analytic Tool for Qualitative Research," *Qualitative Research* (1:3), pp. 385-405.
- Bertot, J.C., Jaeger, P.T., and Grimes, J.M. 2010. "Using Ict's to Create a Culture of Transparency: E-Government and Social Media as Openness and Anti-Corruption Tools for Societies," *Government Information Quarterly* (27:3), pp. 264-271.
- Braun, V., and Clarke, V. 2006. "Using Thematic Analysis in Psychology," *Qualitative Research in Psychology* (3:2), 2006/01/01, pp. 77-101.
- Debjani, B., Umesh, G., and Gupta, M.P. 2012. "E-Service Quality Model for Indian Government Portals: Citizens's Perspective," *Journal of Enterprise Information Management* (25:3), pp. 246-271.
- Deden, W., Teddy, S., Mohd Farhan, M.D.F., and Mohamad Aizi, S. 2017. "The Critical Factors Affecting E-Government Adoption in Indonesia: A Conceptual Framework," *International Journal on Advanced Science* (7:1), pp. 160-167.
- Deng, H., Karunasena, K., and Xu, W. 2018. "Evaluating the Performance of E-Government in Developing Countries," *Internet Research* (28:1), pp. 169-190.
- Furuholt, B., and Wahid, F. 2008. "E- Government Challenges and the Role of Political Leadership in Indonesia: The Case of Sragen." pp. 411-411.
- Heeks, R., and Bailur, S. 2007. "Analyzing E-Government Research: Perspectives, Philosophies, Theories, Methods, and Practice," *Government Information Quarterly* (24:2), pp. 243-265.
- Howitt, D.a. 2013. *Introduction to Qualitative Methods in Psychology*, (Second edition. ed.). Harlow, England: PEARSON.

- Hwang, J., and Syamsuddin, I. 2008. "Failure of E-Government Implementation: A Case Study of South Sulawesi." pp. 952-960.
- Idris, S.H.M. 2016. "Significant Factors Determining E-Government Adoption in Selangor, Malaysia," *Acta Universitatis Danubius: Oeconomica* (12:3), pp. 163-172.
- Ionescu, L. 2013. "The Impact That E-Government Can Have on Reducing Corruption and Enhancing Transparency," *Economics, Management, and Financial Markets*:2), pp. 210-215.
- Karunasena, K., and Deng, H. 2012. "Critical Factors for Evaluating the Public Value of E-Government in Sri Lanka," *Government Information Quarterly* (29), p. 76.
- Kim, S., Kim, H.J., and Lee, H. 2009. "An Institutional Analysis of an E-Government System for Anti-Corruption: The Case of Open," *Government Information Quarterly* (26:1), pp. 42-50.
- Kurfali, M., Arifoğlu, A., Tokdemir, G., and Paçin, Y. 2017. "Adoption of E-Government Services in Turkey," *Computers in Human Behavior* (66), pp. 168-178.
- Maslihatin, T. 2016. "Balanced Scorecard : Performance Measurement for E-Government," *Journal of Theoretical and Applied Information Technology* (90:2), pp. 116-123.
- Mirchandani, D., Johnson Jr, J., and Joshi, K. 2008. "Perspectives of Citizens Towards E-Government in Thailand and Indonesia: A Multigroup Analysis," *Information Systems Frontiers* (10:4), pp. 483-497.
- Nam, T. 2014. "Determining the Type of E-Government Use," *Government Information Quarterly* (31:2), pp. 211-220.
- Nuridin, N., Stockdale, R., and Scheepers, H. 2012. "Organizational Adaptation to Sustain Information Technology: The Case of E-Government in Developing Countries," *Electronic Journal of E-Government* (10:1), pp. 70-83.
- Obi, T., and Naoko, I. 2016. "A Decade of World E-Government Rankings." Beaverton: Ringgold Inc.
- Papadomichelaki, X., and Mentzas, G. 2012. "E-Govqual: A Multiple-Item Scale for Assessing E-Government Service Quality," *Government Information Quarterly* (29), p. 98.
- Posthumus, S., and Von Solms, R. 2004. "A Framework for the Governance of Information Security," *Computers & Security* (23:8), pp. 638-646.
- Prahono, A., and Elidjen, A. 2015. "Evaluating the Role E-Government on Public Administration Reform: Case of Official City Government Websites in Indonesia," *Procedia Computer Science* (59), pp. 27-33.
- Pudjianto, B., Zo, H., Ciganek, A., and Rho, J.J. 2011. "Determinants of E-Government Assimilation in Indonesia: An Empirical Investigation Using Toe Framework," *Asia Pasific Journal of Information Systems* (21:1).
- Puspitasari, L., and Ishii, K. 2016. "Digital Divides and Mobile Internet in Indonesia: Impact of Smartphones," *Telematics and Informatics* (33:2), pp. 472-483.
- Rana, N., Dwivedi, Y., Lal, B., Williams, M., and Clement, M. 2017. "Citizens' Adoption of an Electronic Government System: Towards a Unified View," *A Journal of Research and Innovation* (19:3), pp. 549-568.
- Republik Indonesia. 2014. "Rencana Pitalebar Indonesia 2014 - 2019," K.P.P. Nasional (ed.). Jakarta: Republik Indonesia.
- Statista. 2018. "Internet User Penetration in Indonesia from 2015 to 2022," New York.
- Susanto, T.D., and Goodwin, R. 2013. "User Acceptance of Sms-Based E-Government Services: Differences between Adopters and Non-Adopters," *Government Information Quarterly* (30:4), pp. 486-497.
- United Nations. 2016. "United Nations E-Government Survey 2016," Department of Economic and Social Affairs, New York.
- van Deursen, A., and van Dijk, J. 2011. "Internet Skills and the Digital Divide," *New Media and Society* (13:6), pp. 893-911.
- Venkatesh, V., Morris, M., Davis, G., and Davis, F. 2003. "User Acceptance of Information Technology: Toward a Unified View," *MIS Quarterly* (27:3), pp. 425-478.
- Voutinioti, A. 2013. "Determinants of User Adoption of E-Government Services in Greece and the Role of Citizen Service Centres," *Procedia Technology* (8), pp. 238-244.
- Wangpipatwong, S., Chutimaskul, W., and Papasratorn, B. 2009. "Quality Enhancing the Continued Use of E-Government Web Sites: Evidence from E-Citizens of Thailand," *International Journal of Electronic Government Research (IJEGR)* (5:1), pp. 19-35.
- Williams, M.D., Rana, N.P., and Dwivedi, Y.K. 2015. "The Unified Theory of Acceptance and Use of Technology (Utaut): A Literature Review," *Journal of Enterprise Information Management* (28:3), pp. 443-488.
- Yasar, J., and Giovanni, S. 2007. "Measuring Performance in the Public Sector: Challenges and Trends," *Measuring Business Excellence* (11:4), pp. 4-8.

## Acknowledgements

This research is supported by an Australian Government Research Training Program (RTP) Scholarship.

## Copyright

**Copyright:** © 2018 Alvedi Sabani, Hepu Deng and Vinh Thai. This is an open-access article distributed under the terms of the [Creative Commons Attribution-NonCommercial 3.0 Australia License](https://creativecommons.org/licenses/by-nc/3.0/australia/), which permits non-commercial use, distribution, and reproduction in any medium, provided the original author and ACIS are credited.

# Towards a High-level Service Delivery Architecture for One-Stop Government (OSG)

Thi Thu Huong Nguyen  
School of Information Systems  
Queensland University of Technology  
Brisbane, Australia  
Email: [t340.nguyen@connect.qut.edu.au](mailto:t340.nguyen@connect.qut.edu.au)

Mustafa Hashmi  
<sup>1</sup>Data61, CSIRO, Dutton Park, Brisbane Queensland  
<sup>2</sup>Federation University (FedUni), Brisbane, Queensland  
Email: [mustafa.hashmi@data61.csiro.au](mailto:mustafa.hashmi@data61.csiro.au)

Mary Tate  
School of Information Systems  
Victoria University of Wellington  
Wellington, New Zealand  
Email: [mary.tate@vuw.ac.nz](mailto:mary.tate@vuw.ac.nz)

## Abstract:

The work on the service delivery in the context of one-shop government architecture is far from being mature. Although the understanding on various levels of complexity of e-government service delivery has been addressed, many extant versions of the service delivery architectures themselves are dated and do not reflect the potential contribution of new technologies. In this work-in-progress paper, we report ongoing work and propose an updated service delivery architecture comprising five distinct layers. The proposed architecture addresses some important challenges, and suggests areas for future research as outlined in the paper.

**Keywords:** One-stop government, High-level architecture, Maturity models, Architecture layers

## 1. INTRODUCTION

The potential of one-stop government has captured the interest of officials and citizens for several decades and has been considered as a key factor for public administration's development (Kubicek & Hagen, 2000). One-stop government (hereafter, OSG) is a digital presence of government mainly in a form of well-designed website supported by other services, and provides integrated access to multiple public services for different groups of customers all in one interface. OSG applies initiatives from information and communication technologies (Dias & Rafael, 2007) in order to transform government administration processes and allow more active participation from citizens (Lee, 2010). Many public services are integrated into OSG, including paying taxes online, gathering improvement grants information or accessing to a number of health services, and many other services (Pollitt, 2003).

A key feature of OSG is the integration of information and transactions across agencies, so citizens and businesses can minimise interaction with government while having their services delivered in a better and faster way (Ebrahim & Irani, 2005). From a government's perspective, there is also cost saving in terms of human resources and administration management because services are designed in an automated manner, and require fewer staff and processes. In Australia, OSG solutions are provided at different levels of government and are showing great benefits for all types of users. For example, MyGov<sup>1</sup> is an OSG at national level, in which everyone can use the portal, either citizens or immigrants. At state level, New South Wales's OneGov<sup>2</sup> (NSW's OneGov) can be considered as a good example with a wide range of public services offered.

However, along with opportunities to transform the way government implements traditional public services, OSG also poses many issues in terms of architecture as OSG is still evolving and has not yet reached a mature state (Lofstedt, 2012). According to Ebrahim and Irani, there is a lack of architecture frameworks for OSG as many governments are still in the early stages of implementing integrated digital portals of public services (Ebrahim & Irani, 2005). In addition, OSG systems can be fragmented, as many services are not fully integrated. Low productivity, inconsistent workflow and under-performing systems are consequences of these existing problems (Keld, 2017). Therefore, a more robust architecture is necessary to better design an OSG portal (Ebrahim & Irani, 2005).

This work-in-progress study of OSG's high-level architecture aims to provide governments with overall guidelines to improve public services' core design by applying new technologies, for example cloud computing and data mining, AI, and analytics. In the rest of this paper, we first review previous studies relevant to the topic, including insights about the evolution and maturity of OSG. We then develop a high-level architecture model for OSG, with areas for future research. This is followed by a discussion and conclusion.

## 2. LITERATURE REVIEW

### 2.1. OSG maturity models in relation with OSG architecture

The adoption of OSGs can improve the time taken to deliver of public services to citizens and businesses, while simplifying bureaucratic procedures, reducing transaction costs and enhancing transparency for governments (Saha, 2012). However, in order to achieve this quality of services, OSGs have been undergoing numerous changes in terms of evolution stages and high-level architectures. The evolution of the service capability of OSGs has close relationship with the underlying architectural structure. In each stage of the evolution, OSGs have reached new capabilities by adopting new technology initiatives. In 2000, Baum and Di Maio introduced first framework of OSG's evolution stages including web presence, interaction, transaction and transformation (Baum & Di Maio, 2000; Layne & Lee, 2001). Later, Layne and Lee proposed a four-stage model: *catalogue*, *transaction*, *vertical integration*, and *horizontal integration* (Layne & Lee, 2001). Their model is the most widely cited when discussing the development phases of OSG (Debri & Bannister, 2015). Siau and Long (2005), on the other hand, extended the work of Baum and Di Maio by adding e-democracy as the maturity stage of OSG to open up the possibility for political participation. The integration of e-democracy seems to be the highest maturity level of OSG until a new trend which allow consumers (citizens and businesses) to have more power in resolving public problems was proposed by (Linders, 2012). This trend raised a new concept in which OSG is no longer in its form of e-government but rather evolves to a *we-government*. With the notion of a platform that treats citizens and businesses not as consumers but partners, Linders

---

<sup>1</sup> <https://my.gov.au/LoginServices/main/login?execution=e1s1> (retrieved 21<sup>st</sup> May 2018).

<sup>2</sup> <https://onegov.nsw.gov.au/new/> (retrieved 21<sup>st</sup> May 2018).

emphasized the importance of citizen coproduction with government's efforts in tackling public issues. Thus, this concept can open new approach for OSG's architecture design not only from the interface layer point of view but also for other core layers.

## 2.2. Challenges of OSG

Implementations of OSG still appear to be far from reaching their potential because there are many that challenges need to be addressed. Reasons are varied, and in this section, we discuss three of the most challenging problems for the development of OSG.

Technology capabilities are changing rapidly. OSG is not limited to a particular technology or framework from the past; rather there are rich opportunities to utilize contemporary technologies into OSG's architecture. Therefore, architectures need to be regularly reviewed. For example, many studies from the 2000's (Baum & Di Maio, 2000; Siau & Long, 2005) on OSG's stage model concentrate on web services as the platform for government's portal and have not taken into account the application of other dominant technologies, for example: cloud computing, AI, data analytics and so on (Debri & Bannister, 2015). These technologies have been readily embraced by the private sector to improve service delivery. Tech giants such as Facebook and Amazon use predictive analytics, AI agents, and other tools. People expect public services to keep pace. In some respects, this is the case. Cloud computing, for example has changed the way data is stored by leveraging its capability to save a great amount of information with less investment on capital for infrastructure, installation as well as human resources (Jadeja & Modi, 2012). This technology is widely used by public sectors around the world (Wyld, 2010), and has become an essential component of OSG solutions. Additionally, the use of big-data in recent years is becoming extremely important in government contexts. Big data offers the opportunity for significant contributions to improving transparency, citizen's well-being, economic growth and national security (Kim, Trimi, & Chung, 2014). With benefits from big-data, the Australian government has run a program called Government 2.0 in which offering public access to government data and enabling web-based automation tools (<http://data.gov.au>) with the aim of better utilising government data resources (Kim et al., 2014). Simultaneously, data mining, another application of big-data, with its predictive analytics technique can help to translate a massive amount of data into recommender systems (Kim et al., 2014). This can be used (for example) to predict people at risk of becoming homeless, or needing other forms of public assistance. However, both privacy and security issues, and the scope of integration required across multiple agencies are challenges in the public sector context.

Data analytics raise major privacy concerns. Secondly, although predictive data mining can greatly benefit the decision making process of either private and public sector, the activities of extracting knowledge from massive databases can be a target for cyber-attacks (Malik, Ghazi, & Ali, 2012). Accidentally sharing the personal details of hundreds of customers of Centrelink in Australia is a bitter example of a security breach<sup>3</sup>. Internationally, other breaches have been reported<sup>4</sup>. As citizen data is increasingly shared and integrated, and stored in the cloud, the security of OSGs has become a major concern. Data security in cloud technology has become a pain point due to data loss, phishing and other digital criminal activities (Dillon, Wu, & Chang, 2010). Essentially, the technical problems of security models (Lam, 2005), high cost of security applications and solutions (Lambrinoudakis, Gritzalis, Dridi, & Pernul, 2003), high costs of security infrastructure, and lack of risk management security program (Ebrahim & Irani, 2005) are other challenges in building more trusted system for OSG. As many public enterprises are now adopting new technologies, improved security measures and protection of citizen data is a fundamental requirement for OSGs.

Integration across agencies and levels of government is difficult. Thirdly, the aim of OSG's maturity models is to achieve a fully integrated system with cohesive and seamless public services for that is citizen (not agency) centric (Lam, 2005). However, many OSG solutions fall well short of this vision. One reason is that the structure of government agencies makes OSG integration hard to implement (2005). OSG at national level is different from state level and local level in a number of services integrated, form of services, security system, data collection methods, and so on. Lam (2005) has collected and analysed previous studies, then indicated that strategy, technology, policy and organisations are four main barriers for public services integration. Amongst various barriers, the author has shown that the lack of architecture interoperability is considered as "a major reason for failure in application integration", and it comes from the dissimilarity technology platforms, the closed design of applications, the disparity of programming framework. Lam also pointed out that beside

---

<sup>3</sup> <https://www.smh.com.au/public-service/centrelink-apologises-for-new-privacy-breach-20161101-gsflcp.html> (retrieved 13 June 2018).

<sup>4</sup> <https://www.bbc.com/news/world-us-canada-33017310> (retrieved 12 June 2018).

architectural related issues, incompatible technical standards can also act as obstacles to integration. Equally important, even when governments prioritize compatible technical standards, other issues will occur, for example: differences in methodologies and modelling standards. Therefore, a standardised enterprise system and common technologies are desired to improve the use of OSG in public sector.

### 2.3. Previous Enterprise Architecture Frameworks for e-Government

Enterprise Architecture (EA) frameworks are used to manage the ongoing process of building the ability to tackle complexity, with the key goal of developing and sustaining coherent enterprises (Saha, 2012). Frequently, five layers are used, including: business architecture, process architecture, integration architecture, software architecture and technology (or infrastructure) layer (Winter & Fischer, 2006). We note that vertically, OSGs at different level, for example: national level, state level, and local level have different services packages, technologies, data collection methods, and so on. Horizontally, different departments also have different approaches and points of view about OSG. However, despite of these discrepancies, there should be a common architectural framework to guide the development of layers, processes and target results for each layer (Ebrahim & Irani, 2005). Surprisingly, throughout the development of OSG, there are a few studies that develop architectural frameworks for OSG.

We draw from previous studies of enterprise architecture for e-government. Saha (2007) introduced four architectural domains specifically for the government context including business architecture, data/information architecture, application architecture and technical architecture. This was later expanded by adding policy and strategy architecture domains (Saha, 2012). Their work offer detailed practices for each layer—and provide the inter-relationship between layers, and build conditions for these layers to support each other. When government agencies are able to identify their business models for their public services as a whole, they can also make decision on technologies that best suit the development for those services. One of the most cited paper on e-government architecture is the work of Ebrahim and Irani (2005). The architecture introduced in their work consists of four layers named: *access layer*, *e-government layer*, *e-business layer*, *infrastructure layer*. Although this study is more than ten years old and has been extensively cited, subsequent studies have focussed primarily on the challenges and barriers to implementation (Lam, 2005) rather than on extending the framework. We were not able to identify any follow-up studies that elaborated aspects of the proposed e-government architecture itself. Understanding of the various levels of complexity of e-government services has progressed, but the service delivery architecture itself has not been updated. It is therefore timely to update and elaborate the architectures required for delivering e-government services at various levels of complexity. We use this work as a foundation for our architecture.

Our core study will apply the outcomes from previous researchers on enterprise architecture (EA) and its component layers to improve design thinking for OSG's high-level architecture—so it will be more appropriate for the current state of OSG services, systems and technology.

## 3 A HIGH LEVEL ARCHITECTURAL FRAMEWORK

The architectural framework that we introduce in this paper, presented in Figure 1, includes five distinct layers: *interface layer*, *one-stop government layer*, *integration and personalization layer*, *business layer*, and *infrastructure layer*. Each layer has an inter-relationship with the others, demonstrated by two-way arrows.

The *interface layer* is similar to the access layer in Ebrahim and Irani's (2005) framework, and allows OSG's users to interact with the portal. In this layer, users are classified into customers (individuals and businesses) and providers (governments and non-public providers). The sub-layer that contains channels divided into traditional and digital streams. While the traditional stream presents direct and manual methods, the digital stream presents possible online platforms, for example: web presence, mobile application. However, there is no limitation in the forms of digital channels as they can expand to social media, market place, smart TV, and other technology platforms that are applicable for OSG integration.

The *One-stop-government layer* contains two sub-layers. The first is a customer personal page and the second is a service layer. Within this layer, after accessing from interface layer into their personal pages, customers are able to choose their target services. There are two streams of services. The first stream includes services that are directly integrated and fulfilled by the portal, without the need to exchange data or pass control to other agencies. For example, vehicle licence renewal service is available directly

on the NSW OSG<sup>5</sup>. On the other hand, the second stream requires redirection to other digital pages, for example: Australian OSG at national level, myGov can lead users to websites of ATO, Centrelink, Medicare, and other services websites<sup>6</sup>. This can be done with varying levels of sophistication. Sometimes, the integration and communication is fully or partly automated, at other times, the user themselves needs to initiate the integration of services from several agencies.

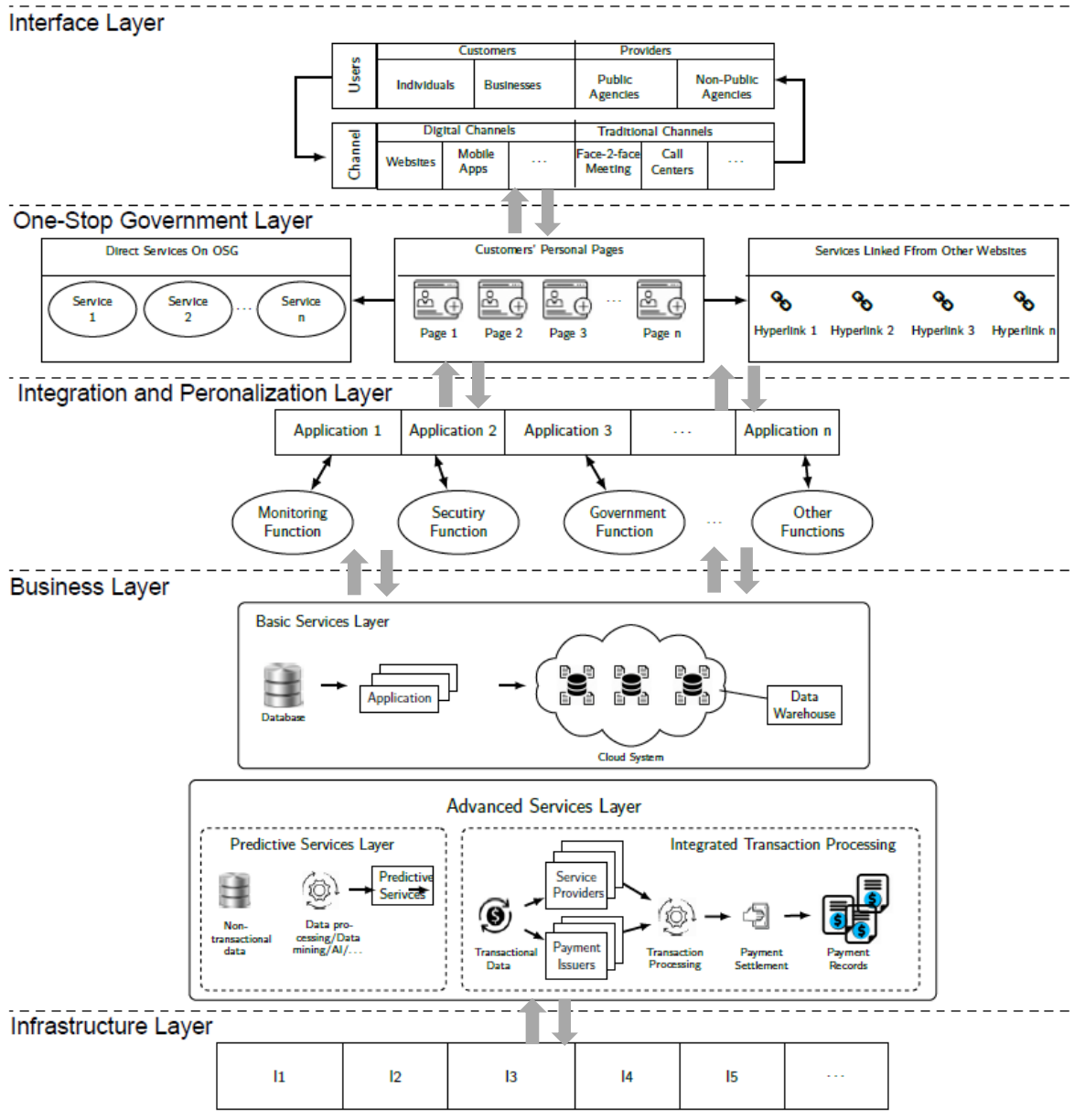

Figure 1: An architectural framework for One-stop Government (OSG)

The *Integration and personalization layer* plays a role of an intermediary, which connects front-end layers (interface and one-stop government layer) to back-end layers. This also serves as a protection wall for data and information in business layer. This layer can deliver agility, cost efficiency and integration (Winter & Fischer, 2006). This layer developed in response to the problem of integrating services from multiple agencies. Furthermore, as this layer sits between the front-end and back-end layers it can significantly improve the protection of the data and digital infrastructure layer, because to reach these layers an external entity would need to interact thorough this intermediary layer. This layer can also serve as a placeholder for extended security applications and solutions. A major contribution of this layer is the ability to manage the data integration required to respond to a customer service need on an

<sup>5</sup> [https://www.onegov.nsw.gov.au/gls\\_portal/sns/ Renew](https://www.onegov.nsw.gov.au/gls_portal/sns/ Renew) (retrieved 21st June 2018).

<sup>6</sup> <https://my.gov.au/LoginServices/main/login?execution=e1s1> (retrieved 21st June 2018).



secure, individual, just-in-time, need-to-know basis, reducing the risk of security breaches. It can also manage the process of seeking customer permission for data sharing, if required. In terms of mechanisms, it is created by combining multiple application each performing a particular function. For example, one application can have monitoring function while the other is implementing security function, or governance function. The set of applications and functions are not limited, they depend on target of each government agency and their technology capabilities.

The *business layer* is similar to Ebrahim and Irani's (2005) framework but different in components and structures. The special characteristic of this layer lies in its two sub-layers: (a) basic services and (b) advanced services. The basic service layer is responsible for storing data and carrying out services for users. Individual services can be siloed, and can be the responsibility of single agencies, the OSG functionality is achieved based on how these services can be integrated by the personalization and integration layer. The adoption of cloud computing technology will help governments to store a massive amount of information from simple database system. An example is that users of myGov are able to create accounts with personal information, which will be saved in this basic service layer with cloud computing technology. Added value is provided by the advanced services layer, which utilizes emerging technologies to deliver more sophisticated services, for example: generating predictive services for users, or processing the payment transaction. The benefits of predictive services can be enormous. It can help governments to identify services that are most accessed by users, then analyse the quality of the services to improve and innovate if necessary. For example, predictive service could be used when a user is receiving income support for job seekers, they can receive targeted advertisements related to job opportunities. Chatbots can potentially be a new advantage from using data mining technique. The payment/transaction services layer is where transactional requests are handled. The mechanism behind this needs the involvement of both service providers (government agencies and non-public agencies) and payment issuers (e.g. banks). Basically, after receiving transactional data, these two entities will proceed the transaction to settle the payments, then record payment results as a final step. The advanced services layer manages secure transactions with other entities, and manages the creation of benefits from basic services, by using artificial intelligence, analytics, and other techniques.

Lastly, the *infrastructure* layer provides foundational technologies for all previous layers, for example: application server, hardware and operation system (Ebrahim & Irani, 2005). Standard network and communication infrastructure should be integrated properly and take into account the revolution in technologies from other layers, so they can work smoothly and at the same time be prepared for changes in the future (Ebrahim & Irani, 2005).

## 5 CONCLUSIONS AND FUTURE OPPORTUNITIES

As society is modernizing, citizens and businesses are expecting governments to have more innovative ideas to improve the transparency and convenience of public services. At the same time, governments also want to strengthen relationships with citizens and businesses, as well as reduce the time, money and resources required to deliver public services. With the growth of technology, OSG has emerged as the win-win solutions for the expectations from both customers and governments.

As OSG is now still far from reaching its maturity level, three main challenges have been identified, including the limitation in using contemporary technologies; the risk of data intrusion; and the difficulty of OSG integration. Our framework addresses the major challenges of OSG architecture. Our contributions are as follows. Based on the work of Ebrahim and Irani (2005), we designed a new architecture with five layers, including interface layer, one-stop government layer, integration and personalization layer, business layer and infrastructure layer. Integration and personalization is a new layer that plays a role of an intermediary wall between front-end system (the first two layers) and the back-end system (the last two layers) to protect, monitor and control data and all business activities. This provides a layer that can manage privacy and security concerns, traverse multiple agencies, request services, and manage communication with customers. It also allows OSG solutions to be developed incrementally for specific customer segments without solving the entire problem of service integration at once. Our enhanced business layer combines the use of cloud computing, predictive data mining/AI, and payment transaction processing. It is extensible, and provides benefit for basic service delivery. Although we provide a way forward for the three afore-mentioned challenges, this is still a work-in-progress, with opportunities for other improvements. Our architecture is fairly high-level, and can be extended to provide more detail. With the rapid change of technology, OSG maturity models should be continuously updated as the purposes and functions of OSG are also changing. In addition, a major area for further research in the development of high-level process models for OSG. Our high-level

architecture can open opportunities for mapping out detailed processes in the personalization and business layers in particular. Finally, a set of new challenges should be detected so the next architectural framework can come up with ideas to have more improvements and innovations.

## References

- Baum, C., & Di Maio, A. (2000). Gartner's four phases of e-government model. *Gartner Group*, 12.
- Debri, F., & Bannister, F. (2015). *E-government stage models: A contextual critique*. Paper presented at the System Sciences (HICSS), 2015 48th Hawaii International Conference on.
- Dias, G. P., & Rafael, J. A. (2007). A simple model and a distributed architecture for realizing one-stop e-government. *Electronic Commerce Research and Applications*, 6(1), 81-90.
- Dillon, T., Wu, C., & Chang, E. (2010). *Cloud computing: issues and challenges*. Paper presented at the Advanced Information Networking and Applications (AINA), 2010 24th IEEE International Conference on.
- Ebrahim, Z., & Irani, Z. (2005). E-government adoption: architecture and barriers. *Business process management journal*, 11(5), 589-611.
- Jadeja, Y., & Modi, K. (2012). *Cloud computing-concepts, architecture and challenges*. Paper presented at the Computing, Electronics and Electrical Technologies (ICCEET), 2012 International Conference on.
- Keld, P. (2017). Realizing e-government benefits with minimal capabilities. *Transforming Government: People, Process and Policy*, 11(2), 262-285.
- Kim, G.-H., Trimi, S., & Chung, J.-H. (2014). Big-data applications in the government sector. *Communications of the ACM*, 57(3), 78-85.
- Kubicek, H., & Hagen, M. (2000). One stop government in Europe: an overview, in Hagen, M., Kubicek, H.(Eds). *One Stop Government in Europe. Results from 11 National Surveys*. Bremen, University of Bremen. 1-36.
- Lam, W. (2005). Barriers to e-government integration. *Journal of Enterprise Information Management*, 18(5), 511-530.
- Lambrinoudakis, C., Gritzalis, S., Dridi, F., & Pernul, G. (2003). Security requirements for e-government services: a methodological approach for developing a common PKI-based security policy. *Computer Communications*, 26(16), 1873-1883.
- Layne, K., & Lee, J. (2001). Developing fully functional E-government: a four stage model. *Government Information Quarterly*, 18(2), 122-136. doi:10.1016/S0740-624X(01)00066-1
- Lee, J. (2010). 10year retrospect on stage models of e-Government: A qualitative meta-synthesis. *Government Information Quarterly*, 27(3), 220-230.
- Linders, D. (2012). From e-government to we-government: Defining a typology for citizen coproduction in the age of social media. *Government Information Quarterly*, 29(4), 446-454.
- Lofstedt, U. (2012). E-government-assesment of current research and some proposals for future directions. *International journal of public information systems*, 1(1).
- Malik, M. B., Ghazi, M. A., & Ali, R. (2012). *Privacy preserving data mining techniques: current scenario and future prospects*. Paper presented at the 2012 3rd International Conference on Computer and Communication Technology (ICCCT 2012).
- Saha, P. (2012). Connected government as the new normal: A strategic thinking approach to whole-of-government enterprise architecture adoption. *Enterprise Architecture for Connected E-Government: Practices and Innovations* (pp. 1-55): IGI Global.
- Siau, K., & Long, Y. (2005). Synthesizing e-government stage models—a meta-synthesis based on meta-ethnography approach. *Industrial Management & Data Systems*, 105(4), 443-458.
- Winter, R., & Fischer, R. (2006). *Essential layers, artifacts, and dependencies of enterprise architecture*. Paper presented at the Enterprise Distributed Object Computing Conference Workshops, 2006. EDOCW'06. 10th IEEE International.
- Wyld, D. C. (2010). The cloudy future of government IT: Cloud computing and the public sector around the world. *International Journal of Web & Semantic Technology*, 1(1), 1-20.

# Mitigating traceability risks amongst SMEs along the beef supply chain: A multiple case study approach to investigating the role and potential impact of information technology

## **Mazino Amuno**

eLogistics Research Group  
School of Technology, Engineering & Design  
University of Tasmania  
Hobart, Australia  
Email: mazino.amuno@utas.edu.au

## **Mohammad Sadegh Taskhiri**

eLogistics Research Group  
School of Technology, Engineering & Design  
University of Tasmania  
Hobart, Australia  
Email: mohammadsadegh.taskhiri@utas.edu.au

## **Paul Turner**

eLogistics Research Group  
School of Technology, Engineering & Design  
University of Tasmania  
Hobart, Australia  
Email: paul.turner@utas.edu.au

## **Abstract**

This research-in-progress investigates how information technology can be used to mitigate increasing traceability risks being faced by small and medium sized enterprises (SMEs) along beef industry supply chains. Changing consumer preferences for information on product provenance as well as enhanced food safety requirements have increased the need for businesses to improve their traceability. Unfortunately, most traceability systems are designed for large organisations in well-integrated supply chains. For SMEs in fragmented food chains finding ways to respond has proven difficult. Deploying a heuristic traceability framework, the research has used a multiple case study approach that has involved the development, implementation and current on-going evaluation of some low-cost IT traceability tools in 5 different beef supply chain segments involving SMEs. Preliminary results provide new perspectives on the role and potential impact of low cost IT for mitigating risks amongst SMEs in beef chains and for further refining the heuristic traceability framework for SMEs.

**Keywords** Traceability, beef chain, SMEs, Information Technology, risks, case study

## 1 Introduction

Small and medium sized enterprises (SMEs) in the beef industry usually operate in complex multi-tiered networks involving numerous stakeholders along beef production and consumption value chains. This complexity often is accompanied by fragmentation that inhibits co-ordination between participants and the integration of information and product flows across various organisations (Adam et al. 2016). SMEs in the beef industry also display relatively low levels of technology use and technology sophistication across functional segments of their chains with paper documentation still very common. In this context, it is perhaps not surprising that SMEs ability to respond to traceability risks and challenges remains relatively low (Brooks et al. 2017).

The traceability risks and challenges increasingly being faced by SMEs relate to: (a) Provenance: retention of identity from the time an animal is born to when it is presented to the consumer as a cut of meat; (b) Food safety: whereby the consumer must be able to eat the meat without fear of adverse health effects, and, (c) Authenticity: provides consumers' with confidence that the meat is in fact what it purports to be on the label (Shackell 2008) (d) Animal Welfare: ascertaining and assuring consumers that the animals have been treated humanely on farm, during transportation, and prior to slaughter (Vanhonacker et al., 2007).

In responding to these challenges the research literature provides evidence that information technology (IT) adoption and use at different points in the supply chain can support greater awareness and visibility and potentially lead to effective risk mitigation (Cipolat 2016). Examples of IT use in addressing traceability issues include the use of radio frequency for identification (RFID) technologies and wireless sensor networks (WSN) (Carthy and Villalba 2018), and intelligent sensing and smart packaging systems (Sohail et al. 2018). More recently emerging technologies such as block-chains and distributed ledger technologies have been utilised to improve visibility and transparency of supply chains (Benton et al. 2018). However, considerable research has also highlighted that, while large organisations have been able to successfully implement these technologies in their supply chains, most SMEs continue to experience difficulties (Galliano and Orozco 2008). This situation for SMEs is in part due to a limited understanding and prioritisation of IT as a critical part of responding to the very real risks being faced and partly due to limited resources (Mattevi and Jones 2016). From a research perspective, it can also be argued that this lack of IT adoption and use is also linked to the reality that most of the models, tools, and frameworks advocated for enhancing traceability have been developed primarily with large businesses in highly integrated supply chains. As low SME adoption of these traceability approaches illustrate, most have proven to be inappropriate, impractical and/or too expensive for SMEs to adopt and use. As a result, SMEs have tended to only focus on minimum traceability in terms of tracking or tracing their products with immediate industry partners in what has been called a one-up-one-down (OUOD) siloed strategy (Nishantha et al. 2010). Unfortunately, with changing consumer preferences and enhanced food safety regulations this traceability approach is increasingly inadequate for SMEs to respond to the very real risks and uncertainties they are facing along beef supply chains.

This research-in-progress investigates how information technology can be used to mitigate traceability risks including provenance, meat safety, meat quality/authenticity, and animal welfare. being faced by SMEs along beef industry supply chains. The main contribution of this paper involves the development of a heuristic framework for IT traceability amongst SMEs that extends the work of Caridi et al. (2010) and adapts it to the specific case of developing an alternative approach for mitigating traceability risks amongst SMEs in beef chains. To further validate this framework and to increase detailed understanding of the role and potential impact of IT the research describes a multiple case study approach that has involved the development, implementation and current on-going evaluation of some low-cost IT traceability tools in 5 different beef supply chain segments.

## 2 A Heuristic Framework for IT Traceability in SMEs

In the last decade, understanding how to improve the visibility and alignment of information and product flows (traceability) amongst SMEs in food supply chains has emerged as an area of increasing importance. Approaches have included the use of mathematical models, simulation, and analytical modelling techniques (Dupuy et al. 2005) and the use of conceptual frameworks and reference models to harmonise and standardise data along food chains (Zhang and Bhatt 2014). These models and frameworks, whilst helpful, assume linear supply chains that are vertically integrated and, in most cases, involve primarily large businesses. For SMEs limited visibility and alignment of information and product flows beyond immediate supply chain partners has remained a problem and is not effectively

addressed in these widely cited models/frameworks. In this context, Caridi et al. (2010) proposed a systematic and structured approach that might be suitable for adaptation to SMEs and for use in more fragmented supply chains. In their approach, visibility is measured according to the amount and quality of useful information when compared to the total information that could be exchanged between nodes in a supply chain (Nguyen et al. 2017). This approach also opens up the possibility of better analysing the potential impact of visibility improvement on the supply chains using IT. However, this does assume that adequate baseline data on total information and information quality can be captured. Building on the work of Caridi et al. (2010), this research has developed a heuristic framework for guiding the conduct of a number of field studies at different points along SME beef chains.

In this framework supply chain visibility is determined by the amount and quality of information that an organisation can readily access and views at each node along the supply chain. The heuristic framework uses three information quality metrics: (a) Freshness: the degree of information “synchronisation” with business partners; (b) Accuracy: the degree of conformity of the shared information with its actual value; (c) Completeness: the degree of completeness of shared information. From among 22 metrics identified in a review of literature on evaluating information quality status in organisations e.g. assessment methods for information quality (AIMQ) criteria (Naumann and Rolker 2005), the three metrics adopted were found to be the most significant in terms of measuring visibility in multi-tiered supply chains (Caridi et al. 2013). Based on these metrics, it is possible to evaluate supply chain visibility as being the sum of visibility of information that any specific company has access to and views at different nodes/segments in a supply chain. In conducting the field studies this research has used four types of traceability information flows to focus on across the different segments of the beef chain. The four types of traceability information are:  $s$ =safety,  $q$ =quality,  $p$ =provenance and  $w$ =animal welfare. These four traceability information are indicative of the major risks factors impacting beef supply chains at different segments(Shackell 2008). Therefore in evaluating traceability information flows = “ $t$ ” the approach is to use the formula  $t=(s,q,p,w)$ . For each type of traceability information flow “ $t$ ”, the following definitions are used:

1. Meat Safety: Information related to the chemical, microbiological or physical attributes of food products;
2. Meat quality: Information describing the compositional quality (lean to fat ratio, meat percentage, intramuscular fat, marbling, protein, and muscle area); functional quality ( e.g. pH, and cooking loss); and eating quality or palatability of meat (e.g. appearance, juiciness, tenderness, and flavor)(ElMasry and Sun 2010);
3. Animal welfare: Information that describes the welfare status of an animal along the supply chain. Information includes the treatment animals receive e.g. animal care, animal husbandry, and humane treatment during transport and slaughter; and
4. Provenance: Information describing the origin, history and location of a product along the supply chain e.g. geography, region, or country of origin

Using the three information quality metrics provided for defining visibility (freshness; accuracy; amount/quantity) Table I illustrates how assessment calculations for each type of traceability information are being generated and how a visibility index is being calculated at each supply node for:  $c$ =completeness (quantity);  $a$ =accuracy; and,  $f$ =freshness. Where completeness is described as the quantity of information, and freshness and accuracy are defined in terms of the quality of information. In implementing this framework in the case studies, participants are requested to use a four-point rating scale to conduct a self-assessment of the visibility score for each type of traceability information (1-low to 4-high). This self-assessment approach provides quantitative data on comparative judgements on information quality status in organisations and along the supply chain because it takes into consideration the perspective of information sources, information users, and their information query processes (Naumann and Rolker 2005).

	Safety (s)	Quality(q)	Provenance(p)	Animal welfare(w)
Completeness(Quantity)	$t_{c,s}$	$t_{c,q}$	$t_{c,p}$	$t_{c,w}$
Accuracy	$t_{a,s}$	$t_{a,q}$	$t_{a,p}$	$t_{a,w}$
Freshness	$t_{f,s}$	$t_{f,q}$	$t_{f,p}$	$t_{f,w}$

Table 1. Assessments of supply visibility of traceability information (adapted from Caridi et al. (2010))

Table 2, illustrates the assessments used for each of the information quality criteria presented in relation to the four types of information flows. The table shows these assessments include completeness,

accuracy, freshness, overall visibility for a given type of information, and quality of overall visible information.

Indicator	Formula
Completeness/Quantity of overall visible information	$Node\_visibility\_completeness_k = \sqrt[4]{t_{c,s} * t_{c,q} * t_{c,p} * t_{c,w}}$
Accuracy of the overall visible information	$Node\_visibility\_freshness_k = \sqrt[4]{t_{a,s} * t_{a,q} * t_{a,p} * t_{a,w}}$
Freshness of the overall visible information	$Node\_visibility\_freshness_k = \sqrt[4]{t_{f,s} * t_{f,q} * t_{f,p} * t_{f,w}}$
Overall visibility for a given type $i$ information at a node $k$	$Node\_partial\_visibility_{i,k} = \sqrt[3]{t_{c,s} * t_{a,s} * t_{f,s}}$
Quality of the overall visible information	$Node\_visibility\_quality_k = \sqrt[3]{Node\_visibility\_accuracy_k * Node\_visibility\_freshness_k}$

Table 2. Assessment of information quality metrics for visibility of information at each supply chain node (adapted from Caridi et al. (2010))

## 2.1 Measuring visibility at individual supply chain segments

Table 3 illustrates the nature of the scales that participants are asked to use in self-assessment of organisational visibility and traceability information related to meat safety, meat quality, provenance and animal welfare. A full taxonomic classification of measurable variables related to these four traceability risks factors can be found in Molnár et al. (2011). The criteria used for each are accessibility to information, quality of the information and information completeness respectively. For example, in the area of meat safety, temperature is considered an important metric especially in the cold chain from the processor to retail. For provenance, important indicators include geographical positional systems (GPS) readouts at handovers points along the chain, country of origin labelling, and regional location labelling, as well as ingredients percentage labelling. In the area of meat quality, the pH is also considered an important measure of the quality of meat (Mach et al. 2008). In the area of animal welfare, studies have found the usefulness of collecting accelerometer and inertia data to validate the welfare status of cattle (Robert et al. 2009).

<b>Traceability information</b>	Supply chain node	I have access to none or less than 25% information	I have access to at least 25%-50% information	I have access to at least 50- than 75% information	I have access to at least than 75% or more information
<b>Freshness</b>	(0)	(1)	(2)	(3)	(4)
<b>Traceability information</b>	Supply chain node	The accuracy of exchanged information is usually very low and unsatisfactory	The accuracy of exchanged information is usually satisfactory but situations in which information is incorrect is not u common	The accuracy of exchanged information is usually satisfactory which information in few situations	The accuracy of exchanged information is usually satisfactory and very accurate
<b>Accuracy</b>		(1)	(2)	(3)	(4)

<b>Traceability information Completeness (Quantity)</b>	Supply chain node	Information is not always updated and not satisfactory (1)	Information is only updated when I ask suppliers to provide data (2)	In some cases information is updated when the node is asked to provide data (3)	Information is updated in real time in most cases (4)
---	-------------------	--	--	---	---

*Table 3. Judgement scale of visibility metrics for each traceability information at each supply chain node (adapted from Caridi et al. (2010))*

### 3 Methodology

The methodology being used in this research involves field studies with SMEs at 5 different beef supply chain segments in the Tasmanian beef industry. The choice of this multiple case study is appropriate for this study given that it follows replication rather than a sampling logic in the conduct of the research investigation (Noor 2008). This also provides an opportunity to identify and explore patterns between cases in order to validate the applicability of the proposed heuristic framework. The research strategy is organised in three phases of pre-intervention, intervention and post-intervention. The pre-intervention phase is organised into two steps. Firstly, preliminary engagement with 6 industry stakeholders in the Tasmanian beef chain was conducted to understand and validate whether these four major traceability risks are impacting the chain and to determine important metrics and indicators that can be used to characterize the risks. These industry stakeholders were selected from six major departments responsible for assessing and mitigating traceability risks at different segments, namely: Biosecurity and Traceability, Animal Brands, Meat Safety, Animal Welfare, Agricultural Veterinary (Agvet) and Chemicals, and Food Standards and local council food retail inspection. These are the major traceability risks areas impacting Tasmanian SMEs along the beef chain. Secondly, baseline data was collected from 8 participants from different beef supply chain segments within the Tasmanian beef industry who, following ethics approval, were invited via telephone to participate in face-to-face interactions across the three stages of the research. In phase one, the aim was to map the supply chain and to benchmark each participants' level of visibility at each segment in relation to meat safety, meat quality/authenticity, provenance, and animal welfare. The participants were drawn from the following segments: farmer, saleyard, processor, cold chain transport, and retail butchers. Participants provided suggestions on the metrics which they considered useful for their supply chain operations.

In Phase 2 (the intervention phase) the research team developed a mobile application and implemented wireless time and temperature sensors in the beef chain to investigate their impact in improving the quality of information available and perceptions of stakeholders around how this information could be used to increase visibility and potentially mitigate traceability risks in their supply chain segment. In phase 3 current on-going evaluation is occurring using both quantitative and qualitative techniques. It is anticipated as well as generating results on how these low-cost IT solutions have impacted on different SMEs along the beef chain, it will also be possible to further refine the heuristic framework that guided the approach to the multiple case studies.

At the level of the research design a mixed mode of data collection using semi-structured interviews, questionnaires were deployed. This allowed the development of a baseline map of the beef chain. Each participant was interviewed for approximately 60-90mins and additional documents related to interview responses were obtained for triangulation purposes and to improve the reliability of findings. Data analysis was conducted using qualitative and quantitative techniques. Voice transcripts derived from interviews were coded and analysed thematically to generate key themes emerging from the data. Paper documents derived from field investigation were analysed using both document and context analysis procedures. The questionnaires were analysed and interpreted using the assessment formulae presented in the tables above. This quantitative self-assessment is allowing for comparison with participants in Phase 3 evaluation. In the next section, preliminary results from case 1 involving three retail meat butcher stores are presented. The results highlight their current levels of visibility to traceability risks of safety, provenance, quality, and animal welfare in the beef chain.

## 4 Preliminary Results and Next Steps

This section presents preliminary findings from one segment of the beef chain involving three retail butcher stores in Tasmania. The results from phase 1 involving three retail butchers confirmed that across the cases the level of traceability and use of technology was low. In one case, there were significant traceability issues related to accuracy of provenance information. One butcher commented: *“I don’t market my beef as “xyz” or anything like that. I market my chicken as “abc” cos I buy my chicken from “abc”. I buy my pork from “efg” and I market those as such. But our beef, i’ll just.. if customer asks, i’ll give them a fair and honest answer. I can know where my products coming from generally but not a 100% of the time”-Butcher A.* This butcher explained that in many cases, it is difficult to market beef as Tasmanian beef due to poor traceability and also due to further disaggregation and mixing that occurs in the store. As a result, they prefer not to differentiate their local beef due to prevalent identity preservation challenges.

In the area of meat quality, authenticity and animal welfare were identified as key traceability challenges in Butcher B. The butcher commented about the issue of freshness and completeness of information as follows: *“Consumers sometimes ask where the products are from? Whether they are free-range, what type of breed, how it was treated, how old it is, specific cut, cattle sex, and whether it is left or right leg. Sometimes they ask which part of the body it is from. if they ask, we tell them primarily verbally”-Butcher B.* The butcher described a key problem related to gaining access to information in real time. In most cases, a follow-up phone call conversation with processors is required to access more information, and rarely do they have that information in real time when consumers demand for better information in the store.

Regarding the issue meat safety and integrity, Butcher C showed a marked difference as compared to Butcher A and B. There was limited interest in verifying meat integrity and safety in the cold chain. Trust and relationship quality were observed as significant predictors of perception bias despite the lack of any technologies. The response is as follows: *“No I don’t check what temperature it comes since they have a log and they just look at it and tell you when its dropped. Not with “ggf company” because I believe they are a professional operators, and as soon as there is a problem. They get another truck...as I said. They have things in place”-Butcher C*

In phase 2, a number of low-cost technologies were developed and implemented to improve visibility and enhance traceability in the case study, and they include: (a) 3 mobile applications (iOS and Android) integrated with quick response code and near field communication (NFC) reading functionality to improve consumer access and timeliness of traceability information related to beef provenance and meat safety in the 3 retail butcher stores; (b) 1 meat integrity android application, called chill verify, to improve completeness/accessibility to time and temperature readings in the cold chain between processor, cold transport, and retail butchers; (c) 2 low cost wireless temperature monitoring sensors to improve freshness and accuracy of equipment temperature in retail butcher stores; (d) 1 consumer verification app integrated with smart meat labels to verify complete information related to animal welfare, meat quality, province and meat safety directly on meat packages; and (e) 2 wireless activity monitoring sensors have been purchased and will be tested in the field to improve accuracy and accessibility to more animal activity data in the farm and during transport.

Preliminary evaluation is revealing markedly different reactions within and between different nodes. For example, amongst butchers there have been some who have enthusiastically adopted and use the trial systems and who are now seeking to invest and implement them into the future. Other butchers however have struggled and continue not to see value in improving their supply chain visibility and capacity for traceability. In reflecting on the heuristic framework, early indications are that it is helpful for obtaining quantitative judgement on visibility from a focal company’s point of view, however to eliminate bias in judgement, it is important that multiple sources of data be utilised. This is because, key observations from the field show that contextual factors such as trust and relationship quality could potentially lead to judgement bias. Thus, mixed methods evaluation triangulating interview responses with quantitative judgement from questionnaires were utilised to address this short coming. This study has contributed to the development of a framework for IT traceability in SMEs. This framework provides an alternative approach for SMEs to enhance visibility of alignment of information and material flow, and potentially mitigate traceability risks using low-cost IT tools. The next steps are to finalise the evaluation phase and complete this doctoral research.



## 5 References

- Adam, B. D., Holcomb, R., Buser, M., Mayfield, B., Thomas, J., O'Bryan, C. A., Crandall, P., Knipe, D., Knipe, R., and Ricke, S. C. 2016. "Enhancing Food Safety, Product Quality, and Value-Added in Food Supply Chains Using Whole-Chain Traceability,").
- Benton, M. C., Radziwill, N., Purritano, A., and Gerhart, C. 2018. "Blockchain for Supply Chain: Improving Transparency and Efficiency Simultaneously," *Software Quality Professional* (20:3).
- Brooks, S., Elliott, C. T., Spence, M., Walsh, C., and Dean, M. 2017. "Four Years Post-Horsegate: An Update of Measures and Actions Put in Place Following the Horsemeat Incident of 2013," *npj Science of Food* (1:1), p. 5.
- Caridi, M., Crippa, L., Perego, A., Sianesi, A., and Tumino, A. 2010. "Measuring Visibility to Improve Supply Chain Performance: A Quantitative Approach," *Benchmarking: An International Journal* (17:4), pp. 593-615.
- Caridi, M., Perego, A., and Tumino, A. 2013. "Measuring Supply Chain Visibility in the Apparel Industry," *Benchmarking: An International Journal* (20:1), pp. 25-44.
- Carthy, M., and Villalba, R. 2018. "New Trends in Cold Chain Monitoring Applications-a Review," *Food control*.
- Cipolat, A. C. 2016. "Supply Chain Risk Mitigation through Visibility and Collaboration for Smes in the South African Manufacturing Environment."
- Dupuy, C., Botta-Genoulaz, V., and Guinet, A. 2005. "Batch Dispersion Model to Optimise Traceability in Food Industry," *Journal of Food Engineering* (70:3), pp. 333-339.
- ElMasry, G., and Sun, D.-W. 2010. "Meat Quality Assessment Using a Hyperspectral Imaging System," in *Hyperspectral Imaging for Food Quality Analysis and Control*. Elsevier, pp. 175-240.
- Galliano, D., and Orozco, L. 2008. "Intra and Inter Organisational Determinants of Electronic-Based Traceability Adoption: Evidences from the French Agri-Food Industry," *12th Congress of the European Association of Agriculture Economics, Ghent, Belgium*.
- Mach, N., Bach, A., Velarde, A., and Devant, M. 2008. "Association between Animal, Transportation, Slaughterhouse Practices, and Meat Ph in Beef," *Meat Science* (78:3), pp. 232-238.
- Mattevi, M., and Jones, J. A. 2016. "Traceability in the Food Supply Chain: Awareness and Attitudes of Uk Small and Medium-Sized Enterprises," *Food Control* (64), pp. 120-127.
- Molnár, A., Van Lembergen, K., Gellynck, X., Sebok, A., and Berczeli, A. 2011. "What Can We Learn from Best Practices Regarding Food Chain Transparency?," *Proceedings in Food System Dynamics*, pp. 435-446.
- Naumann, F., and Rolker, C. 2005. *Assessment Methods for Information Quality Criteria*. Humboldt-Universität zu Berlin, Mathematisch-Naturwissenschaftliche Fakultät II, Institut für Informatik.
- Nguyen, H. V., Nguyen, H. T., Deligonul, S., and Cavusgil, S. T. 2017. "Developing Visibility to Mitigate Supplier Risk: The Role of Power-Dependence Structure," *Asia-Pacific Journal of Business Administration* (9:1), pp. 69-82.
- Nishantha, G., Wanniarachchige, M., and Jehan, S. 2010. "A Pragmatic Approach to Traceability in Food Supply Chains," *Advanced Communication Technology (ICACT), 2010 The 12th International Conference on: IEEE*, pp. 1445-1450.
- Noor, K. B. M. 2008. "Case Study: A Strategic Research Methodology," *American journal of applied sciences* (5:11), pp. 1602-1604.
- Robert, B., White, B., Renter, D., and Larson, R. 2009. "Evaluation of Three-Dimensional Accelerometers to Monitor and Classify Behavior Patterns in Cattle," *Computers and Electronics in Agriculture* (67:1-2), pp. 80-84.
- Shackell, G. H. 2008. "Traceability in the Meat Industry—the Farm to Plate Continuum," *International journal of food science & technology* (43:12), pp. 2134-2142.
- Sohail, M., Sun, D.-W., and Zhu, Z. 2018. "Recent Developments in Intelligent Packaging for Enhancing Food Quality and Safety," *Critical reviews in food science and nutrition*, pp. 1-13.
- Zhang, J., and Bhatt, T. 2014. "A Guidance Document on the Best Practices in Food Traceability," *Comprehensive Reviews in Food Science and Food Safety* (13:5), pp. 1074-1103.

## Acknowledgements

The authors acknowledge the support of the Australian Research Council Industrial Transformation Research Hub 'Pathways to Market' <http://www.utas.edu.au/pathways-to-market>

**Copyright:** © 2018 authors. This is an open-access article distributed under the terms of the [Creative Commons Attribution-NonCommercial 3.0 Australia License](https://creativecommons.org/licenses/by-nc/3.0/au/), which permits non-commercial use, distribution, and reproduction in any medium, provided the original author and ACIS are credited.

# Digital Work and High-Tech Wanderers: Three Theoretical Framings and a Research Agenda for Digital Nomadism

## Blair Wang

School of Information Systems and Technology Management  
UNSW Business School  
Sydney, Australia  
Email: blair.wang@unsw.edu.au

## Daniel Schlagwein

Discipline of Business Information Systems  
The University of Sydney Business School  
Sydney, Australia  
Email: schlagwein@sydney.edu.au

## Dubravka Cecez-Kecmanovic

School of Information Systems and Technology Management  
UNSW Business School  
Sydney, Australia  
Email: dubravka@unsw.edu.au

## Michael C. Cahalane

School of Information Systems and Technology Management  
UNSW Business School  
Sydney, Australia  
Email: m.cahalane@unsw.edu.au

## Abstract

This paper presents a literature review and conceptual development of digital nomadism. Digital nomadism is characterised by mobile workers indefinitely travelling between different locations while continually fulfilling their work obligations. The emerging literature on digital nomadism is fragmented and primarily focused on digital nomads' lifestyles. There is comparatively less focus on theoretically framing digital nomadism into broader narratives in human history. In order to gain a holistic understanding, this paper reviews the limited literature on digital nomadism and expands to other relevant literatures on economy (e.g. traditional boundaries in business), culture (e.g. lifehacking), and technology (e.g. telework and digital communication). These three theoretical framings of digital nomadism enable this paper to identify the current state of knowledge relevant to digital nomadism and develop a research agenda.

**Keywords:** digital nomadism, digital work, telework, factors of production, lifehacking, prosumers

## 1 Introduction

We live in a world in which digital technologies have transformed work. This is the phenomenon that the digital work research agenda seeks to understand (Orlikowski and Scott 2016). Digital work has been described in recent literature as a “grand challenge” for humanity (Colbert et al. 2016). It is such a challenge because it is accompanied by, for example, the loss of jobs as a result of more efficient production operations (Mrass et al. 2017), and reduced clarity about established work-related norms (Bordi et al. 2018). Nonetheless, as “the future of work itself” (Colbert et al. 2016), digital work presents an opportunity to improve human lives.

Digital nomadism is emerging as a growing segment of the digital work labour force. Digital nomads are teleworkers who have become so geographically mobile that they are free to work from almost anywhere in the world. They therefore choose not only to work from almost anywhere in the world but also live almost anywhere in the world, as “perpetual travellers” (Nash et al. 2018). Due to the digital nomads’ defining characteristic of never staying in one place for too long, the total number of digital nomads is difficult to ascertain, in the rough order of magnitude of 200,000 to 500,000 (Schlagwein 2018). Moreover, due to the recency of digital nomadism, research has been scarce (Schlagwein 2018), and the research that does exist is fragmented and primarily focused on the digital nomad’s lifestyle and psychological considerations such as self-actualisation (Müller 2016) and loneliness (Nash et al. 2018).

Yet digital nomadism is much more significant for humanity’s historical narrative than simply another lifestyle. Digital nomadism is not only a new lifestyle option but indeed a new way of working and organising. Therefore, the research question we address is: *How can we theoretically frame digital nomadism holistically as a new way of living, working, and organising?*

We answer this research question based on an interdisciplinary literature review. Grounded in the literature review, we propose and discuss three theoretical framings of digital nomadism: digital nomadism as *economic* activity; digital nomadism as a *cultural* phenomenon; and digital nomadism as a new *technology*-enabled form of working and organising. These theoretical framings enable us to develop a holistic view of the state of knowledge relevant to digital nomadism. Consequently, we are able to propose a research agenda. Our contribution is relevant for academics interested in, and those seeking to explore, a holistic understanding of digital nomadism. Our contribution may also be beneficial for driving the strategic decisions of commercial organisations, and the policy directions of governing bodies, responding to digital nomadism and related concerns.

## 2 Literature Review Method

We operationalised the hermeneutic approach to literature review developed by Boell and Cecez-Kecmanovic (2014). A hermeneutic literature review is characterised by interpretive, non-deterministic, non-replicable incremental discovery and understanding of literature. This was an important distinction for us, since there are many concepts and streams of literature that are related to digital nomadism but do not explicitly use that label, or even synonyms of that label. Keyword searches and systematic literature reviews would have therefore been unable to capture all relevant literature.

Accordingly, we started with a small set of highly relevant publications, and the resulting body of literature was formed through the conceptual relatedness of additional papers’ contents, rather than the semantic similarity of additional papers’ keywords. Although digital nomadism is still a very new phenomenon, it was possible – through a combination of initial keyword searches, subsequent interpretation, and citation tracking – to find a set of the most relevant articles (Müller 2016; Dobrinskaya 2016; Sutherland and Jarrahi 2017; Schlagwein 2018; Reichenberger 2018; Nash et al. 2018; Thompson 2018). The defining characteristic of this set is that they all explicitly use the term ‘digital nomad’ and provide an overview of digital nomadism from some perspective. Through multiple hermeneutic cycles, papers were discovered, read, re-read; and the direction of the literature search changed in response. The final set of 64 relevant papers includes 42 research papers (from academic journals and conferences, and chapters from edited volumes) and 22 papers from practitioners’ literature and newspapers. We selected these papers based on their ability to shed light on the phenomenon of digital nomadism, even if the papers were not specifically written about digital

nomadism. The reading and mapping/classifying of contents within these articles allowed for a critical assessment wherein three broad themes emerged; these are discussed in later sections of this paper.

Three dominant theoretical framings based on economy, culture, and technology were identified. This is shown in Figure 1 below. Topics such as digital (computer-mediated) communication and lifehacking emerged as the most relevant to explore under each broad theoretical framing. Subsequently, it was necessary to find papers specifically related to each of these topics. The papers under each topic are shown in Figure 1 around the circumference of the pie diagram in Figure 1 (only a sample of papers for each topic is shown so that the text is still readable). Papers published at academic outlets such as conferences and journals are shown in **bold** text whereas other sources such as newspaper articles and practitioner books are shown in *italics*. Referring to non-academic literature was appropriate because many concepts – for example, ‘lifehacking’ – emerged from such writing (e.g. Allen 2001; Ferriss 2007).

### papers focusing on digital nomadism

≤2017

**Müller (2016)**  
Digital nomadism as a type of work-life balance endeavor

**Dobrinskaya (2016)**  
Digital nomads' place in the narrative of human history and society

**Sutherland & Jarrahi (2017)**  
How digital nomads are enabled by digital platforms and infrastructure

=2018

**Schlagwein (2018)**  
Motivations for digital nomadism, based on orders of worth

**Reichenberger (2018)**  
Defining digital nomads based on their quest for personal freedom

**Nash et al (2018)**  
Defining digital nomads as digital workers, gig workers, nomadic workers, and global adventure travellers

**Thompson (2018)**  
Critical reflection on digital nomadism in terms of privilege, freedom, and security

inductively determined through hermeneutic cycles (Boell & Cecez-Kecmanovic 2014)

### topics relating to digital nomadism

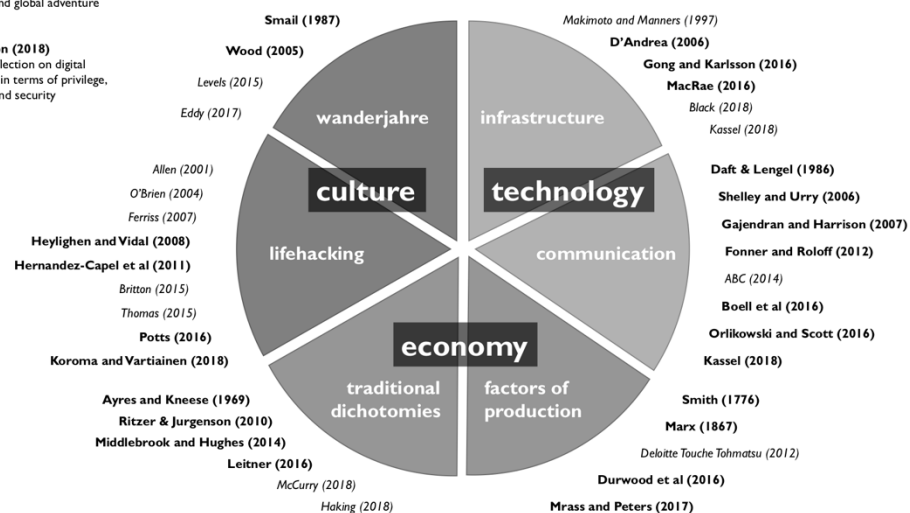

Figure 1. Outcome of the hermeneutic literature review of relevant literature.

## 3 Theoretical Framing 1: Digital Nomadism as Economic Activity

A portion of the reviewed literature suggests to theoretically frame digital nomadism as a new economic model. This view focuses on the underlying factors of production and sees digital work – such as that conducted by digital nomads – as a new form of economic activity. Digital nomadism exemplifies how this activity blurs the borders of old dichotomies such as production-or-consumption and customer-or-citizen. Businesses and governments, the majority of which are modelled on these established traditions, may find it helpful to adapt to such a conflation of previously separated concerns – a conflation that is not exclusive to digital nomads, but which is saliently exemplified by them.

### 3.1 Digital Factors of Production

There is a lack of consensus in the literature about what constitutes “digital work”. Some propose the definition of digital work as the use of “digital tools to produce digital goods” (Durward et al. 2016; Mrass et al. 2017). Others propose a definition of digital work as essentially knowledge work; and thus, digital

nomadism strictly as a type of knowledge work (Nash et al. 2018; Sutherland and Jarrahi 2017). Orlikowski and Scott (2016) propose a particularly broad definition wherein “work today always entails the digital; even where the work itself doesn’t directly involve a computing device”.

To understand the implications of digital nomadism as an example of digital work, it is important to first establish a clear definition of digital work. To this end, the hermeneutic cycles of the literature review took us to the conceptualisation of work at the heart of the modern economy: work as defined by its factors of production (Smith 1776), or as Marx (1867) labels them, the means of production. In either case, there are three factors of production: the *labour* (human effort involved in the work); the *subject matter* (the materials to which labour is applied, alternatively known as “land” or simply “subjects”); and the *instruments* (the reusable assets that assist human labour on the subject matter). Digital work, then, can be understood to be work in which digital technology has transformed factors of production. This can be seen in the case of the digital nomad. Labour is increasingly organised through distributed digital systems such as JIRA, Asana, and Google Calendar (Nash et al. 2018). Subject matter is increasingly digital data forming materials such as documents, statistics, audio/video recordings. Finally, instruments of work are now less defined by their mechanical configurations like the machines of the industrial revolution, and more defined by the bitstreams of digital data stored within the machine: ones and zeroes representing software that defines an instrument’s ability to assist with work.

This definition is important for two reasons. Firstly, it provides a unifying explanation for the different conceptualisations of digital work: Orlikowski and Scott’s (2016) definition refers to any work where digital technologies have transformed *any* factor of production. Their characterisation of modern work as “always entailing the digital” is therefore very reasonable. Meanwhile, the other definitions refer to only to work where digital technologies have at least transformed the subject matter, hence the characterisation of digital work as a subset of knowledge work. Secondly, understanding digital work as the digital transformation of factors of production clarifies the meaning of “disruptive” technology-driven phenomena such as digital nomadism. Such “disruptive” terminology is often misunderstood by key stakeholders in large organisations (Deloitte Touche Tohmatsu 2012). Clarifying “disruption” in terms originating in economics tradition, which such stakeholders are more likely to understand, is therefore likely to be helpful. An example of a research question arising from this could be: *How do digital nomads, in their work, perform factors of production through different materialisations of digital data?*

### 3.2 Challenging Traditional Dichotomies

Although they are both essentially providers of services, the traditional conceptualisation of government is fundamentally different to that of private industry. Digital nomads, however, have been said to reduce the nation state to merely yet another provider of services, namely residence and citizenship. This has come about from digital nomads’ ability to quickly move between jurisdictions; they effectively “hire and fire governments” (Crichton 2018). Even when digital nomads are residing within a state, the governing bodies may find it hard to exert as much influence as with more permanent residents. Digital nomadism leverages new technology platforms that are notoriously difficult to regulate. To obtain affordable and flexible accommodation arrangements, digital nomads have been known to rely on the grey-market housing service Airbnb (Nash et al. 2018; Sutherland and Jarrahi 2017). Existing literature has demonstrated that this service has significant implications for urban planning (Sans and Quagliari 2016), and poses issues for regulation (Leshinsky and Schatz 2018; Edelman and Geradin 2016). Digital nomads’ finances are also difficult for governments to track. In addition to moving funds between jurisdictions using payment-processing services such as PayPal and Transferwise (Nash et al. 2018), digital nomads are actively exploring the opportunities of cryptocurrencies such as Bitcoin (Sutherland and Jarrahi 2017), which cannot be regulated by governments using traditional monetary policy (Middlebrook and Hughes 2014).

In addition to the dichotomy of public versus private organisations, economics tradition has an established dichotomy of production versus consumption (Ayres and Kneese 1969). This has recently been challenged by examples such as self-crafted luxury goods (Kim and Kwon 2017), self-service and peer production (Ritzer and Jurgenson 2010), and tourism (Ateljevic 2000). The digital nomad joins this array of examples, being at the intersection of travel, leisure, and work (Müller 2016; Reichenberger 2018), becoming a hybrid of a travelling businessperson and a backpacker. The implications of these two very different social figures becoming one “flashpacker” is identified by Müller (2016) as being

relatively uncharted in the literature. There is established literature in that digital nomads are similar to freelancers in the gig economy (Nash et al. 2018; Sutherland and Jarrahi 2017), wherein an individual is also an entrepreneur and indeed their own company, and hence required to manage personal brand image, pursue potential clients (Sutherland and Jarrahi 2017), and build client trust from afar despite a potentially very unusual working arrangement from the client's perspective (Leitner 2016). In this context, it is observed that not only are consumption and production interweaved in a digital nomad's schedule, but in some cases, consumption directly enables production, particularly as many digital nomads work in some sort of journalism (Nash et al. 2018) such as travel blogging, food and restaurant review, and video-blogging (vlogging). Even when consumption is not directly linked to production, the interleaving of the two creates a "conflation of perpetual travel and work", the consequences of which are not yet fully understood, though existing discourse about the challenges of work-life balance may be relevant (Haking 2018; Nash et al. 2018). Effectively, these "prosumers" – a portmanteau of professional and consumer (Ritzer and Jurgenson 2010) – blend typical consumption activities into their factors of production: they may repurpose consumer electronics as instruments of production, adapt the domain of their leisure as the subject matter of their work; and organise labour using the same platforms that they use to connect with friends and family, e.g. Facebook.

The status quo nonetheless remains that the established production/consumption dichotomy dominates strategy formulation. Governments still organise territory as residential versus commercial, and businesses still market products to either consumers (B2C) or other businesses (B2B). Yet those who have already adapted their strategy to move away from the dichotomy have been successful. A typical example is Apple, who sell the same products to both consumers and producers, and has reaped the benefits of doing so: their positive brand image is asserted across both segments, positioning them as a known supplier for prosumers (Gerhardt 2010). Meanwhile, Apple's competitor Dell, who in fact launched a "digital nomads" website in 2008 to promote their business laptops (Shiels 2008), continue to follow the producer/consumer dichotomy and have since abandoned said "digital nomads" website.

For the strategies of both businesses and governments, digital nomadism therefore represents both opportunities and threats. The new players like Airbnb and cryptocurrency management companies have capitalised on the digital nomadism phenomenon and profited accordingly. There is an opportunity for governments, too, since governments provide a safety net around workers through the provision of healthcare, aged care, and labour market policies governing workers' rights such as working hours, paid family leave, and workplace justice (e.g. outlawing unfair dismissal and unjust discrimination); being detached from government for the sake of freedom means sacrificing such things for the sake of freedom (Thompson 2018). Some governments proactively attract digital nomads and thus enhance their technology sector; notably the example of Estonia, through their e-residency programme (Gat 2018). However, this has not been without risk; a nomad-friendly business may stumble due to an unfavourable regulatory climate as with Airbnb in Japan (McCurry 2018), and a nomad-friendly government may stumble due to an unfavourable business climate as Estonia experienced with their local banks closing foreigners' business accounts (Vahtla 2018). As these circumstances unravel, so too will research opportunities emerge to better understand how service providers – including business operators, and indeed, even the government as a "hireable and fireable" provider of public services – might best respond. An example of a research question arising from this could be: *How do traditional service providers, including government bodies, respond strategically to digital nomadism?*

## 4 Theoretical Framing 2: Digital Nomadism as a Cultural Phenomenon

A portion of the reviewed literature suggests to theoretically frame digital nomadism as a cultural phenomenon. Digital nomads fly the proverbial flag of the lifehacking subculture popularised in the early mid-2000s in a way that is reminiscent of the journeymen of old. It has yet to be fully understood how digital nomads' unique positioning within cultures impacts the way they work and do business with others. However, given the particularly salient cultural contexts in which digital nomads operate, and the uniquely-positioned concern that these cultural contexts have for work ethic and work-life balance, it would be quite likely that a deeper understanding of digital nomadism's cultural aspects would be beneficial for the strategic decision-making activities of businesses and governments.

#### 4.1 Self-Actualisation and the Lifehacking Subculture

Lifhacking is a recent subculture emerging in industrialised nations, closely associated with digital nomadism. Since the label “lifhacking” was first introduced by O'Brien (2004), lifhacking has come to refer to a worldview in which the challenges of one's life can be overcome using techniques analogous to hacking into a computer system. Accordingly, the lifhacking subculture is characterised by an affinity for autonomy, proactivity, and self-actualisation fulfilled through technical competence (Britton 2015; Thomas 2015). Digital nomads, who are characterised by self-actualisation (Müller 2016) and autonomy (Reichenberger 2018), are therefore closely affiliated with the lifhacking subculture. In particular, two prominent works (Potts 2010) from this subculture have become integral to the digital nomad's way of life (Schlagwein 2018): *The Four Hour Work Week* by Ferriss (2007), and *Getting Things Done* (GTD) by Allen (2001). The former popularised digital nomadism (Haking 2018; Schlagwein 2018), and the latter is a procedure for managing information overload – typical of what mobile workers such as digital nomads experience (Koroma and Vartiainen 2018; Sutherland and Jarrahi 2017) – which has become so influential that it has guided (Chait 2017) the design of the productivity software popular among digital nomads (Nash et al. 2018). The GTD procedure is notable for introducing the concept of “actionability” (Allen 2001), referring to the differentiation between, on one hand, information that represents the organisation of labour, and on the other hand, information used as instruments or subjects of labour.

There is relatively little literature exploring the impacts of the lifhacking subculture and the GTD procedure on work practices and outcomes in general, let alone in a digital nomadism context. The literature that does exist is primarily focused on the cultural significance of lifhacking (Thomas 2015), techniques to best implement GTD (Hernandez-Capel et al. 2011) and psychological outcomes of both GTD (Heylighen and Vidal 2008) and lifhacking in general (Potts 2010). One comment that has been made within the existing discourse, though, is that lifhacking is, at least conceptually, in opposition to the bureaucratic managerial practices originating in the industrial revolution (Potts 2010). This is implicit in the “hacking” within “lifhacking”, that there is something to “hack” and challenge. As seen in, for example, their implications for the traditional structure of economy, digital nomads are indeed challenging many established institutions to fulfil their desires. Future research may do well to understand how the digital nomads' potentially counter-cultural philosophical position affects how they relate to potentially bureaucratic business partners such as large corporate clients and government bodies. The findings may have implications for the strategies adopted by both digital nomads and their business partners to bridge what may be a significant gap in work ethic and working culture. An example of a research question arising from this could be: *How do the values and attitudes within the lifhacking subculture drive the trajectory of digital nomadism in relation to the role of work in one's life?*

#### 4.2 Digital Nomadism as the New Wanderjahre

Digital nomadism is not the first instance in human history in which post-agricultural societies have seen the rapid technology-enabled mobilisation of workers; an example of such a historical precedent can be seen in the *Wanderjahre*. In Medieval Europe, young tradespeople – essentially, the technology workers of that era – had a tradition of “taking to the road” (*auf der Walz*), travelling from town to town for a fixed period of two to three years (the *Wanderjahre*), carrying the tools of their craft, to enhance their personal and professional skills while free of personal attachments such as marriage (Eddy 2017). This tradition was spread to other European-influenced regions such as Australia, where the popular folk song *Waltzing Matilda* describes a particularly belligerent participant of this tradition (Davis 2013). These so-called “journeymen” (*Wandergesellen*) were established within society as parallel to the merchant class and often taken on board as apprentices by master craftspeople (Smail 1987). Though the *Wanderjahre* phenomenon disappeared during the course of the Industrial Revolution and the two World Wars, it has experienced a renaissance among tradespeople who have continued traditions such as initiation rites, strict community rules, and avoiding modern always-on connectivity such as mobile phones. Above all, what one modern journeyman said he appreciated most is the “freedom” afforded by his lifestyle (Eddy 2017).

There are strong parallels between digital nomadism and the *Wanderjahre*. Digital nomads are also typically young and of a particular profession that enables or encourages their travel, and they too value highly their exceptional freedom (Reichenberger 2018). They are also typically young and single, though



not exclusively; there are also digital nomads that travel together with a partner or family (Wood 2005; Reichenberger 2018), and indeed, traditional nomadism is deeply rooted in “the priority of the nomad’s family” (Dobrinskaya 2016). Yet the lack of attachments remains a persistent theme. Indeed, an assumption in the “1 billion nomads by 2035” forecast loosely extrapolated by Levels (2015) from public datasets is that the concept of the family will continue to deviate from traditional views such that by 2035, less than 40% of society will be married. This would ostensibly enable the mobility that facilitates widespread digital nomadism.

Future research may investigate how, if at all, digital nomads are similar to their journeymen counterparts. It is, for example, not well understood whether digital nomads are usually committed to a nomadic lifestyle for their entire lives, or if their intention is usually to have their own short-term *Wanderjahre* before settling down into a more traditional lifestyle. If digital nomadism does continue to grow to be a significant portion of society, as some speculate it will, government policy and business strategies would do well to adapt likewise, just as master craftspeople adapted to journeymen by taking them on as apprentices. If the so-called information revolution is indeed as significant in humanity’s historical narrative as the agricultural and industrial revolution, then the digital nomad, a key figure of this information revolution (Dobrinskaya 2016), is surely worth fully comprehending. An example of a research question arising from this could be: *How could the trajectory of digital nomadism be better understood by examining its historical precedents?*

## 5 Theoretical Framing 3: Digital Nomadism as a Technology-Enabled Form of Working and Organising

A portion of the reviewed literature suggests to theoretically frame digital nomadism as a new technology-enabled form of working and organising. This section presents the literature review of digital nomadism with respect to the underlying technological infrastructure, and the significance of technology for digital nomads’ interpersonal communication. It will be seen that, despite some optimistic views about digital nomadism in recent times, present-day infrastructure has yet to fully enable digital nomadism as it was originally conceptualised and the computer-mediated communication that digital nomads employ has not always been found adequate. Nonetheless, the progress that has been hitherto made has enabled reduction in regional inequality and brought with it advances in digital working patterns that challenge established understandings of digital communication altogether, and business and governments may benefit richly from advancing in step with such progress.

### 5.1 Telecommunications Infrastructure and Contradictions

At its core, digital nomadism is enabled by advances in technology. Makimoto and Manners (1997), who first introduced the term “digital nomad”, presented digital nomadism as a consequence of advances in electronics engineering, defined by the ability to connect any two points on the planet by “video link” to facilitate exchanges of “people, documents, and pictures”. Two decades later, the proliferation of internet access has indeed enabled digital nomads to connect to distant points across the planet, and indeed often by video (Kassel 2018; Schlagwein 2018). Internet connection speeds are crucial since slow internet speeds limit all three factors of production. Organisation of labour (e.g. task lists) may not be conveyed due to outages; digital subject matter is not transferred through the digital supply chain; and even instruments may be rendered unusable due to the increasing preference for cloud-based software (Nash et al. 2018).

However, fast internet access is not consistently available. Though digital nomads favour “exotic” locations (Reichenberger 2018), being “exotic” is generally unhelpful for internet access, since infrastructure is fixed and requires large investments by companies and governments. Nomadism implies geographic mobility, but “basic physics” means that a wireless connection is almost always slower than a wired one (Gong and Karlsson 2016). There are hence certain “hot spots” for digital nomads, and thus present-day digital nomadism has yet to fully fulfil the original 1997 vision.

Nonetheless, the advances that have been hitherto made have already helped reduce regional inequality. In Australia, for example, there is currently an interest at a national level in reducing regional inequality (Parliament of Australia 2018). Digital nomadism has already demonstrated a potential to improve economic productivity in areas outside of capital cities, such as the Southern Tablelands (Black 2018)

and Byron Bay (D'Andrea 2006). Other countries have seen similar regional rebalancing: in the neighbouring country of Indonesia, digital nomadism – enabled by the installation of fibre-optic internet connectivity just six years ago – has completely so much reshaped the former “village” of Ubud into a “diversifying international town” such that those once familiar with it no longer recognise it as such (MacRae 2016). Thus, examples of research questions that could be useful for strategic policy-setting include: *How does the tension between the affordances and constraints of current technology impact the work practices of digital nomads? How do infrastructure investments such as the NBN influence the decisions of digital nomads to move to regional areas? What are the impacts on regional areas when digital nomads do indeed move to them.*

## 5.2 Digital Collaboration and Communication

Of all the factors of production that are being digitally transformed, the organisation of labour has often been characterised as the most problematic for digital work, being complex and requiring effective communication. This is particularly so when the organisation of labour is manifested as collaborative decision-making or as the sharing of advice (Boell et al. 2016). Yet computer-mediated communication (CMC) is exclusively how digital nomads communicate with their clients. The literature is characterised by a lack of consensus about the efficacy of CMC in such remote-working arrangements. Müller (2016) interprets Sheller and Urry (2006) regarding digital nomadism thusly: that, due to contemporary communication and collaboration systems, it is now the case that “physical presence of the participants is no longer necessary” (Müller 2016, p. 344). This is at odds with persistent claims (e.g., Brumma 2016; Fonner and Roloff 2012; Gajendran and Harrison 2007; Ogara et al. 2014) that CMC and virtual presence are still inferior to face-to-face communication and physical presence, particularly in teleworking contexts of which digital nomadism is a specific example.

Nevertheless, digital nomads have been able to survive despite the apparent constraints of their exclusively digital communication. One possible explanation is that traditional perspectives such as media richness theory (Daft and Lengel 1986) and media naturalness theory (Kock 2005) are excessively focused on the channel of communication and whether that channel is inherently “rich”/“natural” or “lean”/“noisy”. Communication is, in that instance, a matter of accurately representing an objective external reality. In reality, the digital nomad employs a vast ecosystem of technology platforms enabling digital nomads to conduct their work (Nash et al. 2018): profession-specific tools (GitHub, Adobe Creative Cloud), general tools (Slack, Skype), productivity aids (Trello, Asana), and online communities with which to seek new work (LinkedIn, Medium, Upwork, Remoteok) or assist one another (NomadList, Hacker Paradise; Twitter, meetup.com, Facebook). In this instance, communication is about co-creating a new digital reality rather than recreating an existing external reality. Authors such as Nash et al. (2018) and Orlikowski and Scott (2016) argue that best explanation for this phenomenon is the *sociomateriality* worldview with its pillars of *performativity* (reality is co-created rather than captured) and *entanglement* (the inseparable intra-acting of people and technology in ever-evolving “assemblages”). Future research may investigate the sociomateriality of digital nomadism to understand how digital nomads seem to have achieved what literature often characterises as highly impractical: work entirely remotely with no face-to-face communication with business partners. This theoretical discourse has significant implications for business strategies and policy-setting. The business case for infrastructure investments such as Australia’s National Broadband Network (NBN) is often framed primarily in terms of video conferencing and being able to recreate face-to-face communication, and the objection is often framed in terms of whether video conferencing and recreating face-to-face communication is really the main objective (NBN Co 2017; ABC 2014). A paradigm shift may help these stakeholders better articulate, and thus leverage, the benefits of the technology. An example of a research question arising from this could be: *How do digital nomads perform effective communication in the digital space to cope with their limited ability to conduct face-to-face business?*

## 6 Discussion

We have presented the state of current understanding about digital nomadism. Although prior studies have considered in depth the digital nomads’ personal lifestyles, there has been relatively little in-depth consideration of how digital nomads fit into broader historical narratives, particularly regarding how they work, and how this may relate to the strategic positioning of businesses and governments. We have explicated this as six topics segmented into the three broad theoretical framings of the economic, the

cultural, and the technological. We have made a number of contributions to Information Systems (IS) research in relation to each of these topics by highlighting hitherto relatively neglected considerations and setting a research agenda for them:

- To better understand digital nomadism as an economic phenomenon, further develop a theoretical framework of the digital enactment of factors of production, and further investigate the consequences of blurring boundaries of public/private and consumption/production;
- To better understand digital nomadism as a cultural phenomenon, investigate the influences of the lifehacking subculture and its related concepts (e.g. GTD) and explicate the fundamental similarities between digital nomadism and the traditional *Wanderjahre* with respect to the future of the digital nomad and the digital nomad's life plan;
- To better understand digital nomadism as a technological phenomenon, investigate the impact of the constraints of the underlying technological including telecommunications infrastructure and the configuration of computer-mediated communication platforms.

Our contribution is constrained by the relative recency of the digital nomadism phenomenon and the consequently relatively small number of papers to consider. The phenomenon is very likely to continue to shift in unpredictable ways that, as with the current state, call for an interdisciplinary approach as well as multiple philosophical backgrounds. For example, a deeper consideration of the socio-cultural issues may likely require insights from traditions in the study of culture such as ethnographic principles; whereas a deeper consideration of the technological issues may likely require further insights from the literature on, for example, digital transformation; and a deeper consideration of the economic issues is very likely to require a serious consideration of the critical analysis of, for example, Marx (1867) in relation to modern capitalism and how this transposes into the digital era, for example, the contestation and reconfiguration of established orders of worth and institutional logics (Schlagwein 2018).

## 7 Conclusion

Digital nomads are teleworkers whose extreme geographic mobility allows them to work and live from anywhere, enabled by the digitising of their factors of production. They therefore choose to work from everywhere, living a life of ongoing interleaved work and travel. We may understand digital nomadism as an example of economic activity, wherein digital nomads challenge traditional dichotomies such as production/consumption and government/business. We may understand digital nomadism as a cultural phenomenon arising from lifehacking subculture and fulfilling a modern analogue of the wandering journeymen of old. We may understand digital nomadism as an example of limited but effective technological progress, wherein underlying infrastructure and subsequent digital communications are imperfect but have allowed significant progress to be made in terms of regional inequality and flexible working. As we continue to refine our understanding of digital nomadism, we open up many possibilities for businesses and governments to respond strategically to digital nomadism.

## 8 References

- ABC. 2014. "National Broadband Network (NBN) cost-benefit analysis released". *ABC News*, <http://www.abc.net.au/news/2014-08-27/nbn-cost-benefit-analysis-released/5698838>  
Retrieved 4 July 2018.
- Allen, D. 2001. *Getting Things Done: The Art of Stress-Free Productivity*. Penguin.
- Ateljevic, I. 2000. "Circuits of tourism: Stepping beyond the 'production/consumption' dichotomy," *Tourism Geographies* (2:4), pp. 369-388.
- Ayres, R. U., and Kneese, A. V. 1969. "Production, Consumption, and Externalities," *The American Economic Review* (59:3), pp. 282-297.
- Black, M. 2018. "Far-flung farm the right fit for young digital nomad". *ABC News*, 1 June.
- Boell, S. K., and Cecez-Kecmanovic, D. 2014. "A Hermeneutic Approach for Conducting Literature Reviews and Literature Searches," *Communications of the AIS* (34), pp. 257-286.
- Boell, S. K., Cecez-Kecmanovic, D., and Campbell, J. 2016. "Telework paradoxes and practices: the importance of the nature of work," *New Technology, Work and Employment* (31), pp. 114-131.

- Bordi, L., Okkonen, J., Mäkinen, J.-P., and Heikkilä-Tammi, K. 2018. "Communication in the Digital Work Environment: Implications for Wellbeing at Work," *Nordic Journal of Working Life Studies* (8:S3).
- Britton, M. 2015. "Lifehacking," in *YouthNation: Building Remarkable Brands in a Youth-Driven Culture*. John Wiley & Sons.
- Brumma, F. 2016. "Telework is Work: Navigating the New Normal," in *Cornell HR Review*. Cornell University.
- Chait, D. 2017. "The GTD Approach To Maximizing Productivity With Trello," in: *Trello Blog*.
- Colbert, A., Yee, N., and George, G. 2016. "The digital workforce and the workplace of the future," *Academy of Management Journal* (59:3), pp. 731-739.
- Crichton, D. 2018. "Digital nomads are hiring and firing their governments". *TechCrunch*, 18 February. <https://techcrunch.com/2018/02/17/digital-nomads-are-hiring-and-firing-their-governments/> Retrieved 15 May 2018.
- D'Andrea, A. 2006. "Neo-Nomadism: A Theory of Post-Identitarian Mobility in the Global Age," *Mobilities* (1), pp. 95-119.
- Daft, R. L., and Lengel, R. H. 1986. "Organizational Information Requirements, Media Richness and Structural Design," *Management Science* (32:5), pp. 554-571.
- Davis, M. 2013. "Der Waltzing Matilda". *SBS News*, 23 August. <https://www.sbs.com.au/news/der-waltzing-matilda> Retrieved 23 August 2013.
- Deloitte Touche Tohmatsu. 2012. *Digital disruption: Short fuse, big bang?*
- Dobrinskaya, D. E. 2016. "Nomadic lifestyle in the network society: sociological aspect," *Connect-Universum* (3).
- Durward, D., Blohm, I., and Leimeister, J. M. 2016. "Crowd Work," *Business & Information Systems Engineering* (58:4), pp. 281-286.
- Eddy, M. 2017. "Cleaving to the Medieval, Journeymen Ply Their Trades in Europe". *The New York Times*.
- Edelman, B., and Geradin, D. 2016. "Efficiencies and Regulatory Shortcuts: How Should We Regulate Companies like Airbnb and Uber?," *Stanford Technology Law Review* (19:2), pp. 293-328.
- Ferriss, T. 2007. *The 4-hour work week: Escape the 9-5, live anywhere and join the new rich*.
- Fonner, K. L., and Roloff, M. E. 2012. "Testing the Connectivity Paradox: Linking Teleworkers' Communication Media Use to Social Presence, Stress from Interruptions, and Organizational Identification," *Communication Monographs* (79:2), pp. 205-231.
- Gajendran, R. S., and Harrison, D. A. 2007. "The Good, the Bad, and the Unknown About Telecommuting: Meta-Analysis of Psychological Mediators and Individual Consequences," *Journal of Applied Psychology* (92:6), pp. 1524-1541.
- Gat, O. 2018. "Estonia Goes Digital: Residents of the tiny Baltic nation are going all in on techno-governance," *World Policy Journal* (35:1), pp. 108-113.
- Gerhardt, W. 2010. *Prosumers Essential to Accelerating New Markets for Service Providers*.
- Gong, S., and Karlsson, M. 2016. "Pushing the Wireless Data Rate to the Internet Speed," *IEEE Access* (4), pp. 8787-8792.
- Haking, J. 2018. "Digital Nomad Lifestyle: A field study in Bali." student thesis, KTH Royal Institute of Technology (Sweden).
- Hernandez-Capel, C., Belmonte-Carmona, A., Roca-Piera, J., and Alvarez-Bermejo, J. A. 2011. "Integrated architecture to track and organize tasks in corporations and institutions," *International Conference on Next Generation Web Services Practices (NWeSP)* (7).
- Heylighen, F., and Vidal, C. 2008. "Getting Things Done: The Science behind Stress-Free Productivity," *Long Range Planning* (41:6), pp. 585-605.
- Kassel, N. 2018. "Ultimately, it's freedom: The young digital nomads descending on Bali for a poolside career". *ABC News*.
- Kim, H. Y., and Kwon, Y. J. 2017. "Blurring production-consumption boundaries: Making my own luxury bag," *Journal of Business Research* (74), pp. 120-125.
- Kock, N. 2005. "Media Richness or Media Naturalness? The Evolution of Our Biological Communication Apparatus and Its Influence on Our Behavior Toward E-Communication Tools," *IEEE Transactions on Professional Communication* (48:2), pp. 117-130.
- Koroma, J., and Vartiainen, M. 2018. "From Presence to Multipresence: Mobile Knowledge Workers' Densified Hours," *The New Normal of Working Lives*, pp. 171-200.
- Leitner, T. M. 2016. *Corporate design principles to integrate digital nomads in post-bureaucratic organisations*. student thesis, Fundacao Getulio Vargas.
- Leshinsky, R., and Schatz, L. 2018. "'I Don't Think My Landlord Will Find Out.'" Airbnb and the Challenges of Enforcement," in *Urban Policy and Research*.

- Levels, P. 2015. "There will be 1 billion digital nomads by 2035", presented at the DNX Global Digital Nomad Conference, Berlin (Germany).
- MacRae, G. 2016. "Community and cosmopolitanism in the new Ubud," *Annals of Tourism Research* (59), pp. 16-29.
- Makimoto, T., and Manners, D. 1997. *Digital Nomad*.
- Marx, K. 1867. *Das Kapital*.
- McCurry, J. 2018. "Tourism pollution: Japanese crackdown costs Airbnb \$10m". *The Guardian*.
- Middlebrook, S. T., and Hughes, S. J. 2014. "Regulating Cryptocurrencies in the United States: Current Issues and Future Directions," *William Mitchell Law Review* (40:2).
- Mrass, V., Li, M. M., and Peters, C. 2017. "Towards a taxonomy of digital work", presented at the European Conference on Information Systems, Guimarães (Portugal), 5-10 June 2017.
- Müller, A. 2016. "The digital nomad: Buzzword or research category?," *Transnational Social Review* (6:3).
- Nash, C., Jarrahi, M. H., Sutherland, W., and Phillips, G. 2018. "Digital nomads beyond the buzzword: Defining digital nomadic work and use of digital technologies," *Lecture Notes in Computer Science* (10766), pp. 207-217.
- NBN Co. 2017. *Free video conferencing options for business*.
- O'Brien, D. 2004. "Life hacks: Tech secrets of overprolific alpha geeks," *Emerging Technology Conference*, San Diego (USA). <https://www.youtube.com/watch?v=NhbqrxmUIQg> Retrieved 15 May 2018.
- Ogara, S. O., Koh, C. E., and Prybutok, V. R. 2014. "Investigating factors affecting social presence and user satisfaction with Mobile Instant Messaging," *Computers in Human Behavior* (36), pp. 453-459.
- Orlikowski, W. J., and Scott, S. A. 2016. "Digital Work: A Research Agenda," in *A Research Agenda for Management and Organization Studies*. pp. 88-96.
- Parliament of Australia. 2018. "Regional Inequality in Australia." [https://www.aph.gov.au/Parliamentary\\_Business/Committees/Senate/Economics/Regional\\_Inequality\\_in\\_Australia](https://www.aph.gov.au/Parliamentary_Business/Committees/Senate/Economics/Regional_Inequality_in_Australia) Retrieved 4 July 2018.
- Potts, T. 2010. "Life Hacking and Everyday Rhythm," in *Geographies of Rhythm: Nature, Place, Mobilities and Bodies*.
- Reichenberger, I. 2018. "Digital nomads – a quest for holistic freedom in work and leisure," *Annals of Leisure Research* (21:3).
- Ritzer, G., and Jurgenson, N. 2010. "Production, Consumption, Prosumption: The nature of capitalism in the age of the digital 'prosumer'," *Journal of Consumer Culture* (10:1), pp. 13-36.
- Sans, A. A., and Quagliari, A. 2016. *Unravelling airbnb: Urban perspectives from Barcelona*.
- Schlagwein, D. 2018. "Escaping the Rat Race: Justifications in Digital Nomadism," *European Conference on Information Systems* (26).
- Sheller, M., and Urry, J. 2006. "The new mobilities paradigm," *Environment and Planning A: Economy and Space* (38:2), pp. 207-226.
- Shiels, M. 2008. "Digital nomad drives laptop sales". *BBC News*.
- Smail, J. 1987. "New Languages for Labour and Capital: The Transformation of Discourse in the Early Years of the Industrial Revolution," *Social History* (12:1), pp. 49-71.
- Smith, A. 1776. *The Wealth of Nations*.
- Sutherland, W., and Jarrahi, M. H. 2017. "The Gig Economy and Information Infrastructure: The Case of the Digital Nomad Community," *Proceedings of the ACM on Human-Computer Interaction* (1).
- Thomas, M. A. 2015. *Life hacking: a critical history, 2004-2014*.
- Thompson, B. Y. 2018. "Digital Nomads: Employment in the Online Gig Economy," *Glocalism: Journal of Culture, Politics and Innovation* (1).
- Vahtla, A. 2018. "E-Residency program under threat as banks closing foreigners' bank accounts". *Eesti Rahvusringhääling*.
- Wood, M. 2005. "Nomad Aesthetics and the Global Knowledge Economy," *Tamara: Journal for Critical Organization Inquiry* (3:4), pp. 50-64.

## Acknowledgements

One of the co-authors of this paper is conducting this research with the assistance of the Commonwealth of Australia through an Australian Government Research Training Program Scholarship.

## Copyright

**Copyright:** © 2018 authors. This is an open-access article distributed under the terms of the [Creative Commons Attribution-NonCommercial 3.0 Australia License](#), which permits non-commercial use, distribution, and reproduction in any medium, provided the original author and ACIS are credited.

# Customer Value Perception toward Use of Mobile Banking Applications

**Reihaneh Bidar**

School of Information Systems  
Queensland University of Technology  
Brisbane, Australia  
Email: r.bidar@qut.edu.au

## Abstract

Mobile banking (m-banking) is one of the most widely used applications and innovative banking services in the past decade. However, the adoption rate of m-banking in developing countries is low and still has potential for growth. We explored factors and value perceptions of clients toward the use of m-banking applications. A conceptual model is presented using the Technology Acceptance Model (TAM) and Uses and Gratification Theory (UGT). The tested variables are Perceived Usefulness, Perceived Ease of Use, Social Integrative, Personal Integrative and Hedonic Benefits. 278 valid survey responses were collected from Iranian and Turkish clients. Multiple regression analysis indicated that Perceived Usefulness and Social Integrative Benefit are the key drivers in both Iran and Turkey, but Hedonic Benefit is only significant in Iran. The results contribute to literature by integrating UGT and TAM and to participate as it enables banks to better design services and to improve customer experience.

**Keywords** mobile banking, information technology adoption, technology acceptance model, uses and gratification theory.

## 1 Introduction

Mobile banking (m-banking) refers to branchless banking (Liu et al. 2009), pocket banking (Amin et al. 2007) and mobile finance (Donner and Tellez 2008). Despite the benefits of m-banking (e.g. increased accuracy and speed in processing banking affairs, decreased currency depreciation and reduced cost), the utilisation of m-banking apps is still below market potential. Researchers suggest further investigation of adoption issues in m-banking is needed (Hanafizadeh et al. 2014), especially in developing countries (Mutahar et al. 2018). Riquelme and Rios (2010) anticipated that mobile phones will replace wallets for financial transactions in the near future. However, adoption of technology and services depends on people's knowledge growth and behavioural changes (Constantiou et al. 2007) and developments in technology do not guarantee widespread consumer acceptance (Wang et al. 2008).

This paper identifies two main shortcomings in literature regarding m-banking adoption. Firstly, although many studies have been conducted on m-banking adoption (e.g., Shaikh and Karjaluo 2015) and factors influencing the use of m-banking (e.g., Alalwan et al. 2016), research focusing on user's value perception is very limited in m-banking context. The importance of identifying user value perception is to identify benefits users expect to achieve from the use of a product/service which will help suppliers to provide support to enhance perception. Secondly, the majority of studies on use of m-banking have applied theory of Technology Acceptance Model (TAM) as the theoretical foundation. However, this paper uses TAM and modifies it to incorporate Uses and Gratification Theory (UGT) to capture user value perception that has been overlooked in the m-banking literature.

This paper focuses on Iran (IR) and Turkey (TR) as developing countries since the rate of m-banking usage among Iranians and Turkish are still growing and are becoming an integrated part of banks' business models (Mohammadi 2015; Onay and Öztaş 2018). In this sense, five variables were selected, and a conceptual model was designed to identify the key factors, as value perceptions, affecting the use of m-banking applications in developing countries. A survey with 26 items was designed and released online. 278 valid data sets were collected and analysed to test the hypotheses in the model. In this paper, I develop a conceptual model integrating TAM and UGT to empirically assess the model, the survey methodology was used. The findings have important implications for research and practice. For research, this study contributes to the literature by integration of UGT from user value perception view and TAM, in m-banking context. The empirical results support three UGT factors (Usefulness, Social Integrative Benefit and Hedonic) that can predict customer use of m-banking applications. For practice, applying social influence and hedonic aspects to the design of app user interface would help to motivate bank clients and provide a richer user experience. Also, it is important for practitioners to improve the functional and operational level of the system to satisfy customer expectations of usefulness and the quality level of services.

## 2 LITERATURE REVIEW AND THEORETICAL BACKGROUND

Researchers have used several theories to explain the adoption of information technologies. The most significant theories exploring the adoption of m-banking include theory of Planned Behaviour (Ajzen 1991), Decomposed Theory of Planned Behaviour (DTPB) (Taylor and Todd 1995), Diffusion of Innovation theory (DOI) (Rogers 1995), Theory of Reasoned Action (TRA) (Fishbein and Ajzen 1975), and TAM (Davis 1989). Wang et al. (2008) recommended a combination of TAM with external variables and network externalities to estimate the adoption of mobile communication innovation among customers. Beiginia et al. (2011) compared TRA, TPB and DTPB to see which model is more appropriate for the adoption of m-banking by consumers. Although there was not a significant difference between TPB and DTPB, DTPB had more influence on the determination of behavioural intention, attitude, and subjective norm and predicted customer's intention to use. A Meta-analysis of TAM showed that while TAM is a useful model for user behaviour on users' intention to use, it needs to be used as the base model (King and He 2006). TAM should be extended using other theories and variables to support contemporary tech-mediated context (Lim 2018).

This paper used TAM as a fundamental model and integrated UGT framework (Katz et al. 1973) as complementary to TAM. Uses and Gratifications is a theory of "why people use a particular kind of media product, and the gratifications they receive from that use" (Lampe et al. 2010). Using UGT helps us to capture the psychological needs which shape people's reason to use a medium to meet specific needs (Katz et al. 1973) and can lead to continuous use (Sangwan 2005). UGT has been used extensively in the social media and communication literature to understand user behaviour. UGT framework includes four attributes including usability, social integrative benefit, personal integrative benefit, and hedonic benefit which manifest the nature of benefits customers expect to gain from their participation in virtual communities (Nambisan and Baron 2009). We follow three main reasons for the integration of TAM



and UGT: first, this integration helps better understand users' use behaviour and motivations to use through the effect of social, personal, and hedonic factors. Second, while TAM and UGT have been used separately in different contexts, no study covered the integration of these models to establish a stronger grounding to explore customer use behaviour. Finally, studies suggested that TAM requires integration of personal and social, security, and behavioural control factors to include contemporary tech-mediated context (Lim 2018) which is captured in this paper through using UGT.

Many studies investigated drivers influencing m-banking adoption in developed and developing countries. For Iran customers, compatibility, trust, perceived usefulness, credibility, and perceived ease of use were found as acceptable constructs with higher effect on the use of m-banking while the need for interaction, perceived risk and perceived cost had the least influence (Hanafizadeh et al. 2014). Also, in the Iran context, system compatibility has been found to have a major impact on the user's attitude toward m-banking usage while subjective norms and personal innovativeness were mediating factors (Mohammadi 2015). Sheng et al. (2011) reported perceived usefulness, ease of use, compatibility, and risk had an impact on accepting m-banking in China. Yang (2009) presented convenience, security, and competitive basic fee are important to adopt m-banking in Taiwan. Self-efficacy and structural assurance found to be the most significant factors which indirectly influencing intention to use m-banking through usefulness and trust for Korean customers. Also, while a user-friendly interface was found to be essential to develop structural assurance and self-efficacy, factors such as low potential risk, and uncertainty should be reduced (Gu et al. 2009). Zhou et al. (2010) found that performance expectancy, task-technology fit, social influence, and facilitating conditions have a significant effect on the adoption. In India however, security, ease of use, and perceived cost, and computer self-efficacy were found to be significant for customers' intention to adopt m-banking (Singh and Srivastava 2018). However, no study investigated value perception related theories such as UGT to identify the main determinants of m-banking use and user value perceptions.

## 2.1 M-banking in Iran and Turkey

Regardless of the broad investigation in the context of m-banking adoption, very few studies have been conducted in the context of Iran (Hanafizadeh et al. 2014; Mohammadi 2015) and Turkey (Altinirmak et al. 2017; Onay and Öztaş 2018). It is important to investigate, as this service is not fully adopted in these countries and many developing countries.

In the context of Iran, Mohammadi (2015) focused on the perception of m-banking usage and Hanafizadeh et al. (2014) explored m-banking adoption. They found that the lack of m-banking adoption in Iran is because internet banking is still being slowly developed and the growth of m-banking adoption is expected to be even less than internet banking. A survey of e-banking identified Iranian customers preferred to use m-banking compared to other payment gateways such as internet banking and ATM (Aghdam et al. 2017). Nili and Keramati (2012) investigated customer retention in e-banking, showing the correlation between the existing retention programs and success in customer retention. Nahang and Araghi (2013) identified that the virtual bank requirements in the Iranians' banking network depend on external and internal organisational parameters. External organisational factors are uncontrollable and influenced by technical, cultural, educational, economic, and political sectors. This result indicates that a similar factor may affect the adoption of m-banking applications. Mohammadi (2015) believe that there is a lack of knowledge regarding the motivators that influence the adoption of m-banking services in Iran and how to improve the use of m-banking.

In Turkey, as of June 2017, 36 million registered customers logged into m-banking at least, and almost 24 million of them (67%) used m-banking services actively. This marks a significant increase, as in June 2013 only 2.7 million registered customers actively used m-banking (BanksAssociationTurkey 2017). For Turkish clients, price has been found to be a critical limiting factor for adoption of mobile phone services (Mao et al. 2005) which can lead to a lower intention to use of the new mobile services such as m-banking apps. A study on the adoption of Turkish banks identified that the larger private and local banks are more likely to adopt m-banking in complementary of physical branches (Onay and Öztaş 2018). Altinirmak et al. (2017) explored m-banking quality factors among Turkish banks and found Denizbank has the highest performance regarding response time, accuracy, trust and accessibility. From a customer perspective, perceived usefulness, perceived ease of use, security and privacy, compatibility, social influence, facilitating conditions and perceived cost were identified as predictors for the use of m-banking in Turkey (Bidar et al. 2014).

## 2.2 Research Model

The proposed research model is presented in Figure 1. It examines the various predictors of m-banking use for Iranian and Turkish customers. The model includes Perceived Usefulness (PU), and Perceived Ease of Use (PEOU) that are the basis of TAM. The remaining 3 factors are adopted from UGT (Katz et al. 1973) including Social Integrative Benefit (e.g., Social Influence), Personal Integrative Benefit (e.g., Trust, Compatibility, Individual Mobility, and Perceived Cost) and Hedonic Benefits. Usefulness is also one of the primary constructs in UGT framework. The rationale behind each of the constructs to the context of m-banking is described below.

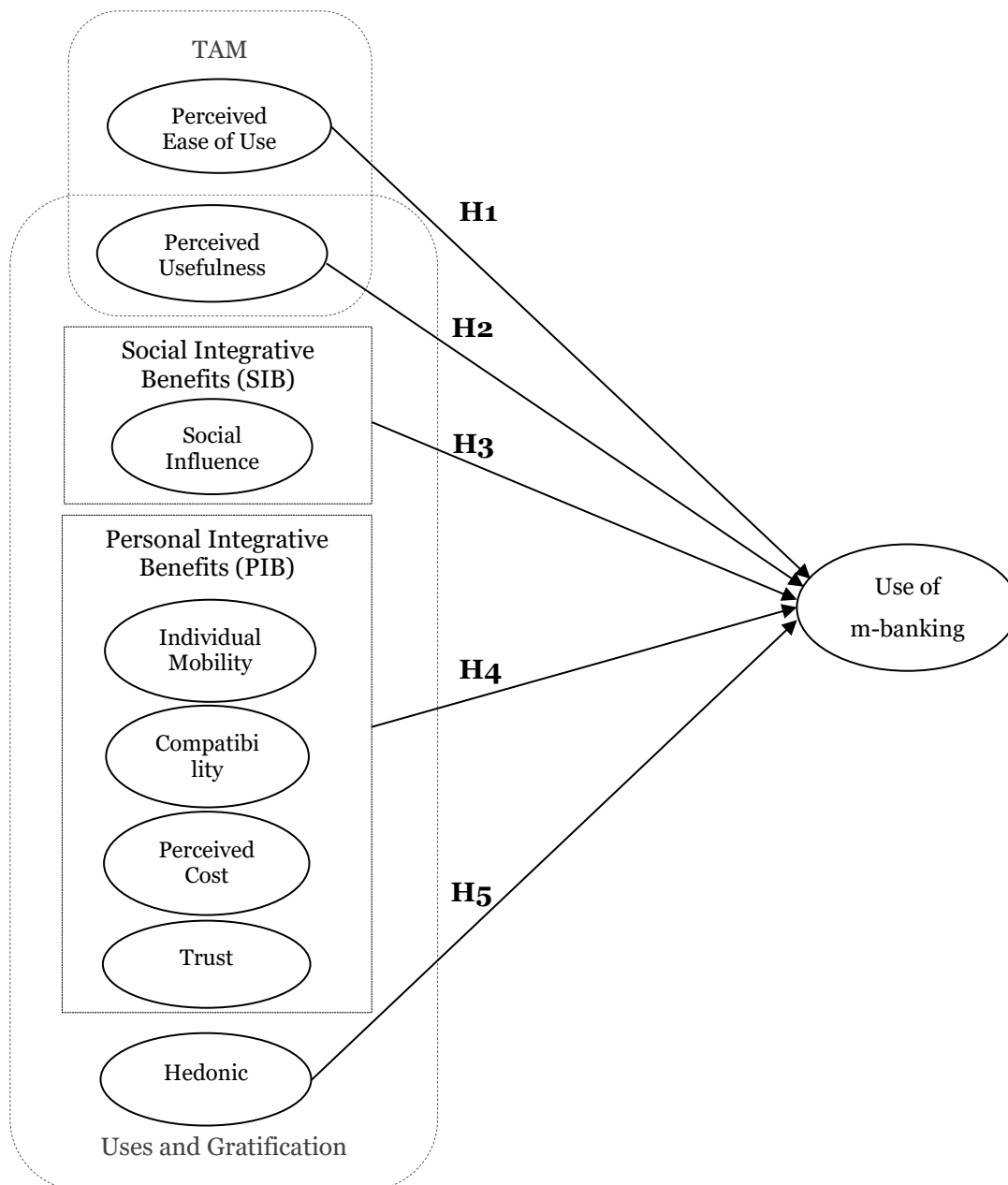

Figure 1: Research model: Use of m-banking in developing countries (Sample of Iran and Turkey).

**Perceived ease of use (PEOU)** is an individual's belief that the adoption of a system is free of effort (Davis 1989). M-banking systems must be easy to learn and easy to use to prevent interaction problems (Luarn and Lin 2005). PEOU has been found to positively influence m-banking adoption in developing countries such as Iran (Hanafzadeh et al. 2014) and Pakistan (Kazi and Mannan 2016).

**H1:** Perceived ease of use has a positive effect on use of m-banking apps.

**Perceived Usefulness (PU)** is an individual's belief that the adoption of a system would enhance their performance and efficiency (Davis 1989). PU has been discussed in the UGT framework as usability and has been a strong and a positive impact on m-banking usage (Davis 1989; Hanafizadeh et al. 2014; Luarn and Lin 2005). PU was found as the most critical factor influencing m-banking acceptance in both developed and emerging economies (Shaikh and Karjaluoto 2015).

**H2:** Perceived Usefulness has a positive effect on the use of m-banking.

**Social Integrative Benefit (SIB)** refers to the benefits a customer gains from the social interactions, including sense of belonging and strengthening consumer's ties with others (Katz et al. 1973). Social influence can be considered as a Social Integrative Benefit. Social influence (SI) and subjective norm were found as social factors influencing m-banking context. Social influence refers to the degree to which people are influenced by others' idea about using the new system (Venkatesh et al. 2003). Subjective norm, as a construct of social influence has been found to be important to the degree in which the social environment perceives mobile payment as desirable (Schierz et al. 2010). Social influence is a factor with a high impact on customers which have more tendencies to use m-commerce by trends, media, and peers (Chong et al. 2012). It was proven that Social influence significantly influences m-banking adoption (Alalwan et al. 2016).

**H3:** Customer Social Integrative Benefits perceived from m-banking services has a positive effect on use of m-banking apps.

**Personal Integrative Benefit (PIB)** are related to benefits associated with strengthening the credibility, confidence, and personal needs (KATZ 1974). Prior research has shown that users might act rationally in relation to their self-interest and improvement (Alexander Hars 2002). Some of the personal values investigated in m-banking and online banking adoption are Trust, Individual Mobility, Compatibility, and perceived cost. All these factors are stated as an implication of Personal Integrative Benefit that helps users' improvement.

Trust (T) is customers' beliefs of integrity and desirable idea toward their banks (Luo et al., 2010). Initial and continuance trust are two fundamental elements of trust. Initial trust converts to continuance trust by gaining experiences (Beiginia et al. 2011). Trust has been found as a crucial factor driving customer's m-banking adoption (Zhou 2012) and was found as a key driver for Iranian bank customers (Hanafizadeh et al. 2014).

Compatibility (COM) is the degree to which an innovation is stable with the existing values and beliefs, past experiences, and current needs (Rogers 1995). It is important for firms to focus on compatibility of m-banking with user's daily needs and preferences to attract more users (Sohail and Al-Jabri 2014).

Mobility and pervasiveness of smartphone shift the attention of individuals toward different application services. Individual Mobility (IM) refers to "the degree to which an individual pursues a mobile lifestyle" (Schierz et al. 2010). Few studies explored Individual mobility (e.g., Schierz et al. 2010) and found a positive correlation to intention to use payment services.

Many studies refer to perceived costs as a barrier to accept m-banking (Chong et al. 2012; Dai and Palvi 2009; Hanafizadeh et al. 2014). Customers compare costs and benefits, and if costs exceed the benefits, they refuse to adopt services (Ho Cheong and Park 2005).

**H4:** Customer Personal Integrative Benefits perceived from m-banking services has a positive effect on use of m-banking apps.

**Hedonic Benefit (HED)** refers to the customer's entertainment or pleasurable experiences (Katz et al. 1973) and satisfaction gained from using the electronic commerce application (Van der Heijden 2004). Nurture of playfulness in the design of medium lead to customer participation (Kohler et al. 2011). Zhang et al. (2015) also found that the hedonic benefit plays a significant role in intention to participate compared to other UGT benefits. In the context of e-commerce hedonic value is predicted to play a more significant role than usefulness on customer's decision making to adopt the system (Van der Heijden 2004).

**H5:** Customer Hedonic Benefits perceived from m-banking services has a positive effect on use of m-banking apps.

### 3 METHODOLOGY

A survey questionnaire was designed to investigate major predictors for m-banking acceptance in Iran and Turkey. The scale items adopted mainly from Hanafizadeh et al. (2014), Venkatesh et al. (2003),

and Lee et al. (2012). The questionnaire included two parts: (1) demographic information; and (2) items related to the variables; In order to ensure validity and trustworthiness of the questions, a small group of m-banking experts and customers checked the questionnaires. Most questions were assessed via a five-point Likert scale in a range from strong disagreement to strong agreement. The survey was distributed among university students. A total number of 278 valid responses from participants were gathered.

## 4 RESULTS

Table 1 shows the descriptive statistics of the participants from both countries. 150 Iranian (79 male and 71 female) and 128 Turkish (74 male and 54 female) participated in the survey. Most respondents aged between 18 and 40. The results revealed that the primary features performed by mobile financial applications from Iranian viewpoint are checking account, transferring money and paying bills, while Turkish users prefer monitoring credit card, checking account and transferring money.

Category		Total		Iran		Turkey	
		F	%	F	%	F	%
Gender	Male	153	55	79	52.7	74	57.8
	Female	125	45	71	47.3	54	42.2
Age	18 – 25	110	39.6	41	27.3	69	53.9
	26 – 30	90	32.4	54	36	36	28.1
	31 - 40	55	19.8	37	24.7	18	14.1
	40 >	23	8.2	18	12	5	3.9
Education	College	27	9.7	21	14	6	4.7
	Bachelors	151	54.3	59	39.3	92	71.9
	Graduate and above	100	36	70	46.6	30	23.4

*F: Frequency, %: Percent*

*Table 1. Descriptive statistics of the participants.*

### 4.1 Reliability

The reliability of the survey for each country was determined separately. Table 2 displays the Cronbach's alpha values of the factors affecting m-banking adoption. The alpha coefficient between 0.6-0.7 represents a lower limit of acceptability, and a reliability coefficient of .70 or higher is considered as high consistency (Hair et al. 2010). The reliability of Hedonic data of Turkish participants and Individual Mobility and Social Influence of Iranians were relatively low, but they are still acceptable. The data for the other factors had high reliability. Overall,  $\alpha$  values for the Iranian and Turkish data were .87 and .89 respectively.

Variable	# of Items	Cronbach's alpha (Iran)	Cronbach's alpha (Turkey)
PU	4	.87	.89
PEOU	3	.71	.79
SI	3	.65	.69
TR	3	.73	.85
COM	3	.81	.81
IM	2	.60	.81
PC	3	.82	.85
HED	2	.74	.61
USE	3	.82	.85

*Table 2. Reliability of the collected data.*

### 4.2 Comparison of the Factors

Independent sample t-test was conducted to compare the variables between the test groups. Table 3 reveals that there is not a significant difference between Trust, Individual Mobility, Perceived Cost and Hedonic in Iran and Turkey. However, significant differences were observed in Perceived Usefulness, Perceived Ease of Use, Compatibility and Social Influence. Perceived Usefulness was significantly

important for Turkish users ( $t(252) = -4.63, p = .000$ ). Turkish users have been significantly more attracted by the simplicity of m-banking than Iranians ( $t(237) = -5.70, p = .000$ ). Compatibility was believed more significant in Turkey ( $t(276) = 3.10, p = .002$ ). Turkish users were significantly more affected by Social Influence than Iranian users ( $t(276) = -2.67, p = .008$ ).

Variable	Group	N	Mean	Std. Dev.	T-Statistics	p-value
PU	IR	150	1.84	.81	-4.63	.000
	TR	128	2.33	.94		
PEOU	IR	150	1.75	.72	-5.70	.000
	TR	128	2.33	.93		
SIB	IR	150	2.95	.85	-2.67	.008
	TR	128	3.21	.81		
TR	IR	150	2.49	.89	.66	.509
	TR	128	2.42	.86		
PIB	IR	150	1.67	.82	-1.51	.133
	TR	128	1.83	.89		
PC	IR	150	3.66	.90	-.28	.777
	TR	128	3.71	.90		
COM	IR	150	2.01	.85	-3.10	.002
	TR	128	2.35	.95		
HED	IR	150	3.44	1.09	-.71	.478
	TR	128	3.53	.96		

Table 3. Mean value comparison of each factor.

### 4.3 Correlation among Factors

Pearson product moment correlation coefficient was calculated to show the correlations between identified variables for each group. This method estimates whether there is a linear relationship between two variables in the population. The correlations among variables in Iran is given as a sample of how we analysed the correlation among factors in Table 4.

All Iranian variables showed positive relationships between the use of m-banking, but the perceived cost had a negative relation. Perceived Usefulness (.610), Perceived Ease of Use (.530), Compatibility (.552), Trust (.558) and Social Influence (.593) had significantly strong relationship individually with the use of m-banking. Positive relationships were observed between PU-PEOU (.583), PU-COM (.574) and SI-TR (.527). For the Turkish users, significant positive correlations were found between the used of m-banking and Perceived Usefulness (.649), Perceived Ease of Use (.638) and Compatibility (.676). The strongest relationship between variables in Turkey sample belongs to the PU-PEOU (.747) and COM-PEOU (.729).

	PU	PEOU	COM	TR	SI	FC	PC	HED	USE
PU	1.00								
PEOU	.583**	1.00							
COM	.574**	.463**	1.00						
TR	.427**	.402**	.480**	1.00					
SI	.455**	.376**	.405**	.527**	1.00				
IM	.321**	.577**	.350**	.342**	.246**	1.00			
PC	-.175*	-.144	-.228**	-.153	.010	-.279**	1.00		
HED	.212**	.289**	.246**	.342**	.063	.213**	-.397**	1.00	
USE	.610**	.530**	.552**	.558**	.593**	.400**	-.203*	.368**	1.00

Table 4. Correlation matrix for Iran (Note: N=150).

### 4.4 Tests of Hypotheses

Multiple regression analysis was conducted to test the five hypotheses. For Iran, three hypotheses of H1 (Perceived Usefulness), H3 (Social Integrative Benefits) and H5 (Hedonic) were supported to have a

positive impact on the use of m-banking at  $\alpha = .003$ . In Turkey, only H1 and H3 were supported to have a positive influence on the use of m-banking in Turkey at  $\alpha = .003$ . Table 5 shows the test results of all hypotheses for the proposed research model.

Hypotheses	Iranian	Turkish
H1: PU-USE	<b>Supported</b>	<b>Supported</b>
H2: PEOU-USE	Rejected	Rejected
H3: SIB-USE	<b>Supported</b>	<b>Supported</b>
H4: PIB-USE	Rejected	Rejected
H5: HED-USE	<b>Supported</b>	Rejected

Table 5. The result of testing hypotheses.

## 5 DISCUSSION

The findings of this research provide insight into the factors which are influencing people's use of m-banking instead of traditional banking procedures. The factors which have a significant influence on the use of m-banking in Iran were Perceived Usefulness, Social Integrative Benefit and Hedonic Benefit. Similar to Iran sample, influential factors in use of m-banking in Turkey were Perceived Usefulness and Social Integrative Benefit, but not Hedonic Benefit. Multiple regression analysis was conducted to test the five hypotheses. The  $\beta$  value represents the standardised coefficient which shows the strength of the effect of the independent variable on the dependent variable.

The first hypothesis was rejected for both countries (Iran:  $\beta = .063$ ,  $p > .05$ ; Turkey:  $\beta = .111$ ,  $p > .05$ ). Liu et al. (2009) also found out that perceived ease of use has no significant influence on the user acceptance of m-banking. In contrast, in the developing country context, PEOU was found as a significant factor in the previous studies (Hanafizadeh et al. 2014; Kazi and Mannan 2016). However, this paper does not confirm a relation between PEOU and use of m-banking in developing countries. Since computer-based systems have become more common these days and people have acquired more knowledge and experience of using smartphones and new applications, there will be less concern about the complexity of the new systems.

The second hypothesis stated that Perceived Usefulness positively influences the use of m-banking apps in both Iran and Turkey. This claim is supported significantly by our findings (Iran:  $\beta = .242$ ,  $p < .01$ ; Turkey:  $\beta = .279$ ,  $p < .01$ ). This further explains that the more customers realise m-banking services to be useful, the more they will be absorbed into the use of m-banking apps. Dai and Palvi (2009) and Amin et al. (2007) also found that Perceived Usefulness of m-banking influences the adoption of novice technologies.

H3 was accepted and Social Integrative Benefit was found to have a positive effect on m-banking usage (Iran:  $\beta = .320$ ,  $p < .01$ ; Turkey:  $\beta = .170$ ,  $p < .05$ ). Similar to the findings of Zhou et al. (2010) in which social influence is a significant determinant of m-banking and online banking acceptance. Son et al. (2012) believe the positive effect of mobile computing devices among social circle increases the idea to which the system is useful. Therefore, the high impact of social factors reveals that friends, social networks, gamification methods influence customers and these interactions can form their opinions and decisions.

H4 which supposed a positive impact of Personal Integrative Benefits on use of m-banking was not supported. The results demonstrate that the essential requirements for m-banking usage such as mobility were provided in these two countries. Regarding to perceived cost, cellular phone users have more tendency to use m-banking services than any others (Hanafizadeh et al. 2014). In contrast, perceived financial cost was found as a significant barrier for users of mobile banking (Luarn and Lin 2005). Min et al. (2008) identified trust, privacy, convenience, and cost as the original determinants in affecting the behavioural intuition of Chinese clients. Although trust in using a new system is always a concern for users, we found that Iranian and Turkish customers believe their banks as a reliable organisation. Adequate knowledge and familiarity of respondents with mobile applications and working up-to-date with banks reduce their disbelief on using m-banking. Hanafizadeh et al. (2014) also identified trust as the most significant antecedents explaining the adoption of m-banking. Compatibility is believed very important for easy use of various systems and products and increasing popularity of m-banking (Hanafizadeh et al. 2014; Lin 2011). However, these personal factors failed to have a significant impact on the use of m-banking in the context of this paper.

Hedonic Benefit (H5) was observed to have a significant positive impact on the use of m-banking in Iran. However, it was not a critical factor in Turkey (Iran:  $\beta = .189$ ,  $p < .01$ ; Turkey:  $\beta = .053$ ,  $p > .05$ ). Users with higher playfulness perception have greater use of m-banking applications and enjoyment from their usage and usefulness of m-banking. Therefore, the use of m-banking applications is higher in Iran when users believe that the service application provides greater hedonic experience.

This paper has three main contributions. From the conceptual viewpoint, we present a model developed from two theories related to the consumer use behaviour in adopting new IS system. The proposed model is an extension of Dai and Palvi (2009) TAM with UGT to m-banking context. The extended model provides a more holistic view of the drivers of user acceptance of m-banking services compared to previous studies. Integration of UGT framework with TAM provides a stronger grounding to explore the use of a new system and helps to reduce the constraint of TAM by supporting the social and hedonic aspects. Specifically, testing the model through different stability tests and using a large sample provides confidence in the findings. Second, the findings of this paper show some significant contributions to the management of mobile services by financial institutions. In particular, an understanding of m-banking process could be quite useful for determining those strategies and actions that better fit consumers' preferences and demands. For example, in both Iran and Turkey banks should focus more on improving functional and operational implementation of the m-banking apps. Also, improving user experience through creating a more gamified design features helps practitioners to create a positive social influence in both countries and satisfy the hedonic benefits for Iranian customers. Finally, this paper provides an insight to the practitioners in filling the lack of knowledge on factors influencing m-banking applications in Turkey and Iran, as both are developing countries. There is still a new market opportunity in both countries.

## 6 CONCLUSION

This paper focused on consumer behaviour on the use of m-banking services. Previous studies on m-banking have used TRA, TPB, and TAM to measure consumer behavioural intention. This paper established an accurate measurement to predict and explain consumer willingness and use of m-banking applications and services through integrating TAM and UGT. We extended TAM using UGT framework to find out people's value perception toward the use of m-banking. We applied multiple regression analysis to determine which variables maintain more persuasive power on use of m-banking. Perceived Usefulness, Social Integrative Benefit and Hedonic Benefit in Iran and Perceived Usefulness and Social Integrative Benefit in Turkey were found as the most important values and drivers in explaining user's use of m-banking. A system that is aligned with the customers' daily needs would have a more positive effect on the m-banking usage. On the other hand, banks in Iran need to employ strategies to enhance Hedonic and playfulness experience through the design of m-banking apps for increasing the number of consumers. Additionally, positive feedback from peers, friends and the impact of advertisements would improve the customers' tendency toward usage of m-banking in both countries.

## 7 REFERENCES

- Aghdam, A. R., Xu, S., Kaveie, A., Fahimi, S. A., Khani, E. G., and Kamalpour, M. 2017. "Performance Assessment of Payment Gateways in Banking Services in Tehran, Iran," *International Journal on Computer Science and Engineering* (9:8), pp. 496-505.
- Ajzen, I. 1991. "The Theory of Planned Behavior," *Organizational Behavior and Human Decision Processes* (50:2), pp. 179-211.
- Alalwan, A. A., Dwivedi, Y. K., Rana, N. P., and Williams, M. D. 2016. "Consumer Adoption of Mobile Banking in Jordan: Examining the Role of Usefulness, Ease of Use, Perceived Risk and Self-Efficacy," *Journal of Enterprise Information Management* (29:1), pp. 118-139.
- Alexander Hars, S. O. 2002. "Working for Free? Motivations for Participating in Open-Source Projects," *International Journal of Electronic Commerce* (6:3), pp. 25-39.
- Altinirmak, S., Okoth, B., Ergun, M., and Karamasa, C. 2017. "Analyzing Mobile Banking Quality Factors under Neutrosophic Set Perspective: A Case Study of Turkey," *Journal of Economics Finance and Accounting* (4:4), pp. 354-367.
- Amin, H., Baba, R., and Muhammad, M. Z. 2007. "An Analysis of Mobile Banking Acceptance by Malaysian Customers," *Sunway academic journal* (4), pp. 1-12.
- BanksAssociationTurkey. 2017. "Digital, Internet and Mobile Banking Statistics").
- Beiginia, A. R., Besheli, A. S., Soluklu, M. E., and Ahmadi, M. 2011. "Assessing the Mobile Banking Adoption Based on the Decomposed Theory of Planned Behaviour," *European Journal of Economics, Finance and Administrative Sciences* (28:1), pp. 7-15.

- Bidar, R., Fard, M. B., Salman, Y. B., Tunga, M. A., and Cheng, H. 2014. "Factors Affecting the Adoption of Mobile Banking: Sample of Turkey," *16th International Conference on Advanced Communication Technology*, pp. 1278-1282.
- Chong, A. Y.-L., Chan, F. T., and Ooi, K.-B. 2012. "Predicting Consumer Decisions to Adopt Mobile Commerce: Cross Country Empirical Examination between China and Malaysia," *Decision Support Systems* (53:1), pp. 34-43.
- Constantiou, I. D., Damsgaard, J., and Knutsen, L. 2007. "The Four Incremental Steps toward Advanced Mobile Service Adoption," *Communications of the ACM* (50:6), pp. 51-55.
- Dai, H., and Palvi, P. C. 2009. "Mobile Commerce Adoption in China and the United States: A Cross-Cultural Study," *ACM SIGMIS Database: the DATABASE for Advances in Information Systems* (40:4), pp. 43-61.
- Davis, F. D. 1989. "Perceived Usefulness, Perceived Ease of Use, and User Acceptance of Information Technology," *MIS quarterly*, pp. 319-340.
- Donner, J., and Tellez, C. A. 2008. "Mobile Banking and Economic Development: Linking Adoption, Impact, and Use," *Asian journal of communication* (18:4), pp. 318-332.
- Fishbein, M., and Ajzen, I. 1975. *Belief, Attitude, Intention and Behavior: An Introduction to Theory and Research*.
- Gu, J.-C., Lee, S.-C., and Suh, Y.-H. 2009. "Determinants of Behavioral Intention to Mobile Banking," *Expert Systems with Applications* (36:9), pp. 11605-11616.
- Hair, J. F., Black, W. C., Babin, B. J., and Anderson, R. E. 2010. *Multivariate Data Analysis*, (7th ed. ed.). Upper Saddle River, NJ: Prentice Hall.
- Hanafizadeh, P., Behboudi, M., Koshksaray, A. A., and Tabar, M. J. S. 2014. "Mobile-Banking Adoption by Iranian Bank Clients," *Telematics and Informatics* (31:1), pp. 62-78.
- Ho Cheong, J., and Park, M.-C. 2005. "Mobile Internet Acceptance in Korea," *Internet research* (15:2), pp. 125-140.
- Katz, E., Blumler, J. G., and Gurevitch, M. 1973. "Uses and Gratifications Research," *The public opinion quarterly* (37:4), pp. 509-523.
- Kazi, A. K., and Mannan, M. A. 2016. "Factors Affecting Adoption of Mobile Banking in Pakistan: Empirical Evidence," *International Journal of Research in Business and Social Science* (2147-4478) (2:3), pp. 54-61.
- Keramati, A., and Nili, A. 2011. "A Proposal Framework for Investigating the Impact of Customer Relationship Management on Customer Retention in E-Commerce," *human resources* (6:9), p. 26.
- King, W. R., and He, J. 2006. "A Meta-Analysis of the Technology Acceptance Model," *Information & management* (43:6), pp. 740-755.
- Kohler, T., Fueller, J., Matzler, K., and Stieger, D. 2011. "Co-Creation in Virtual Worlds: The Design of the User Experience," *MIS Quarterly* (35:3), p. 773.
- Lampe, C., Wash, R., Velasquez, A., and Ozkaya, E. 2010. "Motivations to Participate in Online Communities," *Proceedings of the SIGCHI conference on Human factors in computing systems*: ACM, pp. 1927-1936.
- Lee, J., Lee, M., and Choi, I. H. 2012. "Social Network Games Uncovered: Motivations and Their Attitudinal and Behavioral Outcomes," *Cyberpsychology, Behavior, and Social Networking* (15:12), pp. 643-648.
- Lim, W. M. 2018. "Dialectic Antidotes to Critics of the Technology Acceptance Model: Conceptual, Methodological, and Replication Treatments for Behavioural Modelling in Technology-Mediated Environments," *Australasian Journal of Information Systems* (22).
- Lin, H.-F. 2011. "An Empirical Investigation of Mobile Banking Adoption: The Effect of Innovation Attributes and Knowledge-Based Trust," *International journal of information management* (31:3), pp. 252-260.
- Liu, Z., Min, Q., and Ji, S. 2009. "An Empirical Study on Mobile Banking Adoption: The Role of Trust," *Electronic Commerce and Security, 2009. ISECS'09. Second International Symposium on: IEEE*, pp. 7-13.
- Luarn, P., and Lin, H.-H. 2005. "Toward an Understanding of the Behavioral Intention to Use Mobile Banking," *Computers in human behavior* (21:6), pp. 873-891.
- Mao, E., Srite, M., Bennett Thatcher, J., and Yaprak, O. 2005. "A Research Model for Mobile Phone Service Behaviors: Empirical Validation in the Us and Turkey," *Journal of Global Information Technology Management* (8:4), pp. 7-28.
- Min, Q., Ji, S., and Qu, G. 2008. "Mobile Commerce User Acceptance Study in China: A Revised Utaut Model," *Tsinghua Science and Technology* (13:3), pp. 257-264.
- Mohammadi, H. 2015. "A Study of Mobile Banking Loyalty in Iran," *Computers in Human Behavior* (44), pp. 35-47.



- Mutahar, A. M., Daud, N. M., Thurasamy, R., Isaac, O., and Abdulsalam, R. 2018. "The Mediating of Perceived Usefulness and Perceived Ease of Use: The Case of Mobile Banking in Yemen," *International Journal of Technology Diffusion (IJTD)* (9:2), pp. 21-40.
- Nahang, F., and Araghi, K. 2013. "Internal Factors Affecting the Profitability of City Banks," *International Research Journal of Applied and Basic Sciences* (5:12), pp. 1491-1500.
- Nambisan, S., and Baron, R. A. 2009. "Virtual Customer Environments: Testing a Model of Voluntary Participation in Value Co-Creation Activities," *Journal of product innovation management* (26:4), pp. 388-406.
- Nili, A., and Keramati, A. 2012. "Customer Retention Programs of Crm and Customer Retention in E-Banking," *International Journal of E-Entrepreneurship and Innovation (IJEI)* (3:1), pp. 18-32.
- Onay, C., and Öztaş, Y. E. 2018. "Why Banks Adopt Mobile Banking? The Case of Turkey," *International Journal of Electronic Finance* (9:2), pp. 95-120.
- Riquelme, H. E., and Rios, R. E. 2010. "The Moderating Effect of Gender in the Adoption of Mobile Banking," *International Journal of bank marketing* (28:5), pp. 328-341.
- Rogers, E. M. 1995. "Lessons for Guidelines from the Diffusion of Innovations," *Joint Commission Journal on Quality and Patient Safety* (21:7), pp. 324-328.
- Sangwan, S. 2005. "Virtual Community Success: A Uses and Gratifications Perspective," *System Sciences, 2005. HICSS'05. Proceedings of the 38th Annual Hawaii International Conference on: Ieee*, pp. 193c-193c.
- Schierz, P. G., Schilke, O., and Wirtz, B. W. 2010. "Understanding Consumer Acceptance of Mobile Payment Services: An Empirical Analysis.," *Electronic commerce research and applications*, (9:3), pp. 209-216.
- Shaikh, A. A., and Karjaluto, H. 2015. "Mobile Banking Adoption: A Literature Review," *Telematics and Informatics* (32:1), pp. 129-142.
- Sheng, M., Wang, L., and Yu, Y. 2011. "An Empirical Model of Individual Mobile Banking Acceptance in China," *Computational and Information Sciences (ICCIS), 2011 International Conference on: IEEE*, pp. 434-437.
- Singh, S., and Srivastava, R. 2018. "Predicting the Intention to Use Mobile Banking in India," *International Journal of Bank Marketing* (36:2), pp. 357-378.
- Sohail, M. S., and Al-Jabri, I. M. 2014. "Attitudes Towards Mobile Banking: Are There Any Differences between Users and Non-Users?," *Behaviour & Information Technology* (33:4), pp. 335-344.
- Son, H., Park, Y., Kim, C., and Chou, J.-S. 2012. "Toward an Understanding of Construction Professionals' Acceptance of Mobile Computing Devices in South Korea: An Extension of the Technology Acceptance Model," *Automation in construction* (28), pp. 82-90.
- Taylor, S., and Todd, P. A. 1995. "Understanding Information Technology Usage: A Test of Competing Models," *Information systems research* (6:2), pp. 144-176.
- Van der Heijden, H. 2004. "User Acceptance of Hedonic Information Systems," *MIS quarterly*, pp. 695-704.
- Venkatesh, V., Morris, M. G., Davis, G. B., and Davis, F. D. 2003. "User Acceptance of Information Technology: Toward a Unified View," *MIS quarterly*, pp. 425-478.
- Wang, C. C., Lo, S. K., and Fang, W. 2008. "Extending the Technology Acceptance Model to Mobile Telecommunication Innovation: The Existence of Network Externalities," *Journal of Consumer Behaviour: An International Research Review* (7:2), pp. 101-110.
- Yang, A. S. 2009. "Exploring Adoption Difficulties in Mobile Banking Services," *Canadian Journal of Administrative Sciences/Revue Canadienne des Sciences de l'Administration* (26:2), pp. 136-149.
- Zhang, H., Lu, Y., Wang, B., and Wu, S. 2015. "The Impacts of Technological Environments and Co-Creation Experiences on Customer Participation," *Information & Management* (52:4), pp. 468-482.
- Zhou, T. 2012. "Understanding Users' Initial Trust in Mobile Banking: An Elaboration Likelihood Perspective," *Computers in Human Behavior* (28:4), pp. 1518-1525.
- Zhou, T., Lu, Y., and Wang, B. 2010. "Integrating Ttf and Utaut to Explain Mobile Banking User Adoption," *Computers in human behavior* (26:4), pp. 760-767.

# The Impact of Ineffective ITG on IT Deployment: A Study of Failed IT Deployment Initiatives

## Mehdi Asgarkhani

Department of Computing  
Ara Institute of Canterbury  
Christchurch, New Zealand  
Email: Mehdi.Asgarkhani@ara.ac.nz

## Mark Toleman

School of Management and Enterprise  
University of Southern Queensland (USQ)  
Toowoomba, Australia  
Email: [Mark.Toleman@usq.edu.au](mailto:Mark.Toleman@usq.edu.au)

## Mustafa Ally

School of Management and Enterprise  
University of Southern Queensland (USQ)  
Springfield, Australia  
Email: [Mustafa.Ally@usq.edu.au](mailto:Mustafa.Ally@usq.edu.au)

## Michael Lane

School of Management and Enterprise  
University of Southern Queensland (USQ)  
Toowoomba, Australia  
Email: [Michael.Lane@usq.edu.au](mailto:Michael.Lane@usq.edu.au)

## Abstract

Organisations continue to make significant investments in Information Technology (IT) to enable business. To ensure a return on investment in IT, there is a need for a wider accountability focus on strategic technology initiatives alongside a structured and evaluative approach to the effective governance of IT. Throughout the last decade, systems, processes, standards and best practice frameworks have been developed to facilitate effective IT governance. However, IT deployment initiatives seem to continue to fail to deliver outcomes. This paper examines the impact of ineffective IT governance (ITG) on IT deployment failure in a set of failed IT projects. First, a literature review establishes the influencers (and indicators) of effective ITG. Next, a multiple case study analysis of failed IT deployment initiatives identifies key contributors to deployment failure. Finally, the outcome of the case study analysis is mapped back to the indicators of effective ITG derived from the literature review to determine a possible connection between failed IT deployment and ineffective IT governance. The outcome of the analysis demonstrates a connection between project failures and lack of effective ITG.

**Keywords:** Information Technology (IT) Governance (ITG), Effectiveness of ITG, Evaluating ITG Effectiveness, Model of ITG Effectiveness, IT Project Failure, IT Deployment Case Studies.

## 1 Introduction

Today, Information Technology (IT) solutions play a significant role in enabling businesses. Organisations commit considerable funds to both capital and operational expenses to deploy and operate IT solutions (Lovelock et al., 2016; McLellan, 2014). Deploying technology is often associated with significant organisational change. The change can be associated with significant risks (Davis et al., 1997; EDUCAUSE centre for applied research, 2008; Gauld and Goldfinch, 2006; Laudon and Laudon, 2014).

Despite significant technology advancements and increased awareness of technology management, there are IT deployment cases where organisational outcomes are not materialised (Gole and Shinsky, 2013). For instance, some of the recent case studies of challenged IT deployment initiatives (where deployment of technology failed to deliver the expected outcomes) include the Queensland Health project (Chesterman, 2013), the WINZ NZ kiosk security failure (Deloitte, 2012; Data, 2011) and the NOVOPAY project (NZ Government, 2013).

Increased investment in IT has meant that there is an expectation by organisations that they not only maximise the benefits of adopting IT but also avoid the drawbacks and risks that are often associated with the rapid introduction of technological change (Asgarkhani, 2013; Van Grembergen, 2004). IT practitioners and managers, as well as IT strategists and planners, have continuously developed and put into practice improved IT deployment decision-making processes. Throughout this paper, the term 'practitioner' applies to those who take a deployed system (solution) view when they examine effectiveness. 'Strategists' are those who examine the future direction of an organisation concerning IT deployment and the role and impact of IT Governance (ITG) in securing value from future IT deployments.

Previous studies have shown that IT is expected to add value to the organisation through improved productivity, increased efficiency and profitability, better communication, more effective decision making and higher customer satisfaction (Larcker and Tayan, 2008a). Moreover, studies show that to maximise benefits and value gained from investment in IT, it is universally acknowledged that IT must be fully aligned with overall business strategies and direction (Asgarkhani, 2013; Van Grembergen, 2004). Considerable organisational resources are consumed to manage how IT is acquired and diffused in organisations (Weill and Ross, 2004b; Wu et al., 2015). ITG consists of leadership, organisational structures, and processes which ensure that the enterprise's IT sustains and extends the organisation's strategies and objectives (ITGI, 2007). ITG frameworks and standards were introduced to organisations in the 1990s (Brown and Magill, 1994; Cater-Steel et al., 2006; De Haes and Van Grembergen, 2006; Van Grembergen and De Haes, 2009; Fukuyama, 2013).

The literature on ITG provides advice and recommendations on models and frameworks for ITG implementation (De Haes and Van Grembergen, 2010; Van Grembergen and De Haes, 2009; Weill and Ross, 2004b; Weill and Vitale, 2002; Williams, 2012). The literature outlined in the paper suggests that previous studies on ITG tend to assume that recommended models and practices lead to effective governance, although we could find no empirical evidence to support this assumption. More specifically, despite the number of prescriptive models and 'best practice frameworks' available, and increased uptake of ITG in organisations, achieving effective ITG outcomes is consistently ranked as one of the top concerns of management (Gartner, 2016).

The research problem that motivated this study can be described as determining why, despite the availability of numerous recommended 'best practice frameworks' and models of effective ITG, a significant number of IT deployment projects fail to deliver value.

Two broad research questions motivated this study:

- What influences and indicates the effectiveness of ITG practices?
- What contributes to the failure of IT deployment projects?
- Is there a connection between ineffective ITG and failed IT deployment initiatives?

The paper presents the results of the literature review aimed at determining the influencers (and indicators) of ITG effectiveness - forming a broad conceptual model for ITG effectiveness. Next, six case studies of failed IT deployment projects were analysed to determine the causes of failure. The causes of failure were mapped to the influencers of ITG effectiveness (from the literature review also acting as

indicators of the existence of good ITG practice) to examine the connection between failed projects and the role of ITG.

The paper begins with the literature review presenting the analysis of previous studies with a focus on determining influencers of ITG effectiveness. The literature review is followed by the methodology for the study and the selection of case studies for analysis. The methodology section is followed by the analysis of the case studies and discussion of outcomes. Finally, the conclusion provides a summary of the study and discusses the contribution, limitations and future planned research.

## 2 Literature Review

The purpose of the literature review is to identify (based on previous research) factors that influence and indicate effective ITG. The literature review guided the development of a model of factors that are likely to influence (and also demonstrate) effective ITG (Bem, 1995; Baumeister and Leary, 1997; Moher et al., 2009; Okoli, 2015; Bakker, 2010). The first step of the literature review involved the selection of eligible articles. The preliminary search for resources included journals, and quality assured conference proceedings repositories (such as Science Direct, Springer Link, IEEE Xplore Digital Library, Emerald, Taylor & Francis), books, reports by IT sector professional bodies (for instance Institute of IT Professionals NZ, Australian Computer Society, and British Computer Society), government-commissioned reports, google scholar, and universities' investigative reports.

Key phrases used for the initial search included Information Technology Governance, IT Governance, IT solutions deployment, IT deployment success, IT Deployment failure, IT Governance effectiveness, IT Governance practices, IT Governance Standards/Models, IT Governance Success Factors, IT Governance Mechanisms, IT solutions success/failure, IT Governance theory, IT development, IT platforms changes, Technology changes, and Technology solutions. A logical OR was adopted to search using the phrases above. More specifically, articles that referred to any of the phrases listed were considered in the initial search.

The initial search of qualifying publications and articles resulted in 189 articles although on further analysis some abstracts, titles, and conclusions did not provide a clear understanding of the purpose of the articles. Therefore, a more detailed analysis of the articles was necessary. The introduction, background, and methodology sections were examined. The examination of titles, abstracts, conclusions, introduction, and the methodology sections identified similar or duplicated results that were excluded. After the completion of the screening process, the number of eligible articles was reduced to 71.

In general, the analysis of the literature suggested that the theoretical foundations of Agency Theory (Bonazzi and Islam, 2007; McColgan, 2001), with a strong focus on control, predominantly underpin the current ITG practices. Moreover, effective ITG practices are more likely to secure value delivery of IT deployment (DeLone & McLean, 1992; Weill & Vitale, 2002; Van Grembergen, 2004; Weill & Ross, 2004; De Haes & Van Grembergen, 2010). The literature showed that previous researchers agree in general that effective ITG leads to successful deployment of IT. However, there are two different approaches to substantiating effective ITG (DeLone & McLean, 1992; DeLone & McLean, 2003; Van Grembergen, 2004).

The first group of researchers (Delone & McLean, 2003; Esteves & Joseph, 2008; Halonen, Acton, Golden, & Conboy, 2009) argued that successfully deployed information systems and applications could indicate effective strategic management of technology deployment. They focussed on operational and tactical issues and recommended models to measure the success of information systems to reflect effective ITG.

The second group (Van Grembergen and De Haes, 2009; Van Grembergen, 2004; Weill and Ross, 2004b) argued that factors that can be examined to assess ITG effectiveness are related to strategic approaches, relational mechanisms, and use of standards and frameworks that are expected to lead to ITG effectiveness. They examined and recommended strategic factors that could influence the effectiveness of ITG.

Next, to determine the indicators of effective ITG (taking into account both views above), a concept-centric qualitative analysis (Webster and Watson, 2002) of eligible articles was performed. The analysis determined that previous research outlines various factors that could indicate (and influence) effective ITG, for instance, the existence of an IT steering committee or evidence of monitoring and the assessing of value returned from decisions made on deploying IT.

The set of factors identified seemed to relate to various broader themes of influencers and indicators of effective ITG. Therefore, with reference to broader views expressed by both strategists (Van Grembergen and De Haes, 2009; Van Grembergen, 2004; Weill and Ross, 2004a) and practitioners (DeLone and McLean, 1992; Delone and McLean, 2003; Van Grembergen, 2004) the set of identified influencers were further analysed, and related influencers were placed in broader categories. The grouping identified eight key groups of influencers including *Decision-Making Structure, Formalised systems and processes, Effective communication, Business outcome orientated IT, Alignment of organisational quality-orientated strategies with strategies for the use of IT solutions, the history and the current state of IT deployment, Awareness of organisations financial performance supported by IT solutions, and Operational excellence influenced by the deployment of IT.*

Moreover, further examination of both strategists' and practitioners' views (De Haes and Van Grembergen, 2010; Van Grembergen, 2004; Weill and Vitale, 2002; Weill and Ross, 2004b; Delone and McLean, 2003; DeLone and McLean, 1992), determined three broad strategic themes that could highlight and indicate ITG effectiveness: *ITG Maturity, Alignment of IT and Business, and Organisational Performance influenced by IT deployment.*

Table 1 summarises the outcome of the literature review as a model of influencers and indicators of effective ITG.

**Table 1. Themes of the indicators and influencers of ITG effectiveness**

<b>Themes</b>	<b>Indicators</b>	<b>References</b>
<b>Strategic Theme 1 - ITG Maturity:</b> The experience and rigour in implementing ITG best practice		
Decision-making Support Structure	IT steering committee Strategic information systems planning steering committee Reporting structure (IT directors to CEO) Monitoring and the assessing of value returned from decisions made on deploying IT	(De Haes and Van Grembergen, 2010; Van Grembergen, 2004; Weill and Vitale, 2002; Weill and Ross, 2004b; Delone and McLean, 2003; DeLone and McLean, 1992)
Formalised ITG systems and process	ITG standards and framework Business and IT partnership in decision making Formalised portfolio management Formalised information strategy planning A formal process for strategic information systems planning Formalised IT deployment project governance.	
Effective communication of strategic issues	IT director or CIO involved in executive decision-making and represented on the executive committees. IT strategy committee (or similar) tasked with reporting and discussing IT issues. There is a CIO or a similar role to raise awareness and articulate a vision for IT's role.	
<b>Strategic Theme 2 - Strategic Alignment of IT and Business:</b> The connection and coherence between fulfilling business strategy and the IT strategy.		
Business outcome-orientated alignment of IT and Business	IT strategies recognise and support new business outputs (products and services) Technology support for business outcome diversification strategies Technology and service support for business outcome differentiation.	(De Haes and Van Grembergen, 2010; Van Grembergen, 2004; Van Grembergen and De Haes, 2009; Weill, 2004; Kaplan and Norton, 2004; Kaplan, 2010; Prasad et al., 2008; Myers, 2012; Ramgovind et al., 2015)
Alignment of organisational quality-orientated strategies with strategies for the use of IT solutions.	Adoption of IT Solutions supports business outcome (products and services quality) including production and marketing.	

Themes	Indicators	References
<b>Strategic Theme 3 - Organisational Performance influenced by technology deployment:</b> Organization's overall performance and delivery of outcomes supported by IT relative to its competition		
The history and the current state of IT deployment within an organisation	The current level of process automation via IT User acceptance of technology solutions Support mechanisms for IT solutions Timely delivery of relevant information for effective decision making Effective service management of IT solutions	(DeLone and McLean, 1992; Delone and McLean, 2003; Esteves and Joseph, 2008; Halonen et al., 2009; Zaied, 2012; Hellsten and Karkove, 2006)
Awareness of organisations financial performance supported by IT solutions	Processes for monitoring an organisation's performance Metrics such as return on investment used to assess value delivery of IT	
Operational excellence influenced by the deployment of IT	The existence of processes and metrics for operational performance Seeking ongoing productivity improvements via the deployment of technology solutions Service level agreements and timeline for service delivery	

The term *indicator* is used alongside indicators in the literature review consistently. An influencer is referring to the factors that previous research highlights that influence good practice ITG. The existence (or lack of it) of the same factors is seen as the evidence of good practice (or lack of it) in case studies.

### 3 Research Methodology

Multiple case studies were analysed to identify the possible connection between IT deployment failure and ineffective ITG. Case study analysis has been recommended as a suitable methodology for qualitative studies where contextual analysis adds value to the study (Baxter and Jack, 2008; Stake, 2006; Ritchie and Lewis, 2003; Yin, 2011). Sources for the selection of the case studies included MIS Quarterly, Gartner Research ([www.gartner.com](http://www.gartner.com)), publications by the British Computer Society, Australian Computer Society, Institute of IT Professionals NZ, New Zealand and Australian Government (IT projects publications), and the CIOIndex ([www.cioindex.com](http://www.cioindex.com)). The selection criteria included: *The complexity of the project* (the impact of the project on both major strategic and operational functions), *The cost of the project* (at least AUD \$20M), *Geographic location* (projects from various English speaking countries including New Zealand, Australia, Europe, and North America), *Timeframe* (no older than 10 years), and *Availability of sufficient information for analysis*.

Failure: Failed projects identified as deployment initiatives missing targets (timelines, cost, and functionality) by approximately 20% or more. All projects included application development or deployment. Most projects required some technology platform or infrastructure changes.

Six case studies were selected for analysis. They included: New Zealand's NovoPay (NZ Government Internal Affairs, 2014), Victoria's (Australia) HealthSMART (Brouwer, 2011), UK's IT in NHS (Campion-Awwad et al., 2014), Canada's Phoenix project (Barnhart et al., 2013), HP's ERP Implementation (Chaluverdi and Gupta, 2005) and JetSmart Qantas (Krigsman, 2008).

An *emergent coding* approach (no pre-set codes defined) was employed to analyse the selected case studies of IT deployment failure (Fereday and Muir-Cochrane, 2016; Swain, 2018). Events and developments that contributed to the outcome of the project were extracted and added as excerpts into Dedoose (a web-based qualitative analysis tool). The excerpts were further analysed and coded into factors that contributed to the failure of projects.

## 4 Analysis of Case Studies

The literature review determined three main groups of factors that both influence and indicate effective ITG. The analysis of failed IT deployment initiatives is intended as determining a possible link between failed IT deployments and lack of effective ITG. The analysis of the factors that contributed to the failure of IT deployment was done independently of the literature review outcomes (Cenfetelli, 2004).

A concept-centric qualitative analysis of the excerpts from all cases resulted in identifying 26 contributors to IT deployment failure: *implementation difficulties, lack of sufficient training or IT skills, inadequate test planning and testing, lack of sufficient resource, data migration failure, slow adoption of technology, lack of executive oversight, confused roles accountability, lack of stakeholder involvement, poor user understanding of technology, poor design (functionality & usability), poor day to day project management, conflicting or dysfunctional leadership, poor risk and contingency planning, lack of business case, unrealistic goals and expectations, poor scope definition (scope creep), lack of risk assessment, poor relationship management of parties involved, unprofessional, poor processes and practices, ineffective communication, lack of flexibility of models or frameworks applied, unrealistic and unnecessary pressure on project teams, lack of role clarity, complexity of design and functionality, and inadequate change management.*

Further analysis of the 26 identified contributors showed that they could be related to broad phases or events throughout the process. For instance, the *lack of adequate testing or poor data migration* relates to the phase when technology is implemented. Similarly, *lack of stakeholder involvement, poor design, lack of a business case, unrealistic goals, inadequate scope management, and poor communication*, is connected with risk and change management (Delone and McLean, 2003; DeLone and McLean, 1992). Therefore, the 26 identified contributors were placed into eight broader groups of contributors to failure – table 2.

The outcome of the analysis demonstrated two points. First, the contributors to the failure of IT deployment seemed to connect more directly to 'project management' issues rather than strategic ITG matters. However, considering the key domains of ITG, even operational project management problems can directly or indirectly be associated with lack of effectiveness in one of ITG domains. Moreover, establishing a connection between failed IT deployments, and ineffective ITG proved more complex than anticipated.

As outlined earlier, the analysis of the previous research and the study of cases of failed IT deployments were conducted independently. To ascertain a possible connection between failed IT deployment and ineffective ITG, there is a need to map the outcomes of the literature review (Table 1) and case study analysis (Table 2).

The approach undertaken involved the analysis of the contributors to IT deployment failure to determine if they could relate to *any* influencers and indicators of effective ITG. More specifically, the mapping involved determining if the identified contributor to failure could have been avoided by the existence of any effective ITG influencer/indicator (Cenfetelli, 2004). For instance, poor *Implementation Management* (as a theme contributing to failure – table 2) involves *poor testing, technical know-how, poor data migration, unnecessary pressure on people, and poor change management*. Table 1 was examined to determine if the lack of any influencers or indicators could connect to the causes of poor implementation management. It was observed that some of the indicators of the strategic theme 3 (Organizational Performance – table 1) could impact on contributors to poor implementation management. More specifically, *lack of support mechanisms for IT solutions, effective service management of IT solutions, processes for monitoring organisation's performance, the existence of processes and metrics for operational performance, and service level agreements and timeline for service delivery* influence contributors to failure identified as poor implementation management. Therefore, poor implementation management (based on the sample of projects examined) is influenced by ineffective ITG as related to strategic theme 3 (Organizational Performance).

**Table 2. Themes of contributory factors to IT deployment failure**

<p align="center"><b>Identified themes</b> (8 broad areas of failure – six case studies)</p>	<p align="center"><b>Sub-themes – Contributing Factors</b> (26 initial factors)</p>
<p>Implementation management</p> <p><i>Sample extracts</i> The IT personnel were subjected to the new technology without having adequate time to develop their skills for the new system <b>HP's ERP</b></p>	<p>Testing, technical know-how, data migration, unnecessary pressure on people, lack of training, and change management</p>
<p>Resources management (including people)</p> <p><i>Sample extracts</i> The IT personnel were subjected to the new technology without having adequate time to develop their skills for the new system <b>HP's ERP</b></p> <p>By June 2013, Lorenzo had been delivered on ten sites (out of a contracted 166), of which seven were running them off the shelf 1.0 version as an interim solution. Three other sites were running the desired 1.9 version but not with satisfactory functionality <b>UK's IT in NHS</b></p>	<p>Lack of training, limited skills, unnecessary pressure, and slow adoption of technology</p>
<p>Accountability and clarity of roles</p> <p><i>Sample extracts</i> There was significant turnover in key project positions</p> <p>Until late in the project, there was no programme director with accountability across the whole project <b>NovaPay</b></p>	<p>Lack of broader governance and executive oversight, confused accountability, relationship management, and role clarity</p>
<p>IT-Business alignment</p> <p><i>Sample extracts</i> The relationship between the Ministry and Talent2 was not sufficiently constructive to manage the underlying risks <b>NovaPay</b></p>	<p>Slow adoption of technology, lack of executive oversight, confused accountability, dysfunctional leadership, stakeholder engagement, risk management, unprofessional practices, and lack of flexibility, unnecessary pressure</p>
<p>Information Technology Leadership</p> <p><i>Sample extracts</i> The IT personnel were subjected to the new technology without having adequate time to develop their skills for the new system <b>HP's ERP</b></p> <p>"As long as people enter [information] wrong, it will be wrong. It could be wrong ten years from now. To do it over again, I would have made training absolutely mandatory" - Rosanna Di Paola (associate assistant deputy minister responsible for the federal)" <b>Phoenix</b></p>	<p>Lack of understanding of the use of IT, lack of IT skills, insufficient IT resources, slow adoption of technology, poor planning, lack of a business case, lack of flexibility in approaches to use of IT, lack of role clarity, poor change management</p>
<p>Design and functionality</p> <p><i>Sample extracts</i> Problems surfaced between the legacy system and the new SAP system being implemented, as soon as the implementation went live <b>HP's ERP</b></p>	<p>Data migration, lack of stakeholder involvement, poor understanding of technology, poor understanding of functionality, unrealistic expectations, scope creep, poor communication, and complexity</p>
<p>Risk and change management</p> <p><i>Sample extracts</i> A senior official responsible for rolling out the federal government's Phoenix payroll system told a labour tribunal on Wednesday the issues that led to pay problems for some 80,000 employees are due to a lack of training, not the software itself." - CBC News</p> <p>"As long as people enter [information] wrong, it will be wrong. It could be wrong ten years from now. To do it over again, I would have made</p>	<p>Inadequate testing, lack of stakeholder involvement, poor design, lack of a business case, unrealistic goals, inadequate scope management, poor communication, and complexity</p>



<b>Identified themes</b> (8 broad areas of failure – six case studies)	<b>Sub-themes – Contributing Factors</b> (26 initial factors)
<i>training absolutely mandatory" - Rosanna Di Paola (associate assistant deputy minister responsible for the federal)"</i> <b>Phoenix</b>	
Use of standardised processes and practices  <i>Sample extracts</i> <i>The IT personnel were subjected to the new technology without having adequate time to develop their skills for the new system</i> <b>HP's ERP</b>  <i>Failure to cleanse data before migration to the new system</i> <b>Phoenix</b>	Inadequate test planning, data migration challenges, lack of governance processes, unprofessional practices (testing, communication), lack of flexible processes, poor change management processes

Similarly, lack of *Accountability and Clarity of Roles* (table 2) involves a *lack of broader governance and executive oversight, confused accountability, relationship management, and role clarity*. Once again, table 1 was examined to establish a connection between any effective ITG influencer and the identified contributor to failure (accountability and clarity or roles). It was noticed that some of the indicators of the strategic theme 1 (Organizational Maturity – table 1) could impact on contributors to lack of accountability and clarity of roles. In other words, the absence of *process standards and frameworks, business and IT partnership in decision making (defining roles), a formalised portfolio management (roles), a formalised IT deployment project governance, IT strategy committee (or similar) tasked with reporting and discussing IT issues, and a CIO or a similar role to raise awareness and articulate a vision for IT and decision making roles* are likely to influence contributors to failure related to lack of role clarity and accountability.

Table 3 outlines the outcome of mapping all contributors to failure from table 2 to influencers of ITG effectiveness. More specifically, the table outlines the lack of which broader themes of influencers could have been associated with the eight themes of contributors to failure. Table 3 suggests that the contributors to as determined by the study of six IT deployment initiatives show a connection with poor ITG.

**Table 3 Mapping of the eight areas of contributors to factors to the absence of effective ITG influencers**

<b>Identified themes</b> (8 broad areas of failure – six case studies – table 2)	<b>Reference the broad themes of indicators of effective ITG</b> (Table 1 – literature review)
Implementation management	ITG – organisational performance
Resources management (including people)	ITG – organisational performance
Accountability and clarity of roles	ITG – organisational maturity
	ITG – IT and Business Alignment
IT-Business alignment	ITG – IT and Business alignment
	ITG – organisational maturity
Information Technology Leadership	ITG – organisational maturity
	ITG – organisational performance
Design and functionality	ITG – organisational maturity
Risk and change management	ITG – organisational performance
	ITG – organisational maturity
	ITG – IT and business alignment
Use of standardised processes and practices	ITG – organisational performance
Use of standardised processes and practices	ITG – organisational maturity
	ITG – organisational performance

Next, individual projects (cases) were examined to determine the extent of the presence of contributors to failure – as outlined in table 4.

Table 4 demonstrates that Novo Pay and IT in NHS exhibited all eight areas of failure and therefore showing a connection to all three themes of ITG effectiveness. More specifically, lack of organisational maturity, poor IT and business alignment, and fragile organisational performance could have contributed to the failure of the two specific projects. Four areas of failure were present in all four cases: implementation management, IT-business alignment, risk and change management, and the use of standardised processes and practices. Four projects did not connect to all areas of failure.

In summary, overall, Table 4 suggests that the IT deployment failure in cases studies that were analysed seem to be associated with lack of the three themes of practices that influence effective ITG.

**Table 4. Summary of Case Study Analysis Change the title**

<b>Identified themes (Areas of Failure)</b>	<b>NovoPay</b>	<b>JetSmart Project (Qantas)</b>	<b>ERP at HP</b>	<b>HealthSMART</b>	<b>IT in NHS</b>	<b>Phoenix</b>
Implementation Management	√	√	√	√	√	√
Resources Management	√	-	√	-	√	√
Accountability and clarity of roles	√	√	-	√	√	-
IT-Business alignment	√	√	√	√	√	√
Information Technology Leadership	√	√	-	-	√	√
Design and functionality	√	√	√	-	√	√
Risk and change management	√	√	√	√	√	√
Use of standardised processes and practices	√	√	√	√	√	√

## 5 Conclusions

The study outlined in this paper has a focus on determining the connection between IT deployment failure and poor ITG practices. The study was conducted in two phases.

A broad analysis of the literature on ITG effectiveness suggested that despite previous studies on ITG (recommending options and approaches for improved deployment of IT), there is a lack of research on ITG effectiveness. There seems to be fragmentation in studies on ITG effectiveness with a focus on relevant but isolated issues (mechanisms, relationships, and system performance). The review highlights a need for integrated studies of ITG effectiveness. The analysis of the selected publications also indicated that there is a consensus among both practitioners and strategists that effective ITG is more likely to secure value from IT deployment. Further and a more focused analysis of the selected 71 articles determined that there are two schools of thought concerning the effectiveness of ITG. Information Systems (IS) academics and practitioners argued that successfully deployed information systems and applications could indicate effective strategic management of technology deployment. They focus on operational and tactical matters and recommend models for measuring the success of information systems to reflect effective ITG. On the other hand, strategists suggest that effectiveness of ITG can be assessed via strategic approaches, relational mechanisms, and the use of standards and frameworks. The analysis of literature identified 27 influencers (and indicators) of ITG effectiveness grouped into three strategic views of effectiveness: ITG maturity, strategic alignment of IT and business, and organisational performance influenced by technology deployment.

The multiple case study analysis of six failed IT deployments was focused on firstly determining the contributors to failure and second connecting the contributors to the model of influencers and indicators of effective ITG (Table 1). The analysis of case studies determined eight main groups of factors that contributed towards the failure of IT deployment (table 2).

To answer the research question (How do poor ITG practices contribute to the failure of IT deployment initiatives?) the results of the case study analysis (table 2) were mapped to the model of influencers of ITG derived from the literature review (table 1). The mapping suggested that any of the eight areas of failure identified related to the ineffectiveness in at least one of the main strategic themes of influencers of effective ITG – as outlined in table 3. This study contributes to the theory of ITG by identifying the categories of influencers of ITG effectiveness – as outlined in Table 3. For practitioners, the results of the study present a guide (set of contributors to failure and influencers of ITG effectiveness) for assessing the likelihood of project success before a deployment project is launched.

For future research, there are advantages to extending the number of case studies that are studied. Despite in-depth analysis of every case study and consideration of criteria that ensured inclusion of projects from various regions involving various solutions, analysis of an extended set of projects including analysis of cases of successful deployment projects can strengthen the findings of the study. Moreover, for future research, interviews with ITG practitioners and strategists can provide a third method of analysis thus providing a stronger triangulation of results from three sources of data.

## 6 References

- Asgarkhani, M. Corporate ICT governance: A tool for ICT best practice. International Conference on Management, Leadership and Governance, 2013 Bangkok. ACL, 1-8.
- Bakker, R. M. 2010. Taking stock of temporary organisational forms: A systematic review and research agenda. *International Journal of Management Reviews*, 12(4).
- Barnhart, D., Sullivan, B., Hunter, R., Bruhn, J., Fowler, E., Hoag, L. M., Chappie, S., Henshaw, G., Kelm, B. E., Kennedy, T., Mook, M. & Vincent, K. 2013. Phoenix Program Status - 2013. AIAA SPACE 2013 Conference and Exposition, AIAA SPACE Forum, (AIAA 2013-5341).
- Baumeister, R. F. & Leary, M. R. 1997. Writing narrative literature reviews. *Review of General Psychology*, 1(3), pp 311-320.
- Baxter, P. & Jack, S. 2008. Qualitative case study methodology: study design and implementation for novice researchers,
- Bem, D. J. 1995. Writing a review article for *Psychological Bulletin*. *Psychological Bulletin*, 118(2), pp 172-177.
- Bonazzi, L. & Islam, S. M. N. 2007. Agency theory and corporate governance: A study of the effectiveness of board in their monitoring of the CEO. *Journal of Modelling in Management*, 2(1), pp 7-23.
- Brouwer, G. E. 2011. Own motion investigation into ICT-enabled projects, Office, V. O. (Victoria, Australia).
- Brown, C. & Magill, S. 1994. Alignment of the IS functions with the enterprise: Toward a model of antecedents. *Management Information Systems Quarterly*, 18(4), pp 371-404.
- Campion-Awwad, O., Hayton, A., L., S. & Vuaran, M. 2014. The National Programme for IT in the NHS: A Case History. MPhil, Cambridge.
- Cater-Steel, A., Toleman, M. & Tan, W. G. 2006. Transforming IT service management – the ITIL impact. ACIS 2008. Paper presented at the ACIS 2008. <http://aisel.aisnet.org/acis2006/81>.
- Cenfetelli, R.T. 2004. Inhibitors and Enablers as Dual Factor Concepts in Technology Usage, *Journal of the Association for Information Systems*, (5) 11–12, pp. 472–492.
- Chaluverdi, R. & Gupta, V. 2005. ERP Implementation Failure at HP. ICMR.
- Christian, H. 2010. Seven habits of effective IT governance. Available: [http://www.emeraldgroupublishing.com/learning/management\\_thinking/articles/pdf/hagen\\_it.pdf?PHPSESSID=g6u235aosbo0hc6vj5mvjf2f54](http://www.emeraldgroupublishing.com/learning/management_thinking/articles/pdf/hagen_it.pdf?PHPSESSID=g6u235aosbo0hc6vj5mvjf2f54) [Accessed 28 Feb 2016].
- Coglianesi, C., Healey, T. J., Keating, E. K. & Michael, M. L. 2004. The role of government in corporate governance, USA: Harvard University.
- Data, D. 2011. Ministry of social development - Kiosk review. Available: [https://www.computerworld.co.nz/article/489137/dimension\\_data\\_kiosk\\_report\\_released/](https://www.computerworld.co.nz/article/489137/dimension_data_kiosk_report_released/).
- Davis, J. H., Schoorman, D. & Donaldson, L. 1997. Toward a stewardship theory of management. *The Academy of Management Review*, 22(1), pp 20-47.
- De Haes, S. & Van Grembergen, W. Information Technology Governance Best Practices in Belgian Organisations. Proceedings of the 39th Annual Hawaii International Conference on System Sciences - Volume 08, 2006 Hawaii. 195.2.

- De Haes, S. & Van Grembergen, W. 2010. An exploratory study into IT governance implementations and its impact on business/IT alignment. *Information Systems Management*, 26(1), pp 123-137.
- Deloitte. 2012. Ministry of Social Development Independent Review of Information Systems Security. Available: <https://www.nbr.co.nz/sites/default/files/images/deloitte-phase-2-final-report.pdf>.
- DeLone, W. H. & McLean, E. R. 1992. Information systems success: The quest for the dependent variable. *Information Systems Research*, 3(1), pp 60-95.
- Delone, W. H. & McLean, E. R. 2003. The DeLone and McLean Model of Information Systems Success: A Ten-Year Update. *Journal of Management Information Systems*, 19(4), pp 9-30.
- EDUCAUSE centre for applied research. 2008. IT governance maturity and context. Available: <https://net.educause.edu/ir/library/pdf/erso805/rs/erso8053.pdf>.
- Esteves, J. & Joseph, R. C. 2008. A comprehensive framework for the assessment of e-government projects. *Government Information Quarterly*, 25(118-132).
- Fereday, I. & Muir-Cochrane, E. 2016. Demonstrating Rigor Using Thematic Analysis: A Hybrid Approach of Inductive and Deductive Coding and Theme Development. *International Journal of Qualitative Methods*, 5(1), pp 80-92.
- Fukuyama, F. 2013. What is Governance? . Available: <http://dx.doi.org/10.2139/ssrn.2226592>.
- Gauld, R. & Goldfinch, S. 2006. *Dangerous enthusiasms: E-government, computer failure and information system development.*, Dunedin, New Zealand: Otago University Press.
- Gole, T. & Shinsky, G. 2013. Learning from failed ICT projects, Tobin, G.
- Halonon, R., Acton, T., Golden, W. & Conboy, K. 2009a. Delone & McLean success model as a descriptive tool in evaluating a virtual learning environment. *International Conference on Organizational Learning, Knowledge and Capabilities (OLKC 2009)*. Amsterdam, the Netherlands.
- Hellsten, S.-M. & Karkove, M. 2006. The DeLone and McLean Model of Information Systems Success-Original and Updated Models. SIGCHI Conference.
- ITGI. 2007. COBIT 4.1. Illinois: ITGI.
- Kaplan, R. S. 2010. Conceptual foundations of the balanced scorecard. Available: <http://www.hbs.edu/faculty/Publication%20Files/10-074.pdf>.
- Kaplan, R. S. & Norton, D. P. 2004. Measuring the strategic readiness of intangible assets. *Harvard Business Review*, 82(2), pp 52-63.
- Krigsman, M. 2008. <h1 style="margin-top:0cm;margin-right:0cm;margin-bottom:7.5pt;margin-left:0cm;mso-line-height-alt:12.5pt;background:white"> Qantas Airways: a perfect storm for IT failure? Available: <http://www.zdnet.com/article/qantas-airways-a-perfect-storm-for-it-failure/>.
- Larcker, B. F. & Tayan, B. 2008a. Models of corporate governance: Who's the fairest of them all? *Harvard Business Review*, 33.
- Laudon, K. C. & Laudon, J. P. 2014. *Management Information Systems: Pearson Education Limited*.
- Lovelock, J. D., Hale, K., Lewis, B., Hahn, W. L., Dornan, M., Atwal, R., Graham, C. & Gupta, N. 2016. Forecast Alert: IT spending, worldwide, 2016 Update. Available: <http://www.gartner.com/document/3365822?ref=solrAll&refval=171692296&qid=045cfc67a2fce db47ea1cc373a450684> [Accessed 16 July 2016].
- McColgan, P. 2001. Agency theory and corporate governance: a review of the literature from a UK perspective. Available: <http://citeseerx.ist.psu.edu/viewdoc/download?doi=10.1.1.202.286&rep=rep1&type=pdf>.
- McLellan, C. 2014. IT budgeting in 2015: What the surveys tell us. Available: <http://www.zdnet.com/article/it-budgeting-in-2015-what-the-surveys-tell-us/> [Accessed 16 January 2016].
- Moher, D., Liberati, A., Tetzlaff, J. & Altman, D. G. 2009. Preferred Reporting Items for Systematic Reviews and Meta-Analyses: The PRISMA Statement. *PloS Med Journal*, 6(7).
- Myers, J. 2012. Strategic data management in the era of Big Data.
- NZ Government. 2013. Report of the ministerial inquiry into the NOVOPAY project, Government, N. Z. (Wellington, New Zealand).
- Okoli, C. 2015. A Guide to Conducting a Standalone Systematic Literature Review. *Communications of the Association for Information Systems*, 37(1), Article 43.
- Prasad, A., Green, P. & Heales, J. 2008. Towards a better understanding of information technology, (Brisbane).
- Prasad, A., Heales, J. & Green, P. 2010. A capabilities-based approach to obtaining a deeper understanding of information technology governance effectiveness: Evidence from IT steering committees. *International Journal of Accounting Information Systems*, 11(3), pp 214-232.
- Ramgovind, S., Eloff, M. & Smith, E. 2015. The management of cloud security in cloud computing. [uir.unisa.ac.za](http://uir.unisa.ac.za) [Online]. Available:

- <http://uir.unisa.ac.za/xmlui/bitstream/handle/10500/3883/ramgovind.pdf?sequence=1>  
[Accessed August 16].
- Ritchie, J. & Lewis, J. 2003. *Qualitative Research Practice: a Guide for Social Science Students and Researchers*, Thousand Oaks, California: SAGE Publications, Inc.
- SFIA Foundation. 2015. *Skills Framework for Information Age*. SFIA Foundation.
- Stake, R. 2006. *Multiple case study analysis*, London: The Guilford Press.
- Swain, J. 2018. A hybrid approach to thematic analysis in qualitative research: Using a practical example. *SAGE Research Methods Cases*. doi:10.4135/9781526435477
- Van Grembergen, W. 2004. *Strategies for information technology governance*: Idea Group Publisher.
- Van Grembergen, W. & De Haes, S. 2009. *Enterprise governance of information technology*: Springer.
- Webster, J. & Watson, R. T. 2002. Analyzing past to prepare for the future: Writing a literature review. *MIS Quarterly*, 26(2), pp 13-22.
- Weill, P. 2004. Don't just lead, govern: How top performing firms govern IT. *MIS Quarterly Executive*, 3(1), pp 1-14.
- Weill, P. & Ross, J. 2004a. IT governance on one page. Available: [https://papers.ssrn.com/sol3/papers.cfm?abstract\\_id=664612](https://papers.ssrn.com/sol3/papers.cfm?abstract_id=664612).
- Weill, P. & Ross, J. 2004b. *IT Governance: How Top Managers Manage IT Decision Rights for Superior Results*, Boston: Harvard Business School Press.
- Weill, P. & Vitale, M. 2002. What IT infrastructure capabilities are needed to implement E-business models? *MIS Quarterly Executive*, 1(1), pp 17-34.
- Williams, P. A. 2012. Optimising value creation from IT investments. Available: <http://www.isaca.org/Knowledge-Center/Research/Documents/Outsourcing.pdf> [Accessed September 26, 2015].
- Wu, S. P., Straub, D. W. & Liang, T. 2015. How information technology governance mechanisms and strategic alignment influence organizational performance: Insights from a matched survey of business and IT managers. *MIS Quarterly*, 39(2), pp 497-518.
- Yin, R. K. 2011. *Qualitative Research from Start to Finish*: The Guilford Press.
- Zaied, A. N. H. 2012. An integrated success model for evaluating information system in public sectors. *Journal of Emerging Trends in Computing and Information Sciences*, 3(6), pp.
- Zuber, G. (2008). *Qantas Engineering – transforming Maintenance, Repair and Operations with Project Marlin and Holocentric*. Retrieved from <https://www.holocentric.com/s/QE-Short.pdf>

# Threat or Opportunity? - Examining Social Bots in Social Media Crisis Communication

## **Florian Brachten**

University of Duisburg-Essen  
Duisburg, Germany  
Email: florian.brachten@uni-due.de

## **Milad Mirbabaie**

University of Duisburg-Essen  
Duisburg, Germany  
Email: milad.mirbabaie@uni-due.de

## **Stefan Stieglitz**

University of Duisburg-Essen  
Duisburg, Germany  
Email: stefan.stieglitz@uni-due.de

## **Olivia Berger**

University of Duisburg-Essen  
Duisburg, Germany  
Email: olivia.berger@stud.uni-due.de

## **Sarah Bludau**

University of Duisburg-Essen  
Duisburg, Germany  
Email: sarah.bludau@stud.uni-due.de

## **Kristina Schrickel**

University of Duisburg-Essen  
Duisburg, Germany  
Email: kristina.schricket@stud.uni-due.de

## **Abstract**

Crisis situations are characterised by their sudden occurrence and an unclear information situation. In that context, social media platforms have become a highly utilised resource for collective information gathering to fill these gaps. However, there are indications that not only humans, but also social bots are active on these platforms during crisis situations. Although identifying the impact of social bots during extreme events seems to be a highly relevant topic, research remains sparse. To fill this research gap, we started a bigger project in analysing the influence of social bots during crisis situations. As a part of this project, we initially conducted a case study on the Manchester Bombing 2017 and analysed the social bot activity. Our results indicate that mainly benign bots are active during crisis situations. While the quantity of the bot accounts is rather low, their tweet activity indicates a high influence.

**Keywords** Social Bots, Social Media, Social Media Analytics, Crisis Communication, Sensemaking, Information Systems

## 1 Introduction

Social media has altered the way in which crises (man-made or natural catastrophes) are perceived and communicated about. Social media has become a key instrument for information sharing that allows quick interactions due to short response times and is an efficient way to quickly reach a vast amount of users (Mirbabaie et al., 2014; Palen et al., 2010; Stieglitz et al., 2017b; Wagner et al., 2012). Simultaneously, social media crisis communication is a highly complex topic, because of the “*high number and dynamics of participants as well as the technical requirements of platforms*” (Stieglitz et al. 2017, p. 4). As crisis situations are oftentimes distinguished by their uncertainty through a lack of information, people try to reduce this uncertainty and close information gaps by communicating with each other and thus making sense of the situation (Dervin, 2003; Weick, 1988). According to sensemaking, individuals are living in a world of uncertainties and knowledge gaps (Dervin, 2003). Social media platforms could serve as a relevant medium to close these gaps as they allow their users to decrease their uncertainty through an information exchange process. Research revealed that social media platforms can be highly effective for all participants to make sense of an event (Mirbabaie and Zapatka, 2017). However, the characteristics of social media platforms at the same time give way to negative occurrences such as the spread of false information (Stieglitz et al., 2017b). One phenomenon that has recently been observed to foster these negative mechanics are so called *social bots* – accounts on social media platforms that mimic human behaviour and spread vast amounts of messages believed to aim at influencing human user’s opinions. These accounts have seen a rise in attention lately, oftentimes in the context of a possible interference in politics. While the discussion about possible negative effects of social bots predominates the discussion, there are also cases of benign bots, that is bots which are applied in support of a certain topic (Brachten, et al. 2017).

Prior research indicates that social bots might also be active during crisis situations as well (Bunker et al., 2017). However, research on the occurrence of social bots during crisis communication on social media has been rather sparse. Especially as emergency agencies have started to be active on social media and seek to manage the communication (Ludwig et al., 2015), it is important to understand the validity of the data the agencies are working with. We seek to shed light on this phenomenon. Thus, we initially aim to analyse a crisis situation to elucidate the occurrence of social bots. To do so, we seek to present preliminary findings for the two following research questions:

**RQ1:** *To what extent are social bots active during a crisis situation?*

**RQ2:** *What content do influential social bots spread during a crisis situation?*

In order to answer these research questions, we conducted a case study on the Manchester Bombing 2017. By filtering the dataset for users with the highest retweet count, we identified the so-called power users, which have the biggest influence on crisis communication and therefore exert a high impact on sensemaking. The findings will serve as a first step of better understanding the value of social media communication during crisis situations. This research-in-progress is part of a bigger project that aims at identifying the impact of social bots on crisis communication to a full extent.

## 2 Background

### 2.1 Crisis Communication in Social Media

Social media has gained increased importance in crisis situations as an information source as well as a communication channel (Ehnis et al., 2014; Ross et al., 2018). Prior studies have shown that during crises and risk events, people engage in several forms of communication to learn about the specific situation, in order to gain control and reduce their personal uncertainties (Lachlan et al., 2016, 2009). Social media platforms, such as Facebook or Twitter initially gained importance, as they became a highly utilized resource for communication and information seeking during crisis events (Stieglitz et al., 2017b). Acar and Muraki (2011) examined crisis communication on Twitter during the tsunami in Japan in 2011 and revealed that people who were directly involved, tweeted about their unsafe situation and survival related topics while people from indirectly related areas tweeted to inform others that they were safe. Research also shows that especially for emergency agencies trying to manage a crisis and coordinate people affected by it, social media platforms have become an important way to reach people affected by a crisis situation. As described above, the reason for people to flock to social media in crisis situations is the need for information. As the need for disclosed information increases and the amount of new validated information stagnates, people tend to form their own opinion through dialogue with other users a process called sensemaking (Maitlis and Christianson, 2014).

## 2.2 The Theory of Sensemaking

Sensemaking has become an important topic in the study of organisations and IT systems (Maitlis and Christianson, 2014) and takes place in times of vague or missing information. Sensemaking “*is triggered by cues, such as issues, events or situations for which the meaning is ambiguous and outcomes are uncertain*” (Maitlis and Christianson 2014, p. 70), criteria, all of which apply to crisis situations. The main goals of sensemaking are the arrangement of information in a meaningful context and the reduction of individual knowledge gaps (Stieglitz et al., 2018). The general concept of sensemaking has been predominantly researched within the domains of organisations and on the individual level. However, social media enables users to participate in a collaborative sensemaking process, e.g. by reading, retweeting, and commenting on microblog sites like Twitter. Thus, social media hereby serves as a medium for collective sensemaking and research has shown that a loosely connected group of people can work together to come to an agreement about a certain situation (Hughes et al., 2008). The connectivity and fast information flow in social media can be a factor that further facilitates this collective sensemaking process. As sensemaking in social media is a collaborative process, each individual can influence the group’s opinion (Stieglitz et al., 2018). This is an important aspect as the concept relies on the assumption that human users in crisis situations on social media have the goal to work together to reduce uncertainty and make sense of a situation. However, research indicates that a portion of communication on social media platforms does not stem from human users but is generated by automated actors, so called social bots. On Twitter for example, studies estimate that between 9% and 15% of the overall traffic are actually generated by bots (Varol et al., 2017).

## 2.3 Social Bots

The term “social bot” describes accounts on social media sites that are controlled by bots and imitate human users to a high degree but differ regarding their intent (Stieglitz et al., 2017a). In the last years this phenomenon has gained growing interest. While the term social bot can describe both – benign as well as malicious bots, especially the latter have seen a rise in attention. Especially in the political sphere, their potential influence on the opinion of social media users and thus the outcome of votes has been researched (e.g. in the presidential election 2016 by Bessi & Ferrara (2016)), where an activity of social bots could be proven. A key aspect of the bots is the imitation of human behaviour, for social media users it is oftentimes hard to tell whether a message on a platform stems from a bot or a human user. These bots can thus evoke the impression that some information or opinion, regardless of its accuracy, is highly popular and endorsed by many, a strategy oftentimes observed in the literature on bots (Ferrara et al., 2014). As this example suggests, there have been cases where social bots interfered with the communication on social media. However, the findings on crisis communication remain sparse. While Cassa et al. (2013) did find bot communication in their dataset, it has not been the main research focus. Still, as social media gains more importance for emergency agencies to reach people and for the people affected by a crisis to make sense of it and gain information, it is important to get an understanding on the role social bots play in these scenarios. Should they for example try to spread false information, this has to be taken into account when assessing the usefulness of social media data.

# 3 Research Method

## 3.1 Data Collection

Twitter Data has been researched extensively in previous literature and serves as the main social media platform within the IS community. One of the reasons is the open mentality and the API. As previous findings indicate that the number of bots applied may be related to the language of an event with English providing a richer database (Brachten et al., 2017), we chose to examine a case that took place in an English speaking area. Due to medias’ prominence which indicates a high Twitter activity, we selected the Manchester bombing. On May 22 in 2017 at 22.35 CEST, an individual detonated a bomb in the Manchester Arena. A hashtag was created within the social media communication (#roomformanchester). We collected data via the Twitter Search API for the hashtags “#roomformanchester”, “#Manchester” and “#manchesterbombing”, and the keyword “Manchester”. The data consisted of tweets sent between 22/05/2017 at 22:00 CEST and 24/05/2017 at 22:00 CEST, as this was the period of time with the highest tweet activity.

## 3.2 Bot Detection

For an initial and representative analysis, we focused on the top 20,000 power users as those have the highest impact on sensemaking (Oh et al., 2015). We identified the bots within the sample by using the tool *Botometer*. The tool enables users to enter a Twitter screenname and then assigns a value between



0 and 1 indicating the probability of that account being a bot (Davis et al., 2016). This estimation is based on more than 1.000 features of an account (e.g. the tweet frequency or friend-follower-ratio) and has been applied in past studies for that purpose (Varol et al., 2017). Former studies applied a value of 0.7 and above for an account to be labelled as a bot (Bessi and Ferrara, 2016), which we follow to discriminate between bots and human accounts.

### 3.3 Content Analysis

Following this **first step**, a content analysis was conducted (Skalski et al., 2017). The tweets of the identified bots were classified into dedicated types two general categories from previous research - malicious or benign (Stieglitz et al., 2017a). To classify a bot as malicious, we classified the content of a tweet as (1) commercial, (2) misdirection, (3) spam or (4) others\_malicious (Subrahmanian et al., 2016). To classify a bot as benign, we labelled the content as (1) news reports, (2) weather reports, (3) sports bots, (4) traffic bots or (5) others\_benign (Lokot and Diakopoulos, 2016). As the application of the categories from the first step showed that all of those tweets fell in the category of 'benign', as a **second step** we conducted a second analysis by adapting a codebook from Skalski et al. (2017) to our case, which specifies additional subcategories: (1) Help, (2) Succor, (3) Sympathy, (4) News Report, (5) Search, (6) Criticizing fake information and (7). Other. To ensure a complete understanding of the categories a test coding of 100 tweets was conducted by three coders. Afterwards, Krippendorff's alpha was calculated to test the intercoder reliability. The achieved value of 0.889 indicates a complete coding consistency.

## 4 Preliminary Findings

The initial dataset consisted of 3,285,906 tweets by 1,455,148 accounts, of which tweets from 63,965 accounts were retweeted. Table 1 provides an initial insight into the descriptive statistics for the dataset and shows a rather high average Tweet count (though with a high SD) for the accounts in the sample. To gain first insights into the data, we filtered the number of tweets for preliminary analysis. Therefore, the data was pre-processed manually to identify the 20,000 top users. These power users are those accounts that were most retweeted during the tracking period (Oh et al., 2015). They are participants who are central in a network and who are influencing other participants, hence might have an influence on the sensemaking process. This influence is reflected by their high number of retweets (Mirbabaie and Zapatka, 2017).

Metric	Accounts in the sample		Tweets in the sample	
	Tweet count	Follower count	Retweet count	Favourite count
Min	0	0	0	0
Max	8,027,281	76,966,400	107,694	317,964
Mean	30,052	4,493	5,679	2.18
SD	67,513	130,385	13,589	245.85

Table 1. Descriptive statistics for the initial dataset

During the bot detection on the sample of the 20,000 power users 58 accounts (0.2%) were assigned a value greater than 0.7 and were thus classified as bots. These accounts posted a total of 405 tweets within the sample of 20,000 top-users (approximately 7 tweets per account). Our content analysis revealed that all bot accounts fall into the general category of benign bots. Table 2 shows the distribution of tweets in the categories.

Classification	Number of tweets
Search	153
Sympathy	122
Help	34
Succour	59
News	27
Criticizing fake information	10

Table 2. Distribution of Bot-tweets within tweet Categories

## 5 Discussion

Our preliminary findings revealed that 58 (0.2%) bots were found among the 20,000 power users – much less than previous studies estimated for Twitter communication (Varol et al., 2017). Thus, it can be assumed that during this particular crisis, social bots did not have a particular high influence on crisis communication regarding the *quantity* of the accounts. However, the results indicate that with 405 tweets in total and 7 tweets per account, the bot accounts were far more active than human accounts, which only posted 2 tweets per user on average. This result matches previous research stating that bots have an overall higher frequency (Davis et al., 2016). The results from our study indicate that this higher frequency may be also valid for benign bots. Taking into account that only a small sample was analysed, it will be necessary to see how the bot activity in the overall sample will turn out. One aspect that might be accountable for the low number of bot accounts is the timespan between the gathering of data (i.e. May 2017) and the date of the preliminary analysis (February 2018), which could lead to accounts being deleted from Twitter either for being bots or simply being deleted by their creators. This assumption is also backed by observations we made during the analysis of our dataset on Botometer via Python. During this process, we encountered instances which showed that accounts in the dataset could not be found on Twitter anymore.

The reason for the subsample of the 20,000 power users was to only choose the most-retweeted users. Since the 58 identified bots showed a high tweet activity, it is likely that there is much more bot activity within the remaining sample. This would also mean that those accounts are not retweeted as often as the 20,000 power users. However, focusing on the retweet count does not always show the most influential users (Mirbabaie et al., 2018). With an extensive Social Network Analysis, more influential bots may be identified. As our results indicate, many of the identified bots' messages fall into the category of *sympathy*. Hence, it might be possible that these accounts might also be able to provide emotional aid for people in need. Nevertheless, these findings also indicate that within the 20,000 most retweeted users, bot accounts are sparse yet active. Should this hold true for the overall sample it would also be an interesting finding for emergency agencies, who could incorporate the findings and in their twitter communication for crisis situations.

The analysis of the identified bots during a preliminary content analysis revealed that the content of all bots in our sample was classified as benign. This is contrary to findings in prior research. Most studies focused on the negative side of bots and their threats (Alarifi et al., 2016; Chu et al., 2012; Lokot and Diakopoulos, 2016) without assessing opportunities that could arise out of bots in general and in crisis situations more specific. One possibility would be that messages classified as benign were retweeted the most, because people could discriminate between those messages that really mattered and those that didn't, rendering a crisis situation an occasion, where the primary goal is to help people. In that regard, it might also be possible that malicious bots attempt to take advantage of the crisis in the aftermath of the attack. If the preliminary findings should hold true for the overall sample, it could also indicate that for emergency agencies, the use of social bots in crisis situations could be a way to be heard by the overall public and to efficiently spread important information. If during crisis situations benign messages by bot actors actually got retweeted the most (as indicated by our current findings from the top 20,000 retweeted users) this could hold potential for a professionalised coordination by emergency agencies. The introduction of social bots in this area could save a lot of time and provide a sophisticated coverage of news dissemination as well as emotional aid for the population.

## 6 Conclusion and Further Research

We could identify social bot activity in the researched sample of Twitter communication during the Manchester bombing. Initial findings suggest that the accounts in the current sample exclusively spread benign messages, having the potential to help people during an immediate crisis situation. Furthermore, the results indicate that overall, social bots have a higher tweet activity during crisis situations than human users. Thus, benign bots could exert a high influence on the sensemaking process on social media. An expansion of these findings is needed to get a clearer picture of the magnitude of the bot activity in the overall data sample. The preliminary findings presented in this paper indicate that bot activity is taking place during crisis situations and may even have the potential to actively help in a crisis situation. As our preliminary findings are based on a small sample of a rather active group of accounts, the logical next step will be to analyse bigger and multiple datasets. Besides the identification of social bots via the method already deployed on the current sample and an expansion of the content analysis, a social network analysis will be conducted to visualise and identify communities within the dataset. In that context, an inclusion of data regarding different influence measures such as the *Betweenness* or

*Eigenvector* Centrality could show even more fruitful results with an increased number of influential bots.

Our preliminary findings have several limitations, which we plan to address in future research. First and foremost, the current findings are based on a sample of the actual dataset. While this sample consists of the 20,000 power users, the validity of the findings will be greatly enhanced by expanding the analysis to the whole dataset. Furthermore, the current analysis should be expanded, for one to include an expanded content analysis which's codebook could then also be used for further research on the field of bots in crisis situations. Also, a network analysis on the dataset would be valuable to gain better insights in the communication structure of bots during crisis. Based on an expansion of the analysis to the whole dataset it would also be interesting to compare the current case against other a) man made crises (such as other terror attacks) and b) natural disasters. As especially the former hold potential for the application of social bots, they are the best suited for initial analysis on the field of social bots in crisis communication. Besides the differentiation between different kinds of crises it is also important to look at the situation in different countries, and on different platforms. The current case also only focuses on the three days following the incident. Future research could expand this timeframe to gain further insights how the situation and the bot category distribution develops over time. Especially with regard to the possibility that the initial timespan may have been too short for creators of social bot accounts to intervene in the discussion. Further, a time series analysis should shed light on the dissemination of messages during the crisis and can show which actors are active at what time period. This step will provide insights into bot activity during certain time periods within a crisis and may for example show whether certain kind of bots (i.e. benign or malicious) are active during different time stamps and how dynamics shift over time.

In summary, the current paper presents preliminary findings on the activity of social bots during crisis communication. An extended version of this paper will build upon these preliminary findings and give extensive insights into the activity of social bots during crisis communication based on a large dataset of several million twitter accounts. Building upon these findings, IS researchers are able to tackle the phenomenon of participating bots in crisis situations and design guidelines as well as frameworks for the use of such data.

## 7 References

- Abokhodair, N., Yoo, D., McDonald, D.W., 2015. Dissecting a Social Botnet, in: Proceedings of the 18th ACM Conference on Computer Supported Cooperative Work & Social Computing - CSCW '15. pp. 839–851.
- Acar, A., Muraki, Y., 2011. Twitter for crisis communication: lessons learned from Japan's tsunami disaster. *Int. J. Web Based Communities* 7, 392.
- Alarifi, A., Alsaleh, M., Al-Salman, A.M., 2016. Twitter turing test: Identifying social machines. *Inf. Sci. (Ny)*. 372, 332–346.
- Bessi, A., Ferrara, E., 2016. Social bots distort the 2016 U.S. Presidential election online discussion. *First Monday* 21, 1–14.
- Brachten, F., Stieglitz, S., Hofeditz, L., Kloppenborg, K., Reimann, A., 2017. Strategies and Influence of Social Bots in a 2017 German state election, in: Proceedings of the Australasian Conference on Information Systems. pp. 1–12.
- Bunker, D., Mirbabaie, M., Stieglitz, S., 2017. Convergence Behaviour of Bystanders: An Analysis of 2016 Munich Shooting Twitter Crisis Communication, in: Australasian Conference on Information Systems (ACIS).
- Chu, Z., Gianvecchio, S., Wang, H., Jajodia, S., 2012. Detecting automation of Twitter accounts: Are you a human, bot, or cyborg? *IEEE Trans. Dependable Secur. Comput.* 9, 811–824.
- Davis, C.A., Varol, O., Ferrara, E., Flammini, A., Menczer, F., 2016. BotOrNot: A System to Evaluate Social Bots, in: Proceedings of the International Conference Companion on WWW. pp. 273–274.
- Dervin, B., 2003. Sense-making Methodology Reader: Selected Writings of Brenda Dervin, Sensemaking Methodology Reader Selected Writings of Brenda Dervin.
- Ehnis, C., Mirbabaie, M., Bunker, D., Stieglitz, S., 2014. The role of social media network participants in extreme events, in: 25th Australian Conference of Information Systems.
- Ferrara, E., Varol, O., Davis, C., Menczer, F., Flammini, A., 2014. The Rise of Social Bots. *Commun. ACM*

59, 96–104.

- Hughes, A.L., Palen, L., Sutton, J., Liu, S.B., Vieweg, S., 2008. “Site-Seeing” in Disaster: An Examination of On-Line Social Convergence. 5th Int. ISCRAM Conf. 44–54.
- Lachlan, K.A., Spence, P.R., Lin, X., Najarian, K., Del Greco, M., 2016. Social media and crisis management: CERC, search strategies, and Twitter content. *Comput. Human Behav.* 54, 647–652.
- Lachlan, K.A., Spence, P.R., Seeger, M., 2009. Terrorist attacks and uncertainty reduction: Media use after September 11. *Behav. Sci. Terror. Polit. Aggress.* 1, 101–110.
- Lokot, T., Diakopoulos, N., 2016. News Bots: Automating news and information dissemination on Twitter. *Digit. Journal.* 4, 682–699.
- Ludwig, T., Reuter, C., Pipek, V., 2015. Social Haystack: Dynamic Quality Assessment of Citizen-Generated Content during Emergencies. *ACM Trans. Comput. Interact.* 22, 1–27.
- Maitlis, S., Christianson, M., 2014. Sensemaking in Organizations: Taking Stock and Moving Forward. *Acad. Manag. Ann.* 8, 57–125.
- Mirbabaie, M., Bunker, D., Deubel, A., Stieglitz, S., 2018. Examining Convergence Behaviour During Crisis Situations in Social Media - A Case Study on the Manchester Bombing 2017, in: *IFIP WG 8.6 Working Conference on Information Sysanizations.*
- Mirbabaie, M., Zapatka, E., 2017. Sensemaking in Social Media Crisis Communications - A Case Study on the Brussels Bombings in 2016, in: *Proceedings of the 25th European Conference on Information Systems (ECIS).* pp. 2169–2186.
- Moon, B., 2017. Identifying Bots in the Australian Twittersphere, in: *Proceedings of the 8th International Conference on Social Media & Society - #SMSociety17.* pp. 1–5.
- Oh, O., Eom, C., Rao, H.R., 2015. Research Note – Role of Social Media in Social Change: An Analysis of Collective Sense Making During the 2011 Egypt Revolution. *Inf. Syst. Res.* 210–223.
- Palen, L., Anderson, K.M., Mark, G., Martin, J., Sicker, D., Palmer, M., Grunwald, D., 2010. A vision for technology-mediated support for public participation & assistance in mass emergencies & disasters. *Proc. 2010 ACMBCS Visions Comput. Sci. Conf.* 1–12.
- Reuter, C., Heger, O., Pipek, V., 2013. Combining Real and Virtual Volunteers through Social Media, in: *Iscram 2013.* pp. 780–790.
- Ross, B., Potthoff, T., Majchrzak, T.A., Chakraborty, N.R., Lazreg, M.B., Stieglitz, S., 2018. The Diffusion of Crisis-Related Communication on Social Media: An Empirical Analysis of Facebook Reactions, in: *Proceedings of the 51st Hawaii International Conference on System Sciences (HICSS).* pp. 2525–2534.
- Skalski, P.D., Neuendorf, K.A., Cajigas, J.A., 2017. Content Analysis in the Interactive Media Age, *The Content Analysis Guidebook.*
- Stieglitz, S., Brachten, F., Ross, B., Jung, A.-K., 2017a. Do Social Bots Dream of Electric Sheep? A Categorisation of Social Media Bot Accounts, in: *Proceedings of the Australasian Conference on Information Systems.*
- Stieglitz, S., Bunker, D., Mirbabaie, M., Ehnis, C., 2017b. Sense-making in social media during extreme events. *J. Contingencies Cris. Manag.* 1, 1–12.
- Stieglitz, S., Mirbabaie, M., Milde, M., 2018. Social Positions and Collective Sense-Making in Crisis Communication. *Int. J. Hum. Comput. Interact.*
- Subrahmanian, V.S., Azaria, A., Durst, S., Kagan, V., Galstyan, A., Lerman, K., Zhu, L., Ferrara, E., Flammini, A., Menczer, F., 2016. The DARPA Twitter Bot Challenge. *Computer (Long. Beach. Calif).* 49, 38–46.
- Varol, O., Ferrara, E., Davis, C.A., Menczer, F., Flammini, A., 2017. Online Human-Bot Interactions: Detection, Estimation, and Characterization, *arXiv preprint arXiv:1703.03107.*
- Wagner, C., Mitter, S., Körner, C., Strohmaier, M., 2012. When social bots attack: Modeling susceptibility of users in online social networks, in: *Making Sense of Microposts (# MSM2012).* Lyon, France, pp. 1951–1959.
- Weick, K.E., 1988. Enacted Sensemaking in Crisis Situations. *J. Manag. Stud.* 25, 305–317.

**Copyright:** © 2018 Florian Brachten, Milad Mirbabaie, Stefan Stieglitz, Olivia Berger, Sarah Bludau & Kristina Schrickel. This is an open-access article distributed under the terms of the [Creative Commons Attribution-NonCommercial 3.0 Australia License](https://creativecommons.org/licenses/by-nc/3.0/au/), which permits non-commercial use, distribution, and reproduction in any medium, provided the original author and ACIS are credited.

# Ontology in Software Engineering

## Salvatore F. Pileggi

School of Information, Systems and Modelling  
University of Technology Sydney  
Australia  
Email: SalvatoreFlavio.Pileggi@uts.edu.au

## Antonio A Lopez-Lorca

School of Computing and Information Systems  
University of Melbourne  
Australia  
Email: antonio.lopez@unimelb.edu.au

## Ghassan Beydoun

School of Information, Systems and Modelling  
University of Technology Sydney  
Australia  
Email: Ghassan.Beydoun@uts.edu.au

## Abstract

During the past years, ontological thinking and design have become more and more popular in the field of Artificial Intelligence (AI). More recently, Software Engineering (SE) has evolved towards more conceptual approaches based on the extensive adoption of models and meta-models.

This paper briefly discusses the role of ontologies in SE according to a perspective that closely matches the theoretical life-cycle. These roles vary considerably across the development lifecycle. The use of ontologies to improve SE development activities is still relatively new (2000 onward), but it is definitely no more a novelty. Indeed, the role of such structures is well consolidated in certain SE aspects, such as requirement engineering. On the other hand, despite their well-known potential as knowledge representation mechanisms, ontologies are not completely exploited in the area of SE.

We first (i) proposes a brief overview of ontologies and their current understanding within the Semantic Web with a focus on the benefits provided; then, the role that ontologies play in the more specific context of SE is addressed (ii); finally, we deal with (iii) some brief considerations looking at specific types of software architecture, such as Multi-Agent Systems (MAS) and Service-Oriented Architecture (SOA).

The main limitation of our research is that we are focusing on traditional developments, where phases occur mostly sequentially. However, industry has fully embraced agile developments. It is unclear that agile practitioners are willing to adopt ontologies as a tool, unless we ensure that they can provide a clear benefit and they be used in a lean way, without introducing significant overhead to the agile development process.

**Keywords** Ontology, Software Engineering.

## 1 Introduction

During the past years, ontological thinking and design have become more and more popular in the field of Artificial Intelligence (AI). More recently, Software Engineering (SE) has evolved towards more conceptual approaches based on the extensive adoption of models and meta-models (Henderson-Sellers 2011). A recent survey on applications of ontologies for SE (Bathia et al. 2016), provides a broad analysis of current issues and challenges for the years to come. The authors define a fine-grained classification of the ontologies based on their type and scope. The main categories considered within the survey are upper ontology, software process ontology, domain ontology, requirement ontology, architecture and design ontology, pattern ontology, implementation ontology, documentation ontology, quality ontology, maintenance ontology and technology ontology.

In this paper we reflect on the adoption of ontologies in the field of SE according to a role-based perspective that maps the SE life-cycle much closely than in Bathia et al. (2016). We focus our discussion on Requirements Engineering (RE). Furthermore, we briefly discuss the use of ontologies in the context of Multi-Agent Systems (Van der Hoek and Wooldridge 2008) and Service-Oriented Architecture (Stantchev and Malek 2010) development. As far as the authors know, there are no surveys or papers on the topic adopting a similar approach. However, we have identified a number of works that focus vertically on specific aspects or sub-problems. For instance, Gigante et al. (2015) deal with the role of semantics in requirements verification, while Ding et al. (2014) review knowledge-based approaches in software documentation. These contributions are valuable and informative, however, they lack the big picture view that holistic approaches can provide.

This paper first proposes a brief overview of ontologies and their current understanding within the Semantic Web (Berners-Lee et al. 2001) with a focus on the benefits provided. Then, the role that ontologies play in the more specific context of SE is addressed. We focus on the RE activities while maintaining a holistic view of the SE life-cycle. Finally, the paper briefly considers the cases of Multi-Agent Systems (MAS) and Service-Oriented Architecture (SOA).

## 2 Ontology and Web Semantics

The term “ontology” was originally coined in ancient Greece in metaphysics, a major branch of philosophy at the time, to mean “the study of what is there”. This included for example, the question of whether or not there is a God (Hofweber 2018). AI community adopted the term in the 1980’s to describe a central component of knowledge-based systems (Akerkar and Sajja 2010), to conceptualise and to theorise a modelled world (Gruber 2009). In the early 1990’s Gruber (1993) defined ontology as an “explicit specification of a conceptualisation”, a formalization of the definition suitable to many systems.

More recently, ontology has become one of the key concepts underpinning the Semantic Web model (Chandrasekaran et al. 1999) where, unlike other data models, ontology is supposed to address the “meaning” of the target data, information or knowledge. Indeed, in a Web context, ontology is understood as a rich data model, developed upon the Web infrastructure, able to represent complex resources and the relations among them. As resources are univocally identified worldwide by adopting IRIs (Web resources), ontologies work according to an enhanced model of interoperability, commonly referred to as Semantic Interoperability (Obrst 2003). Furthermore, ontology overcomes the most basic understanding of the Semantic Web (e.g. Linked Data (Bizer et al. 2011)) by providing capabilities for standard reasoning, normally based on the specification of inference rules.

Ontologies may have different scopes and purposes. They are currently adopted in a wide range of domains and discipline. In the context of this work, we mostly refer to domain ontologies which, specify a given-domain by defining its objects, the relationships among them and axioms that govern the domain. The main goal of a domain ontologies is to represent a shared view of a domain. Generally speaking, the model of a domain assumes all parties involved in their use agree on the represented conceptualisation, meaning that the concepts adopted are expected to be well-known and accepted.

Ontologies can be defined as Web ontologies using the OWL language (McGuinness and Van Harmelen 2004). This formalisation relies on Axioms which define facts involving Web resources and literals that are supposed to be always true in the considered context. Web ontologies operate under the assumption of an open world, the falsehood of unknown facts is not assumed. Key elements of OWL ontologies are:

- *Classes and class hierarchy* which determine the type of concepts defined in the ontology, i.e. that exist in the domain. For example, a generic class “person” belonging to a given domain can assume two sub-classes, e.g. “worker” and “student”, defining a hierarchy.
- *Individuals* are normally instances of classes, although it is possible to define un-typed individuals.

- *Properties* establish the relationships among concepts in a given domain. For example, an employee could be related to his employer by a given property. Properties are also adopted to specify the attributes of an individual, i.e. the age or the address of an employee.
- *Inference constructs and rules* are extensively used within ontologies to infer further knowledge (referred to as inferred knowledge) from available facts. Inference is a powerful and key mechanism to define semantic patterns in knowledge.

## 2.1 Benefits of Ontologies

The benefits of ontologies are implicitly defined by their own purpose: by providing the “meaning” of the information addressed, ontologies are knowledge structures richer and more expressive than other data models. Additionally, despite their intrinsic complexity, ontologies can be “understood” (at least in theory) by both machines and humans that can so have exactly the same view of a given system. That is in contrast with most models that normally target humans or computers but very rarely both them. Furthermore, ontologies are descriptive models by definition as they focus on the analysis and the description of the domain. So they support very well descriptive approaches, unlike other models that are naturally oriented to prescriptive solutions (Henderson-Sellers 2011).

Potential benefits of ontologies have been extensively discussed in literature (e.g. by Bürger and Simperl (2008)). First of all, because of the high expressiveness, adopting ontologies provides an opportunity for automatic reasoning to infer implicit knowledge. On the other hand, other data models lack the necessary underlying semantics. Furthermore, the standardisation and the development upon the Web infrastructure significantly increase the capabilities in terms of information exchange, sharing and re-use. In very few words, the potential benefits provided by ontological frameworks overcome the simple, yet relevant, facilitations for data aggregation from heterogeneous data-sources. For instance, in SE inconsistencies in the modelled knowledge can be detected to prevent propagating errors to later phases of software development. Focusing on a domain perspective, they do not only provide the structure for a data container, but define a formalised domain theory both with its implementation. In more general terms, the benefits of using ontologies have been concisely discussed by Gruninger and Lee (2002), who have identified three main areas:

- *Communication*. Ontologies can assist to ensure interoperability among software entities at multiple layers (e.g. data and process level). The specification of formal semantics contributes to avoid ambiguous definitions as well as unwanted interpretations. Moreover, by providing semantically consistent links, it facilitates knowledge engineering, consolidation and transfer.
- *Reuse*. Ontologies can be used to develop systematic widely accepted knowledge environments. Once an ontology is available in a certain domain, it can be reused for similar developments, as well as it can be used in a different or wider scope. This avoids the expensive ad-hoc development and may increase the quality of the final product. Linking concepts from different ontology provides enormous, still largely unexplored, capabilities. Finally, ontologies are intrinsically extendible.
- *Inference and automatic reasoning*. Ontologies typically adopt logic-based languages (e.g. Description Logics) to define inference rules. These structures permit deriving implicit facts from the explicit stated knowledge. Inference rules are solved by specialized software components, known as reasoners. Inference is a key and critical feature: increasing the capability in terms of inference results in a more sophisticated technology.

## 3 Role of Ontologies in Software Development: Requirement Engineering

Most software development processes share a core set of phases (Tsui 2009) (Figure 1, left):

- The *analysis phase* is aimed at extracting the system requirements from the customer and at building the models to understand the problem.
- In the *design phase*, designers think in terms of the solution to define the architecture of the software without concerning themselves with low-level operational detail.
- Within the *codification phase*, programmers materialize the architecture defined in the previous step by using a concrete programming language.



- During the *testing phase*, the different artefacts produced during the software development are verified and validated to assure their quality and compliance with the original requirements.
- Finally, once the product has been delivered to the client, it starts the last phase, *maintenance*, where errors are identified and fixed. Furthermore, new requirements may be eventually added to the system.

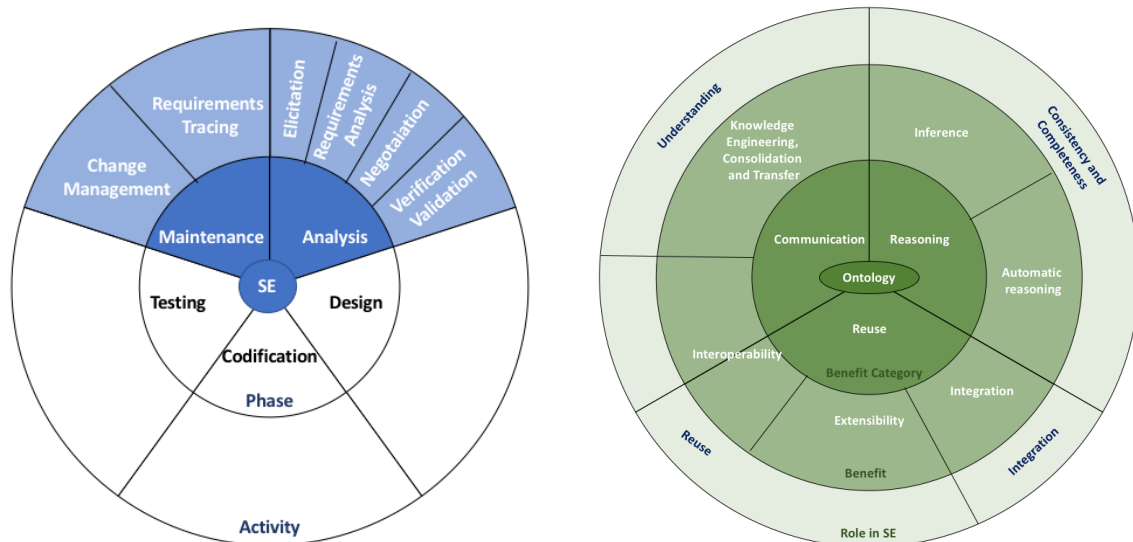

Figure 1: Paper scope in the context of SE (left) and identified ontology roles (right).

The analysis phase is commonly known as requirement analysis phase and, because of its importance, is often object of special attention. It can be further divided in sub-tasks, each one characterised by the following activities (Sadraei et al. 2007):

- *Elicitation* identifies high level goals of the target system, requirements for different groups of users, and the tasks to be accomplished, along with system boundaries. The normal outcome is the early requirements document.
- *Requirement Analysis* analyses the requirements to uncover conflicts, ambiguities, missing or duplicate requirements in order to identify alternatives and convert them into a structured and unambiguous representation. The analysis outcome is an early requirements model.
- *Negotiation* addresses key trade-offs to achieve agreement between stakeholders.
- *Verification and Validation* examine requirements to find any deficiencies in consistency, accuracy and adequacy. It may also include a feasibility analysis to verify the cost of development. After verification and validation, the requirements model should be understood by systems analysts.

Concerning the maintenance phase, two commonly accepted sub-phases may be identified:

- *Change Management* recognizes changes through continuous requirements elicitation, re-evaluation of risk and evaluation of the system in its operational environment (Nuseibeh and Easterbrook 2000), to assure that all relevant information for each change is collected.
- *Requirement Tracing* manages the evolution of requirements, maintaining traces about its history to track the origins of each requirement, so that if a change has to be made to a design component, the original requirement can be located (Davis 1993).

Looking at the typical SE life-cycle with a focus on analysis and maintenance (Figure 1, left), we have identified four different major roles (Figure 1, right) as follows:

- *Consistency and completeness checking*. Ontologies define formal semantics based on some logic. It contributes and can facilitate the automation of important modelling tasks, such as consistency and completeness checking. Consistency checks avoid inconsistent use of knowledge, i.e. to assert truth and falsehood of a given fact at the same time. Automated consistency checking enables the

detection of such assertions through a chain of systematic logical steps. During consistency checking implicit knowledge can also be explicated and modelled. Ontologies can be used this way to complete (Kaiya and Saeki 2005) models acting as reference frames to identify modelling gaps or lacks.

- *Understanding.* By formally defining relations in a domain, ontologies can facilitate the understanding of the target system (e.g. Graja et al. 2011). An ontological approach allows to deconstruct the problem, splitting it into fragments that are easier to understand and analyze. Furthermore, these fragments can be classified, which helps comprehending the underlying structure and eventually defining further relations. Annotation can then be used to augment the concepts of an ontology with metadata that describe them and give further information. These annotations combined with formal relations and structural knowledge, make possible to address a subsequent complexity, suitable for humans and machines both. Semantic query (Ray 2009) provides a powerful interface that enables flexible interaction with ontologies.
- *Integration.* The features of semantic technologies intrinsically enable further capabilities in terms of integration (e.g. Paulheim 2009) within heterogeneous systems, i.e. facilitating that different systems to interoperate and share knowledge. Ontologies are technology-independent knowledge modelling artefacts and can be used in heterogeneous contexts in a wide range of technologies.
- *Reuse.* As previously discussed, ontologies holistically define knowledge by relating atomic concepts. In the context of SE, ontologies are usual to separate domain knowledge from operational knowledge. This facilitates the reuse (Uschold et al. 1998) at two levels: first of all, the ontology schema can be reused as a shared knowledge conceptualization; moreover, it can facilitate the reuse of the concrete artefacts that they describe.

### 3.1 Ontology-driven MAS and SOA Development

The effectiveness of ontology-driven development techniques becomes evident in the moment in which more specific paradigms are considered. Figure 2 shows the theoretical life-cycle for MAS (Van der Hoek and Wooldridge 2008) and SOA (Stantchev and Malek 2010). An exhaustive analysis is out of the scope of the paper. However, it is possible to identify a number of contributions in literature, that adopt an ontology-driven approach for the development of a specific kind of software architectures.

There are cases in which ontologies are applied to generic aspects. That is, for example, the case of the methodology adopted by Cossentino et al. (2010) which adopts an ontological approach in early stages of analysis to describe the problem domain concepts and to complement the requirements description in terms of use cases in MAS. As well as, Tran and Low (2008) focus on ontological capabilities to produce MAS whose components are interoperable and reusable.

Some other works attempt to use ontologies to improve aspects, specific of a kind of architecture. For instance, Girardi and Leite (2008) address explicitly the model of the MAS domain. Nyulas et al. (2008) present an ontology-driven framework for deploying MAS upon JADE (Bellifemine et al. 2007). Sensoy et al. (2010) and Fornara and Colombetti (2009) use OWL ontologies to define the policies that rule agent behaviour.

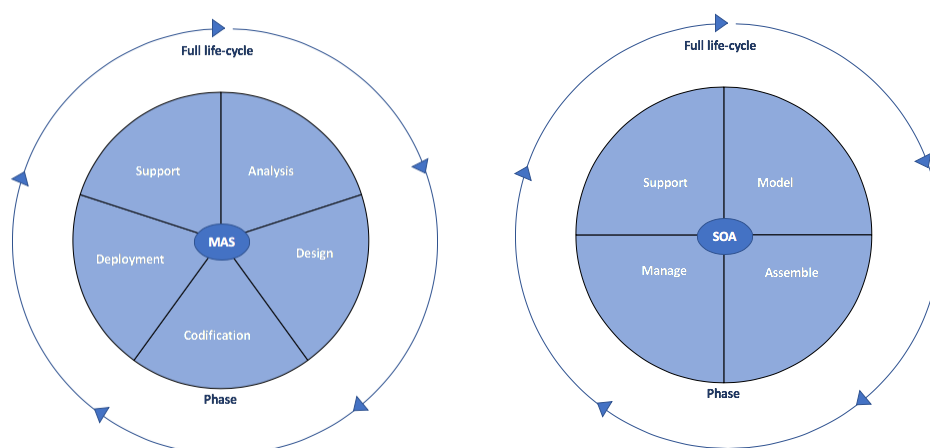

Figure 2: Theoretical MAS (left) and SOA (right) lifecycle.

## 4 Conclusion and Future Work

This paper briefly discusses the role of ontologies in SE according to a perspective that closely matches the theoretical life-cycle. These roles vary considerably across the development lifecycle. The use of ontologies to improve SE development activities is still relatively new (2000 onward) but it is definitely no more a novelty. Indeed, the role of such structures is well consolidated in certain SE aspects, such as requirement engineering. On the other hand, despite their well-known potential as knowledge representation mechanisms, ontologies are not completely exploited in the area of SE.

We believe that ontology-driven software development will be consolidated in the next future, becoming more popular and, eventually, extensively adopted in fact. To contribute to this goal, we seek to explore uses of ontologies for the development of both MAS and SOA. We will attempt to harness their potential, including automatic reasoning, as a tool to enable the verification and validation of these systems. This is, ensuring consistency and traceability of artefacts along the development life-cycle, and consistency against the client needs, respectively.

One limitation of our research, is that we are focusing on traditional developments, where phases occur mostly sequentially. However, industry has fully embraced agile developments. It is unclear that agile practitioners are willing to adopt ontologies as a tool, unless we ensure that they can provide a clear benefit and they be used in a lean way, without introducing significant overhead to the agile development process.

## 5 References

- Akerkar, R., and Sajja, P. (2010). *Knowledge-based systems*. Jones & Bartlett Publishers.
- Bellifemine, F. L., Caire, G., and Greenwood, D. (2007). *Developing multi-agent systems with JADE* (Vol. 7). John Wiley & Sons.
- Berners-Lee, T., Hendler, J., and Lassila, O. (2001). "The Semantic Web". *Scientific American*, 284(5), 34-43.
- Bhatia, M.P.S., Kumar, A. and Beniwal, R. (2016). "Ontologies for software engineering: Past, present and future". *Indian Journal of Science and Technology*, 9(9).
- Bizer, C., Heath, T., & Berners-Lee, T. (2011). "Linked data: The story so far". In *Semantic services, interoperability and web applications: emerging concepts* (pp. 205-227). IGI Global.
- Bürger, T., & Simperl, E. (2008). "Measuring the benefits of ontologies". In *OTM Confederated International Conferences On the Move to Meaningful Internet Systems* (pp. 584-594). Springer, Berlin, Heidelberg.
- Chandrasekaran, B., Josephson, J. R., & Benjamins, V. R. (1999). "What are ontologies, and why do we need them?". *IEEE Intelligent Systems and their applications*, 14(1), 20-26.
- Cossentino, M., Gaud, N., Hilaire, V., Galland, S., & Koukam, A. (2010). "ASPECS: an agent-oriented software process for engineering complex systems". *Autonomous Agents and Multi-Agent Systems*, 20(2), 260-304.
- Davis, A. M. (1993). *Software requirements: objects, functions, and states*. Prentice-Hall, Inc..
- Ding, W., Liang, P., Tang, A. and Van Vliet, H. (2014). "Knowledge-based approaches in software documentation: A systematic literature review". *Information and Software Technology*, 56(6), pp.545-567.
- Fornara, N., & Colombetti, M. (2009, May). "Ontology and time evolution of obligations and prohibitions using semantic web technology". In *International Workshop on Declarative Agent Languages and Technologies* (pp. 101-118). Springer, Berlin, Heidelberg.
- Gigante, G., Gargiulo, F. and Ficco, M. (2015). "A semantic driven approach for requirements verification". In *Intelligent Distributed Computing VIII* (pp. 427-436).
- Girardi, R., & Leite, A. (2008). "A knowledge-based tool for multi-agent domain engineering". *Knowledge-Based Systems*, 21(7), 604-611.

- Graja, M., Jaoua, M., and Belguith, L. H. (2011). "Building ontologies to understand spoken Tunisian dialect". *arXiv preprint arXiv:1109.0624*.
- Gruber, T. R. (1993). "A translation approach to portable ontology specifications". *Knowledge acquisition*, 5(2), 199-220.
- Gruber, T. (2009). "Ontology". *Encyclopedia of database systems*, 1963-1965.
- Gruninger, M., and Lee, J. 2002. "Ontology - Applications and Design". *Communications of the ACM* (45:2), pp 39 - 41.
- Henderson-Sellers, B. (2011). "Bridging metamodels and ontologies in software engineering". *Journal of Systems and Software*, 84(2), 301-313.
- Hofweber, T. (2018). "Logic and Ontology", *The Stanford Encyclopedia of Philosophy* (Summer 2018 Edition), Edward N. Zalta (ed.).
- Kaiya, H., and Saeki, M. (2005). "Ontology based requirements analysis: lightweight semantic processing approach". In *5<sup>th</sup> International Conference on Quality Software*, 2005 (QSIC 2005).
- McGuinness, D. L., and Van Harmelen, F. (2004). "OWL web ontology language overview". *W3C recommendation*, 10(10), 2004.
- Nuseibeh, B., and Easterbrook, S. (2000). "Requirements engineering: a roadmap". In *Proceedings of the Conference on the Future of Software Engineering* (pp. 35-46). ACM.
- Nyulas, C. I., O'Connor, M. J., Tu, S. W., Buckeridge, D. L., Okhmatovskaia, A., & Musen, M. A. (2008). "An ontology-driven framework for deploying jade agent systems". In *Proceedings of the 2008 IEEE/WIC/ACM International Conference on Web Intelligence and Intelligent Agent Technology-Volume 02* (pp. 573-577). IEEE Computer Society.
- Obrst, L. (2003). "Ontologies for semantically interoperable systems". In *Proceedings of the twelfth international conference on Information and knowledge management* (pp. 366-369). ACM.
- Paulheim, H. (2009). "Ontologies for user interface integration". In *International Semantic Web Conference* (pp. 973-981). Springer, Berlin, Heidelberg.
- Ray, S. K., Singh, S., and Joshi, B. P. (2009). "Exploring multiple ontologies and WordNet framework to expand query for question answering system". In *Proceedings of the First International Conference on Intelligent Human Computer Interaction* (pp. 296-305). Springer, New Delhi.
- Sadraei, E., Aurum, A., Beydoun, G., and Paech, B. (2007). "A field study of the requirements engineering practice in Australian software industry". *Requirements Engineering*, 12(3), 145-162.
- Şensoy, M., Norman, T. J., Vasconcelos, W. W., & Sycara, K. (2010). "OWL-POLAR: Semantic policies for agent reasoning". In *International Semantic Web Conference* (pp. 679-695). Springer, Berlin, Heidelberg.
- Stantchev, V., and Malek, M. (2010). "Addressing dependability throughout the SOA life cycle". *IEEE Transactions on Services Computing*, (2), 85-95.
- Tran, Q. N. N., & Low, G. (2008). "MOBMAS: A methodology for ontology-based multi-agent systems development". *Information and Software Technology*, 50(7-8), 697-722.
- Tsui, F., Karam, O., & Bernal, B. (2016). *Essentials of software engineering*. Jones & Bartlett Learning.
- Uschold, M., Healy, M., Williamson, K., Clark, P., and Woods, S. (1998). "Ontology reuse and application". In *Formal ontology in information systems* (Vol. 179, p. 192). IOS Press Amsterdam.
- Van der Hoek, W., and Wooldridge, M. (2008). "Multi-agent systems". *Foundations of Artificial Intelligence*, 3, 887-928.

# Barriers of e-Tourism Adoption in Developing Countries: A Case Study of Nepal

## Sanjay Lama

School of Information, Systems and Modelling  
University of Technology Sydney  
Sydney, Australia  
Email: Sanjay.Lama@student.uts.edu.au

## Sojen Pradhan

School of Information, Systems and Modelling  
University of Technology Sydney  
Sydney, Australia  
Email: Sojendra.Pradhan@uts.edu.au

## Anup Shrestha

School of Management and Enterprise  
University of Southern Queensland  
Toowoomba, Australia  
Email: Anup.Shrestha@usq.edu.au

## David Beirman

Management Discipline Group  
UTS Business School  
University of Technology Sydney  
Sydney, Australia  
Email: David.Beirman@uts.edu.au

## Abstract

Developing countries lack e-tourism competencies despite attractive destinations to offer. Nepal is one of the developing countries with its natural beauty and diverse cultural heritage that has great tourism potential. This research is aimed at identifying barriers of e-tourism adoption in developing countries, using Nepal as a case study. Based on the Technology, Organization and Environment (TOE) and e-readiness models, and our literature review, we propose ten factors that affect e-tourism adoption. We applied mixed methods to validate these factors using seven interviews with relevant stakeholders and a survey of 198 tourism organisations in Nepal. The results demonstrate that e-tourism adoption is affected by environmental factors such as lack of national infrastructure, market size, and country-specific contextual factors. Similarly, organizational factors include lack of e-tourism awareness, lack of resources, low value proposition and limited top management support. Finally, we discuss these factors and its implication to policy and practice.

## Keywords

e-Tourism; technology adoption barriers; environmental and organisational factors; developing countries; Nepal

## 1 Introduction

In the global tourism business, travellers today have access to faster and cost-effective online platforms for planning, booking and paying for their future trips (Buhalis & Jun, 2011). New technologies have offered tourists the flexibility and choices during pre-purchase activities such as searching, planning and comparing tour packages (Buhalis & Law, 2008). Similarly, potential tourists can read online reviews and contact several travel agencies before making final purchase decisions for hotels and tourist destinations (Gonzalo, 2014). In such a competitive e-tourism ecosystem, developing countries are missing out to offer pre-purchase facilities to potential tourists even though these countries often have attractive destinations to offer in order to claim a greater market share. Tourism operators in developing countries, particularly small and medium tourism operators (SMTEs) that lack global franchise connections, are lagging behind in the uptake of e-tourism features in their services.

This research is aimed at identifying barriers of e-tourism adoption in one of the developing countries, taking Nepal as a case study. Nepal has great tourism potential with its natural beauty and diverse cultural heritage. Nevertheless, there is limited adoption of e-tourism in Nepal and majority of travel businesses operate traditionally. Therefore, developing countries like Nepal fail to reach its potential target market as tourism operators are unable to offer technology-enabled pre-purchase facilities. In this context, this research is aimed at: (a) identifying the barriers that affect e-tourism adoption by SMTEs; and (b) creating a conceptual model for effective adoption of e-tourism in developing countries.

Despite having own unique contexts and specific environments, developing countries typically share several common features such as low ICT adoption index, turbulent political and macroeconomic circumstances (Karanasios & Burgess 2008). There have been several research on general e-commerce adoption in developing countries but very few have focused on the tourism industry. It is widely recognized that the factors impacting e-commerce adoption differ greatly for every industry (Brdese, 2013). Therefore, the 'one-size-fits-all' model may not be feasible for e-commerce adoption (Molla & Licker, 2005). Consequently this research attempts to explore unique scenarios in terms of barriers of e-tourism adoption in Nepal.

We present a background on tourism in developing countries, relevant factors for e-tourism adoption and widely accepted frameworks of technology adoption. It is followed by an introduction to the case study of tourism in Nepal. We discuss our research methodology and present a conceptual model for e-tourism adoption. Finally, we conclude with possible future research directions and implications for developing countries.

## 2 Background

Tourism is one of the biggest exports of over eighty percent of developing countries (Samimi et al., 2011). According to World Tourism Organization (UNWTO), the ratio of tourists who visited developing countries is 40 % and is increasing (UNWTO 2017). Similarly, UNWTO, in its report revealed that tourism is contributing between 3 to 10 % of the overall GDP of many developing countries.

Because of the nature of tourism services that is usually intangible and perishable, it is one of the most appropriate industries for the adoption of ICT (Karanasios & Burgess, 2008). Searching and booking travel commodities, such as accommodation, tours and flights have been one of the most online frequent activities. With the advent of Web 2.0 and review/ranking sites such as TripAdvisor, Expedia and Booking.com, tourists spend a lot of their time researching before making a final decision. Activities such as inquiries, bookings, and confirmation of tickets require clear communication between providers and consumers. Gonzalo (2014) found that 27 % of hoteliers communicate with customers before their arrival.

E-tourism is also enabling comparison of tourism service offerings, getting real-time prices and enabling transparent tourism-related processes (Buhalis & Jun, 2011). With the growing

popularity of websites such as Tripadvisor.com, people are interested in expressing their views and reading other's experiences and opinions on the Internet. TripAdvisor already has around 170 million reviews, with over 280 million unique visitors every month, which shows extensive utilization of e-tourism (Gonzalo, 2014). Yet, SMTEs in developing countries like Nepal have lagged behind in the adoption of e-tourism primarily due to technology barriers.

### 3 E-Tourism in Nepal

Nepal is an attractive tourist destination. Lonely Planet, the largest travel guide book publisher, ranked Nepal as one of the best destinations to travel in 2017. Nepal is rich in cultural diversity, sculptures, heritage, natural beauty and home to many flora and fauna. Popularly known as the land of Himalayas, it has more than 1,300 mountain peaks and is one of the most visited travel destinations for mountaineers, trekkers and adventure seekers. It is home to eight of the ten highest mountains in the world. Despite the abundance of natural resources and huge potential for tourism business, the tourism industry has not contributed significantly towards uplifting the economic status of the nation in a sustainable manner. Nepal is one of the developing countries with low human development index of 0.558 and ranks 144th in the overall index (UNDP 2017). Tourism is one of the major sectors which provide a large number of employment (approximately 427,000 people) and contributed almost 7.5 % of total Gross Development Product (GDP) in the year 2016 (World Travel and Tourism Council 2017).

ICT infrastructure in Nepal is underdeveloped and largely centralized in the capital city of Kathmandu. Though the computers and Internet usage started in the early 90's, the overall ICT development has been sluggish. The government created the IT Policy 2000 (Ministry of Science and Technology 2000) with the objective of making ICT more accessible to the public and create knowledge-based societies and industries. It was a government initiative to use IT as a tool for development and growth (Ministry of Information and Communication 2015). Similarly, the Electronic Transaction Act 2008 governs the electronic transactions in Nepal (Ministry of Science and Technology 2008) with provisions for recognition of digital documents and electronic transactions. However, full implementation of the Act still faces many challenges from practical difficulties, lack of readiness and co-ordination among key stakeholders (Dhami 2015). Due to these significant hurdles, e-tourism has not been adopted in Nepal beyond the primary use of websites for general information for tourists.

### 4 Theoretical Framework & Hypotheses

Since e-tourism adoption is a technology-based phenomenon, we reviewed widely accepted technology adoption frameworks: Theory of Reasoned Action (TRA) (Ajzen & Fishbein 1980), Technology Acceptance Model (TAM) (Davis 1989), Technology, Organization and Environment (TOE) model (Tornatzky et al. 1990), TAM 2 (Venkatesh & Davis 2000), Unified Theory of Acceptance and use of Technology (UTAUT) (Venkatesh et al. 2003) and e-Readiness model (Molla & Licker 2005).

Each framework and its components were examined with a view to adapt it to establish a framework for e-tourism adoption for developing countries, using Nepal as a case study. Evaluation criteria for fit of these well-established frameworks for our research setting were conducted based on the three parameters: (a) Unit of analysis: individual (I) or organisation (O); (b) prior studies in the context of developing countries; and (c) focus on technology. Evaluation of contemporary technology adoption frameworks for e-tourism adoption in developing countries is presented in Table 1.

Evaluation in Table 1 demonstrate that TOE (Tornatzky & Fleischer 1990) and e-readiness model (Molla & Licker, 2005) operate at organizational unit of analysis which is relevant to our study. Furthermore, e-readiness model has been extensively studied in the context of developing countries. Consequently, we select these two frameworks to study factors affecting technology for SMTEs in Nepal. TOE focuses on three factors: technology, organization and

environment; that influence technology adoption within a business. E-readiness model emphasizes perceived external e-readiness (PEER) and perceived organizational e-readiness (POER) towards technology adoption. From these two frameworks, seven factors: market forces, supporting industries, contextual factors, infrastructure, awareness, resources and owner or top management support are proposed.

Table 1: Evaluation of popular frameworks about technology adoption for e-tourism in developing countries

Frameworks	Review	Evaluation		
		Unit of Analysis	Context of Developing Countries	Technology Focus
TRA (Ajzen & Fishbein, 1980)	studies human behaviour at the individual level rather than organisation level.	I	×	×
TAM (Davis, 1989); TAM 2 (Venkatesh & Davis, 2000)	relevant for individual-level technology adoption	I	×	✓
TOE (Tornatzky and Fleischer, 1990)	studies innovation adoption on the organisation level.	O	×	✓
UTAUT (Venkatesh et al., 2003)	technology adoption study at the individual level.	I	×	✓
E-readiness model (Molla & Licker, 2005)	studies perceived organisation e-readiness and environmental e-readiness.	O	✓	✓

Beyond the seven proposed factors from the theoretical frameworks, we introduced three more factors based on extant literature review of tourism-related issues in the developing countries. Kshetri (2007) included factors related to language and culture into one category called cognitive factors. Similarly, Kapurubandara and Lawson (2006) used “social-cultural” term to include factors related to culture. These two factors ‘cultural barriers’ and ‘language barriers’ are merged into a single category and termed as “*socio-cultural*” factor in this study. Other factors investigated in the literature include ‘perceived benefits’ and ‘relative advantage’ which are related to the value that the adoption of e-commerce can add to the organizations (Kabanda & Brown, 2010). Other studies (Dwivedi et al., 2009; Rowe et al., 2012; Scupola, 2003) investigated e-commerce adoption and examined relative advantage or value proposition factors based on TOE model. Since both factors are related to the value, they are grouped into a new category and named “*value proposition*”. Finally, factors associated with security concerns, trust and privacy challenges in the area of e-commerce (Pearson & Grandon 2004; Ghobakhloo et al. 2011) are included broadly in the category called “*security concern*”.

The ten factors proposed for this study is grouped under two categories: environmental and organisational factors; and further divided into sub-factors that are associated with each factor. These are outlined in Table 2.

A set of hypotheses has been formulated for each factor to test the impact on e-tourism adoption, resulting in 10 hypotheses (H1 to H10) for these factors. They are listed next.:

*H1: Lack of national infrastructure negatively influences the adoption of e-tourism*

There are several types of infrastructure which impact on the e-tourism adoption. The unreliable supply of power, as argued by previous studies (Kabanda & Brown 2010; Kapurubandara & Lawson 2006; Karanasios & Burgess 2008; Kshetri 2007; Shrestha et al. 2015) is one of the major concerns. Some of the studies also pointed out that the technological infrastructure such as slow and inadequate telecommunication and internet technologies as well as lower penetration of e-payment cards influence the lower adoption. Appropriate laws



and policies are incorporated as legal infrastructure and they are also of concern and influence the e-commerce adoption (Dhami 2015; Hunaiti et al. 2009; Shemi 2013; Zaiid 2012).

Table 2. Proposed e-Tourism adoption factors in developing countries

Category	Factor	Description
Environmental Factors	<b>National Infrastructure</b>	
	Electricity	Availability of electricity in the country.
	Financial	Condition and readiness of financial institutions for the adoption.
	Technological framework	Situation of country regarding technical resources such as status of internet, digital divide, e-readiness.
	Legal framework	National status of country regarding laws relating to e-commerce.
	<b>Market Forces</b>	
	Market forces e-readiness	Degree to which market and organisations partners such as customers are ready for e-commerce adoption.
	Pressure from competitors	Pressure to adopt e-commerce because of competitors adopting e-commerce or similar technologies.
	<b>Supporting IT Industry</b>	
	IT organizations	Readiness, capability and status of IT organisations to implement
	<b>Socio-cultural Factors</b>	
	Language	The language used for technology and lack of knowledge about it.
	Culture	Culture of the country such as tradition, ways of doing things.
	<b>Context of the Country</b>	
	Condition of country	Political situation of country and its effect on e-commerce adoption.
Plan and policies	Plans and policies of government relating to technology.	
Incentives from government	Incentives and motivation provided by government for the adoption.	
Organizational Factors	<b>Awareness</b>	
	Owner's knowledge and information about e-commerce and its benefits and usage.	
	<b>Resources</b>	
	Skill & Human resource	Human skills and other skills to implement e-commerce.
	Cost of resource	Initial and operational required for e-commerce.
	Technological	Technological resources such as hardware and software.
	<b>Security</b>	
	Lack of trust	Confidence that using e-commerce is safe and trustworthy.
	Privacy	Concern about of the privacy and data misuse.
	<b>Value proposition</b>	
Perceived benefits	Expected benefits of using e-commerce in the organisation.	
Relative Advantage	Degree to which an innovation is perceived as better than existing	
<b>Owner or Top Management</b>		
Owner support	The degree of owner's commitment and encouragement to use.	
Background and knowledge	Owner's information and knowledge about e-commerce.	

H2: The market forces for tourism industry has a positive influence on e-tourism

The market size and its potentials are attractive and conducive to adopt new ICT tools (Ahmad & Agrawal 2012; El-Nawawy & Ismail 1999; Molla & Licker 2005). Similarly, a pressure from

competitors also positively motivates to adopt e-commerce (Chen & McQueen 2008; Chong & Pervan 2007; Hitt & Brynjolfsson 1997; Simpson & Docherty 2004).

*H3: Supporting industries negatively influence the adoption of e-tourism*

The readiness of supporting industries to support, facilitate and their ability to provide services is crucial for e-commerce adoption (Kabanda & Brown 2010). E-commerce implementation requires coordination with IT companies. Better support from the IT vendor results into higher e-commerce adoption (Ghobakhloo et al. 2011).

*H4: Socio-cultural factors negatively influence the adoption of e-tourism*

Each society is characterised by own values and norms which makes it unique. These different types of culture in different countries and regions also impacts how e-commerce is adopted (Chong et al. 2009; Saffu et al. 2008; Thatcher et al. 2006). Nepal is a country which is diverse and rich in culture (Shrestha et al. 2015) and its influence in the adoption of e-commerce is also important to investigate.

*H5: The lack of government incentives discourages SMTEs to adopt e-tourism*

Nepal has been going through unstable political situation for more than a decade. Unstable government and political situation deter the adoption of e-commerce (Al-Weshah & Al-Zubi 2012; Kapurubandara & Lawson 2006) whereas some studies demonstrated that the support and incentives from the government have encouraged the adoption of the technologies (Al-Weshah & Al-Zubi 2012; Karanasios & Burgess 2008; Cameron & Quinn 2005).

*H6: Awareness of e-commerce has positively influenced the adoption of e-tourism*

As awareness has been found to be one of the common factors influencing e-commerce in several studies (Hunaiti et al. 2009; Karanasios & Burgess 2008; Kshetri 2007; Molla & Licker 2005; Zaied 2012), the correlation between awareness and its influence on e-commerce adoption by SMTEs of Nepal is evaluated.

*H7: The lack of resources in SMTEs of Nepal, negatively influences the adoption of e-tourism*

Resources include human resources, resources related to cost, technological resources, and other business resources. Kapurubandara and Lawson (2006) and Al-Weshah and Al-Zubi (2012) stated that lack of skills is one of the most important barriers of e-commerce adoption. Among others, cost of resources is another major influencer in regards to the adoption (Datta 2011; Karanasios & Burgess 2008; Kartiwi & MacGregor 2007; Shrestha et al. 2015; Uzoka & Seleka 2006; Zaied 2012).

*H8: The digital security concerns among owners of SMTEs in Nepal discourages the e-tourism*

Due to intangible nature of internet operations, people are fearful of being victim to internet frauds. Trust and confidence are found to be essential for e-commerce (Lawrence & Tar 2010). Buhalis & Jun (2011) assert that in the tourism industry, lack of trust inhibits buying and selling activities and expressed their concerns about paperless and faceless transactions in the online arena.

*H9: The value proposition is positively related to the adoption of e-tourism*

The perceived benefit refers to the expectation that specific benefits will be achieved by practising specific action or behaviour. Pearson and Grandon (2004) argue that if organisation perceives that e-commerce increases the managerial productivity and support strategic decisions, then it may be adopted. Relative advantage is the degree to which an innovation is perceived as better than the existing idea or system it supersedes (Rogers 2010). Various studies have indicated relative advantage as one of the factors influencing e-commerce adoption (Ahmad et al. 2015; Brdese 2013; Dwivedi et al. 2009; Grandon & Pearson 2004).

*H10: Owner’s support has positively influenced the adoption of e-tourism*

Top level manager or owner’s commitment is one of the most important factors found in many studies. They have indicated that manager’s knowledge of e-commerce and commitment to adopt e-commerce have a considerable bearing on adoption decision (Al-Weshah & Al-Zubi 2012; Kapurubandara & Lawson 2006; Karanasios & Burgess 2008; Shemi 2013). In addition to manager’s perspective, the characteristic or knowledge of manager about e-commerce is also an important factor (Brdese 2013).

Based on the proposed hypotheses, we present our research model in Figure 1. Next we discuss research methodology.

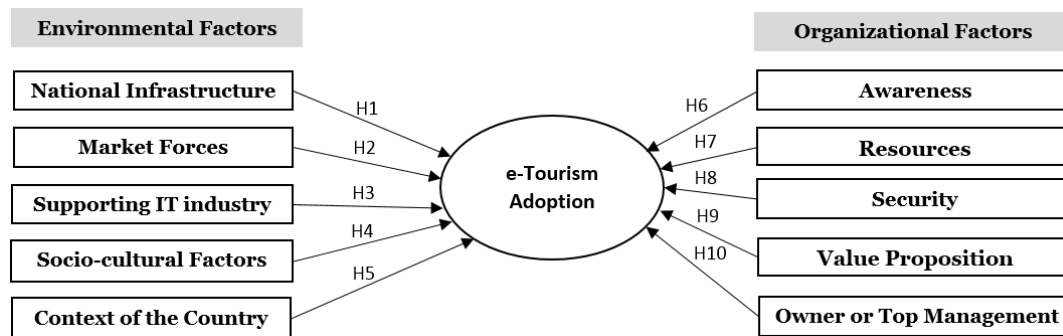

Figure 1. Research model on e-tourism adoption for developing countries

## 5 Research Methodology

This research uses mixed methods - qualitative and quantitative approaches to collect data through interviews and surveys with representatives of tourism associations and SMTEs in Nepal. The validation in this research has been done in two stages, first through content analysis from the semi-structured interview (qualitative) and then through statistical analysis from the survey (quantitative). The triangulation of multiple methods for data collection and analysis enhance interpretability, reliability and internal validity making results more robust (Creswell & Clark 2011).

The first sets of factors are derived from the relevant literature as presented in Figure 2. Then semi-structured interviews were conducted with seven representatives of the major stakeholders. Three major associations, one semi-government body, two tourism organizations, and a related stakeholder from the government were selected for the interview. The objectives of the interviews were to i) validate the proposed factors and the conceptual model (Figure 2) ii) and add new factors which may be relevant in the context of Nepal. The respondents were selected through purposive or judgmental sampling technique. Purposive sampling is a type of non-probability sampling and informant selection tool, through which informants are chosen non-randomly based on the qualities the informant possesses such as knowledge or experience (Tongco 2007).

Most of the reported factors are found to be consistent with the factors compiled from the literature review. After the content analysis of interview data, two new sub-themes: *Resistance to Change* and *Awareness of Social Media*, were added. These new sub-themes were classified under existing factors. Questionnaire related to ‘resistance to change’ was added to “Socio-cultural factors” and whereas ‘awareness of social media’ is included in the factor “Awareness”.

The survey questionnaire was distributed to 250 SMTEs of Nepal using a random sampling method to validate the factors, from which 198 SMTEs (almost 80 %) responded. The composition of SMTEs consists of 98 tour and travel agencies (almost 50 %), 72 trekking agencies (36 %) and 28 small hotels (14 %).

Through the quantitative data, hypothesis testing was used to validate the factors and the conceptual model. The hypotheses have been set up to check the relationship between different factors and e-tourism adoption by SMTEs. The hypotheses were formulated based

on the factors identified through literature reviews and semi-structured interviews. The five-point Likert scale is used in the survey questionnaire. The highest scale 5 represented 'strongly agree', the next scale 4 'agree', 3 'neutral', 2 'disagree' and 1 'strongly disagree' respectively. SPSS was utilized for the statistical analysis of the quantitative data. The binary logistic regression method was used to test the hypotheses because of the binary nature of dependent variable i.e. e-tourism adoption. Reliability and validity checks were performed to ensure the consistency and quality of the data.

## 6 Analysis and Results

### 6.1 Reliability Analysis

The Cronbach's alpha is typically used to assess the internal consistency of the factors in the model (Hair et al. 2006). The Cronbach alpha of greater than 0.60 is acceptable and reliable for exploratory research, and greater than 0.70 is recommended for the confirmatory research (Straub et al. 2004). The table below shows the reliability of the survey data.

Table 3. Reliability Test of Survey Data

Environmental Factors	Cronbach $\alpha$	Organizational Factors	Cronbach $\alpha$
National Infrastructure	0.759	Awareness	0.851
Market Forces	0.722	Resources	0.842
Supporting IT Industry	0.721	Security & Trust	0.787
Socio-cultural Factors	0.788	Value Proposition	0.760
Context of the Country	0.718	Owner or Top Management	0.723

### 6.2 Hypothesis Testing Results

The factors explored in this study are independent variables, and the adoption of e-tourism is the dependent variable. We used binary regression to investigate the relation between the independent and dependent variable. The hypothesis which investigates the effect of various factors on e-tourism has been examined.

The significance value ( $p < 0.05$ ) indicates that the factors are significant in the model. After the analysis, three environmental factors (lack of infrastructure, market size and lack of support from the government from the context of the country) and four organizational factors (awareness, lack of resources, value proposition and top management support) were found to be significant in e-tourism adoption by SMTEs of Nepal. The two environmental factors (supporting IT industry and socio-cultural factors), as well as one organizational factor (security concern), were found to be non-significant.

The result of binary regression for the proposed model is presented in Table 4.

Table 4. Binary Regression Results

Factor	$\beta$	S.E.	Wald	df	Sig.(p value)	Exp(B)	Result
Lack of National Infrastructure	-.486	.236	4.243	1	.039 (<0.05)	.615	Supported
Market	.651	.255	6.525	1	.011 (<0.05)	1.918	Supported
Supporting IT Industry	.411	.251	2.674	1	.102 (>0.05)	1.509	Not Supported
Socio-cultural	.029	.221	.017	1	.896 (>0.05)	1.029	Not Supported
Context of the Country	-.436	.201	4.711	1	.030 (<0.05)	.646	Supported
Awareness	.525	.259	4.118	1	.042 (<0.05)	1.691	Supported
Lack of Resources	-.997	.269	13.765	1	.000 (<0.05)	.369	Supported
Security Concerns	-.102	.257	.158	1	.691 (>0.05)	.903	Not Supported
Value Proposition	.889	.283	9.890	1	.002 (<0.05)	2.433	Supported
Owner or Top management	1.117	.318	12.351	1	.000 (<0.05)	3.055	Supported

The lack of national infrastructure shows that lack of electricity, technological resources, financial infrastructure and laws have negatively impacted the adoption. Similarly, the contextual factors such as lack of government policies and incentives, the condition of the

country are also found to be affecting the adoption negatively. The market forces are found to be encouraging the e-tourism adoption. The awareness of the e-tourism and social media is found to be positively impacting the adoption. The value proposition factors such as perceived benefits are also found to be encouraging the adoption. Similarly, the owner or top management's support is also positively linked to the adoption. However, the lack of resources in organizations is found to be negatively influencing the e-commerce adoption. The impact of supporting IT industry, socio-cultural factors and security concerns were not supported.

## 7 Conclusions & Implications

The tourism sector received significant attention in the academic literature, however, limited research investigated e-tourism adoption in the developing countries such as the case in Nepal. This study added some insights in this area by identifying some key factors that are often been neglected in developing country's perspective. The results show that e-commerce adoption by SMTEs is affected by environmental factors: lack of national infrastructure, market size, and contextual factors (government's support) and organizational factors: awareness, lack of resources, value proposition and top management or owner's support.

Our study explored the need for significant government intervention in creating a facilitating infrastructure for e-tourism in Nepal. The tourism industry contributes a significant portion to the GDP and therefore, it is imperative that the policymakers address the fundamental factors (i.e. government incentives, resource capabilities and national infrastructure) identified in this research. Also, research on e-commerce adoption by tourism organizations in Nepal is in the infancy stage and this study aids for the progression in such discourse.

## 8 References

- Ahmad, I. & Agrawal, A.M. 2012, 'An empirical study of problems in implementation of electronic commerce in Kingdom of Saudi Arabia', *International Journal of Business and Management*, vol. 7, no. 15, p. 70.
- Ahmad, S.Z., Abu Bakar, A.R., Faziharudean, T.M. & Mohamad Zaki, K.A. 2015, 'An empirical study of factors affecting e-commerce adoption among small-and medium-sized enterprises in a developing country: Evidence from Malaysia', *Information Technology for Development*, vol. 21, no. 4, pp. 555-72.
- Ajzen, I. & Fishbein, M. 1980, 'Understanding attitudes and predicting social behaviour'.
- Al-Weshah, G.A. & Al-Zubi, K. 2012, 'E-business enablers and barriers: empirical study of SMEs in Jordanian communication sector', *Global Journal of Business Research*, vol. 6, no. 3, pp. 1-15.
- Brdesee, H.S. 2013, 'Exploring factors impacting e-commerce adoption in tourism industry in Saudi Arabia', RMIT University Melbourne, Australia.
- Buhalis, D. & Jun, S.H. 2011, 'E-tourism', *Contemporary tourism reviews*, pp. 01-38.
- Buhalis, D. & Law, R. 2008, 'Progress in information technology and tourism management: 20 years on and 10 years after the Internet—The state of eTourism research', *Tourism management*, vol. 29, no. 4, pp. 609-23.
- Cameron, K.S. & Quinn, R.E. 2005, *Diagnosing and changing organizational culture: Based on the competing values framework*, John Wiley & Sons.
- Chen, J. & McQueen, R.J. 2008, 'Factors affecting e-commerce stages of growth in small Chinese firms in New Zealand: an analysis of adoption motivators and inhibitors', *Journal of Global Information Management (JGIM)*, vol. 16, no. 1, pp. 26-60.
- Chong, A.Y.L., Ooi, K.B., Tak, Y.K. & ShuYang, Z. 2009, 'Factors affecting the adoption of e-commerce: a study of the textile industry in Wujin, China', *International Journal of Business and Management Science*, vol. 2, no. 2, p. 117.
- Chong, S. & Pervan, G. 2007, 'Factors influencing the extent of deployment of electronic commerce for small-and medium-sized enterprises', *Consumer Behavior, Organizational Development, and Electronic Commerce: Emerging Issues for Advancing Modern Socioeconomies*.

- Creswell, J.W. & Clark, V.L.P. 2011, 'Designing and conducting mixed methods research', 2 ed.
- Datta, P. 2011, 'A preliminary study of ecommerce adoption in developing countries', *Information Systems Journal*, vol. 21, no. 1, pp. 3-32.
- Davis, F.D. 1989, 'Perceived usefulness, perceived ease of use, and user acceptance of information technology', *MIS Quarterly*, pp. 319-40.
- Dhami, A.M.C. 2015, 'Trends of Cybersecurity Threats in Nepal: Law Enforcement Experience', paper presented to the Cybersecurity: Challenges and solutions for developing economies, Kathmandu, <<http://www.itconference.org.np/presentations/Trends of Cybersecurity Threats in Nepal - Law Enforcement Experience.pdf>>.
- Dwivedi, Y.K., Papazafeiropoulos, A. & Scupola, A. 2009, 'SMEs'e-commerce adoption: perspectives from Denmark and Australia', *Journal of Enterprise Information Management*, vol. 22, no. 1/2, pp. 152-66.
- El-Nawawy, M.A. & Ismail, M.M. 1999, 'Overcoming deterrents and impediments to electronic commerce in light of globalisation: the case of Egypt', 9th Annual Conference of the Internet Society, INET, vol. 99.
- Ghobakhloo, M., Arias-Aranda, D. & Benitez-Amado, J. 2011, 'Adoption of e-commerce applications in SMEs', *Industrial Management & Data Systems*, vol. 111, no. 8, pp. 1238-69.
- Gonzalo, F. 2014, 8 Etourism Stats to Consider for 2015, <<http://fredericgonzalo.com/en/2014/10/16/8-etourism-stats-to-consider-for-2015/>>.
- Grandon, E.E. & Pearson, J.M. 2004, 'Electronic commerce adoption: an empirical study of small and medium US businesses', *Information & management*, vol. 42, no. 1, pp. 197-216.
- Hair, J.F., Black, W.C., Babin, B.J., Anderson, R.E. & Tatham, R.L. 2006, 'Multivariate data analysis (Vol. 6): Pearson Prentice Hall Upper Saddle River', NJ. 連結.
- Hitt, L.M. & Brynjolfsson, E. 1997, 'Information technology and internal firm organization: An exploratory analysis', *Journal of Management Information Systems*, vol. 14, no. 2, pp. 81-101.
- Hunaiti, Z., Masa'deh, R., Mansour, M. & Al-Nawafleh, A. 2009, 'Electronic commerce adoption barriers in small and medium-sized enterprises (SMEs) in developing countries: the case of Libya', *IBIMA Business Review*, vol. 2, no. 5, pp. 37-45.
- Kabanda, S. & Brown, I. 2010, 'Factors That Affect e-Commerce Adoption in Tanzanian SMEs', *International Conference on Information Management and Evaluation, Academic Conferences International Limited*, p. 153.
- Kapurubandara, M. & Lawson, R. 2006, 'Barriers to Adopting ICT and e-commerce with SMEs in developing countries: an Exploratory study in Sri Lanka', *University of Western Sydney, Australia*.
- Karanasios, S. & Burgess, S. 2008, 'Tourism and internet adoption: a developing world perspective', *International Journal of Tourism Research*, vol. 10, no. 2, pp. 169-82.
- Kartiwi, M. & MacGregor, R.C. 2007, 'Electronic commerce adoption barriers in small to medium-sized enterprises (SMEs) in developed and developing countries: A cross-country comparison', *Journal of Electronic Commerce in Organizations (JECO)*, vol. 5, no. 3, pp. 35-51.
- Kshetri, N. 2007, 'Barriers to e-commerce and competitive business models in developing countries: A case study', *Electronic Commerce Research and Applications*, vol. 6, no. 4, pp. 443-52.
- Lawrence, J.E. & Tar, U.A. 2010, 'Barriers to e-commerce in developing countries', *Information, society and justice journal*, vol. 3, no. 1, pp. 23-35.
- Ministry of Information and Communication, G.o.N. 2015, 'National Information and Communication Technology Policy, 2015', in G.o.N. Ministry of Information and Communication (ed.) Kathmandu, <<http://www.nta.gov.np/en/component/joomdoc/ICT Policy.pdf/download>>.
- Ministry of Science and Technology, G.o.N. 2000, 'Information Technology Policy 2000', in G.o.N. Ministry of Science and Technology (ed.) Kathmandu, <[http://moste.gov.np/it\\_policy\\_2057\\_\(2000\\_ad\)](http://moste.gov.np/it_policy_2057_(2000_ad))>.

- Ministry of Science and Technology, N. 2008, 'The Electronic Transactions Act, 2008', in N. Ministry of Science and Technology (ed.) Ministry of Science and Technology, Nepal, Kathmandu, <[http://moste.gov.np/elec\\_tran\\_act](http://moste.gov.np/elec_tran_act)>.
- Molla, A. & Licker, P.S. 2005, 'Perceived e-readiness factors in e-commerce adoption: An empirical investigation in a developing country', *International Journal of Electronic Commerce*, vol. 10, no. 1, pp. 83-110.
- Pearson, J.M. & Grandon, E. 2004, 'E-commerce adoption: perceptions of managers/owners of small and medium sized firms in Chile', *The Communications of the Association for Information Systems*, vol. 13, no. 1, p. 46.
- Rogers, E.M. 2010, *Diffusion of innovations*, Simon and Schuster.
- Rowe, F., Truex, D. & Huynh, M.Q. 2012, 'An empirical study of determinants of e-commerce adoption in SMEs in Vietnam: An economy in transition', *Journal of Global Information Management (JGIM)*, vol. 20, no. 3, pp. 23-54.
- Saffu, K., Walker, J.H. & Hinson, R. 2008, 'Strategic value and electronic commerce adoption among small and medium-sized enterprises in a transitional economy', *Journal of Business & Industrial Marketing*, vol. 23, no. 6, pp. 395-404.
- Samimi, A.J., Sadeghi, S. & Sadeghi, S. 2011, 'Tourism and economic growth in developing countries: P-VAR approach', *Middle-East Journal of Scientific Research*, vol. 10, no. 1, pp. 28-32.
- Scupola, A. 2003, 'The adoption of Internet commerce by SMEs in the south of Italy: An environmental, technological and organizational perspective', *Journal of Global Information Technology Management*, vol. 6, no. 1, pp. 52-71.
- Shemi, A.P. 2013, 'Factors affecting e-commerce adoption in small and medium enterprises: An interpretive study of Botswana', University of Salford.
- Shrestha, D., Bhattarai, B., Kwon, D.Y. & Jeong, S.R. 2015, 'The Prospect and Challenges of ICT in Tourism Industry of Nepal', paper presented to the KSII The 7th International Conference on Internet (ICONI) 2015., Malaysia.
- Simpson, M. & Docherty, A.J. 2004, 'E-commerce adoption support and advice for UK SMEs', *Journal of small business and enterprise development*, vol. 11, no. 3, pp. 315-28.
- Straub, D., Boudreau, M.-C. & Gefen, D. 2004, 'Validation guidelines for IS positivist research', *The Communications of the Association for Information Systems*, vol. 13, no. 1, p. 63.
- Thatcher, S.M., Foster, W. & Zhu, L. 2006, 'B2B e-commerce adoption decisions in Taiwan: The interaction of cultural and other institutional factors', *Electronic Commerce Research and Applications*, vol. 5, no. 2, pp. 92-104.
- Tongco, M.D.C. 2007, 'Purposive sampling as a tool for informant selection', *Ethnobotany Research and Applications*, vol. 5, pp. 147-58.
- Tornatzky, L.G. & Fleischer, M. 1990, *Processes of technological innovation*, Lexington Books.
- UNDP, U.N.D.P. 2017, 'Human Development Report', <<http://hdr.undp.org/en/countries/profiles/NPL>>
- UNWTO 2017, *Tourism and the world economy, in the Facts and Figures*, World Tourism Organization, 2016, <<http://www.unwto.org/index.php>>.
- Uzoka, F.-M.E. & Seleka, G.G. 2006, 'B2C e-commerce development in Africa: case study of Botswana', *Proceedings of the 7th ACM conference on Electronic commerce*, ACM, pp. 290-5.
- Venkatesh, V. & Davis, F.D. 2000, 'A theoretical extension of the technology acceptance model: Four longitudinal field studies', *Management science*, vol. 46, no. 2, pp. 186-204.
- Venkatesh, V., Morris, M.G., Davis, G.B. & Davis, F.D. 2003, 'User acceptance of information technology: Toward a unified view', *MIS quarterly*, pp. 425-78.
- World Travel and Tourism Council, W. 2017, *Travel and Tourism Economic Impact 2016*, London, UK. <<https://www.wttc.org/-/media/files/reports/economic-impact-research/countries-2017/nepal2017.pdf>>

Zaied, A.N.H. 2012, 'Barriers to e-commerce adoption in Egyptian SMEs', *International Journal of Information Engineering and Electronic Business*, vol. 4, no. 3, p. 9.



# An Integrated Information Retrieval Framework for Managing the Digital Web Ecosystem

## Dengya Zhu

School of Management, Information Systems  
CBS, Curtin University, Perth, WA, Australia  
Email: d.zhu@curtin.edu.au

## Shastri L Nimmagadda

School of Management, Information Systems  
CBS, Curtin University, Perth, WA, Australia  
Email: shastri.nimmagadda@curtin.edu.au

## Torsten Reiners

School of Management, CBS  
Curtin University, Perth, WA, Australia  
Email: T.Reiners@cbs.curtin.edu.au

## Abstract

The information explosion constrains the Digital Web Ecosystem exploration and makes challenging in retrieving relevant information and knowledge using Web search tools. The existing tools are not well integrated, and search results are inadequately managed. In this article, we describe effective information retrieval services for users and agents in various digital Web ecosystem scenarios. A novel Integrated Information Retrieval Framework (IIRF) is proposed, which employs the Web search technologies and traditional database searching techniques to provide comprehensive, dynamic, personalized, and organization-oriented information retrieval services, ranging from the Internet, intranet, to personal desktop. Experiments are carried out demonstrating the improvements in the search process with an average precision of Web search results to standard 11 recall level, attaining improvement from 41.7% of a comparable system to 65.2% of search. A 23.5% precision improvement is achieved with the framework. The comparison made among search engines presents similar development with satisfactory search results.

**Keywords:** digital ecosystem, information retrieval, information management, search engine, crawler

## 1 Introduction

The digital ecosystem (Gartner 2017) is an interdependent group of elements or processes, such as entities and or dimensions, more specifically people, enterprises, who share standardized digital content on various platforms that are mutually beneficial. Accenture (Moore et al. 2018) finds in a survey with more than 3000 executives that “digital ecosystems are transforming the way their organizations deliver value”. However, data in digital ecosystems are distributive, complex, heterogeneous, and multidimensional (Barrows and Traverso 2006). In other words, they have all the features that big data do, that is, the volume of the data generated per hour in digital ecosystems ranges from megabytes to gigabytes to terabytes; tens of thousands of bytes of data transported per seconds, demonstrating velocity of data. The data format varies as per varieties, from emails to instant messages to images to streaming data and more.

Because of the complexity in digital ecosystems, and their data sources, management information systems need improvements, creating scopes for better information retrieval methods and search functions, adaptable to a new information-access era. Searches need highly specialized search tools and formulations in addition to the presentation of search results in a way they can better be interpreted and analysed. Multiple information scenarios of digital ecosystems make businesses shifting their focus to new flexible, re-configurable, and collaborative business paradigm, and consequently, they should adapt to digitalization trends, and strive to leverage their data in competitive advantage. With the vast amount of data in hand, one of the distinct steps for organizations is to facilitate the data search process by easing the complexity of digital ecosystems. For example, Commonwealth Bank of Australia (CBA) developed an app that assists users to search properties that they are interested in with sale price history as well as similar information of other properties nearby, and then with mortgage link points to CBA. After six months, consumers made more than 1.2 million property searches, and the app’s return on investment is 109% (Weill and Woerner 2015).

Many enterprise-level search tools/platforms exist for exploring digital ecosystems (Barrows and Traverso 2006). *Search engines*, such as the Apache Solar and Lucene (McCandless et al. 2010) are typical examples of types, which provide services at an enterprise level, such as distributed indexing/searching with high scalability, availability, and extensibility. The customized version may include an entity extractor, thesaurus, classification, filtering and other characteristics. *Desktop search* that focuses on retrieving local files resides in personal desktop computers, messages, emails, Web history, is another type of searching tool. The third type of such gadget is an *intranet search* engine which crawls information from servers within an intranet to local networks. For resolving enterprise-scale problems, a search engine should support and combine tagging, categorization, and navigation tools to improve the end user experience. An enterprise metadata category – ontology-based metadata – can be built to define a metadata schema, to index a set of documents, and write a user interface for querying and displaying results. Even though automatic metadata extraction is never perfect, a user interface is needed to allow amendments and re-use of the metadata. In addition, the system should satisfy scalability, security, metadata update, view privilege, and query (search-term) optimization criteria (Albro 2006). The challenges are identified from the existing literature (Croft et al. 2015) and the search tools.

## 2 The Existing Issues and Challenges

The information retrieval is challenging, and there are still some big issues need to be addressed (Croft et al. 2015), because of information explosion, low accuracy, search results are improperly managed, mismatching human-computer interaction with clustered results. An active information retrieval service is needed for users in various digital ecosystems. In digital ecosystems, other challenges include inadequately integrated domains, systems and their associated data sources. The current challenges of documentation of data sources and information search are briefly summarized in the following sections.

*Integrated search tools:* In addition to the general purpose Web search engines, such as Google, Bing and Yahoo, specific search tools and functions exist, for example, desktop, music, language-specific searches, and specific full-text database with bibliographic searching. The specific tools provide a more effective search for a particular domain or field, as compared with the general purpose search engines. Information seekers must install the tools on their computers, and then match the search tools/functions with their information retrieval needs. The process may involve considerable trial and error and investment in learning a variety of systems. Substantial resources are used such as time,

memory, disk space, and processing power, in particular, accessing the high-resolution images. An integrated search framework that can collaborate search function and repository access tools can facilitate resolving the issues, easing information retrieval from search engines.

*The syntactic-based search not necessary semantic centric:* The searching is syntactical but not semantic based, and search results are not properly personalized. Web search engines look for factual similarities between search-terms and the web-pages (Arasu et al. 2001). Search engines crawl websites from the Internet and download web-pages from various sites. Idioms or phrases are accordingly indexed, stemmed, removing the stop-words in the web-pages. High-level dimensionality document is created as per the content of the web-pages. A number of indexed terms determines the dimensionality. This vector represents different patterns of search-terms. Accordingly, similarities between search-terms and their knowledge including document vectors are calculated and ranked. During this process, the semantic characteristics and issues of search-terms are not fairly involved. As an example, it is not a surprise when using “UPS” as a search term to retrieve information about the “Uninterruptible Power Supply” that may return irrelevant or ambiguous results such as the “United Parcel Services”.

*Untailored search results:* Most search engines and tools make an effort to return and rank search results, based on general purpose search, where a contextual and personalized search is still not widely considered relevant (Croft et al. 2015). No matter what role a searcher is - a car sales representative, an environmentalist, or a computer technician - if they use the same query “jaguar”, they get the same search results. However, submitting the search-term, the sales representative thinks of the “jaguar” car and not anything else. The environmentalist seeks information about the animal jaguar, whereas the technician thinks of using the Apple’s Jaguar as an operating system. The general purpose search tools thus need improvement to get quality and relevant search results. Although some search engines provide personalized results, the precision still a concern (Croft et al. 2015).

*Enterprise-level search personalization:* The customization and personalization features go hand-in-hand. Personalization must deliver the content and functionality that match the specific users’ needs, what they look for in search of innovative and new terminologies. Netflix is an example, which has established a market with the adaptability of user views and search-terms. Without any clue of search terms, a majority of search engines return and rank search results, based on general purpose search after a user submit a keyword, where personalized search is not considered (Arnold 2004). The keywords may be the characteristic of human language, although the keyword queries are inherently ambiguous. For example, keyword “jaguar” may mean 1) a car for a car seller; 2) an animal for an environmentalist and 3) an operating system for a technician. The personalized Web search tools and models are taken advantage of, even though development of the search tool is still in its initial stages that may need the attention of real-world applications.

*Integrated holistic enterprise-level search engine:* Enterprise software applications typically hold their search functions. More popular Gmail, Microsoft Outlook and other email services have built-in search functions. Microsoft SharePoint built-in search allows users to search SharePoint pages. Nevertheless, users in an enterprise need to frequently change several portals and explore different parts of data available in the enterprise.

The research gaps are identified through critical analysis of the existing facts of search tools (Zhu and Dreher 2007), diligently providing evidence and substantiating the results. Further, we examine them by exploring and framing research questions and objectives with problem solutions.

### **3 Research Questions and Objectives**

Based on the current information retrieval challenges, we design the research question and objective. Research questions (RQ): (1) Design and develop a framework in search of structured and unified information (2) How do we accomplish information search in complex digital Web ecosystems and analyse their results, using the latest search engines and tools. The research objectives (RO): (1) Develop an integrated information retrieval framework that can deal with the search engines and (2) Analyse the search results to claim that the research performs well with user satisfaction.

### **4 Research Goal, Motivation and Significance**

The goal is to design and develop a framework to search for unified information and validating the framework through series of experiments with supported performances. Another research goal is to generate structured textual data that can be shared between different search engines and the type of framework needed for such unified information. Increased search efforts and outcomes of terms searched in various contexts is the motivating factor for exploring and exploiting new framework. Keeping in view the user needs, variety of search engines and options, a need for more generic framework is felt. Activation, persistence and intensity of search terms and their outcomes usable by type of users motivate us to develop new search articulations. Connecting and trending of events between contexts are the other motivations. The implication, relevance and quality of articulations in the current contextual applications, all describe the significance of research. The current research is made significant to academicians, IT/IS researchers and data management personnel. Integrated methodological framework can risk minimize the economics involved in exploring new information and knowledge through interfaces and desktop integration. Based on the experiences with IT/IS companies, the authors experience pitfalls at various stages and chains of search engines, especially keeping in view the heterogeneity and multidimensionality of data sources relevant to industry scenarios.

## 5 An Integrating Search Framework

Figure 1 illustrates an Integrating Information Retrieval Framework (IIRF), proposed for digital ecosystem representation, articulated with various artefacts. It is detailed in the following sections.

### 5.1 Information streams

When users submit search requests, search-terms match with information from diverse sources including the Internet, intranets, full-text databases, databases of digital ecosystems, and personal desktop computers. The similarities are compared between search results, and the categories are sorted through adaptable ontologies associated with digital ecosystems. The similar and dissimilar items, obtained from different sources are clustered. The search processes are described in the following sections, with the functionality of each component, as explained in Figure 1. The framework is divided into four main parts, namely, information streams and sources; query or search-term expansion; search results categorizing/clustering and filtering; and personalized search results representation. The components are described in the following sections.

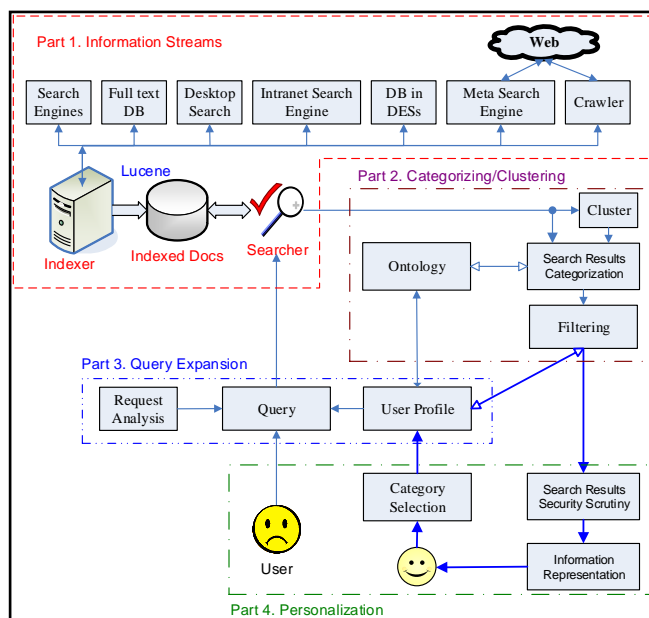

Figure 1: An integrating information retrieval framework (IIRF)

*Search process:* A programmable script is designed as a crawler for browsing the World Wide Web. Currently, the crawlers emerge with large-size scripts, complexity and rapid growth of the World Wide Web. With the result, the page selection, importance, recency, and refresh options create many challenges. In addition to regular page refresh, crawlers should focus on the effectiveness of crawling. Usually, a crawler starts with an initial set of URLs that are placed in a queue and prioritized. A URL is selected based on some ordering strategies. The crawlers download Web-pages, extract URLs from the downloaded pages, and put the new URLs in the queue, expanding into (crawling) relevant Websites.

This process is repeated until crawlers decide to abort. Prioritizing the URLs in the queue and setting the stop conditions are both related to estimating, or measuring the relevance of the URL content to the semantic need of digital web ecosystems.

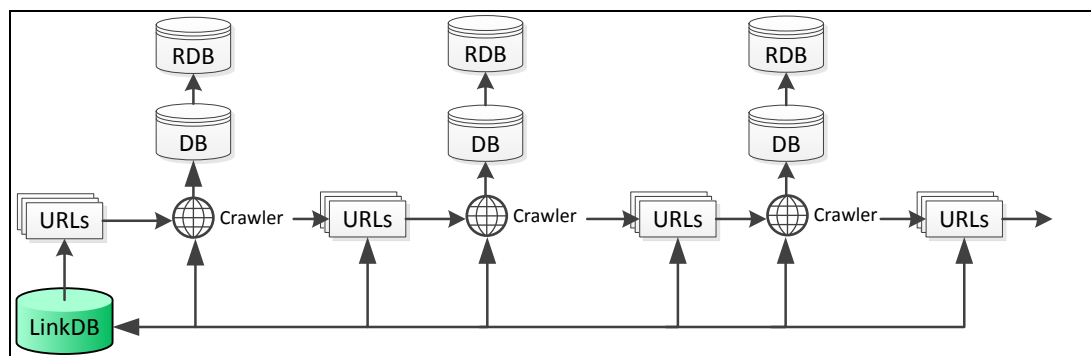

Figure 2: The crawling strategy for the IIRF

As illustrated in Figure 2, the proposed crawling strategy consists of the following stages. Firstly, a set of seed URLs, which contains all relevant websites picked up by ecosystem users, is created and stored in a URL link-database (LinkDB), injecting in the URL list (URLs, also URL Frontier). The seed URL list is adjustable based on users' business requirements. With the seed URLs injected into the URL frontier, a crawler downloads all Webpages in the URLs and stores the extracted content into a database (DB). The content gets indexed by search engine after the documents are preprocessed (stop word removing, stemming, named entity extraction). At the same time, URLs contained in the downloaded webpages are also extracted and then put into LinkDB after duplicate and irrelevant URLs are removed. For all the downloaded webpages in the DB, some of them may not be relevant. Therefore, a document categorization algorithm such as Support Vector Machines, is trained by using existing documents stored in the ecosystem as a training data set. Only the relevant documents moved from DB to relevant database (RDB) are indexed in the RDB.

**Search aggregators:** The users and their adoptable search engines are valued as long as they satisfy the user needs and revenue generated. A generic architecture is needed to match multiple search options and opportunities for Meta integration purposes. A metasearch engine is a system that provides unified access to several existing search engines (Meng et al. 2000). The aggregator in IIRF is based on the following considerations: 1) single search engine's processing power may not scale to the tremendous increase and virtually unlimited amount of data; 2) it is hard or even impossible for a single search engine to index all the data on the Web and keep it up to date; and 3) some 'deep web' sites may not allow their documents to be crawled by external websites, but allow their documents to be accessed by their search engines (Zhu and Dreher 2007).

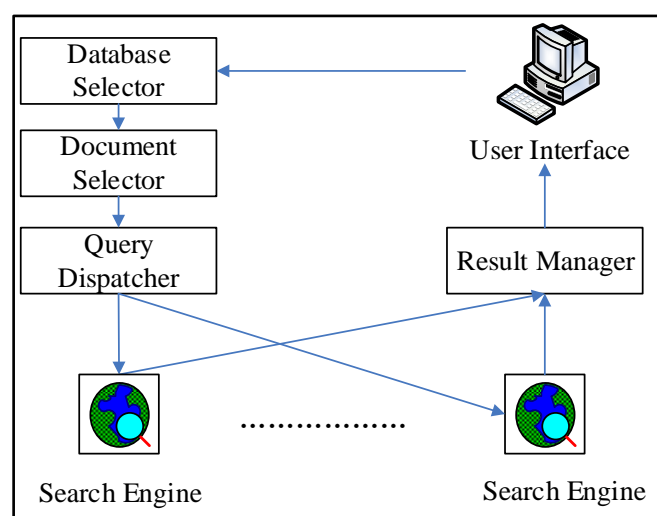

Figure 3: Meta-search engine structure (Meng et al. 2000)

The conceptual architecture of the meta-search engine is illustrated in Figure 3. Meta-search starts with

initializing user query, selecting a set of suitable databases (coupled with search engines) by the database selector. The document selector chooses the number of documents, retrievable from the component search engine. The local similarity threshold is used to limit the documents retrieved from the component search engine. Query dispatcher connects the server with each of the selected search engine, and passes the query to them. Results manager integrates returned results from search engines into a single ranked list and renders it to the user (Meng et al. 2000).

*Reprising databases:* A Relational Data Base Management System (RDBMS) usually manages the existing databases in an enterprise that can be repurposed by IIRF in the digital Web ecosystems. In addition, the RDBMS manages the metadata and other security-sensitive data, which usually provides security and integrity management (Ramez and Navathe 2016). In IIRF, user queries are submitted to RDBMS as well, and the retrieved results from the RDBMS are then presented to the categorization/clustering component for further processing, as illustrated in Figure 1. In addition, the extracted entities such as title, gender, person name, address, email address, organisation, telephone number, mobile phone number and others from text document are stored in the RDBMS. These extracted entities are used to match records of RDBMS, and thus a connection between structured data in RDBMS and unstructured/semi-structured text data can be established, and vice versa. Users of IIRF can search data by providing a Google like search term, and can also search data in the RDBMS.

*Desktop search:* Desktop integration feature must be agreeable among users to share data between applications, sustainable to business leverages. The Google, Microsoft, Yahoo!, and other significant players (Barrows and Traverso 2006) provide free downloaded desktop search solutions. As the storage allows hundreds of gigabytes of data and beyond, the desktop search can significantly make better user productivity. In these models, indexing or tagging can enable users to access information through dynamic integrated navigational retrieval systems. They can act as agents to return pointers or links to the desired information. The plain list representation, and no consideration of semantic aspects, though are drawbacks but overcome by re-organising, ontologically filtering and personalizing the desktop search results.

*Text retrieval:* Text retrieval differs from database probing, in which an exact matching is necessary, and any mismatching among thousands of objects can create an error. However, there is more tolerance for errors, because of information retrieval systems focus on process semi- or unstructured natural language text. The text in such contexts could exhibit ambiguities semantically (Croft et al. 2015). The added difference is that in a full-text retrieval system, the search is about subject or topic information, which involves not only the syntactic interpretation of search-terms and text objects but also the relevance of an object to user information needs. Some open source search engines, such as Lucene are available for full-text search.

*Intranet engine:* Searching for information on the intranet is rather a daunting task, which is addressed by search tools' development companies, such as Google and Thunderstone. Because the performance of intranet search engines differs dramatically, ISYS Search Software vendors suggest that features should be considered carefully, and in IIRF contexts, intranet engine selection is the users' choice.

## 5.2 Search results categorization and clustering

Knowledge-based hierarchical ontologies are considered to manage a vast amount of information. Another method is to arrange the itemized information into different clusters according to their similarities. In this retrieval framework, these two approaches are combined to leverage the advantages of both tactics, as suggested in Chau and Chen (2008).

*Fine-grained ontologies:* The ontologies are created in IIRF to improve the search process, categorizing the search results. The search results are filtered based on the user selection and accordingly classified under the selected category for description and presentation. In IIRF, the Open Directory Project (ODP) is employed as an ontology to present the Web knowledge structure. The semantic characteristics of each category in the ODP are manifested by a category-document that includes the topic of the class, the description of the type, and a list of submitted Web-pages (composed of the title of the Web-pages and a brief description of each of the submitted Web-pages) under this category.

*Categorizing search results:* Undoubtedly, the text categorization is the problem of assigning predefined categories to free text documents (Croft et al. 2015). In IIRF, search results are categorized

based on the ODP as a lightweight ontology. The category-documents in the ODP are employed as a training data set.

Let  $d_j = \{w_{1,j}, w_{2,j}, w_{T,j}\}$  is the  $j$ th category-document, where  $T$  is the total number of vocabulary in IIRF, and  $q = \{w_{1,q}, w_{2,q}, w_{T,q}\}$  is a searched item.  $w_{i,j}$  is the tf-idf weight of  $i$ th term in  $j$ th document,  $w_{i,q}$  is the tf-idf weight of  $i$ th term in the searched item. The similarity between  $q$  and  $d_j$  is estimated by the cosine value of the angle  $\theta$  of the two vectors:

$$\text{sim}(d_j, q) = \cos(\theta) = \frac{d_j \bullet q}{|d_j| \times |q|} = \frac{\sum_{i=1}^T (w_{i,j} \times w_{i,q})}{\sqrt{\sum_{i=1}^T w_{i,j}^2 \sum_{i=1}^T w_{i,q}^2}}$$

The similarities between  $q$  and the  $d_j, j = 1, 2 \dots N$  (where  $N$  is total number of *category-document* in IIRF) are ranked/sorted in their descending order. For top  $K$  ranked *category-documents*, suppose their corresponding ODP category is  $C = \{c_1, c_2 \dots c_K\}$ ,  $q$  is assigned to the category selected from  $C$  by majority voting algorithm.

*Clustering*: Text clustering aims at assembling documents that are related among themselves and satisfy a set of characteristic properties. It can be used to expand a user query with new and related index terms (Croft et al. 2015) and facilitate users to browse the retrieved results. Many clustering algorithms are available, such as the K-mean clustering algorithm, and Fuzzy C-Means. In IIRF, K-mean is chosen to cluster returned search results. Two essential issues of K-means are, how to decide a proper  $K$  and how to select the original  $K$  cluster centres. In IIRF, since the search results are categorized based on the ODP category, the number of the first level categories under which search results are assigned is a suitable candidate for  $K$ . Meanwhile, the search-item which is most similar to the candidate category is assigned to the first centre of the cluster. Cosine similarity (as described above) is utilized to estimate the “likelihood” among neighbouring groups.

*Filtering*: The Google and Facebook introduce personalization features and algorithms that filter information as per user requirements and influence the filtering process. We further analyze filtering processes to show how the personalization can be linked to filtering techniques without any bias of human and computer interaction. Search result filtering is decided in IIRF by two factors: one is the user’s selection of an exciting category of the ontology; another factor is the pre-built user profile that is to be discussed in next section. When a user chooses an interesting category, only search results categorized under this category are presented to the user, and other information is filtered out. However, by default, even if the user does not select a type, the search results are filtered. Based on the pre-built user profile, search results are compared with the features in the pattern; they are re-ranked and then only search results having similar features described by user profiles, are presented to the users.

### 5.3 Expanding and analyzing queries

*User profile and personalization*: A user profile is a reference ontology in which each concept has a weight indicating the user’s interest in that concept (Croft et al. 2015). An information space of the ODP (Pitkow et al. 2002) is used to represent user models. As suggested in Dolog and Nejd1 (2003), the user model combines two proposed standard learner profiles, IEEE Personal and Private Information and IMS Learner Information Package (LIP) to express the features of a user. The precision and recall of metasearch engines are improved through mining association rules that reflect users’ past search behaviour. IIRF cuts off the ODP knowledge from the second level to obtain 573 topics and uses these topics to represent users search interests that are represented by  $\langle \text{topic}, \text{weight} \rangle$  tuples. The user profile is initialized by asking users to assign a weight (integer) to an existing topic to indicate how much interesting the topic is. Users are allowed to choose any number of interesting topics. To map a user search interest into these topics, for each search result  $r_i$  visited by a user, let  $c_i$  is the topic, as detailed in Section 2, the corresponding weight of  $c_i$  in the tuple is increased.

*Query and request analysis*: Query augmentation and result processing are two primary uses of user profiles. In IIRF, after a user selects an OPD topic, query augmentation is an alternative, which allows

the user to re-submit the query  $q_+ = q \cup \{t_k, k = 1, 2 \dots K\}$ , where  $q$  is the query submitted by the user,  $t_k$  is the term selected using

$$\lambda^2 = \frac{N[P(t_k, c_i)P(\bar{t}_k, \bar{c}_i) - P(t_k, \bar{c}_i)P(\bar{t}_k, c_i)]^2}{P(t_k)P(\bar{t}_k)P(c_k)P(\bar{c}_k)}$$

Where  $N$  is the 573 topics in user profile. These topics are now represented by *category-document*.  $P(t, c)$  is the joint probability of term  $t$  and category  $c$ ,  $\bar{c}$ ,  $\bar{t}$  indicates  $c$  or  $t$  does not appear respectively.  $K$  is number of terms determined by the confidence  $P(\lambda^2 > 10.83) < 0.001 = 99.9\%$  that the assumption of independence of the term  $t_k$  and  $q$  can be rejected (Manning et al. 2008).

## 5.4 Representing personalized search results

*Information representation:* In IIRF, search results are obtained from the traditional database, full-text database, intranet, Internet, and desktop searches - all results are integrated into one coherent information representation. Users of the basic search framework can choose which data sources are to be used, from which the needed information is retrieved. The IIRF permits users to set the search scope and thus provide the flexibility to access data sources to satisfy their information needs. Search results come from the Web and Intranet are categorized into a domain-oriented knowledge structure (Zhu and Dreher 2007).

*Search results from security scrutiny:* The component under development, performs a search result. A security scrutiny task concerns “who is allowed to update a piece of metadata and view a particular piece of metadata about a document (or know that the document exists at all)” (Barrows and Traverso 2006).

## 6 Experimental Results

*Evaluation measurements:* The two widely accepted measurements of information retrieval effectiveness are precision and recall. Recall measures the ability of an information retrieval system to retrieve all relevant documents; accuracy measures the ability of an information retrieval system to extract only relevant material. For text categorization purposes, the two measures are defined as (Manning et al. 2008):

$$\text{recall} = \frac{\text{categories found and correct}}{\text{total categories correct}}$$

$$\text{precision} = \frac{\text{categories found and correct}}{\text{total categories found}}$$

In the search process, search engines make available for retrieved documents in a ranked list according to the degree of relevance of the document to a given query. Users then examine the ranked list starting from the top document. The recall and precision measures vary since the users proceed with their examination of the retrieved answer set. Precision versus recall curve is drawn, evaluating the ranked lists. It is based on eleven standard recall level, as usually employed in (Croft et al. 2015). Another measurement is the precision at a given cut-off level. A cut-off level is a rank that defines the retrieved set. For example, a cut-off level of 10 represents the top ten retrieved documents in the ranked list. If seven out of ten of the returned documents is relevant, the precision at cut-off level ten ( $P@10$ ) is  $7/10 = 0.7 = 70\%$ .

*Experiment description:* A unique search browser (SSB) (Zhu and Dreher 2007), which is a component of IIRF, has been developed which categorizes Web search results from Yahoo! under the categories of the ODP. Five search-terms with general or ambiguous meaning are selected as shown in Table 1.

For each search-term, 50 search results are retrieved by utilizing the Yahoo! Search Web Service API. The returned search results are presented to judges to perform the relevance judgment. The relevant judgment results are summarized. A final binary decision is made regarding whether a returned search item is related to the specified information need or not. Based on the relevance judgment results, the standard 11 recall-precision curve is drawn for each search-term of the search results of Yahoo!, and of the categorized results of SSB, as shown in Figure 4.  $P@5$  and  $P@10$  are two sets of search results, as presented in Table 2.



Query	Information needs
Clinton	The American president William J Clinton
Ford	Henry Ford, the founder of Ford motor company
Health	State of physical, mental, and social-well being
Jaguar	Information about an entity, animal “jaguar”
UPS	Information about “uninterrupted power supply”

Table 1. Search Terms and Information Needs

Company	P@5	P@10	Average
Yahoo	46.7	42	44.4
SSB	85	70	77.5
Improvement	38.3	28	33.2

Table 2. P@5 and P@10 of Yahoo and SSB

%	Goggle		MS Live		Lycos		Bing	
	P5	P10	P5	P10	P5	P10	P5	P10
Clinton	40	40	0	0	40	40	20	10
Ford	20	30	20	20	20	20	40	20
Health	100	100	60	40	100	80	100	70
Jaguar	20	40	20	10	20	40	20	10
UPS	20	10	20	20	20	10	0	0

Table 3. P@5 and P@10 of Google, MS Live Search, Bing and Lycos

The data documented in Tables 2 and 3 are based on different relevance judgment criteria and the summary of estimation done in the current research. Following the macro-averaging style (Manning et al. 2008), while drawing the standard 11 point recall-precision curve, the precision  $p_j$  at recall level  $j$  is calculated by:

$$p_j = \frac{1}{N} \sum_{i=1}^N p_{i,j} \quad j = 0, 1, \dots, 10$$

$N = 5$  is number of queries in the experiment,  $p_{i,j}$  is the precision of the  $i$ th query at  $j$ th recall level. The overall precision is calculated by:

$$p = \frac{1}{11 \times N} \sum_{j=0}^{10} \sum_{i=1}^N p_{i,j}$$

*Relevance judgment:* Relevance judgment is inherently subjective (Alonso and Mizzaro 2009). To alleviate the subjectiveness introduced, five judges from Curtin University of Technology are involved in this research. They are presented with search-terms, the information needs, and the search results returned from Yahoo! They know nothing about the categorized results of the SSB. The relevance judgment results of five judges are then averaged. A final binary decision is reached for each returned search item of Yahoo!

The experimental results in Figure 4a and Table 2 of SSB are based on 50 search results of Yahoo!, that is, SSB categorized Yahoo’s 50 results into different ODP categories. In this context, the comparison between Figure 4a and Table 2 is a direct analogy. Because SSB does not categorize the search results of the rest of four search engines, and in such case, the comparison may not be straightforward. However, the indirect comparison also reveals that without applying the proposed search strategy, the performance of the search engines is far from satisfactory regarding the recall-precision curve measure,

and P@5 and P@10 evaluations.

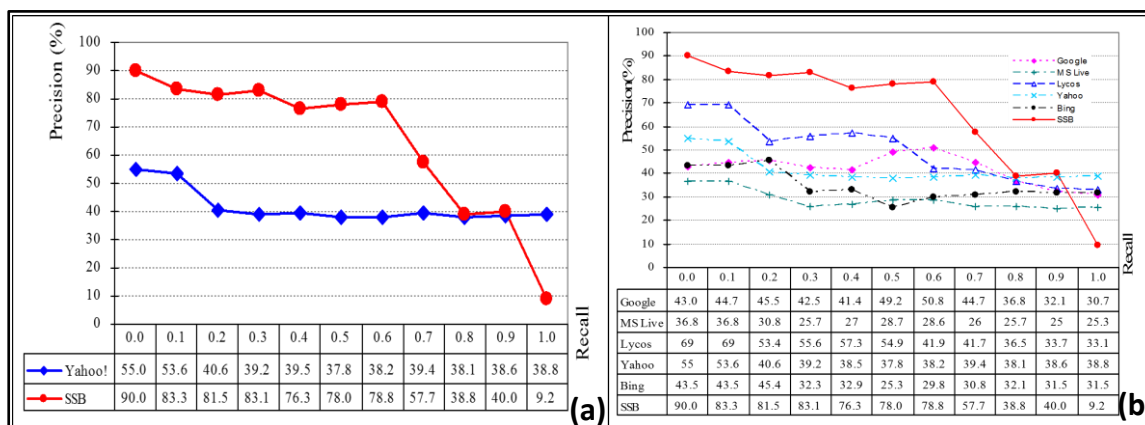

Figure 4 (a): Average recall-precision curves of Yahoo! and SSB categorized search results over the five search-terms (b) Average recall-precision curves of Yahoo!, Google, MS Live Search, Bing, Lycos, and the categorized results of IIRF

### Standard 11 Recall-Precision curve, P@5 and P@10

- As shown in Figure 4b, the overall average *precision* of the 50 search results Yahoo! is  $458.9/11 = 41.7\%$ .
- The overall average *precision* of the categorized results is  $716.7 / 11 = 65.2\%$
- The average improvement on *precision* of the Categorized results is  $65.2\% - 41.7\% = 23.5\%$
- Table 2 demonstrates the improvement of P@5 and P@10 respectively are 38.3% and 28.0% respectively, the average improvement is 33.2%.

*Search results of Google, MS Live, Bing, and Lycos:* To further verify the effectiveness of IIRF, search results of five queries from Google, MS Live Search, MS Bing, and Lycos are also compared, as shown in Figure 4b. The P@5 and P@10 of the results are shown in Table 3 (where P5, P10 represent P@5, P@10 respectively). Figure 4b and Table 3 reveal 1), SSB outperforms the other five major search engines regarding averaged precision based on standard 11 recall-precision curves and P@5 and P@10 in this experiment. 2), the performance of Google and Yahoo is nearly the same; MS Live Search and MS Bing perform relatively weak, as both the recall-precision curve and P@5 and P@10 demonstrate better search. 3), Lycos performs better by the measure of the recall-precision curve, but only better than MS Live Search and Bing when evaluated by P@5 and P@10.

Although MS Bing classifies its results into different clusters, for the five search terms, only one formed cluster “Bill Clinton” is relevant. For the rest four queries, the formed clusters are irrelevant to the specified information needs. For example, when search results of “jaguar” are clustered, all formed clusters are about cars: Jaguar Cars, Jaguar XF, Jaguar UK, Jaguar Dealers, Jaguar Accessories, BMW, Mercedes, and Jaguar X Type. The framework validates the case studies with variables used in the search results, in addition to suggesting significant rework and validation with more case studies making more reliable search results.

## 7 Conclusions

In this paper, a novel search framework is proposed, aiming at providing effective information retrieval services in digital Web ecosystems. The search framework integrates not only traditional database search (MIS) and Web search (search engine), but also intranet search, desktop search, full-text database search, personalization, ontological search results categorization, search results clustering, and search results from security scrutiny. Experimental data demonstrate that text categorization based on the ODP can potentially improve the precision of Web search results by 23.5%. Further work is needed to complete the whole framework and conduct evaluation studies, especially to leverage the advantages of information categorization and clustering.

## 8 Future Scope and Limitations

The experimental results so far demonstrate that text categorization in IIRF improves the precision of Web search results. Implementing the rest of the search framework and conducting a wide range of experiments are planned. With the improvement of precision, the recall of categorized search results has lower than the search results of Yahoo! The reason for the issue is, firstly one search result is assigned to only one category, even if the second or third ranked category has very close similarity instance with the chosen one. Another reason is the categorization algorithm utilized in the IIRF is not optimal. However, algorithms are more powerful in multi-label categorization strategies and their implementations. Combining text clustering and categorization is likely the next research direction, which can improve the recall of the categorized Web-search results.

## References

- Albro, E. E. 2006. Google Mini Is a Mighty Search Tool," *PC World*, June 21.
- Alonso, O. and Mizzaro, S. 2009. Relevance criteria for e-commerce: a crowdsourcing-based experimental analysis, proceedings of the 32<sup>nd</sup> international ACM SIGIR conference on research & development in information retrieval, p. 760-761.
- Arnold, S. E. 2004. How Google Has Changed Enterprise Search," *Searcher*, vol. 12, no. 10, 2004, pp. 8-17.
- Arasu, A. Cho, J. Garcia-Molina, H. Paepcke, A. Raghavan, S. 2001. Searching the Web," *ACM Transactions on Internet Technology*, vol. 1, no. 1, 2001, pp. 2-43
- Barrows, R. and Traverso, J. 2006. Search Considered Integral," *ACM Queue*, May 2006, pp. 30-36.
- Chau, M. and Chen, H. 2008. "A Machine Learning Approach to Web Page Filtering Using Content and Structure Analysis," *Decision Support Systems*, vol. 44, no. 2, Pages 482-494.
- Croft, W.B., Metzler, D. and Strohman, T. 2015. *Search Engines – Information Retrieval in Practice*, Pearson.
- Dolog, P. and Nejdil, W. 2003. Challenges and Benefits of the Semantic Web for User Modelling," in Proceedings of the 12th International *World Wide Web Conference (WWW'03)*, 2003, pp. 99-111.
- Gartner, "Insights From the 2017 Gartner CIO Agenda Report: Seize the Digital Ecosystem Opportunity," 2017.
- McCandless, M., Hatcher, E. and Gospodnetić, O. 2010. *Lucene in Action*, 2nd, Greenwich: Manning Publications.
- Manning, C. D. Raghavan, P. and Schütze, H. 2008. *Introduction to Information Retrieval*, Cambridge: Cambridge University Press, 2008.
- Meng, W., Yu, C. and K.-L. Liu, K. -L. 2000. Building Efficient and Effective Metasearch Engines," *ACM Computing Surveys*, vol. 34, no. 1, 2000, pp. 48-89.
- Moore, R., Seedat, Y., and Chen, J. Y. J. 2018. *South Africa: Winning with Digital Platforms*, Accenture, 2018.
- Pitkow, J. Schütze, H. Cass, T. Cooley, R., Turnbull, D. Edmonds, A. Adar, E. and Breuel, T. 2002. Personalized Search: A contextual computing approach may prove a breakthrough in personalized search efficiency," *Communications of the ACM* vol. 45, no. 9, 2002, pp. 50-55.
- Ramez, E. and Navathe, SB. 2016. *Fundamentals of Database Systems*, Pearson.
- Weill, P. and Woerner, SL. 2015. Thriving in an Increasingly Digital Ecosystem, MIT Sloan Management Review, Vol. 56, No. 4, pp 27-34.
- Zhu, D. and Dreher, H. V. 2007. *An integrating text retrieval framework for digital ecosystems paradigm*, *Proceedings of the Inaugural IEEE, DEST*, Cairns, Australia, pp. 367-372.

## Acknowledgement

We acknowledge the contributions of Professor Heinz Dreher (retired) for his critical comments made on the initial manuscript. We are thankful to the Head of School of Management and Information Systems' Discipline for permitting us to present and publish in the ACIS 2018 conference proceedings.

**Copyright:** © 2018 authors. This is an open-access article distributed under the terms of the [Creative Commons Attribution-NonCommercial 3.0 Australia License](https://creativecommons.org/licenses/by-nc/3.0/), which permits non-commercial use, distribution, and reproduction in any medium, provided the original author and ACIS are credited.

# The Effect of Organisational Culture and Knowledge Environment on Organisational Success: Directions for Future Research

## **Mrs. Mujid Attar**

School of Information System & Modelling  
University of Technology Sydney  
Sydney, Australia  
Email: [MujidMarwanO.Attar@student.uts.edu.au](mailto:MujidMarwanO.Attar@student.uts.edu.au)

## **Dr. Kyeong Kang**

School of Information System & Modelling  
University of Technology Sydney  
Sydney, Australia  
Email: [Kyeong.Kang@uts.edu.au](mailto:Kyeong.Kang@uts.edu.au)

## **Abstract**

Increasingly, organisations strive to shape their knowledge environment and organisational culture for improved performance and organisational success. Despite that, existing evidence recounts the individual role of organisational culture, knowledge management and intellectual capital towards organisational performance and success, a comprehensive explanation of the effect of multiple dimensions of these factors on organisational success remains unexplored. This paper adds to existing literature by proposing that an organisation's knowledge environment combines its knowledge sharing practices (i.e. knowledge types, knowledge sharing approaches and knowledge sharing processes) and its intellectual capital. This paper presents a conceptual model on the relationship between organisational culture, knowledge environment and organisational success. The model proposes the role of organisational culture in shaping knowledge sharing practices, intellectual capital and organisational success. This research-in-progress concludes with directions for future research on the effect of organisational culture, knowledge sharing practices and intellectual capital on organisational success.

**Keywords:** Organisation Culture, Knowledge Sharing, Intellectual Capital, and Organisational Success.

## 1 Introduction

Increasingly, knowledge has become a key factor for sustainability of an organisation (Al. Othman and Sohaib 2016). The organisation's knowledge management practices influence its innovation capability (Liao et al. 2007) and value creation (Kianto et al. 2014). Well-planned knowledge management practices supports organisational performance (Hussinki et al. 2017; Wang et al. 2014). Although knowledge management is a multi-dimensional aspect, existing literature mainly explores the role of knowledge sharing to an organisation. Unfortunately, there is limited explanation of the contribution of various knowledge sharing practices to organisational success. Organisational knowledge sharing practices may include, but not limits to, orientation nor to tacit or explicit knowledge (Wang et al. 2014), application of codification or personalisation strategy (Choi et al. 2008; Hansen et al. 1999) and knowledge sharing processes of donating knowledge and collecting knowledge (Van den Hooff and de Leeuw van Weenen 2004). Understanding knowledge sharing practices alone does not provide sufficient explanation of an organisation's knowledge environment that supports organisational success. One must realise that an organisation's knowledge environment constitutes both knowledge sharing practices as the flow of knowledge and intellectual capital as a knowledge stock or knowledge assets (Chatzkel 2002; Martín-de-Castro et al. 2011).

Culture is a basic element to knowledge management (Chen et al 2011). Organisational culture encourages employees to create and share their knowledge within an organisation. For this reasons, organisations seek to establish an appropriate culture that introduces and supports knowledge management (Chen et al 2011). Organisational culture is a critical success factor for a knowledge management infrastructure that supports organisational success (Ziam et al. 2007). This is simply because the success or failure of the complete organisation usually depends on its culture (Schein 2004; Schein 2010). In addition, the sphere of knowledge in any organisation gives birth to creativity and innovation, which are considered as the key components for sustainability and organisation's success (Argote 2013). Despite the growing number of studies relating to organisational culture and knowledge management, there are limited studies that have shown organisation improved their performance through organisational culture, knowledge sharing practices and intellectual capital. Considering organisational culture, knowledge sharing and intellectual capital is one way to understand how knowledge-based organisations drift towards success. This research-in-progress paper will present a conceptual model on the relationship between organisational culture, organisational knowledge environment and organisational success.

## 2 Theoretical Background

### 2.1 Organisational Culture

Organisational culture is out-richtly considered as the most fundamental and constant strength within an organisation (Schein 2004). Organisational culture is a pattern of shared basic assumptions learned by a group as it solves its problems through external adaptation and internal integration that has worked well enough to be considered valid and, therefore, to be taught to new members as the correct way to perceive, think, and feel in relation to those problems (Schein 2004; Schein 2010). There are different dimensions used to describe organisational culture. Organisational culture may include the following dimensions – information systems, organisational structure, processes, leadership, communication, reward systems and trust (Gupta and Govindarajan 2000). The above factors have been founded to influence knowledge sharing in organisations (Al-Alawi et al. 2007). Among the organisational culture dimensions, *mutual trust*, *profound communication* and *IT support* provide the foundation of an organisation's culture (Schein 2004). Trust embodies the beliefs about the anticipated behaviour and intensions of the involved entities (Johnson and Cullen 2002). Trust is an element of social systems (Lewis and Weigert 1985), as a core factor for performance and cooperation (de Jong et al. 2015) and knowledge sharing (Holste and Fields 2010). Communication, on the other hand, relates to human interaction through verbal and non-verbal language (Al-Alawi et al. 2007). Communication style and satisfaction are critical for knowledge sharing especially in the donation and collection of knowledge (Gumus 2007). Lastly, IT support for knowledge sharing could be for intellectual capital development and improved performance; however, there is insufficient evidence to confirm its role. IT support resonates from a support oriented organisation culture (Van Muijen et al. 1999). Organisations that focus on IT support for knowledge sharing indirectly encourage employees to share knowledge (Lin and Lee 2006). Consequently, IT support builds knowledge sharing capacities thus improving the organisation's innovation capability (Dewett and Jones 2001) – i.e. product innovation, process innovation and management innovation (Liao et al. 2007).

## 2.2 Knowledge Sharing Practices

Knowledge sharing is the activity of transferring knowledge in various forms of one person, group or organisation to another (McAdam et al. 2012). It affects the overall performance of an organisation (Boehm 2012). Knowledge sharing enables employees to increase their working skills (Bock et al. 2005). Knowledge sharing allows individuals to create valuable knowledge contents that enhances the production of organisational intellectual property capital and growth (Nonaka and Konno 1998). Although knowledge sharing is linked to performance, it remains difficult for an organisation to identify the specific knowledge sharing practices that support's performance. There are various knowledge sharing practices that are core to the organisation's operational and financial strategy and must be planned diligently after considering all requisite factors (Akbar 2003). First, one must remember the fact that knowledge manifests in two common *types*, hence, knowledge can be shared as tacit or explicit (Wang et al. 2014). Secondly, knowledge intensive organisations should pursue either codification or personalisation as a dominant strategy (Hansen et al. 1999). Thirdly, the *knowledge sharing process* consists of two dimensions namely knowledge donating and knowledge collecting (Lin 2007; Van den Hooff and de Leeuw van Weenen 2004).

Tacit knowledge sharing and explicit knowledge sharing may differ in the way, which influence the performance and success of an organisation. For instance, sharing explicit knowledge has greater impact on financial performance than operational performance while sharing tacit knowledge has a greater impact on operational performance than financial performance (Wang et al. 2014). On the other hand, the organisation's view of knowledge – i.e. explicit-oriented approach (also known as codification or commodity view of knowledge) or tacit-oriented approach (also known as personalisation or community view of knowledge) may influence its operations and efficiency (Choi and Lee 2003; Choi et al. 2008; McMahan et al. 2004). Combining both approaches may increase the organisation's level of performance (Choi and Lee 2003; Choi et al. 2008). For success, organisations should seek to align their knowledge management strategy to the business strategy (Greiner et al. 2007). Lastly, knowledge sharing process – donating and/or collecting knowledge – commonly affect employee's job performance which in return affects the organisation's performance (Obeidat et al. 2015).

## 2.3 Intellectual Capital

Intellectual capital is the organisation's knowledge stock – knowledge assets (Martín-de-Castro et al. 2011). At one point, intellectual capital is a two-level concept – human capital (knowledge created by and stored in a firm's employees-human resource) and structural capital (the embodiment, empowerment, and supportive infrastructure of human capital) (Martín-de-Castro et al. 2011). Similar research has proposed different framework of intellectual capital, which has three major components human capital, structural capital, and relational capital (Edvinsson and Malone 1997). Relational capital constitutes organisation's relationships with stakeholders (Edvinsson and Malone 1997). Human, structural and relational capital offers a powerful approach to differentiating organisational financial and non-financial performance (Wang et al. 2014; Youndt et al. 2004). Therefore, organisations incorporating all aspects of intellectual capital in their overall business strategies will improve the way they share knowledge, and ultimately improved operational and financial performance (Wang et al. 2014). Organisations should seek to align their knowledge management practices with their intellectual capital to support their strategic goals (Zhou and Fink 2003). There is strong evidence to suggest that intellectual capital supports organisation's performance, in a number of aspects such as value creation (Kianto et al. 2014) and innovation capability (Cabrilo and Dahms 2018), operations and financial performance (Hussinki et al. 2017; Wang et al. 2014). Nonetheless, organisations cannot ignore the close relationship between knowledge management and intellectual capital development for improved performance, value and success of the organisation.

## 2.4 Organisational Success

There multiple measures of organisational success based on intangible performance indicators such as leadership, innovation, reputation, employee satisfaction, and client satisfaction and/or tangible performance indicators such as revenue, profit, growth etc. (Ng et al. 2011; Simon et al. 2011). This paper recognises organisational success in terms of operational and financial performance. Operational success here refers to the following performance indicators – customer satisfaction, cost management and productivity while financial success relates to the following performance indicators – growth of the organisation's annual profits (Wang et al. 2014).

### 3 Research Model and Hypotheses

The research model presented in Figure 1 below presents the hypothesised relationship between organisational culture, knowledge sharing practices and organisational success. An organisation's knowledge environment constitutes not only the knowledge flows (knowledge processes) but also knowledge stocks (intellectual capital) (Chatzkel 2002). Organisational culture is critical for knowledge management and performance (Al Saifi 2015). Further still, knowledge management may, without other influences, drive organisational performance and survival (Omotayo 2015). Exploring organisational success drives us towards examining the role of organisational culture, knowledge sharing practices and intellectual capital.

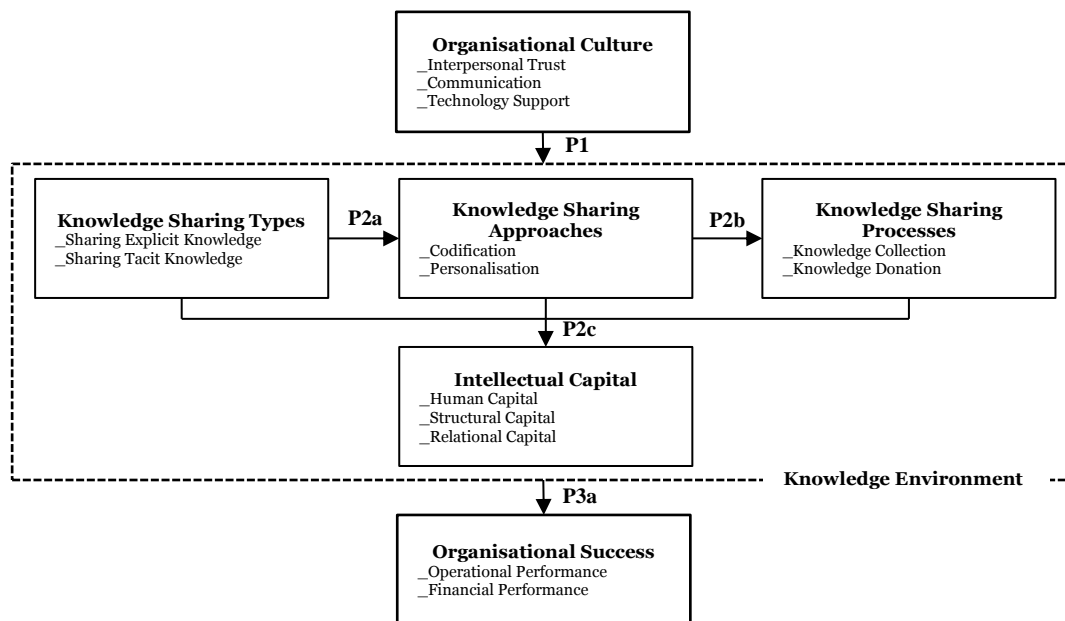

Figure 1. Research Model

Organisational culture tends to influence employee use of IT systems for knowledge sharing activities (Shao et al. 2015) and therefore affects knowledge sharing in an organisation (Al-Adaileh and Al-Atawi 2011; Al-Alawi et al. 2007; Shao et al. 2015; Suppiah and Singh Sandhu 2011). Ultimately, knowledge sharing supports both operational and financial benefits of an organisation (Wang et al. 2014), profitability and growth of an organisation (Wang and Wang 2012). In addition, knowledge sharing is significant in the development of intellectual capital (Kianto et al. 2014; Wang et al. 2016). A comprehensive exploration of knowledge sharing practices of an organisation, calls for a study of knowledge types (Lin 2007; Wang et al. 2014), knowledge management strategies (Hansen et al. 1999) and knowledge sharing processes of an organisation (Al Othman and Sohaib 2016; Lin 2007) as fundamental aspects for developing organisational intellectual capital (Wang et al. 2014). It is then likely that organisational culture that supports knowledge sharing enables an organisation to develop its intellectual capital for improved performance, which supports the organisational success.

**Proposition 1:** Organisational culture, such as trust, communication and IT support is positively related to the organisation's knowledge environment, whereby, organisational culture will positively affect knowledge sharing types, knowledge sharing approaches, knowledge sharing processes and intellectual capital.

Knowledge sharing is an essential intellectual capital development (Hsu and Sabherwal 2012; Wiig 1997; Zhou and Fink 2003). Knowledge sharing not only refers to the knowledge sharing processes – collection and donation – in an organisation, but also constitutes the organisation's knowledge sharing approaches and the type of knowledge shared widely across the organisation. In fact, there is a positive relationship between the knowledge sharing practices and intellectual capital (Hsu 2008; Karagiannis et al. 2008; Wang et al. 2014). Consequently, intellectual capital development enables the firm to perform better, especially when its knowledge management approaches are well developed (Hsu and Sabherwal 2012; Wang et al. 2016; Wang et al. 2014). Knowledge sharing practices improve organisational performance through the development of human capital (Hsu 2008), structural capital (Karagiannis et al. 2008), and relational capital (Bontis et al. 2007; Skaggs and Youndt 2004).

**Proposition 2:** The organisation's knowledge environment constitutes interrelated components such as knowledge sharing types, knowledge sharing approaches, knowledge sharing processes and intellectual capital. This interrelationship is such that;

**Proposition 2a – c:** Sharing a particular organisational knowledge type is positively related to organisation knowledge sharing approaches (i.e. personalisation and codification). Knowledge sharing approaches are positively related to knowledge sharing process (collection and donation) in organisations. The organisation's knowledge sharing practices (i.e. knowledge sharing types, knowledge sharing approaches and knowledge sharing processes) are positively related to intellectual capital.

**Proposition 3:** The organisation's knowledge environment, i.e. knowledge sharing types, knowledge sharing approaches, knowledge sharing processes and intellectual capital, is positively related to an organisation's operational and financial success.

**Proposition 3a:** Knowledge sharing practices affect an organisation's operational and financial success through its intellectual capital specifically, human, structural and relational capital.

## 4 Future Work and Research Method

Despite the growing number of research linking knowledge management and intellectual capital to organisational performance, there is limited explanation on the comprehensive nature of the knowledge environment and its antecedents and its role on organisational success. It is imperative to recognise knowledge sharing practices and intellectual capital as constitutive elements of an organisation's knowledge environment. Therefore, organisations have to shape their knowledge sharing practices towards intellectual capital development (Kianto et al. 2014) because these two factors are unavoidably interrelated in many ways (Zhou and Fink 2003). This paper thus provides the following questions as a direction for future research. How does organisational culture influence knowledge environment and organisational success? Is the effect of knowledge sharing practices on organisational success mediated by intellectual capital? We propose a mixed methods research design to study the research questions test and explain the propositions presented by the research model in Figure 1. A mixed method for this study may employ a cross sectional survey questionnaire and multiple case study interviews. Informed by Venkatesh et al. (2013), selecting a mixed methods approach for this study aims to corroborate the quantitative findings using qualitative explanations to improve the reliability of findings. While a cross sectional survey will enable a researcher to study the prevalence of the identified elements of organisational culture, knowledge sharing practices and intellectual capital development, a multiple case study will allow better generalizability and validity of findings (Yin 2018). A multiple case study will also offer richer and deeper explanation of the study variables and their interrelationship (Yin 2018).

## 5 Conclusion

To consider knowledge sharing as a factor for success, organisations will have to acknowledge that their knowledge environments constitute both knowledge flows – i.e. knowledge sharing practices and knowledge stocks – i.e. intellectual capital. Managing knowledge sharing practices requires the organisation to identify the core knowledge types shared among its employees, their suitable knowledge sharing strategy/approach and the flow of knowledge donation and collection between employees. Further still, it is important to realise that knowledge sharing facilitates intellectual capital development; therefore, organisations must carefully plan their knowledge sharing practices to support intellectual capital as a means to enabling organisational success. Lastly, organisations may consider shaping their organisational culture to support their knowledge environment, because organisational culture is critical in collaborative behaviour among people.

## 6 References

- Akbar, H. 2003. "Knowledge Levels and Their Transformation: Towards the Integration of Knowledge Creation and Individual Learning," *Journal of Management Studies* (40:8), pp. 1997-2021.
- Al-Adaileh, R. M., and Al-Atawi, M. S. 2011. "Organizational Culture Impact on Knowledge Exchange: Saudi Telecom Context," *Journal of knowledge Management* (15:2), pp. 212-230.
- Al-Alawi, A. I., Al-Marzooqi, N. Y., and Mohammed, Y. F. 2007. "Organizational Culture and Knowledge Sharing: Critical Success Factors," *Journal of knowledge management* (11:2), pp. 22-42.
- Al Othman, F. A., and Sohaib, O. 2016. "Enhancing Innovative Capability and Sustainability of Saudi Firms," *Sustainability* (8:12), p. 1229.



- Al Saifi, S. A. 2015. "Positioning Organisational Culture in Knowledge Management Research," *Journal of Knowledge Management* (19:2), pp. 164-189.
- Al. Othman, F., and Sohaib, O. 2016. "Enhancing Innovative Capability and Sustainability of Saudi Firms," *Sustainability* (8:12), pp. 1-16.
- Argote, L. 2013. *Organizational Learning: Creating, Retaining and Transferring Knowledge*. New York: Springer Science & Business Media.
- Boehm, E. 2012. "Improving Efficiency and Effectiveness in an Automotive R&D Organization," *Research-Technology Management* (55:2), pp. 18-25.
- Bontis, N., Seleim, A., and Ashour, A. 2007. "Human Capital and Organizational Performance: A Study of Egyptian Software Companies," *Management Decision* (45:4), pp. 789-801.
- Cabrilo, S., and Dahms, S. 2018. "How Strategic Knowledge Management Drives Intellectual Capital to Superior Innovation and Market Performance," *Journal of Knowledge Management*.
- Chatzkel, J. 2002. *Intellectual Capital*. Oxford, United Kingdom: John Wiley and Sons, Inc.
- Choi, B., and Lee, H. 2003. "An Empirical Investigation of Km Styles and Their Effect on Corporate Performance," *Information & Management* (40:5), pp. 403-417.
- Choi, B., Poon, S. K., and Davis, J. G. 2008. "Effects of Knowledge Management Strategy on Organizational Performance: A Complementarity Theory-Based Approach," *Omega* (36:2), pp. 235-251.
- de Jong, B. A., Dirks, K. T., and Gillespie, N. 2015. "Trust and Team Performance: A Meta-Analysis of Main Effects, Contingencies, and Qualifiers," *Academy of Management Proceedings: Academy of Management*, p. 14561.
- Dewett, T., and Jones, G. R. 2001. "The Role of Information Technology in the Organization: A Review, Model, and Assessment," *Journal of management* (27:3), pp. 313-346.
- Edvinsson, L., and Malone, M. S. 1997. "Intellectual Capital: Realizing Your Company'S True Value by Finding Its Hidden Brainpower,").
- Greiner, M. E., Böhmman, T., and Krcmar, H. 2007. "A Strategy for Knowledge Management," *Journal of knowledge management* (11:6), pp. 3-15.
- Gumus, M. 2007. "The Effect of Communication on Knowledge Sharing in Organizations," *Journal of Knowledge Management Practice* (8:2), pp. 15-26.
- Gupta, A. K., and Govindarajan, V. 2000. "Knowledge Flows within Multinational Corporations," *Strategic management journal*, pp. 473-496.
- Hansen, M. T., Nohria, N., and Tierney, T. 1999. "What's Your Strategy for Managing Knowledge," *Harvard business review* (77:2), pp. 106-116.
- Holste, J. S., and Fields, D. 2010. "Trust and Tacit Knowledge Sharing and Use," *Journal of knowledge management* (14:1), pp. 128-140.
- Hsu, I.-C. 2008. "Knowledge Sharing Practices as a Facilitating Factor for Improving Organizational Performance through Human Capital: A Preliminary Test," *Expert Systems with applications* (35:3), pp. 1316-1326.
- Hsu, I. C., and Sabherwal, R. 2012. "From Intellectual Capital to Firm Performance: The Mediating Role of Knowledge Management Capabilities," *IEEE Transactions on Engineering Management* (58:4), pp. 626-642.
- Hussinki, H., Ritala, P., Vanhala, M., and Kianto, A. 2017. "Intellectual Capital, Knowledge Management Practices and Firm Performance," *Journal of Intellectual Capital* (18:4), pp. 904-922.
- Johnson, J. L., and Cullen, J. B. 2002. "Trust in Cross-Cultural Relationships," in *The Blackwell Handbook of Cross-Cultural Management*, M.J. Gannon and K.L. Newman (eds.). Oxford UK: Blackwell, pp. 335-360.
- Karagiannis, D., Waldner, F., Stoeger, A., and Nemetz, M. 2008. "A Knowledge Management Approach for Structural Capital," in *Practical Aspects of Knowledge Management*, T. Yamaguchi (ed.). pp. 135-146.
- Kianto, A., Ritala, P., Spender, J.-C., and Vanhala, M. 2014. "The Interaction of Intellectual Capital Assets and Knowledge Management Practices in Organizational Value Creation," *Journal of Intellectual capital* (15:3), pp. 362-375.
- Lewis, J. D., and Weigert, A. 1985. "Trust as a Social Reality," *Social forces* (63:4), pp. 967-985.
- Liao, S.-H., Fei, W.-C., and Chen, C.-C. 2007. "Knowledge Sharing, Absorptive Capacity, and Innovation Capability: An Empirical Study of Taiwan's Knowledge-Intensive Industries," *Journal of information science* (33:3), pp. 340-359.
- Lin, C.-P. 2007. "To Share or Not to Share: Modeling Tacit Knowledge Sharing, Its Mediators and Antecedents," *Journal of business ethics* (70:4), pp. 411-428.
- Lin, H.-F., and Lee, G.-G. 2006. "Effects of Socio-Technical Factors on Organizational Intention to Encourage Knowledge Sharing," *Management decision* (44:1), pp. 74-88.

- Martín-de-Castro, G., Delgado-Verde, M., López-Sáez, P., and Navas-López, J. E. 2011. "Towards 'an Intellectual Capital-Based View of the Firm': Origins and Nature," *Journal of Business Ethics* (98:4), pp. 649-662.
- McAdam, R., Moffett, S., and Peng, J. 2012. "Knowledge Sharing in Chinese Service Organizations: A Multi Case Cultural Perspective," *Journal of Knowledge Management* (16:1), pp. 129-147.
- McMahon, C., Lowe, A., and Culley, S. 2004. "Knowledge Management in Engineering Design: Personalization and Codification," *Journal of Engineering Design* (15:4), pp. 307-325.
- Ng, H. S., Kee, D. M. H., and Brannan, M. 2011. "The Role of Key Intangible Performance Indicators for Organisational Success," *Proceedings of the 8th International Conference on Intellectual Capital, Knowledge Management and Organisational Learning*.
- Nonaka, I., and Konno, N. 1998. "The Concept of 'Ba': Building a Foundation for Knowledge Creation," *California management review* (40:3), pp. 40-54.
- Obeidat, B. Y., Zyod, D. S., and Gharaibeh, A. a. H. 2015. "The Associations among Transformational Leadership, Transactional Leadership, Knowledge Sharing, Job Performance, and Firm Performance: A Theoretical Model," *Journal of Social Sciences (COES&RJ-JSS)* (4:2), pp. 848-866.
- Omotayo, F. O. 2015. "Knowledge Management as an Important Tool in Organisational Management: A Review of Literature,").
- Schein, E. H. 2004. *Organisational Culture and Leadership*. San Francisco, CA: Jossey-Bass.
- Schein, E. H. 2010. *Organizational Culture and Leadership*. John Wiley & Sons.
- Shao, Z., Wang, T., and Feng, Y. 2015. "Impact of Organizational Culture and Computer Self-Efficacy on Knowledge Sharing," *Industrial Management & Data Systems* (115:4), pp. 590-611.
- Simon, A., Kumar, V., Schoeman, P., Moffat, P., and Power, D. 2011. "Strategic Capabilities and Their Relationship to Organisational Success and Its Measures: Some Pointers from Five Australian Studies," *Management Decision* (49:8), pp. 1305-1326.
- Skaggs, B. C., and Youndt, M. 2004. "Strategic Positioning, Human Capital, and Performance in Service Organizations: A Customer Interaction Approach," *Strategic Management Journal* (25:1), pp. 85-99.
- Suppiah, V., and Singh Sandhu, M. 2011. "Organisational Culture's Influence on Tacit Knowledge-Sharing Behaviour," *Journal of knowledge management* (15:3), pp. 462-477.
- Van den Hooff, B., and de Leeuw van Weenen, F. 2004. "Committed to Share: Commitment and Cmc Use as Antecedents of Knowledge Sharing," *Knowledge and process management* (11:1), pp. 13-24.
- Van Muijen, J. J., Koopman, P., De Witte, K., and De Cock, G. 1999. "Organizational Culture: The Focus Questionnaire," *European Journal of Work and Organizational Psychology* (8:4), pp. 551-568.
- Venkatesh, V., Brown, S. A., and Bala, H. 2013. "Bridging the Qualitative-Quantitative Divide: Guidelines for Conducting Mixed Methods Research in Information Systems," *MIS quarterly* (37:1).
- Wang, Z., Wang, N., Cao, J., and Ye, X. 2016. "The Impact of Intellectual Capital-Knowledge Management Strategy Fit on Firm Performance," *Management Decision* (54:8), pp. 1861-1885.
- Wang, Z., Wang, N., and Liang, H. 2014. "Knowledge Sharing, Intellectual Capital and Firm Performance," *Management decision* (52:2), pp. 230-258.
- Wiig, K. M. 1997. "Integrating Intellectual Capital and Knowledge Management," *Long Range Planning* (30:3), pp. 399-405.
- Yin, R. K. 2018. *Case Study Research: Design and Methods*. Thousand Oaks, CA: Sage Publications, Inc.
- Youndt, M. A., Subramaniam, M., and Snell, S. A. 2004. "Intellectual Capital Profiles: An Examination of Investments and Returns," *Journal of Management Studies* (41:2), pp. 335-361.
- Zhou, A. Z., and Fink, D. 2003. "The Intellectual Capital Web: A Systematic Linking of Intellectual Capital and Knowledge Management," *Journal of intellectual capital* (4:1), pp. 34-48.
- Ziam, H., Taoglu, E., and Ziam, S. 2007. "Performance of Knowledge Management Practices: A Causal Analysis," *Journal of Knowledge Management* (11:6), pp. 54-67.

# The Interplay between Social Capital and Knowledge Contribution in Online User Communities

## **Jie (Kevin) Yan**

Wright School of Business  
Dalton State College  
Georgia, USA  
Email: [jyan@daltonstate.edu](mailto:jyan@daltonstate.edu)

## **Dorothy Leidner**

Hankamer School of Business  
Baylor University and Lund University  
Texas, USA  
Email: [Dorothy\\_Leidner@baylor.edu](mailto:Dorothy_Leidner@baylor.edu)

## **Hind Benbya**

Montpellier Business School  
Montpellier, France  
Email: [h.benbya@montpellier-bs.com](mailto:h.benbya@montpellier-bs.com)

## **Weifei Zou**

Fox School of Business  
Temple University  
Pennsylvania, USA  
Email: [weifei.zou@temple.edu](mailto:weifei.zou@temple.edu)

## **Abstract**

Firms have been increasingly relying on online user communities (OUC) to access external, distant knowledge and expertise. Previous research on OUC has largely investigated the influence of individuals' social capital on their knowledge sharing behavior. In this study, we propose a spiral view on the relationship between social capital and knowledge contribution. We suggest that there are two-way interactions between individuals' social capital and their knowledge contribution in online user communities. To test our proposition, we collected and analysed participation data of 3,512 users from the OUC of BMC, a global leader in innovative software solutions. We discuss the theoretical and practical implications of our study for the online user community literature as well as the broader context of online community.

**Keywords:** Social capital, Knowledge contribution, Online user communities, Two-way relationship, Granger causality

## 1 Introduction

Firms have been increasingly relying on online user communities (hereinafter OUC) to access external, distant knowledge and expertise (Jeppesen and Frederiksen 2006; Yan et al. 2018). Participants or members in OUC are mainly product users of the host firm. They voluntarily engage in the community and contribute their knowledge and expertise about existing product support and new product development. Much research has focused on understanding why users are willing to cooperate with host firms and contribute their knowledge to the community (e.g., Porter and Donthu 2008; Jeppesen and Frederiksen 2006). An emergent line of inquiry has emphasized the social capital aspect of community engagement (e.g., Wasko and Faraj 2005). Social capital refers to the collective resources emerging from and embedded inside a social network, as a result of the interconnected relationships of its members (Nahapiet and Ghoshal 1998). Prior studies on social capital in OUC suggested that participants are embedded in the social structure of their community and that social capital building goals plays a major role in their knowledge contribution behavior.

Existing empirical IS research have revealed significant effects of social capital on knowledge contribution in OUC (e.g., Robert et al. 2008; Nov et al. 2012) but has primarily emphasized and theorized a linear relationship between social capital and knowledge contribution. Such a relationship falls short of revealing the dynamic interplay or co-evolution between social capital and knowledge contribution that might explain why the social capital emerged in the first place or how it can be sustained over time. Thus, the goal of this study is to contribute to a better understanding of the interplay between social capital and knowledge contribution in OUC. We investigate the interactions between users' knowledge contribution, including both the quantity and the quality dimensions, and their social capital, including the structural, cognitive, and relational dimensions. Through a multidimensional, dynamic analysis of knowledge contribution and social capital, we seek to provide a robust and complete picture of the interplay between social capital and knowledge contribution. More specifically, we ask the following research questions: 1) *is there a one-way or two-way relationship between social capital and knowledge contribution*, and 2) *does the causal relationship apply to users with different participation levels?*

Investigating the above questions has several theoretical implications. First, existing theories on social network have proposed a two-way, dynamic relationship between structural social capital and knowledge contribution in both online and offline settings (see Wasko et al. 2004; Perry-Smith and Shalley 2003). However, to the best of our knowledge, no published studies have empirically investigated such a relationship. Our study therefore takes the first step towards this direction by empirically examining a two-way relationship between social capital and knowledge contribution. Further, we extend current research by investigating the three dimensions of social capital (structural, cognitive and relational) simultaneously. This is important in order to distinguish the impact each dimension has in the presence of the other two. From a broader online community perspective, the findings of our study should be applied not only to the OUC context but also to other forms of online communities. This includes Q&A, open source and various open innovation communities where the dynamics of knowledge creation and exchange determine the long-term success of communities (Benbya 2016; Faraj et al. 2011).

Second, our study holds implications for other research streams in the online community literature. For instance, online community leadership as an emerging research stream focuses on the formation of leadership and the role of leaders in online communities (Johnson et al. 2017). It has been found that knowledge contribution and social capital of individuals are two key antecedents of leadership in online communities (Faraj et al. 2015). Members, for example, with a central network position who contribute frequently are more likely to be identified as leaders. Our study suggests that the path to leadership in OUC may entail ongoing interactions between individuals' knowledge contribution and social capital. As one changes, so does the other. In other words, while both knowledge contribution and social capital affect leadership independently, it is essential to account for the reciprocity between knowledge contribution and social capital and examine how such dynamics determine the emergence of leadership in online communities.

Moreover, our findings may help explain how social capital initially emerges from knowledge contribution in some online marketplaces (e.g., Amazon reviews) and how social capital translates into other capital forms (e.g., game credits) as a result of participation in online games. Answers to these questions are still unclear to date (Faraj et al. 2011). Overall, the present paper holds the potential to not merely consolidate extant OUC literature but provide extensions by examining a two-way relationship between social capital and knowledge contribution. Our findings would also add a layer of explanation to the participation and contribution dynamics in many other types of online communities.

## 2 The Interplay between Social Capital and Knowledge Contribution

A large body of extant OUC research has investigated the relationship between knowledge contribution and social capital. Studies in this research stream, however, have largely focused on examining the effects of users' social capital on their knowledge contribution. Social capital is typically defined as "resources embedded in a social structure that are accessed and/or mobilized in purposive action" (Lin 2001, p.29). Drawing upon the seminal work of Nahapiet and Ghoshal (1998), this research stream typically conceptualizes social capital as consisting of three distinct dimensions: structural, cognitive, and relational (e.g., Wasko and Faraj 2005).

Structural capital refers to the connections and structural links among individuals (Nahapiet and Ghoshal, 1998). Research on the structural aspect of social capital has tended to focus on the structural position of individuals and how it impacts knowledge exchange in OUC (Huysman and Wulf 2006). Whelan (2007), for example, finds that community members' core/periphery structure and connectivity influence their knowledge contribution. Dahlander and Frederiksen (2012)'s research shows that users' position in the core/periphery structure of an OUC is consequential for knowledge contribution. Cognitive capital refers to the capability of individuals to understand and apply knowledge when connecting with each other (Nahapiet and Ghoshal 1998). Research on the cognitive aspect of social capital has largely focused on the cognitive benefits users anticipate from engaging in OUC (Huysman and Wulf 2006). For instance, Nambisan and Baron's research reveals that users' expectations of expertise enhancement and actual experiences in community learning are significantly related to users' participation in value creation and innovation (Nambisan and Baron 2010). Finally, relational capital refers to the characteristics of the relationship such as mutual respect, trust and generalized reciprocity (Nahapiet and Ghoshal 1998). Several studies on OUC have found that community trust (or the norm of collaboration) affects users' knowledge-sharing intentions with both other users and the host firm (e.g., Porter and Donthu 2008; Wasko et al. 2004). And building a norm of reciprocity has significant effects on the quality and quantity of knowledge contribution (e.g., Dholakia et al. 2004).

The discussion above reveals significant effects of social capital on knowledge contribution in OUC. However, the relationship between knowledge contribution and social capital can be relevantly examined in both directions. It is intuitive to expect that an individual's knowledge contribution should, in turn, influence his/her social capital in the community. For example, for users who extensively participate in product support and contribute their knowledge, they receive more connections or ties and thereby gain reputational benefits and community status (Phang et al. 2009). This changes their structural capital in the community. Therefore, while studies relying on social network and collective action theories have shown that network outcomes are affected by network structures (Burt 2004; Nahapiet and Ghoshal 1998), a largely ignored dimension is how network outcomes (e.g., knowledge exchange) will in turn change network structures.

Further, users should also develop their expertise and skills by contributing knowledge in the community. As a user contributes his/her own knowledge, the user is involved in the knowledge exchange process, either actively or passively. The user may, for example, discuss his/her answers with others, read and comment on answers of others or simply receive a notification of the marking of a best answer. In other words, we suggest that in OUC, knowledge contribution itself motivates the contributor to interact with others who share the same practice and thereby learn the knowledge, skills and norms of the practice over time. This developed expertise or cognitive capital then drives the user to continue to share his/her knowledge in the community. Unlike previous studies largely assuming knowledge contribution depends on pre-determined cognitive capital (e.g., Wasko and Faraj 2005), our study seeks to examine cognitive capital as a key outcome of knowledge contribution.

Finally, the norm of collaboration and trust should be cultivated between users who reactively and proactively contribute their knowledge in the community. As users receive incoming ties and derive expertise and skills resulting from their knowledge contribution, they are willing to develop trust and a sense of reciprocity with others (Dholakia et al. 2004). A strong norm of reciprocity and trustworthiness in the collective will, in turn, reward individual efforts and ensure continual contributions (Dholakia et al. 2004). These combined should impact relational capital between users in the community. Overall, we suggest that understanding the interplay between knowledge contribution and social capital is of great importance for scholars to advance theories and for practitioners to build a thriving community but remains under-investigated.

### 3 Methodology

#### 3.1 Data

We collected our data from the OUC of BMC, a global leader in innovative software solutions headquartered in Houston, Texas. BMC established its OUC in 2002 for product support and new product development and has since developed a successful, long-term relationship with its product users. As of January 2016, the community has 26,597 registered members. To create a sample of users for the study, we utilized the community's member list which ranks all members based on their community levels (i.e., points earned based on cumulative contributions) and selected a stratified random sample of 6,836 users. Doing so allows us to ensure that the dataset represents various population members. We then checked the record of recent community activities of each user in our dataset and removed those users who did not have any community activities during the last 3 months. Members who do not have any login records during the past 3 months were assigned with a status of "inactive" by the system. The entire process results in a total of 3,512 users included in our dataset.

We collected the users' participation data from their online community profiles. Community profiles include each user's demographic data (e.g., name, company and title), network data (following/followers), contribution data (e.g., answers and ideas), reputation data (e.g., points and levels), etc. Through the profile menus such as "Content", "Connections" and "Reputation", users can access more detailed information such as the discussions and threads they have participated in, the profiles of people following them, and the entire ranking list of the community. Figure 1 provides an example of an online community profile.

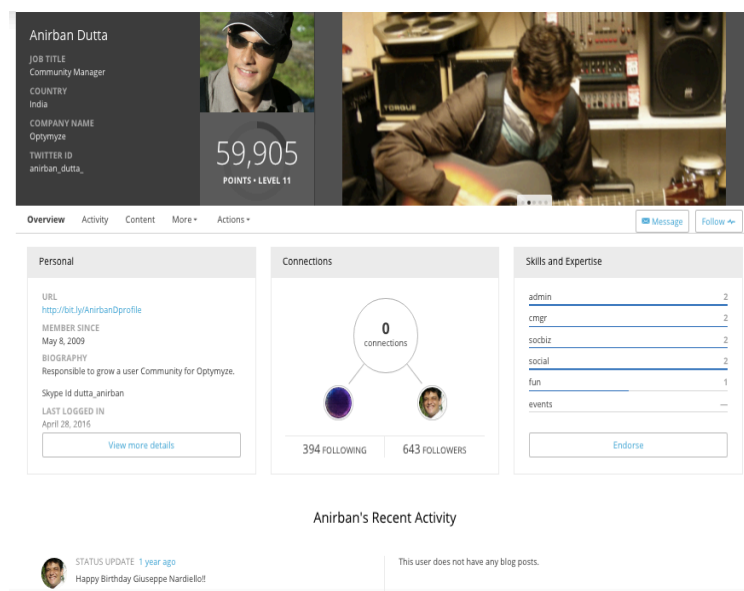

Figure 1. An Example of Online Profile

#### 3.2 Variables and Measures

To examine the dynamics between social capital and knowledge contribution, we focus on three groups of variables. They are: 1) users' initial social capital including structural, cognitive, and relational, 2) users' knowledge contribution including both the quantity and quality dimension, and 3) the changes of users' structural, cognitive and relational capital. We seek to investigate whether the initial social capital will predict users' knowledge contribution, which will, in turn, determine the change in users' social capital. We measured all the variables via each user's online community profile on a weekly basis from March 6<sup>th</sup> 2016 to July 30<sup>th</sup> 2016, a total of 21 weeks.

To measure the initial structural capital each user possesses at the beginning of our research period, we utilized the total number of followers a user has in the community. The more followers a user has, the more closely the user moves toward the core structure of an online community (Borgatti 2005). To measure the initial cognitive capital level of each user, we recorded and coded all the helpful and correct answers a user had contributed before March 2016. We coded the answers as follows: an answer would receive 3 points if it was marked as "correct", 2 points if marked as "helpful", and 1 point if not marked.

We then summed up the points for each user and used this cumulative score to represent the initial cognitive experience (knowledge and expertise) a user had at the beginning of our research period. We measured initial cognitive capital in this way considering that individuals' level of knowledge and expertise is associated with their knowledge contribution in the community (Wasko and Faraj 2005). Drawing upon previous studies (Borgatti and Cross 2003), the initial relational capital was measured by counting the number of ties where two users followed each other. For example, if a user had 5 connections where the user and the other user followed each other, the user would receive a relational score of 5. Research on social media indicates that when individuals choose to follow each other, they tend to trust each other to an extent and are willing to interact for reciprocity (Coleman 1988).

The variables of knowledge contribution (i.e., quantity and quality) were measured at the end of each week (i.e., the beginning of the next week). We measured knowledge contribution using each user's participation data during the current week. Specifically, we again categorized each user's discussion contributions into correct answers, helpful answers and others. A user would receive 3 points if one of his/her answers was marked as correct, and 2 points if marked as helpful, and 1 point if it received no marks. We then summed up all the points to measure the quantity dimension of the user's knowledge contribution; the quality dimension was measured by only counting the points of correct and helpful answers.

The variables of the changes of structural, cognitive and relational capital were also measured at the end of each week using each user's participation data. For the change of cognitive capital, we measured it by identifying whether the correct and/or the helpful answers in the discussions a user participated were contributed by the user or others. We suggest that the user should, to some extent, learn from peers' correct and/or helpful answers if such answers appear in the discussion threads<sup>1</sup>, which should result in change of cognitive capital. To quantify the cognitive change, we used the cumulative score of correct answers (3 points/each) and helpful answers (2 points/each) contributed by others to reflect the user's change of cognitive capital in the current week.

The change of structural capital was measured by recording the number of new followers of each user at the end of each week. However, whether the new followers resulted from a user's knowledge contribution is unobservable. To overcome this issue, we checked each new follower's online profile to determine whether the follower and the focal user had participated in the same discussion threads. We suggest that the following action should, to some extent, result from the knowledge contribution if the two users had participated in the same discussions. Based on this criterion, we were able to remove those new followers whose motives were "unidentifiable". We then recorded the number of new ties where the focal user and the new follower followed each other as the change of relational capital.

### 3.3 Modelling and Estimation Approach

In this study we are interested in 1) whether there is a one-way or two-way relationship between social capital and knowledge contribution, and 2) whether the relationship is applicable to users with different levels of participation. To examine the first question, we employed the Granger causality test (Granger 1969). The Granger test for causality considers the following questions: is it social capital that leads to knowledge contribution or is it knowledge contribution that causes changes of social capital, or does both causal relationships exist?

The Granger causality test of two variables is commonly conducted by regressing one variable on its own lagged values and on lagged values of the other variable (Greene 2011; Heshmati and Lööf 2008). One variable is explained to Granger cause the other variable if the past values of both variables are useful in predicting the dependent variable (Greene 2011). Given this, we used the following models to examine the Granger causal relationship between social capital ( $y$ ), social capital change ( $\Delta y$ ) and knowledge contribution ( $x$ ):

$$\Delta y_{it} = \alpha_{0t} + \sum_{l=1}^n \alpha_{lt} \Delta y_{i,t-l} + \sum_{l=1}^n \beta_{lt} x_{i,t-l} + \varepsilon_{it} \quad (1)$$

$$x_{it} = \gamma_{0t} + \sum_{l=1}^n \gamma_{lt} x_{i,t-l} + \sum_{l=1}^n \delta_{lt} y_{i,t-l} + \varepsilon_{it} \quad (2)$$

where  $t$  is the time period (i.e., 21 weeks from March to August),  $i$  is the number of observations (i.e., 3,512 users) in each week, and  $n$  is the number of lags selected. Notably, the error term ( $\varepsilon$ ) follows a two-

---

<sup>1</sup> Having participated (e.g., comments or replies) in a discussion, a user will receive a message (via email and on community app) if a helpful or a correct answer is marked by the asker.

way error component structure (Baltagi 2001). It consists of an unobservable user specific ( $\lambda$ ), time specific ( $\mu$ ) and a random error term ( $\tau$ ), i.e.,  $\varepsilon_{it} = \lambda_{it} + \mu_{it} + \tau_{it}$ .

In terms of the choice of the number of lags, overall, using large lags helps rule out autocorrelation while small lags increase degrees of freedom (Greene 2011; Heshmati and Lööf 2008). Our selection of number of lags is empirical rather than theoretical. Specifically, for each causality test, we added one lag at a time and compare the statistics based on the Schwarz information criterion (SIC), considering that our sample size is large (Cavanaugh and Neath 1999). We then used the results from this procedure to determine the appropriate lag length for the causality tests. We suggest that the causal effect is transitory if it holds only for a few lags and is persistent if the effect holds for multiple, consecutive lags (Greene 2011; Heshmati and Lööf 2008).

Our second question concerns whether the causal relationships hold true for users with different levels of participation. To this end, we categorized users into different participation levels based on their community levels. Given that the community level depends upon users' earned<sup>2</sup> points in the community, it reflects how active a user has participated in the community. We divided all the 3,512 users into two groups with low and medium participation levels and high participation level, respectively. We chose Level 9 (there are a total of 13 levels based on community points earned) as the cut-off level considering that according to the community's reputation system, Levels 9~13 represent highly experienced users with a status of "Expert", "Master", "Guru", "Grand Master" and "Emperor", respectively. Consequently, there are 3,330 users (Levels 1~8) in the low and medium group and 182 users (Levels 9~13) in the high group.

Given the above, our empirical study employs two strongly balanced panel models spanning 21 weeks. One panel includes 3,330 users (Panel 1) and the other panel has 182 users (Panel 2). We constructed both panels based on user-week pairs, resulting in 69,930 observations in Panel 1 and 3,822 observations in Panel 2. For each user-week pair, variables examined include social capital (i.e., the initial social capital level at the beginning of week t), knowledge contribution during week t, and the change of social capital during week t (which, in turn, determines the initial social capital level at the beginning of week (t+1)). Then each Granger causality test between two variables was conducted using vector auto regressive (VAR) with the within estimation method. The use of fixed-effects method allows us to account for unobservable user and time specific effects in the error term (Greene 2011).

### 3.4 Results

Tables 1 presents the descriptive statistic and correlations of our panel data. The averages are relatively low in Panel 1 because of excess zeros in the observations. The correlation between the quality and quantity of knowledge contribution is high (i.e., 0.67) in Panel 2, indicating that users with higher participation levels may be more likely to contribute helpful and correct answers. Tables 1 and 2 in the Appendix illustrate the results of the lag order selection for each pair of variables. Given the time period of 21 weeks in each panel, we were able to include one lag at a time and run the procedure up to 20 lags. The SIC criterion, as noted earlier, was employed and the corresponding results in the tables suggest using lag structures including 1-lag, 2-lag, 7-lag and 8-lag. We chose the 2-lag structure for the best balance of efficiency and accuracy as well as for the consistency in reporting the results of causality tests.

Low and Medium Participation Levels (Panel 1: 3,330 users; 69,930 observations)												
Variable	Mean	S.D.	Min	Max	1	2	3	4	5	6	7	8
SC	1.06	1.93	0	23	1.00							
CC	3.94	5.83	0	68	0.24	1.00						
RC	0.74	1.50	0	26	0.36	0.21	1.00					
$\Delta$ SC	0.43	1.04	-1	24	0.31	0.20	0.29	1.00				
$\Delta$ CC	0.37	0.92	0	31	0.09	0.16	0.08	0.12	1.00			
$\Delta$ RC	0.27	0.74	-1	19	0.26	0.17	0.32	0.29	0.11	1.00		
Quality	0.43	0.95	0	11	0.09	0.15	0.09	0.12	0.34	0.11	1.00	
Quantity	2.92	1.96	0	20	0.04	0.07	0.04	0.05	0.16	0.05	0.49	1.00
High Participation Level (Panel 2: 182 users; 3,822 observations)												
Variable	Mean	S.D.	Min	Max	1	2	3	4	5	6	7	8

<sup>2</sup> For example, a user will earn 1 point if the user replies to a discussion question and 5 points and 10 points if the answer is marked as helpful and correct, respectively. Users can also earn points through other community activities such as posting a status update and creating an idea, among others.



SC	1.95	6.80	0	185	1.00							
CC	5.78	7.66	0	165	0.13	1.00						
RC	1.36	4.06	0	115	0.55	0.14	1.00					
$\Delta$ SC	0.95	5.11	0	197	0.55	0.07	0.49	1.00				
$\Delta$ CC	0.20	1.22	0	13	0.04	0.11	0.02	0.05	1.00			
$\Delta$ RC	0.33	5.22	0	53	0.42	0.09	0.46	0.36	0.01	1.00		
Quality	1.22	2.66	0	36	0.07	0.15	0.10	0.10	0.30	0.05	1.00	
Quantity	3.82	3.67	0	51	0.06	0.13	0.08	0.09	0.25	0.05	0.67	1.00

Table 1. Descriptive Statistics and Correlations Matrix

### 3.5 Causality Tests with VAR Estimation

Tables 2 and 3 report the results of causality tests using 2-lag structure for Panel 1 and Panel 2, respectively. Comparing the results between the two tables, we see different patterns of causality. For users with low and medium participation levels (Panel 1), the results show that overall, there is a two-way relationship between social capital and knowledge contribution. Not only does social capital, including structural, cognitive and relational, have a positive impact on users' knowledge contribution in terms of quality and quantity, but there is a reverse causal dependence between social capital and knowledge contribution: users with higher levels of knowledge contribution are more likely to build up their social capital (structural, cognitive and relational) in the community. In contrast, the results based on users with high participation level (Panel 2) overall show the absence of a two-way relationship between social capital and knowledge contribution. Further, the results only illustrate a one-way relationship between cognitive capital and knowledge contribution and between knowledge contribution and the change of structural capital. We will discuss and explain these findings in detail in the discussion section.

Panel 1	Lags	$\Delta$ SC	$\Delta$ CC	$\Delta$ RC	Quality	Quantity
SC	L1	---	---	---	0.0179*** (0.0015)	0.0177*** (0.0038)
	L2	---	---	---	0.0024 (0.0014)	0.0071 (0.0038)
CC	L1	---	---	---	0.0047*** (0.0005)	0.0056*** (0.0012)
	L2	---	---	---	0.0014** (0.0005)	0.0020 (0.0012)
RC	L1	---	---	---	0.0170*** (0.0020)	0.0169*** (0.0049)
	L2	---	---	---	0.0064** (0.0020)	0.0116* (0.0048)
Quality	L1	0.0309*** (0.0043)	0.0933*** (0.0036)	0.0238*** (0.0035)	---	---
	L2	0.0168** (0.0051)	0.0472*** (0.0031)	0.0180*** (0.0030)	---	---
Quantity	L1	0.0073*** (0.0021)	0.0156*** (0.0015)	0.0043** (0.0015)	---	---
	L2	0.0036 (0.0022)	0.0104*** (0.0015)	0.0036* (0.0015)	---	---

\*\*\* Sig. at  $p < 0.001$ ; \*\* Sig. at  $p < 0.01$ ; \* sig. at  $p < 0.05$

Table 2. Results of Causality Tests (Low and Medium Participation Levels; 3,330 users)

Panel 2	Lags	$\Delta$ SC	$\Delta$ CC	$\Delta$ RC	Quality	Quantity
SC	L1	---	---	---	0.0077 (0.0056)	0.0122 (0.0083)
	L2	---	---	---	0.0051 (0.0056)	-0.0019 (0.0083)
CC	L1	---	---	---	0.0133** (0.0041)	0.0127* (0.0060)
	L2	---	---	---	0.0082 (0.0043)	0.0109 (0.0062)

RC	L1	---	---	---	0.0057 (0.0081)	0.0157 (0.0119)
	L2	---	---	---	-0.0051 (0.0090)	-0.0102 (0.0133)
Quality	L1	0.1093*** (0.0126)	0.0105 (0.0068)	0.0554 (0.0329)	---	---
	L2	0.0331** (0.0127)	0.0022 (0.0054)	0.0651 (0.0426)	---	---
Quantity	L1	0.0562*** (0.0097)	0.0043 (0.0046)	0.0281 (0.0239)	---	---
	L2	0.0231* (0.0099)	0.0038 (0.0038)	0.0218 (0.0298)	---	---

\*\*\* Sig. at  $p < 0.001$ ; \*\* Sig. at  $p < 0.01$ ; \* sig. at  $p < 0.05$

Table 3. Results of Causality Tests (High Participation Level; 182 users)

## 4 Discussion

In this study, we are interested in examining the interactions between users' social capital and their knowledge contribution in the OUC context. Further, we investigate the causal relationships based on users with different levels of participation. For users with low and medium participation levels, our results (see Table 2) indicate that a two-way relationship exists between their knowledge contribution and social capital. However, the causal relationships, either between social capital and knowledge contribution or between knowledge contribution and the change of social capital, are not strictly persistent. Our explanation to this finding is twofold. First, we suggest that the effect of social capital on knowledge contribution is nonlinear. This is because when users' social capital increases, they may not be as motivated to contribute more compared to the time when they only possessed a small amount of social capital. For example, an additional 5 incoming ties (i.e., structural capital) should matter more for a user who has no ties than for a user who has 100 ties already. In other words, the marginal effect of more social capital on knowledge contribution should be decreasing in the long run. The results (see Table 3) of users with high participation level (i.e., those who have possessed extensive social capital) also echo with this explanation showing that the effects of structural, cognitive and relational capital on knowledge contribution are largely insignificant.

Second, we suggest that community growth and the resulting community size may have an impact on the relationship between knowledge contribution and social capital change. A large community provides more interaction opportunities, but individual interactions are more likely to remain unnoticed by other members (Wang et al. 2013; Wasko et al. 2004). These may impact the emergence, form and loss of social capital within a community (Wasko and Faraj 2005; Lin 2001). On the other hand, it may be difficult for members to continue to grow their social ties and expertise in a community that grows slowly, regardless of their knowledge contribution (Butler 2001; Hsiao and Chiou 2012). Unfortunately, in the present study we were not able to examine the influence of community growth and size on the causal relationships. Future studies applying comparative analysis based on multi-community data of community growth and size would be valuable to deepen and extend our understanding on the interactions between social capital and knowledge contribution.

Regarding users with high participation level, our results indicate that overall, there are no causal relationships between social capital and knowledge contribution. Nevertheless, several findings are worth discussing. First, the results (upper right in Table 3) show that for this group of users, social capital overall does not influence knowledge contribution. This finding may be explained by the concept of lead users in the OUC research. We suggest that users with high participation level are largely lead users who possess great expertise and community experience and often exhibit different personality traits (e.g., locus of control and innovativeness) than non-lead users (e.g., those in Panel 1). Studies have shown that users with a high degree of lead user characteristics tend to enjoy revealing their knowledge to other users, and their motivation for participation and contribution to the community are largely related to a wish to be recognized by the host firm and peers (Jeppesen and Laursen 2009; Jeppesen and Frederiksen 2006; Mahr and Lievens 2012). Combined, we suggest that social capital (structural, cognitive and relational) should cause knowledge contribution only for non-lead users.

Second, the effects of knowledge contribution on the change of cognitive and relational capital are insignificant (bottom left in Table 3). We measured the change of cognitive capital of a user by calculating the number of correct and/or helpful answers contributed by others that the focal user may learn from. We suggest that compared to peers, experts and experienced users may be overall more likely

to contribute helpful and correct answers when they participate in a discussion. This could lead to no cognitive capital changes even though they have contributed in multiple discussions, based on the measure. Likewise, we measured the change of relational capital by calculating the connections where the focal user and other users followed each other. Such a measure could be problematic where the experienced users did not choose to follow back when they received ties after the knowledge contribution. Given these limitations in variable measurement, future research employing subjective measures via user self-report or survey is needed to confirm and complement our findings.

## 5 Conclusion

The objective of this study was to investigate the interplay between social capital and knowledge contribution in OUC. While previous research has overall shown that users' social capital is a good predictor of their knowledge contribution, this study shows that the relationship between social capital and knowledge contribution is far more complex than just a one-way causal relationship. We find that a two-way relationship exists between social capital and knowledge contribution among users with low and medium participation levels. For users with high participation level, our study shows that their knowledge contribution is not caused primarily by the social capital they possess in the community, while a one-way causal effect of knowledge contribution on the change of structural capital is found. In sum, our study demonstrates evidence of significant bi-directional relationships between social capital and knowledge contribution and examines the conditions (various participation levels) under which the causal relationships will exist.

With these findings, our study also provides practitioners a valuable guideline for the design of OUC. Host firms could integrate the reputation systems with social networking features in the community. Our study demonstrates that implementing social network/media features in the reputation systems will further motivate contribution by visualizing users' social capital in the community. The following/followers feature used by BMC, for instance, not only helps visualize users' social ties and connections and thereby their positions in the network but allows users to know their mutual friends and who knows whom. As a result, users are more likely to be motivated to participate in the community as they recognize the changes in their structural and relational capital. Additionally, the bookmark and notification features allow users to simultaneously derive information and knowledge without logging into the community, facilitating the cognitive capital benefits. Managers and community designers should therefore strategically adopt and implement new features and tools that will enhance social exchange and connectedness within the communities.

## 6 References

- Baltagi, B.H. 2001. *Econometric Analysis of Panel Data*. Second Edition, Hoboken, NJ. Wiley, Inc.
- Benbya, H. 2016. *Successful OSS Project Design and Implementation: Requirements, Tools, Social Designs and Reward Structures*, Routledge.
- Borgatti, S.P. 2005. "Centrality and Network Flow," *Social Networks* (27:1), pp 55–71.
- Borgatti, S.P., and Cross, R. 2003. "A Relational View of Information Seeking and Learning in Social Networks," *Management Science* (49:4), pp 432–45.
- Burt, R.S. 2004. "Structural Holes and Good ideas," *American Journal of Sociology* (110:2), pp 349–99.
- Butler, B.S. 2001. "Membership Size, Communication Activity, and Sustainability: A Resource-Based Model of Online Social Structures," *Information Systems Research* (12:4), pp 346–62.
- Cavanaugh, J.E. and Neath, A.A. 1999. "Generalizing the Derivation of the Schwarz Information Criterion," *Communications in Statistics - Theory and Methods* (28:1), pp 49-66.
- Coleman, J.S. 1988. "Social Capital in the Creation of Human Capital," *American Journal of Sociology* 94, pp 95–120.
- Dahlander, L., and Frederiksen, L. 2012. "The Core and Cosmopolitans: A Relational View of Innovation in User Communities," *Organization Science* (23:4), pp 988–1007.
- Dholakia, U.M., Bagozzi, R.P., and Pearo, L.K. 2004. "A Social Influence Model of Consumer Participation in Network-and Small-Group-Based Virtual Communities," *International Journal of Research in Marketing* (21:3), pp 241–63.

- Faraj, S., Jarvenpaa, S. and Majchrzak, A. 2011. "Knowledge Collaboration in Online Communities," *Organization Science* (22:5), pp 1224–39.
- Faraj, S., Kudaravalli, S., and Wasko, M. 2015. "Leading Collaboration in Online Communities," *MIS Quarterly* (39:2), pp 393–412.
- Granger, C.W. 1969. "Investigating Causal Relations by Econometric Models and Cross-Spectral Methods," *Econometrica* (37:3), pp 424–38.
- Greene, W.H. 2011. *Econometric Analysis*. Los Angeles: Pearson Education, Inc.
- Heshmati, A. and Lööf, H. 2008. "Investment and Performance of Firms: Correlation or Causality?," *Corporate Ownership & Control* (6:2), pp 268–82.
- Hsiao, C.C., and Chiou, J.S. 2012. "The Impact of Online Community Position on Online Game Continuance Intention: Do Game Knowledge and Community Size Matter?," *Information & Management* (49:6), pp 292–300.
- Huysman, M., and Wulf, V. 2006. "IT to Support Knowledge Sharing in Communities: Towards a Social Capital Analysis," *Journal of Information Technology* (21:1), pp 40–51.
- Jeppesen, L.B., and Frederiksen, L. 2006. "Why Do Users Contribute to Firm-Hosted User Communities? The Case of Computer-Controlled Music Instruments," *Organization Science* (17:1), pp 45–63.
- Jeppesen, L.B., and Laursen, K. 2009. "The Role of Lead Users in Knowledge Sharing," *Research Policy*, (38:10), pp 1582–89.
- Johnson, S.L., Jarvenpaa, S., Benbya, H., Barrett, M. and Faraj, S. 2017. "Leadership and Online Communities," *International Conference on Information Systems Proceedings*.
- Johnson, S.L., Safadi, H., and Faraj, S. 2015. "The Emergence of Online Community Leadership," *Information Systems Research* (26:1), pp 165–87.
- Lin, N. 2001. *Social Capital: A Theory of Social Structure and Action*. Cambridge University Press.
- Mahr, D., and Lievens, A. 2012. "Virtual Lead User Communities: Drivers of Knowledge Creation for Innovation," *Research Policy* (41:1), pp 167–77.
- Nahapiet, J., and Ghoshal, S. 1998. "Social Capital, Intellectual Capital, and the Organizational Advantage," *Academy of Management Review* (23:2), pp 242–66.
- Nambisan, S., and Baron, R.A. 2010. "Different Roles, Different Strokes: Organizing Virtual Customer Environments to Promote Two Types of Customer Contributions," *Organization Science* (21:2), pp 554–72.
- Nov, O., Ye, C. and Kumar N. 2012. "A Social Capital Perspective on Meta-Knowledge Contribution and Social Computing," *Decision Support Systems* (53:1), pp 118–26.
- Perry-Smith, J.E. and Shalley, C.E. 2003. "The Social Side of Creativity: A Static and Dynamic Social Network Perspective," *Academy of Management Review* (28:1), pp 89–106.
- Phang, C.W., Kankanhalli, A., and Sabherwal, R. 2009. "Usability and Sociability in Online Communities: A Comparative Study of Knowledge Seeking and Contribution," *Journal of the Association for Information Systems* (10:10), pp 721–47.
- Porter, C.E., and Donthu, N. 2008. "Cultivating Trust and Harvesting Value in Virtual Communities," *Management Science* (54:1), pp 113–28.
- Robert, L.P., Dennis, A.R. and Ahuja M.K. 2008 "Social Capital and Knowledge Integration in Digitally Enabled Teams," *Information Systems Research* (19:3), pp 314–34.
- Wang, X., Butler, B.S., and Ren, Y. 2013. "The Impact of Membership Overlap on Growth: An Ecological Competition View of Online Groups," *Organization Science* (24:2), pp 414–31.
- Wasko, M.M., and Faraj, S. 2005. "Why Should I Share? Examining Social Capital and Knowledge Contribution in Electronic Networks of Practice," *MIS Quarterly* (29:1), pp 35–57.
- Wasko, M.M., Faraj, S., and Teigland, R. 2004. "Collective Action and Knowledge Contribution in Electronic Networks of Practice," *Journal of the Association for Information Systems* (5:11), pp 721–47.

Whelan, E. 2007. "Exploring Knowledge Exchange in Electronic Networks of Practice," *Journal of Information Technology* (22), pp 5-12.

Yan, J.K., Leidner, D and Benbya, H. 2018. "The Differential Innovativeness Outcomes of User and Employee Participation in an Online User Innovation Community," *Journal of Management Information Systems* (35:3), pp 1-34.

## Appendix

Lag	SC-Quality	CC-Quality	RC-Quality	SC-Quantity	CC-Quantity	RC-Quantity	Quality -ΔSC	Quality -ΔCC	Quality -ΔRC	Quantity -ΔSC	Quantity -ΔCC	Quantity -ΔRC
0	5.46	7.10	4.91	7.90	9.54	7.34	4.49	3.07	3.86	6.93	5.52	6.29
1	5.40	7.03	4.85	7.85	9.47	7.30	4.42	3.03	3.83	6.86	5.50	6.27
2	5.40	7.03	4.84	7.84	9.48	7.29	4.41*	2.95*	3.82*	6.85*	4.49*	6.26*
3	5.39	7.02	4.85	7.85	9.47	7.30	4.42	2.96	3.83	6.87	5.50	6.27
4	5.38	7.01	4.84	7.83	9.47	7.30	4.42	2.96	3.83	6.87	5.51	6.28
5	5.37	7.00	4.84	7.83	9.46	7.29	4.42	2.97	3.84	6.88	5.52	6.29
6	5.31	6.98	4.79	7.76	9.44	7.25	4.43	2.97	3.84	6.89	5.52	6.29
7	3.98*	4.68*	3.38*	6.44*	7.45*	5.83*	4.43	2.98	3.83	6.88	5.53	6.29
8	3.99	4.69	3.39	6.45	7.46	5.84	4.43	2.99	3.84	6.89	5.54	6.29
9	3.99	4.69	3.39	6.45	7.46	5.85	4.44	3.00	3.85	6.90	5.55	6.30
10	4.00	4.70	3.4	6.46	7.47	5.86	4.45	3.00	3.86	6.90	5.56	6.31
11	4.01	4.71	3.41	6.47	7.48	5.86	4.45	3.01	3.86	6.91	5.56	6.32
12	4.02	4.72	3.42	6.48	7.49	5.87	4.45	3.02	3.87	6.91	5.57	6.32
13	4.03	4.72	3.42	6.48	7.49	5.88	4.46	3.03	3.87	6.92	5.58	6.33
14	4.03	4.73	3.43	6.49	7.50	5.89	4.46	3.03	3.88	6.92	5.59	6.34
15	4.04	4.74	3.44	6.50	7.51	5.90	4.47	3.04	3.88	6.93	5.59	6.35
16	4.05	4.75	3.44	6.51	7.52	5.91	4.47	3.05	3.89	6.94	5.60	6.36
17	4.06	4.76	3.45	6.52	7.53	5.91	4.48	3.06	3.90	6.95	5.61	6.36
18	4.07	4.77	3.46	6.53	7.54	5.92	4.49	3.07	3.90	6.96	5.62	6.36
19	4.07	4.77	3.47	6.54	7.54	5.93	4.50	3.07	3.91	6.96	5.64	6.37
20	4.08	4.77	3.47	6.56	7.55	5.93	4.50	3.09	3.91	6.98	5.65	6.38

\* indicates lag order selected by the criterion

Table 1. Lag Order Selection Using SIC (Panel 1: 3,330 users)

Lag	SC-Quality	CC-Quality	RC-Quality	SC-Quantity	CC-Quantity	RC-Quantity	Quality -ΔSC	Quality -ΔCC	Quality -ΔRC	Quantity -ΔSC	Quantity -ΔCC	Quantity -ΔRC
0	10.91	9.14	6.87	12.34	10.60	8.31	11.03	4.75	5.88	12.46	9.68	7.32
1	10.72	9.13	6.68	12.24	10.62	8.14	7.45*	4.73*	5.67*	8.92*	6.20*	7.12*
2	10.81	9.24	6.76	12.33	10.73	8.23	7.56	4.84	5.76	9.00	6.22	7.22
3	10.06	9.29	6.83	11.60	10.82	8.33	7.61	4.91	5.78	9.06	6.33	7.30
4	10.16	9.24	6.86	11.71	10.79	8.35	7.70	5.02	5.80	9.12	6.43	7.36
5	10.24	9.19	6.93	11.80	10.73	8.43	7.73	5.07	5.87	9.20	6.53	7.45
6	9.16	9.22	7.00	10.74	10.80	8.51	7.75	5.15	5.94	9.26	6.59	7.55
7	6.55	6.94*	5.92	7.96*	8.52*	7.41*	7.83	5.22	6.01	9.24	6.68	7.55
8	6.53*	6.99	5.91*	7.98	8.62	7.49	7.82	5.20	6.02	9.32	6.69	7.62
9	6.63	7.09	5.97	8.05	8.72	7.55	7.92	5.30	6.11	9.42	6.74	7.66
10	6.64	7.08	5.96	8.16	8.82	7.60	7.94	5.30	6.17	9.50	6.85	7.76
11	6.60	7.10	6.00	8.17	8.92	7.69	7.97	5.32	6.20	9.60	6.95	7.86
12	6.58	7.19	6.00	8.16	9.01	7.70	8.04	5.42	6.29	9.67	7.04	7.95
13	6.61	7.17	6.00	8.22	9.09	7.72	8.10	5.47	6.36	9.76	7.13	8.05
14	6.70	7.26	6.09	8.33	9.20	7.81	8.20	5.57	6.45	9.87	7.23	8.12
15	6.76	7.34	6.14	8.43	9.31	7.90	8.24	5.62	6.54	9.92	7.33	8.22
16	6.81	7.45	6.25	8.47	9.41	8.00	7.99	5.73	6.61	9.77	7.42	8.30
17	6.89	7.49	6.28	8.52	9.44	8.08	8.07	5.83	6.67	9.86	7.50	8.36
18	6.99	7.57	6.35	8.62	9.54	8.18	8.15	5.94	6.75	9.96	7.58	8.47
19	7.07	7.67	6.44	8.68	9.64	8.28	8.22	6.03	6.79	10.06	7.69	8.51
20	7.12	7.75	6.51	8.78	9.71	8.37	8.24	6.13	6.90	10.12	7.88	8.59

\* indicates lag order selected by the criterion

Table 2. Lag Order Selection Using SIC (Panel 2: 182 users)

# IT Service Management Knowledge Ecosystem – Literature Review and a Conceptual Model

## **Muralidharan Ramakrishnan**

School of Management and Enterprise  
University of Southern Queensland  
Toowoomba, Queensland, Australia  
Email: Muralidharan\_ram@hotmail.com

## **Anup Shrestha**

School of Management and Enterprise  
University of Southern Queensland  
Toowoomba, Queensland, Australia  
Email: Anup.Shrestha@usq.edu.au

## **Aileen Cater-Steel**

School of Management and Enterprise  
University of Southern Queensland  
Toowoomba, Queensland, Australia  
Email: Aileen.Cater-Steel@usq.edu.au

## **Jeffrey Soar**

School of Management and Enterprise  
University of Southern Queensland  
Toowoomba, Queensland, Australia  
Email: Jeffrey.Soar@usq.edu.au

## **Abstract**

Information Technology Service Management (ITSM) is a customer-centric approach to manage IT Services in order to provide value to the business. The ITSM Knowledge ecosystem comprises multiple knowledge areas including process frameworks, technology tools and skills. Organisations struggle to comprehend the ecosystem due to the dynamic nature and volume of the business technology environment. A Systematic Literature Review was conducted to understand the state of the current research in ITSM knowledge ecosystem. The review indicated that the focus of the existing research is skewed towards process frameworks knowledge area and neglects tools and training. The approach proposed in the extant research fails to provide a holistic view of the ecosystem. To overcome the limitations a conceptual model is proposed based on Knowledge Commons theory.

**Keywords** ITSM, IT Service Management, ITSM Knowledge Ecosystem, ITIL, Knowledge Commons

## 1 Introduction

Information Technology Service Management (ITSM) is a customer centric approach to manage IT Services in order to provide value to the business (Taylor 2007). The ITSM knowledge ecosystem comprises multiple knowledge areas including process frameworks, technology tools and skills/training. There are many stakeholders who engage in complex interactions utilising different knowledge areas. Table 1 shows the typical knowledge life cycle stages, the knowledge areas and examples of key stakeholders within the ITSM knowledge ecosystem.

Knowledge area	Knowledge Lifecycle Stage		
	Generation	Dissemination	Consumption
Process frameworks	Library developers	Professional bodies, symposia, social media, networks	Organisations, consultants, auditors
Tools	Vendors, library	Marketing	Organisations
Training/Skills	Higher education institutions, training providers, skills framework	Higher education institutions, HR trainers, job advertisers	Individuals, training providers, Hiring Managers

Table 1 Key stakeholders within the ITSM knowledge ecosystem

In ITSM practice, there are many complementary process frameworks including, but not limited to, COBIT®, ISO/IEC 20000, Lean Six Sigma, Project Management Body of Knowledge (PMBOK®), PRINCE2®, Agile, SCRUM, TOGAF®, DevOps, CMMI® and ITIL®. Organisations often leverage more than one framework to meet their business objectives (Cater-Steel et al. 2006).

Some process frameworks have an extensive range of technology tools to support their implementation. The tools play a pivotal role in automating the process steps, integrating with other processes and providing a user interface for process execution and control.

Likewise, the process frameworks typically offer relevant skill certifications for practitioners. The certification schemes differ between process frameworks. The process frameworks, tools and skills maintain symbiotic relationships within the ITSM ecosystem.

### 1.1 Research problem

In a dynamic business technology environment, organisations need to continually look out for a complementary mix of process frameworks, supporting tools and updated skills for their employees. However, the existence of multiple process frameworks causes confusion, inefficiency and ineffectiveness (Heston and Phifer 2011). To address these issues, the research problem “*Within the ITSM Knowledge ecosystem, no single platform that provides a holistic, contemporary view of all knowledge areas exists*” is considered.

The research will design and evaluate a Self-Managing ITSM Knowledge Repository (SIKR). SIKR will be a useful resource for organisations during strategic planning as it provides a comprehensive view of complementary frameworks, tools and competencies. Evaluating the use of multiple frameworks within organisations is outside the scope of the research.

## 2 Literature Review

The research follows the Design Science Research (DSR) methodology (Hevner 2004). As part of the DSR methodology, a Systematic Literature Review (SLR) is conducted to understand the current state of research knowledge. The SLR addresses the following questions:

- How is the research coverage of knowledge areas distributed?
- What are the primary techniques used to harmonise multiple process frameworks?
- Are these techniques suitable for modelling ITSM knowledge ecosystem holistically?

SLR is a structured and rigorous approach to conduct a literature review (Kitchenham et al. 2009). This research uses the SLR strategy to define the search approach, inclusion and exclusion criteria, data collection and analysis. Among the ITSM process frameworks, ITIL is the most widely adopted framework (Marrone et al. 2014). As ITIL framework spans across the entire ITSM Lifecycle, “ITIL” is used as the bridging keyword in the literature search. To cover additional relevant research papers, the

search terms “ITSM” and “IT Service Management” are included. Table 2 shows the summary of the literature review strategy.

<b>Criteria</b>	<b>Search terms</b>
Search keyword combinations	(ITIL AND COBIT) OR (ITIL AND “Six Sigma”) OR (ITIL AND Lean) OR (ITIL AND CMMI) OR (ITIL AND Agile) OR (ITIL AND DevOps) OR (ITSM OR IT Service Management)
Databases	Google Scholar, ACM Digital Library, Applied Science and Technology Source Ultimate, Business Source Ultimate, IEEE Xplore - IET
Language	English
Article type	Academic journals, Conference papers
Options	Scholarly (Peer reviewed) Publications, Full Text, References available, conference papers
Date Range	Jan 2000 to June 2018
Inclusion Criteria	Papers on process frameworks with specific focus on integration/harmonisation of multiple process frameworks
Exclusion Criteria	Papers outside identified process frameworks; focused on only one framework; those do not include any analysis of the overlap/integration between the process frameworks

*Table 2 Literature review strategy*

The search found 654 papers that satisfied the search criteria. The paper title and abstracts were screened reducing the set to 67 papers that discussed multiple process frameworks. Duplicate papers and papers that discussed only one framework were rejected. These 67 papers were studied to select 41 papers to be included in literature review based on inclusion criteria outlined in Table 2. The shortlisted literature comprises 15 journal articles and 26 conference papers as listed in Appendix A. To analyse the results the codification approach presented in Table 3 was followed.

<b>Code</b>	<b>Description</b>	<b>Value</b>
Knowledge area	The predominant knowledge area discussed in the research	Process, skills, tools
Process framework coverage	The process frameworks discussed in the research	ITIL, COBIT, CMMI, ISO, DevOps, Lean, Agile, Six Sigma, PMBOK
Process integration approach	Approach to describe the relationships between process frameworks	Mapping, combination, ontology

*Table 3 Codification approach*

### 3 Results and Discussion

The knowledge areas were classified as process frameworks, tools and skills. The result indicates that 38 out of 41 included articles addressed the process framework area. The process framework research is focussed on developing a conceptual process model, a map or ontology. Only three papers discussed the issue of skills and no research was found in the tools category. The integration approaches can be broadly classified into mapping and structured ontology. Mapping is a technique of describing the relationship between related processes. Mapping was used by 23 papers to understand the relationship between process frameworks. The structured ontology provides a more formal approach to define the relationship between two entities. Pardo et al. (2013; 2012; 2014) proposed techniques for ontology mapping. The ontology-based approach would suit for process harmonisation of two to three frameworks. Since the ontological model is based on reductionist approach, it cannot harmonise large number of process frameworks due to the inability in managing large amounts of information (Mejia et al. 2016). The summary of findings to research questions is provided in Table 4.

<b>Research question</b>	<b>Findings</b>
How is the research coverage of knowledge areas distributed?	92.7% Process Frameworks, 7.3% Skills, 0% Tools



What are the primary techniques used to integrate multiple process frameworks?	Mapping, Ontology
Are these techniques suitable for modelling ITSM knowledge ecosystem holistically?	The techniques are not suitable for holistic modelling

Table 4 Literature review summary

## 4 Conceptual Model

The limitations identified through the SLR include the inadequate coverage of tools and skills and inability of mapping/ontological approaches to provide a holistic view of the ITSM knowledge ecosystem. To address these limitations a fundamentally different approach is proposed based on Knowledge Commons theory (Hess and Ostrom 2007).

The term "Commons" is defined as "a general term that refers to resource shared by a group of people" (Hess and Ostrom 2007). The Commons economic theory is applied in the study of shared natural resources such as water resources, forests, fisheries, wildlife, knowledge management, and Free/open-source software (FOSS) (Macbeth and Pitt 2015). Institutional Analysis Development (IAD) Framework was proposed by Ostrom (1999) to systematically analyse the Commons. Frischmann et al. (2014) argued that the IAD framework needs to be tailored to suit knowledge commons. Drawing inspiration from IAD, this research proposes an alternative conceptual model of Knowledge Commons shown in Figure 1. The conceptual model consists of technical layer, community layer and usage layer. The technical layer is a platform for storing the knowledge artefacts. A practitioner community will contribute to the knowledge creation and governance of the repository. The usage layer will include knowledge consumers.

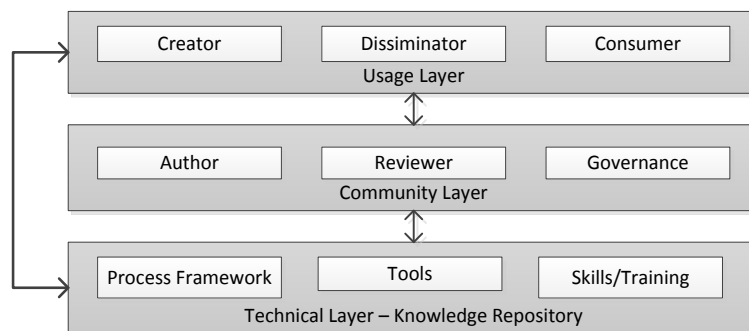

Figure 1 ITSM Knowledge Commons Conceptual Model

## 5 Conclusion and Future Research Directions

The literature review indicates that the existing research approaches fail to provide a holistic view of the ITSM Knowledge ecosystem. To overcome the limitations of the current research, a conceptual model based on Knowledge Commons is proposed. The conceptual model's practical and theoretical implications will be explored in the research. Based on the conceptual model, the research will develop a Self-managing ITSM Knowledge Repository (SIKR) using DSR methodology. The suitability and tailoring of DSR will be addressed by the research. In addition, the research will contribute to existing ITSM literature and position the results in current debate on ITSM. The research will be relevant to ITSM practitioners as SIKR is expected to provide a reliable knowledge platform.

## 6 References

- Bahn, D., Betz, C., Gluhova, S., Khan, F., Lebens, M., Mosman, M., Paulson, P., Olagunju, A., Opatrny, J., Spencer, G., and Tarmizi, H. 2016. "Renewing the IT Curriculum: Responding to Agile, DevOps, and Digital Transformation." Retrieved 21/07/2018, from <http://dynamicit.education/>
- Berrahal, W., and Marghoubi, R. 2016. "Lean continuous improvement to information technology service management implementation: Projection of ITIL framework," *2016 International Conference on Information Technology for Organizations Development (IT4OD)*, pp. 1-6.
- Cater-Steel, A., Tan, W.-G., and Toleman, M. 2006. "Challenge of adopting multiple process improvement frameworks," *Proceedings of 14th European conference on information systems (ECIS 2006)*: European Conference on Information Systems, pp. 1375-1386.

- Cater-Steel, A., and Toleman, M. 2007. "Education for IT service management standards," *International Journal of IT Standards and Standardization Research* (5 (2)), pp 27-41.
- Ehsan, N., Malik, O.A., Shabbir, F., Mirza, E., and Bhatti, M.W. 2010. "Comparative study for PMBOK & CMMI frameworks and identifying possibilities for integrating ITIL for addressing needs of IT service industry," *2010 IEEE International Conference on Management of Innovation & Technology*, pp. 113-116.
- Ekanata, A., and Girsang, A.S. 2017. "Assessment of capability level and IT governance improvement based on COBIT and ITIL framework at communication center ministry of foreign affairs," *2017 International Conference on ICT For Smart Society (ICISS)*, pp. 1-7.
- Evelina, E., Pia, G., David, H., Liv, M.v.W., and Waldo, R.F. 2010. "Process improvement framework evaluation," *2010 International Conference on Management Science & Engineering 17th Annual Conference Proceedings*, pp. 319-326.
- Frischmann, B.M., Madison, M.J., and Strandburg, K.J. 2014. *Governing knowledge commons*. Oxford University Press.
- Heschl, J. 2008. "Mapping ITIL v3 to COBIT," *COBIT Focus* (1), pp 13-16.
- Hess, C., and Ostrom, E. 2007. *Understanding knowledge as a commons*. Cambridge, Massachusetts, London, England: The MIT Press.
- Heston, K.M., and Phifer, W. 2011. "The multiple quality models paradox: how much 'best practice' is just enough?," *Journal of Software Maintenance & Evolution: Research & Practice* (23:8), pp 517-531.
- Hevner, A.R. 2004. "Design Science In Information Systems Research," *MIS Quarterly* (28:1), pp 75-105.
- Huang, Z., Zavarisky, P., and Ruhl, R. 2009. "An Efficient Framework for IT Controls of Bill 198 (Canada Sarbanes-Oxley) Compliance by Aligning COBIT 4.1, ITIL v3 and ISO/IEC 27002," *2009 International Conference on Computational Science and Engineering*, pp. 386-391.
- Jeners, S., Lichter, H., and Pyatkova, E. 2012. "Automated Comparison of Process Improvement Reference Models Based on Similarity Metrics," *2012 19th Asia-Pacific Software Engineering Conference*, pp. 743-748.
- Jeners, S., Lichter, H., and Rosenkranz, C.G. 2013. "Efficient Adoption and Assessment of Multiple Process Improvement Reference Models," *e-Informatica* (7:1), pp 15-24.
- Karkoskova, S., and Feuerlicht, G. 2015. "Extending MBI Model using ITIL and COBIT Processes," *Journal of Systems Integration (1804-2724)* (6:4), pp 29-44.
- Kitchenham, B., Brereton, O.P., Budgen, D., Turner, M., Bailey, J., and Linkman, S. 2009. "Systematic literature reviews in software engineering—a systematic literature review," *Information and software technology* (51:1), pp 7-15.
- Kundu, G.K., Murali Manohar, B., and Bairi, J. 2011. "A comparison of lean and CMMI for services (CMMI-SVC v1.2) best practices," *Asian Journal on Quality* (12:2), pp 144-166.
- Kusumah, P., Sutikno, S., and Rosmansyah, Y. 2014. "Model design of information security governance assessment with collaborative integration of COBIT 5 and ITIL (case study: INTRAC)," *2014 International Conference on ICT For Smart Society (ICISS)*, pp. 1-6.
- Latif, A.A., Din, M.M., and Ismail, R. 2010. "Challenges in Adopting and Integrating ITIL and CMMi in ICT Division of a Public Utility Company," *2010 Second International Conference on Computer Engineering and Applications*, pp. 81-86.
- Lin, L.-C., Li, T.-S., and Kiang, J.P. 2009. "A continual improvement framework with integration of CMMI and six-sigma model for auto industry," *Quality and Reliability Engineering International* (25:5), pp 551-569.
- Lino, A., and da Silva, M. 2008. "Improving ITIL processes using a Lean Methodology," *Instituto Superior Tecnico*.
- Macbeth, S., and Pitt, J.V. 2015. "Self-organising management of user-generated data and knowledge," *The Knowledge Engineering Review* (30:3), pp 237-264.
- Marrone, M., Gacenga, F., Cater-Steel, A., and Kolbe, L. 2014. "IT service management: A cross-national study of ITIL adoption," *Communications of the association for information systems* (34).
- McCarthy, M.A., Herger, L.M., Khan, S.M., and Belgodere, B.M. 2015. "Composable DevOps: Automated Ontology Based DevOps Maturity Analysis," *2015 IEEE International Conference on Services Computing*, pp. 600-607.
- Mejia, J., Muñoz, E., and Muñoz, M. 2016. "Reinforcing the applicability of multi-model environments for software process improvement using knowledge management," *Science of Computer Programming* (121), pp 3-15.
- Năstase, P., Năstase, F., and Ionescu, C. 2009. "Challenges generated by the implementation of the IT standards COBIT 4.1, ITIL v3 and ISO/IEC 27002 in enterprises," *Economic Computation & Economic Cybernetics Studies & Research* (43:3), pp 1-16.

- Oktadini, N.R., and Surendro, K. 2014. "SLA in cloud computing: Improving SLA's life cycle applying six sigma," *2014 International Conference on Information Technology Systems and Innovation (ICITSI)*, pp. 279-283.
- Ostrom, E. 1999. "Coping with tragedies of the commons," *Annual review of political science* (2:1), pp 493-535.
- Pardo, C., Pino, F.J., Garcia, F., Baldassarre, M.T., and Piattini, M. 2013. "From chaos to the systematic harmonization of multiple reference models: A harmonization framework applied in two case studies," *Journal of Systems and Software* (86:1), pp 125-143.
- Pardo, C., Pino, F.J., García, F.F.G.u.e., Piattini, M.M.P.u.e., and Baldassarre, M.T.b.d.u.i. 2012. "An ontology for the harmonization of multiple standards and models," *Computer Standards & Interfaces* (34:1), pp 48-59.
- Pardo, C.J., García-Rubio, F.O., Piattini- Velthuis, M., Pino-Correa, F.J., and Baldassarre, M.T. 2014. "A reference ontology for harmonizing process- reference models," *Revista Facultad de Ingeniería Universidad de Antioquia*, pp 29-42.
- Parvizi, R., Oghbaei, F., and Khayami, S.R. 2013. "Using COBIT and ITIL frameworks to establish the alignment of business and IT organizations as one of the critical success factors in ERP implementation," *The 5th Conference on Information and Knowledge Technology*, pp. 274-278.
- Pillai, A.K.R., Pundir, A.K., and Ganapathy, L. 2014. "Improving information technology infrastructure library service delivery using an integrated lean six sigma framework: A case study in a software application support scenario," *Journal of Software Engineering and Applications* (7:06), p 483.
- Pinheiro, M.G., and Misaghi, M. 2014. "Proposal of a Framework of Lean Governance and Management of Enterprise IT," in: *Proceedings of the 16th International Conference on Information Integration and Web-based Applications* Hanoi, Viet Nam: ACM, pp. 554-558.
- Pirta, R., and Grabis, J. 2015. "Integrated Methodology for Information System Change Control Based on Enterprise Architecture Models," *Information Technology & Management Science* (18:1), pp 103-108.
- Pricope, S., and Lichter, H. 2011. "A model based integration approach for reference models," in: *Proceedings of the 12th International Conference on Product Focused Software Development and Process Improvement*. Torre Canne, Brindisi, Italy: ACM, pp. 6-9.
- Ramachandran, R. 2013. "Capability determinants of information communications technology services (ICTS) sector: a Malaysian policy perspective," in: *Proceedings of the 7th International Conference on Theory and Practice of Electronic Governance*. Seoul, Republic of Korea: ACM, pp. 116-119.
- Sahibudin, S., Sharifi, M., and Ayat, M. 2008. "Combining ITIL, COBIT and ISO/IEC 27002 in Order to Design a Comprehensive IT Framework in Organizations," *2008 Second Asia International Conference on Modelling & Simulation (AMS)*, pp. 749-753.
- Sánchez Peña, J.J., Fernández Vicente, E., and Ocaña, A.M. 2013. "ITIL, COBIT and EFQM: Can They Work Together?," *International Journal of Combinatorial Optimization Problems & Informatics* (4:1), pp 54-64.
- Sheikhpour, R., and Modiri, N. 2012. "An approach to map COBIT processes to ISO/IEC 27001 information security management controls," *International Journal of Security and Its Applications* (6:2), pp 13-28.
- Stroud, R.E. 2010. "Governing and Managing the Operational Environment With COBIT and ITIL," *COBIT Focus* (4), pp 9-12.
- Tajammul, M., and Parveen, R. 2017. "Comparative analysis of big ten ISMS standards and their effect on cloud computing," *2017 International Conference on Computing and Communication Technologies for Smart Nation (IC3TSN)*, pp. 362-367.
- Taylor, S. 2007. "The official introduction to the ITIL service lifecycle," *The Stationary Office, London*.
- Tshinu, S.M., Botha, G., and Herselman, M. 2008. "An Integrated ICT Management Framework for Commercial Banking Organisations in South Africa," *Interdisciplinary Journal of Information, Knowledge & Management* (3), pp 39-53.
- Verlaine, B., Jureta, I., and Faulkner, S. 2016. "How can ITIL and Agile Project Management coexist?," *International Conference on Exploring Services Science: Springer*, pp. 327-342.
- Veronica, and Suryawan, A.D. 2017. "Information technology service performance management using COBIT and an ITIL framework: A systematic literature review," *2017 International Conference on Information Management and Technology (ICIMTech)*, pp. 150-155.
- Von Solms, B. 2005. "Information Security governance: COBIT or ISO 17799 or both?," *Computers & Security* (24:2), pp 99-104.

Wickboldt, J.A., Bianchin, L.A., Lunardi, R.C., Granville, L.Z., Gasparly, L.P., and Bartolini, C. 2011. "A framework for risk assessment based on analysis of historical information of workflow execution in IT systems," *Computer Networks* (55:13), pp 2954-2975.

## 7 Appendix A: Analysed Research Papers in SLR

Authors	Coverage	Knowledge area	Approach
(Berrahal and Marghoubi 2016)	Lean, ITIL	Process	Mapping
(Bahn et al. 2016)	Agile, DevOps	Skills	Curriculum
(Cater-Steel and Toleman 2007)	ITIL, ISO/IEC 20000	Skills	Review of skills
(Cater-Steel et al. 2006)	ITIL, COBIT, CMMI, ISO 9001	Process	Survey
(Ehsan et al. 2010)	PMBOK, CMMI, ITIL	Process	Mapping
(Ekanata and Girsang 2017)	COBIT, ITIL	Process	Mapping
(Evelina et al. 2010)	ITIL, COBIT, CMMI, ISO 9000	Process	Mapping
(Heschl 2008)	COBIT, ITIL	Process	Mapping
(Heston and Phifer 2011)	ISO 9001:2000; Lean Six Sigma; CMMI; ITIL; ISO 27001	Process	Combine
(Huang et al. 2009)	COBIT, ITIL, ISO/IEC 27002	Process	Mapping
(Jeners et al. 2012)	CMMI, ITIL, COBIT	Process	Model- metrics
(Jeners et al. 2013)	ITIL, COBIT, CMMI	Process	Integration
(Karkoskova and Feuerlicht 2015)	ITIL, COBIT, MBI	Process	Mapping
(Kundu et al. 2011)	CMMI, Lean	Process	Mapping
(Kusumah et al. 2014)	COBIT, ITIL	Process	Mapping
(Latif et al. 2010)	ITIL, CMMI, PRINCE2, PMBOK, COBIT	Process	Mapping
(Lin et al. 2009)	CMMI, Six Sigma	Process	Combined
(Lino and da Silva 2008)	Lean, ITIL	Process	Unclassified
(McCarthy et al. 2015)	DevOps, ITIL	Process	Architecture
(Mejia et al. 2016)	ITIL, COBIT, CMMI, Six sigma	Process	Mapping
(Năstase et al. 2009)	COBIT, ITIL, ISO/IEC 27002	Process	Mapping
(Oktadini and Surendro 2014)	ITIL, Six Sigma	Process	Mapping
(Pardo et al. 2012)	ITIL, ISO, CMMI, COBIT	Process	Ontology
(Pardo et al. 2013)	CMMI, ITIL, COBIT, SWEBOK	Process	Ontology
(Pardo et al. 2014)	CMMI, ISO, ITIL, COBIT, RiskIT	Process	Mapping
(Parvizi et al. 2013)	ITIL, COBIT	Process	Unclassified
(Pillai et al. 2014)	ITIL, Lean Six Sigma	Process	Action research
(Pinheiro and Misaghi 2014)	Lean, ITIL, CMMI, COBIT	Process	Mapping
(Pirta and Grabis 2015)	ITIL, COBIT, ValIT	Process	Combine
(Pricope and Lichter 2011)	Generic	Process	Architecture
(Ramachandran 2013)	CMMI, ITIL, PMPOK, Six Sigma	Skills	Mapping
(Sahibudin et al. 2008)	ITIL, COBIT, ISO/IEC 27002	Process	Mapping
(Sánchez Peña et al. 2013)	ITIL, COBIT, EFQM	Process	Mapping
(Sheikhpour and Modiri 2012)	COBIT, ISO/IEC 27001	Process	Mapping
(Stroud 2010)	COBIT, ITIL	Process	Mapping
(Tajammul and Parveen 2017)	ISO27001, PRINCE2, COBIT, OPM3, CMMI, ITIL	Process	Mapping
(Tshinu et al. 2008)	ITIL, COBIT, CMMI	Process	Combine
(Verlaine et al. 2016)	ITIL, Agile (SCRUM)	Process	Mapping
(Veronica and Suryawan 2017)	ITIL, COBIT	Process	Literature Review
(Von Solms 2005)	COBIT/ISO17799	Process	Mapping
(Wickboldt et al. 2011)	ITIL, PMBOK, COBIT, M_o_R	Process	Combine

## Copyright

**Copyright:** © 2018 M. Ramakrishnan, A. Shrestha, A. Cater-Steel and J. Soar. This is an open-access article distributed under the terms of the [Creative Commons Attribution-NonCommercial 3.0 Australia License](https://creativecommons.org/licenses/by-nc/3.0/australia/), which permits non-commercial use, distribution, and reproduction in any medium, provided the original author and ACIS are credited.

# Uncovering Complexity in the Jakarta Energy Planning Process using Agent-Oriented Analysis

## Yohanes Dwi Anggoro

School of Systems, Management and Leadership  
University of Technology Sydney  
New South Wales, Australia  
Email: yohanes.d.anggoro@student.uts.edu.au

## Suwin Sandu

School of Systems, Management and Leadership  
University of Technology Sydney  
New South Wales, Australia  
Email: suwin.sandu@uts.edu.au

## Ghassan Beydoun

School of Systems, Management and Leadership  
University of Technology Sydney  
New South Wales, Australia  
Email: ghassan.beydoun@uts.edu.au

## Abstract

The Jakarta Energy Planning Process (JEPP) is expected to be a successful template for other provinces in Indonesia. However, JEPP consists of a complex set of interrelated activities. These activities are fraught with difficulties and errors, including incorrectness, inconsistency, incompleteness, and redundancy in the process under which the Jakarta energy planning is undertaken. This paper aims to identify complexity issues in JEPP with the aim to alleviate these complexities using Agent-Oriented Analysis (AOA). This research uses the Design Science Research (DSR) method and towards the analysis employs seven Agent-Based Modellings (ABMs), including goal model, role model, organisation model, interaction model, environment model, agent model, and scenario model. The research consists of five stages: the synthesis of a preliminary knowledge analysis framework, the identification of complexity issues, recommendation synthesis, and finally the development of the complete knowledge analysis framework. While the analysis undertaken in this paper focuses on Jakarta, the developed knowledge analysis framework should be useful for energy planners in other regions, and research communities in general who are involved in such endeavours in developing complex planning processes.

**Keywords:** Agent Oriented Analysis, Energy Planning Process, Knowledge Framework, Complexity Issues.

## 1 Introduction

Jakarta, as the capital city of Indonesia, is expected to act as a role model for the achievement of the National Energy Policy targets set by the National Energy Council. All team members and energy stakeholders involved in the Jakarta Energy Planning Team are also expected to plan future energy needs effectively and to contribute significantly to meet the national energy mix in a sustainable and an environmentally friendly manner. However, energy planning activities and processes are inherently complex. Many inconsistency problems and constraint violations invariably arise in system development and implementation process, in particular where knowledge modelling is incrementally undertaken (Sarmiento et al. 2015; Beydoun et al. 1998). According to Balint et al (2011), some of the common problems that may arise in the energy planning system such as a lack of a single problem statement, administrative and scientific complexity, conflicting data values, conflicting objectives, political complexity, a dynamic and a changing context, and multiplicity of actors involved. Furthermore, another common problem for a process system is the duplication of efforts in the process. Repetitive steps often reduce the quality of the process and confuse the actors involved. Collecting data and maintaining its quality are also major challenges in the energy planning process both nationally and regionally (Cajot et al. 2017). It is paramount to clearly identify the core issues in the Jakarta energy planning process to formulate the complex energy planning process and this is yet to be adequately undertaken (Cajot et al. 2017).

The objectives of this paper is to improve JEPP. The paper provides a preliminary knowledge analysis framework aiming to provide a recommendation to reduce complexity issues in the energy planning process. The main research question in this paper is “How can Agent-Oriented Analysis (AOA) alleviate several challenges of energy planning process?”. Towards a problem solving through effective and efficient analysis of information system, this research deploys seven ABMs from the Agent-Oriented Software Engineering (AOSE) practice. The models have proved sufficient to cover more than 20 AOSE existing methodologies (Beydoun et al. 2009; Lopez-Lorca et al. 2016). This approach has proved effective in identifying and developing several issues in a complex system (Liang et al. 2013; Miller et al. 2014; Shvartsman and Taveter 2014; Inan 2015). The chosen ABMs are goal model, role model, organisation model, interaction model, environment model, agent model, and scenario model. The use of this methodology addresses a broader research complexity management question by constructing and evaluating knowledge artefact design to understand and solve human and organization complex problems.

The rest of this paper is organized as follows: The next section reviews the development of agent technology and ABMs in the area of complex systems. The third section describes the methodology used in this research. The fourth section presents the overview of JEPP. The fifth section provides the research results and discussions on knowledge analysis framework. Finally, the sixth section concludes with a discussion of future work.

## 2 Related Work

The use of the term agent has been widely used, including in the field of informatics and computer science, industrial, manufacturing, business, and electronic commerce. It resulted in the increasingly unclear definition of agent, as any researcher trying to define the agent with the background knowledge they have (Wooldridge & Jennings 1995). In the development of agent technology, there are more numerous and complicated tasks that have to be done by an agent in a system, and it requires more agents in a system to complete those tasks. The paradigm of system development where there are multiple agents in a system, which interacts, negotiates and coordinate each other to carry out and complete the tasks is called as the Multi-Agent System (MAS). The MAS as sub-field of the Artificial Intelligence (AI) aims to provide construction principles of a complex system involving several agents and coordination mechanisms for behaviours of the independent agents. Therefore, the MAS approach also can fulfil the user needs and meet the user’s requirements, which can be very complex (Al-azawi and Ayesah 2013), for instance peer-to-peer community based searching systems (Beydoun et al. 2011), and supply chain management (Xu et al. 2011).

The system development is often interpreted as a process to improve existing system by developing a new system to replace the old system. There are some reasons the old system needs to be repaired or replaced, such as the existence of various problems, irregularities in the system, the growth of the organization, to achieve a greater chance, the system changes requested by the user. According to Akbari (2010), AOSE methodology is a business process of system development by using different concept and modeling tools of an agent, and put agents as central modelling to evolve system development paradigm (Wooldridge 1999; Ashamalla et al. 2017). It has been widely used in many domains, including robotics, networking, security, traffic control, gaming and commerce (Akbari 2010), disaster management (Inan et al. 2015). Furthermore, Lopez-Lorca (2016) argue that the Agent-Oriented Analysis (AOA) as an analysis phase in a development life cycle based on AOSE methodology, which aims to capture some knowledge characteristics of existing system that need to be developed. Some literatures have demonstrated the effectiveness of AOA to capture complex knowledge characteristics of a particular domain, which contain various activities and constraints. For example, the use of AOA for the system development of health decision support framework (Liang et al. 2013), military training scenarios (Shvartsman and Taveter 2014), and aircraft turnaround simulation (Miller et al. 2014).

## 3 Research Methodology

The selection of methodology in this research is vital as it will directly affect the achievement of the study objectives and results (Silver et al. 1995, Zmud 1997). This research use the Design Science Research (DSR) method to assist a problem solving through effective and efficient analysis of information system (Hevner et al., 2004). The purpose of employing the DSR method in this research is to develop a knowledge analysis framework for identifying real complex problem in energy planning processes and providing recommendation to improve these processes.

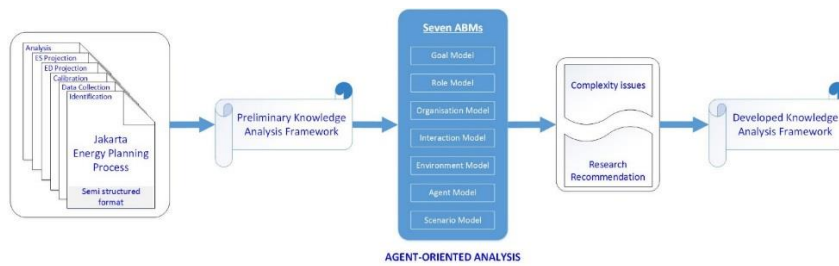

Figure 1. The Agent-Oriented Analysis (AOA) Stages.

Figure 1 describes several stages in this research. Firstly, the input of this research comes from JEPP workflow, which contains detail information of the energy planning process. Secondly, the preliminary knowledge analysis framework is developed based on information contained in JEPP workflow. Thirdly, the AOA of the preliminary knowledge analysis framework is undertaken using seven ABMs in the AOSE methodology to synthesise and to capture complex knowledge of JEPP. Fourthly, based on AOA results, the real complexity issues of JEPP is identified. Finally, the output of this research will provide developed knowledge analysis framework by considering the research recommendation results.

## 4 Jakarta’s Energy Planning Process

Generally, the energy planning process at either regional or national level requires a diversity of inputs and coordination of various fields, stakeholders and information to achieve a goal of developing sustainable energy systems. The JEPP consists of six main steps, including energy issues and study goal identification, overview of existing energy supply system, calibration of energy system modelling, energy demand projection, energy supply projection, and results analysis. According to the Jakarta Governor Decree No. 989 Year 2017, the study team of the Regional Energy General Plan (REGP) of the Jakarta province consists of six main organizational elements, including University (U), Districts (D), Regional Planning Agency (RPA), Regional Secretariat (RS), Regional Department (RD), and Regional Technical Institution (RTI). Each of these organisations has several actors who involve directly on the study implementation and responsible to the study coordinator. In total, there are more than 20 actors as team members. In addition, it also involves some energy stakeholders in 10 organisations at national level to support the study team in collecting socio-technical data to complete the regional energy planning study.

## 5 Results and Discussion

### 5.1 Preliminary Knowledge Analysis Framework

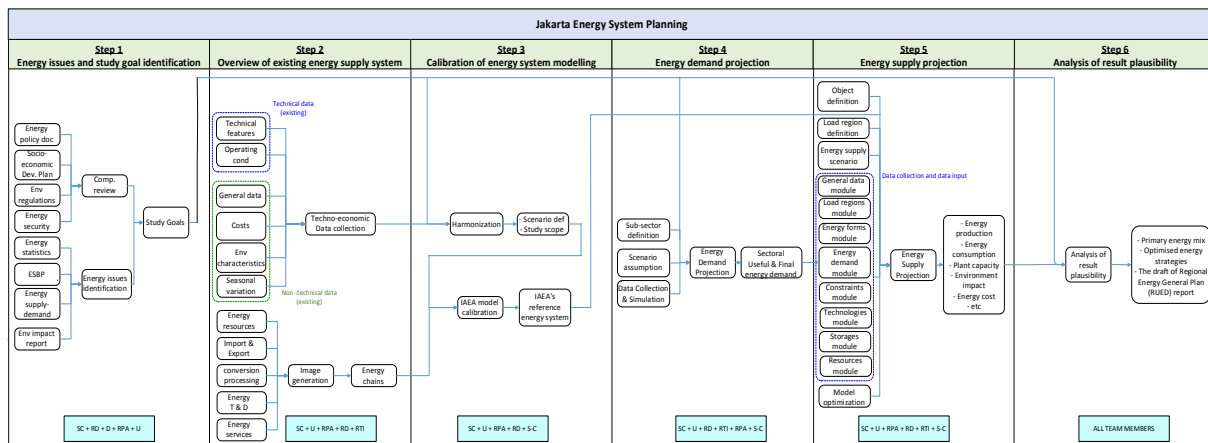

Figure 2. Preliminary knowledge analysis framework

Figure 2 presents the preliminary knowledge analysis framework of JEPP, which shows all activities and actors involved in each process. This preliminary framework aims to capture all existing knowledge of JEPP in a comprehensive and systematic manner based on information described in previous section, so that the complex energy planning process can be relatively easily understood. As a result, the preliminary knowledge analysis framework of JEPP as shown in Figure 2 able to describe all detail energy planning activities performed by the Jakarta energy planning team sequentially and systematically.



## 5.2 Agent-Oriented Analysis

This section describes the agent-oriented analysis within the preliminary knowledge analysis framework. It details the generation of several ABMs including goal model, role model, organisation model, interaction model, environment model, agent model, and scenario model.

### 5.2.1 The goal model

This research starts with the goal model at the beginning of the AOA, and put it as central modelling because it will become the basis for other ABMs to be processed. This research identified all six main goal models and 17 sub-goal models, which cover more than 90 activities or steps of the Jakarta energy planning process. Furthermore, it also identified each role involved in each goal and sub-goal. These goal models are identified to describe and explain the purpose and goal hierarchy in JEPP. It also presents some knowledge elements, including: First, there are two knowledge elements, i.e. the goal (a main goal and 17 sub-goals) and the role. Second, the objective of energy planning activities is to achieve the main goal. Third, the main goal may consists of several sub-goals that must be responsible to achieve the main goal by having element “how-to” achieve the main goal. Fourth, the role(s) refer to the agent role to chase the sub-goal(s).

### 5.2.2 The role model

The role model can be processed after the goal model as the role model represents more detail on responsibilities and constraints that has been identified in the goal model to achieve the system’s goal. This research identified 36 role models, which explain responsibilities of 36 actors/agents involved in the energy planning process based on the Governor Decree No. 989/2017 and real events. The role model presents some knowledge elements, including: First, the unique role ID that obtained from the goal model. Second, the role name element that describes the agent’s role. Third, the description element that provides an explanation about the agent’s role. Fourth, the responsibilities element that describes all roles in order to achieve the goal or sub-goals models. Fifth, the constraints element that defines the condition of the role’s entities (organisations/agencies/individuals).

### 5.2.3 The organisation model

The organisation model is performed based on hierarchy level of the agent involved in the goal model and the role model. This research identified several organization models for 36 agents involved in JEPP. It aims to inform the work relationship, coordination, communication and negotiation between those agents. It presents two knowledge element namely: the roles that obtained from the goal models and the relationship that describe how the roles are related, coordinated, communicated and negotiated each other. Generally, there are two relationship types i.e. isControlledBy relationship, which define that one of the interrelated roles is in higher administration level and have an authority to control others; and isPeer relationship, which define that both of the interrelated roles has same level position and does not have an authority to control each other.

### 5.2.4 The interaction model

The interaction model is performed to connect several activities with their agent’s roles, in which each connection represent an activity that has to be done to achieve main goal or sub-goal defined in the goal model. The knowledge elements captured in the interaction models are as follows: First, the role element is identified based on the goal model and the role model. Second, the activity element, which represent some activities in the sub-goals to achieve the main goal identified in the goal model. Third, the interaction element, which describe the relationship between activities and the agent’s roles.

### 5.2.5 The environment model

The aim of the environment model is to identify environment entity that used by MAS when they pursue main goal or sub-goals defined in the goal model. This research identified twelve environment models where each environment entity also has some environment attributes. Furthermore, the environment model presents some knowledge elements: First, the unique environment entity ID for each environment element. Second, the environment name element that describes the environment type. Third, the description element that provides an explanation about the environment entity. Fourth, the attribute element that provide environment attribute list. Fifth, the role element that inform several agent’s roles who use this environment model.

### 5.2.6 The agent model

The agent model is required to inform a set of equipment owned by one particular agent or actor to achieve each main goal or sub-goal defined in the goal model. This research identified 27 agent models, which explain more detail about all activities trigger and action, and environment entities of each actor. There are many knowledge element captured in the agent model, including agent name element, description element, reference element that obtained from the role model, environment element that obtained from the environment model, and activity element that provide activities list performed by agent to achieve its main goal or sub goal. Then, in each activity element has sub-element such as activity name element, functionality element that describes which main goal or sub-goals need to be achieved in the activity, trigger element that indicates what event will cause the activity start, and action element that describe a set of activities need to be performed when the activity started.

### 5.2.7 The scenario model

The scenario model as the last of AOA is performed to provide detail descriptions of event sequences to achieve main goal or sub-goals defined in the goal model. This research created 17 scenario models, which describe how each scenario starts and ends. It also has many knowledge elements that similar with the knowledge elements in the agent model. However, the activity element in the scenario model provide all activities list, in which set up together with the role element, and the environment element required to achieve particular objective. Then, the condition element aims to inform whether those activities performed in parallel, sequentially or interleaved way. So that, this scenario model can be understood comprehensively and more easily.

## 5.3 Complexity Issues of the Jakarta Energy Planning Process

Based on the results of AOA using the ABMs in the previous section, this research identifies several complex problems in the Jakarta energy planning process, as shown in Figure 3. It shows that there are four categories of complex problems: Firstly, *incorrectness* may occur when the requirements obtained do not accurately reflect the client's future needs. Secondly, *inconsistency* may occur when two or more users have conflicting requirements. Thirdly, *incompleteness* may occur when the clients are not fully understand the overall impact of the current decision. Fourthly, *redundancy* usually occurs because of the lack of collaboration between departments, so a process has been adapted in a less systematic way.

In case of JEPP, this research identified complexity issues occurred in JEPP, such as: the *redundancy* issues (repetition task) and the *inconsistency* issues (conflicting values) occurred in data collection process in step 2, 4, and 5 of JEPP; and data harmonization process between step 3, and step 2, 4, 5 of JEPP. The *incorrectness* issues (scientific complexity and uncertainty) and the *inconsistency* issues (lack of a single problem statement) occurred in energy issues identification process in step 1 of JEPP. Further details, this research identified the *redundancy issues* of data collection process when there are several data collected in step 2, 4, and 5 are similar. For example, step 2 collects several data of technical features data, operating condition data, general data (study timeframe, discount rate), energy cost data, environmental characteristics (emission, waste, land use), and seasonal variation data (load region, load curve). In the same way, the data collection process in step 4 and 5 collect these data obtained in step 2.

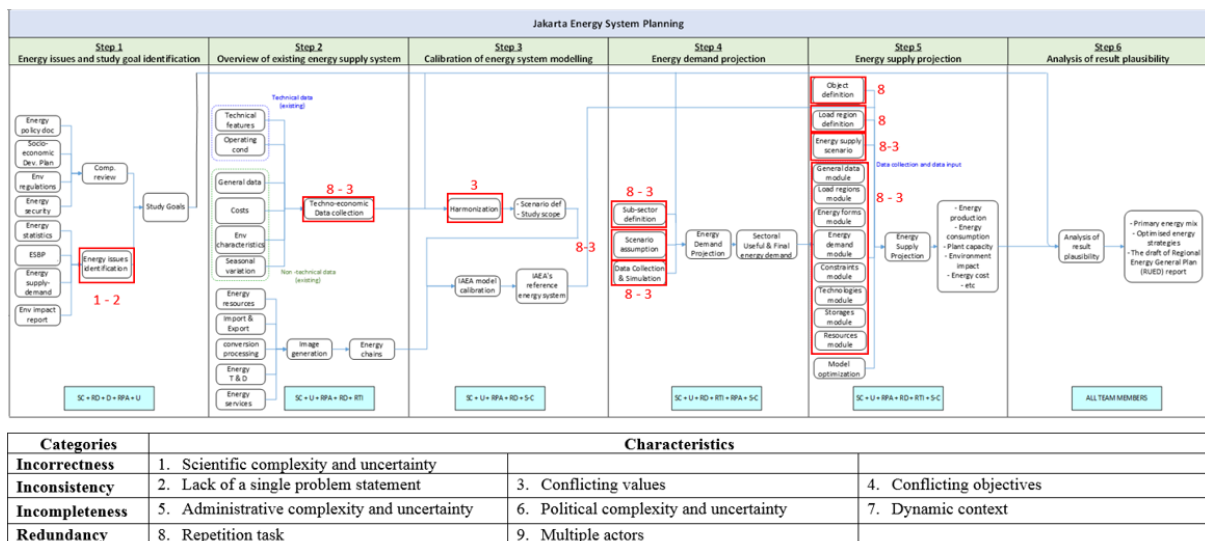

Figure 3. Several complex problem of the Jakarta energy planning process.

## 5.4 Developed Knowledge Analysis Framework

We provide a number of recommendations to minimize the complexity and to obtain a more efficient process by providing the developed knowledge analysis framework of JEPP as shown in Figure 4. This provides a significant improvement in the energy planning process. The most significant improvement is in the data collection process, conducted iteratively in steps 2, 4, and 5. This research simplifies the data collection process by consolidating this process in step 2 (techno-economic data collection activity) and removing the process in steps 4 and 5. Secondly, the process of sub-sector definition and scenario assumption for energy demand and energy supply system in steps 4 and 5 are simplified by merging it with the process of data harmonisation in step 3. Thirdly, this research simplifies the process of energy chain generation in step 2 by redefining the required aspects in the energy chain system to become more efficient. By reducing some complexities and providing significance improvements in the energy planning process, it is expected that the developed knowledge analysis framework in this research can be used and adopted as a guidance for energy practitioner, energy researcher, academics and energy stakeholders to perform energy planning process in a more efficient way.

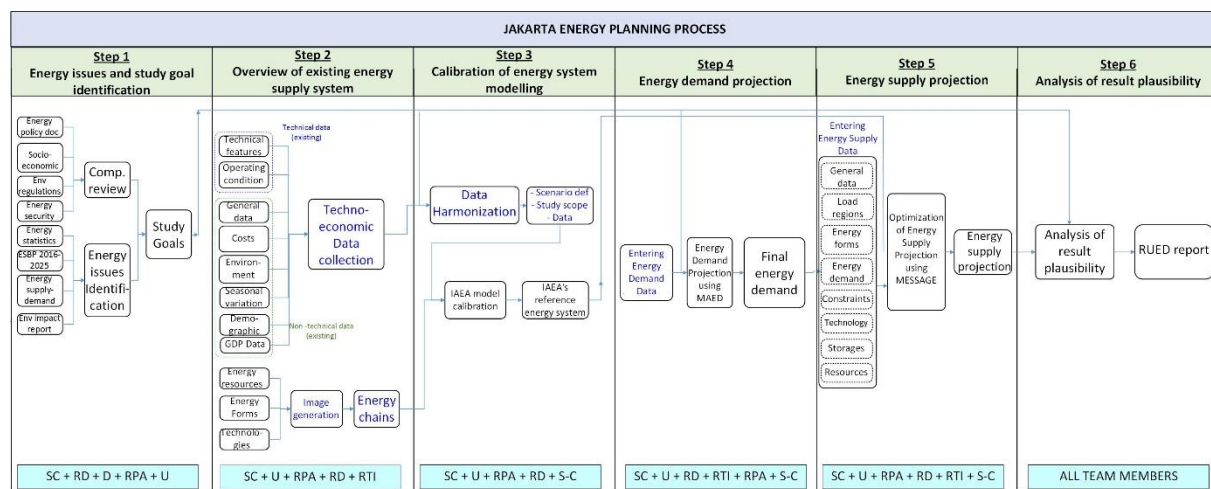

Figure 4. The developed knowledge analysis framework.

## 6 Summary and Future Research

The key results of this research are as follows: Firstly, this research has identified the preliminary knowledge analysis framework based on several information obtained from JEPP. Secondly, this research has captured, and analysed all knowledge artefact of the JEPP by using seven ABMs including goal model, role model, organisation model, interaction model, environment model, agent model, and scenario model. The use of ABMs has helped in understanding the complexity of JEPP in a comprehensive and systematic manner. Thirdly, this research has identified some complex problems in the JEPP. Fourthly, this research has provided several recommendations to reduce complex problems in the Jakarta energy planning process. Finally, this research has developed the knowledge analysis framework based on the result of AOA. For further development, following the DSR method, the next stage of this research will develop more in-depth understanding into the developed knowledge analysis framework obtained in this research. This will enhance the generalisability of the proposed framework to apply it in other countries or regions that similarly have complex planning processes.

## 7 References

- Akbari, Z. 2010. "A Survey of Agent-oriented Software Engineering Paradigm: Towards Its Industrial Acceptance," *Journal of Computer Engineering Research* (1), pp 14-28.
- Ashamalla, A., Beydoun, G., and Low, G. 2017. "Model driven approach for realtime requirement analysis of multi-agent systems," *Computer Languages, Systems & Structures* (50), pp 127-139.
- Al-Azawi, R., and Ayes, A. 2013. "Comparing Agent -Oriented Programming Versus Object-Oriented Programming," *ICIT 2013 The 6th International Conference on Information Technology*, pp 24-29, Jordan, 8-10 May 2013, IEEE Jordan Chapter.
- Balint, P.J., Stewart, R.E., Desai, A. and Walters, L.C. 2011. *Wicked Environmental Problems: Managing uncertainty and conflict*. Island Press.

- Beydoun, G., Low, G., Henderson-Sellers, B., Mouratidis, H., Gomez-Sanz, J.J., Pavón, J., and Gonzalez-Perez, C. 2009. "FAML: a generic metamodel for MAS development", *IEEE Trans.Softw.En* (99:1), pp 841–863.
- Beydoun, G., Low, G., Tran, N., and Bogg, P. 2011. "Development of a peer-to-peer information sharing system using ontologies," *Expert Systems with Applications* (38:8), pp 9352-9364.
- Beydoun, G., Hoffmann, A. 1998. "Simultaneous modelling and knowledge acquisition using NRDR", 5th Pacific rim conference on artificial intelligence (PRICAI98), Singapore, Springer-Verlag.
- Cajot, S., Peter, M., Bahu, J.M., Guignet, F., Koch, A., and Maréchal, F. 2017. "Obstacles in Energy Planning at the Urban Scale," *Sustainable Cities and Society* (30), pp 223-236.
- Hevner, A.R., March, S.T., Park, J., and Ram, S. 2004. "Design science in information system research," *MIS Quarterly* (28:1), pp 75-105.
- Inan, D. I., Beydoun, G., and Opper, S. 2015. "Towards Knowledge Sharing in Disaster Management: an Agent-Oriented Knowledge Analysis Framework," in *Proceedings of the 26th Australasian Conference on Information Systems (ACIS2015)*, Adelaide, South Australia, pp 1-13.
- Jennings, N.R., and Wooldridge, M.J. 2001. *Agent-Oriented Software Engineering: Handbook of Agent Technology*. AAAI/MIT Press.
- Lopez-Lorca, A. A., Beydoun, G., Valencia-Garcia, R., and Martinez-Bejar, R. 2016. "Supporting Agent-Oriented Requirement Analysis with Ontologies," *International Journal of Human-Computer Studies* (87), pp 20-37.
- Liang, Xiao, Fox, J., and Hong, Zhu. 2013. "An Agent-Oriented Approach to Support Multidisciplinary Care Decisions," *Paper presented at the 3rd Eastern European Regional Conference on the Engineering of Computer Based Systems (ECBS-EERC)*.
- Miller, T., Lu, B., Sterling, L., Beydoun, G., and Taveter, K. 2014. "Requirements Elicitation and Specification Using the Agent Paradigm: The Case Study of an Aircraft Turnaround Simulator," *IEEE Transactions on Software Engineering* 40(10), pp 1007-1014.
- Sarmiento, E., Leite, J.C.S.d.P., and Almentero, E. 2015. "Using correctness, consistency, and completeness patterns for automated scenarios verification," *2015 IEEE Fifth International Workshop on Requirements Patterns (RePa)*.
- Shvartsman, I., and Taveter, K. 2014. "From Agent-Oriented Models to Profile Driven Military Training Scenarios" in Zavoral, Filip, Jung, Jason, J., and Badica, Costin (Eds.), *Intelligent Distributed Computing VII* (511), pp 317-322, Springer International Publishing.
- Silver, M.S., Markus, M.L., and Beath, C.M. 1995. "The Information Technology Interaction Model: A Foundation for the MBA Core Course," *MIS Quarterly* (19:3), pp 361-390.
- Wooldridge, M., and Jennings, N.R. 1995. "Intelligent agents: Theory and Practice," *Knowledge Engineering Review* (10:2).
- Wooldridge, M., Jennings, N.R., and Kinny, D. 1999. "A Methodology For Agent-oriented Analysis & Design," *Proceedings of the 3rd annual conference on Autonomous Agents AGENTS '99*, pp 69-76.
- Wooldridge, M. 2002. *An Introduction to MultiAgent Systems*. John Wiley & Sons, LTD.
- Xu, D., Wijesooriya, C., Wang, Y.-G., and Beydoun, G. 2011. "Outbound logistics exception monitoring: A multi-perspective ontologies' approach with intelligent agents," *Expert Systems with Applications* (38:11), pp 13604-13611.
- Zmud, R. 1997. "Editors Comments," *MIS Quarterly* (21: 2), pp xxi-xxii.

## Copyright

**Copyright:** © 2018 Yohanes Dwi Anggoro, Suwin Sandu, and Ghassan Beydoun. This is an open-access article distributed under the terms of the [Creative Commons Attribution-NonCommercial 3.0 Australia License](https://creativecommons.org/licenses/by-nc/3.0/au/), which permits non-commercial use, distribution, and reproduction in any medium, provided the original author and ACIS are credited.

# Facilitating Knowledge Transfer based on a Resource Based View of Tacit Knowledge Stock: A Skills Assessment Perspective

## **Aastha Pant**

School of Management and Enterprise  
University of Southern Queensland  
Toowoomba, Australia  
Email: Aastha.pant@usq.edu.au

## **Anup Shrestha**

School of Management and Enterprise  
University of Southern Queensland  
Toowoomba, Australia  
Email: Anup.shrestha@usq.edu.au

## **Eric Kong**

School of Management and Enterprise  
University of Southern Queensland  
Toowoomba, Australia  
Email: Eric.Kong@usq.edu.au

## **Mustafa Ally**

School of Management and Enterprise  
University of Southern Queensland  
Toowoomba, Australia  
Email: Mustafa.ally@usq.edu.au

## **Abstract**

Resource Based View posits the use of internal resources for competitive advantage which is often evaluated using four questions on value, rarity, imitability and organisation, also known as the VRIO framework. We focus on the organisational resource of tacit knowledge – characterized by knowledge that is difficult to transfer. Knowledge transfer begins with the identification of knowledge stock. Using the Design Science Research Methodology, we develop and evaluate a skills assessment method to measure tacit knowledge stock of an organisation based on the Skills Framework of the Information Age (SFIA). The method is evaluated in an Australian bank during its digital innovation initiative. We found that knowledge transfer is most effective when the person or party that is transferring knowledge has prior understanding of the receivers' knowledge stock. This finding has significant implications to practice in the area of knowledge management.

**Keywords** resource-based view, VRIO framework, knowledge management, Skills Framework for the Information Age, design science research

## 1 Introduction

The Resource Based View (RBV) theory by Barney (1991) states that organisations must use their internal resources for their sustainable growth. Among several tangible and intangible resources used by an organisation, knowledge is a critical resource that promotes sustainable competitive advantage (Harrison et al. 2001). Knowledge management is gaining prominence within the areas of strategic management and innovation (Rupietta and Backes-Gellner 2017). During knowledge management, the concept of knowledge stock and knowledge transfer are often used to measure effective dissemination of knowledge in an organisation (Kyriakopoulos and De Ruyter 2004). Generally, at an individual level, knowledge stock may refer to (a) information contained in the mind of a person i.e. tacit knowledge or (b) information which can be clearly documented i.e. explicit knowledge (Machlup 1979).

Knowledge stock of a person is static in nature and remains under-utilised unless transferred to others effectively (Lai et al. 2016). Knowledge transfer is typically a spiral flow of knowledge through people, groups or firms (Nonaka 1994). Knowledge transfer among employees within an organisation enhances a healthy knowledge management culture (Lam 2005). Employees that continuously acquire new knowledge enable external knowledge acquisition that helps to effectively transfer knowledge within an organisation (Lopez-Saez et al. 2010). Although knowledge transfer is a heavily researched topic, it is a challenge for many organisations to execute it in practice (Frank et al. 2015; Minbaeva et al. 2014). Moreover, there is a general consensus that tacit knowledge is more difficult to transfer as compared to explicit knowledge because of the challenge in codifying tacit knowledge (Inkpen and Pien 2006).

Research has suggested various factors that are responsible for the success of tacit knowledge transfer, viz. peoples' knowledge levels, interactions, and motivation for knowledge transfer, absorptive capacity and the existing knowledge stock (Gupta and Govindarajan 2000). Knowledge stock can be represented by skills ingrained within an organisation's human resources. In our research, we refer to 'knowledge stock' of people in terms of their current digital skills. Digital skills are critical for all careers in today's ICT-empowered business ecosystem (Shrestha et al. 2017). Likewise, the importance of correctly identifying peoples' current skills to enable knowledge transfer has been highlighted by various studies (Leonard-Barton 1995; Prince et al. 2015). However, there are scant studies that investigate the measurement of peoples' skills as knowledge stock and its link to knowledge transfer. Consequently, this research attempts to answer the research question: *How can peoples' skills be measured as tacit knowledge stock, and then subsequently enable knowledge transfer?* This research question is divided into two sub questions for granularity, which are:

*RQ1: Can tacit knowledge stock be measured by skills of employees in an organisation?*

*RQ2: How does tacit knowledge stock enable knowledge transfer?*

To answer the research question, we developed a skills assessment method that uses the Skills Framework for the Information Age (SFIA) to measure tacit knowledge stock of organisational staff. The VRIO framework by Barney (1991) is widely used to evaluate an organisation's resources in terms of its value, rarity, imitability and organisation. We evaluated the method by reviewing its reported tacit knowledge stock based on the VRIO framework. The organisational setting for the evaluation is a real-world digital innovation project in an Australian bank in 2018. Key stakeholders of the project were interviewed to investigate how the reported knowledge stock may enable knowledge transfer within the organisation.

The paper is organised as follows. First, a brief description of the relevant knowledge management and skills assessment principles is presented followed by an overview of the RBV theory and the VRIO Framework. The design principles for the development of the skills assessment method is presented using a conceptual model for this study. Based on the design principles, we explain our Design Science Research (DSR) project in terms of development and evaluation of the method to identify knowledge stock based on the digital skills of ICT professionals and to understand its impact on knowledge transfer. Finally, research findings are discussed and implications to research and practice are offered.

## 2 Literature Review

### 2.1 Knowledge as a Resource

The term 'knowledge' refers to a justified belief that expands the abilities of a person to perform their activities effectively (Huber 1991; Nonaka 1994). According to Leonard and Sensiper (1998), knowledge is relevant and actionable information which is partly based on the experience of a person. There are two types of knowledge in an organisation: tacit and explicit (Nonaka 1994; Polanyi 2009). Tacit

knowledge refers to a composition of cognitive and technical elements where cognitive elements include views and thoughts of a person (Spender 1996). On the other hand, the technical elements comprise skills and ideas about a specific area (Nonaka 1994). According to Spender (1996), tacit knowledge is the knowledge which is not explicated yet. For example, the skills and abilities needed to master a musical instrument cannot be fully expressed in words, hence it is a tacit knowledge. Likewise, explicit knowledge refers to the knowledge which can be expressed and transferred in symbolic forms or using simple language (Alavi and Leidner 2001). An example of explicit knowledge is an owner's manual of a product that explains how to operate it, where the knowledge is presented in a codified form. Transferring tacit knowledge is more complicated as compared to explicit knowledge transfer (Dhanaraj et al. 2004). It is because tacit knowledge is progressively increased via interactions and observations whereas explicit knowledge is relatively easy to learn and code (Doz et al. 2001).

Among various factors influencing knowledge transfer, a persons' tacit knowledge stock is an important one (García-Morales et al. 2008; Gupta and Govindarajan 2000). The research conducted by Empson (2001) reported that people inhibit knowledge transfer when their level of knowledge do not match with others knowledge level with whom they are sharing. Huckaby and Christensen (2012) pointed out that there is a strong relationship between attitude and the intention of people to transfer their knowledge. Negative attitude towards transferring knowledge is caused by differences in the knowledge stock (Cohen and Levinthal 2000). The research conducted by Fullwood et al. (2013) found that academic leadership, represented as superior knowledge stock, plays a vital role in transferring knowledge. A taxonomic analysis by Frank and Ribeiro (2014) identified four major factors influencing knowledge transfer including personnel, technology, work design and external environment sub-systems. According to this research, identifying technical and systematic knowledge stock of the team members was the most important factor that could influence knowledge transfer between the teams. Power and Cormican (2015) also mentioned that knowledge transfer is simpler when organisations are aware of the knowledge stock of their staff. Moreover, identification of knowledge stock of organisational staff before recruitment helps to select right staff for knowledge transfer within the organisation (Power and Cormican 2015).

Extant literature on knowledge as a resource has confirmed the importance of knowledge stock identification to enable knowledge transfer. Nevertheless, there is a lack of research that investigates the "methods" to measure tacit knowledge within an organisation. A recent research demonstrated the lack of the use of IT in identifying tacit knowledge stock (Pant et al. 2018). Potential methods to identify the knowledge stock of an employee are accessing past projects and profiles, analysis of existing documents produced by the employee and staff relationship analysis (Newk-Fon Hey Tow et al. 2012). Assessing current staff skills is one of the most efficient and accurate methods to identify organisational knowledge stock (Bartram 2004; Shrestha et al. 2017). We discuss skills assessment in more detail next.

## 2.2 Skills Assessment

Skills assessment is the process of determining the competency level of a person in terms of ability to perform relevant activities. Such assessment may use ICT tools and methods to obtain the overall profile of a person and their relevant capabilities (Patterson et al. 2001). A competency based management (CBM) method allows organisations to assess the human capacities based on their current skills that are required to achieve organisational goals (Tripathi and Agrawal 2014). Many attempts have been made to explain the skills assessment process to identify knowledge stock (Lawler III 1994; Tripathi and Agrawal 2014). However, there appears to be limited attempt to propose ways of doing this, consequently there is a lack of empirical evidence to demonstrate skills assessment as an effective method of knowledge stock identification (Shrestha et al. 2017).

Skills assessments have several benefits both at the individual and organisational level because measurement of skills help individuals plan their careers and organisations can manage their collective knowledge stock for long term organisational benefits (Bartram 2004). However, the process of adopting skills assessments to measure knowledge stock at organisational level is largely untested in a research setting (Shrestha et al. 2017). This research measures the skills possessed by staff of an organisation to identify their knowledge stock and then explore the extent to which it facilitates knowledge transfer. To address this requirement, the skills assessment method was developed using the Skills Framework for the Information Age (SFIA) to review digital skills within the ICT setting.

The SFIA, originally proposed in 2000, is a popular and well-established framework to identify digital skills and competencies for ICT professionals. Organisations and individuals from over 150 countries use this framework to map their skills set. A major activity in this framework involves open consultation and obtaining input from those who possess practical experiences in the management of skills in industries and educational institution. A standard report can be produced for the skills possessed by an

individual in order to help them in their career aims (SFIA 2018; von Kinsky et al. 2016). A total of 97 skills are defined in SFIA in six categories, namely, Strategy and Architecture, Business Change, Solution Development and Implementation, Service Management, Procurement and Management Support and Client Interface (SFIA 2018). There are seven levels of increasing responsibilities for all the skills: follow, assist, apply, enable, ensue/advise, initiate/influence and set strategy. Each skill is described based on the responsibility level of autonomy, influence, complexity and business skills needed by the employees. This research proposes skills assessment as a critical method to measure tacit knowledge stock. Assessment as a method has been previously researched in the area of knowledge management to enable process improvements in IT Service Management (Shrestha et al. 2018). Knowledge is considered a significant resource for organisations and it is often studied from a resource-based view using the VRIO framework. A brief overview of these terms follows next.

### **2.3 Resource Based View of the Firm (RBV) and VRIO Framework**

RBV states that it is very important for an organisation to utilise its core competencies as it increases organisational productivity (Barney 1991). Internal resources of an organisation are given the highest priority by RBV that promotes a resource-based model. According to the model, there are two types of resources: (1) tangible resources such as physical assets of an organisations, and (2) intangible resources, such as brand reputation, trademarks and intellectual properties (Wernerfelt 1984). It also assumes that organisational resources are heterogeneous and immobile in nature. The term 'heterogeneous' means that an organisation's intellectual property varies from one organisation to another. The term 'immobile' means that those properties cannot move from one organisation to another without one's efforts in transferring them (Barney 1991). Based on the 'knowledge as a resource' view, it is clear that the skills and knowledge of the organisational staff are critical factors for organisational growth (Tzabbar et al. 2008).

VRIO is an abbreviation for a four-question framework about a resource to determine its worth in terms of Value, Rarity, Imitability, and Organisation. The VRIO Framework was developed by Barney (1991) which states that the resources must not only be valuable, rare, and costly to imitate to enhance organisational growth, but the organisation should also utilize the resources properly to take advantage of it. Based on the concept of dynamic capabilities, Eisenhardt and Martin (2000) argue that organisational strategy and processes are as important as the organisational resources, because they enable resources manipulation to enhance organisation's performance. The main focus of the empirical studies were on the direct connection between resources configurations and organisational performances, whereas there is limited attention towards effective utilization of resources (Armstrong and Shimizu 2007).

Using the language from the VRIO framework, it can be concluded that research studies have limited focus on the interrelationship between a firm's organisation ('O') and its resources ('VRI') to explain its performance even though positive impact of effective utilization of firm's resources has been established (Cockburn et al. 2000). Consequently, having knowledge resources that are valuable, rare and difficult to imitate are not enough for superior performance of the organisation. Methods to utilize knowledge resources that can be codified easily (i.e. explicit knowledge) are abundant in the information systems and knowledge management literature (Dayasindhu 2002). However, knowledge resources that are hard to codify, such as tacit knowledge stock must also be utilized for knowledge transfer within an organisation. An organisation's knowledge stock can only be utilized optimally when it can be transferred because knowledge stock is static in nature and has limited value unless transferred (Lai et al. 2016). RBV and VRIO framework offer design principles with a theoretical input to justify and explain this design science research project. Methodology is discussed in some detail next.

## **3 Design Science Research Methodology**

A key objective of a Design science research (DSR) project is to generate and evaluate artefacts that focus on solving organisational issues (Hevner 2007). This research developed and evaluated a skills assessment method to identify the knowledge stock of ICT professionals of an organisation. Consequently, this research is best suited as a DSR, with the method as the artefact proposed to resolve issues surrounding knowledge stock identification and its implications to knowledge transfer. The design principles, development, demonstration and evaluation of the artefact are presented next.

### **3.1 Design Principles for the Artefact**

RBV (Barney et al. (2001) suggests organisations must focus on managing their resources to enhance their growth. People are considered the most important resource because they possess intellectual



capital (Edvinsson and Malone 1997) and knowledge (Grant 1996) to offer competitive advantages. The knowledge based theory by Grant (1996) states that organisations exist and grow only when there is better integration and application of the knowledge present within them. Using RBV as the kernel theory, we recognize skills as a key organisational resource to represent knowledge stock and propose our first design principle: *tacit knowledge stock is an organisation resource measured by skills assessment*.

Likewise, the VRIO framework (Barney 1991) demands that a firm’s resource must be valuable, rare, difficult to imitate and well-organised by the firm to obtain maximum benefits. Considering that tacit knowledge is more difficult to transfer than explicit knowledge (Inkpen and Pien 2006), we present our second and final design principle: *knowledge transfer is enabled by tacit knowledge stock*.

Based on the two design principles, a conceptual research model has been developed (Figure 1) to explain the rationale and process of artefact development and evaluation.

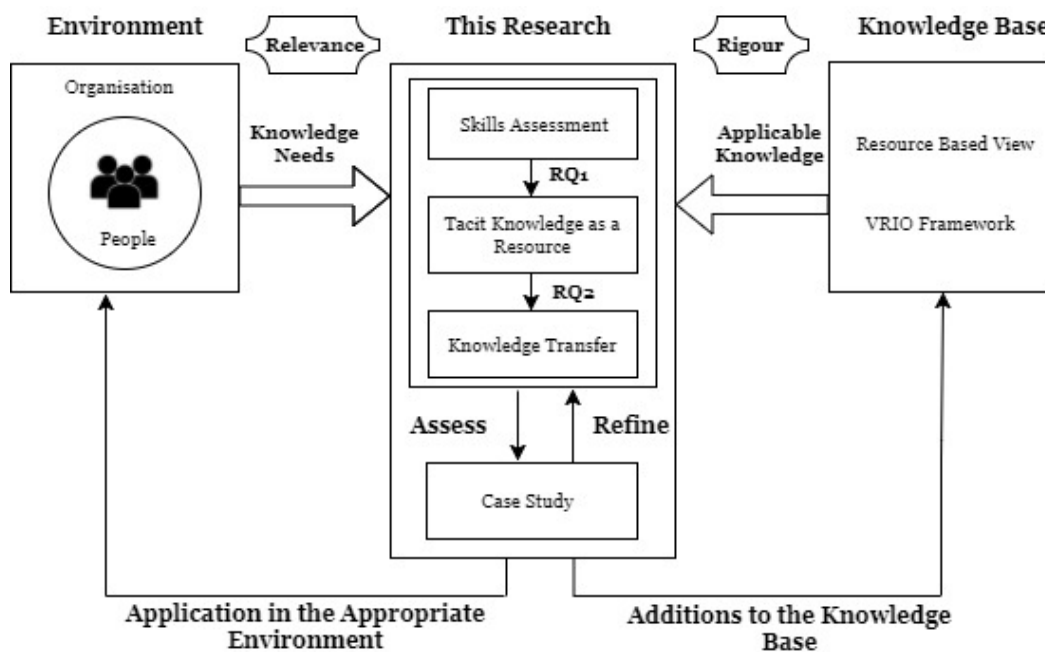

Figure 1: Conceptual Research Model adapted from Hevner (2007)

Figure 1 is based on the three-phase DSR cycles by Hevner (2007). The three phases in the cycle include: (i) Relevance Cycle, (ii) Design Cycle and (iii) Rigour Cycle. The three cycle DSR study has been applied previously in a research area of automating assessments in order to demonstrate relevance and rigour of research activities (Barafort et al. 2018). Similarly, we apply Hevner (2007) methodology in this research. The ‘Relevance cycle’ for this research deals with the alignment of the organisation with its knowledge needs whereas the Design cycle deals with the development and evaluation of the artefact to provide a solution to the existing research problem in the area of knowledge management. The artefact is a skills assessment method to measure the knowledge stock of people in a case study organisation to explore its importance in knowledge transfer. In doing so, this research is fulfilling one of the knowledge needs of the case study organisation. Moreover, the ‘Rigour cycle’ in the model refers to the theory and framework used to support the research which includes the RBV and the VRIO Framework. The application of the theory and framework adds knowledge and provides rigour to the knowledge base of this research.

### 3.2 Artefact Development and Demonstration

ICT skills are one of the most powerful skills required by organisations both currently as well as in future (Colbert et al. 2016). For our study, we developed a skills assessment method that measures the digital skills possessed by individuals and, in so doing, can help decision makers identify their collective knowledge stock to enable knowledge transfer. The method uses the SFIA framework because of its popularity and reliability (SFIA 2018). The method was developed with our Australian technology partner that provides world-leading cloud-based assessment services (Shrestha et al. 2017).

### 3.3 Artefact Evaluation

#### 3.3.1 Case Selection and Participants

Our case study organisation is an Australian bank that was rolling out a digital innovation project as a strategic initiative championed by its CIO. Given the choice of SFIA, we selected this case study where research participants must possess superior levels of digital and IT skills. Staff experiences in using skills assessment method can provide insight into the role of the method to measure their individual knowledge stock. Similarly, we sought input through interviews of the senior managers of the digital innovation project to gain their perspectives on how the identified knowledge stock might enable knowledge transfer, as required for digital innovation activities during the project.

#### 3.3.2 Data Collection

All the ICT staff at the case study were invited to participate in the study. There are seven ICT teams in the project: Strategy and Architecture, IT Administration, IT Service Delivery, IT Infrastructure & Security Services, Banking Payments & Ancillary Systems, IT Projects and Digital Banking Systems. There were 9 to 21 employees in each team. A total of 14 employees across all teams were intensively involved with the skills assessment exercise. We organized a one-hour workshop at the case study site to help the participants understand the SFIA framework and train them to use the method that was executed in April 2018.

We presented individual skills profile to the ICT staff and a collective snapshot of skills summary, as identified tacit knowledge stock, to the senior managers of the project. We obtained the perceived views of the participants on the effectiveness of skills assessment exercise to measure their knowledge stock. Further in-depth semi-structured interviews with senior managers provided an insight on how the identified knowledge stock could help in knowledge transfer within the context of digital innovation at the case study.

## 4 Result and Findings

Skills assessment is helpful assessing one's skills at both individual level and organisational level (Bartram 2004). Firstly, research participants were interviewed about the effectiveness of skills assessment to identify their knowledge stock at an individual level. Majority of the employees (10 out of 14) found the method was very effective in identifying their knowledge stock at the individual level. Four employees thought that the method was useful for the managerial staff at the organisational level only. Table 1 provides the summary of the evaluation results of the effectiveness of the skills assessment method.

Level of skills assessment	Selected key comments
<b>Individual level</b>	
<ul style="list-style-type: none"> <li>planning career</li> <li>identifying skills gaps</li> <li>Getting an overall picture of the individual knowledge stock</li> </ul>	<p><i>“... I can identify the skills and knowledge stock which I lack or which I can pursue in future to progress my career.”</i></p> <p><i>“If you have a career goal and trying to plan a career, I think it will be very useful because it will help you identify the areas where you need to work on.”</i></p> <p><i>“...provides me some directions to obtain a certain training or knowledge in my areas.”</i></p>
<b>Organisational level</b>	
<ul style="list-style-type: none"> <li>useful to the managerial staff only</li> <li>getting an overall picture of the collective knowledge stock</li> <li>recruiting new employees based on the identified knowledge gaps</li> </ul>	<p><i>“... an overall picture of what the employees are skilled with. It is a great tool for the management.”</i></p> <p><i>“... useful for the management staff. I think it helps managerial staff to know where they are and what they want to do in future, based on the knowledge stock of their staff.”</i></p> <p><i>“...assess the potential employees to determine what skills they have and what skills they can bring to the organisation.”</i></p>

Table 1. Evaluation Results of Skills Assessment Method

Secondly, the research participants were asked a series of questions to determine in what ways the representation of their knowledge stock can help in knowledge transfer. Three key themes emerged from our data analysis: person-organisation fit; sender's willingness; and prior understanding of receiver's knowledge stock. These themes are briefly discussed next.

#### 4.1 Person-Organisation Fit

Person-organization fit was originally studied by Kristof (1996). According to this theory, there must be compatibility between a person and an organisation to enhance the growth of both entities. It means that it is not enough to have an employee with excellent knowledge stock but they must have abilities to fit organisational demands. We found that effectiveness of knowledge transfer depends on the fit of the person in his or her job and roles within the organisation.

*-"[knowledge transfer] can depend on what your role is in an organisation. For example, if you have a particular set of skills that require you to do your job that might not be the same skills set for another person.... knowledge stock identification alone cannot facilitate knowledge transfer."*

#### 4.2 Senders' Willingness

Past research have investigated sender's willingness in knowledge transfer (Héliot and Riley 2010; Wiewiora et al. 2013). This research supports previous studies and suggests that if the sender is not willing or interested to transfer knowledge, understanding knowledge stock in itself is not sufficient.

*-"[knowledge transfer] depends on whether a person wants to share knowledge to expand into different roles in the organisation after identifying his/her knowledge stock."*

#### 4.3 Prior Understanding of Receiver's Knowledge Stock

Majority of research participants suggested if they want to transfer knowledge, they would like to know the knowledge stock of the person beforehand to whom they are sharing their knowledge. It appears to be a very practical suggestion but surprisingly we did not find much research in this area.

Cummings and Teng (2003) states that the knowledge stock of the sender must be made accessible to the receiver to enable knowledge transfer between them whereas Gupta and Govindarajan (2000) mentioned that knowledge transfer is dependent on the knowing the value of sender's knowledge stock by the receiver which is similar. However, limited studies associate knowledge transfer effectiveness with receiver's knowledge stock.

*-"... if I know what other people's knowledge areas are, then it certainly would help to go to the right person to obtain or give knowledge."*

*-"If the profiles of other team mates are shared with us, then certainly yes [enabling knowledge transfer]. That will help us to gain the knowledge from that person if we are going to some other specialized projects."*

The results are further discussed in the next section.

## 5 Discussion

Our results complement research conducted by Bartram (2004) and suggest that skills assessment is a useful method to identify knowledge stock at individual as well as organisational level. However, our findings confirm that people typically find skills assessment is only useful for individual knowledge stock. For example, the skills assessment enabled case study participants to plan their career. Benefits to the case study organisation itself due to the recognition of collective knowledge stock were not appreciated.

Wiklund and Shepherd (2003) argue that if the collective knowledge resource of a firm is utilized properly, it enhances firm's orientation and performance. Likewise, the research conducted by Nickerson and Zenger (2004) stated that managers must identify and utilize the overall knowledge stock of the firm because it helps in solving critical problems of the firm using limited time and resources. Although organisations benefit greatly by their collective knowledge stock, organisations are missing out on effectively disseminating them.

Barney (1991) VRIO framework states that organisations can gain maximum benefits if its resources are valuable (V), rare (R), difficult to imitate (I) and properly utilized by the organisation (O). The fourth property of an organisational resource, i.e. ability to utilize the resources (O) is found to be most challenging (Chatzoglou et al. 2018). Our results complement Power and Cormican (2015)'s argument

that understanding knowledge stock of all employees in an organisation enables knowledge transfer. The empirical data from our research demonstrate the importance of knowledge stock to facilitate knowledge transfer. Following the VRIO framework, our research confirm when collective knowledge stock of an organisation is identified, this will facilitate knowledge transfer leading to superior performance, akin to research conducted by (Argote and Ingram 2000).

We introduced three new themes that emerged while exploring the relationship between knowledge stock and knowledge transfer. Based on the theme of 'person-organisation fit', it is critical that knowledge stock is relevant to the person's job and current role in the organisation. Judge (1994)'s theory of work adjustment confirms that person-organisation fit positively impacts an employee's career success and supports organisation growth. Associating this theory with the VRIO framework, tacit knowledge stock can be considered valuable, rare and difficult to imitate (VRI) on its own, however it can only be organised (O) when we determine best fit for the organisation and its staff. Implications to practice include creating favourable working environment where employees are aware of their roles and responsibilities in the organisation to enable knowledge transfer.

Moreover, our findings support common understanding that during knowledge transfer, willingness of the person or party that transfers their knowledge, i.e. sender's willingness, is a very important factor. Past research confirms that without the motivation of the sender, there cannot be effective knowledge transfer in any organisation (Gupta and Govindarajan 2000; Héliot and Riley 2010; Wiewiora et al. 2013). Our findings also support the fact that the sender must have vested interest in knowledge transfer.

Lin (2007) states that the use of ICT helps knowledge receiver to recognize the sender's knowledge stock. This research does not explore identifying the receiver's knowledge stock. Likewise, it has been proven that collective knowledge stock has a positive impact on knowledge transfer (Wang and Noe 2010). Prior research suggests that based on ones' own knowledge stock, a sender perceives that the receiver will benefit from knowledge transfer without recognizing the receiver's knowledge stock. In these cases, knowledge transfer occurs due to the perceived beliefs of employees that their knowledge stock is useful to other people especially in a professional network. However, the sender is not aware of the receiver's knowledge stock in all these studies (Chiu et al. 2006; Siemsen et al. 2007; Wasko and Faraj 2005). However, we found that prior understanding of receiver's knowledge stock could play a critical role in knowledge transfer.

Consequently, as an important implication to practice, we argue for recognizing the knowledge stock of the receiver before knowledge transfer is considered by the sender. A number of studies have proposed that knowledge transfer is relatively easier when knowledge stock is known (Lin 2007; Wang and Noe 2010). However, this relationship has been explored based on self-awareness of knowledge stock of the sender but not from the perspective of the receiver. This is perhaps due to the assumption that it is not possible to recognise the knowledge stock of others. This assumption, however, does not hold true since our research has enabled identification of knowledge stock using a skills assessment method. At an individual level, such knowledge stock can be shared across key stakeholders for the purpose of effective knowledge transfer. Therefore, combined with the factor of sender's willingness, we believe that our argument: prior understanding of receiver's knowledge stock enables effective knowledge transfer, is justified.

## 6 Conclusion

Based on the RBV theory and VRIO framework, the objective for this paper was to understand how a skills assessment method can identify knowledge stock and how effective is such knowledge stock towards knowledge transfer in an organisation. Using Design Science Research Methodology, we developed the skills assessment method using the SFIA framework, and later evaluated it in an Australian bank. The method measured the knowledge stock of ICT employees of the organisation in terms of their digital skills. Evaluation of the method was based on semi-structured interviews to determine how knowledge stock could enable knowledge transfer.

We found that skills assessment is useful to measure knowledge stock, however such benefits are highly recognized at the individual level rather than for the entire organisation. This is a missed opportunity for effective use of knowledge stock towards knowledge transfer. Our research work also concluded that knowledge transfer is effective when there is some prior understanding of the receivers' knowledge stock. This finding is significant as prior research has not yet studied this factor, probably due to the assumption that others' knowledge stock may not be recognized. The use of the skills assessment

method in this research has created an opportunity to identify knowledge stock, hence recognize receiver's knowledge stock for effective knowledge transfer.

We realise the need of further research to empirically test the relevance and strength of receiver's knowledge stock to enable knowledge transfer. There are other recognized limitations of this study. As the skills assessment method was evaluated in one case study only, issues of validity and reliability can be raised. Furthermore, this study investigates the knowledge stock of ICT staff only. More research should be conducted to assess broader skill set of employees and under different organisational settings. Nevertheless, we argue this research has presented a novel perspective of receiver's knowledge stock for effective knowledge transfer. This perspective can have significant implications to practice in knowledge management.

## 7 References

- Alavi, M., and Leidner, D. E. 2001. "Knowledge Management and Knowledge Management Systems: Conceptual Foundations and Research Issues," *MIS Quarterly* (25:1), pp. 107-136.
- Argote, L., and Ingram, P. 2000. "Knowledge Transfer: A Basis for Competitive Advantage in Firms," *Organizational Behavior and Human Decision Processes* (82:1), pp. 150-169.
- Armstrong, C. E., and Shimizu, K. 2007. "A Review of Approaches to Empirical Research on the Resource-Based View of the Firm," *Journal of Management* (33:6), pp. 959-986.
- Barafort, B., Shrestha, A., Cortina, S., and Renault, A. 2018. "A Software Artefact to Support Standard-Based Process Assessment: Evolution of the Tipa® Framework in a Design Science Research Project," *Computer Standards & Interfaces* (60), pp. 37-47.
- Barney, J. 1991. "Firm Resources and Sustained Competitive Advantage," *Journal of Management* (17:1), pp. 99-120.
- Barney, J., Wright, M., and Ketchen Jr, D. J. 2001. "The Resource-Based View of the Firm: Ten Years after 1991," *Journal of Management* (27:6), pp. 625-641.
- Bartram, D. 2004. "Assessment in Organisations," *Applied Psychology* (53:2), pp. 237-259.
- Chatzoglou, P., Chatzoudes, D., Sarigiannidis, L., and Theriou, G. 2018. "The Role of Firm-Specific Factors in the Strategy-Performance Relationship: Revisiting the Resource-Based View of the Firm and the Vrio Framework," *Management Research Review* (41:1), pp. 46-73.
- Chiu, C.-M., Hsu, M.-H., and Wang, E. T. 2006. "Understanding Knowledge Sharing in Virtual Communities: An Integration of Social Capital and Social Cognitive Theories," *Decision Support Systems* (42:3), pp. 1872-1888.
- Cockburn, I. M., Henderson, R. M., and Stern, S. 2000. "Untangling the Origins of Competitive Advantage," *Strategic Management Journal* (21:10-11), pp. 1123-1145.
- Cohen, W. M., and Levinthal, D. A. 2000. *Absorptive Capacity: A New Perspective on Learning and Innovation*. Cornell University: Elsevier.
- Colbert, A., Yee, N., and George, G. 2016. "The Digital Workforce and the Workplace of the Future." Academy of Management Briarcliff Manor, NY.
- Cummings, J. L., and Teng, B.-S. 2003. "Transferring R&D Knowledge: The Key Factors Affecting Knowledge Transfer Success," *Journal of Engineering and Technology Management* (20:1-2), pp. 39-68.
- Dayasindhu, N. 2002. "Embeddedness, Knowledge Transfer, Industry Clusters and Global Competitiveness: A Case Study of the Indian Software Industry," *Technovation* (22:9), pp. 551-560.
- Dhanaraj, C., Lyles, M. A., Steensma, H. K., and Tihanyi, L. 2004. "Managing Tacit and Explicit Knowledge Transfer in Ijvs: The Role of Relational Embeddedness and the Impact on Performance," *Journal of International Business Studies* (35:5), pp. 428-442.
- Doz, Y. L., Santos, J., and Williamson, P. J. 2001. *From Global to Metanational: How Companies Win in the Knowledge Economy*. Boston, USA: Harvard Business Press.
- Edvinsson, L., and Malone, M. S. 1997. *Intellectual Capital: Realizing Your Company's True Value by Finding Its Hidden Brainpower*. Harper Business: New York.
- Eisenhardt, K. M., and Martin, J. A. 2000. "Dynamic Capabilities: What Are They?," *Strategic Management Journal* (21:10-11), pp. 1105-1121.
- Empson, L. 2001. "Fear of Exploitation and Fear of Contamination: Impediments to Knowledge Transfer in Mergers between Professional Service Firms," (54:7).
- Frank, A. G., and Ribeiro, J. L. D. 2014. "An Integrative Model for Knowledge Transfer between New Product Development Project Teams," *Knowledge Management Research & Practice* (12:2), pp. 215-225.

- Frank, A. G., Ribeiro, J. L. D., and Echeveste, M. E. 2015. "Factors Influencing Knowledge Transfer between Npd Teams: A Taxonomic Analysis Based on a Sociotechnical Approach," *R&D Management* (45:1), pp. 1-22.
- Fullwood, R., Rowley, J., and Delbridge, R. 2013. "Knowledge Sharing Amongst Academics in Uk Universities," *Journal of Knowledge Management* (17:1), pp. 123-136.
- García-Morales, V. J., Lloréns-Montes, F. J., and Verdú-Jover, A. J. 2008. "The Effects of Transformational Leadership on Organizational Performance through Knowledge and Innovation," *British Journal of Management* (19:4), pp. 299-319.
- Grant, R. M. 1996. "Toward a Knowledge-Based Theory of the Firm," *Strategic Management Journal* (17:S2), pp. 109-122.
- Gupta, A. K., and Govindarajan, V. 2000. "Knowledge Flows within Multinational Corporations," *Strategic Management Journal*, pp. 473-496.
- Harrison, J. S., Hitt, M. A., Hoskisson, R. E., and Ireland, R. D. 2001. "Resource Complementarity in Business Combinations: Extending the Logic to Organizational Alliances," *Journal of Management* (27:6), pp. 679-690.
- Héliot, Y., and Riley, M. 2010. "A Study of Indicators of Willingness in the Knowledge Transfer Process," *Journal of Management & Organization* (16:3), pp. 399-410.
- Hevner, A. R. 2007. "A Three Cycle View of Design Science Research," *Scandinavian journal of information systems* (19:2), p. 4.
- Huber, G. P. 1991. "Organizational Learning: The Contributing Processes and the Literatures," *Organization Science* (2:1), pp. 88-115.
- Huckaby, J., and Christensen, H. I. 2012. "A Taxonomic Framework for Task Modeling and Knowledge Transfer in Manufacturing Robotics," *26th AAAI Conference on Artificial Intelligence*, Georgia Institute of Technology: USA, pp. 759-770.
- Inkpen, A. C., and Pien, W. 2006. "An Examination of Collaboration and Knowledge Transfer: China–Singapore Suzhou Industrial Park," *Journal of Management Studies* (43:4), pp. 779-811.
- Judge, T. A. 1994. "Person–Organization Fit and the Theory of Work Adjustment: Implications for Satisfaction, Tenure, and Career Success," *Journal of Vocational Behavior* (44:1), pp. 32-54.
- Kristof, A. L. 1996. "Person-Organization Fit: An Integrative Review of Its Conceptualizations, Measurement, and Implications," *Personnel psychology* (49:1), pp. 1-49.
- Kyriakopoulos, K., and De Ruyter, K. 2004. "Knowledge Stocks and Information Flows in New Product Development," *Journal of Management Studies* (41:8), pp. 1469-1498.
- Lai, J., Lui, S. S., and Tsang, E. W. 2016. "Intrafirm Knowledge Transfer and Employee Innovative Behavior: The Role of Total and Balanced Knowledge Flows," *Journal of Product Innovation Management* (33:1), pp. 90-103.
- Lam, W. 2005. "Successful Knowledge Management Requires a Knowledge Culture: A Case Study," *Knowledge Management Research & Practice* (3:4), pp. 206-217.
- Lawler III, E. E. 1994. "From Job-Based to Competency-Based Organizations," *Journal of Organizational Behavior* (15:1), pp. 3-15.
- Leonard-Barton, D. 1995. *Wellsprings of Knowledge: Building and Sustaining the Sources of Innovation*. Boston, MA: Harvard Business School Press.
- Leonard, D., and Sensiper, S. 1998. "The Role of Tacit Knowledge in Group Innovation," *California Management Review* (40:3), pp. 112-132.
- Lin, H.-F. 2007. "Knowledge Sharing and Firm Innovation Capability: An Empirical Study," *International Journal of Manpower* (28:3/4), pp. 315-332.
- Lopez-Saez, P., Emilio Navas-Lopez, J., Martín-de-Castro, G., and Cruz-Gonzalez, J. 2010. "External Knowledge Acquisition Processes in Knowledge-Intensive Clusters," *Journal of Knowledge Management* (14:5), pp. 690-707.
- Machlup, F. 1979. "Stocks and Flows of Knowledge," *Kyklos* (32:1-2), pp. 400-411.
- Minbaeva, D. B., Pedersen, T., Björkman, I., and Fey, C. F. 2014. "A Retrospective On: Mnc Knowledge Transfer, Subsidiary Absorptive Capacity, and Hrm," *Journal of International Business Studies* (45:1), pp. 52-62.
- Newk-Fon Hey Tow, W., Venable, J., and Dell, P. 2012. "How Organisations Know What They Know: A Survey of Knowledge Identification Methods among Australian Organisations," *Australasian Conference on Information Systems (23rd : 2012)*, Geelong, Victoria: ACIS, pp. 1-10.
- Nickerson, J. A., and Zenger, T. R. 2004. "A Knowledge-Based Theory of the Firm—the Problem-Solving Perspective," *Organization Science* (15:6), pp. 617-632.
- Nonaka, I. 1994. "A Dynamic Theory of Organizational Knowledge Creation," *Organization Science* (5:1), pp. 14-37.

- Pant, A., Shrestha, A., Kong, E., and Ally, M. 2018. "A Systematic Literature Mapping to Investigate the Role of It in Knowledge Stock and Transfer," *Pacific Asia Conference on Information Systems (PACIS)*, Japan.
- Patterson, T. L., Goldman, S., McKibbin, C. L., Hughs, T., and Jeste, D. V. 2001. "Uscd Performance-Based Skills Assessment: Development of a New Measure of Everyday Functioning for Severely Mentally Ill Adults," *Schizophrenia Bulletin* (27:2), pp. 235-245.
- Polanyi, M. 2009. *The Tacit Dimension*. Chicago: University of Chicago press.
- Power, R., and Cormican, K. 2015. "Towards Effective Knowledge Transfer in High-Tech Project Environments: Preliminary Development of Key Determinants," *Procedia Computer Science* (64), pp. 17-23.
- Prince, M., Burns, D., Lu, X., and Winsor, R. 2015. "Knowledge and Skills Transfer between Mba and Workplace," *Journal of Workplace Learning* (27:3), pp. 207-225.
- Rupietta, C., and Backes-Gellner, U. 2017. "Combining Knowledge Stock and Knowledge Flow to Generate Superior Incremental Innovation Performance—Evidence from Swiss Manufacturing," *Journal of Business Research* (in press).
- SFIA. 2018. "The Skills Framework for the Information Age - Sfia." Retrieved 1 February, 2018, from <https://www.sfia-online.org/en/reference-guide>
- Shrestha, A., Kong, E., and Cater-Steel, A. 2018. "Managing Knowledge and Learning for Process Improvement: A Software-Mediated Process Assessment Approach for It Service Management," in *The Palgrave Handbook of Knowledge Management*. Cham: Palgrave Macmillan, pp. 621-641.
- Shrestha, A., Kong, E., and Collins, P. 2017. "Facilitating Knowledge Transfer for Innovation: Towards a Decision Support System to Identify Knowledge Stock in the Ict Profession," *Proceedings of the 28th Australasian Conference on Information Systems (ACIS 2017)*: Australian Association for Information Systems.
- Siemsen, E., Balasubramanian, S., and Roth, A. V. 2007. "Incentives That Induce Task-Related Effort, Helping, and Knowledge Sharing in Workgroups," *Management Science* (53:10), pp. 1533-1550.
- Spender, J. C. 1996. "Making Knowledge the Basis of a Dynamic Theory of the Firm," *Strategic Management Journal* (17:S2), pp. 45-62.
- Tripathi, K., and Agrawal, M. 2014. "Competency Based Management in Organizational," *Global Journal of Finance and Management* (6:4), pp. 349-356.
- Tzabbar, D., Aharonson, B. S., Amburgey, T. L., and Al-Laham, A. 2008. "When Is the Whole Bigger Than the Sum of Its Parts? Bundling Knowledge Stocks for Innovative Success," *Strategic Organization* (6:4), pp. 375-406.
- von Kinsky, B., Miller, C., and Jones, A. 2016. "The Skills Framework for the Information Age: Engaging Stakeholders in Ict Curriculum Design," *Journal of Information Systems Education* (27:1), pp. 37-50.
- Wang, S., and Noe, R. A. 2010. "Knowledge Sharing: A Review and Directions for Future Research," *Human Resource Management Review* (20:2), pp. 115-131.
- Wasko, M. M., and Faraj, S. 2005. "Why Should I Share? Examining Social Capital and Knowledge Contribution in Electronic Networks of Practice," *MIS Quarterly*, pp. 35-57.
- Wernerfelt, B. 1984. "A Resource-Based View of the Firm," *Strategic Management Journal* (5:2), pp. 171-180.
- Wiewiora, A., Trigunarsyah, B., Murphy, G., and Coffey, V. 2013. "Organizational Culture and Willingness to Share Knowledge: A Competing Values Perspective in Australian Context," *International Journal of Project Management* (31:8), pp. 1163-1174.
- Wiklund, J., and Shepherd, D. 2003. "Knowledge-Based Resources, Entrepreneurial Orientation, and the Performance of Small and Medium-Sized Businesses," *Strategic Management Journal* (24:13), pp. 1307-1314.

## Acknowledgements

We thank Mr. Paul Collins, CEO of SkillsTx for his input in providing the digital skills assessment platform for our artefact.

# Information Technology and Organizational Learning Interplay: A Survey

## Saleem Malik

Faculty of Science and Technology  
Federation University Australia  
Mount Helen, Australia  
Email: smalik@federation.edu.au

## Madhu Chetty

Faculty of Science and Technology  
Federation University Australia  
Mount Helen, Australia  
Email: madhu.chetty@federation.edu.au

## Mehmood Chadhar

Faculty of Science and Technology  
Federation University Australia  
Mount Helen, Australia  
Email: m.chadhar@federation.edu.au

## Abstract

The objective of this paper is to provide a systematic review of the evolutionary trends in the research domain of information technology and organizational learning. Having surveyed various journals and key conferences between 2000 and 2018 on the topic, we observe that *information technology (IT)* has expanded from its general form to various contemporary information systems, e.g. knowledge organization systems, communication and collaborative systems and decision support systems. However, *organization learning (OL)* now essentially occurs through knowledge management activities, e.g. knowledge acquisition, storing, sharing and application of knowledge. The survey reported here not only validates the interplay of IT and OL but also reveals some important intervening factors between IT and OL, e.g. absorptive capacity, organization culture, user trust, acceptance and satisfaction that work as deterministic elements in the reciprocal relationship of IT and OL. We propose future research to explore interaction between big data analytical systems and organizational learning.

**Keywords** organizational learning, information technology, knowledge management, information system, influential factors



## 1 Introduction

Information technology (IT) is an integral part of contemporary organizations which provides them a suitable platform for learning. Organizational learning (OL) is a way for continuous improvement of business processes and is achieved by management of tacit and explicit knowledge resources (Chadhar and Daneshgar 2018). Organizations learn and improve if there exists a mechanism for its employees to access required knowledge to run their daily activities. IT provides such mechanism within organization and it can be in different forms such as information systems, applications, hardware infrastructure and thus provides an infrastructure to acquire, retrieve and share data and information, which when processed in some specific context becomes knowledge, to its members to perform their organizational work (Broendsted and Elkjaer 2001). Hence, IT acts as a facilitator of knowledge management and ultimately triggers organizational learning. Information technology expedites the ability of the organizations to acquire new knowledge, transfer and represent this knowledge and apply it into their informed decision making, enhance their performance and gain competitive advantages over their counterparts. Nevertheless, organizations cannot achieve required benefits of IT, if they have not imbibed the necessary modalities to learn latest market trends, customer behaviours and competitors role (Tippins and Sohi 2003). OL plays a pivotal role in implementation, assimilation and utilization of IT to enhance organization performance and gain competitiveness (Cegarra-Navarro et al. 2007; Cho 2007; Lin and Lee 2005; Pebrianto and Djahur 2013; Reardon and Davidson 2007; Roberts et al. 2017; Torkestani et al. 2014). Knowledge acquisition, dissemination, representation and application are the main constructs of OL which are supported by IT altogether or separately. Various researchers (Chadhar 2017; Garrido-Moreno and Padilla-Meléndez 2011; Ke and Wei 2006; Myreteg 2015; Peltier et al. 2013; Verwijs and Soekijad 2002) have demonstrated role of OL in implementation mainly in the context of success of Enterprise Resource Planning (ERP) and Customer Relationship Management (CRM) systems. Although information technology and organizational learning are known to work independently but inherently, it has been observed that they have an interactive and reciprocal relationship (Robey et al. 2000). Having surveyed various literature, we observe that IT has expanded from its general form to various contemporary information systems, in contrast to previous studies on the topic, which enhance organizational learning and in response, OL provides a mechanism to utilize the technology efficiently. Thus both IT and OL have interplay. There are also some factors, such as organization culture, environment, user acceptance and satisfaction which affect the interplay of IT and OL. The survey of the scholarly literature helped us to develop a framework, depicted in Figure 1 and according to best of our knowledge, there is no such framework available in the literature before. The figure illustrates the interplay of IT and OL by showing that IT enhances organization learning whereas OL supports information technology, including the factors influencing this relationship.

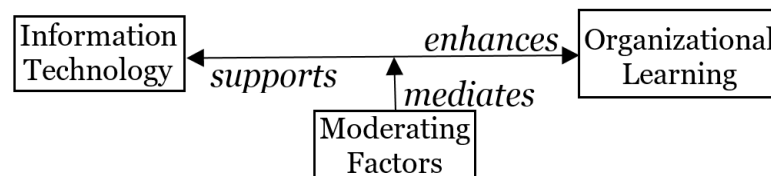

Figure 1: classification and relationship diagram of IT and OL (source: Developed for this research)

## 2 Methodology

We started our study to provide a systematic review of the evolutionary trends in the research domain of IT and OL to facilitate researchers and practitioners working to overcome implementation and utilization problems of information systems to increase their efficiency. Instead of being exhaustive and covering the entire domain of IT and OL, the survey aims to focus essentially on the interplay between IT and OL and the interceding factors which have influence on this interplay. To achieve this, we have chosen a specific criterion to select articles for this survey. Only recent (from January 2000 till July 2018) refereed journal and conference articles are included. The articles that emphasised certain terms in their title, such as “organizational learning” or any of its dimension and “information technology” or any of its application, are counted. Next, from the numerous databases available, we have restricted our search only to Scopus database because of its larger collection of scholarly journals and non-exhaustive nature of our study. With this restriction we have found 101 research articles. There is a small possibility that not all articles may get properly filtered and may thus escape in being included in this survey.

The survey is divided into four main categories: (i) Relationship between knowledge management and organizational learning, (ii) Studies that describe information technology as an enabler of organizational learning, (iii) Studies that treat organizational learning concepts to support information technology; and

(iv) Factors that affecting interplay between information technology and organizational learning. The survey reported here enables us to make specific conclusions about IT and OL and indicates some directions for future research reported by different authors in the literature.

### 3 Knowledge Management and Organizational Learning

All organizations need knowledge, tacit and explicit, to run their business effectively. Tacit knowledge is implicit and difficult to codify and imitate. While tacit knowledge can be found in the forms of skill and experience of employees. The explicit knowledge is formal and easy to access, articulate and codify in the form of electronic or paper documents. From the viewpoint of knowledge base theory, knowledge is power to remain successful in turbulent business world. Organizations put their maximum efforts to manage their internal and external knowledge to make it available to their employees to keep them more efficient and innovative in their roles. Knowledge management contributes significantly into organization performance. From information technology perspective, knowledge management serves to create, store, share and utilize knowledge (Ling 2011) . We can consider knowledge management to be an antecedent of organizational learning that is controlled by its manageable processes such as single and double loop learning and community of practice or both have same concern. Our viewpoint is supported by many researchers (Castaneda et al. 2018; Firestone and McElroy 2004; Spender 2008). We are of the opinion that whenever there is knowledge management within an organization there will certainly be an occurrence of organizational learning.

### 4 Information Technology for Organizational Learning

Information technology plays a very important role to make organizations efficient, to manage knowledge and learn quickly (Lopez-Nicolas and Soto-Acosta 2010; Mitić et al. 2017; Real et al. 2006; Tanriverdi 2005; Verwijs and Soekijad 2002). It provides a way to store and access required memory and knowledge rapidly by using internet, WWW, WAN, intranet or LAN and any other ICTs (Bennet and Shane Tomblin 2006; Chalmeta and Grangel 2008; Croasdell 2001). Organizations use various information systems for acquisition, retention, transfer and application of required knowledge to obtain competitive advantages and meet their objectives (Arias and Solana 2013; Baxter et al. 2009; Chou 2003; Davison et al. 2013; Hrastinski and Monstad 2014; Lyytinen and Rose 2006; Ruiz-Mercader et al. 2006). Janson et al. (2007) demonstrated role of information technology to support an organization to learn for successful transition from a socialist company to a privatized company. The similar concept is demonstrated by Cecez-Kecmanovic et al. (2010). We have categories information technology into knowledge organization systems, communication and collaborative systems and decision support system, figure 2. In the following sections, we have discussed how these information systems enhance organizational learning.

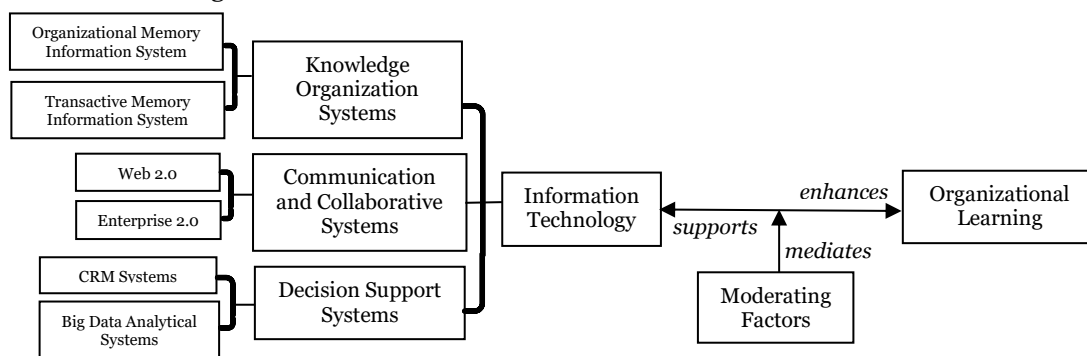

Figure 2: IT for OL (source: Developed for this research)

#### 4.1 Knowledge Organization Systems

These are the technology based systems which are used to manage, store and retrieve knowledge to enhance learning experience of organization. We have categories knowledge support systems into knowledge management systems, organizational memory information systems and transactive memory information systems.

Knowledge management systems facilitates organizations to collect, store, share and apply knowledge to achieve productivity in business. They support organizational processes and routines and contribute into overall organizational learning process (Gasson and Shelfer 2007; Yildirim 2017).

Organizational memory information systems such as databases, electronic bulletin boards, company yellow pages, intranet portals and knowledge repositories etc. provide means to organizations to access and protect their experiential knowledge to solve problems and perform better decisions making (Ji and Salvendy 2001; Olivera 2000). The systems keep knowledge available within organization when any employee leave the organization (Sudharatna 2015). Organizational memory systems initiate organizational learning through which employees reuse or gain new knowledge to perform their duties (Basaruddin et al. 2011).

Transactive memory information systems can be in the form of expertise directories, job description of employees, organizational organograms and social networks etc. that are digitally accessible to employees through information technology. These systems facilitate employees to know who knows what within organization and help them in improved tacit and explicit knowledge management and enhancing their learning experience and performance (Dunaway and Sabherwal 2012; Joy et al. 2012; Spraggon and Bodolica 2017; Wang et al. 2018; Zhang et al. 2012). An organization can learn faster and perform better than an organization that has not established any transactive memory system (Argote 2015). Organizational knowledge is usually stored in organization routines and transactive memory system helps employees to know who knows what about those routines, thus promoting knowledge management among employees (Argote and Guo 2016).

## **4.2 Communication and Collaborative Systems**

These are systems which facilitate collaboration and communication among employees, teams; virtual or distributed, or inter-organizations to acquire or share knowledge. E-collaboration among employees of an organization increases their productivity (Choi and Ko 2012). We have divided communication and collaboration into Web 2.0 tools and Enterprise social network systems.

Organizations use Web 2.0, social media technologies such as social websites, blogs, discussion forums etc., to increase collaboration and participation among employees to accomplish their tasks efficiently. Employees acquire and share knowledge through these tools and improve their learning experience and hence influence organizational learning for innovation, better performance and competitiveness (Boateng et al. 2009; Boateng et al. 2010; Huang and Güney 2012; London and Hall 2011; Menolli et al. 2017; Thomas and Akdere 2013; Zeng et al. 2015).

Enterprise social network systems (ESNS), also known as Enterprise 2.0, for instance Microsoft Yammer etc. imitate characteristics of Web 2.0 tools except these are used only within organizational boundaries. ESNS helps employees to capture and disseminate internal knowledge which ultimately enhance organizational learning, processes and outcome (Aboelmaged 2018; Qi and Chau 2018)

## **4.3 Decision Support Systems**

Decision support systems are used to apply the acquired knowledge. Information technologies has changed traditional decision tacking actions. Now organizations use technology supported systems to take better informed decisions about their counterparts, business strategies and goals. These systems support organizations to learn quickly and adopt rapidly to the changes; customer behaviours, supply chain, competitive forces, resource management etc., that are happening around its turbulent business environment (Bhatt and Zaveri 2002). We have found CRM and Big data analytical systems as a decision support system in our survey.

Customer relationship management system works as knowledge management tool within organization. CRM system provides customers information orientation, their behaviour towards product buying, loyalty, purchase patterns etc., which help top management to take informed decision about sales and marketing. The informed decisions, equipped with customer knowledge acquired through CRM system, improve organization performance (Stein and Smith 2009).

Big data is considered organization asset upon which analytics, through specialised tools, are applied to generate new knowledge. Big data analytics enhance organizational learning and facilitate organizations to improve their decision making activities and gain competitive advantage over their contenders (Calvard 2016; Erickson and Rothberg 2014; Fredriksson 2018; Kabir and Carayannis 2013; Khan and Vorley 2017; Lambrou 2016; Le Dinh et al. 2016; O'Connor and Kelly 2017). Predictive knowledge can be extracted from big data which improves organization's decision making capability. Sumbal et al. (2017) have illustrated the concept by an exploratory study in oil and gas industry. Similar

demonstration has also been reported by (Khan and Vorley 2017). Different organizational learning models are used to generate knowledge from big data. Philip (2018) used SECI model to exemplify the knowledge creation from big data. Other model of knowledge creation from big data are proposed by (Chan 2014; Izhar and Shoid 2016; Noh 2018).

## 5 Organizational Learning for Information Technology

Organization learning helps organizations in various ways to implement, utilize, govern and assimilate information technology. Figure 3 depicts how organizational learning facilitates information technology. Organizations that uses information technology in accordance with methods of organization learning have comparatively more advantage over organizations that have no organization learning initiative (Takian et al. 2014). Usually knowledge is embedded into tasks, members and tools of organizations and are considered knowledge repositories. Organizational learning seeds processes, routines, structures and capabilities within organizations that maximize understanding of implementation, utilization and management of information technology (Argote and Hora 2017).

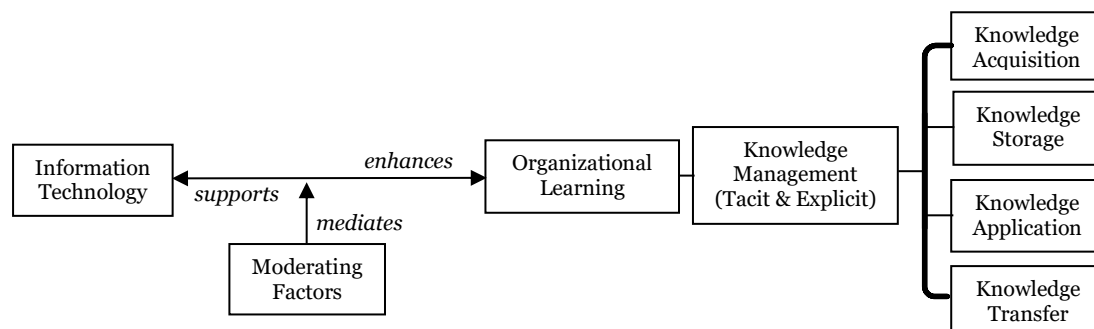

Figure 3: OL for IT (source: Developed for this research)

It acts as a catalyst to increase efficiency and effectiveness of an information system (Louis Raymond 2000). Vishwanath and Sankaranarayanan (2017) have demonstrated role of organizational learning in customer value creation through information technology supported CRM. Organizational learning enhances quality of customer data, contributing into better decision making regarding product and services, interactive customer marketing strategies and tactics, that fuels organization performance (Peltier et al. 2013). Similar concept regarding organizational learning as success factor of customer relationship management system have been reported by (Stein and Smith 2009). Organizations find implementation and post implementation of contemporary enterprise resource planning systems (ERP) a big challenge because of their complexity. Tomblin (2010) has proved organizational learning as a facilitator in deployment of ERP system. He has exemplified use of organization learning as a basis to understand and learn two phases of ERP; implementation and post implementation. Exploration and exploitation are two main dialects of organization learning that have different impact on of information technology in context of organization performance. There is trade-off between these two concepts and organizations need to keep balance in them for better organization performance (Hunter 2003).

## 6 Factors Affecting Interplay between IT and OL

In this section, we have included only those articles that fulfil inclusion criteria of our study and indicate factors that influence relationship of information technology and organizational learning. Following figure 4 represents the factors which affects relationship of IT and OL.

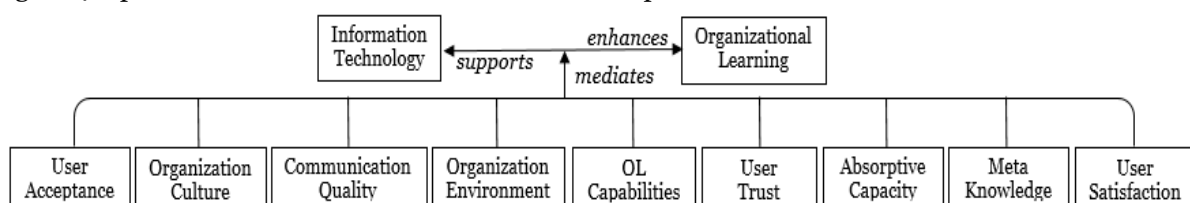

Figure 4: Factors affecting interplay between IT and OL (source: Developed for this research)

Absorptive capacity is ability of an organization to understand value of new external knowledge, assimilate the knowledge and apply it into its business activities. During implementation of new information technology, if the organization has no absorptive capacity then it can't learn to get

maximum benefits of the technology (Dong and Yang 2015). Marabelli and Newell (2009) have explained role of absorptive capacity in organizational learning and implementation of ERP system in a worldwide organization.

Benefits of contemporary technologies such as Web 2.0, CRM, ERP etc. are manifested in better knowledge management, learning and performance only if employees have trust on technology or among each other (Brockman et al. 2017; Simeonova 2017).

The organization environmental conditions affect organizational learning, exploration and exploitation, when employees make use of information technology. Information technology contribute to organizational learning differently in environmental turbulence and organization turnover (Kane and Alavi 2007).

Meta knowledge, knowledge exchange and knowledge structure, is more important than technical or professional competences to use an information system. If employees have no knowledge about contents structure of information system then it becomes itself a learning barrier. Therefore, employee 'knowledge about contents, characteristics of co-workers, cooperation between employees and self-competences works as a success factor in implementation of an information system and motivate learning process (Herrmann et al. 2003; Hrastinski and Monstad 2014).

Although organization leaning helps employees to gain skills and knowledge to use information technology but organizations cannot achieve required results if the employees are reluctant to accept that technology. Lee et al. (2013) investigated the influence of user acceptance on IT and concluded that user acceptance played a vital role to accept a new technology among operating room nursing staff.

User satisfaction is an important measure of effectiveness of an information system. It plays a critical role in learning, use or implementation of an information system within an organization. Organization can't achieve its goals if its employees are not satisfied with the technology being implemented, thus limiting its role in organizational learning (Goswami et al. 2006).

Reciprocal relationship between information systems such as transactive memory information system and knowledge management is mediated by communication among employees of an organization. Timely, useful and thoughtful communication among employees foster knowledge sharing within organization (Chen 2014).

Organization culture plays an important role to facilitate organizational learning and information technology . It has great effects on implementation, utilization and governance of information technology for knowledge sharing (Ruppel and Harrington 2001). It works as an instigator of knowledge acquisition and sharing ultimately fostering organizational learning and performance (Chuang et al. 2013). An organization can't survive and innovate if it has no culture to learn about new market trends, emerging technologies and strategies of its rivals (Al-Tameem 2004; Shao et al. 2017).

Organizational learning capabilities are known as the management practices or conditions within organization which may foster organizational learning . Continuous learning is necessary for organizations for their survival. OLC help organization to implement and utilize information technology for better decision making, to gain competitive advantages and enhance its performance (Nwankpa and Roumani 2014).

## **7 Conclusion**

We have consolidated a large body of knowledge on information technology and organizational learning that reveals intertwined nature of these two disciplines and validates previous studies of their interplay. For IT to OL research stream, we conclude that information technology enhances organizational learning or its dimensions in many ways such as knowledge organization systems help for knowledge storage and retrieval, communication and collaborative systems make knowledge acquisition and dissimilation efficient, and decision support systems promote application of knowledge, thus improving overall business processes and gaining competitive advantages.

For OL to IT research stream, we believe that organizational learning supports deployment, implementation and assimilation of information technology. Organizations can increase their performance, innovate and gain advantage over their counterparts only if there is some mechanism to capture, store and share knowledge through information technology. This mechanism is provided by organizational learning in the form of single loop learning, double loop learning, 'community of practice' and SECI model.

Our survey has also identified some influential factors such as organization culture and environment, user acceptance and satisfaction, meta-knowledge, absorptive capacity that need to be considered while implementing information technology in an organization. There are also some limitations of our research. First, we have used only one, albeit very authentic, database of record, Scopus. Second, we have included only peer reviewed articles of a specific period. Therefore, there is possibility of missing some relevant research, however large inclusion of body of knowledge into our survey has reduced the chance to challenge our results. This paper highlights some gaps in the literature that work an opportunity for future research such as relationship of big data and artificial intelligence with organizational learning. As most of the literature indicates that organizations fail in successful implementation of information systems, therefore an empirical investigation of the interaction between big data and organization learning will open new doors for organizations to deploy, implement and assimilate big data systems effectively. We also hope that such kind of research will act as a classification model to find cause and outcome of the relationship of big data and OL. Relationship and gaps of the theories reported in this paper, provide an opportunity for IS researcher to conduct future research.

### Directions for Future Research

Some future directions reported in surveyed literature are: Firstly, the researchers, in IT to OL research stream, commends further inquiry to seek interaction of information technology with different sources of organizational learning e.g. individual learning. They also solicited to explore enabling role of different information intensive techniques such machine learning and data mining into organizational learning.

Secondly, in the reviewed literature of OL to IT stream, researchers seem to be interested to find exclusive impact of each source of OL on implementation of various information systems such as e-commerce applications. Role of OL for implementation (pre implementation vs post implementation) of distinct information systems such as ERP and CRM is also suggested for future exploration.

Finally, although there are many factors reported in the literature that affect interaction of information technology and organizational learning, however additional factors for instance manager's ambiguity regarding information technology or competitors, relational capital, organization structure, management style and reward system in organization need further inquest. These factors are very important because they may cause low performance of information technology and hindrance in organizational learning and hence draw attention to be addressed. Reverse effect of information technology and organizational learning on such factors is another future research direction that is reported in the literature.

## 8 References

- Aboelmegeed, M. G. 2018. "Knowledge Sharing through Enterprise Social Network (Esn) Systems: Motivational Drivers and Their Impact on Employees' Productivity," *Journal of Knowledge Management* (22:2), pp. 362-383.
- Al-Tameem, A. A. 2004. "An Inhibiting Context Hampering Role of Information Technology as an Enabler in Organizational Learning," *Journal of Computer Information Systems* (44:4), pp. 34-40.
- Alavi, M., and Tiwana, A. 2002. "Knowledge Integration in Virtual Teams: The Potential Role of Kms," *Journal of the Association for Information Science and Technology* (53:12), pp. 1029-1037.
- ANDO, F. 2002. "The Real Relationship between Organizational Culture and Organizational Learning," *Annals of Business Administrative Science* (1:2), pp. 25-34.
- Argote, L. 2015. "An Opportunity for Mutual Learning between Organizational Learning and Global Strategy Researchers: Transactive Memory Systems," *Global Strategy Journal* (5:2), pp. 198-203.
- Argote, L., and Guo, J. M. 2016. "Routines and Transactive Memory Systems: Creating, Coordinating, Retaining, and Transferring Knowledge in Organizations," *Research in Organizational Behavior* (36), pp. 65-84.
- Argote, L., and Hora, M. 2017. "Organizational Learning and Management of Technology," *Production and Operations Management* (26:4), pp. 579-590.
- Arias, J. M., and Solana, J. M. 2013. "Information Systems Supported Organizational Learning as a Competitive Advantage," *Journal of Industrial Engineering and Management* (6:3), pp. 702-708.
- Basaruddin, S., Haron, H., and Noordin, S. A. 2011. "Understanding Organizational Memory System for Managing Knowledge," *International Conference on Advancements in Information Technology ICAIT 2011*.

- Baxter, G. J., Connolly, T. M., and Stansfield, M. 2009. "How Can Organisations Learn: An Information Systems Development Perspective," *Learning Inquiry* (3:1), pp. 25-46.
- Bennet, A., and Shane Tomblin, M. 2006. "A Learning Network Framework for Modern Organizations: Organizational Learning, Knowledge Management and Ict Support," *Vine* (36:3), pp. 289-303.
- Bhatt, G. D., and Zaveri, J. 2002. "The Enabling Role of Decision Support Systems in Organizational Learning," *Decision Support Systems* (32:3), pp. 297-309.
- Boateng, R., Malik, A., and Mbarika, V. 2009. "Web 2.0 and Organizational Learning: Conceptualizing the Link," *AMCIS 2009 Proceedings*, p. 546.
- Boateng, R., Mbarika, V., and Thomas, C. 2010. "When Web 2.0 Becomes an Organizational Learning Tool: Evaluating Web 2.0 Tools," *Development and Learning in Organizations: An International Journal* (24:3), pp. 17-20.
- Brockman, B. K., Park, J. E., and Morgan, R. M. 2017. "The Role of Buyer Trust in Outsourced Crm: Its Influence on Organizational Learning and Performance," *Journal of Business-to-Business Marketing* (24:3), pp. 201-219.
- Broendsted, J., and Elkjaer, B. 2001. "Information Technology as a Fellow Player in Organizational Learning," *ECIS 2001 Proceedings*, p. 12.
- Calvard, T. S. 2016. "Big Data, Organizational Learning, and Sensemaking: Theorizing Interpretive Challenges under Conditions of Dynamic Complexity," *Management learning* (47:1), pp. 65-82.
- Castaneda, D. I., Manrique, L. F., and Cuellar, S. 2018. "Is Organizational Learning Being Absorbed by Knowledge Management? A Systematic Review," *Journal of Knowledge Management* (22:2), pp. 299-325.
- Cecez-Kecmanovic, D., Janson, M., and Zupancic, J. 2010. "Transition to Market Economy through Information Systems and Organizational Learning: A Case of Sava Company," *Journal of Information Technology Case and Application Research* (12:4), pp. 61-83.
- Cegarra-Navarro, J. G., Jiménez, D. J., and MartíNez-Conesa, E. Á. 2007. "Implementing E-Business through Organizational Learning: An Empirical Investigation in Smes," *International Journal of Information Management* (27:3), pp. 173-186.
- Chadhar, M., and Daneshgar, F. 2018. "Organizational Learning and Erp Post-Implementation Phase: A Situated Learning Perspective," *Journal of Information Technology Theory and Application (JITTA)* (19:2), p. 7.
- Chadhar, M. A. 2017. "Is Enactment and Organisational Learning: A Case of an Integrated Erp Post-Implementation in Australia," in: *Australian Conference on Information Systems*. Hobart, Australia.
- Chalmeta, R., and Grangel, R. 2008. "Methodology for the Implementation of Knowledge Management Systems," *Journal of the Association for Information Science and Technology* (59:5), pp. 742-755.
- Chan, J. O. 2014. "Big Data Customer Knowledge Management," *Communications of the IIMA* (14:3), pp. 45-56.
- Chen, X. 2014. "Transactive Memory System, Communication Quality, and Knowledge Sharing in Distributed Teams: An Empirical Examination in Open Source Software Project Teams," in: *International Conference on Information Systems*. Auckland.
- Cho, V. 2007. "A Study of the Impact of Organizational Learning on Information System Effectiveness," *International Journal of Business and Information* (2:1), pp. 127-158.
- Choi, S., and Ko, I. 2012. "Leveraging Electronic Collaboration to Promote Interorganizational Learning," *International Journal of Information Management* (32:6), pp. 550-559.
- Chou, S.-W. 2003. "Computer Systems to Facilitating Organizational Learning: It and Organizational Context," *Expert Systems with Applications* (24:3), pp. 273-280.
- Chuang, S.-H., Liao, C., and Lin, S. 2013. "Determinants of Knowledge Management with Information Technology Support Impact on Firm Performance," *Information Technology and Management* (14:3), pp. 217-230.
- Croasdell, D. T. 2001. "It's Role in Organizational Memory and Learning," *Information Systems Management* (18:1), pp. 8-11.
- Davison, R. M., Ou, C. X., and Martinsons, M. G. 2013. "Information Technology to Support Informal Knowledge Sharing," *Information Systems Journal* (23:1), pp. 89-109.
- Dong, J. Q., and Yang, C.-H. 2015. "Information Technology and Organizational Learning in Knowledge Alliances and Networks: Evidence from Us Pharmaceutical Industry," *Information & Management* (52:1), pp. 111-122.
- Dunaway, M. M., and Sabherwal, R. 2012. "Understanding the Role of Transactive Memory Systems and Knowledge Management Mechanisms on Team Performance," in: *International Conference on Information Systems*. Orlando.

- Erickson, S., and Rothberg, H. 2014. "Big Data and Knowledge Management: Establishing a Conceptual Foundation," *The Electronic Journal of Knowledge Management* (12:2), pp. 108-116.
- Firestone, J. M., and McElroy, M. W. 2004. "Organizational Learning and Knowledge Management: The Relationship," *The Learning Organization* (11:2), pp. 177-184.
- Fredriksson, C. 2018. "Big Data Creating New Knowledge as Support in Decision-Making: Practical Examples of Big Data Use and Consequences of Using Big Data as Decision Support," *Journal of Decision Systems*, pp. 1-18.
- Garrido-Moreno, A., and Padilla-Meléndez, A. 2011. "Analyzing the Impact of Knowledge Management on Crm Success: The Mediating Effects of Organizational Factors," *International Journal of Information Management* (31:5), pp. 437-444.
- Gasson, S., and Shelfer, K. M. 2007. "It-Based Knowledge Management to Support Organizational Learning: Visa Application Screening at the Ins," *Information Technology & People* (20:4), pp. 376-399.
- Gil, R. J., and Martin-Bautista, M. J. 2012. "A Novel Integrated Knowledge Support System Based on Ontology Learning: Model Specification and a Case Study," *Knowledge-Based Systems* (36), pp. 340-352.
- Goswami, S., Chan, H. C., and Chua, A. L. 2006. "Intranets and Organizational Learning: Impact of Metadata Filters on Information Quality, User Satisfaction and Intention to Use," *PACIS 2006 Proceedings*, p. 16.
- Herrmann, T., Kienle, A., and Reiband, N. 2003. "Meta-Knowledge-a Success Factor for Computer-Supported Organizational Learning in Companies," *Educational Technology & Society* (6:1), pp. 9-13.
- Hrastinski, S., and Monstad, T. 2014. "Exploring the Relationship between the Use of an Interactive Video Website and Organizational Learning," *New Media & Society* (16:4), pp. 594-614.
- Huang, K.-Y., and Güney, S. 2012. "Toward a Framework of Web 2.0-Driven Organizational Learning," *CAIS* (31), p. 6.
- Hunter, S. 2003. "Information Technology, Organizational Learning, and the Market Value of the Firm," *Journal of Information Technology Theory and Application* (5:1), pp. 1-28.
- Izhar, T. A. T., and Shoid, M. S. M. 2016. "A Research Framework on Big Data Awareness and Success Factors toward the Implication of Knowledge Management: Critical Review and Theoretical Extension," *International Journal of Academic Research in Business and Social Sciences* (6:4), pp. 325-338.
- Jackson, P., and Klobas, J. 2008. "Transactive Memory Systems in Organizations: Implications for Knowledge Directories," *Decision Support Systems* (44:2), pp. 409-424.
- Janson, M., Cecez-Keemanovic, D., and Zupančič, J. 2007. "Prospering in a Transition Economy through Information Technology-Supported Organizational Learning," *Information Systems Journal* (17:1), pp. 3-36.
- Jerez-Gomez, P., Céspedes-Lorente, J., and Valle-Cabrera, R. 2005. "Organizational Learning Capability: A Proposal of Measurement," *Journal of business research* (58:6), pp. 715-725.
- Ji, Y. G., and Salvendy, G. 2001. "A Framework for Improving Organizational Learning through a User-Adaptive Intranet Portal Organizational Memory Information System," *The International Journal of Aviation Psychology* (11:2), pp. 123-148.
- Joy, W. H., Fang, Y., and Schroeder, A. 2012. "Transactive Memory Systems, Knowledge Integration, and Team Performance in Geographically Dispersed Teams," *ECIS 2012 Proceedings*.
- Kabir, N., and Carayannis, E. 2013. "Big Data, Tacit Knowledge and Organizational Competitiveness," *Journal of Intelligence Studies in Business* (3:3).
- Kane, G. C., and Alavi, M. 2007. "Information Technology and Organizational Learning: An Investigation of Exploration and Exploitation Processes," *Organization Science* (18:5), pp. 796-812.
- Ke, W., and Wei, K. K. 2006. "Organizational Learning Process: Its Antecedents and Consequences in Enterprise System Implementation," *Journal of Global Information Management* (14:1), p. 1.
- Khan, Z., and Vorley, T. 2017. "Big Data Text Analytics: An Enabler of Knowledge Management," *Journal of Knowledge Management* (21:1), pp. 18-34.
- Kraska, T. 2013. "Finding the Needle in the Big Data Systems Haystack," *IEEE Internet Computing* (17:1), pp. 84-86.
- Lambrou, M. 2016. "Innovation Capability, Knowledge Management and Big Data Technology: A Maritime Business Case," *International Journal of Advanced Corporate Learning (iJAC)* (9:2), pp. 40-44.
- Le Dinh, T., Phan, T.-C., and Bui, T. 2016. "Towards an Architecture for Big Data-Driven Knowledge Management Systems," in: *AMCIS*.



- Lee, C.-C., Lin, S.-P., Yang, S.-L., Tsou, M.-Y., and Chang, K.-Y. 2013. "Evaluating the Influence of Perceived Organizational Learning Capability on User Acceptance of Information Technology among Operating Room Nurse Staff," *Acta Anaesthesiologica Taiwanica* (51:1), pp. 22-27.
- Lin, H.-F., and Lee, G.-G. 2005. "Impact of Organizational Learning and Knowledge Management Factors on E-Business Adoption," *Management Decision* (43:2), pp. 171-188.
- Ling, L. S. 2011. "Defining Knowledge Management (Km) Activities from Information Communication Technologies (Icts) Perspective," *Journal of Organizational Knowledge Management* (2011), pp. 1-10.
- London, M., and Hall, M. 2011. "Web 2.0 Support for Individual, Group and Organizational Learning," *Human Resource Development International* (14:1), pp. 103-113.
- Lopez-Nicolas, C., and Soto-Acosta, P. 2010. "Analyzing Ict Adoption and Use Effects on Knowledge Creation: An Empirical Investigation in Smes," *International Journal of Information Management* (30:6), pp. 521-528.
- Louis Raymond, S. B. 2000. "Organizational Learning as a Foundation of Electronic Commerce in the Network Organization," *International Journal of Electronic Commerce* (5:2), pp. 29-45.
- Lyytinen, K., and Rose, G. M. 2006. "Information System Development Agility as Organizational Learning," *European Journal of Information Systems* (15:2), pp. 183-199.
- Marabelli, M., and Newell, S. 2009. "Organizational Learning and Absorptive Capacity in Managing Erp Implementation Projects," *ICIS 2009 Proceedings*, p. 136.
- Menolli, A. L. A., Pinto, H. S., Reinehr, S., and Malucelli, A. 2017. "Secol: A Semantic Environment Based on Social Media to Support Organisational Learning," *Behaviour & Information Technology* (36:4), pp. 364-389.
- Mitić, S., Nikolić, M., Jankov, J., Vukonjanski, J., and Terek, E. 2017. "The Impact of Information Technologies on Communication Satisfaction and Organizational Learning in Companies in Serbia," *Computers in Human Behavior* (76), pp. 87-101.
- Myreteg, G. 2015. "Organizational Learning and Erp Systems in the Post-Implementation Phase: Where Do We Stand? A Literature Review," *Electronic Journal Information Systems Evaluation Volume* (18:2).
- Noh, K.-S. 2018. "Model of Knowledge-Based Process Management System Using Big Data in the Wireless Communication Environment," *Wireless Personal Communications* (98:4), pp. 3147-3162.
- Nwankpa, J., and Roumani, Y. 2014. "Understanding the Link between Organizational Learning Capability and Erp System Usage: An Empirical Examination," *Computers in Human Behavior* (33), pp. 224-234.
- O'Connor, C., and Kelly, S. 2017. "Facilitating Knowledge Management through Filtered Big Data: Sme Competitiveness in an Agri-Food Sector," *Journal of Knowledge Management* (21:1), pp. 156-179.
- Olivera, F. 2000. "Memory Systems in Organizations: An Empirical Investigation of Mechanisms for Knowledge Collection, Storage and Access," *Journal of management studies* (37:6), pp. 811-832.
- Pebrianto, A., and Djamhur, S. 2013. "The Influence of Information Technology Capability, Organizational Learning, and Knowledge Management Capability on Organizational Performance (a Study of Banking Branches Company in Southern Kalimantan Province)," *Information and Knowledge Management* (3:11), pp. 112-120.
- Peltier, J. W., Zahay, D., and Lehmann, D. R. 2013. "Organizational Learning and Crm Success: A Model for Linking Organizational Practices, Customer Data Quality, and Performance," *Journal of Interactive Marketing* (27:1), pp. 1-13.
- Philip, J. 2018. "An Application of the Dynamic Knowledge Creation Model in Big Data," *Technology in Society*.
- Qi, C., and Chau, P. Y. K. 2018. "Will Enterprise Social Networking Systems Promote Knowledge Management and Organizational Learning? An Empirical Study," *Journal of Organizational Computing and Electronic Commerce* (28:1), pp. 31-57.
- Real, J. C., Leal, A., and Roldán, J. L. 2006. "Information Technology as a Determinant of Organizational Learning and Technological Distinctive Competencies," *Industrial Marketing Management* (35:4), pp. 505-521.
- Reardon, J. L., and Davidson, E. 2007. "An Organizational Learning Perspective on the Assimilation of Electronic Medical Records among Small Physician Practices," *European Journal of Information Systems* (16:6), pp. 681-694.
- Roberts, N., Gerow, J. E., Jeyaraj, A., and Roberts, S. 2017. "A Meta-Analysis of Organizational Learning and It Assimilation," *ACM SIGMIS Database: the DATABASE for Advances in Information Systems* (48:4), pp. 51-68.

- Robey, D., Boudreau, M.-C., and Rose, G. M. 2000. "Information Technology and Organizational Learning: A Review and Assessment of Research," *Accounting, Management and Information Technologies* (10:2), pp. 125-155.
- Ruiz-Mercader, J., Meroño-Cerdan, A. L., and Sabater-Sánchez, R. 2006. "Information Technology and Learning: Their Relationship and Impact on Organisational Performance in Small Businesses," *International journal of information management* (26:1), pp. 16-29.
- Ruppel, C. P., and Harrington, S. J. 2001. "Sharing Knowledge through Intranets: A Study of Organizational Culture and Intranet Implementation," *IEEE transactions on professional communication* (44:1), pp. 37-52.
- Shao, Z., Feng, Y., and Hu, Q. 2017. "Impact of Top Management Leadership Styles on Erp Assimilation and the Role of Organizational Learning," *Information & Management* (54:7), pp. 902-919.
- Simeonova, B. 2017. "Transactive Memory Systems and Web 2.0 in Knowledge Sharing: A Conceptual Model Based on Activity Theory and Critical Realism," *Information Systems Journal*.
- Spender, J.-C. 2008. "Organizational Learning and Knowledge Management: Whence and Whither?," *Management learning* (39:2), pp. 159-176.
- Spraggon, M., and Bodolica, V. 2017. "Collective Tacit Knowledge Generation through Play: Integrating Socially Distributed Cognition and Transactive Memory Systems," *Management Decision* (55:1), pp. 119-135.
- Stein, A., and Smith, M. 2009. "Crm Systems and Organizational Learning: An Exploration of the Relationship between Crm Effectiveness and the Customer Information Orientation of the Firm in Industrial Markets," *Industrial Marketing Management* (38:2), pp. 198-206.
- Sudharatna, Y. 2015. "Organizational Memory System as a Foundation of Knowledge Management," *International Conference on Intellectual Capital and Knowledge Management and Organisational Learning: Academic Conferences International Limited*, p. 276.
- Sumbal, M. S., Tsui, E., and See-to, E. W. 2017. "Interrelationship between Big Data and Knowledge Management: An Exploratory Study in the Oil and Gas Sector," *Journal of Knowledge Management* (21:1), pp. 180-196.
- Takian, A., Sheikh, A., and Barber, N. 2014. "Organizational Learning in the Implementation and Adoption of National Electronic Health Records: Case Studies of Two Hospitals Participating in the National Programme for Information Technology in England," *Health informatics journal* (20:3), pp. 199-212.
- Tanriverdi, H. 2005. "Information Technology Relatedness, Knowledge Management Capability, and Performance of Multibusiness Firms," *MIS quarterly*, pp. 311-334.
- Thomas, K. J., and Akdere, M. 2013. "Social Media as Collaborative Media in Workplace Learning," *Human Resource Development Review* (12:3), pp. 329-344.
- Tippins, M. J., and Sohi, R. S. 2003. "It Competency and Firm Performance: Is Organizational Learning a Missing Link?," *Strategic management journal* (24:8), pp. 745-761.
- Tomblin, M. S. 2010. "Theory Development in Enterprise Systems and Organizational Learning," *Journal of Organizational Computing and Electronic Commerce* (20:4), pp. 398-416.
- Torkestani, M. S., Mazloomi, N., and Haghghat, F. 2014. "The Relationship between Information Systems Success, Organizational Learning and Performance of Insurance Companies," *International Journal of Business and Social Science* (5:10).
- Verwijs, C., and Soekijad, M. 2002. "Functions of Ict for Supporting Organisational Learning," *International journal of information technology and management* (1:1), pp. 103-114.
- Vishwanath, K. R., and Sankaranarayanan, B. 2017. "Customer Value Creation in Crm Initiatives: The Impacts of Organizational Learning and It Capabilities," in: *AMCIS*.
- Wang, Y., Huang, Q., Davison, R. M., and Yang, F. 2018. "Effect of Transactive Memory Systems on Team Performance Mediated by Knowledge Transfer," *International Journal of Information Management* (41), pp. 65-79.
- Yıldırım, N. 2017. "Organisational Learning through Knowledge Management Systems: A Case Study on Improvement of Customer Support Processes," *International Journal of Knowledge Management Studies* (8:3-4), pp. 375-402.
- Zeng, S., Gonzalez, J., and Lobato, C. 2015. "The Effect of Organizational Learning and Web 2.0 on Innovation," *Management Decision* (53:9), pp. 2060-2072.
- Zhang, C., Hong, D., and Ling, H. 2012. "A Study on the Mechanism of Tacit Knowledge Integration: The Role of Social Ties and Transactive Memory Systems," *International Journal of Innovative Computing, Information and Control* (8:8), pp. 5847-5857.

**Copyright:** © 2018 authors. This is an open-access article distributed under the terms of the [Creative Commons Attribution-NonCommercial 3.0 Australia License](https://creativecommons.org/licenses/by-nc/3.0/), which permits non-commercial use, distribution, and reproduction in any medium, provided the original author and ACIS are credited.

# Assessing the impact of using instant messaging in eLearning on the performance of teaching and learning in higher education

## **Aaron Bere**

School of Information of Business IT and Logistics  
RMIT University  
Melbourne, Victoria, Australia  
Email: [aaron.bere@rmit.edu.au](mailto:aaron.bere@rmit.edu.au)

## **Hepu Deng**

School of Information of Business IT and Logistics  
RMIT University  
Melbourne, Victoria, Australia  
Email: [hepu.deng@rmit.edu.au](mailto:hepu.deng@rmit.edu.au)

## **Richard Tay**

School of Information of Business IT and Logistics  
RMIT University  
Melbourne, Victoria, Australia  
Email: [richard.tay@rmit.edu.au](mailto:richard.tay@rmit.edu.au)

## **Abstract**

There are growing interests in improving teaching and learning performance through eLearning using specific emerging technologies in higher education. As a result, understanding the impact of using such technologies on the performance of teaching and learning is becoming important. This experimental study investigates the impact of eLearning using instant messaging on the performance of teaching and learning in higher education in developing countries. Pre-test and post-test surveys are used for collecting experimental data from participants to investigate the impact of using instant messaging on teaching and learning. Data analysis conducted quantitatively using SPSS reveals that eLearning using instant messaging improves teaching and learning. In particular, the use of instant messaging in eLearning is more effective than face-to-face teaching and learning with respect to the overall performance in the classroom. This leads to the conclusion that eLearning using instant messaging could transform teaching and learning in higher education in developing countries.

**Keywords** eLearning, instant messaging, performance in teaching and learning, student grades, interaction

## 1 Introduction

Instant messaging is an emerging digital technology that offers real-time text and video transmission over the Internet. It is becoming increasingly popular with the rapid development of information and communication technologies (ICT), in particular the availability of smartphones (Bere and McKay, 2017). This is due to the benefits instant messaging offers to individual users including the ability to send text messages, audio, video chat, and group chat for free, the convenience and immediacy in communication regardless of time and geographical constraints unlike computer based communication services, and the capacity to provide an integrated platform for connecting various services such as electronic payments, online gaming, and social networking (Sun et al., 2017).

There is an increasing interest in the use of instant messaging in the development of effective electronic learning (eLearning) in higher education (Bere and Rambe, 2016; So, 2016; Murire and Cilliers, 2017). This is due to the high proliferation of instant messaging and the ability to support collaborative, ubiquitous, and personalised learning (Bere and Rambe, 2016). As a result, there are various projects that have been implemented on the adoption of instant messaging in higher education for improving teaching and learning (Bere and Rambe, 2016; So, 2016).

Much research has been done that shows the potential benefits for adopting eLearning using instant messaging in higher education (Bere and Rambe, 2016; So, 2016). There is, however, lack of studies that focus on investigating the impact of using instant messaging on teaching and learning performance (Bere and McKay, 2017), especially in developing countries in which eLearning resources are limited (Rambe and Bere, 2013). There are mixed findings with respect to the effectiveness of eLearning using instant messaging in the literature. Some studies, for instance, argue that the use of eLearning using instant messaging has positive effects on teaching and learning in higher education (Bere and Rambe, 2016; So, 2016). Some other studies report various drawbacks of using instant messaging in eLearning including the negative impact on writing because students tend to overlook an appropriate use of vowels and punctuation, prone to high levels of distraction while learning, and lack of organisation of the discussions held over these applications (Fewkes and McCabe, 2012; Wang, Woo and Quek, 2012). This shows that there is a need for better understanding the impact of using instant messaging on the performance of teaching and learning in higher education.

The aim of the study is to investigate the impact of eLearning using instant messaging on the performance of teaching and learning in higher education in developing countries. The study follows a pre-test and post-test control group experimental design in order to achieve the purpose of the study. Pre-tests and post-test surveys are used for collecting data from undergraduate students in South Africa. The collected data are analysed using SPSS. The results show that eLearning using instant messaging improves teaching and learning. Furthermore, the use of instant messaging in eLearning is more effective than face-to-face teaching and learning with respect to the overall performance in the classroom. This study contributes to the ongoing debate on how to improve teaching and learning using emerging technologies. The findings of this study can lead to better adoption of eLearning using instant messaging in higher education.

In what follows, the second section provides a review of the related literature about the use of instant messaging in eLearning. The third section addresses the research question and the development of hypotheses in the study. The fourth section presents the methodology used in this study. The fifth section provides a quantitative data analysis using SPSS. This is followed by the research findings and discussion. Finally, the conclusion of the study is provided.

## 2 Literature Review

eLearning can be approached from different viewpoints including the educational paradigm and the delivery orientation (Lee, Yoon and Lee, 2009; Sek et al., 2016). Educational philosophers view eLearning as a self-regulated knowledge acquisition practice achieved through various learning processes including interactions using digital technologies (Lee, Yoon and Lee, 2009; Sek et al., 2015). Delivery-oriented research treats eLearning as the delivery of teaching and learning material in various formats including documents, texts, audios, and videos through ICT (Lee, Yoon and Lee, 2009). In this study, eLearning is referred to as a teaching and learning approach that focuses on the needs and abilities of students through adopting digital technologies to provide students with electronic content asynchronously or synchronously in a blended setting at anytime and anywhere (Bere and Rambe, 2016).

The popularity of instant messaging in eLearning provokes the need to develop new modes of eLearning systems in higher education (So, 2016). This is because instant messaging offers numerous

benefits to teaching and learning including the ability to facilitate the flow of information and the sharing of information among students and teachers, the capacity to provide anywhere and anytime learning through using smartphones, the capability of combining audio, text, and video communications in a user-friendly multi-modal platform that allows students to interact through message exchanges at no cost or minimal cost. In particular, students can easily record an audio, take a photo, and record a video, attach these files and send them easily to other students as learning materials (Rambe and Bere, 2013; Sun et al., 2018). This leads to an increased acceptance of instant messaging in eLearning for teaching and learning in higher education.

Robinson et al. (2015) conduct a study in the United Kingdom about the potential of using instant messaging in promoting teaching and learning in higher education. The study reveals that instant messaging facilitates the development of a social presence among students in teaching and learning in higher education. Such a social presence creates an immediate connection between students, therefore leading to the improvement of teaching and learning. In particular, this study recognises various affordances of instant messaging in teaching and learning including the promptness of the immediate arrival of new messages, the easiness of uploading and downloading text, audio, and video messages, the availability of user-friendly interfaces for collaborative learning, the ability to arrange messages in a chronological order to facilitate the finding of the original thread, and the capacity to form groups without the intervention of the third party. The study, however, does not directly investigate the impact of instant messaging on the performance of teaching and learning in higher education.

So (2016) investigates the effectiveness of eLearning using instant messaging in higher education at Hong Kong. The study utilises a mixed-methods approach including experimental and control groups, and surveys. It reveals that instant messaging improves the performance of teaching and learning. The study further shows that there is an increasing acceptance of instant messaging in eLearning as a teaching and learning tool in higher education at Hong Kong. Such a study is useful for better understanding the impact of using instant messaging in eLearning on the performance of teaching and learning in higher education. The study, however, is conducted in the context of developed countries in which the overall environment for the use of instant messaging is very much different from the context of developing countries.

Awada (2016) explores the effectiveness of eLearning using instant messaging on the performance of teaching and learning in developing countries with respect to the proficiency of critique writing in higher education. The study follows a pre-test and post-test control group experimental design. It reveals that instant messaging is more effective in enhancing the critique writing proficiency of the participants through increasing the motivation of students for learning. Overall this study provides better understanding of the impact of using instant messaging in eLearning on the performance of teaching and learning. It is, however, limited in the generalisability of the research findings due to the focus of the study only in teaching and learning of the English language in higher education.

In South Africa, Rambe and Bere (2013) investigates the effectiveness of eLearning using instant messaging in higher education with the adoption of a qualitative approach. Such a study is conducted within the framework for the rational analysis of mobile education (Koole, 2009). It reveals that the use of instant messaging in eLearning improves teaching and learning in various ways including intensified students' academic participation, developed learning communities for knowledge creation, and increased knowledge sharing capabilities. This leads to improved user perceptions that influence the intention of students to adopt eLearning using instant messaging in higher education.

Rambe and Bere (2013) explore the challenges of eLearning using instant messaging in higher education for improving teaching and learning. This leads to the identification of specific challenges to the effective use of instant messaging including the presence of slow download of large audio and video files, the struggle of students in expressing themselves in English, the existence of student fears of increased workloads through responding to peers' queries, the need for giving critiques based on in-depth understanding, the pressure of collaborative engagements, and the disturbance of instant messaging notifications. This study is valuable for better understanding the use of instant messaging in eLearning. This is because the identifications of the challenges can help eLearning practitioners develop more effective strategies and policies for improving the use of instant messaging in eLearning.

Murire and Cilliers (2017) conduct a study in South Africa to investigate the critical factors that influence the adoption of eLearning using instant messaging in higher education following the unified theory of acceptance and use of technology (Venkatesh et al., 2003). The study argues that the adoption of eLearning using instant messaging could improve teaching and learning through improved communication between students and lecturers. This leads to the identification of various critical factors for the adoption of eLearning using instant messaging including performance expectancy,

social influence, effort expectancy and behavioural intention. This study is useful in better understanding the critical factors for the adoption of instant messaging in eLearning for improving teaching and learning. There is, however, lack of empirical studies on the impact of using instant messaging in eLearning on teaching and learning performance in higher education with the use of quantitative approaches.

The studies above examine the impact of using instant messaging on the performance of teaching and learning in higher education. These studies show that performance in teaching and learning is measured in various ways including social presence, student grades, student perceptions, and learning activities such interactions. The literature review shows that the performance in teaching and learning influence adoption of eLearning in higher education. However, there is little research in the investigation of performance in teaching and learning in developing countries mainly using student grades.

### **3 Research questions and hypotheses development**

This study aims to investigate the impact of eLearning using instant messaging on the performance of teaching and learning in higher education in developing countries. To adequately achieve this objective, the main research question for the study is formulated as follows: *How effective is the use of instant messaging in eLearning for improving teaching and learning in higher education in developing countries?*

To successfully address this research question, two hypotheses have been developed with respect to the relationship between the use of instant messaging and the performance of teaching and learning in higher education in developing countries. Such hypotheses are to be tested through the use of the control group in order to adequately assess the impact of using instant messaging in eLearning on the performance of teaching and learning in higher education.

The performance of teaching and learning in eLearning can be measured from different perspectives including social presence, levels of interaction, student satisfaction, and student grades (Rambe and Bere, 2013; Robinson et al., 2015; So, 2016). Social presence is used to measure the performance of teaching and learning as the degree at which a communication medium mimics the characteristics of face-to-face interaction (Park, Cho and Lee, 2014). Use interaction is adopted to measure the performance of teaching and learning in which interaction is defined as a two-way communication between individuals, either on an individual or group basis during teaching and learning (Jesus and Moreira, 2009). User satisfaction is used to measure the performance of teaching and learning as the degree of student's opinion about the potential of eLearning to improve teaching and learning (Vasileva-Stojanovska et al., 2015). Student grades are a standardised measurement of varying levels of achievements in a course based on an individual's scores (Warne et al., 2014). They are commonly used in measuring the performance of teaching and learning, in particular in developing countries like South Africa.

There is a common recognition that the performance of teaching and learning is positively associated with the adoption of eLearning in higher education. Rudman (2017) conduct a study in South Africa to examine the effect of eLearning on the performance of teaching and learning. The study measures performance using student grades. A quasi-experimental design with a pre-test-intervention-post-test repeated measure timeline method is adopted. The findings reveal that eLearning has positive effects on the performance of teaching and learning. Bere and McKay (2017) conduct a study in South Africa to assess the impact of specific eLearning technologies on the performance of teaching and learning. The study measures performance using student grades. A quasi-experimental design consisting of eLearning using LMS versus eLearning using instant messaging were conducted. Data was collected using pre-test and post-test surveys. The findings show that although both eLearning interventions improve performance of teaching and learning, eLearning using LMS is more effective. Due to the social presence, interaction capabilities and students' satisfaction of eLearning using instant messaging, individuals who utilise these digital technologies should obtain higher grades. Based on this background the following hypothesis is developed.

*H1. eLearning using instant messaging positively influence teaching and learning performance.*

Traditional face-to-face teaching approaches are the most commonly used instructional method predominantly in developing countries (Bere and McKay, 2017). Techniques such as small group work contribute to the popularity of traditional face-to-face teaching. This is due to numerous benefits including capacity to empower students on how to interact, provision of opportunities to develop

productive dispositions and intellectual autonomy, and ability to facilitate interpersonal skills development and appreciation for engaging in democratic processes (Jansen, 2012). Contrarily, traditional face-to-face has numerous challenges including restrictions to learning constrained by space and time, students' attention diminishes quickly during lectures, costly, and use of large amounts of paper which has implications on the environment (Bere and McKay, 2017). As a result of these challenges eLearning is replacing traditional teaching methods in higher education. This is due to the promises eLearning offers including ability to support anywhere and anytime learning, provision of authentic collaborative learning facilitated by effective social presence, quick provision of feedback, cost effective, and environment friendly (So, 2016; Sun et al., 2018). This leads to the development of understandings that eLearning is an effective alternative to traditional face-to-face teaching and learning. Based on this background the following hypothesis is developed.

*H2. eLearning using instant messaging has better teaching and learning performance than face-to-face teaching and learning.*

## 4 Research Design and Methodology

This paper aims to investigate the impact of eLearning using instant messaging on the performance of teaching and learning in higher education in developing countries. Two research hypotheses have been developed as above. To effectively test the hypothesis, linear regression and ANOVA tests are conducted on the data collected through the use of control groups in a higher education institution in South Africa.

To adequately answer the research question, a pre-test and post-test control group experimental design is adopted in the study. The study follows several specific steps including face-to-face lecture, pre-test and post-test control experiments in a form of eLearning tutorials versus traditional face-to-face based group tutorials. These steps are elaborated on Figure 1.

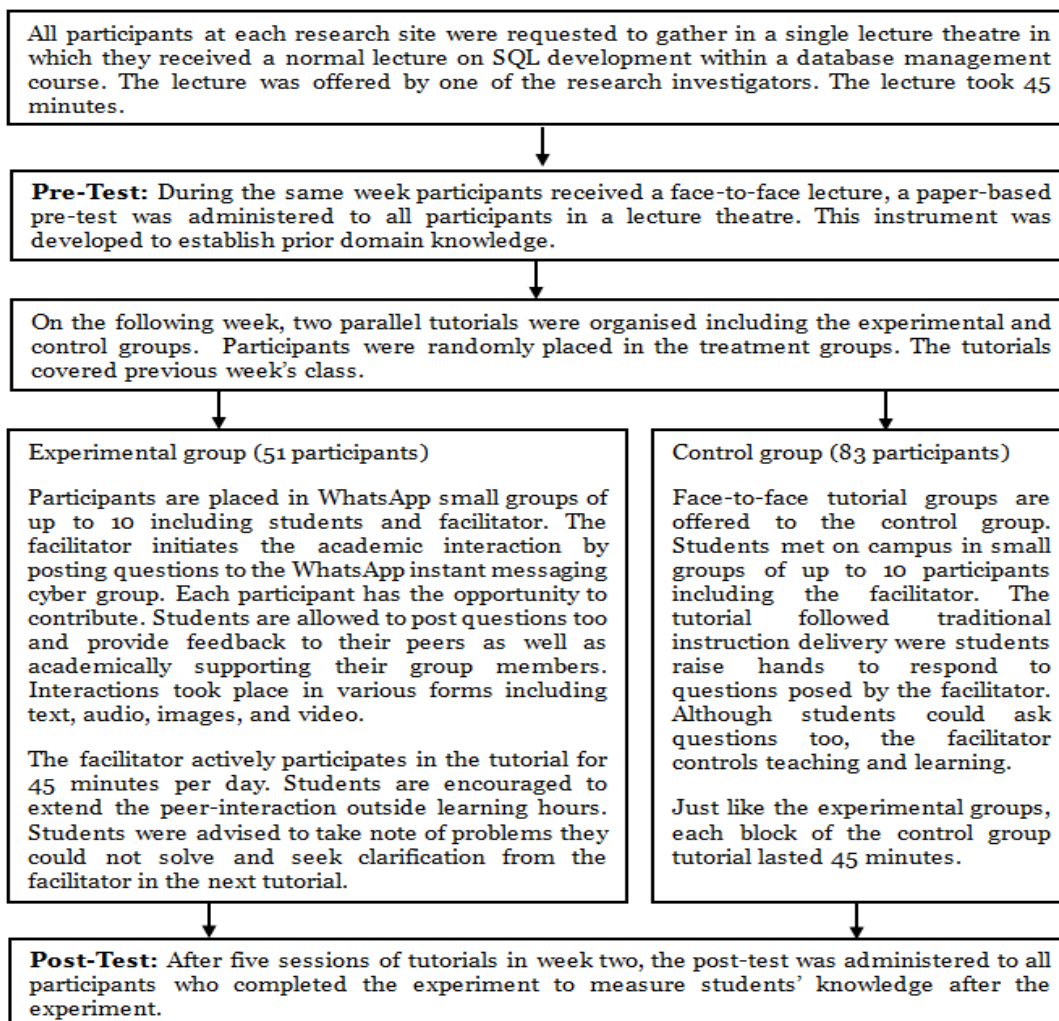

*Figure 1: Research steps*

The data collection survey instruments for the study consist of pre-test and post-test. These instruments are developed based on Gagné (1985) learned capabilities including intellectual skills, cognitive strategy, and verbal information. In order to develop valid and reliable instruments, an instructional matrix developed by Gagné (1985) is engaged. The instructional matrix is directly used to guide the development of a pre-test which tests nine learning domains associated with the acquisition of database SQL query concepts. The database SQL query learning domains are listed vertically on the left-hand side of the instructional matrix (the y-axis), while the five instructional objectives are listed horizontally (the x-axis) from band-A to band-E. The level of instructional objectives complexity increased from band-A to band-E. The nine listed learning domains include database terms, database operations, database types, components of SELECT clause, FROM clause, conditional filtering, logic operations, aggregate functions, and developing queries.

**Pre-Test:** This instrument establishes prior domain knowledge, hence a paper based pre-test is completed based on participants' knowledge gained during their normal lectures. This implies that, a pre-test is conducted before accessing treatments. To avoid pressure and stress, the pre-test items are ordered from easiest to the most difficult.

The pre-test instrument consists of 38 test-items. It has 18 dichotomous and 20 partial credit test-items. Dichotomous refers to a scoring technique that utilises either a '0' or '1'. A test-item is scored '0' if the answer is either incorrect or blank (left unanswered), while a score of '1' is allocated when a correct answer has been given. Therefore, the dichotomous scoring system is applied for test-items that require clear and easy understanding questions. Partial credit scoring technique is used for complex questions that required an ordered sequence of steps to be followed to get to a solution and could not be answered by a distinct response. These item-tests cannot be scored by assigning either a '0' or '1' because partially correct responses can be obtained.

**Post-Test:** Just like the pre-test, the post-test instrument consists of 38 test-items. It has 18 dichotomous and 20 partial credit test-item scores. The post-test instrument is developed based on the instruction matrix principles too. This instrument is designed in such a way that its content is closely related to that of a pre-test. The test-items in the post-test are randomly ordered and the wording for the two instruments is not identical. The rationale behind such differences is to reduce memory effects on post-tests. The researcher carefully rephrased post-test test-items keeping in mind that they should measure the same learning content with the pre-test test-items.

Content validity is established on both survey data collection instruments prior to the experiments. The process involve 16 database experts including 4 database developers, 4 business intelligence specialist, 4 university lecturers in South Africa, and 4 database administrators. These experts are contacted by e-mail and requested to participate in the instrument testing process. Fourteen participants agreed to take part in the study but ten provided content validity feedback of the instruments. Seven questions were amended including two dichotomous and five partial credit test-items in order to improve their readability, clarity and comprehensiveness (Bolarinwa, 2015).

To ensure reliability of the instruments, a pilot study was conducted using 28 undergraduate students enrolled for database management courses at one of the research sites. Students who participated in the pilot study were not considered in the main experiment. The purpose of this instrument testing process is to calibrate and validate the reliability of the research procedure, using the QUEST Interactive Test Analysis System (Adams & Khoo, 1996). The pilot study pre-test item-fit map presented on figure 2 shows that test-items 9 and 33 over-fits the Rasch model. such test-items should be eliminated (Adams and Khoo, 1996). Further test were conducted to ascertain their invalidity.

The test-items discrimination was observed. Wu and Adams (2007) recommend a test-item discrimination should be at least 0.2. Test-items 9 and 33 obtained a discrimination value of 0.66 each. Therefore, the test-items are discriminating well between "able" and "not able" participants. In relation to this pilot study, the test-items 9 and 33 provide very high discrimination effect on the measurement of database knowledge acquisition when it is correlated with the overall score of the test. A conclusion is made that Test-items 9 and 33 are important abilities which should be tested novice database SQL developers, hence such test-items should not be deleted from the instrument. Therefore, a decision was made not to remove them.



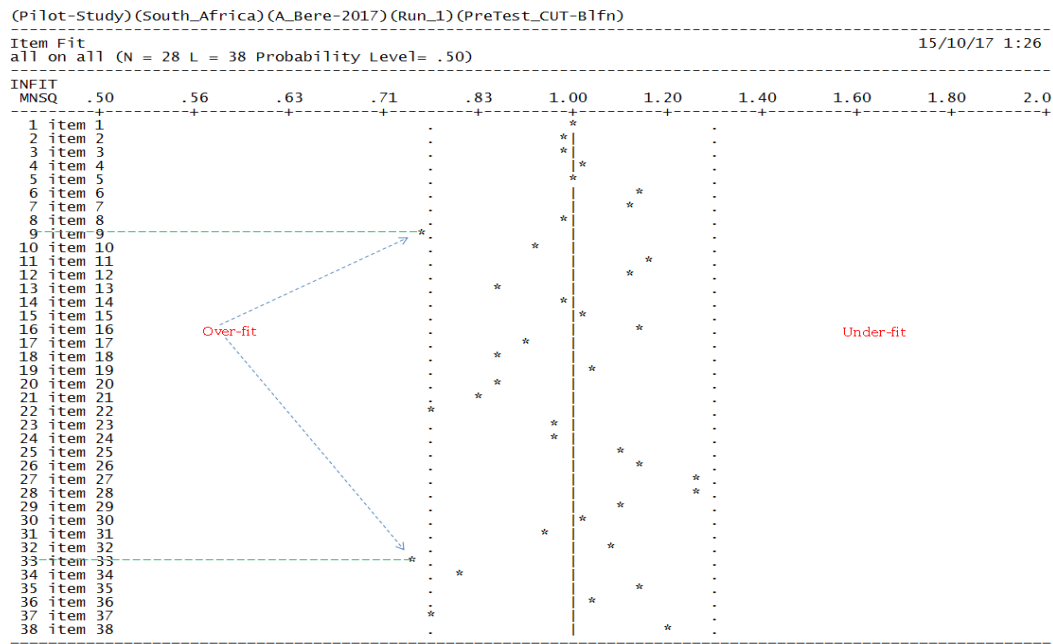

Figure 2: pilot study pre-test item-fit

Although test-item 9 and 33 of the pilot study pre-test did not fit the Rasch model, the instrument displays sufficient internal consistency. According to Wu and Adams (2007) the recommended internal consistency should be at least 0.70. The pre-test's internal consistency is 0.82 which surpasses the recommended threshold. Such results show that the survey instrument is reliable.

The paper-based survey was conducted at two South African universities of Technology between March 2017 and May 2017. The target population from both universities is undergraduate IT enrolled in database management introductory course. A total of 141 questionnaires were distributed. Seven were discarded due to missing responses. Females are the majority consisting of 59% of the participants' population (134 participants).

Participants' ages are categorised in four groups. The 22-25 years age group is the most popular with 88 participants while the 30 years and above category is the least popular with 10 participants. The 18-21 years and 16-29 years' participants are 22 and 14 respectively.

## 5 Data Analysis

The study experiment consists of control group N=83 and experiment group N= 51 participants. To minimise bias, participants are randomly selected into the study groups. Control group involves small group face-to-face interactions. Control group mean and standard deviation are 10.20 and 6.758 respectively while experiment group obtains higher values of mean = 18.65 and standard deviation = 8.079. A higher mean suggests that experiment group performed better than control group. A higher standard deviation shows that experiment group data is largely dispersed compared to control group data. Table 1 below presents the mean and standard deviations of the study.

Treatment	N	Mean	Std. Deviation
Control group	83	10.20	6.758
Instant messaging	51	18.65	8.079
Total	134	13.42	8.344

Table 1. Mean and standard deviation

A linear regression was conducted to depict the teaching and learning performance impacts of the eLearning initiative using instant messaging. Experimental group results ( $b = 8.44$ ,  $s.e = 1.30$ ,  $p < .00$ ) shows that eLearning using instant messaging predict better performance in teaching and learning. Correspondingly, the control group results ( $b = 10.21$ ,  $s.e = .80$ ,  $p < .00$ ) reveals that traditional teaching methods predict better performance in teaching and learning. eLearning using instant

messaging account for 24.3% of the performance in teaching and learning ( $R^2 = .243$ ) which shows that the model relatively fits the data. Table 2 below presents results of the study linear regression.

Variables	Step 1				
	b	s.e	$\beta$	p	t
Constant (control group)	10.21	.80		.00	12.76
Instant messaging	8.44	1.30	.49	.00	6.51
$R^2$	24.3***				
$\Delta R^2$	24.3***				

Table 2. Linear regression results

The second hypothesis postulates that eLearning using instant messaging has better teaching and learning performance than face-to-face teaching and learning. ANOVA was employed to examine this hypothesis. The ANOVA results show hypothesis 2 of this study is significant ( $F = 42.400$ ,  $p < .000$ ). This finding means that eLearning using instant messaging is more effective than traditional teaching and learning methods. Table 3 presents ANOVA test results of the study.

Model	Sum of Squares	df	Mean Square	F	Sig.
Regression	2251.432	1	2251.432	42.400	.000b
Residual	7009.165	132	53.100		
Total	9260.597	133			

Table 3. ANOVA test results

## 6 Discussion

This section presents a summary of the main findings of this study. These findings are organised with respect to the two hypotheses developed above. The first hypothesis postulates that eLearning using instant messaging positively influences teaching and learning performance. As indicated on Table 2, this is supported which suggests that eLearning using instant messaging can positively influence the teaching and learning performance. This finding is consistent with that of So (2016) who reveals that instant messaging mediated eLearning systems could improve students' performance. Such improvement in teaching and learning could be caused by sharing knowledge and learning resources outside school hours (So, 2016). This shows the significance of various instant messaging characteristics including ability to form of cohorts for teaching and learning, interaction at no cost, and ubiquitous learning (Rambe and Bere, 2013).

The second hypothesis assumes that eLearning using instant messaging has better teaching and learning performance than traditional teaching and learning methods. The findings of the study reveal that this hypothesis is significant ( $F = 42.400$ ,  $p < .000$ ). This finding is consistent with the research in eLearning using instant messaging (Rambe and Bere, 2013; Robinson et al., 2015; So, 2016). Robinson et al. (2015), for example, reveal that various instant messaging technology characteristics influence better performance in teaching and learning than other instructional methods. These characteristics include the promptness of the immediate arrival of new messages, the easiness of uploading and downloading different formats of messages, the availability of user-friendly interfaces, the ability to arrange messages in a chronological order to facilitate the finding of the original thread, and the capacity to form groups without the intervention of the third party. Furthermore, the capacity of instant messaging to support teaching and learning anywhere and anytime makes it better than traditional face-to-face instructional methods (Rambe and Bere, 2013). This suggests the importance of the technology affordances of instant messaging on improving the performance of teaching and learning.

The findings of this study corroborates Rambe and Bere (2013)'s views that eLearning using instant messaging offer more effective collaborative learning settings resulting in better teaching and learning performance impacts. Rambe and Bere (2013) encourage South African higher education educators and students to adopt instant messaging for supporting teaching and learning activities.

The contributions of this study are twofold. Firstly, the study provides a better understanding of the performance of teaching and learning using instant messaging. Secondly, this study provides insights that eLearning using instant messaging is more effective than traditional face-to-face teaching and learning methods with respect to performance in teaching and learning. The research findings in this

study have practical implications for higher educational institutions particularly in developing countries in their decision to transform teaching and learning through better adoption of eLearning.

## 7 Conclusion

The study examines the effectiveness of eLearning using instant messaging in higher education. Findings reveal that both face-to-face and eLearning using instant messaging enhance teaching and learning. The study shows that eLearning using instant messaging is more effective than face-to-face teaching and learning.

The major limitation of the study is that the sample is selected from a single department of two universities in South Africa. To generalise the findings, the sample should be extended. Future study can be conducted to investigate the factors causing performance in teaching and learning using instant messaging.

## 8 References

- Adams, R. and Khoo, S. 1996. *Quest Version 2.1: The Interactive Test Analysis System*. Camberwell, Victoria, Australia: ACER press
- Awada, G. 2016. Effect of WhatsApp on critique writing proficiency and perceptions toward learning. *Cogent Education* (3:1) pp 1-25.
- Bere, A. and McKay, E. 2017. Investigating the impact of ICT tutorial strategies to promote improved Database knowledge acquisition, *The 28th Australasian Conference on Information Systems*, Hobart, Australia: University of Tasmania.
- Bere, A. and Rambe, P. 2016. An empirical analysis of the determinants of mobile instant messaging appropriation in university learning. *Journal of Computing in Higher Education* (28:2) pp 172-198.
- Bolarinwa, O. A. 2015. Principles and methods of validity and reliability testing of questionnaires used in social and health science researches. *Nigerian Postgraduate Medical Journal* ( 22:4) pp 195-201.
- Fewkes, A. M. and McCabe, M. 2012. Facebook: Learning tool or distraction? *Journal of Digital Learning in Teacher Education* (28:3) pp92-98.
- Gagné, R. 1985. *The Conditions of Learning and Theory of Instruction*. New York, NY: Holt, Rinehart and Winston.
- Jansen, A. 2012. Developing Productive Dispositions during Small-Group Work in Two Sixth-Grade Mathematics Classrooms: Teachers' Facilitation Efforts and Students' Self-reported Benefits. *Middle Grades Research Journal* (7:1) pp 37-56.
- Jesus, R. A. F. and Moreira, F. J. L. (2009) *E-Learning and Solidarity: The Power of Forums, Handbook of Research on Social Dimensions of Semantic Technologies and Web Services*: IGI Global:448-467.
- Koole, M. L. 2009. A model for framing mobile learning. *Mobile learning: Transforming the delivery of education and training* (1:2) pp 25-47.
- Lee, B.-C., Yoon, J.-O. and Lee, I. 2009. Learners' acceptance of e-learning in South Korea: Theories and results. *Computers & Education* (53:4) pp 1320-1329.
- Murire, O. T. and Cilliers, L. 2017. Social media adoption among lecturers at a traditional university in Eastern Cape Province of South Africa. *South African Journal of Information Management* (19:1) pp 1-6.
- Park, S., Cho, K. and Lee, B. G. 2014. What makes smartphone users satisfied with the mobile instant messenger?: Social presence, flow, and self-disclosure. *International Journal of Multimedia and Ubiquitous Engineering* (9:11) pp 315-324.
- Rambe, P. and Bere, A. 2013. Using mobile instant messaging to leverage learner participation and transform pedagogy at a South African University of Technology. *British Journal of Educational Technology* (44:4) pp 544-561.

- Robinson, L., Behi, O., Corcoran, A., Cowley, V., Cullinane, J., Martin, I. and Tomkinson, D. 2015. Evaluation of Whatsapp for promoting social presence in a first year undergraduate radiography problem-based learning group. *Journal of Medical Imaging and Radiation Sciences* (46:3) pp 280-286.
- Rudman, E. M. P. 2017. Biomechanics for first year occupational therapy students: enriching learning using an E-learning resource. *South African Journal of Occupational Therapy* (47:1) pp 36-40.
- Sek, Y. W., Deng, H., McKay, E. and Qian, M. 2016. Exploring the impact of learning styles on the acceptance of open learner models in collaborative learning. *International Journal of Systems and Service-Oriented Engineering (IJSSOE)* (6:3) pp1-15.
- Sek, Y. W., Deng, H., McKay, E. and Xu, W. Investigating the determinants of information sharing intentions of learners in collaborative learning. *International Conference on Web-Based Learning: Springer*, 87-97.
- So, S. 2016. Mobile instant messaging support for teaching and learning in higher education. *The Internet and Higher Education* (31:2016) pp 32-42.
- Sun, Y., Liu, D., Chen, S., Wu, X., Shen, X.-L. and Zhang, X. 2017. Understanding users' switching behavior of mobile instant messaging applications: An empirical study from the perspective of push-pull-mooring framework. *Computers in Human Behavior* (75:2017) pp 727-738.
- Sun, Z., Lin, C. H., Wu, M., Zhou, J. and Luo, L. 2018. A tale of two communication tools: Discussion forum and mobile instant messaging apps in collaborative learning. *British Journal of Educational Technology* (49:2) pp 248-261.
- Vasileva-Stojanovska, T., Malinovski, T., Vasileva, M., Jovevski, D. and Trajkovik, V. 2015. Impact of satisfaction, personality and learning style on educational outcomes in a blended learning environment. *Learning and Individual Differences* (38:2015) pp 127-135.
- Venkatesh, V., Morris, M. G., Davis, G. B. and Davis, F. D. 2003. User acceptance of information technology: Toward a unified view. *MIS quarterly* (27:3) pp 425-478.
- Wang, Q., Woo, H. L. and Quek, C. L. 2012. Exploring the affordances of Facebook for teaching and learning. *International Review of Contemporary Learning Research* (1:1) pp 23-31.
- Warne, R. T., Nagaishi, C., Slade, M. K., Hermesmeier, P. and Peck, E. K. 2014. Comparing weighted and unweighted grade point averages in predicting college success of diverse and low-income college students. *NASSP Bulletin* (98:4) pp 261-279.
- Wu, M. and Adams, R. 2007. *Applying the Rasch model to psycho-social measurement: A practical approach*. Educational Measurement Solutions Melbourne.

# **Names and Faces: a staff dashboard to support student learning engagement**

## **Vince Bruno**

School of Business IT and Logistics  
RMIT University  
Melbourne, Victoria  
Email: vince.bruno@rmit.edu.au

## **Joan Richardson**

School of Business IT and Logistics  
RMIT University  
Melbourne, Victoria  
Email: joan.richardson@rmit.edu.au

## **Jim McGovern**

School of Business IT and Logistics  
RMIT University  
Melbourne, Victoria  
Email: jim.mcgovern@rmit.edu.au

## **Abstract**

This paper describes the in-progress development and preliminary evaluation of a dashboard to support student-centred higher education. The dashboard, known as Names and Faces, aims to provide easy access to the data teaching staff need to proactively foster student engagement, and to improve the student's overall university experience. Names and Faces brings together data from disparate systems, and provides a highly visual interface that meets the needs of a wide range of teaching staff. Importantly, the prototype has been developed by academic staff in collaboration with other academics using an iterative prototyping approach. 48 academic staff have used the prototype over two semesters, identifying new data sources and interfaces to be incorporated in future iterations. This project contributes to the development of improved information support for student-centred education, but also to academic information systems in terms of data integration, usability, and user-centred design.

**Keywords** student engagement, staff dashboards, data integration, HCI, iterative prototyping.

## 1 Introduction

Many higher education teaching staff are interested in a more student-centred approach to learning and teaching, but often do not have the time or the tools to assemble the information needed to support this approach. If data is available, it often requires access to several systems and is presented inflexibly, in different formats. Names and Faces addresses this problem in two ways, first, by providing an integrated view of student data and their university activity, and second, by providing a highly visual interface, useable by a wide range of staff. Names and Faces also addresses a third objective, to achieve wider acceptance by involving teaching staff in an iterative, collaborative development process.

The basis of Names and Faces is to know relevant information about students and their educational experience, and to use this information to proactively foster engagement with their classes and to improve their overall educational experience. Names and Faces takes a teacher's perspective on information, literally building a picture of the students from information often stored in disparate system, including their student card photographs, demographic data, academic history, current program and timetabling, together with progressive engagement indicators, and institutional learning analytics predictions.

One of the key issues addressed in the development of Names and Faces is buy-in from teaching staff. Although staff report high levels of interest in data-based approaches to learning support, they indicate low involvement in decision making, and little discussion about this data with colleagues and other subject matter experts (West et al., 2016). Australian higher education staff seem to be relatively infrequent users of student data. For example, only 58 of 319 teaching staff, and 37 of 304 programme and course coordinators reported accessing analytics data more often than monthly (Huijser, West & Heath, 2016). Past and possibly current data-based approaches may not answer the questions that teaching staff have (Svinicki et al., 2016), and more involvement of staff in the development of such tools may lead to better tools and higher uptake.

The Names and Faces prototype has been developed to meet the broad objectives of:

- i. providing an integrated, more holistic view of the student and their educational experience,
- ii. supporting proactive engagement with students by providing a personal view of students that includes their photos, preferred name and pronunciation, and supports functionality, such as to remember birthdays,
- iii. detecting potential difficulties, specific to individual students, which may detract from their university experience, such as timetable clashes, timetable spread, their overall load, uneven assignment workloads, planned absences,
- iv. providing tools for teaching staff, such as to help them know and recognise their students, and
- v. encouraging staff use by involving them closely in development.

In the remainder of the paper, section 2 provides the background in student engagement that underpins the educational focus of Names and Faces. Section 3 describes the data sources and section 4 the visual interface of the prototype. Section 5 describes the implementation, while section 6 briefly examines the prototype deployment, feedback and future development plans.

## 2 Improving student engagement and their learning experience

Names and Faces aims to improve student-staff interaction as an important part of student engagement (Richardson, 2011). Positive, welcoming and personal communication experiences can motivate students and increase their sense of belonging, resulting in greater participation in the learning process, further interaction, higher learning achievement, and increased overall satisfaction (Kim & Sax, 2009; Kuh et al., 2006; Masika & Jones, 2016; O'Keefe, 2017; Shepherd & Sheu, 2014; Zepke & Leach, 2010). In dealing with students that have been identified as at risk, short, informative discussions between teaching staff and students are likely to be as effective as more elaborate, less personal, and costlier, institutional interventions (Jayaprakash et al., 2014).

There is considerable capacity to improve staff-student interaction in Australian higher education. Australian students may have up to 50% less staff and student interaction compared to US students (Richardson, 2011). This may stem from the widespread use of large lecture classes with casual staffing

of tutorials in Australia, where students often have little contact with senior, full-time staff (Coates & Ransom, 2011).

Names and Faces implements what some teachers do manually, create a chart of student photographs, names and relevant information. The prototype facilitates a more personal environment through data, such as preferred names and pronunciations. Names and Faces also draws on information about student enrolments, assignments, and formal off-campus activity to allocate work more evenly and accommodate potential conflicts.

One of the substantial issues for this project (and other data driven projects) are the ethical and legal issues around use of student data. The obligation of institutions to act must be balanced against the rights of the student to privacy (Ifenthaler & Schumacher, 2015; Slade & Prinsloo, 2013). In Australia, universities and their use of student data is governed by state legislation, for example in Victoria, The Privacy and Data Protection Act of 2014 (CPDP, 2014). Compliance with the relevant legislation is typically covered by University policies and processes. Generally, student personal data can be used with appropriate safeguards if its purpose is to improve the student learning experience and outcomes. In fact, it has been identified that there is a moral obligation to use such data to do so (Slade & Prinsloo, 2013). Implied access is provided by the ability of staff to access various systems, and the approach taken in the current implementation of Names and Faces is to use data normally available to teaching staff. Ethical and privacy issues, and mechanisms to deal with these will be an ongoing consideration for the project.

### 3 Data Integration

Universities hold large amounts of data, but much of this is siloed in systems implemented on different platforms with weak linkages and a range of interfaces. Some of this data may be outside university systems and accessible only by staff users, for example social media, websites, mobile and cloud-based applications (West et al., 2016). Table 1 outlines the data sources used in the current prototype and some of the challenges in accessing this data.

<b>Data</b>	<b>Location</b>	<b>Access</b>
Student photographs (as they appear on the student card)	Student Academic Management System (SAMS)	The photos can be obtained via the browser on an individual student level, or using the query tool on a course/class level. This data can be exported using an XML, Excel or HTML format.
Student enrolments, current class registrations and previous results	Academic student enrolments (iExplore)	The data is accessible from a web browser and limited spreadsheet export at a student, course or program level is possible.
Student Timetables	MyTimetable: students register for their classes (such as Lecture, Laboratory, Workshop, Tutorial)	This data can be exported from the application as a spreadsheet, text or HTML format.
Assessment details	The Learning Management System (Canvas) provides access to assessment and other details for a course	This data can be accessed using the application API (in JSON format) for courses taught by that staff member, or provided by the LMS project team.
Final exam schedule	Prepared by student administration group	This is sent to academic staff in a spreadsheet via email.
Class/Room locations map	The campus maps (Meridian) provides maps for many of the university buildings	Stored off campus on a cloud service. Access is through an API that provides the data in JSON format.
Other administrative data.	Various sources about an individual student, course and/or program.	Predominantly transmitted via email.

Table 1. Important Student Data Sources and Access

## 4 Functional Visualisation

Names and Faces interface includes the following functionally orientated visualisation of the data.

- i. The Student View provides basic information about a student, including their photo, and the following data related to the student is currently available for display.
  - a. the student's timetable for the current semester,
  - b. basic program map (visual), filled with enrolment and/or timetabled data,
  - c. an assessment summary map for each course timetabled for across the semester,
  - d. the assessment details for each course timetabled for the given semester, and
  - e. the list of exams the student will need to attend for the given semester.
- ii. The Class List provides a visual list of student in a class, using student card photos. This view can be based on enrolment course data or timetabled class attendance data. This list also includes:
  - a. the assessment details of the class, and
  - b. a list of students and courses where there is a timetable clash with this course.
- iii. Program List provides a visual list (photos) of all currently enrolled student in a program.
- iv. The Names and Faces Game helps staff to learn the names of student. The game presents the staff member with a photo of a student in their class with 6 potential student names. The staff member attempts to match the student name with that in the photo. A report can be seen that provides a count of the number of right and wrong attempts made for each student.
- v. Class Location provides a grid view of the timetabled courses for a given class location at the university across a week. This view also includes a map of the floor in the given building of the location.

## 5 Implementation

The conceptual design is based on a simple three-level architecture (Leitner & Ebner, 2017) of data capture, processing and presentation, which allows flexibility for implementation in a range of technical environments. The data capture layer brings together data from disparate systems, unifying the different data models. Ideally, institutions will have a data integration solution in place, but in the absence of such a solution, connectors can be included in the data capture layer. Data from the disparate sources are stored in a relational database.

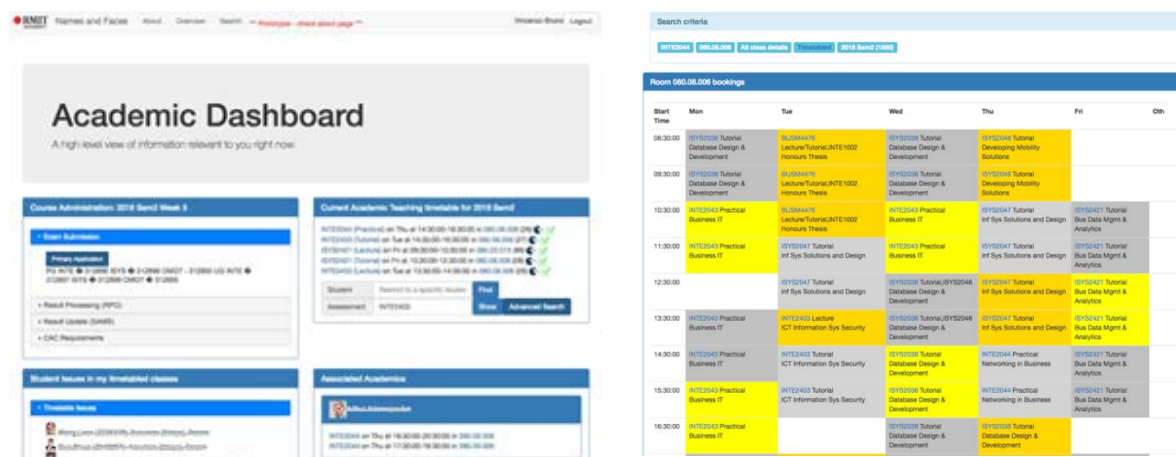

Figure 1: Main dashboard display (left) and Weekly Location View (right)

The academic dashboard prototype is currently housed in a server that is only accessible through the University intranet. Users must authenticate using the university authentication system and only academic staff can access the data for their course/class.

A web application has been developed that can be accessed through browsers on desktop and mobile devices. The visualisation is based on a "bootstrap" web graphical toolkit, which provides a common look and feel and enables the various displays to adapt to a variety of screen sizes. Figure 1 shows the



2018, UTS, Sydney

*Names and Faces*

main dashboard display that includes administrative tasks sensitive to the current week in the semester, information about the courses allocated to the academic currently logged in and a list of academic involved in the same courses. Data about student with special consideration, equitable assessment plans and timetable issues/clashes are shown in relation to academic's involved courses. This figure also shows an example weekly location (room) view of courses timetabled and academic involved.

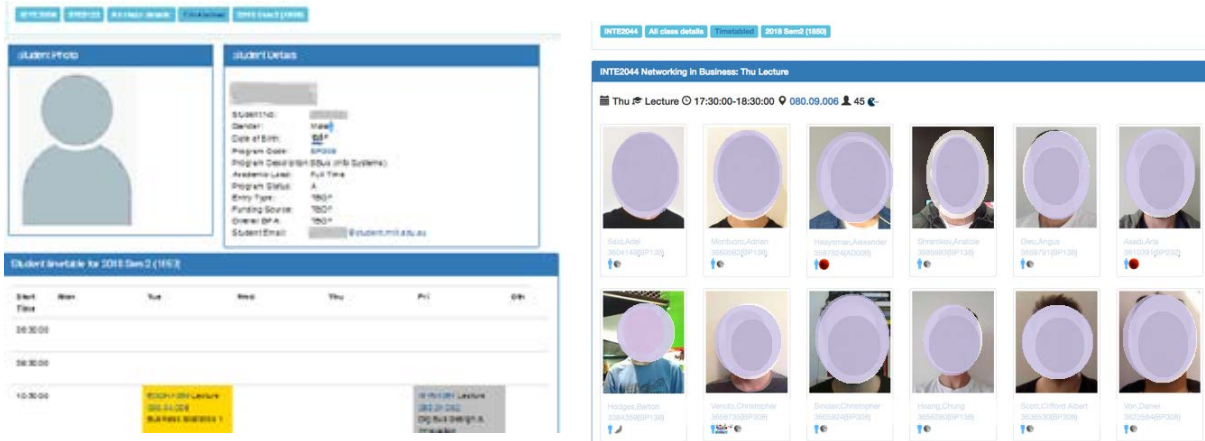

Figure 2: Snippet of the Individual Student View (Left) and Class List (Right)

The Student View (shown in Figure 2) combines data about the student (minimal), student's timetable for current semester, student's basic program plan, all assessment and exam details for enrolled courses. Figure 2 also shows a Class List View that displays the names and faces of students in each timetabled class for a course. This view can be flipped to enrolled students rather than timetabled, for courses that do not have timetabled rooms.

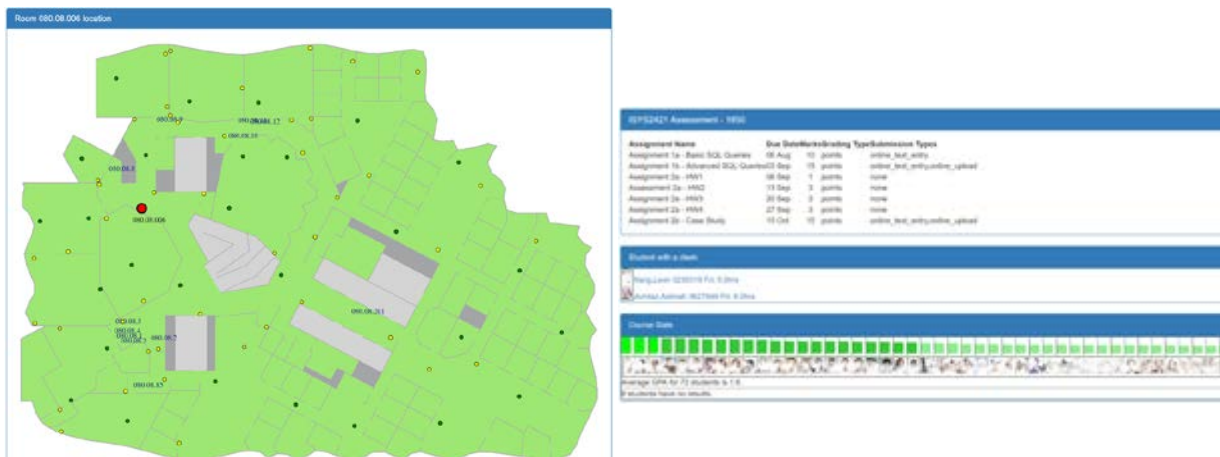

Figure 3: Room location map (Left) and Additional Class List Details (Right)

The prototype includes data from the university room location maps (Figure 3) found on the weekly location view. The additional class list details (Figure 3) includes assessment pieces, students with timetable clashes with this class and a GPA summary of enrolled students.

## Preliminary evaluation and future development

The first phase of this project has focused on iterative design and development with the aim of establishing a reasonably stable dashboard. A second phase will follow to more formally evaluate the impact of the dashboard on measurable outcomes, such as satisfaction, retention and grades, for students, and usefulness and time saving for teaching staff.

The initial prototype has been developed with the involvement of academic staff from one Australian university over a 5-month period, spanning two semesters. An encouraging sign has been the increasing number of staff involved over time. Staff have accessed the web application using Windows desktop, Macintosh desktop and mobile devices, providing feedback in face to face discussions and email. Staff have identified bugs and improvements to the visual interface, as well as suggesting new functionality, such as the names and faces game.

Of the 48 academic staff members who have accessed the web application,

- all have used the (visual) class list,
- 32 have accessed individual student details,
- 23 have examined their class location, and
- 8 have used the names and faces game.

Names and Faces has been successful in motivating academic staff to collaborate in the development of a tool that helps with their work. Development iterations have led to the incorporation of more valuable data sources as they are identified, such as that from university learning analytics initiatives. Additional reports that can improve the student experience are being assessed.

## 6 Conclusion

Names and Faces aims to provide the type of student information systems that teaching staff need. The student is central to Names and Faces, and the primary interface is based on their image and their name. Academics can now obtain data from a single source of truth where the student lifecycle and experience is the single point around which data is presented. This data can make it easier to engage with the students in formal and less formal educational settings. It also aids staff in improving the student experience by providing the full context of the student's university activity, and by highlighting potential conflicts and difficulties before they arise. This data can be linked to other data as it becomes available, such as patterns of learning behaviour established by institutional predictive learning analytics. Together with their own knowledge of students, Names and Faces provide a powerful tool for teaching staff, one that can inform them, but most importantly allow them to influence positive student academic outcomes.

## References

- Coates, Hamish & Laurie Ransom, 2011, "Dropout DNA, and the genetics of effective support", Research Briefing, Australian Survey of Student Engagement (AUSSE), Vol 11, June.
- CPDP, 2014, Privacy Legislation in Victoria, [https://www.cdpd.vic.gov.au/images/content/pdf/CPDP\\_Information\\_Sheet\\_-\\_Privacy\\_Legislation\\_in\\_Victoria.pdf](https://www.cdpd.vic.gov.au/images/content/pdf/CPDP_Information_Sheet_-_Privacy_Legislation_in_Victoria.pdf) (accessed, 24/10/2017).
- Huijser, Henk; Deborah West & David Heath, 2016, "The Potential of Learning Analytics to Systematically Address Diverse Learning Needs and Improve Student Retention in Australian Higher Education", Advances in the Scholarship of Teaching and Learning, SIM University
- Ifenthaler, Dirk & Clara Schumacher, 2015, "Divulging Personal Information within Learning Analytics Systems", 12th International Conference on Cognition and Exploratory Learning in Digital Age (CELDA), pps 11-18, 24-26 October 2015, Dublin, Ireland.
- Jayaprakash, Sandeep M., Erik W. Moody, Eitel J. M Lauria, Jame R. Regan & Joshua D. Baron, 2014, "Early Alert of Academically At-Risk Students: An Open Source Analytics Initiative, *Journal of Learning Analytics*, 1(1), 6-47.

- Kim, Young K. & Linda J. Sax, 2009, "Student-Faculty Interaction in Research Universities: Differences by Student Gender, Race, Social Class, and First-Generation Status", *Research in Higher Education*, 50:437-459, Springer.
- Kuh, George D., Jillian Kinzie, Jennifer A. Buckley, Brian K. Bridges & John C Hayek, 2006, "What Matters to Student Success: A Review of the Literature", Commissioned Report for the National Symposium on Postsecondary Student Success: Spearheading a Dialog on Student Success, National Postsecondary Education Cooperative, July.
- Leitner, Philipp & Martin Ebner, 2017, "Development of a dashboard for Learning Analytics in Higher Education", in Zaphiris, P. & A. Ioannou (eds), *Learning and Collaboration Technologies, Technology in Education, LCT 2017, Lecture Notes in Computer Science*, vol 10296, pp. 293-301, Springer.
- Masika, Rachel & Jennie Jones, 2016, "Building students belonging and engagement: insights into higher education students' experience of participating and learning together", *Teaching in Higher Education*, Volume 21, Issue 2.
- O'Keefe, P., 2013, "A sense of belonging: Improving student retention", *College Student Journal*, vol. 47, no. 4, pp. 605-613.
- Richardson, Sarah, 2011, "Uniting Teachers and Learners: Critical insights into the importance of staff-student interactions in Australian university education", Research Briefing, Australian Survey of Student Engagement (AUSSE), Vol 12, September.
- Shepherd, Morgan M. & Tsong Shin Sheu, 2014, "The Effects of Informal Faculty-Student Interactions and Use of Information Technology on Non-Traditional Students' Persistence Intentions and Educational Outcomes", *Journal of Higher Education Theory and Practice*, vol. 14(2).
- Slade, Sharon & Paul Prinsloo, 2013, "Learning Analytics: Ethical Issues and Dilemmas", *American Behavioural Scientist*, Vol 57, Issue 10.
- Svinicki, Marilla D., Kyle Williams, Kadie Buckley, Anke J. Z. Sanders, Lisa Pine & Julie Stewart, 2016, "Factors Associated with Faculty Use of Student Data for Instructional Improvement", *International Journal-Society of Teaching and Learning*, Vol. 10, No. 2, Art. 5.
- West, Deborah; Henk Huijser, David Heath, Alf Lizzio, Danny Toohey, Carol Miles, Bill Searle & Jurg Bronnimann, 2016, "Higher education students' experiences with learning analytics in relation to student retention", *Australian Journal of Educational Technology*, 32(5).
- Zepke, Nick & Linda Leach, 2010, "Improving Student Engagement: Ten proposals for action", *Active Learning in Higher Education*, 11(3) 167-177.

## Acknowledgements

The authors would like to acknowledge the assistance of the College of Business, RMIT University in providing funding, and the assistance of the many staff in the College who provided valuable feedback on the prototype.

## Copyright

**Copyright:** © 2018 Vince Bruno, Joan Richardson and Jim McGovern. This is an open-access article distributed under the terms of the [Creative Commons Attribution-NonCommercial 3.0 Australia License](https://creativecommons.org/licenses/by-nc/3.0/au/), which permits non-commercial use, distribution, and reproduction in any medium, provided the original author and ACIS are credited.

# Organisational Learning with SaaS CRM – A case study of Higher Education

## Taiwo Oseni

Centre for Informatics and Applied Optimization  
Federation University Australia  
Ballarat, Australia  
Email: [t.oseni@federation.edu.au](mailto:t.oseni@federation.edu.au)

## Mehmood Chadhar

Centre for Informatics and Applied Optimization  
Federation University Australia  
Ballarat, Australia  
Email: [m.chadhar@federation.edu.au](mailto:m.chadhar@federation.edu.au)

## Sasha Ivkovic

Centre for Informatics and Applied Optimization  
Federation University Australia  
Ballarat, Australia  
Email: [s.ivkovic@federation.edu.au](mailto:s.ivkovic@federation.edu.au)

## Sally Firmin

Centre for Informatics and Applied Optimization  
Federation University Australia  
Ballarat, Australia  
Email: [s.firmin@federation.edu.au](mailto:s.firmin@federation.edu.au)

## Abstract

Customer Relationship Management (CRM) generally has a reputation as a technology that does not live up to its over-inflated expectations. Yet, implementations in higher education remain on the rise. Higher Education institutions (HEIs) are embracing cloud-based CRM systems to upsurge performance, encourage better management practices, and enhance their relationship with staff and students. CRM success however relies heavily on an adaptive organisational learning (OL) process upon which proactive decisions can be made. This paper emphasises that committed learning in post-implementation use is paramount to attaining further understanding of the capabilities, features and functionality of the CRM. Investigating how SaaS CRM usage reflect an organisation's learning in a Higher Education context, the paper presents theoretical and practical contributions in a framework for effective SaaS CRM utilisation, and recommends a continuous cycle of exploration-exploitation-exploration. Yet the reality is that organisations explore, exploit, and then stop exploring.

## Keywords

CRM, SaaS, Organisation Learning, Exploitation - Exploration, Higher Education

## 1.0 Introduction

Organisational learning (OL) is key to organisations' efficient and effective use of new technology. Taking different forms, OL leads to the creation of various types of organisational capabilities, some leading to improvements of existing organisational routines, and others culminate in the development of entirely new routines (Linda & Manpreet, 2017). Not surprisingly, the 2017 Gartner's Hype Cycle reports that cloud-based Information Systems (IS) are now in a phase where focused experimentation and solid hard work by organisations lead to a true understanding of the technology's applicability, risks and benefits (Smith & Anderson, 2017). With digital business increasingly becoming crucial to remaining competitive, the SaaS (Software as a Service) model of cloud-based systems is more and more being adopted by organisations. Offering greater flexibility and agility that enable organisations to concentrate on their core businesses and competencies (Bernsteiner, Kilian, & Ebersberger, 2016). The SaaS market is expanding and gradually having significant impact on different industry sectors, including Higher Education sector. Higher Education institutions (HEIs) are especially beginning to embrace cloud-based Customer Relationship Management (CRM) systems to upsurge performance, encourage better management practices, and enhance their relationship with staff as well as existing and prospective students (Amuna, Shobaki, Naser, & Badwan, 2017). The SaaS model is particularly attractive, being the easiest cloud-based offering since all services are provided and bundled in the delivered software (Buxton, 2015). Faced with technological and economic changes, HEIs such as universities are under increased pressure to enhance value and effectiveness as far as current and potential customers are concerned, and as such find 'easily deployed' SaaS CRM desirable. In HEIs, the concept of students and faculty staff members as "customers" has become a competitive imperative with a profound impact on how colleges and universities attract, retain, and serve customers of all types (Futa, 2004). An educational CRM system aids HEIs to have a full understanding of students' requirements as it collects customer knowledge in all phases of student interaction phases: admission, fee payment, registration, course conclusion, etc. (Abubakar & Mukhtar, 2015). Expectedly, CRM implementations in higher education hit its peak in 2016; yet because CRM generally has a reputation as a technology that does not live up to its over-inflated expectations (Williams, 2017), it remains an important area to be researched. We suggest in this paper that for investments in CRM live up to expectations, organisations must consider their approach to learning. Our recommendation is aligned with previous research findings about the contribution of organisational learning in organisations' justifications for investment in similar enterprise systems (Chadhar & Farhad, 2017; Janson, Cecez-Kecmanovic, & Zupančič (2007). According to Peltier, Zahay, and Lehmann (2013), CRM success relies heavily on having an adaptive organisational learning process upon which proactive decisions can be made. A learning organisation draws on and integrates strategic and tactical insight across functional areas in an organisation and such learning spans vertical and horizontal organisational units, including organisational culture and cross-functional/intradepartmental learning processes (Chadhar & Farhad, 2017; Janson, Cecez-Kecmanovic, & Zupančič (2007). Organisations must be invested in educating users, discovering, understanding, learning to use, and actually using the capabilities and features included in CRM (Seethamraju, 2015). This draws attention to the relevance of organisational factors such as learning in CRM use as without committed investment in post-implementation use, it becomes difficult to attain further understanding of the capabilities, features and functionality of the CRM.

The purpose of this study is therefore to consider the organisational elements, particularly organisational learning, and its relevance in successful post-implementation use of a SaaS CRM System, with a Higher Education institution as the context of investigation. This objective will be achieved by addressing the question: *How does SaaS CRM usage reflect an organisation's learning?*

The paper presents theoretical and practical contributions in a framework for effective SaaS CRM utilisation, and recommends that a continuous cycle of exploration-exploitation-exploration is necessary.

The rest of the paper is structured to include a review of the SaaS CRM and organisational learning literature in Section 2, followed by a discussion of the research methodology in Section 3. Sections 4 and 5 presents the case study and discussions respectively. In section 6, the paper is concluded, and further research recommended.

## 2.0 Literature Review

### 2.1 SaaS CRM – why organisational learning matters

Other cloud-based models, Platform-as-a-Service (PaaS) and Infrastructure-as-a-Service (IaaS), are frequently hailed as fundamental to cloud computing, SaaS remains a model for technology to drive and deliver innovation in businesses (Buxton, 2015). The only infrastructure needed for SaaS being broadband Internet connectivity, SaaS has proved it is here to stay. The multi-tenancy model of SaaS allows organisations to scale rapidly without incurring additional infrastructure or staffing costs, and service providers can readily support customers in responding to changing market requirements faster than with on-premise software. More importantly, SaaS solutions comply with the demand for digital transformation, and can be provisioned with great speed, often with simply a browser and an Internet connection from a wide range of desktop and mobile devices (Buxton, 2015).

As customers are aware that a SaaS model may simplify the introduction of a new software system, they usually have high expectations concerning the usability of the software, and in many cases expect an easy start (Bauer, 2012). Such expectations are logical given that the software is readily available on the Internet and can immediately be used. This is one of the advantages of SaaS solutions, there are implications regarding how organisations approach the organisational change associated with such adoptions. For instance, such expectations may mean that most organisational staff are not willing to invest extensive effort in reading user manuals or conduct new training. As a new technology, the organisation's approach to learning is important and should emphasise the relevance of engaging in cross-departmental discussion and learning activities that help to adapt to the new SaaS CRM system (Chen, Wu, Chu, Lin, & Chuang, 2017).

Son and Lee (2011) suggest that high organisational learning capacity increases cloud computing adoption, and Malladi and Krishnan (2012) found that a firm's existing strengths in organisational learning, coordination IT capability and process management have a role in enhancing the impact of the technology. These studies highlight organisational learning as an important part of embracing cloud computing services in organisations. For instance, organisational culture, staff skills, and work practices can be expected to change as SaaS solutions are adopted and utilised (El-Gazzar, 2014), pointing to the fact that the manner in which an organisation learns will impact on how effectively the organisation uses the SaaS system. We draw on this in our efforts to understand the role of organisational learning on how a cloud-based system, in this case a SaaS CRM can be utilised to bring about expected benefits.

The introduction of cloud-based enterprise services does alter roles and responsibilities (Bernsteiner et al., 2016). For instance, new roles will emerge, like managers for the different types of services, service architects or staff that are responsible for service orchestration. Such new roles add value to the organisation as they influence the skills of employees who would have to develop an understanding on how these kinds of IS work and what kind of possibilities they offer. Consequently, organisational elements such as structure as well as internal and external processes may be impacted. However, as per authors' knowledge, such impacts of organisational elements, particularly organisational learning, are not investigated and only little work has been done in considering the role of organisational learning in the achievement of expected benefits from such adoptions as SaaS CRM. This research aims to fill this research gap by investigating how *SaaS CRM usage reflect an organisation's learning*.

### 2.2 Organisational Learning Types – Exploitation and Exploration

Many definitions of organisational learning concern the active use of data in guiding organisational behaviour (Edmondson & Moingeon, 1998). In specific relation to IS, Tomblin (2010) argues that organisational learning describes the efficient application of captured and assimilated knowledge to achieve positive influences on organisations' IT infrastructure as well as business experience. One prominent theory of organisational learning is the Exploitation-Exploration learning introduced by March (1991). According to March (1995), in order to improve a firm's performance, learning involves a trade-off between exploitation and exploration, where exploitation organisational learning is described as the refinement and extension of existing competencies and exploration organisational learning as discovery and innovation. In other words, the utilisation, refinement and extension of existing capabilities is considered to be exploitation, whereas the search for alternative capabilities that are able to strengthen future exploitative potential is explorative learning (Yamin & Sinkovics, 2007). Three important characteristics for differentiating between exploitation and exploration learning include the objectives, the type of activities through which learning is accomplished, and the timing of benefits derived (Hunter, 2003). Each characteristic can be identified by indicators. Adapted from (Hunter, 2003), Table 1 summarises the indicators of exploitation and exploration in learning as defined by the theory (March, 1991, 1995; March, Sproull, & Tamuz, 1991).

**Table 1: Distinctions between exploitation and exploration organisational learning**

Characteristics	Exploitation Indicators	Exploration Indicators
Objective	Increase in reliability Accuracy and control over core processes Improvement of short-run efficiency Refinement of existing capabilities/technologies	Development of new knowledge New ways of problem- solving New strategies and technologies
Activities	Activities that emphasise a reduction of variation in organisational processes and activities. Activities are risk-averse in nature	Activities leading to an increase in variation in organisational processes, tasks and functions. Activities involve risk-taking, innovation, research
Outcomes	Certain and immediate	Uncertain and remote

Given the inherent tension between exploitation and exploration, the tendency to explore versus exploit is affected by several factors such as resources, organisational culture, and structure and a focus on how one learning type disrupts the other (Lavie, Stettner, & Tushman, 2010). For instance, organisations that focus on exploitation trade flexibility for stability, while those that focus on exploration may face challenges when attempting exploitation. Specifically for the context of Cloud CRM post-implementation usage, as organisations choose ‘use’ scenarios that emphasise reduced variation in organisational processes as opposed over ones that lead to an increase in variation, they may be favouring exploitation against exploration. Similarly, when ‘use’ scenarios involve innovation in business processes, it may be the case that exploration chosen over exploitation.

### 2.3 Exploitation and Exploration in Cloud CRM post-live use

Our argument in this study is that organisational learning will likely inform the manner in which organisations use their Cloud CRM systems, with their use scenarios indicating either exploitation or exploration learning. Exploitation and exploration organisational learning concepts have been previously used for classifying various organisational projects: technological projects (Hunter, 2003), organisational innovations (Li, Vanhaverbeke, & Schoenmakers, 2008), product innovation (Greve, 2007), on-premise enterprise systems implementation (Kraemmerand, Møller, & Boer, 2003; Tomblin, 2010), and ERP post-implementation modifications (Oseni, Rahim, Smith, & Foster, 2012; Oseni, Rahim, Smith, & Foster, 2014). Organisational learning in terms of exploitation and exploration has however not been adopted as a lens for CRM adoptions. Yet, exploitation and exploration will likely occur as an organisation, through the use of CRM, transforms data to information and information to knowledge. In addition, as the use of traditional in-house and packaged software such as ES, has been found to result in organisational learning (Edberg & Olfman, 2001a; Edberg & Olfman, 2001b), which then influences how ES are maintained and enhanced (Kraemmerand et al., 2003; Nicolaou, 2008; Tomblin, 2010). How organisational learning influences the manner in which such packaged software are utilised is however an area that is presently not covered by the literature. Particularly, as onsite implementations are decreasing and cloud based options are more desirable, investigating exploitation and exploration tendencies appear important. This is especially the case because organisational learning significantly impacts on the assimilation of cloud technology (Bharati & Chaudhury, 2014), alongside influencing organisational elements such as culture, staff skills, and work practices (El-Gazzar, 2014).

Based on the different features that characterise each learning type, we suggest that SaaS CRM use scenarios may indicate organisational learning through exploitation and exploration. Hence our goal in this paper is to investigate how the use of cloud CRM demonstrates exploitation vs exploration, and present strategies for effective SaaS CRM usage. This is relevant and emphasises that attachment to the existing core competencies makes organisational learning and the development of fundamentally new capabilities extremely difficult for established organisations (Khanagha, Volberda, Sidhu, & Oshri, 2013). The paper therefore considers organisational learning in successful post-live use of SaaS CRM, with a Higher Education institution as the context of investigation and seeks to explicate how SaaS CRM usage reflect an organisation’s learning.

### 3.0 Research Method and Context

The research approach for the current study is an interpretive case study. The approach is adopted to gain insight into how organisational learning emerges in SaaS CRM use. The revelatory aims and research question of the current study inclined us towards an exploratory case study. A case study is defined as a research strategy that examines a phenomenon in its natural setting, and permits the researcher to gather information from one or multiple entities by employing multiple data collection

methods (Benbasat, Goldstein, & Mead, 1987; Yin, 2009). A single exploratory case study provides detailed and intensive analysis of the phenomenon of interest (SaaS CRM use), with emphasis on an intensive examination of the setting (Bryman, 2012). Our case study will explore the concepts of organisational learning for understanding how SaaS CRM can be better utilised. We present a case study of a higher education institution reflecting SaaS CRM adoption and use from an OL perspective by questioning several use cases as reflecting exploitation or exploration OL. The selection of an Australian higher education institution is purposive and not random. This provides a suitable context for the research questions to be answered (Yin, 2009). As higher education CRMs normally serve three key audiences: prospective students, current students, and alumni/donors (Vugt & Knasys, 2015), they differ from CRM Systems that are designed for a single type of customer. Data is collected via interviews with three key CRM users: *ITS Program Manager* who managed the implementation of CRM, *Student Systems and Processes Manager* who handles the day to day running of the CRM, and the *Student Experience Coordinator* who coordinates the use of the CRM for business processes. These three key personnel were engaged as they represent the major informants for the CRM implementation and post-implementation use. To identify what mode of learning has been employed in a use scenario, interview questions cover skills, procedures or capabilities that were improved, challenged or changed during that particular use scenario. Questions are designed to identify exploitation activities which can be characterised as needing already accumulated knowledge, clear, able to be properly conducted using present knowledge, focused on achieving short-term goals and which are clearly consistent with existing company policy. For exploration CRM use, questions sought to uncover activities which represent a search for new possibilities within the context of SaaS CRM use, as well as an evaluation of diverse options with respect to business processes, which might require staff members to learn new skills or obtain new knowledge. Data is analysed thematically using a pattern-matching logic (Yin, 2009), a technique of analysis which allows comparisons between empirically-based patterns and conceptual predictions. Following the recommendation of Kelle (2007), qualitative coding was done to develop theoretical concepts and categories from unstructured textual data.

## 4.0 Alpha University Case study – Data Analysis

### 4.1 Implementation Background

This is a case of SaaS CRM implementation and usage at a higher education institution in Australia – Alpha University; a 1.5 million dollar government-funded project with the purpose to address problems with student engagement. Prior to the initiation of the project, the university was new to the SaaS environment as most enterprise systems used by the university had been hosted on the premise. The strategy with the cloud CRM was to have a template based implementation with a reliance on “AS IS” functionality. Microsoft dynamics CRM was selected and two of its modules were implemented. The two modules delivered were considered a success from a products’ delivery point of view, holistically the system is not used for engaging students through the entire student lifecycle. In addition, though the system offers data mining and analytics functionalities, these are not presently being used. In consideration of its use from an OL perspective, the objectives of the implementation, associated activities, and resulting outcomes are investigated. As presented in Table 1 above, three important characteristics for differentiating between exploitation and exploration learning include the objectives, the type of activities through which learning is accomplished, and the timing of benefits derived. These three aspects are able to indicate Exploitation/Exploration organisation learning, and therefore form a lens through which we discuss findings from the case.

### 4.2 Implementation Objectives

Exploitation can be reflected in objectives for the use of CRM such as for increased reliability, accuracy and control over core business processes, including improvement of short-run efficiency, and refinement of existing capabilities/technologies. Objectives that include the development of new knowledge, new ways of problem- solving, and new strategies and technologies on the other hand reflect exploration learning. From this perspective, the adoption of SaaS CRM can be seen to reflect exploration by the university. The CRM project was an opportunity to invest in a gap that existed. Because there were no systems and sheets for capturing data of student interactions, the system was considered because it had embedded in it, processes that were desired but at the moment not in existence. This can be observed in the statements below:

*“Prior to this, a student management application was used but the marketing team was missing a function to engage with prospective students. There was no process of interacting with such students and so there was a big hole in that respect. The student customer services were using their internal sheets and there was no mechanism to obtain data that can be used to see the type, nature,*



*and interest of students and reassessing...so that was a key reason for the project” – ITS Program Manager*

*“We had very fragmented student systems and processes, and nothing that could record interactions with prospective students...no consistency. One of the aims was to have a single repository for students management. I think it was recognised that we needed a better way to deal with students communication. There is value in having a system where communication is recorded and it could be accessed by anyone that needed to look into the records” – Manager, Student Systems and Processes*

The project represented a new venture where the university did not have much expertise or knowledge, also pointing to exploration as mentioned below:

*“On a strategic level, we did not have a vast knowledge of how well CRM could be used ...We also didn't have a CRM support person to assist us in exploring new possibilities... The system was put in so we could understand what kind of enquiries we get, and to ensure that we had relevant staff available to manage the enquiries...for instance to understand what time of the year we get an influx of enquiries, what piece of work do we need to do, the staff we'll need to be responding to enquiries...” –Student Experience Coordinator*

### 4.3 Implementation Activities

Exploitation activities emphasise reduced variation in organisational processes and are risk-averse in nature while Exploration activities lead to increased variation in organisational processes, tasks and functions, and involve risk-taking, innovation, and research. The objectives of the project point to exploration, the actual use of SaaS CRM in the university point to exploitation. The activities undertaken in using the new system highlight the desire for reduced variation in processes. For instance, the ITS program manager stated:

*“When human do things, they actually do it based on whatever they think is right, but when you go for standardisation and best practices...you've got options to customise or use as is..and if you use as is then you change your business processes, you get trained on them and try to see things in a different way from how you were doing things ..and this is the kind of learning that a department or unit goes through with exposure to a new system...but that is not the case here” – ITS Program Manager*

Similarly two other users express a similar sentiment reflecting that the use of the system does not reflect a search for possibilities, but rather emphasise well-known organisational processes.

*“We're basically doing the same job...we answered emails before, we're answering emails now just using a different system... So instead of the email coming into the different mail boxes, it comes straight into CRM” –Student Experience Coordinator*

*“Since the initial CRM implementation, there have been plans to do a phase 2 but that that hasn't happened...so at the moment its just business as usual but using the CRM... Up until now its been just using the system for what we know or what we've been told that the system can do... we haven't had time to go back to find out what else we can do. ..we know what we know because we know it, but theres a whole lot more functionality that we can be using that we just haven't investigated ” – Manager, Student Systems and Processes*

### 4.4 Implementation Outcomes

Similar to the activities, the outcomes reflect exploitation through automated processes and reflected in certain and immediate benefits. With exploration, while benefits are expected, there usually will be some uncertainty associated and a lower level of clarity as to what the outcomes might be.

*“As per outcomes, people are happy because their processes are no longer manual and the system is delivering some key critical functionality that are beneficial, but if you look at it holistically, it's not doing what we put it in for considering all the money we spent ... now we are considering whether to go for another system or to re-implement other modules from dynamics into our current environment... it could have been better and there is obviously need for improvement but there are talks to dump it and bring something new. ” – ITS Program Manager*

*“It previously took about 5 days to respond to enquiries, now that's reduced to 2 days...the right people get allocated the job not like before where mails got allocated to people who really could not respond appropriately... and we have a single view of student interactions its easier for us now to create folders for each staff member to ...students are going to get correct response all the time...Its easier to allocate work to the team” --Student Experience Coordinator*

*“All emails come in are now directed to CRM and that’s become a single point for monitoring and responding to emails. We previously couldn’t quantify that sort of traffic. Managers are using the system to manage workload such that if it’s a busy period, more people are directed to look at emails” – **Manager, Student Systems and Processes***

*“When you bring in a new system, it brings new functionality that impacts on business processes so there is automation definitely on the business front ...many things have become system driven and one of the major functionalities used is the prospects where the system captures the information and introduces a few perks ..prior to this, all that was done was to gather information from emails in a manual way then the system captures and analyses the information...but I believe they could have really changed the way that has been done in the past and this was the main trigger point for the project” – **ITS Program Manager***

## 5.0 Discussion

Following data collection and analysis, we now present our discussion in two levels: first the findings of our study, and subsequently our reflection of the findings.

### 5.1 Findings

Assessing the objectives, activities, and outcomes of the SaaS CRM project through discussions with major stakeholders at the university highlight that while exploration was desired at the initiation of the system, in reality, Exploitation was undertaken. The project’s objectives reflect exploration while the project activities and outcomes reflect exploitation. This instigates an important question: what happened during the implementation journey to redirect Exploration into Exploitation? As indicated by the ITS Programs Manager, the delivery of two modules was considered successful because in the end, there was a new product. In a more rounded perspective however, it seemed that only a tiny portion of available functionality is being exploited. For instance, the system can be used for engaging students from prospects to the entire student lifecycle of but isn’t been used as such. Yet, the university is considering abandoning the system and re-implementing a new system.

So the question, why do organisations explore, exploit, and then stop exploring? Why do they prefer to explore a new system that engage in further exploration of the old? There is obviously more that can be done. For instance, data mining and analytics can be explored but isn’t. This was indicated by the IT Program manager, Student experience coordinator, and manager of student systems.

*“Analytics and business intelligence are other key things that are important...while the system may have data mining and analytics, we are not using it...we are at the moment not performing any data analytics functionality from the CRM system...there is a lot more opportunity...Half of the battle is won by delivering critical functionality...but more importantly, further exploration, identification and implementation is required because that is going to bring the entire cycle to a closure and will guarantee an ongoing live relationship between a university and its customers” – **ITS Program Manager***

*“There is more and we really need to start looking beyond what we are currently using them for. We need to go in and gave a play and see how things work...an outside of the box functionality we can use, and there’ll be things that will be bigger and we may consider as projects. We need to be asking questions. If the system doesn’t work the way we thought it’ll work, does it meet our needs or there’s this add on that we might be able to buy that will deliver more?” – **Manager, Student Systems and Processes***

In summary, it does appear that effective use of the system will be a combination of exploitation and exploration. Exploitation seems to come easily and prompts a consideration of hindrances to exploration? A few things can be attributed from this case.

- First, it does appear that a lack of sufficient knowledge discourages exploration. The student experience coordinator for instance expressed that the much that could be done using the system required specialty knowledge that the team did not have at the time:

*“We were also looking to be able to perform some reports using the system but that has not happened yet because the reports are really not good... If we can get the reports up and running that will be good...we will be able to look through the entire student lifecycle and we know where staff are needed...Are the moment, the reports are crap...generic and not customised for our need...the reports have not been designed to suit us...we got the package but we did not have the support we needed” –**Student Experience Coordinator***

The absence or externalising of such relevant knowledge has implications for effective use of the CRM. For instance, without adequate knowledge, an organisation cannot strengthen its

capabilities in the area. Internalising such knowledge presents organisations the opportunity of learning-by-doing, thereby strengthening its capabilities (Linda & Manpreet, 2017).

- Second, Exploration may require additional resources. The student services manager expressed this by indicating that an additional software will be required should they decide to pursue the idea of expanding the functionality provided by the CRM to meet specific needs:  
*“There is a lot more potential and we are starting to look at how we can use the CRM for capturing and engaging with social media. At the moment, we are using CRM to send emails to students but we’re also really interested in how we can use CRM to contact students via SMS. That obviously involves some other software rather than expecting students to read emails because they really don’t...Timetabling for example is looking at being able to let students know when classes are cancelled on the day...so we are starting to look into that space where we can consider how the functionality that came with the system can be used to move forward” – **Manager, Student Systems and Processes***
- Third, it can be observed from the case of this university’s SaaS CRM implementation that exploration requires proactiveness. The manager of student services reflected this:  
*“We are now getting proactive with how we can use the system better and other functionalities we can use, instead being reactive...there is still lots of potential in the system, it’s a large system and we’re only using a small part of it...but we are moving from a reactive position where we are simply responding to problems...that’s not right, we’ve got to change things slightly to ..Ok how do we use more of the functionality that the system delivers to further improve and make changes? – **Manager, Student Systems and Processes***

## 5.2 Reflection

We began this study considering how organisational learning occurs as an organisation, through the use of CRM, transforms data to information and information to knowledge. We find that the exploitation/exploration attributes of such data transformation activities can influence the outcomes of the usage activities. The data indicated that use cases indicative of knowledge transfer across old user groups might be perceived as exploitation and may not generate new insights into knowledge as compared to use cases involving knowledge transfer across new and un-explored user groups. We conceived Exploitation CRM use scenario as primarily involving the improvement and refinement of current skills and capabilities within the organisation. The exploitation of CRM can therefore be concluded to be the strengthening of a firm’s current customer management routines and capabilities. Exploration CRM use scenarios, on the other hand, are defined as primarily involving the generation of new customer management routines and capabilities. These may involve transformation of existing strategies, and typically challenge previous approaches. The idea of classifying CRM use scenarios based on exploitation and exploration is suggestive of ambidexterity, the expectation that organisations will adopt both learning strategies in their use of SaaS CRM. Both exploitation and exploration are relevant; the former for the codification of technological knowledge into the organisational routines and helpful for evolutionary change and incremental innovations, the latter necessary for the development of radically new technological capabilities and supporting experimentation (Khanagha et al., 2013). However, as organisations have been observed to shift between exploitation and exploration (Greve, 2007), either exploitation or exploration is expected to be dominant for a particular use scenario. Yet, due to intricacies involved in the transformation of data into useful knowledge using CRM, our findings indicate that a balance of exploitation and exploration use scenarios is necessary, if successful CRM utilisation for transforming data into useful knowledge, for enhancing customer satisfaction, is to be achieved.

The summary of our findings is that although it is expected that that organisations will adopt both exploitation and exploration organisational learning strategies in their use of SaaS CRM, only exploitation has been employed so far at Alpha University. As such the outcomes are not yet satisfactory. We find that the use of SAAS CRM at the university indicate a doing of the old with the new, primarily involving the improvement and refinement of current skills and capabilities within the organisation. This was a good outcome, and strengthened the university’s current customer management routines and capabilities, more was expected from the investment in SaaS CRM in the form of new customer management routines and capabilities. For instance, transformation of existing strategies, were expected. Nevertheless, the study revealed that there is still some scope for exploration. As organisations have been observed to shift between exploitation and exploration (Greve, 2007), with either exploitation or exploration being dominant for a particular use scenario, further exploration can be expected in the future. Tthis is usually the case within organisations, desiring exploration but undertaking exploitation, this study emphasises that effective use of SaaS CRM utilisation for transforming data into useful knowledge and for enhancing customer satisfaction requires a balance of exploitation and exploration.

The paper proposes a framework suggesting that a continuous cycle of exploration-exploitation-exploration is necessary for effective utilisation of SaaS CRM. This is presented in Figure 1.

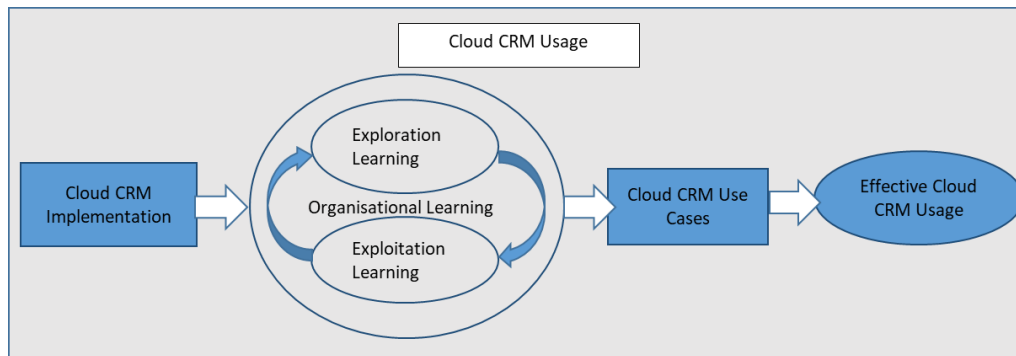

Figure 1: Framework for Organisational Learning in SaaS CRM adoption.

The framework indicates that Exploitation and Exploration learning are both significant and prerequisite to achieving benefits from SaaS CRM. Specifically, the framework emphasises that an organisation's exploitation/exploration initiates use cases that promote effective usage of SaaS CRM. This comprises a desire to maximise current customer processes and knowledge via exploitation, as well as innovative and new customer processes and knowledge via exploration.

## 6.0 Conclusion

The relevance of organisational learning in CRM is an under-explored topic. Yet, CRM success relies heavily on having an adaptive organisational learning process upon which proactive decisions can be made. With arguments that organisational learning results as organisations use their SaaS CRM systems, this study purposed to consider the role of organisational learning in successful post-implementation use of SaaS CRM, with a Higher Education institution as the context of investigation. To examine *how organisation learn to use SaaS CRM*, we conducted a case study to investigate the idea that SaaS CRM usage may reflect organisational learning, and in turn SaaS CRM outcomes.

From the Exploitation-Exploration organisational learning perspective, the case revealed that SaaS CRM use does reflect organisational learning and informed the development of a theoretical framework for effective SaaS CRM usage. This organisational learning informed framework is a key contribution to the CRM literature, and identifies SaaS CRM implementation as the context of investigation; Organisational Learning in terms of exploitation and exploration as the constructs upon which CRM use cases are built; CRM Use Cases as the objects of investigation; and Effectiveness of SaaS CRM Use as outcomes. We observe, from the case study, that while the project's objectives show the organisation's desire to undertake exploration using SaaS CRM, the project activities and outcomes indicate that exploitation had been undertaken. The paper therefore further considered why the desired exploration had not been pursued, and observed that that exploration requires proactiveness, the right knowledge, the right level of support, and the right level of resources. Although it is expected that that organisations will adopt both learning strategies in their use of SaaS CRM, only exploitation had been employed so far, and as such the outcomes are not yet satisfactory. This emphasises that both exploitation and exploration are relevant; the former for the codification of technological knowledge into the organisational routines and helpful for evolutionary change and incremental innovations, the latter necessary for the development of radically new technological capabilities and supporting experimentation (Khanagha et al., 2013).

This insight is relevant for managers who are responsible not only for implementing the system, but for day to day use of the system for business activities. Particularly because a good balance of exploitation and exploration requires conscious planning and efforts, business managers must implement strategies that emphasise both exploitation and exploration. As a contribution to practitioners, the paper proposes that a continuous cycle of exploration-exploitation-exploration is necessary. Yet the reality is that organisations explore, exploit, and then stop exploring. In fact, rather than exploring what is already being exploited, organisations sometimes prefer to explore into a totally new system as was seen in this case. We believe that CRM managers can use our organisational learning informed model as a tool for guiding CRM use cases towards desired outcomes. We however caution against generalising the findings due to the use of a single case study. Further studies are needed involving multiple case studies across various industry segments. Likewise, surveys are to be undertaken to collect data from a range of

organisations to establish a better understanding of how SaaS CRM use reflect an organisation's learning, and in turn SaaS CRM outcomes.

## References

- Amuna, Y. M. A., Shobaki, M. J. A., Naser, S. S. A., & Badwan, J. J. (2017). Understanding Critical Variables for Customer Relationship Management in Higher Education Institution from Employees Perspective. *International Journal of Information Technology and Electrical Engineering*, 6(1).
- Bauer, M. (2012). Lessons Learned in the Development of a CRM SaaS Solution. In A. Maedche, A. Botzenhardt, & L. Neer (Eds.), *Software for People: Fundamentals, Trends and Best Practices* (pp. 257-274). Berlin, Heidelberg: Springer Berlin Heidelberg.
- Benbasat, L., Goldstein, D. K., & Mead, M. (1987). The Case Research Strategy in Studies of Information Systems. *MIS Quarterly*, 11(3), 369-369. Retrieved from <http://search.proquest.com/docview/218119421?accountid=12528>
- Bernsteiner, R., Kilian, D., & Ebersberger, B. (2016). Mobile Cloud Computing for Enterprise Systems: A Conceptual Framework for Research. *International Journal of Interactive Mobile Technologies (iJIM)*, 10(2), 72-76.
- Bharati, P., & Chaudhury, A. (2014). Cloud Assimilation: An Organizational Learning Approach.
- Bryman, A. (2012). *Social research methods* (4th ed.). Newyork: Oxford university press.
- Buxton, A. (2015). The reasons why SaaS will remain the dominant cloud model. *TechRadar*.
- Chadhar, M., & Daneshgar, F. (2018). Organizational Learning and ERP Post-implementation Phase: A Situated Learning Perspective. *Journal of Information Technology Theory and Application (JITTA)*, 19(2), 7.
- Chadhar, M., & Daneshgar, F. (2018). *IS Enactment and organisational learning: A case of an integrated ERP post-implementation in Australia*. Paper presented at the 27th Australasian Conference on Information Systems, Brsiabne.
- Chen, Y.-S., Wu, C., Chu, H.-H., Lin, C.-K., & Chuang, H.-M. (2017). Analysis of performance measures in cloud-based ubiquitous SaaS CRM project systems. *The Journal of Supercomputing*. doi:10.1007/s11227-017-1978-x
- Edmondson, A., & Moingeon, B. (1998). From Organizational Learning to the Learning Organization. *Management Learning*, 29(1), 5-20. doi:10.1177/1350507698291001
- El-Gazzar, R. F. (2014). A Literature Review on Cloud Computing Adoption Issues in Enterprises. In B. Bergvall-Kårebom & P. A. Nielsen (Eds.), *Creating Value for All Through IT: IFIP WG 8.6 International Conference on Transfer and Diffusion of IT, TDIT 2014, Aalborg, Denmark, June 2-4, 2014. Proceedings* (pp. 214-242). Berlin, Heidelberg: Springer Berlin Heidelberg.
- Futa, G. (2004). Customer Relationship Management system models application in higher education. *Annales UMCS Informatica AI*, 2(1), 445-452
- Greve, H. R. (2007). Exploration and exploitation in product innovation. *Industrial & Corporate Change*, 16(5), 945-975. Retrieved from <http://ezproxy.lib.monash.edu.au/login?url=http://search.ebscohost.com/login.aspx?direct=true&db=bth&AN=27642939&site=ehost-live&scope=site>
- Hunter, S. D. (2003). Information Technology, Organizational Learning, and the Market Value of the Firm. *Journal Of Information Technology Theory And Application*, 5(1), 1-28.
- Janson, M., Cecez-Kecmanovic, D., & Zupančič, J. (2007). Prospering in a transition economy through information technology-supported organizational learning. *Information Systems Journal*, 17(1), 3-36.
- Kelle, U. (Ed.) (2007). *Computer-assisted qualitative data analysis*. London: SAGE.
- Khanagha, S., Volberda, H., Sidhu, J., & Oshri, I. (2013). Management innovation and adoption of emerging technologies: The case of cloud computing. *European Management Review*, 10(1), 51-67.
- Kraemmerand, P., Møller, C., & Boer, H. (2003). ERP implementation: An integrated process of radical change and continuous learning. *Production Planning & Control*, 14(4), 338-348. doi:10.1080/0953728031000117959
- Lavie, D., Stettner, U., & Tushman, M. L. (2010). Exploration and Exploitation Within and Across Organizations. *The Academy of Management Annals*, 4(1), 109-155. doi:10.1080/19416521003691287
- Li, Y., Vanhaverbeke, W., & Schoenmakers, W. (2008). Exploration and Exploitation in Innovation: Reframing the Interpretation. *Creativity and Innovation Management*, 17(2), 107-126. doi:10.1111/j.1467-8691.2008.00477.x

- Linda, A., & Manpreet, H. (2017). Organizational Learning and Management of Technology. *Production and Operations Management*, 26(4), 579-590. doi:doi:10.1111/poms.12667
- Malladi, S., & Krishnan, M. S. (2012). Cloud computing adoption and its implications for CIO strategic focus—an empirical analysis.
- March, J. G. (1991). Exploration and exploitation in organizational learning. *Organization Science*, 2(1), 71-87. Retrieved from <http://ezproxy.lib.monash.edu.au/login?url=http://search.ebscohost.com/login.aspx?direct=true&db=bth&AN=4433770&site=ehost-live&scope=site>
- March, J. G. (1995). The Future, Disposable Organizations and the Rigidities of Imagination. *Organization*, 2(3-4), 427-440. doi:10.1177/135050849523009
- March, J. G., Sproull, L. S., & Tamuz, M. (1991). Learning from samples of one or fewer. *Organization Science*, 2(1), 1-13. Retrieved from <http://ezproxy.lib.monash.edu.au/login?url=http://search.ebscohost.com/login.aspx?direct=true&db=bth&AN=4433753&site=ehost-live&scope=site>
- Oseni, T., Rahim, M. M., Smith, S. P., & Foster, S. (2012). *Exploring ERP post-implementation modifications and their influence on business process outcomes: a theory driven model*. Paper presented at the 24th Australasian Conference on Information Systems, Melbourne.
- Oseni, T., Rahim, M. M., Smith, S. P., & Foster, S. (2014, June 9-11). *An Initial Empirical Evaluation Of The Influence Of Erp Post-Implementation Modifications On Business Process Optimisation*. Paper presented at the European Conference on Information Systems (ECIS), Tel Aviv, Israel.
- Peltier, J. W., Zahay, D., & Lehmann, D. R. (2013). Organizational Learning and CRM Success: A Model for Linking Organizational Practices, Customer Data Quality, and Performance. *Journal of Interactive Marketing*, 27(1), 1-13. doi:<https://doi.org/10.1016/j.intmar.2012.05.001>
- Seethamraju, R. (2015). Adoption of software as a service (SaaS) enterprise resource planning (ERP) systems in small and medium sized enterprises (SMEs). *Information systems frontiers*, 17(3), 475-492.
- Smith, D. M., & Anderson, E. (2017). *Hype Cycle for Cloud Computing, 2017* Retrieved from
- Son, I., & Lee, D. (2011). *Assessing A New IT Service Model, Cloud Computing*. Paper presented at the PACIS.
- Tomblin, M. S. (2010). Theory development in enterprise systems and organizational learning. *Journal of Organizational Computing and Electronic Commerce*, 20(4), 398-416. doi:10.1080/10919392.2010.516647
- Vugt, T. v., & Knasys, M. (Producer). (2015). The importance of CRM systems in Higher Education.
- Williams, K. J. C. (2017). *Hype Cycle for Education, 2017* Retrieved from
- Yamin, M., & Sinkovics, R. R. (2007). ICT and MNE reorganisation: the paradox of control. *critical perspectives on international business*, 3(4), 322 - 336.
- Yin, R. K. (2009). *Case study research*. California: SAGE.

**Copyright:** [Oseni, Chadhar, Ivkovic, Firmin]© 2018 authors. This is an open-access article distributed under the terms of the [Creative Commons Attribution-NonCommercial 3.0 Australia License](https://creativecommons.org/licenses/by-nc/3.0/), which permits non-commercial use, distribution, and reproduction in any medium, provided the original author and ACIS are credited.

# A Comparative Study of Critical Success Factors for General and Healthcare Business Intelligence Systems

Quy Nguyen  
Faculty of Information Systems  
University of Information Technology, Ho Chi Minh City  
Email: [qnd2611@gmail.com](mailto:qnd2611@gmail.com)

Rob Meredith  
Faculty of Information Technology  
Monash University  
Caulfield East, Victoria  
Email: [Rob.Meredith@monash.edu](mailto:Rob.Meredith@monash.edu)

Frada Burstein  
Faculty of Information Technology  
Monash University  
Caulfield East, Victoria  
Email: [Frada.Burstein@monash.edu](mailto:Frada.Burstein@monash.edu)

## Abstract

Critical Success Factor (CSF) research provides a useful instrument for better managing a project and driving it to success. Research about CSFs for business intelligence (BI) systems and industry-specific CSFs have been noted; however, scant research has been conducted to investigate CSFs for healthcare BI projects. This paper adopted a mixed method approach to investigate differences between CSFs of BI systems in general and BI systems in the healthcare industry. We found that although CSFs of healthcare BI are similar to those of general BI, there is a significant overlap between CSFs for BI development and use. This finding supports the intertwined relationship between success of different BI project phases, which has yet been acknowledged in BI and IS success models.

**Keywords** Critical Success Factors, Healthcare Business Intelligence, Business Intelligence Success Model.

## 1 Introduction

According to Negash and Gray (2008), business intelligence (BI) is a type of information system (IS) that gathers, stores, manages and analyses data to provide inputs to and improve outputs of the decision-making process. The term “business intelligence” has been around for many decades and since the 2000s, BI has become a significant part of IT portfolios of many organisations (Arnott and Pervan 2014). Gartner (2017) forecasts that global spending on BI technologies will reach US\$ 22.8 billion at the end of 2020.

In healthcare organisations, BI adoption has made significant impacts on administrative and clinical operations. These systems are often used by medical professionals to obtain aggregated data from multiple information registries and medical records to gain better understandings of healthcare practices, and improve patient outcomes (Tremblay et al. 2012). BI applications also improve healthcare administration by increasing process efficiency, better utilising the human resource and reducing costs (Foshay and Kuziemy 2014). Despite the strategic role of BI and significant investments for BI projects, organisations often suffer from high rates of failure. Healthcare BI projects face even more significant challenges due to the involvement of diverse stakeholders, and the risk-averse and complex nature of the healthcare setting (Standing and Cripps 2015). Brooks et al. (2013) point out that unlike BI systems in other industries, healthcare BI systems need to gather data from multiple siloed systems within the organisation as well as external entities because of interoperability requirements in healthcare practices. Adding to the complexity of healthcare BI is the need to integrate financial data and clinical data which are often stored in various formats and have different definitions. These challenges justify a desire to investigate key factors that are likely to affect the overall success of healthcare BI projects. Unfortunately, our understanding of this topic is still limited.

This paper is, therefore, motivated by both theoretical and practical objectives. Theoretically, given the lack of empirical studies on CSFs of healthcare BI, our paper makes an initial step toward addressing this research gap by adding empirical evidence to the question of whether CSFs of healthcare BI are different from general BI. We were also interested in identifying CSFs for different project phases as Wu (2007) and Sangar and Iahad (2013) argue that success should be defined differently for each phase. While different projects may consist of different lifecycle phases, we investigated the broad difference between development CSFs and use CSFs. In practical terms, the investigation of CSFs of healthcare BI is expected to help BI practitioners and healthcare organisations better focus their efforts and resources on critical areas to drive their projects to success throughout the entire project lifecycle.

To achieve the research objectives, we integrated the literature on CSFs of BI and related decision support systems to create a list of BI CSFs. This general BI CSF list was used as a theoretical lens for our exploration of CSFs for healthcare-specific BI projects. In addition to an online survey, we conducted face to face interviews with healthcare BI experts to gain in-depth understandings of the impact of healthcare settings on BI projects. Our research results confirmed that CSFs for healthcare BI are similar to CSFs for general BI, and there is a significant overlap between CSFs of BI development and BI use. On the basis of our analysis, we offered significant insights to the current understandings on success models of BI projects, and practical implications on how to maintain BI success across different project phases.

## 2 Research Design

As stated in section 1, this paper aims to investigate CSFs for healthcare BI and the relationship between CSFs and different project phases. To achieve these objectives, an exploratory, interpretivist approach was adopted. Specifically, this research followed a mixed-method research design with both qualitative and quantitative elements. According to Remus and Wiener (2010), the combination of quantitative and qualitative approaches is especially relevant and useful to CSF research consisting of multiple phases with each phase requiring a different method. The mixed-method approach was applied in the three stages of this research as follows:

### 2.1 Stage one – Literature review

The purpose of stage one was to explore and identify a set of CSFs for BI projects across multiple industries, discussed in previous studies. We conducted a systematic review of the CSF literature in several online databases such as ProQuest, EBSCOHost, Google Scholar, and the AIS electronic library. Also, acknowledging the fact that BI is a type of decision support system (DSS) (Arnott and Pervan 2014) and research findings of different types of DSS are transferrable (Clark et al. 2007), this research utilised



Research phase	Purpose	Type of research
Literature review	<ul style="list-style-type: none"> <li>Constructing a theoretical basis for CSF examination.</li> <li>Identifying and defining a CSF list for general BI</li> <li>Classifying CSFs into different phases of BI projects</li> </ul>	Qualitative
Online survey of healthcare BI experts	<ul style="list-style-type: none"> <li>Assessing the relevance of the CSFs of general BI for healthcare settings</li> </ul>	Quantitative & qualitative
Semi-structured interviews with healthcare BI experts	<ul style="list-style-type: none"> <li>Obtaining in-depth insight of issues raised in the survey's responses.</li> <li>Triangulate the survey results.</li> </ul>	Qualitative

*Table 1: Research design applied in three stages of this research*

CSF findings for such DSS as executive information systems, data warehouses, and personal DSS to ensure that the list was exhaustive. The result of this stage was an integrated list of CSFs for general BI, which was used as a theoretical lens for our exploration of the CSFs for healthcare-specific BI.

## 2.2 Stage two – An online survey

Based on the CSF list of general BI, a semi-structured survey was designed to collect data from healthcare BI developers and users, using an online survey tool. The first part of the survey collected demographic information from the respondents to ensure that they met the inclusion criteria. The second part asked respondents to indicate the 'criticality' of the identified CSFs to healthcare BI development, as well as use on five-point Likert scales. The third part consisted of open-ended questions asking the respondents to provide any CSFs that might have been missing from the CSF list. The survey link was posted to an online professional network where it reached more than 1300 healthcare BI practitioners internationally. During the survey time, email reminders and the snowballing technique were applied to gain respondent rates. A total of nine usable survey responses were collected.

## 2.3 Stage three – Follow-up interviews

At the end of the survey, the respondents were asked if they would like to participate in follow-up interviews. Two respondents agreed and were selected. The interviewees were selected because they had substantial experience of healthcare BI and BI in other industries. Both of them were working as healthcare BI experts for a large public hospital in Australia. Before the actual interviews, interview questions were emailed to the interviewees for them to prepare for the interview so that more informative data could be collected and interview fluidity was maintained (Poon and Wagner 2001). The interviews were conducted for between 60 to 75 minutes and were audio recorded. In addition to the audio records, written notes were taken during the interviews and later analysed.

# 3 Theoretical Background and Related Works

## 3.1 BI success and critical success factors

BI success can be understood as positive benefits obtained through the deployment of ISs (Isik et al. 2013). However, because success is perceived differently, and organisations implement ISs for different objectives, IS success is measured in different ways. As a result, several success models have been developed to measure IS success such as the model of Delone and McLean (2003) and Data Warehouse (DW) success such as the work of Wixom and Watson (2001). Also, as mentioned in Section 1, Wu (2007) and Sangar and Iahad (2013) argue that success measures should be defined according to project stages because as the project progresses, success changes. Following Delone and McLean (2003), Wixom and Watson (2001), and Yeoh and Koronios (2010), success criteria for BI implementations may include factors such as information quality, system quality, service quality and project process performance, while BI use success may take into account system use and net benefits.

The success of BI projects can be affected by various factors. The idea of CSFs is that some factors are so critical that they must be effectively managed for the project to be successful (Rockart 1979), these factors must be addressed effectively for the organisation be successful. Since Rockart's article, many studies have been conducted to investigate CSFs for BI in different industries such as insurance and financial services Arnott (2008), energy (Harison 2012; Yeoh and Koronios 2010), and transportation and construction (Yeoh and Koronios 2010).

According to Remus and Wiener (2010), one of the key characteristics of CSF research is the need to analyse CSFs in specific contexts. CSF literature reveals several results for BI in different industries, however, our understanding of this topic in healthcare settings still remains limited. In addition, although the dynamic and interrelated nature of CSFs has been acknowledged in previous studies (McBride 1997; Nandhakumar 1996), they do so in a limited way. Therefore, the purpose of our literature review is to compile CSFs for BI projects from previous studies into an integrated list of CSFs for general BI and present this list as a theoretical lens for the exploration of CSFs for healthcare BI. Also, acknowledging the dynamic and interrelated nature of CSFs, we have categorised the identified CSFs into three groups: BI development, BI use, and CSFs common to both phases. This categorisation creates a basis for further investigation of the relationship between CSFs of different phases and the implications it may have on BI success dimensions.

### 3.2 CSFs for general BI development

Analysing executive information system (EIS) and the DW literature, Arnott (2008) created a list of 10 CSFs for BI and DW systems. His CSF list includes appropriate team skills, effective data management, widespread management support, committed and informed executive sponsor, appropriate technology, adequate resources, a clear link with business objectives, well-defined information and systems requirements, evolutionary development, and management of project scope. ) developed a list of 22 CSFs including 15 CSFs specific to BI and seven CSFs common to both BI and enterprise resource planning systems. Yeoh and Koronios (2010) created a list of seven CSF categories for BI implementation. BI literature also reveals other CSF lists such as Olszak and Ziemia (2012), Olbrich et al. (2012), and Sangar and Iahad (2013).

### 3.3 CSFs for general BI use

When investigating CSFs for EIS, Rainer and Watson (1995) developed two CSF lists for the development phase and the use phase. Their CSF list for EIS use consisted of 46 factors in four main groups: system function, systems characteristics, information quality factors, and impact on executive work factors. Later, Sangar and Iahad (2013) found that perceived usefulness and learnability, and user-friendly technologies are essential to end-user acceptance, making it a CSF of BI use. In addition, organisational maturity was considered critical to the continual re-alignment of BI and the organisation's business objectives (Schieder and Gluchowski 2011; Wixom and Watson 2010). Similarly, Audzeyeva and Hudson (2016) claim that organisations should effectively manage organisational deep structure factors such as core beliefs and values, organisational structures, power distribution and control systems to derive long-term benefits from their BI investment.

### 3.4 CSFs common to general BI development and general BI use

Wixom and Watson (2001) contend that after successful implementation, widespread management support and ongoing commitment of resources continue to be critical to the success of the post-implementation phase of DW. Moreover, because business and information requirements evolve over time, BI systems need to be updated to support the on-going re-alignment between BI and the organisation (Audzeyeva and Hudson 2016). Therefore, an adaptive, evolutionary development methodology (Arnott 2008; Poon and Wagner 2001) is another CSF common to both BI development and BI use. User training was considered as another common CSFs for both BI development and BI use because users can improve satisfaction and expertise in deploying the BI system through training sessions (Poon and Wagner 2001; Sangar and Iahad 2013).

### 3.5 An integrated list of general BI CSFs

An integrated list of 23 CSFs was obtained after an extensive search of CSFs in the literature as shown in Table 1. The CSF list was obtained from a variety of academic sources, including peer-reviewed articles, conference papers, and book chapters. However, to ensure the quality of the reference sources, only peer-reviewed articles were selected to create the list.

No.	CSF	Description
CSF1	Ongoing top management support and sponsorship	BI/DW should receive widespread and ongoing support and sponsorship from top management. This helps manage the change process and overcome resistance.
CSF2	Clear link with business objectives	BI projects must be aligned and driven by business requirements and strategies. BI systems need to be re-aligned to fulfill changing business needs.

No.	CSF	Description
CSF3	Adaptive, evolutionary development approach	A successful DW/BI system should be developed iteratively with strong user involvement, evolving towards an effective application set.
CSF4	User training	BI projects should have proper training programs for users and focus on training super users who will then train other users in their department.
CSF5	Appropriate team skills	The project manager must possess adequate knowledge and skills in business and technical areas to successfully guide the project. Support staff must be capable of mastering technologies required for the system.
CSF6	Appropriate technology and tools	BI hardware and software should be selected with a high level of organisational fit.
CSF7	Adequate resources	BI projects must receive sufficient budget for software, hardware, and human resources.
CSF8	Data quality and integrity	The project should have an effective ETL process to minimise data quality issues and integrate data from different sources.
CSF9	Well-defined information and system requirements	BI project should have common definitions of what is required from the systems, and these definitions should be agreed by both business and technical sides.
CSF10	Scalable and flexible technical framework	Technical infrastructure must be scalable to facilitate system expansion to align with evolving information needs.
CSF11	Effective project management	The project should be guided by an effective, suitable management methodology to minimise project risks and increase the success chance.
CSF12	Integration of BI and other systems	Physical or functional link of BI with various systems and their application or data should be visible so that the derived value can be greater than that obtained from individual systems.
CSF13	Change management	Organisations need to adopt an effective approach to managing changes associated with the BI implementation.
CSF14	Effective communication	BI projects should develop an effective communication plan to communicate to internal and external audience. This is to convey information to and to get feedback from the intended audience.
CSF15	Balanced team skill and composition	BI projects should include people from both the IT and the business side of the organisation.
CSF16	Human factor	Apart from having a balanced development team, BI projects should find right people as project champions and participants in pilot projects.
CSF17	Timing of BI effort	The readiness of organisations to accept changes from the adoption of BI systems.
CSF18	Perceived BI usefulness	Users' perception of how BI can help to fulfill their daily work.
CSF19	Organisational maturity	Development level of structures and processes of organisations which facilitate strategic use of BI to address business priorities.
CSF20	Organisational culture	The system of beliefs, values, and norms of individuals within organisations that supports the use of BI systems and fosters it by emphasizing their economic and operational benefits.
CSF21	Information quality factors	Quality of information obtained from the systems which include timeliness, accuracy, relevance, and convenience
CSF22	BI function factors	Functions of the systems that provide useful information for users. They include status access, standardised definitions, exception reporting, access to external data, drilling down.
CSF23	BI characteristics factors	Attributes of the system that allow users to easily access and assimilate information. They include ease of use, adaptable interface, adaptability to changing information requirements

*Table 2: An integrated CSF list for general BI*

It should be acknowledged that the identified CSFs are a very large list. This would seem to contradict the underlying premise of CSFs, which is that they should consist of “the limited number of areas” critical to success (Rockart 1979). Also, some CSFs in this list, such as CSF11, CSF13, CSF14, appears to be

relevant because they were discussed at different levels of detail in previous studies. For example, some studies grouped detailed factors into more general and comprehensive CSFs such as Rainer and Watson (1995) and Yeoh (2010) while others listed detailed factors as separate CSFs such as Olbrich et al. (2012). These suggest two issues in CSF research: CSF grouping and the size of CSF lists which are beyond the scope of this study but warrants further consideration in future studies. For the sake of exhaustiveness, we refrained from editing the integrated list, instead relying on the survey and interview phases of the project to identify the ‘criticality’ of each identified CSF.

The 23 identified CSFs were categorised into three groups: common CSFs, CSFs for BI development, and CSFs for BI use. It should be noted that the categorisation was based on research findings in previous studies where they have been found critical to the success of either BI development, BI use, or both phases. Four CSFs were included as common CSFs, thirteen CSFs as specific to BI development and eight CSFs as specific to BI use. Table 3 presents the categorisation, along with the sources used as the basis for classification.

<b>CSF No.</b>	<b>Development</b>	<b>Use</b>	<b>CSF categorisation</b>
CSF1	(Poon and Wagner 2001); (Yeoh and Koronios 2010); (Presthus et al. 2012);	(Wixom and Watson 2001); (Grubljesic and Jaklic 2015)	Common
CSF2	(Yeoh and Koronios 2010); (Olszak and Ziemba 2012); (Sangar and Iahad 2013)	(Audzeyeva and Hudson 2016)	Common
CSF3	(Poon and Wagner 2001); (Presthus et al. 2012)	(Audzeyeva and Hudson 2016)	Common
CSF4	(Harison 2012); (Presthus et al. 2012)	(Sangar and Iahad 2013); (Grubljesic and Jaklic 2015)	Common
CSF5	(Presthus et al. 2012); (Olszak and Ziemba 2012); (Sangar and Iahad 2013)		Development
CSF6	(Wixom and Watson 2001); (Olszak and Ziemba 2012); (Sangar and Iahad 2013)		Development
CSF7	(Wixom and Watson 2001); (Harison 2012); (Olszak and Ziemba 2012)		Development
CSF8	(Wixom and Watson 2001); (Yeoh and Koronios 2010); (Olszak and Ziemba 2012); (Sangar and Iahad 2013)		Development
CSF9	(Rainer and Watson 1995); (Poon and Wagner 2001); (Olszak and Ziemba 2012)		Development
CSF10	(Yeoh and Koronios 2010); (Harison 2012)		Development
CSF11	(Sangar and Iahad 2013)		Development
CSF12	(Olszak and Ziemba 2012); (Isik et al. 2013)		Development
CSF13	(Yeoh and Koronios 2010); (Olszak and Ziemba 2012)		Development
CSF14, 16, 17	(Presthus et al. 2012)		Development
CSF15	(Yeoh and Koronios 2010); (Presthus et al. 2012)		Development
CSF18		(Sangar and Iahad 2013); (Grubljesic and Jaklic 2015)	Use
CSF19		(Wixom and Watson 2010); (Audzeyeva and Hudson 2016)	Use
CSF20		(Harison 2012); (Grubljesic and Jaklic 2015)	Use
CSF21, 22, 23		(Rainer and Watson 1995)	Use

Table 3 : A categorisation of CSFs for general BI

## 4 Survey and Interviews

### 4.1 Survey data analysis

The survey received a total of twelve responses, of which three were excluded because of missing data, resulting in nine useable responses. While the sample size is very low, it should be noted that the purpose of the survey was qualitative and exploratory rather than quantitative and seeking to establish statistical validity. Rather, our aim was to gain an in-depth understanding of the healthcare context and how it affects the success of BI projects from senior experts in the area, with significant collective experience across multiple projects.

The respondents worked in different healthcare departments. Most had more than five years of experience in healthcare BI projects and were involved in more than one project phase.

Respondent characteristics		No. of respondent N=9
Job title	Manager of IT department	5
	Manager of business department	2
	Manager of R&D department	1
	Healthcare Solution Architect	1
Healthcare BI experience	1-5 years	1
	5-10 years	7
	More than 10 years	1
Role in healthcare BI project	Developer	7
	User	2
Healthcare BI project phase involved	Development	7
	Use	7

Table 4: Survey respondents' demographic information.

Respondents were asked to rate the importance of each CSF for the healthcare BI project using a five-point Likert scale from not important at all (1) to absolutely critical (5). During the data analysis, the rating was sorted into two groups for comparison. We categorised an individual response as considering a CSF as critical if it was rated 4 or 5. With nine responses, we classified a factor as critical if it was rated critical by five or more respondents. Figure 1 provides a visual summary of this analysis.

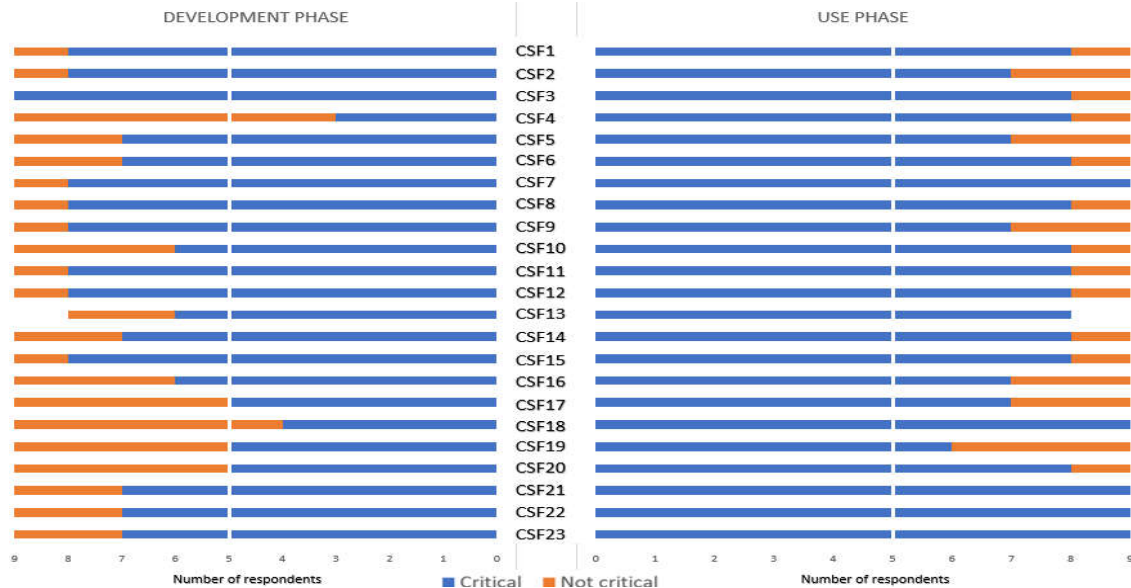

Figure 1: CSF rating for healthcare BI development and use.

Based on this analysis, changes were made to the CSF categorisation. Two CSFs were not rated as critical for healthcare BI development: CSF4 (user training), and CSF18 (perceived BI usefulness). CSF4 was

originally a common CSF; however, the survey suggests that it is only critical to BI use. The result of this analysis is, therefore, that all CSFs, except for CSF04 and CSF18 are common to both development and use phases. Only CSF04 and CSF18 belong to the use category. These findings suggest that it may not be possible to distinguish CSFs clearly by phase for healthcare BI projects.

At the end of the survey, the respondents were asked to identify CSF differences between healthcare BI and general BI. One distinctive feature of healthcare BI, provided by the respondent, is the ability to benchmark BI results with other healthcare organisations. This is not because of competitive or financial purposes, but is to “share and improve clinical practice and KPIs across the sector”. Survey respondents also highlighted the difficulties in benchmarking healthcare BI systems due to incompatible data formats, definitions, and business rules. Although the importance of BI benchmarking in healthcare BI projects were acknowledged by the survey respondents, there are still questions about how BI benchmarking contributes to the success of healthcare BI projects, and whether this factor is a CSF or it is just an important factor. These questions are discussed further in the follow-up interviews.

## 4.2 Interview data analysis

As outlined above, follow-up interviews were sought to further understand issues that arose from the survey, with respondents volunteering their willingness to participate at the end of the survey. Two healthcare BI experts working in a large public hospital in Australia were chosen, with their backgrounds described in Table 4.

	Interviewee 1	Interviewee 2
Current job role	Business service manager	Director of application & knowledge management
Experience with healthcare BI	6 years	5 1/2 years
Role in healthcare BI project	Designer	Designer
Previous experience with BI systems in other industries	- 3 years - Financial service industry	- 6 years - Software industry

Table 5: Backgrounds of the interview participants.

The interviewees believed that changes in the CSF categorisation reflect current practice in the BI industry. For them, BI development is an ongoing process in which the BI team needs to redevelop the system continuously to remain relevant to business requirements. The first interviewee commented:

*As I mentioned before, BI development phase is an iterative process and it's ongoing all of the time to have a relevant business intelligent system that needs to be responsive to what the users need which means the development phase never really finishes.*

According to the interviewees, because BI development and BI use are intertwined, many CSFs became critical to the success of both phases. In explaining this relationship, apart from arising business requirements, the introduction of new BI technology was mentioned as one key reason. BI technological advancements enable the BI system to deal with more complex data sources and to fulfill requirements that were previously unsolvable. The second interviewee related:

*I think what has occurred is that the technology is much more agile and much more open to being able to attach to different data sources and data sets that put it into that common domain now whereas several years ago. I would say that the approach has changed significantly over the last five to seven years.*

In seeking to explain their opinions on the reasons for changes in the CSF categorisation, two examples were given by the interviewees. First, CSF9 (well-defined information, and system requirements), which was originally categorised as a development phase CSF, is a common CSF because changes in users' information needs require the BI team to continually redefine new information needs and adjust the system accordingly. The first participant contended:

*To me, it's like information system requirement will change over time. It's not like oh I installed a system in 2000 that will go to the end of the world it is not it will be like the requirement of that system, the specification, will always be changing.*

Second, CSF20 (organisational culture) which was classified as a CSF for BI use, was argued by the interviewees to be common to both phases because organisations should have a culture that supports

data management before, during and after the BI system is developed. Without this culture, the BI project will suffer from data quality issues and therefore face the risk of failure. The second interviewee commented:

*Within our environment, data are collected long before it gets used. In the BI area, there needs to be an organisational culture that takes into account the need to inform people that changes need to occur and there needs to be a data stewardship that is implemented across the organisation from a governance perspective.*

In regard to CSF4 (user training), originally classified as common to both phases, the interviewees questioned the need of user training during the development phase because key users need to be involved in the development team from scratch. They often became experts of the BI tool through this involvement and therefore formal training was only necessary for general users when the BI system was deployed. The first interviewee said:

*Users are heavily engaged in all steps in the development so without training the users are getting a good feeling about that tool... In this case, a bunch of super users who are really into that business need are already familiar with the tool.*

According to the interviewees, changes in the CSF categorisation were caused by BI evolution and new BI technologies. For them, these triggers exist in many industries rather than being specific to the healthcare context. The first interviewee contended: *"I would agree much more with CSF changes you got from the survey across multiple industries."*

In discussing benchmarking BI results between healthcare organisation, the interviewees considered this is a distinctive feature of healthcare BI as opposed to general BI. In healthcare sector, sharing information and data is a common practice to help improve clinical and research activities whereas commercial BI systems may find it difficult to exchange BI results which are often of operational and strategic importance. Both interviewees also acknowledged the significance of benchmarking practice to the development of healthcare BI systems in two different ways. First, by benchmarking BI results, users can have visual guidance on what features and functions of the BI systems they would like to have. Second, this practice facilitates knowledge sharing between development teams which improves the performance of the BI project. The interviewees, however, just considered BI benchmarking is an important factor rather than a CSF of healthcare BI as expressed in the first interviewee's comment: *"It may not be a critical success factor but it is one of the factors that you should utilise while developing your BI tool."*

## 5 Discussion and Conclusion

To date, little research has been devoted to exploring the distinction between CSFs for BI development and BI use, although the interaction between success factors across different project stages has been recognised previously. The IS success model of Delone and McLean (2003) is among the most prominent works describing the relationship between success dimensions. In their model, Delone and McLean (2003) argue that "information quality", "system quality" and "service quality" are three separate measures that affect "system use" and "user satisfaction". "Use" and "user satisfaction" are considered to be in an interrelationship in which positive system use will result in user satisfaction and greater satisfaction will encourage users to use the system more frequently. "System use" and "user satisfaction" will bring "net benefits", which, in turn, will affect "system use" and "user satisfaction". In another popular success model of data warehousing systems, Wixom and Watson (2001) argue that implementation success can be measured by organisational, project, and implementation dimensions and these dimensions will affect system quality which will then lead to net benefits. These models, even the consolidated model for BI success of Schieder and Gluchowski (2011), neglected to include the impacts of system use on the success of system implementation success although they acknowledged the influence of implementation success dimensions on system deployment success. The impact of system use on the success of system development was apparent in our data as most of the CSFs were considered critical for both project phases. This intertwined relationship is a result of the evolutionary nature of BI development. Success models for BI projects, therefore, should be updated and validated to recognise the blurred line between system use and system development: the linear development process assumed in models such as Delone and Mclean's may mean that these models do not apply to systems developed through evolutionary processes.

To our knowledge, this was the first research to investigate differences between CSFs of healthcare BI and general BI. The need to research CSFs according to specific industries has been raised since the study of Rockart (1979) and then Leidecker and Bruno (1984). These authors argue that in corporate

management, the success of companies within the same industry is often determined by a small number of similar CSFs. Our research, however, found that CSFs of healthcare BI are similar to general BI and that the list of CSFs from the literature is surprisingly large. Despite the size of the list, participants didn't suggest that any of the CSFs were not, in fact, critical. This finding may suggest that the impact of industrial characteristics can be stronger in the field of corporate management where different industries may result in different sets of CSFs. When it comes to BI implementation and deployment, the impact of organisational, technical, and project management factors become more significant to the success of BI projects. It should be noted that this finding does not necessarily negate the need to consider specific industry characteristics in tailoring BI projects, which, according to Chiasson and Davidson (2005), can influence the implementation or practice, use, and impacts of IT artefacts such as BI systems. Instead, the finding highlights the need to distinguish other important, but perhaps not critical factors from CSFs. In fact, in our research BI benchmarking was considered to have significant impacts on the success of healthcare BI development as it fosters learning process between users, the systems and developers. This learning cycle is a central concept in the iterative and evolutionary development of DSS (Keen 1980). BI benchmarking is a distinctive feature of healthcare BI as a result of the collaborative nature in clinical and research practice between healthcare organisations. Whereas, BI benchmarking is limited in other commercial sectors due to the competitiveness between companies and strategic importance of BI results that are often securely protected. Although BI benchmarking was not considered as a CSF in this research, this factor can affect the success of healthcare BI and therefore worth consideration of healthcare BI practitioners and users when developing their BI systems.

With the research findings, our study has made theoretical contributions to our understanding on CSFs of BI projects in different industries and important implications for BI practice. It has also identified the problematic nature of CSF research in the fact that the integrated list of CSFs identified from the literature is so broad and large. Theoretically, before this study, little research was conducted investigating CSFs for healthcare BI although several studies on CSFs for BI in other industries have been conducted. Our study addressed this research gap by providing evidence that despite the unique characteristics of the healthcare industry, general BI CSFs apply. Our research findings have therefore contributed to CSF research for general BI by verifying it in a new industry. Findings on the distinction between CSFs for BI development and BI use have highlighted the integrated nature of evolutionary BI development and raised questions about assumptions of linear development processes in common IS success models. For BI practice, healthcare organisations that are using or planning to implement BI systems can use our research findings to guide their projects. The verification of the 23 CSFs in healthcare settings can assist BI practitioners in understanding what factors should be managed well and focus their finite resources and efforts to these areas. Our work also alerts BI practitioners that CSFs of BI development may continue to influence the success of BI use and vice versa. Therefore, these factors should be managed well even after the BI systems have been implemented to achieve overall success.

Our findings are of course limited due to the limited number of survey responses. Therefore, our findings are not generalisable in a positivist sense. Rather, they offer insight for directions of future research into IS success models and the problems inherent in CSF studies.

## 6 References

- Arnott, D. 2008. "Success Factors for Data Warehouse and Business Intelligence Systems," *ACIS 2008 Proceedings*, p. 16.
- Arnott, D., and Pervan, G. 2014. "A Critical Analysis of Decision Support Systems Research Revisited: The Rise of Design Science," *Journal of Information Technology* (29:4), pp. 269-293.
- Audzeyeva, A., and Hudson, R. 2016. "How to Get the Most from a Business Intelligence Application During the Post Implementation Phase? Deep Structure Transformation at a Uk Retail Bank," *European Journal of Information Systems* (25:1), pp. 29-46.
- Brooks, P., El-Gayar, O., and Sarnikar, S. 2013. "Towards a Business Intelligence Maturity Model for Healthcare," *System Sciences (HICSS), 2013 46th Hawaii International Conference on: IEEE*, pp. 3807-3816.
- Chiasson, M. W., and Davidson, E. 2005. "Taking Industry Seriously in Information Systems Research," *Mis Quarterly* (29:4), pp. 591-605.
- Clark, T. D., Jones, M. C., and Armstrong, C. P. 2007. "The Dynamic Structure of Management Support Systems: Theory Development, Research Focus, and Direction," *Mis Quarterly* (31:3), pp. 579-615.
- Delone, W. H., and McLean, E. R. 2003. "The Delone and Mclean Model of Information Systems Success: A Ten-Year Update," *Journal of management information systems* (19:4), pp. 9-30.



- Foshay, N., and Kuziemsky, C. 2014. "Towards an Implementation Framework for Business Intelligence in Healthcare," *International Journal of Information Management* (34:1), pp. 20-27.
- Gartner. 2017. "Gartner Says Worldwide Business Intelligence and Analytics Market to Reach \$18.3 Billion in 2017." Retrieved 12 July 2017, from <http://www.gartner.com/newsroom/id/3612617>
- Grubljesic, T., and Jaklic, J. 2015. "Business Intelligence Acceptance: The Prominence of Organizational Factors," *Information Systems Management* (32:4), pp. 299-315.
- Harison, E. 2012. "Critical Success Factors of Business Intelligence System Implementations: Evidence from the Energy Sector," *International Journal of Enterprise Information Systems (IJEIS)* (8:2), pp. 1-13.
- Hawking, P., and Sellitto, C. 2010. "Business Intelligence (Bi) Critical Success Factors," *21st Australian Conference on Information Systems*.
- Isk, O., Jones, M. C., and Sidorova, A. 2013. "Business Intelligence Success: The Roles of Bi Capabilities and Decision Environments," *Information & Management* (50:1), pp. 13-23.
- Keen, P. G. 1980. "Adaptive Design for Decision Support Systems," *ACM SIGOA Newsletter* (1:4-5), pp. 15-25.
- Leidecker, J. K., and Bruno, A. V. 1984. "Identifying and Using Critical Success Factors," *Long range planning* (17:1), pp. 23-32.
- McBride, N. 1997. "The Rise and Fall of an Executive Information System: A Case Study," *Information Systems Journal* (7:4), pp. 277-287.
- Nandhakumar, J. 1996. "Design for Success?: Critical Success Factors in Executive Information Systems Development," *European Journal of Information Systems* (5:1), pp. 62-72.
- Negash, S., and Gray, P. 2008. *Business Intelligence*. Springer Berlin Heidelberg.
- Olbrich, S., Poppelbuß, J., and Niehaves, B. 2012. "Critical Contextual Success Factors for Business Intelligence: A Delphi Study on Their Relevance, Variability, and Controllability," *System Science (HICSS), 2012 45th Hawaii International Conference on IEEE*, pp. 4148-4157.
- Olszak, C. M., and Ziemba, E. 2012. "Critical Success Factors for Implementing Business Intelligence Systems in Small and Medium Enterprises on the Example of Upper Silesia, Poland," *Interdisciplinary Journal of Information, Knowledge, and Management* (7:12), pp. 129-150.
- Poon, P., and Wagner, C. 2001. "Critical Success Factors Revisited: Success and Failure Cases of Information Systems for Senior Executives," *Decision support systems* (30:4), pp. 393-418.
- Presthus, W., Ghinea, G., and Utvik, K.-R. 2012. "The More, the Merrier?: The Interaction of Critical Success Factors in Business Intelligence Implementations," *International Journal of Business Intelligence Research (IJBIR)* (3:2), pp. 34-48.
- Rainer, R. K., and Watson, H. J. 1995. "What Does It Take for Successful Executive Information Systems?," *Decision Support Systems* (14:2), pp. 147-156.
- Remus, U., and Wiener, M. 2010. "A Multi-Method, Holistic Strategy for Researching Critical Success Factors in It Projects," *Information Systems Journal* (20:1), pp. 25-52.
- Rockart, J. 1979. "Chief Executives Define Their Own Information Needs," *Harvard Business Review* (57), pp. 81-93.
- Sangar, A. B., and Iahad, N. B. A. 2013. "Critical Factors That Affect the Success of Business Intelligence Systems (Bis) Implementation in an Organization," *International Journal of scientific & technology research* (12:2), pp. 176-180.
- Schieder, C., and Gluchowski, P. 2011. "Towards a Consolidated Research Model for Understanding Business Intelligence Success," *ECIS*.
- Standing, C., and Cripps, H. 2015. "Critical Success Factors in the Implementation of Electronic Health Records: A Two-Case Comparison," *Systems Research and Behavioral Science* (32:1), pp. 75-85.
- Tremblay, M. C., Hevner, A. R., and Berndt, D. J. 2012. "Design of an Information Volatility Measure for Health Care Decision Making," *Decision Support Systems* (52:2), pp. 331-341.
- Wixom, B., and Watson, H. 2010. "The Bi-Based Organization," *International Journal of Business Intelligence Research* (1:1), pp. 13 - 28.
- Wixom, B., and Watson, H. J. 2001. "An Empirical Investigation of the Factors Affecting Data Warehousing Success," *MIS Quarterly* (25:1), pp. 17-41.
- Wu, J. 2007. "Critical Success Factors for Erp System Implementation," in *Research and Practical Issues of Enterprise Information Systems II*. Springer, pp. 739-745.
- Yeoh, W., and Koronios, A. 2010. "Critical Success Factors for Business Intelligence Systems," *Journal of computer information systems* (50:3), pp. 23-32.

### **Acknowledgment**

We would like to express our gratitude to Bismi Jomon, Business Services Manager, and Annie Gilbert, Applications and Knowledge Management Director, at Alfred Hospital for providing their invaluable insight and expertise to this research. We would also thank Professor Chris Bain for his great support in the data collection process of this research.

**Copyright:** © 2018 Quy Nguyen, Rob Meredith, Frada Burstein. This is an open-access article distributed under the terms of the [Creative Commons Attribution-NonCommercial 3.0 Australia License](https://creativecommons.org/licenses/by-nc/3.0/australia/), which permits non-commercial use, distribution, and reproduction in any medium, provided the original author and ACIS are credited.

## Consumer Perceptions in the Adoption of the Electronic Health Records in Australia: A Pilot Study

### Neethu Mathai

School of Engineering and Information Technology  
Murdoch University  
Perth, Australia  
Email: neethu.mathai@murdoch.edu.au

### Mohd Fairuz Shiratuddin

School of Engineering and Information Technology  
Murdoch University  
Perth, Australia  
Email: f.shiratuddin@murdoch.edu.au

### Ferdous Sohel

School of Engineering and Information Technology  
Murdoch University  
Perth, Australia  
Email: f.sohel@murdoch.edu.au

### Xuequn Wang

School of Engineering and Information Technology  
Murdoch University  
Perth, Australia  
Email: a.wang@murdoch.edu.au

### Abstract

The paper reports an empirical investigation of the factors affecting consumer perceptions of the adoption of Electronic Health Records in Australia. This paper also details the processes involved in the pilot testing of the instrument where it has been pilot-tested to a convenience sample by sending individual postal survey envelopes to shortlisted community organisations in Australia.

Reliability analysis to check the internal consistency was performed using the Cronbach's alpha. Content validity was achieved by reviewing the instrument with a panel of experts. The results of this pilot study proved the feasibility of a full-scale study and these could be used as the basis for refinement of the instrument. Based upon the outcome of validity and reliability testing, items for the final instrument were identified. The findings showed that the tested model does fit the data well and has a significant and positive impact on the consumer's attitude in using the EHR.

**Keywords** consumer perceptions, electronic health record, my health record, pilot study, questionnaire validation

## 1 INTRODUCTION

An Electronic Health Record (EHR) is defined as an electronic version of an individual's medical history and may include all of the key administrative, clinical data including, but not limited to information such as demographics; medications; past medical history; immunizations; laboratory data and radiology reports etc. (Rahman et al. 2015). Australia's EHR system was previously known as the Personally Controlled Electronic Health Record (PCEHR) or eHealth record, and now it is called the My Health Record. Personal electronic health records allow consumers to manage their own healthcare. As such, consumers would have control over the data and access functions of their own health records. Each record potentially contained a summary of a patient's health information and was accessible by both the consumer and any health professional approved for viewing (Torrens et al. 2017).

This paper presents a pilot study which is a work-in-progress of an upcoming full-scale study. In this paper, we present the methods and results of the pilot study; studying the factors affecting consumer perceptions on the adoption of the EHRs in Australia. In this pilot study, responses provided by 48 respondents were gathered. The results were used to improve the measures and conduct primary tests. Specifically, a survey was conducted to assess the feasibility of a full-scale study, and to evaluate the survey based on the participant's understanding and perception of the questionnaire items. Participants were requested to provide their feedback on the survey design, and any suggestions or comments they think would improve the survey. Furthermore, the survey helped us to evaluate the reliability of the instrument and examined the clarity and appropriateness of the questions.

## 2 BACKGROUND

The EHRs has the potential to address many of the challenges currently faced by healthcare systems. A well-designed EHRs could potentially reduce healthcare-related costs, improving its quality and efficiency and, most importantly prevent medical errors (Grana et al. 2015). Analysing whether the currently adopted EHRs improves quality and efficiency has important implications on how best to employ it. The EHRs, when optimally implemented, holds a tremendous potential benefit for the healthcare system, could enhance how patient data are documented, organized, and utilised (Bowman 2013).

A comprehensive analysis of the EHR consumers' perceptions and attitudes are key to a successful implementation. The move to personally controlled health records and changes to the healthcare system have reframed patients as 'consumers', with an assumption that they have a consumer's right to select and choose in the health marketplace and are participants in the development of their e-health record (Cripps et al. 2012). Consumers have an important role to play whereby they hold valuable, first-hand knowledge of what could contribute to the successful employment of an EHRs (McGinn et al. 2011). Examining consumer concerns particularly in the early stages of the EHRs implementation helps in gaining a deeper understanding of consumer views and provide important insights for its development (Andrews et al. 2014).

It is therefore important to find out what are the factors affecting consumer adoption of the EHRs to improve the understanding of how consumers perceive this technology. The main objective of this pilot test is to assess the feasibility and to refine the measures which will be used in the full-scale study exploring the consumer perceptions in the adoption of EHRs in Australia.

## 3 METHODS

The research uses a theoretical framework based on Technology Acceptance Model (TAM) (Davis 1989). The application of TAM in health care context was examined by the study (Holden et al. 2010), and results indicate TAM predicts a substantial portion of the use or acceptance of health IT.

The study includes the core constructs in TAM: namely, Perceived Usefulness, Perceived Ease of Use, Subjective Norms and Attitude. Additional external variables were also adopted- namely, Perceived Health Literacy, Perceived Computer Anxiety, Perceived Self-efficacy and Perceived Barriers. In our study setting, Perceived Usefulness is conceptualised as the extent to which an individual believes that the use of EHRs could enhance their performance and Perceived Ease of Use denotes the degree to which an individual believes that the use of the EHRs will be effortless. Subjective Norms refers to the degree to which an individual perceives that others who are important to them believe they should use EHRs. (Davis 1989; Kim et al. 2017). Perceived Health Literacy can be defined as the degree to which individuals have the capacity to obtain, understand, use and communicate basic health information and services to make appropriate health decisions (Services 2000). Perceived Computer Anxiety expresses

an individual's apprehension or fear when faced with the possibility of using a computer. Perceived Self-efficacy represents the self-evaluation by an individual of their capacity to use EHRs (Compeau et al. 1995; Jian et al. 2012). Demographic factors indicate the socioeconomic characteristics of the individual such as age, gender, education level, income and living area. Perceived Barriers refers to the barrier variables involved in the EHR adoption such as security, privacy and availability of resources.

A survey questionnaire was developed after a thorough review of the literature related to the EHRs. The survey was divided into eight sections. All these sections have a number of questions to evaluate the consumer's perceptions and attitude towards EHRs. The majority of the questions were closed Likert-scaled and categorical questions, although blank spaces for writing comments and suggestions were included at the end of each section. Table 1 shows the sources where the questionnaire items were taken from. Changes to some wording were made so that they are appropriate to fit the EHRs context.

<b>Construct</b>	<b>Questionnaire Sources</b>	<b>Construct</b>	<b>Questionnaire Sources</b>
Perceived Usefulness	(Davis 1989)	Perceived Computer Anxiety	(Heinssen et al. 1987)
Perceived Ease of Use	(Davis 1989)	Perceived Self-efficacy	(Compeau et al. 1995)
Attitude	(Davis 1989)	Perceived Health Literacy	(Noblin et al. 2012)
Subjective Norms	(Davis 1989)	Perceived Barriers	(Miller 2016) (Perera et al. 2011) (Showell 2017)

*Table 1: Sources of the items in the questionnaire*

The questionnaire was reviewed by experts to assess its validity and acceptability, to ensure that the questions were clearly articulated and truly reflected the construct that is intended to be measured. This has not only helped in cross-checking the substantive aspects of the survey, but also improved the overall style of the instrument as well. The final version of the questionnaire was then piloted to assess its reliability. This pilot survey was granted ethics approval from the university's Human Research Ethics Committee. Prospective participants in the pilot survey were restricted to Australian residents aged 18 and above, who have some level of awareness of the EHR system. The survey was entirely voluntary and anonymous.

A list of contacts of community organisations was gathered from the Australian community directory, considering the size and diversity of the organisations and anticipated EHR awareness of people in those locations. Eight shortlisted community organisations in Western Australia, Queensland, New South Wales and Victoria were then contacted by phone for their consent, and once consented, 150 hard copies of the pilot survey materials were then mailed out to them. The pilot survey was opened for two months, and during the survey period, two reminders were made to ensure an acceptable level of response rate.

## 4 STATISTICAL ANALYSIS RESULTS

This section presents the analysis of the results of this pilot study.

### 4.1 Descriptive statistics results

According to (Nulty 2008), the expected response rate for postal surveys is 33.3%. In this pilot survey, 150 surveys were distributed, 48 questionnaires were returned, and 47 questionnaires were treated as "complete" as one of the surveys has missing data in one of the question. Therefore, the effective response rate can be calculated as:

Effective response rate = Total number of complete questionnaires returned / Total number of questionnaires distributed =  $47 / 150 \times 100 \% = 31.33 \%$ .

Data were analysed using SPSS, and descriptive statistics (frequencies) of the data was calculated to describe the basic features of the data in this study. Table 2 shows the characteristics of the respondents of this pilot survey.

Characteristics	N	Characteristics	N
<b>Gender</b>		<b>Gross household income level</b>	
Male	21	Below \$18,200	3
Female	27	\$18,201 – \$37,000	3
<b>Age</b>		\$37,001 – \$87,000	17
18-35 years old	16	\$87,001 – \$180,000	12
36 - 65 years' old	31	\$180,001 and over	-
65 years old and above	1	Prefer not to say	13
Prefer not to say	-	<b>Living area</b>	
<b>Education level</b>		Rural Area	-
Secondary (High) school	1	Regional town/city	24
TAFE education	6	Major city	24
University undergraduate	21	Other (please specify)	-
University postgraduate	18	Prefer not to say	-
Prefer not to say	2		

Table 2: Characteristics of the respondents

Table 3 shows the distribution of the respondents by region/state.

Western Australia	Queensland	New South Wales	Victoria
24	9	10	5

Table 3: Distribution by region/state

## 4.2 Internal consistency analysis

Reliability analysis using Cronbach's alpha was conducted to ensure that the collected data was reliable. An accepted rule of thumb is that an  $\alpha$  value of 0.6-0.7 indicates acceptable reliability, and 0.8 or higher indicates good reliability. Cronbach's alpha is sensitive to the number of items in the scale and is also affected by sample sizes (Cronbach 1951; Voss et al. 2000). The 44-item questionnaire was acceptable to the participants and showed good internal consistency, i.e. with Cronbach's alpha values between 0.62–0.89. The results indicated that seven out of eight measured variables had Cronbach's alpha indicators that exceeded the test value of 0.70. Table 4 presents a summary of the results of the Cronbach's alpha coefficients of each variable.

Variable	Cronbach's Alpha	N	Variable	Cronbach's Alpha	N
Perceived Usefulness	0.857	3	Perceived Computer Anxiety	0.754	2
Perceived Ease of Use	0.884	2	Perceived Self-efficacy	0.618	2
Perceived Health Literacy	0.724	4	Perceived Barriers	0.743	8
Subjective Norms	0.895	3	Attitude	0.862	2

Table 4: A summary of the results of the Cronbach's alpha coefficients of each variable

## 4.3 Regression analysis

Simple linear regression is used to summarize and study the relationships between the variables. Results of the linear regression analysis suggest that Perceived Usefulness ( $\beta=0.70$ ,  $p<0.05$ ), Perceived Ease of Use ( $\beta=0.53$ ,  $p<0.05$ ), Subjective Norms ( $\beta=0.47$ ,  $p<0.05$ ), Perceived Self-efficacy ( $\beta=0.52$ ,  $p<0.05$ ), and Resource Availability ( $\beta=0.32$ ,  $p<0.05$ ) exhibits a statistically significant relationship to the dependent variable Attitude.

Pearson correlation was used to measure the strength of linear association. Results of the Pearson's correlation shows that Perceived Usefulness ( $r_p=0.585$ ,  $p<0.01$ ), Perceived Ease of Use ( $r_p =0.516$ ,  $p<0.01$ ), Subjective Norms ( $r_p =0.472$ ,  $p<0.01$ ), Perceived Self-Efficacy ( $r_p =0.421$ ,  $p<0.01$ ), and Resource availability ( $r_p =0.462$ ,  $p<0.01$ ) have a statistically significant correlation with dependent

variable Attitude while Perceived Health Literacy, Perceived Computer Anxiety, Security and Privacy concerns exhibited no significant correlation with consumers' Attitude in adoption of the EHRs.

#### **4.4 Participants comments and expectations about EHRs**

In this pilot survey, the final section asked for participant's expectations, suggestions or comments about electronic health records adoption. The respondents mainly shared their suggestions and comments on the EHR's usefulness, security and privacy, the need for awareness, and their expectations about EHRs.

Majority of the respondents were positive about the usefulness of health record system and believed it would improve the quality of care; as stated by Participant 29, *"EHR system, would be beneficial to everybody and would definitely help to keep my medical information up-to-date"*. Participant 2 added, *"I think the EHR system is a great idea and would happily use it, provided there are strict and high standards of security for my health information"*. Participant 30 believed and stated, *"Easy to use in the age of computers"*.

Participants expressed strong security and privacy concerns regarding unauthorised access, security and data breaches of the system. For example, participant 35 stated, *"EHR system is a wise idea, but one's personal record should not be leaked"*. Participant 25 supported this point by stating, *"I believe it is a good idea to keep all health records of all citizens but my biggest concern is the security of the personal data"*. Participant 36 stated, *"Recent hacking of internet databases indicate data is not secure. Otherwise, the system will be beneficial"*.

Participants also expressed their concerns regarding the usage of data for secondary purposes. For example, participant 45 stated, *"For me data protection is crucial. Privacy is paramount. There is cancer in my family. Could that stop me from getting insurance? What about a nosy employee?.."*. However, participants trust the government, but doubt the ability to securely protect the information, as stated by participant 7, *"Even though I trust the government, I doubt that the frauds may find a way to access the data and use for improper usage"*.

Participants further indicated EHRs awareness was not sufficient as stated by Participant 44, *"a general awareness of the EHR system is important to the public"*. Participant 47 added by stating, *"more educational awareness; extra training info for seniors"*. Participant 22 added, *"User awareness training should be conducted example through TV advertisement"*. Participant 46 recommended, *"online educational video on how to use EHRs for consumers"*. Participant 22 added, *"Before adopting the EHR system make an awareness of the benefits of using this to the public by conducting community seminar or others"*.

#### **4.5 Feedback about the questionnaire items, data quality and non-response**

In the pilot survey after each section, participants were asked to provide their comments on clarity and understandability of the questionnaire items. They were also asked whether any question they think will be helpful to include in the main survey. Participants responded to most of the survey questions as clear and understandable. One of the improvements suggested in the questionnaire by the respondents was to use the term "Electronic Health Record" instead of just using the 'EHR' abbreviation in the questionnaire to avoid confusions and for better understanding. Another valuable comment raised was to use simple terms in the instructions by removing vague words such as "perceptions" and "perceived" and to make the terms 'health resources' clearer to 'websites/articles/information' in Section B (Perceived Health Literacy). Some participants expressed their concerns about security and privacy and suggested to include more questions on the respective sections. Based on the overall feedback of the participants, relevant changes have made in the questionnaire and a few more questions related to the security and privacy of EHRs have added to the final instrument.

The 'Response Quality' refers to the number of questions answered, item omissions and quality of responses for open-ended questions. In this pilot survey, the average number of questions, respondents left unanswered was very small, i.e., only one missing data. When the average number of questions respondents did not answer is small, this is an indicator of a good quality survey (Couper & Triplett, 1999). This pilot survey also received good quality of responses for open-ended suggestions/comments section. Longer responses to open-ended section would indicate detailed responses, which contributes to the quality of a survey method (Schaefer et al. 1998). Therefore, the 'Response Quality' of this pilot survey can be rated as good as the respondents have given good quality suggestions and detailed comments.

The tendency to non-response was assumed to be affected by the method of conducting this pilot survey via postal mail, and the demographics of the respondents such as age and income level. Based on this

pilot survey results, categories such as older people above 65 years, people from the rural area, and rich people with an income level of \$180,001 and above, have less participation in this survey. It is worth pointing out that every study has its confounding variables and limitations, and the confounding effect cannot be completely avoided (Šimundić 2013).

#### 4.6 Discussion and conclusion

The effectiveness of the EHR system is mainly dependent upon the consumers' acceptance. Acceptance can ultimately contribute to the active and continued use of the EHR system (Hanna et al. 2017). It is likely that the consumers will not adopt or will abandon the EHR if the system does not align closely with their attitudes, and expectations (Greenhalgh et al. 2010). It is therefore important to find out the factors affecting the consumers' attitudes towards the adoption of the EHR.

Conducting and gathering data for this pilot survey was a relatively expensive exercise, but it yielded important information about the feasibility of the main study and the reliability of the instrument. The internal reliability for the direct subscales yielded good values. Findings from this pilot study demonstrate the influence of factors Perceived Usefulness, Perceived Ease of Use, Subjective Norms, Perceived Self-efficacy, and Resource Availability on consumers' Attitude towards the adoption of the EHRs in Australia. These variables exhibit a positive and significant correlation with the dependent variable Attitude. Since the linear regression analysis results show a large  $R^2$  value ( $R^2=63.2\%$ ), it can be concluded that the tested model does fit the data well and confirms that it is feasible and appropriate to conduct the main study on a larger population. Further, the invaluable feedback received in the comments section confirms the importance of the future study.

One of the methodological limitations highlighted by this pilot survey is the difficulty in getting responses from paper-based surveys conducted via postal mail. Postal surveys tend to be resource-intensive in terms of labour and financial investment. Another limitation is in determining internal consistency and correlation given the small sample size. Larger sample size should hypothetically lead to more accurate or representative results. This strengthens the argument of the importance of conducting further reliability in the upcoming main study to determine and confirm the overall psychometric properties of this instrument.

As a significant proportion of the population currently uses electronic technologies, the emerging data collection approach based on the internet is a relatively cost-effective survey alternative which can collect large amounts of data from participants in a short time frame. Similarly, they also seem to be feasible and effective in collecting data on sensitive issues or access to individuals which are hard to reach or in distant locations (Regmi et al. 2016). Further, feedback was also received from the community organisations that helped in recruitment that participants said that would have preferred to respond via an online survey and hence the proposed new study will collect data via an online questionnaire. The target population for this cross-sectional survey will be Australian residents aged 18 and over.

A better understanding of consumer characteristics, attitudes, and beliefs will contribute to the research field and provide valuable insights into the factors that influence the acceptance of, or resistance to the technology. Further, understanding these factors will provide the ability for health educators to design meaningful materials for promoting the adoption of EHRs.

## 5 REFERENCES

- Andrews, L., Gajanayake, R., and Sahama, T. 2014. "The Australian general public's perceptions of having a personally controlled electronic health record (PCEHR)," *International Journal of Medical Informatics* (83:12), pp 889-900.
- Bowman, S. 2013. "Impact of electronic health record systems on information integrity: quality and safety implications," *Perspectives in Health Information Management* (10:Fall).
- Compeau, D. R., and Higgins, C. A. 1995. "Computer self-efficacy: Development of a measure and initial test," *MIS quarterly*, pp 189-211.
- Cripps, H., and Standing, C. 2012. "Building patient trust in electronic health records,").
- Cronbach, L. J. 1951. "Coefficient alpha and the internal structure of tests," *psychometrika* (16:3), pp 297-334.
- Davis, F. D. 1989. "Perceived usefulness, perceived ease of use, and user acceptance of information technology," *MIS quarterly*, pp 319-340.



- Grana, M., and Jackowski, K. 2015. "Electronic health record: A review," *IEEE*, pp 1375–1382.
- Greenhalgh, T., Hinder, S., Stramer, K., Bratan, T., and Russell, J. 2010. "Adoption, non-adoption, and abandonment of a personal electronic health record: case study of HealthSpace," *BMJ* (341).
- Hanna, L., Gill, S. D., Newstead, L., Hawkins, M., and Osborne, R. H. 2017. "Patient perspectives on a personally controlled electronic health record used in regional Australia: 'I can be like my own doctor'," *Health Information Management Journal* (46:1), pp 42-48.
- Heinssen, R. K., Glass, C. R., and Knight, L. A. 1987. "Assessing computer anxiety: Development and validation of the Computer Anxiety Rating Scale," *Computers in Human Behavior* (3:1) 1987/01/01/, pp 49-59.
- Holden, R. J., and Karsh, B.-T. 2010. "The technology acceptance model: its past and its future in health care," *Journal of biomedical informatics* (43:1), pp 159-172.
- Jian, W.-S., Syed-Abdul, S., Sood, S. P., Lee, P., Hsu, M.-H., Ho, C.-H., Li, Y.-C., and Wen, H.-C. 2012. "Factors influencing consumer adoption of USB-based Personal Health Records in Taiwan," *BMC Health Services Research* (12:1), p 277.
- Kim, K. K., Sankar, P., Wilson, M. D., and Haynes, S. C. 2017. "Factors affecting willingness to share electronic health data among California consumers," *BMC Medical Ethics* (18:1), p 25.
- McGinn, C. A., Grenier, S., Duplantie, J., Shaw, N., Sicotte, C., Mathieu, L., Leduc, Y., Légaré, F., and Gagnon, M.-P. 2011. "Comparison of user groups' perspectives of barriers and facilitators to implementing electronic health records: a systematic review," *BMC Medicine* (9) 04/28, 02/09/received, 04/28/accepted, pp 46-46.
- Miller, S. 2016. "Evaluation of the Participation Trials for the My Health Record," *Final Report*. (November).
- Noblin, A. M., Wan, T. T., and Fottler, M. 2012. "The impact of health literacy on a patient's decision to adopt a personal health record," *Perspectives in Health Information Management/AHIMA, American Health Information Management Association* (9:Fall).
- Nulty, D. D. 2008. "The adequacy of response rates to online and paper surveys: what can be done?," *Assessment & evaluation in higher education* (33:3), pp 301-314.
- Perera, G., Holbrook, A., Thabane, L., Foster, G., and Willison, D. J. 2011. "Views on health information sharing and privacy from primary care practices using electronic medical records," *International Journal of Medical Informatics* (80:2) 2011/02/01/, pp 94-101.
- Rahman, R., and Reddy, C. K. 2015. "Electronic Health Records: A Survey," *Healthcare Data Analytics* (36), p 21.
- Regmi, P. R., Waithaka, E., Paudyal, A., Simkhada, P., and Van Teijlingen, E. 2016. "Guide to the design and application of online questionnaire surveys," *Nepal journal of epidemiology* (6:4), p 640.
- Schaefer, D. R., and Dillman, D. A. 1998. "Development of a standard e-mail methodology: Results of an experiment," *Public opinion quarterly*, pp 378-397.
- Services, H. 2000. *Healthy People 2010: Objectives for improving health (Part B: Focus areas 15-28). Appendices*, (US Department of Health and Human Services).
- Showell, C. 2017. "Barriers to the use of personal health records by patients: a structured review," *PeerJ* (5), p e3268.
- Šimundić, A.-M. 2013. "Bias in research," *Biochemia Medica* (23:1) 02/15, 12/10/received, 01/10/accepted, pp 12-15.
- Torrens, E., and Walker, S. M. 2017. "Demographic characteristics of Australian health consumers who were early registrants for opt-in personally controlled electronic health records," *Health Information Management Journal* (46:3), pp 127-133.
- Voss, K. E., Stem, D. E., and Fotopoulos, S. 2000. "A comment on the relationship between coefficient alpha and scale characteristics," *Marketing Letters* (11:2), pp 177-191.

## **Copyright**

Copyright: © 2018 authors. This is an open-access article distributed under the terms of the Creative Commons Attribution-Non-commercial 3.0 Australia License, which permits non-commercial use, distribution, and reproduction in any medium, provided the original author and ACIS are credited.

# Self-Control Matters: Examining Indirect Use of Hospital Information Systems and its Control Mechanisms

## Yujing Xu

Department of Information Systems  
City University of Hong Kong  
Hong Kong, China  
Email: xyujing2-c@my.cityu.edu.hk

## Yu Tong

School of Management  
Zhejiang University  
Zhejiang, China  
Email: tong\_yu@zju.edu.cn

## Stephen Shaoyi Liao

Department of Information Systems  
City University of Hong Kong  
Hong Kong, China  
Email: issliao@cityu.edu.hk

## Abstract

The indirect use of hospital information systems (HIS), that is, the indirect interaction of designated physicians with HIS by delegating HIT-related tasks to others, has become a popular phenomenon in hospitals. Indirect use frees physicians from busywork and helps them achieve improved productivity. However, the agency theory and organization literature indicate that the consequences of indirect use may depart from physicians' expectations because of agency problems. To resolve such challenges, prior work places great emphasis on formal control and social control. Considering the nature of hospital settings, this study proposes that an agent's self-control could also be a prominent control mechanism. To obtain a comprehensive understanding, this study builds a research model that depicts the impacts of three control mechanisms and their interplays on indirect use performance. The proposed methodology and preliminary findings are also discussed to provide insights into how to conduct indirect use efficiently and effectively.

**Keywords:** indirect use, hospital information systems (HIS), self-control, formal control, social control

## 1 Introduction

As a tool to boost administrative efficiency and support patient care, hospital information systems (HIS), which include electronic medical record systems and computerized physician order entry, have become staple applications in physicians' daily work (Black et al. 2011; Hillestad et al. 2005; Kazley and Ozcan 2008; Poon et al. 2010). In hospitals, the indirect use of HIS, that is, the indirect interaction of designated physicians with HIS by delegating HIT-related tasks to others (Xu et al. 2018; Tong et al. 2017; Tong et al. 2015; Kane and Alavi 2008), has become popular. Many physicians, especially those at the senior level, tend to delegate HIS-related tasks (e.g., data entry) to their subordinates or interns. This indirect use behavior can be understood as a form of agency (Eisenhardt 1989), which involves two parties: principal physicians (who are designated users and choose to delegate HIS-related tasks to others) and agent physicians (who perform the HIS-related tasks on behalf of the principal physicians).

The popularity of indirect use among physicians can be understood from the nature of their work. Although the use of HIS effectively promotes service quality and saves cost, it adds to the workload of physicians who are already facing tight work schedules. Furthermore, physicians prioritize their provision of quality service to their patients. Given a heavy workload, physicians cannot allocate sufficient attention to every patient. Indirect use frees principal physicians from busywork and helps them achieve improved productivity (True et al. 2014). Some researchers recognize the importance of the indirect use of HIS in improving the efficiency and quality of care in healthcare organizations (e.g., Tong et al. 2017; Kane and Alavi 2008; Sykes et al. 2011). For example, Kane and Alavi (2008) verified that indirect use could alleviate principals' busy workload and improve quality of care.

Despite the promises, prior literature in agency theory and organization control indicate that agent behavior may depart from a principal's expectations due to goal conflict and information asymmetry between the two parties (Eisenhardt 1985, 1989; Friedkin 1983; Ouchi and Maguire 1975). The indirect use of HIS, if not managed properly, may also introduce problems to principal physicians. For example, an agent physician's attitude toward the indirect use of HIS may be totally different from that of the principal physician because the agent must bear extra work and delegation could prevent the agent from accomplishing tasks at his/her own pace. Such a conflict has a possible negative effect on the indirect use of HIS. To resolve such challenges, prior work on the principal-agent relationship places great emphasis on two control mechanisms conducted by principals, namely, formal control and social control. Formal control is a control mechanism usually supported by organizational rules that authorizes the principal to monitor the agent's behavior or verify the outcome (Jaworski 1988). Social control engenders a close tie between the principal and the agent through trust and shared norms and values (Li et al. 2010; Poppo and Zenger 2002). Although these two control mechanisms are pivotal, as suggested by the literature, this study posits that the nature of the hospital setting could weaken their effectiveness. Specifically, given that agent physicians are usually junior physicians who are required to periodically rotate between different medical units/hospitals, principal physicians cannot physically establish a stable relationship with and effectively implement control over the same agent physicians.

Under such circumstances, this study proposes that an agent physician's self-control could be a prominent control mechanism. Different from formal control and social control, self-control is conducted by the agent to adjust inappropriate behavior by establishing individual goals and monitoring what has been achieved (Jaworski 1988; Kirsch 1996). This type of control mechanism has not been a major focus in the literature (Thaler and Shefrin 1981). Few studies examine the impact of self-control from the agents' perspective. To obtain a comprehensive understanding of control mechanisms for physicians' indirect use of HIS, this paper proposes a research model that depicts the impacts of three control mechanisms and their interplays on indirect HIS use performance. To evaluate the research model, this study is in the process of conducting a multi-method study in a hospital. This project aims to provide insights into how to perform indirect use efficiently and effectively.

## 2 Theoretical Background and Hypotheses Development

### 2.1 Control Mechanisms

The core issue in delegation is the principal-agent relationship (Holmstrom and Milgrom 1991). Austin (2001) generalized the central problem in an agency relationship as how to motivate the agent to behave in the interest of the principal. Control mechanisms can direct the principal and agent's cooperation by regulating the agent's behavior, which greatly influences the success of indirect HIS use (Fryxell et al. 2002). Choosing effective control mechanisms is needed when managing the relationship between the principal and the agent (Jap and Ganesan 2000). The literature on agency theory and organization

control focus on two dominant categories of control mechanisms, namely, formal control and social control. Hence, little attention has been paid to self-control.

Formal control is a written, management-initiated mechanism by which the probability that the agent behaves in the interest of the principal will be affected (Jaworski 1988). By relying on formal control, the individual principal can monitor, direct, and evaluate what the agent has done (Anderson and Oliver 1987). However, formal control is associated with the authority of the principal and a long-term relationship between the principal and the agent. Therefore, it may be not effective in the healthcare work context because of the high mobility of medical teams.

Unlike formal control, social control may not be supportive of the stated organization objectives (Jaworski 1988). This type of control is localized to the work unit, that is, a medical team in a hospital. Two different views about social control can be found in previous studies. Social control engenders a close tie between the principal and the agent. However, social control is realized by slow accumulation. Moreover, the high mobility of medical teams cannot guarantee the long-term trust between the principal and the agent.

Self-control in which individuals set their own goals, are intrinsically motivated to complete their tasks to achieve their objectives, and evaluate their final performance as work progresses (Kirsch and Cummings 1996). The source of self-control is an individual's intrinsic motivation. Hwang (2005) and Malhotra (2002) claimed that self-control is based on the individual's intrinsic motivation of perceived enjoyment. In other words, the extent to which helping principals accomplish HIS-related tasks is perceived to be enjoyable and pleasant in agents' own right, apart from the instrumental value of the delegation. In the IS literature, self-control and its intrinsic motivation have been suggested as effective interventions to enhance system adoption (Malhotra and Murnighan 2002; Venkatesh and Davis 2000). Owing to its advantages in confining individuals' inappropriate behavior, self-control is associated with positive managerial practices, such as improved satisfaction or performance (Hwang 2005; Kirsch and Cummings 1996). For example, Venkatesh (1999) reported that the game-based training method, which enhances intrinsic motivation (self-control), has higher user satisfaction than the traditional training method does.

Given that many key relationships in the IS use context are not governed by formal organizational mechanisms, Kirsch (1996) argued that a balance exists between autonomous self-control and other control modes. For example, self-control is dependent on the extent to which outcomes are measurable and on the level of the principals' knowledge about direct system use. Thus, self-control and formal and social control have a non-substitutive relationship, and they interact with each other. Specifically, additional behavior observability and outcome measurability may have a negative interactive effect on self-control. This situation is caused by the agent's perception of restrictions. By contrast, agents who have much discretion or freedom in managing delegated tasks are more likely to use self-control and have better achievement than those who have less (Manz and Angle 1986).

## **2.2 Hypotheses Development**

Based on the phenomenon of indirect use of HIS in hospital, we propose the hypotheses.

### **2.2.1 Impact of Self-control on Indirect HIS Use Performance**

Agents' behavior related to delegated tasks may be self-determined, controlled, or motivated (Hwang 2005). Self-determination theory (Deci and Ryan 1985) indicates that developing an elaborate and unified sense of self is a natural and innate appeal for individuals. Self-control focuses on how agents regulate their own actions by developing a coherent sense of oneself. Self-control is associated with positive managerial practices, such as improved satisfaction or performance (Hwang 2005; Kirsch and Cummings 1996).

For agent physicians who perform the delegated HIS-related tasks with self-control, they themselves are the controllers. They believe that accomplishing these tasks is enjoyable and pleasant; thus, they set personal goals and monitor how well they have done over time and intrinsically reward themselves for completing the job. This type of control mechanism is different from formal organizational control mechanisms or professional norms. The agents commit to these tasks and achieve an improved performance in terms of effectiveness and efficiency, thereby finally contributing to the principals' indirect use of HIS. Obviously,

*H1: Self-control is positively associated with indirect HIS use performance.*

## 2.2.2 Comparison between Self-control and Other Control Mechanisms

Based on agency theory and organization control theory, formal and social control can bridge the gap between the principal and the agent in terms of goal conflict and information asymmetry (Eisenhardt 1989; Ouchi and Maguire 1975). Formal control restricts the inappropriate behavior of agents with HIS-related tasks by verifying the outcome or monitoring and directing their behavior (Anderson and Oliver 1987). Social control organizes agents' behavior through relationship governance or socialization (Jaworski 1988; Poppo and Zenger 2002).

Principal physicians delegate HIS-related tasks to agent physicians, who are also usually in the same medical team. Although previous studies have confirmed that formal and social control used by principals can ensure that agents behave in the interest of the principals to a certain degree (Celly and Frazier 1996; Li et al. 2010; Lui 2009), both control mechanisms are subject to the high mobility of the healthcare work context. They depend on the relationship between principal physicians and agent physicians. In addition, formal control relies on the authority of principal physicians supported by stated organizational rules and objectives. Under this circumstance, high mobility weakens their usefulness. At the same time, because self-control is a function of agents' own intrinsic motivation, it cannot be affected by medical teams' mobility and principals' characteristics. On this occasion, agents' self-control seems increasingly useful in ensuring that agent physicians behave correctly due to its advantages in confined inconformity. As a result, the following hypotheses can be derived.

*H2: Formal control is positively associated with indirect HIS use performance.*

*H2b: Self-control is more positively associated with indirect HIS use performance than formal control is.*

*H3: Social control is positively associated with indirect HIS use performance.*

*H3b: Self-control is more positively associated with indirect HIS use performance than social control is.*

## 2.2.3 Moderating Effect of Formal Control and Social Control

Self-control, formal control, and social control share a non-substitutive relationship (Kirsch 1996; Kirsch and Cummings 1996). For example, social control may enhance the extent of self-control due to the trust perceived by agent physicians from principal physicians (Lui 2009). Enhanced self-control leads to an improved performance of agent physicians in delegated tasks. Thus, social control mechanisms may positively moderate the effect of self-control on indirect HIS use.

In addition, Manz and Angle (1986) suggested that self-control in a discretionary and free environment can lead to improved achievement. Therefore, the high level of behavior and outcome observability (formal control) suggest that principal physicians closely supervise agent physicians, thereby resulting in little freedom for agent physicians to manage delegated HIS-related tasks. In turn, this process reduces the impact of self-control on the indirect use of HIS. By contrast, social control provides agents additional autonomy to handle the work. An agent who has much discretion or freedom in managing delegated tasks is likely to use self-control and attain considerable achievements. Under such an environment, agent physicians can work at their own pace. In addition, the intrinsic motivation of enjoyment makes agent physicians actively engage in delegated HIS-related tasks. Specifically, the following hypotheses are derived.

*H4: Formal control negatively moderates the relationship between self-control and indirect HIS use performance.*

*H5: Social control positively moderates the relationship between self-control and indirect HIS use performance.*

## 3 Proposed Methodology and Preliminary Findings

The indirect use of HIS reflects a complex activity of physicians within the context and environment of a hospital. To investigate this phenomenon and evaluate the proposed hypotheses, this study is now in the process of refining the research model through a case study that follows the sequential multi-method research approach (Mingers 2001). Qualitative data collected from physicians can provide a full understanding of the research context. Furthermore, a case study can disclose information about the reasoning behind the different effects of control mechanisms on indirect HIS use performance. Then, a contextualized research model will be formulated on the basis of the analysis of the case study. A

positivist approach will then be employed to form a substantial and systematic view of the indirect use of HIS.

A large public general hospital in China with approximately 2,000 physicians is selected for this study. In this hospital, physicians directly interact with the HIS and indirectly interact with it by delegating some HIS-related tasks to their subordinates or colleagues. The choice of a single hospital enables us to detect individual-level effects and avoid inter-hospital differences.

The qualitative data will be collected in two to three months. The data gathering techniques used include onsite observations and interviews with IS professionals and 10-dyad physicians, who are principal physicians and agent physicians, respectively. As a first step in data collection, 10 physicians, including five principal physicians and five agent physicians from different departments, have been interviewed. The interview began with questions related to their basic information, such as their age, position, and job description. Then, for the principal physicians, questions about their direct and indirect use of HIS and the control mechanisms they used were asked; For the agent physicians, questions about how they help the principal physicians accomplish HIS-related tasks and how the control mechanisms guide their behavior were asked. The interviews were open-ended and interactive. The interviewees were prompted to answer by using examples, especially for points relevant to our focus. Each interview lasted 30 minutes to 1 hour.

No.	Department	Sex	Position	Role in indirect use	Code	Quote
1	Oncology	F	Associate Chief Physician	Principal	<ul style="list-style-type: none"> <li>Attitude towards indirect use</li> <li>Self-control</li> </ul>	<p>It (indirect use) eased me of my burden, and I have more time to deal with things that only senior physician can do.</p> <p>...rely on their autonomy.</p>
2	Oncology	F	Resident Physician	Principal	<ul style="list-style-type: none"> <li>Attitude towards indirect use</li> <li>Self-control</li> </ul>	<p>As the principal: new interns are not familiar with the systems... sometimes they did bad...but after my training, they do better can help me a lot.</p> <p>As the agent: it (indirect use) is my duty.</p> <p>Of course, self-control is the most important thing.</p>
3	Orthopaedics	M	Intern	Agent	<ul style="list-style-type: none"> <li>Attitude towards indirect use</li> </ul>	<p>... (Data entry) it is a waste of time, I can learn little from it.</p>

*Table 1. Example of Quotes for Codes*

The transcribed interview data were first organized and coded on the basis of this set of themes. Sample quotes from these interviews are listed in Table 1. Through a preliminary analysis of these qualitative data, we identified some important findings. To guarantee the reliability of the findings, we made sure that each finding was supported by at least two sources (Klein and Myers 1999). We moved back and forth between data, theoretical lenses, and the refined model until “theoretical saturation” was reached, at which point the incremental improvement of the model was minimal and comprehensively explaining the findings of the qualitative data was possible.

First, we find that indirect HIS use behavior is popular and that it has even become a norm among physicians. On the basis of the dialogues with physicians, the reasons that lead to the indirect use of HIS can be summarized into four categories.

- To free oneself from busy workload
- To guide junior physicians and interns in performing treatment by using HIS
- For those who have limited computer literacy, indirect use improves work efficiency and avoids embarrassment
- For those who value hierarchies, the right to delegate HIS-related tasks makes them feel identified

This study will mainly focus on the first two categories because they account for the most proportion of indirect use of HIS in the target hospital.

Second, the indirect use of HIS liberates principal physicians from a heavy workload, thereby allowing them to concentrate on patient treatment operation and improve their productivity to a certain degree. For example, an agent physician told us that his supervisory physician needed more than three hours to prepare medical records without his help.

In terms of control mechanisms, we observe a non-substitutive relationship among the three control mechanisms. Three of the five principal physicians mentioned that they would use some of the three control mechanisms at the same time. However, a junior principal physician claimed that whether indirect use is helpful depends on the task type. Furthermore, approximately 90% of the interviewees admitted or emphasized the significant effect of self-control. This finding is consistent with our hypotheses. All agent physicians agreed with our argument that the trust of principal physicians would enhance their self-control performance. However, when referring to the attitude toward delegation, the male and female participants expressed different feelings distinctly. Thus, we will consider sex a control variable in the following study.

In the future, additional qualitative data will be collected from principal physicians and agent physicians in departments that we have yet to address in the target hospital to enrich our findings and further modify our proposed research model. Then, to verify the proposed refined model, we will conduct a survey in the same hospital. We will also design two different questionnaires for principal physicians and agent physicians. Items from our previous study will be revised to correspond to our research context. Specifically, the proposed model will help us form a comprehensive picture of indirect use and its control mechanism.

## 4 Expected Contribution

This study is one of the early attempts to theoretically study the effects of different control mechanisms and their interplays on indirect HIS use performance. Therefore, this study has implications for both theory and practice. Theoretically, this study hopes to advance the current understanding of indirect HIS use in terms of different control mechanisms. The literature on indirect use by IS centrality ignores the goal conflict and information asymmetry between principal physicians and agent physicians. Thus, we must study different control mechanisms that can govern agent physicians' behavior. Additionally, the literature on agency theory and organization control primarily focus on formal control and social control. By contrast, the high mobility of healthcare work weakens the effects of these two dominant control mechanisms. Meanwhile, the advantage of self-control in bounding an individual's own behavior is one of our focuses. By incorporating self-control to examine indirect HIS use, this study effectively supplements the agency literature.

Furthermore, this study offers important implications for practitioners. First, this study illustrates different control mechanisms in aligning the agent's behavior and emphasizes the pivotal role of self-control in the healthcare work context. By using appropriate control mechanisms when delegating HIS-related tasks to others, principal physicians can enjoy improved performance. In addition, an improved understanding of indirect HIS use and its different control mechanisms can help principal and agent physicians in making long-term plans. In sum, this study will provide valuable knowledge for healthcare shareholders to understand how to employ HIS effectively and efficiently through indirect use.

## 5 References

- Anderson, E., R.L. Oliver. 1987. "Perspectives on Behavior-Based Versus Outcome-Based Salesforce Control Systems," *Journal of Marketing* (51:4), pp. 76-88.
- Austin, R.D. 2001. "The Effects of Time Pressure on Quality in Software Development: An Agency Model," *Information Systems Research* (12:2), pp. 195.



- Black, A.D., J. Car, C. Pagliari, C. Anandan, K. Cresswell, T. Bokun, B. McKinstry, R. Procter, A. Majeed, A. Sheikh. 2011. "The Impact of eHealth on the Quality and Safety of Health Care: A Systematic Overview," *PLoS Medicine* (8:1), pp. 1-16.
- Celly, K.S., G.L. Frazier. 1996. "Outcome-based and behavior-based coordination efforts in channel relationships," *Journal of marketing research*, pp. 200-210.
- Deci, E.L., R.M. Ryan. 1985. *Intrinsic motivation and self-determination in human behavior*. Springer Science & Business Media.
- Eisenhardt, K.M. 1985. "Control: Organizational and Economic Approaches," *Management Science* (31:2), pp. 134-149.
- Eisenhardt, K.M. 1989. "Agency Theory: An Assessment and Review," *The Academy of Management Review* (14:1), pp. 57-74.
- Friedkin, N.E. 1983. "Horizons of observability and limits of informal control in organizations," *Social Forces* (62:1), pp. 54-77.
- Fryxell, G.E., R.S. Dooley, M. Vryza. 2002. "After the ink dries: the interaction of trust and control in US - based international joint ventures," *Journal of Management Studies* (39:6), pp. 865-886.
- Hillestad, R., J. Bigelow, A. Bower, F. Girosi, R. Meili, R. Scoville, R. Taylor. 2005. "Can Electronic Medical Record Systems Transform Health Care? Potential Health Benefits, Savings, And Costs," *Health Affairs* (24:5), pp. 1103-1117.
- Holmstrom, B., P. Milgrom. 1991. "Multitask principal-agent analyses: Incentive contracts, asset ownership, and job design," *Journal of Law, Economics, & Organization*, pp. 24-52.
- Hwang, Y. 2005. "Investigating enterprise systems adoption: uncertainty avoidance, intrinsic motivation, and the technology acceptance model," *European Journal of Information Systems* (14:2), pp. 150-161.
- Jap, S.D., S. Ganesan. 2000. "Control mechanisms and the relationship life cycle: Implications for safeguarding specific investments and developing commitment," *Journal of marketing research* (37:2), pp. 227-245.
- Jaworski, B.J. 1988. "Toward a Theory of Marketing Control: Environmental Context, Control Types, and Consequences," *Journal of Marketing* (52:3), pp. 23-39.
- Kane, G.C., M. Alavi. 2008. "Casting the Net: A Multimodal Network Perspective on User-System Interactions," *Information Systems Research* (19:3), pp. 253-272.
- Kazley, A.S., Y.A. Ozcan. 2008. "Do Hospitals With Electronic Medical Records (EMRs) Provide Higher Quality Care?: An Examination of Three Clinical Conditions," *Medical Care Research and Review* (65:4), pp. 496-513.
- Kirsch, L.J. 1996. "The Management of Complex Tasks in Organizations: Controlling the Systems Development Process," *Organization Science* (7:1), pp. 1-21.
- Kirsch, L.J., L.L. Cummings. 1996. "Contextual influences on self-control of is professionals engaged in systems development," *Accounting, Management and Information Technologies* (6:3), pp. 191-219.
- Li, Y., E. Xie, H.-H. Teo, M.W. Peng. 2010. "Formal control and social control in domestic and international buyer-supplier relationships", *Journal of Operations Management* (28:4), pp. 333-344.
- Lui, S.S. 2009. "The Roles of Competence Trust, Formal Contract, and Time Horizon in Interorganizational Learning," *Organization Studies* (30:4), pp. 333-353.
- Malhotra, D., J.K. Murnighan. 2002. "The Effects of Contracts on Interpersonal Trust," *Administrative Science Quarterly* (47:3), pp. 534-559.
- Malhotra, Y. 2002. "Is knowledge management really an oxymoron? Unraveling the role of organizational controls in knowledge management" *Knowledge mapping and management*, pp. 1-13.
- Manz, C.C., H. Angle. 1986. "Can group self-management mean a loss of personal control: Triangulating a paradox," *Group & Organization Management* (11:4), pp. 309-334.

- Mingers, J. 2001. "Combining IS research methods: towards a pluralist methodology," *Information systems research* (12:3), pp. 240-259.
- Ouchi William, G. 1979. "A Conceptual Framework for the Design of Organizational Control Mechanism," *Management Science* (25:9), pp. 833-848.
- Poon, E.G., A. Wright, S.R. Simon, C.A. Jenter, R. Kaushal, L.A. Volk, P.D. Cleary, J.A. Singer, A.Z. Tumolo, D.W. Bates. 2010. "Relationship Between Use of Electronic Health Record Features and Health Care Quality: Results of a Statewide Survey," *Medical Care* (48:3), pp. 203-209.
- Poppo, L., T. Zenger. 2002. "Do formal contracts and relational governance function as substitutes or complements?" *Strategic management journal* (23:8), pp. 707-725.
- Sykes, T.A., V. Venkatesh, A. Rai. 2011. "Explaining physicians' use of EMR systems and performance in the shakedown phase," *Journal of the American Medical Informatics Association* (18:2), pp. 125-130.
- Thaler, R.H., H.M. Shefrin. 1981. "An Economic Theory of Self-Control," *Journal of Political Economy* (89:2), pp. 392-406.
- Tong, Y., H.-H. Teo, C.-H. Tan. 2008. "Direct and Indirect Use of Information Systems in Organizations: An Empirical Investigation of System Usage in a Public Hospital". *ICIS 2008 Proceedings*, pp. 138.
- Tong, Y. C.-H. Tan, H.-H. Teo. 2017. "Direct and Indirect Information System Use: A Multimethod Exploration of Social Power Antecedents in Healthcare ". *Information System Research*.
- True, G., G.L. Stewart, M. Lampman, M. Pelak, S.L. Solimeo. 2014. "Teamwork and delegation in medical homes: primary care staff perspectives in the Veterans Health Administration," *Journal of general internal medicine* (29:2), pp. 632-639.
- Venkatesh, V. 1999. "Creation of favorable user perceptions: exploring the role of intrinsic motivation," *MIS quarterly*, pp. 239-260.
- Venkatesh, V., F.D. Davis. 2000. "A theoretical extension of the technology acceptance model: Four longitudinal field studies," *Management science* (46:2), pp. 186-204.
- Xu, Y., Tong, Y., Shaoyi S, Liao, Zhou, G., Yu, Y. 2018. "Understanding indirect system use of junior employees in the context of healthcare," *Information & management*, vol. 55, no. 6, pp. 759-770.

## Acknowledgements

This work was supported by the National Natural Science Foundation of China (grant numbers 71502155); and the development grant from Shenzhen Science, Technology and Innovation Commission (grant number JCYJ20160229165300897).

## Copyright

**Copyright:** © 2018 authors. This is an open-access article distributed under the terms of the [Creative Commons Attribution-NonCommercial 3.0 Australia License](https://creativecommons.org/licenses/by-nc/3.0/), which permits non-commercial use, distribution, and reproduction in any medium, provided the original author and ACIS are credited.

# **Engagement Leading to Empowerment-Digital Innovation Strategies for Patient Care Continuity**

## **Mohan Tanniru**

Senior Investigator  
Henry Ford Health System  
Detroit, MI, USA  
Email: mrtanniru@gmail.com

## **Kamaljeet Sandhu**

Senior Lecturer  
UNE Business School  
University of New England  
Armidale, NSW. Australia  
Email: ksandhu@une.edu.au

## **Abstract**

Digital innovations have started to extend the value chain into the customer decision making process, enabling firms to support two major types of customer services: empowerment prior to customer purchase and engagement during and post-purchase. Service organizations such as health care firms, by virtue of their intense engagement with patients during in-patient care, have a unique opportunity to empower patients' health care choices once they become outpatients. Understanding patient ecosystems and social support networks during this engagement has important implications for the digital transformation of care-related support to reduce health care costs and also empower patients to self-manage their health. This research uses a framework to develop alternative care support environments and, using four case studies, to develop a research agenda for digital transformation to support the empowerment of health care consumers by engaging them effectively inside the hospital.

**Keywords:** Continuity of Patient Care, Engagement and Empowerment Services, Digital Transformation, Health IT

# 1 Introduction

Digitisation has advanced the business value chain into customer decision making and has made the transformation of businesses to meet evolving customer expectations a competitive necessity for innovation. The evolving service technology innovation landscape, which influences customers' desire to search, select, purchase, and continually assess their decisions post-purchase, has started to make it essential for businesses to understand customer decision perceptions (Sandhu 2012, 2011). The rapid design and delivery of digital services in support of business transformation to create sustained business value has become an important priority (Sandhu & Corbitt 2003). The need of businesses for speed (Bossart et al, 2013) and agility in the use of internal and external resources to create value through innovative “services” has been the major premise of service dominant logic (Lusch & Nambisan, 2015).

For discussions in this paper, we will use Figure 1 to classify “services” using customer decision making as the anchor. The empowerment services are designed to make customers aware (intelligence phases) of what businesses have to offer and support their decision making to purchase the product/service (design and choice phases) (Simon, 1947). The engagement services include activities involved in the actual purchase and “use” of the product/service purchased. These empowerment and engagement services are in turn supported by the business value chain (Porter, 1985). We classify these as customer interfacing activities (primary and support activities, such as marketing, sales, distribution, and service after sale used to interact and engage customers) and business operations (all other activities, including the supply chain, to support customer interfacing activities).

The digital transformation challenge for businesses today is to transform business operations with speed and agility. The speed is needed for faster alignment of business operations with customer decision making as businesses empower customers to evaluate offers made and engage them to meet their expectations during purchase and post-purchase. Agility allows adaptation of business operations with customer decision making as businesses empower customers to explore product/service configuration options prior to purchase and engage them during purchase and post-purchase if expectations change. In other words, businesses must adapt the (technical) design and (business) delivery of (digital) services to empower and engage customers through their evolving customer journeys.

<b>Engagement</b> Action (during use) Action (during purchase)	Support purchase and post-purchase use	Align operations and supply chain for sale & retention
<b>Empowerment</b> Design/Choice Intelligence	Support customer decision making	Align operations and supply chain for competitive offer
	<b>Customer Interfacing</b> Marketing, outbound logistics, sales, (service) + Support Activities	<b>Business operations</b> Operations, inbound logistics + Support Activities

Figure 1. Services Developed to Support Customer Decision-Making and Action

Businesses use remote monitoring technologies, surveys, reviews on blogs, and discussion boards to learn about customer decision journeys during the “use” cycle of engagement to improve the “empowerment” services of customers. The longer the “use” cycle, the more opportunity there is to gather information about the customer journey after purchase and to influence their future decision journey in the purchase of the next product/service. In other words, digital strategies today use the analysis of engagement services currently being used to transform the design and delivery of empowerment services to support future sales and use. In general, service firms have a shorter use cycle (e.g. restaurants, travel, entertainment services, etc.), and, in many cases, the purchase and use cycles are intermingled. For shorter “use” cycles, digital strategies must effectively combine the design and delivery of engagement services (i.e. the automation of activities related to “customer interfacing” and “business operations”) to influence their empowerment services that will lead to sales.

Health care transformations poses a particular challenge. Except in cases when repeat customer purchase of health care services is involved (e.g. dental, eye care etc.), engagement services in health care do not, and in some cases should not, lead to repeat business (as in the case of “unanticipated” readmission of patients for the same illness). Secondly, while effective engagement services can increase patient and physician satisfaction for future referrals, these engagement services extend the health care

organization's boundary and include many external factors such as patient ecosystem and players such as other care providers, which are not under the control of the organization. In other words, to even reap the benefits of reduced readmission costs and potentially good reviews of patient care quality, digital strategies to support patient engagement require the transformation of patient care inside to outside the hospital. There is a need for a systematic evaluation of the patient journey during the engagement phase to help health care organizations develop digital transformation strategies that will improve patient well-being and reduce overall health care costs. This is the goal of this research.

The paper is organized as follows. The next section provides a context for the study. Section Three develops a framework to understand the patient journey post-discharge using four case studies and the role various stakeholders play in the digital transformation of this journey. Section Four identifies select digital strategies hospitals can use to support digital transformation of the extended value chain of the hospital. The last section provides concluding comments and a research agenda for the future.

## **2 Digital Transformation in Hospitals**

Health care customers can be in multiple states: *healthy state*, *health maintenance state*, *health-monitoring state* (e.g. chronic conditions), and *patient state*. A customer can move from a healthy state to a health maintenance state if certain health conditions, such as high blood pressure, high cholesterol, obesity, etc. are identified as sources for future complications. The health maintenance state, if not supported effectively, can lead to more serious health conditions that may require a continual health monitoring state (e.g. diabetes type 1 or 2, heart condition, or other chronic conditions). When a health care consumer comes to a hospital, he or she is in a "patient" state seeking care related inpatient services. A customer can move from a patient state to any other state once discharged.

Independent of how a customer's journey led him/her to a patient state, we will focus on what happens to this patient once they are in the hospital. Digital transformations in hospitals have focused on addressing care quality and patient engagement in different care units within the hospital, besides the use of electronic medical records to support patient data sharing by clinical and administrative personnel. Some have focused on leveraging advanced technologies to track patient flows in ED to reduce delays and improve patient and nurse/physician communication (Burke et al. 2004), to optimally allocate operating rooms for surgeries using data analytics (Raghupathi and Raghupathi 2014), and to reduce patient falls, hospital acquired infections, etc. in patient rooms (Weiner, et al, 2016). Besides digital transformations, several process innovations were used to improve patient engagement (Fowler et el 2018).

Given the importance of patient engagement in care processes post-discharge, prior research (Kripalani et al. 2013) has identified nine discharge services. Some of these need hospital engagement with patients in patient rooms, while others require the engagement of external care providers. The next section will discuss four case studies that illustrate varied engagements between hospitals and external care providers in order to understand the patient journey complexities.

## **3 Extending Engagement Post Discharge**

In this section, we will illustrate four different case scenarios to understand the complexity of digital transformation of patient engagement once a patient leaves the hospital.

### **Case study 1: RSVP System**

RSVP stands for the Remote Specialist Visiting Physicians program (RSVP, 2016). External care coordinators recruited from the local fire department—emergency medical technicians (EMTs)—visited patients as a follow-up and engaged in a two-way consultation with physicians using video conferencing technology (e.g. SwyMed Telemedicine). In addition, the hospital partnered with Vivify Health, which provides a kit to help patients monitor their vital signs and consult with a hospitalist at the hospital as needed. The program's goal is to stop the escalation of illnesses and reduce unnecessary hospital readmissions. The success of the pilot effort in reducing readmissions led the hospital to extend it to other patients in other regions. The engagement here includes patients in a supportive ecosystem (patients living at home).

### **Case study 2: Physician/Nurse Intervention**

In this case, the hospital uses a team of a physician and advanced nurse practitioner to coordinate the care of cardiac patients who are discharged to a nursing home (Jones et al, 2013). The program started in March 2011, and the frequent personal visits of either or both of the team members to the nursing home helped educate the nursing home staff on what symptoms to look for when a patient is in an agitated state. The nursing staff can use the team for consultation over the phone or in person to address the situation at the nursing home itself, rather than send them to the ED. The intervention led to a reduction in readmissions and is being expanded to other nursing homes in Michigan, with the expectation that tele-health monitoring devices and mobile apps can help support the increased scale of the patient/care staff engagement. This represents the engagement of patients in a less-supportive ecosystem (i.e. people in need of care outside their home) and who need continual health monitoring.

### Case study 3: Social worker engagement

Recognizing the impact of socioeconomic status on diabetes, the Mobile Health Program in Seattle, managed by the Global to Local [GlobalToLocal] organization, recruited a number of health care consumers after they visited a hospital. The aim was to ensure that these patients maintain their health condition or potentially improve it, but not suffer deterioration. The community that was selected experiences significantly higher rates of poverty and premature death, has many immigrants and refugees, and faces multiple barriers to accessing health care and navigating care related practices and systems. The study has provided iPhones and has allowed patients to participate in customized healthy cooking classes once a month, taught by a nutritionist. In addition, the patients interacted with their case manager (CHW) via reports sent from an iPhone-compatible application that tracked blood sugar levels, nutrition, and exercise. This case illustrates how to engage health care consumers in a less supportive ecosystem, maintain their health, and empower them with education and mentoring.

### Case study 4: Self-health management

Several seniors at a community centre for the elderly in Michigan were interviewed to assess their health maintenance needs (Bhatia, 2017). While many have identified ways to get care related alerts contextually (when they are watching television or interacting with others socially), they expressed the desire to use technology to allow their family members to participate in their care and related activities to reduce stress (e.g. that caused by a car not working or heating system failures) and loneliness. This illustrates the case of health care consumers in a supportive ecosystem needing support from family and friends to maintain their health. These four cases summarize four different types of engagement as shown in Figure 2.

Supportive eco-system	Awareness and Empowerment w/Technology Q3	Awareness and Empowerment with External Care Providers w/Technology Q4
	Awareness and Empowerment of Social Network w/Technology Q1	Awareness and Empowerment with External Care Providers and Social Network w/Technology Q2
	Health maintenance (& Healthy) State	Health monitoring state

Figure 2. Strategies for Engagement

Quadrant 2 engages health care consumers at nursing homes to monitor their health using a mix of health care providers and nursing facility personnel, while Quadrant 1 engages health care consumers needing health care maintenance using social workers and community members. The RSVP system was designed to support health monitoring of health care consumers using a mix of physicians and other community care providers (Quadrant 4), while seniors living at home need to maintain their health using reminders and stress reducing activities (Quadrant 3). The next section will discuss the role of the ecosystem and care management grid (shown in Figure 2) to help develop the transformations needed to support patient engagement and empowerment, as part of hospital's digital strategy.

## 4 Digital Assessment and Strategy

Given that much of the health care consumers' journey begins when they enter the hospital as a patient, the engagement phase within the hospital should try to begin to empower patients. Hospitals need to

use approaches to inform and educate patients about the health care conditions that made them become a patient, and to engage them in care related choices and treatment options whenever appropriate. One hospital in Michigan has started to provide patients with a book with detailed information on the care they are undergoing (Fowler et al 2018). This allows patients to record and ask questions, and to see what actions they need to take once they are discharged, including making their first follow-up appointment. Other strategies are discussed briefly below.

*Patient portals* are used to share information but are less effective when they support only one-way communication from provider to patient. To make portals active social media forums, a two-way communication and consultation through alerts and automatic scheduling of appointments, along with the engagement of other members of the patient ecosystem, is required. *Telehealth technologies* are used to support communication between the patient and the provider. Their effectiveness depends on how engaged both the patient and providers are in using this communication for follow-ups and conversations. Again, given the varying nature of the ecosystem that supports patients, these technologies have to use different types of interaction (e.g. Skype, video conferencing, text, chat, etc.).

*Medical devices* are used to track health conditions (wearables) or activities (apps that track steps walked) are important in empowering patients to self-manage their health, but they must be connected to other patient/physician communication tools if they are to be effective, and they must be connected to other technologies used by patients (iPads or TVs) to support effective engagement. *Infomediaries and health care sites* (e.g. WebMD) are used to inform patients about the services available for them to learn about disease symptoms and criteria relevant in decision making. However, for these sites to be effective, consumers need to not only know how to seek answers to questions they have but also to stay involved in these interactions. For example, those who went through elective surgeries (e.g. cosmetic) and shared their experiences with peers and physicians/experts have been shown to be effective (Khuntia et al 2017). *Social media* used to share information about health and non-health care needs, combined with other uses of social media (talk to friends or play games), can reduce patient isolation. When combined with apps on iPads, it can increase the comfort level in using them. In summary, developing digital strategies to engage health care consumers inside the hospital so they are empowered when they leave the hospital begins with an assessment of the health state of a patient and the nature of the ecosystem they enter when they leave the hospital. Select questions shown in Table 1 provide examples.

<b>Empowerment Assessment</b>	How do patients become aware of care related symptoms and treatment options?
	What do patients look for in evaluating care related options?
	Which organizations do patients belong to that support their knowledge gathering?
	Is there care related support for immediate care, preventive care, and care that needs continual attention?
	Who else besides patients are engaged in decisions related to choosing care related options?
	What resources can the patients bring to have confidence in their care related choices?
<b>Engagement Assessment</b>	Who can help support patients select care options?
	Who is paying for the care chosen?
	What trade-offs is the patient willing to make between price, time, convenient access to care, who provides it, etc.?
	How capable is the patient in self-managing their own care - emotionally and access to care facilities?
	Where is the care provided post discharge?
	What social network can the patient rely on in seeking support during care follow-up?
	Does the patient have sustained access to physicians or other care providers to support care?

Table 1. Some Questions Related to Empowerment and Engagement

## 5 Conclusions and Future Research Directions

Hospitals need to tailor their digital transformation effort to support patients in their ecosystem. This paper argues that patient empowerment to self-manage their health in this ecosystem begins with their engagement with hospital staff inside the hospital and effective support of care and a non-care support network outside the hospital. Future research needs to view patients as health care consumers and tailor the empowerment strategies to make them be innovative in their use of care processes and technology to self-manage their health.

## References

- Bhatia, K, 2017, CareTainment: Research & Development Prototype, 2<sup>nd</sup> Graduate Research Conference, Oakland University, March, <https://www.oakland.edu/Assets/Oakland/grad/files-and-documents/Graduate-Student-Research-Conference/2017/Graduate%20Research%20Conference%202017%20Booklet%20.pdf>
- Bossert, O., Laartz, J. and Ramsay, T. 2014. "Running Your Company at Two Speeds", *McKinsey Quarterly*.
- Burke, Marina, Boal, Jeremy, Mitchell, Ruth. 2004. Communicating for Better Care: Improving nurse–physician communication., *AJN, American Journal of Nursing*: December 2004 - Volume 104 - Issue 12 - p 40-47.
- Chakravarthy B.S. and Y. Doz. 1992. "Strategy Process Research" Focusing on Corporate Self-Renewal," *Strategic Management Journal*, Vol. 13, pp. 5-14
- Fowler, B.L. J. Johns, M.R. Tanniru, V. Balijepally, Y.F. Roumani, D. Bobryk, K. Mitchell, 2018, "Engaging patients through Multi-Disciplinary Rounding – The case study at a Michigan hospital," *J. of Hospital Administration*, Vol. 7, No.5, 17-26.
- GlobalToLocal, <https://www.wghalliance.org/initiative/global-to-local/>
- Jones, J., J. Klaver and S. Kazzuha, 2013, Lessons Learned From Implementing a Readmissions Reduction Program, Oct 13, <https://blog.acc.org/post/lessons-learned-from-implementing-a-readmissions-reduction-program/>
- Khuntia, J., Yim, D., Tanniru, M., and Lim, S, 2017, "Patient Empowerment and Engagement with a Health Infomediary," *Health Policy and Technology, Elsevier*, 6, 40-50.
- Kripalani, S., Theobald, C.N., Anctil, B., Vasilekskis, E.E., 2013, "Reducing Hospital Readmission Rates: Current Strategies and Future Directions," *Annual Reviews Medicine*, October, Vol. 8, pp: 12-38
- Lusch, R. F., and Nambisan, S. 2015. "Service Innovation: A Service-Dominant Logic Perspective," *MIS Quarterly* (39:1), pp. 155-175.
- Porter, Michael E., *Competitive Advantage: Creating and Sustaining Superior Performance*, 1985, New York: Simon and Schuster.
- RSVP, 2016, <http://www.stjoeshealth.org/body.cfm?id=7598&action=detail&ref=5532>
- Raghupathi and Raghupathi, 2014, *Health Information Science and Systems*, 2:3  
-<http://www.hissjournal.com/content/2/1/3>
- Sandhu, K., 2012, Testing E-Services. *Advanced Automated Software Testing: Frameworks for Refined Practice*. pg: 196-218. IGI Global.
- Sandhu, K., and Corbitt, B., 2003, Web-based electronic service adoption model (E-SAM). PACIS 2003 Proceedings. <http://aisel.aisnet.org/pacis2003/29>
- Sandhu, K., 2011, The Use of Qualitative Evidence in E-Services Systems Implementation. *International Journal of Innovation and Learning*. vol 9(1). Inderscience Online. Print ISSN: 1471-8197 Online ISSN: 1741-8089
- Simon, H. A., *Administrative behavior*. 1947, New York, NY: Macmillan.
- Weiner, J., Tanniru, M., Khuntia, J., Bobryk, D., Naik, M., Page, K.L., 2016, "Digital Leadership in Action in a Hospital through a Real Time Dashboard System Implementation and Experience," *Journal of Hospital Administration*, May.

## Copyright

The following copyright paragraph must be appended to the paper. Author names MUST not be included until after reviewing. Please ensure the hyperlink remains for electronic harvesting of copyright restrictions.

**Copyright:** © 2018 authors. This is an open-access article distributed under the terms of the [Creative Commons Attribution-NonCommercial 3.0 Australia License](https://creativecommons.org/licenses/by-nc/3.0/australia/), which permits non-commercial use, distribution, and reproduction in any medium, provided the original author and ACIS are credited.



# Online Value Co-Creation in the Healthcare Service Ecosystem: A Review

## Atae Rezaei Aghdam

School of Information Systems  
Queensland University of Technology (QUT)  
Brisbane, Australia  
Email: atae.rezaeiaghdam@hdr.qut.edu.au

## Jason Watson

School of Information Systems  
Queensland University of Technology (QUT)  
Brisbane, Australia  
Email: ja.watson@qut.edu.au

## Hasti Ziainatin

School of Information Systems  
Queensland University of Technology (QUT)  
Brisbane, Australia  
Email: hastim.matin@gmail.com

## Abstract

Nowadays, the role of patients in the healthcare domain is extending beyond being passive healthcare recipients to becoming “makers and shapers” of healthcare services. In the healthcare service ecosystem, Online Health Communities (OHCs) foster co-creation among the different actors. Over the last five years, a number of articles that focus on value co-creation in the healthcare services have surfaced that highlight the significance of the interactions and engagements between the healthcare ecosystem levels. Accordingly, this paper aims to conduct a systematic review of the literature focusing on the role of OHCs as facilitators of value co-creation in the healthcare service ecosystem. A systematic review of the literature was conducted with articles published between 2013 and 2018. Thematic analysis revealed three key themes including “value is ubiquitous”, “online resources connectivism”, and “informational and emotional support”. This paper provides a structured overview of the current literature and identifies opportunities for future research.

**Keywords** Value co-creation, online health communities, healthcare ecosystem, service ecosystem

## 1 Introduction

Value co-creation is described in the literature as consumers coming together with suppliers, service providers or other consumers to create benefits realised by the user in the consumption process (Lusch et al. 2007; Nambisan and Nambisan 2009; Vargo and Lusch 2004). The customer can play a role as product conceptualiser, product designers, product testers, and product marketers in the co-creation process (Nambisan 2002; Nambisan and Nambisan 2008). In the healthcare context, value co-creation refers to “activities centred around the individual patient or in collaboration with numbers of the service delivery network including the patient, family, friends, other patients, health professionals and the outside community” (McColl-Kennedy et al. 2012, p. 6). One of the platforms that can facilitate co-creation in the healthcare ecosystem is online communities (Nambisan and Nambisan 2009). The process of value co-creation occurs in online communities between customers or peers in a process commonly known as peer production (Tapscott and Williams 2008), co-production (Peters et al. 2012), or social production (Arvidsson 2008) among other terms. In recent years, the concept of value co-creation has been discussed in terms of an adapting ecosystem, which continuously improves the system’s capabilities for responding to new opportunities (Romero and Molina 2011; Vargo and Lusch 2011). Understanding the holistic aspects of what is a complex system requires a shift from a firm-centred perspective to focusing on the entire context of a complex world (Gummesson 2008). This viewpoint makes a complex context such as healthcare more understandable by adopting system-level thinking. Therefore, in this context, it is important to investigate value co-creation at various levels of aggregation (Lusch and Spohrer 2012). Value co-creation plays an indispensable role in shaping the service ecosystem (Frow et al. 2016), and actors participation in co-creating value in healthcare has received much credence in healthcare research (Osei-Frimpong et al. 2018). In essence, a service ecosystem perspective provides new visions toward value co-creation by emphasising the role of multiple actors and their value co-creation interactions (Lusch and Vargo 2014), the significance of interdependencies, adaptation, and evolution (Frow et al. 2014). In a previous research study, (Beirão et al. 2017), suggested that the healthcare ecosystem needs to facilitate value co-creation. It assists ecosystem managers to make sure that resource integration is facilitated to foster benefits for all actors for engaging in value co-creation activities (Beirão et al. 2017). Co-creation practice created by various actors, belonging to different service ecosystems levels (micro, meso, and macro), show a mutual adjustment and contribute to ongoing shared changes (Ciasullo et al. 2017). In a service ecosystem, the process of value co-creation is impacted by actors’ abilities to access, adapt, and integrate resources that are severely shaped by the social context such as relationship and resources (Akaka et al. 2013; Pinho et al. 2014). Actors in such an ecosystem are engaged to share their resources, responding to value propositions which offer the possibility for positive outcomes (Frow et al. 2016). In line with this, the outcome of health co-creation takes place not only in light of patients’ demands, requirements, expectations, and experiences but also “with” the patient, who plays the main partner of healthcare professionals and a fundamental value co-creator (Ciasullo et al. 2017). Likewise, with the rapid growth of social media technology, online communities have been provided as ideal platforms for fostering co-creation between the different actors in healthcare service ecosystem (Amann 2017; Nambisan and Nambisan 2009). Hence, it is essential to investigate an integrated ecosystem perspective to understand the impact of OHCs as facilitators for value co-creation process in healthcare service ecosystem. As such, the main aim of this study is to address the following research question:

- 1) What is the role of online health communities as facilitators of value co-creation in the healthcare service ecosystem?

The remainder of this paper is organised in the following manner; Section 2; explains the research methodology employed in this paper, Section 3; presents the results of the thematic analysis, and finally, in section 4 and 5, the paper concludes and discusses the opportunities for future research.

## 2 Research Methodology

A systematic literature review of the most relevant articles to the research question was performed with articles published between 2013 and 2018. Most of the pertinent studies were collected from information-system related publications such as Information Systems Electronic Library (AISEL) and PubMed database. Among the 329 identified articles, a total number of 22 articles complied with the following inclusion criteria: 1) articles were written in English 2) published between 2013 and 2018 3) focus on value co-creation in online health communities through different stakeholders in the healthcare service ecosystem. Details of the database searches are presented in table 1.

Database	Keywords search	Final selections
EBSCO	11	4
Scopus	14	3
Medline	19	2
PubMed	157	8
AISeL	102	3
Google scholar	26	2
Total	329	22

Table 1. Database search details

The search results were acquired by searching the main keywords including “value co-creation”, “healthcare service ecosystem”, and “online health communities”. According to our research aim, a research string was defined using Boolean “AND” and “OR” operators: (“value co-creation”) OR (“online value co-creation”) AND (“online health communities” OR “Virtual health communities”) AND (“Healthcare service ecosystem”). However, we did not merely focus on these specific terminologies because some papers discussed value co-creation activities by different stakeholders without using the specific terms such as “online value co-creation” or “healthcare service ecosystem”. Hence, for ensuring that relevant papers are not neglected in this study, we included other relevant terms in the searching process. For instance, for the EBSCO database, a variant of the above string was applied to ensure that important relevant studies are not omitted. The initial database search strategy resulted in 329 papers, out of which 95 papers were assessed for inclusion criteria and finally 22 papers were selected as the most relevant papers for this review. During the study selection process, 234 out of 329 titles and abstracts of articles were screened by authors and discarded from the article selection process. The rest of 95 articles were fully reviewed and finally, 22 most relevant articles were selected in the final stage. Figure 1 illustrates the stages of article selections;

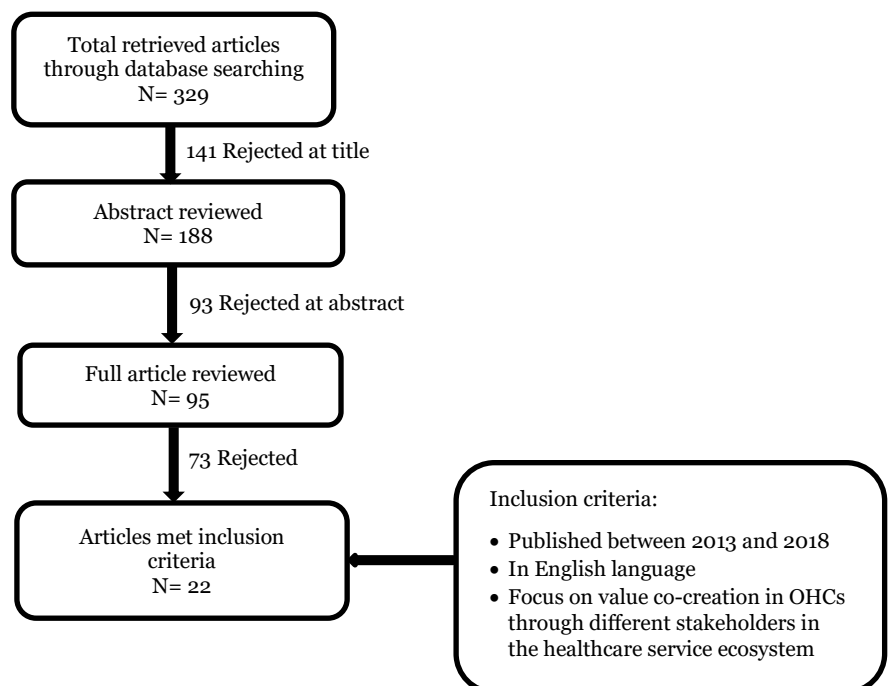

Figure 2: publication selection stages

In order to identify the main themes of chosen articles, “Thematic Analysis” has been carried out in this study. Thematic analysis is a technique to identify, analyse, and report the patterns (themes) within data

(Braun and Clarke 2006). In doing so, we followed Braun and Clarke (2006) six steps of thematic analysis, which is contextualised in table 2.

Phase	Contextualisation of the process
<b>1. Familiarisation with data</b>	Our data is the most relevant articles published in the last five years regarding the role of online health communities as facilitators of value co-creation in the healthcare service ecosystem.
<b>2. Generating initial codes</b>	During this phase, fifty-four codes were generated.
<b>3. Searching for themes</b>	Re-focus the analysis from the extensive level of themes and sorting the diverse codes into potential themes and sub-themes. After re-focusing the initial codes, we combined some similar themes with each other and conclude with 14 general themes.
<b>4. Reviewing themes</b>	Some candidate themes were eliminated from the process due to the less relevance to the research question, however, some themes broke down into separate themes. In addition, in this level, any additional data that had been missed earlier coding stage have been coded.
<b>5. Defining and naming themes</b>	Refine the themes and choose the final themes by combining similar themes, identifying the essence of each theme and determining what aspect of each theme captured. The naming of themes conducted in this phase in order to give the reader a sense of what the theme is about.
<b>6. Producing the report</b>	Producing a concise, coherent and logical story the data tell within and across themes. After performing this phase, the fourteen general themes grouped into three main constructs including; “value is ubiquitous”, “online resources connectivism”, and “informational and emotional online support”. All themes and sub-themes were vetted during a team meeting.

Table 2. Thematic analysis phases

In terms of testing the trustworthiness of the findings of this paper, we employed per cent agreement as our method of inter-coder reliability checking (Nili et al. 2017). Per cent agreement is a simple and useful method of checking the reliability of the qualitative findings of less sensitive (e.g. literature review) IS projects (Nili et al. 2018), where the original analyst and a second person compare the findings of their analyses for a sample of papers. We employed two research scholars to review the coding process. The overall result was 95% agreement on the findings, making us confident about the reliability of our literature review.

### 3 Results

In this study, we conduct a systematic review of the literature focusing on the role of OHCs as facilitators of value co-creation in the healthcare service ecosystem. In order to answer the research question, thematic analysis has been applied to explore the major concepts of literature regarding the role of OHCs as facilitators in healthcare service ecosystem. This analysis method followed an inductive approach, coding all sections of findings, discussion and conclusion. After following the six steps of thematic analysis including re-reading, re-coding, re-focusing, and refining the content of each paper, three main constructs have been identified as follow;

#### 1. Value is ubiquitous

In this study, we found that OHCs are ubiquitous resources that can facilitate value co-creation in all levels of the healthcare service ecosystem. In fact, by using OHCs, the process of value co-creation

facilitate among actors all across the healthcare ecosystem. Value co-creation occurs in multiple levels of ecosystem ranging from micro level to mega level. Among 22 studies, 11 studies contended that value co-creation process occurs in multiple levels of healthcare service ecosystem. The literature mostly focused on the patient-to-patient interactions in micro level. For example, social and emotional support from peer patients in the OHCs affected patients' perception regarding the service quality of healthcare organisations in the micro and meso levels of the healthcare service ecosystem. Furthermore, each level of an ecosystem includes various kinds of actors and these actors are engaging in the value co-creation process. For instance, on a micro level, patients, physicians, nurses, families and friends, on the meso and macro levels, hospitals, local health agencies, and healthcare organisations, and on the mega level, government health agencies, health funding bodies and regulatory bodies are the main actors. Moreover, numerous interactions occur among different actors such as dyad, triad, and complex networks in the healthcare service ecosystem. Therefore, all interactions in OHCs within and across all levels of the ecosystem grouped into "actors' online interactions" construct. By providing OHCs for actors in the healthcare service ecosystem, users can play a role as product designers, product testers, and product marketers (Nambisan and Nambisan 2008). As online value co-creation occurs in multiple levels of the ecosystem through OHCs, we categorised different kinds of values that created by actors into "online value" construct. By defining the term "online value" we mean that actors can create value through OHCs regardless of their location. In other word, actors are distance value co-creator in the healthcare ecosystem. They can create an online value from different locations and different levels within the healthcare service ecosystem. Therefore, patients and caregivers are the main beneficiaries of ubiquitous of value within OHCs. In essence, OHCs provide an opportunity for actors such as patients, physicians, caregivers, and nurses to share their health information and contribute in the value co-creation process within and across ecosystem levels (Bidar et al. 2017; Courtney 2013; Van Oerle et al. 2018). Consequently, all defined constructs such as; "Ecosystem levels", "online value", and "actors' online interactions" are combined into "ubiquitous value" construct due to the similarity of the context in order to answer the research question.

## **2. Online resources connectivism**

In this study, we found that online resources have been generated, shared, and re-combined by actors in OHCs. Resources are crucial parts of value co-creation in healthcare service ecosystem. The outcome of thematic analysis reveals that shared knowledge, health information, members, technology, and organisations within the ecosystem are defined as resources (Barrett et al. 2016; Chandler and Lusch 2015; Ciasullo et al. 2016; Maglio and Spohrer 2013; Osei-Frimpong et al. 2015; Scholz et al. 2017). In this study, we focus on online resources that accessed, shared, and re-combined by actors in the healthcare ecosystem. Accordingly, we investigated three main categories from the literature regarding online resources including; "resource access", "resource sharing", and "resource recombination". OHCs enable users to access, share, and recombine the resources in order to create online value in the healthcare ecosystem. As 8 studies out of 22 articles opined that for beneficial outcomes of value co-creation process, resources require to be combined with other resources (Beirão et al. 2017; Chung 2013; Ciasullo et al. 2017; Ciasullo et al. 2016; Hammervoll 2014; Osei-Frimpong et al. 2015; Palumbo et al. 2017; van der Eijk et al. 2013). As an example of online resource sharing, the patient assisted with this new knowledge can share and discuss with other patients on an OHC. Within the OHCs that form part of the ecosystem, interactions and relationships might change as knowledge is shared (Frow et al. 2016). The knowledge and the resources that shared in OHCs by stakeholders, can be valuable for healthcare professionals, who can read posts, or discussion among members of OHCs, and thereby learn about patients' perceptions, feelings, experiences, and attitudes toward medical services (Zhao et al. 2015). This knowledge also enables physicians to design more effective treatment choices, enhance their service quality, and interact with their patients in an effective way (Zhao et al. 2015). Hence, OHCs can facilitate the process of value co-creation by providing online resources to different actors in the healthcare service ecosystem.

## **3. Informational and emotional online support**

OHCs provide informational and emotional support for the community members. These types of supports are co-created by actors in OHCs. Members of these communities, interact online with others to receive and provide different types of social and informational support (Wang et al. 2017). Informational support is the most popular support provided by OHCs (Wang et al. 2017). Actors can benefit from OHCs by obtaining online supports from other actors such as patients, caregivers, physicians, and healthcare organisations. For instance, there are numerous support groups on OHCs such as breast cancer support group of Facebook or support groups of chronic diseases, which were found in the 22 studies. These communities are significant sources of value co-creation for actors in the healthcare service ecosystem. In this study, we explored constructs known as "informational support"

and “emotional support” that offered by OHCs to participants. Due to the fact that informational and emotional supports are provided through online platforms, the terms “online support” has been named to the construct. In addition, most relevant papers of this study focused on the role of OHCs in value co-creation among actors as in OHCs the process of value co-creation happens between patients, physicians, caregivers, and healthcare organisations. Therefore, OHCs are ideal platforms to foster value co-creation among actors within and across all levels of healthcare service ecosystem.

## 4 Discussion and directions for future works

The results of this study identified three main constructs of literature mostly focusing on value co-creation in the healthcare service ecosystem over the last five years. As the literature contends that value is the basic outcome and the most frequent factor of the co-creation process, this paper thematically analyses the value co-creation process in the healthcare service ecosystem from the context of online value co-creation. In essence, healthcare is not merely delivering of services from hospital or health organisations to patients, but a co-creating of value in which several actors are involved in resource integration in order to exchange service (Gambarov et al. 2017). This review suggests that OHCs provide an ideal platform for fostering value co-creation among different actors in the healthcare service ecosystem. The thematic analysis reveals three main constructs; in the first place, the ubiquitous of value provide opportunities for stakeholders to co-create value regardless of their locations. In the second place, users of OHCs benefit from online resources. For instance, they can access, share, and integrate resources in OHCs within or across levels of the healthcare service ecosystem. Furthermore, healthcare professionals also benefit from sharing resources in OHCs as they can read posts or discussion among members of OHCs, and thereby learn about patients’ perceptions, feelings, experiences, and attitudes toward medical services (Zhao et al. 2015). In the third place, actors can leverage OHCs by gaining online supports from other such as patients, caregivers, physicians, and healthcare organisations in order to provide different types of social and informational support.

It is important for service managers to extend their perspective to all actors in the service ecosystem by understanding the significance of mutual value co-creation at the system level (Beirão et al. 2017). In this systematic review, we also adopt a developed view of Gummesson (2008) regarding the levels of service ecosystem, placing particular focus on the mega level as this level was not mentioned in some previous studies as one of the ecosystem levels. In essence, mega level plays important role in the healthcare service ecosystem. Therefore, in this study, we adopt four levels of a service ecosystem; micro, meso, macro and mega level as our research question focused on healthcare service ecosystem. Healthcare organisations should establish better relations with the different actors at the other levels for value co-creation. Moreover, there is a need to design proper policies to elude the emergence of value co-destruction, which contains negative health outcomes (Barile et al. 2016). Therefore, healthcare organisations need to provide active patients with opportunities to engage in widespread value co-creation (Jaakkola and Alexander 2014). In doing so, OHCs can be applied as part of the healthcare organisation service offerings to increase the quality and value of their service portfolio in a cost-effective manner (Nambisan and Nambisan 2009).

Although numerous businesses have started to harness the advance potential of online communities by utilizing them as an online environment for customer co-innovation and value co-creation, healthcare organisations are lagging behind (Amann et al. 2016; Nambisan 2002). To date, more and more healthcare organisations are recognising the importance of OHCs as a significant platform of complementary service to improve the total quality of healthcare services delivery (Amann and Rubinelli 2017). Hence, healthcare organisations can extend a better understanding of various types of consumer value co-creation that is delivered by OHCs (Nambisan and Nambisan 2009). However, only limited studies have provided holistic view toward the significance of health service co-production and value co-creation in shaping a dynamic healthcare ecosystem (Annarumma and Palumbo 2016; Beirão et al. 2017; Frow et al. 2016). There is also a lack of sufficient studies regarding how interactions among multiple actors, especially in meso, macro and mega level, contribute to the emergence of value co-creation process (Ciasullo et al. 2016). Besides, the perspective in which healthcare organisations are able to participate indirectly in value co-creation might be an area of investigation (Hardyman et al. 2015). Furthermore, while in a complex domain such as healthcare, the service ecosystem view suggest a comprehensive understanding of value co-creation between the actors (Ciasullo et al. 2017), not many authors have focused on meso, macro and mega level. For instance, Hardyman et al. (2015) have investigated the interactions between healthcare organisations, local health agencies, and social services in the meso level. Consequently, only a few studies are exploring the value co-creation at macro and mega level (Frow et al. 2016; McColl-Kennedy et al. 2012). Thus, there are a number of areas, which is required for further research and discussion concerning value co-creation in healthcare service

ecosystem especially, engagement of healthcare organisations in meso level along with investigating the role of OHCs as facilitators within or across ecosystem levels.

## 5 Conclusion

This paper has investigated an online value co-creation in the healthcare service ecosystem. In doing so, relevant studies have been considered to interpret the significance of value co-creation in the healthcare service ecosystem. As social technologies such as online communities embedded in ecosystems, it is essential to understand how technology enables ecosystem emergence and provide opportunities for ecosystem actors. In a complex domain such as healthcare, the service ecosystem view suggest a comprehensive understanding of value co-creation between the actors (Ciasullo et al. 2017). The ecosystem's view leads to a great understanding of the necessity for resources' combinations, which is a fundamental aspect of value co-creation (Pappa et al. 2017). From co-creation perspective in a healthcare domain, patients are not passive and recipient of healthcare services, however rather are active co-creator of value, and there is increasing evidence that benefits of such a method include enhancing health outcomes and cost efficiencies (Frow et al. 2016). At the micro level, the quality of healthcare services provided to patients influences a healthcare organisation's total service quality, which in turn impact the patient's quality of life (Beirão et al. 2017). For example, social and emotional support from peer patients in the OHCs affected patients' perception regarding the service quality of healthcare organisations. Additionally, healthcare professionals should engage with patients and caregivers in co-designing and co-delivering health treatments (Palumbo et al. 2017). At the meso level, based on the outcome of thematic analysis, healthcare organisations should attempt to provide healthcare environment that establishes a co-creation of value among actors in the healthcare domain (Palumbo et al. 2017). Healthcare organisations need to take a holistic view of service delivery, considering the critical areas of the co-creation process for providing an opportunity for patients for an active participatory role in healthcare as healthcare is a high participatory domain and it needs patients active participation to attain successful results (Osei-Frimpong et al. 2015). At the macro and mega levels, governmental health agencies should be attentive about the role of vivid and cooperative inter-organisational relationship in identifying the potential of value co-creation (Palumbo et al. 2017). The mega level plays an essential role in establishing a healthcare service ecosystem (Palumbo et al. 2017). In essence, this level might improve patient-centred care at the macro and meso level that has the potential to enhance the suitability of the healthcare services ecosystem (Frow et al. 2014). Government health agencies can impact on the organisational strategies, motivating them to obey an ecosystem strategies at the strategic and the operational level (Adner 2017). Nevertheless, previous studies have emphasised on empowerment of patients in micro level (Funnell 2016), healthcare organisations should also be taken into consideration regarding empowerment to participate in value co-creation process (Palumbo et al. 2017). OHCs can improve the process of value co-creation among patients along with providing with an additional mechanism for obtaining informational and emotional support. These new forms of user-generated contents might offer value to patients, healthcare professionals, and healthcare organisations (Barrett et al. 2016). Practitioners should also be aware of environmental and cognitive impacts on users to improve value co-creation behaviour, improving the success of online communities (Bidar et al. 2016). Participation in OHCs leads to additional activities carrying out by patients, that add value to the patient-provider interactions (Hartmann et al. 2015). The information synthesised from the literature in this systematic review also suggest that the value co-creation is not limited to a micro level, which focuses on the dyadic interactions between patients and providers; rather their effect extends to all ecosystems' levels. In fact, the different actors such as patients, physicians, healthcare organisations, caregivers, professional association, etc., are participated in various ways regarding value co-creation, contributing health outcome enhancement at all levels.

## 6 Reference

- Adner, R. 2017. "Ecosystem as Structure: An Actionable Construct for Strategy," *Journal of Management* (43:1), pp. 39-58.
- Akaka, M. A., Vargo, S. L., and Lusch, R. F. 2013. "The Complexity of Context: A Service Ecosystems Approach for International Marketing," *Journal of Marketing Research* (21:4), pp. 1-20.
- Amann, J. 2017. "Democratising Healthcare: The Role of Ehealth Technologies in Driving Patient Participation," *EMJ Innov* (1:1), pp. 40-46.
- Amann, J., and Rubinelli, S. 2017. "Views of Community Managers on Knowledge Co-Creation in Online Communities for People with Disabilities: Qualitative Study," *J Med Internet Res* (19:10), p. e320.

- Amann, J., Zanini, C., and Rubinelli, S. 2016. "What Online User Innovation Communities Can Teach Us About Capturing the Experiences of Patients Living with Chronic Health Conditions. A Scoping Review," *PloS one* (11:6), p. e0156175.
- Annarumma, C., and Palumbo, R. 2016. "Contextualizing Health Literacy to Health Care Organizations: Exploratory Insights," *Journal of Health Management* (18:4), pp. 611-624.
- Arvidsson, A. 2008. "The Ethical Economy of Customer Coproduction," *Journal of Macromarketing* (28:4), pp. 326-338.
- Barile, S., Lusch, R., Reynoso, J., Saviano, M., and Spohrer, J. 2016. "Systems, Networks, and Ecosystems in Service Research," *Journal of Service Management* (27:4), pp. 652-674.
- Barrett, M., Oborn, E., and Orlikowski, W. 2016. "Creating Value in Online Communities: The Sociomaterial Configuring of Strategy, Platform, and Stakeholder Engagement," *Information Systems Research* (27:4), pp. 704-723.
- Beirão, G., Patrício, L., and Fisk, R. P. 2017. "Value Cocreation in Service Ecosystems: Investigating Health Care at the Micro, Meso, and Macro Levels," *Journal of Service Management* (28:2), pp. 227-249.
- Bidar, R., Watson, J., and Barros, A. 2017. "Classification of Service Co-Creation Systems: An Integrative Approach," *Advanced Communication Technology (ICACT), 2017 19th International Conference on: IEEE*, pp. 333-340.
- Bidar, R., Watson, J., and Barros, A. P. 2016. "Literature Review to Determine Environmental and Cognitive Factors Underlying User Value Cocreation Behaviour,").
- Braun, V., and Clarke, V. 2006. "Using Thematic Analysis in Psychology," *Qualitative research in psychology* (3:2), pp. 77-101.
- Chandler, J. D., and Lusch, R. F. 2015. "Service Systems: A Broadened Framework and Research Agenda on Value Propositions, Engagement, and Service Experience," *Journal of Service Research* (18:1), pp. 6-22.
- Chung, J. E. 2013. "Patient-Provider Discussion of Online Health Information: Results from the 2007 Health Information National Trends Survey (Hints)," *Journal of health communication* (18:6), pp. 627-648.
- Ciasullo, M. V., Cosimato, S., and Palumbo, R. 2017. "Value Co-Creation in the Health Service Ecosystems: The Enabling Role of Institutional Arrangements," *International Business Research* (10:12), p. 222.
- Ciasullo, M. V., Cosimato, S., Storlazzi, A., and Douglas, A. 2016. "Health Care Ecosystem: Some Evidence from the International Consortium for Health Outcomes Measurement (IcHom)," *Toulon-Verona Conference "Excellence in Services"*.
- Courtney, K. 2013. "The Use of Social Media in Healthcare: Organizational, Clinical, and Patient Perspectives," *Enabling health and healthcare through ICT: available, tailored and closer* (183), p. 244.
- Frow, P., McColl-Kennedy, J. R., Hilton, T., Davidson, A., Payne, A., and Brozovic, D. 2014. "Value Propositions: A Service Ecosystems Perspective," *Marketing Theory* (14:3), pp. 327-351.
- Frow, P., McColl-Kennedy, J. R., and Payne, A. 2016. "Co-Creation Practices: Their Role in Shaping a Health Care Ecosystem," *Industrial Marketing Management* (56), pp. 24-39.
- Funnell, M. M. 2016. "Patient Empowerment: What Does It Really Mean?," *Patient education and counseling* (99:12), pp. 1921-1922.
- Gambarov, V., Sarno, D., Hysa, X., Calabrese, M., and Bilotta, A. 2017. "The Role of Loyalty Programs in Healthcare Service Ecosystems," *The TQM Journal* (29:6), pp. 899-919.
- Gummesson, E. 2008. "Extending the Service-Dominant Logic: From Customer Centricity to Balanced Centricity," *Journal of the Academy of Marketing Science* (36:1), pp. 15-17.
- Hammervoll, T. 2014. "Service Provision for Co-Creation of Value: Insights from Exchange-and Production Economy Perspectives," *International Journal of Physical Distribution & Logistics Management* (44:1/2), pp. 155-168.
- Hardyman, W., Daunt, K. L., and Kitchener, M. 2015. "Value Co-Creation through Patient Engagement in Health Care: A Micro-Level Approach and Research Agenda," *Public Management Review* (17:1), pp. 90-107.
- Hartmann, B. J., Wiertz, C., and Arnould, E. J. 2015. "Exploring Consumptive Moments of Value-Creating Practice in Online Community," *Psychology & Marketing* (32:3), pp. 319-340.
- Jaakkola, E., and Alexander, M. 2014. "The Role of Customer Engagement Behavior in Value Co-Creation: A Service System Perspective," *Journal of Service Research* (17:3), pp. 247-261.
- Lusch, R. F., and Spohrer, J. C. 2012. "Evolving Service for a Complex, Resilient, and Sustainable World," *Journal of Marketing Management* (28:13-14), pp. 1491-1503.
- Lusch, R. F., and Vargo, S. L. 2014. *Service-Dominant Logic: Premises, Perspectives, Possibilities*. Cambridge University Press.



- Lusch, R. F., Vargo, S. L., and O'Brien, M. 2007. "Competing through Service: Insights from Service-Dominant Logic," *Journal of retailing* (83:1), pp. 5-18.
- Maglio, P. P., and Spohrer, J. 2013. "A Service Science Perspective on Business Model Innovation," *Industrial Marketing Management* (42:5), pp. 665-670.
- McCull-Kennedy, J. R., Vargo, S. L., Dagger, T. S., Sweeney, J. C., and Kasteren, Y. v. 2012. "Health Care Customer Value Cocreation Practice Styles," *Journal of Service Research* (15:4), pp. 370-389.
- Nambisan, P., and Nambisan, S. 2009. "Models of Consumer Value Cocreation in Health Care," *Health Care Management Review* (34:4), pp. 344-354.
- Nambisan, S. 2002. "Designing Virtual Customer Environments for New Product Development: Toward a Theory," *Academy of Management Review* (27:3), pp. 392-413.
- Nambisan, S., and Nambisan, P. 2008. "How to Profit from a Better 'virtual Customer Environment'," *MIT Sloan management review* (49:3), p. 53.
- Nili, A., Tate, M., and Barros, A. 2017. "A Critical Analysis of Inter-Coder Reliability Methods in Information Systems Research,"
- Nili, A., Tate, M., and Johnstone, D. 2018. "The Process of Solving Problems with Self-Service Technologies: A Study from the User's Perspective," *Electronic Commerce Research*, pp. 1-35.
- Osei-Frimpong, K., Wilson, A., and Lemke, F. 2018. "Patient Co-Creation Activities in Healthcare Service Delivery at the Micro Level: The Influence of Online Access to Healthcare Information," *Technological Forecasting and Social Change* (126), pp. 14-27.
- Osei-Frimpong, K., Wilson, A., and Owusu-Frimpong, N. 2015. "Service Experiences and Dyadic Value Co-Creation in Healthcare Service Delivery: A Cit Approach," *Journal of Service Theory and Practice* (25:4), pp. 443-462.
- Palumbo, R., Cosimato, S., and Tommasetti, A. 2017. "Dream or Reality? A Recipe for Sustainable and Innovative Health Care Ecosystems," *The TQM Journal* (29:6), pp. 847-862.
- Pappa, G. L., Cunha, T. O., Bicalho, P. V., Ribeiro, A., Couto Silva, A. P., Meira, W., Jr., and Beleigoli, A. M. 2017. "Factors Associated with Weight Change in Online Weight Management Communities: A Case Study in the Loseit Reddit Community," *J Med Internet Res* (19:1), p. e17.
- Peters, C., Bodkin, C. D., and Fitzgerald, S. 2012. "Toward an Understanding of Meaning Creation Via the Collective Co-Production Process," *Journal of Consumer Behaviour* (11:2), pp. 124-135.
- Pinho, N., Beirão, G., Patrício, L., and P. Fisk, R. 2014. "Understanding Value Co-Creation in Complex Services with Many Actors," *Journal of Service Management* (25:4), pp. 470-493.
- Romero, D., and Molina, A. 2011. "Collaborative Networked Organisations and Customer Communities: Value Co-Creation and Co-Innovation in the Networking Era," *Production Planning & Control* (22:5-6), pp. 447-472.
- Scholz, B., Bocking, J., and Happell, B. 2017. "How Do Consumer Leaders Co-Create Value in Mental Health Organisations?," *Australian Health Review* (41:5), pp. 505-510.
- Tapscott, D., and Williams, A. D. 2008. *Wikinomics: How Mass Collaboration Changes Everything*. Penguin.
- van der Eijk, M., Faber, M. J., Aarts, J. W., Kremer, J. A., Munneke, M., and Bloem, B. R. 2013. "Using Online Health Communities to Deliver Patient-Centered Care to People with Chronic Conditions," *Journal of medical Internet research* (15:6).
- Van Oerle, S., Lievens, A., and Mahr, D. 2018. "Value Co-Creation in Online Healthcare Communities: The Impact of Patients' Reference Frames on Cure and Care," *Psychology & Marketing*.
- Vargo, S. L., and Lusch, R. F. 2004. "Evolving to a New Dominant Logic for Marketing," *Journal of marketing* (68:1), pp. 1-17.
- Vargo, S. L., and Lusch, R. F. 2011. "It's All B2b... and Beyond: Toward a Systems Perspective of the Market," *Industrial marketing management* (40:2), pp. 181-187.
- Wang, X., Zhao, K., and Street, N. 2017. "Analyzing and Predicting User Participations in Online Health Communities: A Social Support Perspective," *Journal of medical Internet research* (19:4).
- Zhao, J., Wang, T., and Fan, X. 2015. "Patient Value Co-Creation in Online Health Communities: Social Identity Effects on Customer Knowledge Contributions and Membership Continuance Intentions in Online Health Communities," *Journal of Service Management* (26:1), pp. 72-96.

**Copyright:** © 2018 Rezaei Aghdam, Watson, Ziainatin. This is an open-access article distributed under the terms of the Creative Commons Attribution-Non Commercial 3.0 Australia License, which permits non-commercial use, distribution, and reproduction in any medium, provided the original author and ACIS are credited.

# Development and evaluation of ensemble-based classification models for predicting unplanned hospital readmissions after hysterectomy

## Isabella Eigner

Institute of Information Systems  
Friedrich-Alexander-University Erlangen-Nuremberg  
Nuremberg, Germany  
Email: isabella.eigner@fau.de

## Daniel Reischl

Institute of Information Systems  
Friedrich-Alexander-University Erlangen-Nuremberg  
Nuremberg, Germany  
Email: daniel.reischl@fau.de

## Freimut Bodendorf

Institute of Information Systems  
Friedrich-Alexander-University Erlangen-Nuremberg  
Nuremberg, Germany  
Email: freimut.bodendorf@fau.de

## Abstract

Unplanned hospital readmissions are a key indicator of quality in healthcare and can lead to high unnecessary costs for the hospital due to additional required resources or reduced payments by insurers or governments. Predictive analytics can support the identification of patients at high-risk for readmission early on to enable timely interventions. In Australia, hysterectomies present the 2nd highest observed readmission rates of all surgical procedures in public hospitals. Prior research so far only focuses on developing explanatory models to identify associated risk factors for past patients. In this study, we develop and compare 24 prediction models using state-of-the-art sampling and ensemble methods to counter common problems in readmission prediction, such as imbalanced data and poor performance of individual classifiers. The application and evaluation of these models are presented, resulting in an excellent predictive power with under- and oversampling and an additional slight increase in performance when combined with ensemble methods.

**Keywords** Predictive analytics, readmissions, hysterectomy, ensemble learning, sampling

## 1 Introduction

The Australian Institute for Health and Welfare (AIHW) tracks 28-day unplanned readmission rates for seven surgical procedure groups, i.e. hip replacements, knee replacements, tonsillectomy and adenoidectomy, cataract surgery, appendectomy, prostatectomy, and hysterectomy (AIHW, 2017b). The service rate in Australia (i.e., number of separations per 1,000 population) for hysterectomies (3.3) is only surpassed by cataract surgeries (9.3). These procedures, however, show very low readmission rates overall (0.3%). Besides tonsillectomy and adenoidectomy that show readmission rates of 3.4% on average, hysterectomy procedures have the 2<sup>nd</sup> highest rate of unplanned readmissions in Australia (3.3%) (AIHW, 2017a). Research has shown that hysterectomies are associated with a high complication risk, however, the influencing risk factors are not fully known (Daugbjerg *et al.*, 2014). In addition, Australia has one of the highest frequencies of hysterectomy procedures as compared to other OECD countries (262.2 procedures per 100,000 females) (OECD, 2018). Thus, analyzing hysterectomies as one of the most frequent and risk-prone procedures for unplanned hospital readmissions using Australian healthcare data offers great potential for generating useful insights and furthermore reducing unnecessary costs.

According to a systematic review by Artetxe *et al.* (2018) on predictive models for hospital readmission risk, machine learning methods can improve the prediction ability over traditional statistical approaches. Such contributions to this academic field are aimed at first aligning complex and sensitive information across multiple sources, using, among others, administrative, insurance, clinical, and government registry data. This information is thereafter used to identify patients in need of additional healthcare resources by means of various intervention methods (Billings *et al.*, 2013). To identify patients at risk of readmission, predictive analytics has developed into a popular research area in medicine and healthcare management (Zhou *et al.*, 2016; Kansagara *et al.*, 2011). The task of readmission prediction presents multiple challenges that have to be dealt with during the data pre-processing and analysis. Since the population of readmitted cases is usually low with respect to non-readmissions (3.3 % for hysterectomy in Australia on average), the analyst has to deal with an imbalanced class distribution. Furthermore, planned and unplanned readmissions need to be clearly separated as to avoid noise in the training set. While no universal definition for unplanned readmissions is available, the AIHW characterises them as “readmissions where the principal diagnosis indicates an adverse event.” (AIHW, 2017b). For this study, a readmission is defined as a revisit to the hospital that is directly related to the index admission, takes place in acute care, and where the time span between the discharge date of the index admission and the admission date of the revisit does not exceed 28 days.

Although the importance of predictive analyses in Information Systems (IS) is apparent (Gregor, 2006; Shmueli and Koppius, 2011) and contributions of IS in healthcare have been numerous demonstrated in the past (Haried *et al.*, 2017), research on predictive analytics in healthcare is still scarce in IS literature (Bardhan *et al.*, 2015). Furthermore, while studies in the past rather focus on explanatory modeling and hypothesis testing, the importance and major differences of building powerful prediction models have recently become apparent (Shmueli and Koppius, 2011). In readmission prediction research in general, especially the initial conditions targeted in the Hospital Readmission Reduction Program (HRRP) (acute myocardial infarction, heart failure, and pneumonia) are addressed in a variety of studies that are, however, primarily conducted in the US (Weinreich *et al.*, 2016; Baechle *et al.*, 2017; Castillo *et al.*, 2017; Amarasingham *et al.*, 2010; Frizzell *et al.*, 2017; Au *et al.*, 2012). Readmissions in Australian hospitals, especially focusing on the AIHW procedure groups are a novel and promising research area that will increasingly affect the Australian healthcare system as unplanned readmissions are more and more focused by insurers and the government (Health Innovation & Reform Council, 2013). This study presents a novel approach to identify patients at risk for 28-day readmission after a hysterectomy utilizing different sampling and ensemble methods. A dataset of 3,466 hysterectomy episodes at a private not-for-profit Australian hospital group is used to build and evaluate 24 different prediction models. The results of a literature review on common risk factors from previous research on predictive models for hospital readmissions in general as well as classification methods and their predictive power that are typically used in readmission prediction are used as a base for this study. Furthermore, the review indicates that diagnosis-specific prediction models perform better than general risk prediction models ([Anonymous], 2018). Thus, decision trees (DT), support vector machines (SVM), and artificial neural networks (ANN) are combined with under- and oversampling as well as bagging and boosting techniques to evaluate a potential increase in predictive performance through the use of sampling and ensemble methods. In addition to the general risk factors identified in previous research on predicting readmissions, disease-specific risk factors are identified in studies presenting explanatory models on hospital readmissions after hysterectomy. The process to build empirical models presented by Shmueli and Koppius (2011) is used to guide the subsequent analysis. The modeling section

of this paper is structured according to the process depicted in Table 1. Lastly, the implications and limitations of this study are presented.

<b>Goal</b>	<i>Build and compare prediction models to identify patients at risk for 28-day readmission after hysterectomy utilizing sampling and ensemble methods</i>
<b>Data collection &amp; study design</b>	<i>Observational data / retrospective study</i>
<b>Data preparation &amp; EDA</b>	<i>3,466 hysterectomy episodes; readmission rate 4.8 %</i>
<b>Variables</b>	<i>25 attributes</i>
<b>Methods</b>	<i>Decision tree / Artificial neural net / Support vector machine</i>
<b>Evaluation</b>	<i>Recall / AUC / F2-measure</i>

Table 1: Analysis process

## 2 Theoretical Background

### 2.1 Hospital Readmissions

The Australian government defines readmissions as "unplanned and unexpected hospital readmissions to the same public hospitals within 28-days for selected surgical procedures" (AIHW, 2017b). Although readmissions are a central theme in the Australian healthcare sector, criteria to specify whether an admission counts as a readmission vary among the different states or insurers. Rates are measured within a 28-day or 30-day time frame from the index admission. In Western Australia, an admission is labelled an unplanned readmission if the previous admission occurred within a time frame of 28 days and the patient is admitted for the same or a related condition or a complication following the index admission (Government of Western Australia, Department of Health, 2017). Since 2006, the Australian Institute of Health and Welfare (AIHW) has been tracking 28-day readmission rates (AIHW, 2017b). Monitoring of unplanned readmission rates across Australia is executed through the instalment of the National Healthcare Agreement (NHA) which contains unplanned readmission rates as a quality of care indicator. The calculation for the report, however, is limited to public hospitals. Here, readmissions are defined by the following criteria that have to be fulfilled to qualify for the inclusion in the statistic (AIHW, 2017b):

- The admission has to follow a separation from the same hospital where the patient was either treated with a knee replacement (TKA), hip replacement (THA), tonsillectomy and adenoidectomy (T&A), hysterectomy (HRT), prostatectomy (PRO), cataract surgery (CAT) or appendectomy (APP).
- The second admission has to occur within 28 days of the previous separation.
- A principal diagnosis has to have one of the following codes: T80/88, T98.3, E89, G97, H59, H95, I97, J95, K91, M96 or N99. These diagnosis codes include complications, sequelae of complications, and post-procedural disorders.

For these procedures, unplanned readmission rates of 2.09% (APP), 0.32% (CAT), 1.92% (THA), 2.31% (TKA), 3.34% (hysterectomy), 2.65% (PRO), and 3.47% (T&A) can be observed in Australian hospitals on average (AIHW 2017a, p. 225). Excluded from penalisation are planned readmissions as well as obstetrical delivery, transplant surgery, maintenance, chemotherapy, rehabilitation, and non-acute readmissions for a scheduled procedure. If a hospital exceeds the readmission rate benchmark, which is calculated on the risk-adjusted national average for the conditions above, funding rates are reduced. The corresponding expected risk adjustment, to account for region specific populations, is calculated by taking several factors, such as the hospital specific distribution of patient's age, gender and previous conditions as well as clinical risk factors using data from the preceding three financial years, into account. In summary, the AIHW definition of readmissions explicitly excludes planned admissions, considers only a specific list of surgeries, and focuses on a 28-day period.

## 2.2 Imbalanced Data

Imbalanced data, also known as skewed data, has a strong unequal distribution of the minority and majority classes (SUN *et al.*, 2009). In the case of hospital readmissions, the minority class is represented by unplanned readmissions. The main issue with handling imbalanced data is that traditional classifiers tend to perform best with an equal class distribution while the relevant information from the minority class might be overlooked with regards to the majority class (SUN *et al.*, 2009). There are a number of different approaches to handle imbalanced data (Galar *et al.*, 2012; SUN *et al.*, 2009; Kotsiantis, 2007; Longadge and Dongre, 2013; Chawla, 2005; He and Garcia, 2009) that can either be grouped in **algorithm approaches**, **data level approaches**, or a **combination of both**. Algorithm approaches manipulate the classifier to give a higher attention to the minority class. Since adaptations of the classifier need expert knowledge of the algorithm and the data domain (SUN *et al.*, 2009), this approach is not suitable for this study. Data level approaches, which are also known as external approaches (Haixiang *et al.*, 2017), change the data dimensions and can be further distinguished into **feature selection** and **resampling** (Haixiang *et al.*, 2017; Kotsiantis, 2007). The feature selection performed in this study is mainly based on risk factors derived from the literature. Resampling methods manipulate the number of entities to reduce the skew of the data. Resampling can be divided into *undersampling* and *oversampling*, where undersampling reduces the entities from the majority class, while oversampling creates additional entities of the minority class (Kotsiantis, 2007; Galar *et al.*, 2012). From the variety of over- and undersampling methods presented in literature (Galar *et al.*, 2012; Haixiang *et al.*, 2017) this study focuses on the most prominent techniques, namely *random undersampling* and the *synthetic minority oversample technique (SMOTE)*. Random undersampling, which is one of the most commonly applied undersampling techniques (Haixiang *et al.*, 2017), is the process of randomly removing entities of the majority class to reduce the data imbalance (Galar *et al.*, 2012). The most commonly used oversampling technique is SMOTE (Chawla *et al.*, 2011) and its derivations (Haixiang *et al.*, 2017).

## 2.3 Ensemble Learning

Hybrid methods of predicting imbalanced data include **cost-sensitive learning** and **ensemble learning**. Cost-sensitive learning follows the approach of manipulating the algorithm to weight the minority class higher and improve the classifier performance. Cost-sensitive approaches have the downside that the actual costs of misclassification must be known (SUN *et al.*, 2009). In this study, the costs of misclassification—namely, the costs of unplanned readmissions—are not known. Ensemble learning is performed when the results of several classifiers are combined to predict a future observation (Galar *et al.*, 2012). Ensemble learning can either be performed by combining different classifiers or by applying variations of the same classifier (Haixiang *et al.*, 2017). This study aims to benchmark the performance of traditional classifiers to single classifier ensembles. Single classifier ensembles are grouped into parallel ensembles (“*bagging*”) and iterative ensembles (“*boosting*”). Parallel ensembles train different base classifiers simultaneously, while iterative approaches train one base classifier after another (Haixiang *et al.*, 2017). **Bagging**, which is short for “bootstrapped aggregating,” is introduced by Breiman (1996) and combines several base classifiers into one classifier by bootstrapping the data into several different bags. Then, for each of the bags, the base classifier is trained and applied to the application set. Subsequently, the differently trained classifiers vote as to which class a new entity belongs, and a majority vote of the classifiers determines in which class the observation fits best. The most prominent **boosting** method, **AdaBoost** (“adaptive boosting”) (Freund and Schapire, 1997) is based on the principle of boosting introduced by Schapire (1990) and uses the base principle of improving the algorithm in every iteration to achieve a higher performance. Single classifier ensembles for imbalanced data combine either resampling methods or cost-sensitive approaches with the traditional ensemble methods, bagging or boosting (Galar *et al.*, 2012). Combining resampling with traditional ensembles resamples the data in bagging approaches after bootstrapping, while AdaBoost-based ensembles resample the data at each iteration before training the base classifier. This study focuses on random undersampling and SMOTE sampling. If undersampling is combined with bagging, the literature uses the term “underbagging” (Galar *et al.*, 2012), while the combination of SMOTE sampling and bagging is referred to as “BaggingSMOTE” (Błaszczyszki and Stefanowski, 2015). The combination of AdaBoost with random undersampling is called “RUSBoost” in the literature (Seiffert *et al.*, 2008), and the combination of AdaBoost with SMOTE as SMOTEBoost (Lavrač *et al.*, Chawla *et al.*, Chawla *et al.*, 2003).

### 3 Data Analysis

#### 3.1 Goal Definition

The goal of this study is to develop a prediction model that identifies patients at discharge with substantial risks of unplanned readmission to the hospital after hysterectomy. Since the data is imbalanced and this study aims to predict as many potential risk patients as possible, the receiver operating curve (ROC) in combination with the area under the curve (AUC) score is used. To identify whether a model proves sufficient, a target AUC score is defined. The AUC score of 0.50 can be described as random guessing, while an AUC score of 1.0 means that the prediction is 100% correct (Fawcett, 2006). Models with good discrimination powers are models with AUC scores of at least 0.80 (Kleinbaum and Klein, 2010, p. 357). Thus, this study aims to achieve an AUC score above 0.80. This is also aligned with current prediction models, which have AUC scores between 0.53 and 0.83 (Zhou *et al.*, 2016).

#### 3.2 Data Collection and Study Design

This study uses observational data from a large not-for-profit private health-care group in Victoria containing clinical, demographic, and financial information from anonymized patient episodes between the years 2011 to 2015. In total, the dataset comprises 642,407 patient episodes, where each entity describes a single episode at the hospital. For each episode, 483 different attributes are provided, which can be categorized into social demographic (e.g., age and nationality), financial (e.g., hospital charges), medical (e.g., diagnoses and procedures), and hospital-related (e.g., admission ward, length of stay) factors. The diagnosis data is coded in an Australian modification of the 10th version of the International Classification for Diseases (ICD-10-AM). The World Health Organization introduced ICD to name global health trends and statistics and is the international standard for reporting diseases and health conditions (World Health Organization, 2018). The procedure data is coded in the Australian Classification of Health Interventions (ACHI). To extract all relevant episodes for the procedure groups under study, the respective ACHI codes provided by the AIHW are used. Patients who died before or after discharge (n = 10) from the hospital as well as patients who were discharged at their own risk (n = 4) and patients who were admitted after December 3, 2015 (n = 75) are excluded from this dataset. Since unplanned readmissions are not directly flagged in the data, episodes that led to a readmission are marked as such, if the difference between the admission date of the revisit and discharge date of the episode is within the range of 0 to 28 days. Planned readmissions are excluded in this step. The final dataset counts a total of 3,466 hysterectomies. 166 episodes (4.8 %) lead to a 28-day readmission to the same hospital group.

In addition to general risk factors derived from studies on predicting all-cause patient readmissions, studies providing explanatory models for procedure-specific readmissions are analysed to identify specific risk factors for hysterectomies. A summary of all potential risk factors according to the respective sources is illustrated in Table 2.

Study	Data / Patients	Time-frame	Country	Risk factors	Procedures	Readmission rate
<b>Kreuninger <i>et al.</i>, 2018</b>	3,981 (benign)	60-day	USA	Type of procedure, perioperative complications	L, A, V, R	1.9 – 3.5 %
<b>Lonky <i>et al.</i>, 2017</b>	3,106 (benign)	90-day	USA	Race, type of procedure, blood loss, operative complications, length of stay	L, A, V	3.5 %
<b>Philp <i>et al.</i>, 2017</b>	119 (cervix cancer)	30-day	Canada	Age, operation time, blood loss, intraoperative complications	L	5%
<b>Penn <i>et al.</i>, 2016</b>	40,580 (benign)	30-day	USA (NSQIP)	Medical and surgical complication	L, A, V	2.8%
<b>Lee <i>et al.</i>, 2016</b>	1,649 (benign + malignant)	+ 30-day	USA	Complications, prior abdominal surgeries, malignancy, length of stay, blood loss	L, A, V	6%
<b>Fitch <i>et al.</i>, 2016</b>	21,926	30-day	CCED	Type of procedure (inpatient vs. outpatient)	L, A, V	2.1 – 3.05%

<b>Jennings et al., 2015</b>	8,890 (benign)	30-day	USA (NSQIP)	Comorbidities, substance abuse, L	operation time, complications		3.1%	
<b>Dessources et al., 2015</b>	41,196 (benign + malignant)	30-day	USA (NSQIP)	Complications, comorbidities, age		L, A, V	3.4 6.1%	–
<b>Catanzarite et al., 2015</b>	21,228 (benign)	30-day	USA (NSQIP)	Complications, return to theatre, age, comorbidities, smoking, prior surgeries, operation time, status (inpatient vs. outpatient), length of stay		L, A, V	2.7 3.8%	–
<b>Daugbjerg et al., 2014</b>	22,150 (benign)	30-day	Denmark	Socioeconomic status		L, A, V	6%	
<b>Liang et al., 2013</b>	395 (endometrial cancer)	90-day	USA	Length of stay, postoperative complications		R	7.6%	
<b>Summitt et al., 1994</b>	113	2 weeks	USA	Medication, complication, blood loss		L, V	3.8 %.	

Table 2: Identified studies on readmission risk factors after a hysterectomy

### 3.3 Data Preparation

The next step of developing a prediction model is to prepare the data, which mainly includes data cleaning, handling missing values, and splitting the data (Shmueli and Koppius, 2011). The term “data cleaning” describes the process of detecting and removing data errors and inconsistencies. A way to identify unclean data is to perform data profiling, which uses metadata to discover errors in the data. Errors discovered can be illegal values, misspellings, missing values, varying value representations, and duplicates (Rahm and Do, 2000). Next, the data is split into training and validation sets. The training set is a part of the data that is used to train the prediction model, and the validation set is used to determine the performance of the model. For this study, a cross-validation approach with 10-fold validation is used.

### 3.4 Exploratory Data Analysis

The goal of the exploratory data analysis is to analyze the dataset visually and numerically to ensure that the data is suitable for the prediction model as well as reducing the dimensions (Shmueli and Koppius, 2011). Because too many predictors can decrease the performance of a prediction model, the dimensions are systematically reduced in this step. Especially procedure and diagnosis data are reduced to relevant factors as well as redundancies within lengths of stay and admission dates are resolved. The numerical distribution gives an insight into how the two cohorts differ. While patients who were not readmitted visited the hospital 0.22 times on average, readmitted patients visited the hospital an average of 1.94 times within the last three months. Additionally, the procedure “radical abdominal hysterectomy with radical excision of pelvic lymph nodes” (10% /6%) and “total abdominal hysterectomy with removal of adnexa” (26%/ 23%) show a higher readmission rate within the study group. Additionally, patients being readmitted stay longer in the hospital (6.5/6.07) and longer in the operating room (160/136) and have a higher number of diagnoses (2.43/2.13), complications (1.49/0.95) and procedures (5/4.32). Furthermore, readmitted patients more often have low haemoglobin levels (25 %/14%), have less histology performed (34%/40%) and are released from the hospital later in the day (57%/48%).

### 3.5 Choice of Variables

After reducing dimensions, the next step is to select which variables to use for the prediction model. Two factors are especially relevant for the variable selection. At first, the variables must have a measurement quality, which means variables that do not assist in predicting unplanned readmissions are not relevant for the model. The second factor is the ex-ante availability. This signifies that the predictor must be accessible at point of prediction. In this study, the parameter must be available at time of discharge (Shmueli and Koppius, 2011). A feature is seen as beneficial if it is correlated with the prediction flag but is not redundant to any other relevant feature (Yu and Liu, 2003). This means that the variables must have the ability to predict readmissions while they not being highly correlated with each other. Since

correlations above 0.70 are seen as highly correlated (Asuero *et al.*, 2007), features with a correlation above 0.70 are removed. Additionally, in this step, variables that only include low information or no information are also excluded for predicting unplanned readmissions. Thus, columns only containing one constant value are removed as well as columns with a variance below 0.05. In regard to ex-ante availability, three additional features containing post-discharge information are removed since these factors are not accessible ex-ante. The resulting risk factors can be grouped into hospital-related and hospital-visit-related factors, socio-demographics, the patient history, as well as laboratory data. In summary, this leads to 25 different factors accessible at discharge.

Attribute	Type	Description (dc = distinct count)
Patient id	Categorical	Patient unique identifier (dc = 3,462)
Episode id	Categorical	Unique episode identifier (dc = 3,446)
Led_to_readmission	Boolean	Label attribute to be predicted
Admission year	Categorical	dc = 5 (2011 - 2015)
Admission ward	Categorical	dc = 31
Admission patient classification	Categorical	dc = 20; type of patient (e.g., surgical, medical)
Age	Numeric	mean = 55.35; range = 21 - 98
Blood usage	Boolean	Yes (13.3%) No (86.7%)
Campus	Categorical	dc = 6
Cancer	Boolean	Yes (27.44%) No (72.56%)
Complications	Numeric	mean = 0.98; range = 0 - 9
Diagnosis count	Numeric	mean = 3.50; range = 0 - 10
Discharge ward	Categorical	dc = 34
Discharge patient classification	Categorical	dc = 20; type of patient (e.g., surgical, medical)
Haemoglobin low	Boolean	Yes (14.83%) No (85.17%)
Histology	Boolean	Yes (39.47%) No (60.53%)
Hysterectomy procedure	Categorical	dc = 14;
Length of stay	Numeric	mean = 5.10; range = 0 - 69
Metastatic cancer	Boolean	Yes (7.59%) No (92.41%)
Procedure count	Numeric	mean = 4.35; range = 1 - 10
Separation after 10am	Boolean	Yes (48.21%) No (51.79%)
Total number of beds	Numeric	mean = 2.32; range = 0 - 11
Total number of wards	Numeric	mean = 1.03; range = 0 - 5
Total time in theatre	Numeric	mean = 137.48; range = 0 - 771
Visits past 6 months	Numeric	mean = 0.49; range = 0 - 27

Table 3: Final feature set

### 3.6 Choice of Potential Methods

Next, it must be determined which algorithms are used. According to Shmueli and Koppius (2011) either data-driven, shrinkage, or ensemble methods can be used. Based on the literature review, combinations of resampling with bagging and boosting show different strengths, yet there is no way to determine which of the algorithms are most suitable for predicting unplanned readmissions. Underbagging is used in the only study incorporating the problem of imbalanced data to predict unplanned hospital readmissions, while RUSBoost is similar to SMOTEBoost, showing performance improvement in many cases. Yet the most comprehensive study of Galar *et al.* (2012) highlights that a combination of SMOTE and bagging is the best bagging approach. This is why this study applies SMOTEBoost, BaggingSMOTE, underbagging, and RUSBoost to the data. Since all of these ensembles are combinations of either bagging or boosting with random undersampling or SMOTE-sampling, these components are also tested in combination with the base classifier. The base classifiers applied are the most frequently used classifiers in combination with ensemble learning— namely, DT, SVM, and ANN.

This leads to 24 different combinations being benchmarked within this study. First, the base classifiers DT, SVM, and ANN are applied; next, the traditional ensemble methods AdaBoost and bagging are applied in combination with them. Next, the base classifiers are benchmarked in combination with random undersampling, underbagging, and RUSBoost. Finally, models incorporating oversampling are applied (namely, SMOTE-sampling, BaggingSMOTE, and SMOTEBoost). RUS, SMOTE-sampling, and underbagging are based on the library ImbalancedLearn, which is an extension of Scikit-Learn



(Lemaitre *et al.*, 2016). For RUSBoost and SMOTEBoost, the algorithms developed by Johnson (2017) are utilized, which are based on the Scikit-Learn implementation of AdaBoost. Because the ANN implementation of Scikit-Learn does not support class weighting (which is necessary to apply boosting approaches to the data) ANN cannot be applied in combination with AdaBoost, RUSBoost, and SMOTEBoost. This leads to a benchmark of 24 different algorithms to predict unplanned hospital readmissions.

### 3.7 Evaluation, Validation, and Model Selection

The next step is to validate and select the best model. To evaluate the models, accuracy is usually used as a performance measure. For validation, Shmueli and Koppius (2011) state that the performance can be measured by applying the model to a holdout set or by using a cross-validation approach. This study uses a tenfold cross validation. Finally, as part of the model selection, different predictors should be added to improve the model performance. To compare the different results, the data is finally prepared to fit the need of the base classifiers. Thus, the performances of the 24 models are assessed and evaluated. For all models, a random seed is used to make the results reproducible. The seed is set to 11 and ensures that the retraining of a model with the same parameters shows identical results. For each classifier, a grid search is performed to attain the best parameter settings. For the DT, a maximum depth of 8, the gini index as the split criterion and the default setting for selecting the best split is chosen. The SVM is implemented using the support vector classification (SVC) algorithm with a radial basis function (RBF) kernel, setting the penalty parameter C to 32768 and the gamma to 0.000488. The ANN implementation utilizes the Multi-layer Perceptron (MLP) classifier with 8 neurons in the hidden layer, the lbfgs solver for weight optimization, the rectified linear unit (relu) function as the activation function, and an alpha of 0.01. For evaluation, we include the area under the curve (AUC) score, which presents a popular measure in healthcare analyses. In addition, we investigate the recall, which represents the ratio of all correctly predicted readmissions (predicted positives) to the true readmissions (true positives). To be able to easily track the cost of our prediction models with regards to the false positive rate, the F-score is included in the evaluation that considers both precision and recall. For this measure, the  $\beta$  is set to 2, to allow a higher weight for the recall (Sattar *et al.*, 2006).

Overall, underbagged decision trees show the most promising results for identifying unplanned readmissions with an AUC of 0.94, detecting almost all positive cases of the data set. On the other hand, bagging without prior resampling leads to an unsatisfactory predictive power across all three classifiers. Here, the issue of imbalanced data becomes apparent, where the prediction models tend to sort all examples to the majority class. Surprisingly, a standard SVM with no prior sampling, bagging, or boosting approach leads to a high AUC score of 0.87, whereas sampling and ensemble methods rather worsen the results. Table 4 summarizes the results for each prediction model, where models with an AUC > 0.9, AUC > 0.75 and AUC < 0.6 are highlighted in green, orange and red respectively. The best and worst models are highlighted in bold in addition.

	Decision Tree			SVM			Neural Net		
	AUC	Recall	F2	AUC	Recall	F2	AUC	Recall	F2
<b>Standard</b>	0.73	0.49	0.48	<b>0.87</b>	<b>0.83</b>	<b>0.62</b>	0.55	0.10	0.12
<b>RUS</b>	0.93	0.97	0.70	0.78	0.77	0.44	0.70	0.63	0.34
<b>SMOTE</b>	0.91	0.92	0.69	0.84	0.78	0.59	0.71	0.63	0.36
<b>Bagging</b>	<b>0.68</b>	<b>0.38</b>	<b>0.40</b>	0.51	0.02	0.02	<b>0.5</b>	<b>0</b>	<b>0</b>
<b>Underbagged</b>	<b>0.94</b>	<b>0.99</b>	<b>0.71</b>	0.81	0.72	0.53	0.73	0.67	0.39
<b>Overbagged</b>	0.93	0.95	0.71	0.62	0.28	0.27	<b>0.79</b>	<b>0.65</b>	<b>0.54</b>
<b>AdaBoost</b>	0.69	0.40	0.41	<b>0.5</b>	<b>0</b>	<b>0</b>	<b>0.5</b>	<b>0</b>	<b>0</b>
<b>RUS Boost</b>	0.93	0.96	0.70	<b>0.5</b>	<b>0</b>	<b>0</b>	<b>0.5</b>	<b>0</b>	<b>0</b>
<b>Smote Boost</b>	0.68	0.40	0.40	<b>0.5</b>	<b>0</b>	<b>0</b>	<b>0.5</b>	<b>0</b>	<b>0</b>

Table 4: Model evaluation

## 4 Conclusion

We conclude that the task of identifying patients at risk of readmission is highly complex and risk factors depend heavily on the presented context. Furthermore, the issue of imbalanced data and the poor performance of individual classifiers need to be considered in readmission prediction. Due to these restrictions, we present and compare prediction models to determine readmissions after a hysterectomy

procedure utilizing both sampling and ensemble methods. To this end, individual classifiers with no prior sampling, individual classifiers using under- and oversampled data, as well as bagged and boosted classifiers with and without prior sampling are built and evaluated. This way, the suitability of sampling and ensemble methods for the task at hand is analyzed by investigating a potential increase in predictive performance. Another advantage of our approach is the inclusion of both empirical evidence from past studies to construct relevant attributes as well as the investigation of all variables already collected onsite. This way, the resulting feature set is developed rigorously while keeping an open mind about further relevant risk factors not yet considered in the past. Overall, 24 prediction models are evaluated performing with AUC scores ranging from 0.5 to 0.94. Decision trees show the overall best performance considering all evaluation metrics. Support vector machines still yield satisfactory AUC rates of maximum 0.87 while neural nets perform considerably poorly with a maximum AUC score of 0.79. By including the F2-measure into the evaluation metrics, the cost of correct predictions can also be implicitly observed. Overall, combining RUS and bagging with decision trees are recommended for this context. The results indicate that the influence of sampling is higher than performing bagging or boosting, as the ensemble methods only slightly increase the predictive performance after sampling.

The implications of this study are evident for research and practice. With unplanned hospital readmissions as a key indicator of healthcare quality and associated unnecessary costs, the early identification of high-risk patients can support timely interventions to reduce avoidable readmission. This offers the opportunity for cost-reduction and an increased quality of healthcare services for hospitals and practitioners. On the other hand, this study gives an indication of the suitability of implementing ensemble methods in research and practice. As the number of studies investigating Australian healthcare data in general and readmission prediction after hysterectomies specifically is still limited, this study addresses an important research gap that can motivate further research in this area. Nevertheless, identifying patients at risk of readmission is a continuously challenging task due to the individual factors that influence patient care outcome in different healthcare settings.

Lastly, some limitations of this study also need to be mentioned. The data used to develop the predictive models in this paper are extracted retrospectively from a single private hospital group comprising multiple campuses in Australia. Furthermore, due to a lot of missing values, many features were excluded and thus didn't provide additional substantial findings on relevant risk factors. As a result, potentially important features (e.g., BMI) also could not be harnessed. Finally, domain experts (e.g., gynaecologists) should be consulted for a qualitative evaluation and interpretation of the results in future studies. This way, the suitability of the final feature set can be further strengthened or expanded.

## 5 References

- AIHW (2017a), "Admitted patient care 2015–16: Australian hospital statistics", available at: <http://www.aihw.gov.au/WorkArea/DownloadAsset.aspx?id=6012959534>.
- AIHW (2017b), "National Healthcare Agreement: PI 23–Unplanned hospital readmission rates, 2017", available at: <http://meteor.aihw.gov.au/content/index.phtml/itemId/630049>.
- Amarasingham, R., Moore, B.J., Tabak, Y.P., Drazner, M.H., Clark, C.A., Zhang, S., Reed, W.G., Swanson, T.S., Ma, Y. and Halm, E.A. (2010), "An automated model to identify heart failure patients at risk for 30-day readmission or death using electronic medical record data", *Medical care*, Vol. 48 No. 11, pp. 981–988.
- [Anonymous, 2018] Details omitted for double-blind reviewing.
- Artetxe, A., Beristain, A. and Graña, M. (2018), "Predictive models for hospital readmission risk. A systematic review of methods", *Computer Methods and Programs in Biomedicine*, Vol. 164, pp. 49–64.
- Asuero, A.G., Sayago, A. and González, A.G. (2007), "The Correlation Coefficient. An Overview", *Critical Reviews in Analytical Chemistry*, Vol. 36 No. 1, pp. 41–59.
- Au, A.G., McAlister, F.A., Bakal, J.A., Ezekowitz, J., Kaul, P. and van Walraven, C. (2012), "Predicting the risk of unplanned readmission or death within 30 days of discharge after a heart failure hospitalization", *American heart journal*, Vol. 164 No. 3, pp. 365–372.
- Baechle, C., Agarwal, A., Behara, R. and Zhu, X. (2017), "A cost sensitive approach to predicting 30-day hospital readmission in COPD patients", in Fotiadis, D.I. (Ed.), *4th IEEE EMBS International Conference on Biomedical and Health Informatics, Orland, FL, USA*, IEEE, Piscataway, NJ, pp. 317–320.
- Bardhan, I., Oh, J.-h., Zheng, Z. and Kirksey, K. (2015), "Predictive Analytics for Readmission of Patients with Congestive Heart Failure", *Information Systems Research*, Vol. 26 No. 1, pp. 19–39.

- Billings, J., Georghiou, T., Blunt, I. and Bardsley, M. (2013), "Choosing a model to predict hospital admission: an observational study of new variants of predictive models for case finding", *BMJ Open*, Vol. 3 No. 8, e003352.
- Błaszczczyński, J. and Stefanowski, J. (2015), "Neighbourhood sampling in bagging for imbalanced data", *Neurocomputing*, Vol. 150, pp. 529–542.
- Breiman, L. (1996), *Machine Learning*, Vol. 24 No. 2, pp. 123–140.
- Castillo, A., Edriss, H., Selvan, K. and Nugent, K. (2017), "Characteristics of Patients With Congestive Heart Failure or Chronic Obstructive Pulmonary Disease Readmissions Within 30 Days Following an Acute Exacerbation", *Quality management in health care*, Vol. 26 No. 3, pp. 152–159.
- Catanarite, T., Vieira, B., Qin, C. and Milad, M.P. (2015), "Risk Factors for Unscheduled 30-day Readmission after Benign Hysterectomy", *Southern medical journal*, Vol. 108 No. 9, pp. 524–530.
- Chawla, N.V. (2005), "Data Mining for Imbalanced Datasets. An Overview", in Maimon, O.Z. and Rokach, L. (Eds.), *Data mining and knowledge discovery handbook*, Springer, New York, NY, pp. 853–867.
- Chawla, N.V., Bowyer, K.W., Hall, L.O. and Kegelmeyer, W.P. (2011), "SMOTE: Synthetic Minority Over-sampling Technique", *Journal Of Artificial Intelligence Research*.
- Chawla, N.V., Lazarevic, A., Hall, L.O. and Bowyer, K.W. (2003), "SMOTEBoost. Improving Prediction of the Minority Class in Boosting", in Lavrač, N., Gamberger, D., Todorovski, L. and Blockeel, H. (Eds.), *Knowledge Discovery in Databases: PKDD 2003: 7th European Conference on Principles and Practice of Knowledge Discovery in Databases, Cavtat-Dubrovnik, Croatia, September 22-26, 2003. Proceedings, Lecture Notes in Computer Science*, Vol. 2838, Springer, Berlin, Heidelberg, pp. 107–119.
- Daugbjerg, S.B., Cesaroni, G., Ottesen, B., Diderichsen, F. and Osler, M. (2014), "Effect of socioeconomic position on patient outcome after hysterectomy", *Acta obstetrica et gynecologica Scandinavica*, Vol. 93 No. 9, pp. 926–934.
- Dessources, K., Hou, J.Y., Tergas, A.I., Burke, W.M., Ananth, C.V., Prendergast, E., Chen, L., Neugut, A.I., Hershman, D.L. and Wright, J.D. (2015), "Factors associated with 30-day hospital readmission after hysterectomy", *Obstetrics and gynecology*, Vol. 125 No. 2, pp. 461–470.
- Fawcett, T. (2006), "An introduction to ROC analysis", *Pattern Recognition Letters*, Vol. 27 No. 8, pp. 861–874.
- Fitch, K., Huh, W. and Bochner, A. (2016), "Open vs. Minimally Invasive Hysterectomy. Commercially Insured Costs and Readmissions", *Managed care (Langhorne, Pa.)*, Vol. 25 No. 8, pp. 40–47.
- Freund, Y. and Schapire, R.E. (1997), "A Decision-Theoretic Generalization of On-Line Learning and an Application to Boosting", *Journal of Computer and System Sciences*, Vol. 55 No. 1, pp. 119–139.
- Frizzell, J.D., Liang, L., Schulte, P.J., Yancy, C.W., Heidenreich, P.A., Hernandez, A.F., Bhatt, D.L., Fonarow, G.C. and Laskey, W.K. (2017), "Prediction of 30-Day All-Cause Readmissions in Patients Hospitalized for Heart Failure: Comparison of Machine Learning and Other Statistical Approaches", *JAMA Cardiology*, Vol. 2 No. 2, pp. 204–209.
- Galar, M., Fernandez, A., Barrenechea, E., Bustince, H. and Herrera, F. (2012), "A Review on Ensembles for the Class Imbalance Problem. Bagging-, Boosting-, and Hybrid-Based Approaches", *IEEE Transactions on Systems, Man, and Cybernetics, Part C (Applications and Reviews)*, Vol. 42 No. 4, pp. 463–484.
- Government of Western Australia, Department of Health (2017), "Admission, Readmission, Admission, Readmission, Discharge and Transfer Reference Manual", available at: <http://www.health.wa.gov.au/circularsnew/attachments/1242.pdf> (accessed 16 August 2017).
- Gregor, S. (2006), "The Nature of Theory in Information Systems", *MIS Q*, Vol. 30 No. 3, pp. 611–642.
- Haixiang, G., Yijing, L., Shang, J., Mingyun, G., Yuanyue, H. and Bing, G. (2017), "Learning from class-imbalanced data. Review of methods and applications", *Expert Systems with Applications*, Vol. 73, pp. 220–239.
- Haried, P., Claybaugh, C. and Dai, H. (2017), "Evaluation of health information systems research in information systems research: A meta-analysis", *Health informatics journal*, 1460458217704259.
- He, H. and Garcia, E.A. (2009), "Learning from Imbalanced Data", *IEEE Transactions on Knowledge and Data Engineering*, Vol. 21 No. 9, pp. 1263–1284.
- Health Innovation & Reform Council (2013), *Hospital Readmission Findings*.
- Jennings, A.J., Spencer, R.J., Medlin, E., Rice, L.W. and Uppal, S. (2015), "Predictors of 30-day readmission and impact of same-day discharge in laparoscopic hysterectomy", *American journal of obstetrics and gynecology*, Vol. 213 No. 3, 344.e1-7.
- Johnson, R. (2017), *ND DIAL: Imbalanced Algorithms*.
- Kansagara, D., Englander, H., Salanitro, A., Kagen, D., Theobald, C., Freeman, M. and Kripalani, S. (2011), "Risk prediction models for hospital readmission: a systematic review", *JAMA*, Vol. 306 No. 15, pp. 1688–1698.

- Kleinbaum, D.G. and Klein, M. (2010), "Assessing Discriminatory Performance of a Binary Logistic Model: ROC Curves", in Kleinbaum, D.G., Klein, M. and Pryor, E.R. (Eds.), *Logistic Regression: A Self-Learning Text, Statistics for Biology and Health*, 3. ed., Springer Science+Business Media LLC, New York, NY, pp. 345–387.
- Kotsiantis, S.B. (2007), "Supervised Machine Learning: A Review of Classification Techniques", *Informatica*, Vol. 31 No. 3.
- Kreuninger, J.A., Cohen, S.L., Meurs, E.A.I.M., Cox, M., Vitonis, A., Jansen, F.W. and Einarsson, J.I. (2018), "Trends in readmission rate by route of hysterectomy - a single-center experience", *Acta obstetrica et gynecologica Scandinavica*, Vol. 97 No. 3, pp. 285–293.
- Lavrač, N., Gamberger, D., Todorovski, L., Blockeel, H., Chawla, N.V., Lazarevic, A., Hall, L.O. and Bowyer, K.W. (Eds.) (2003), *SMOTEBoost: Improving Prediction of the Minority Class in Boosting: Knowledge Discovery in Databases: PKDD 2003*, Springer Berlin Heidelberg.
- Lee, M.S., Venkatesh, K.K., Growdon, W.B., Ecker, J.L. and York-Best, C.M. (2016), "Predictors of 30-day readmission following hysterectomy for benign and malignant indications at a tertiary care academic medical center", *American journal of obstetrics and gynecology*, Vol. 214 No. 5, 607.e1-607.e12.
- Lemaitre, G., Nogueira, F. and Aridas, C.K. (2016), *Imbalanced-learn: A Python Toolbox to Tackle the Curse of Imbalanced Datasets in Machine Learning*, available at: <http://arxiv.org/pdf/1609.06570>.
- Liang, M.I., Rosen, M.A., Rath, K.S., Clements, A.E., Backes, F.J., Eisenhauer, E.L., Salani, R., O'Malley, D.M., Fowler, J.M. and Cohn, D.E. (2013), "Reducing readmissions after robotic surgical management of endometrial cancer. A potential for improved quality care", *Gynecologic oncology*, Vol. 131 No. 3, pp. 508–511.
- Longadge, R. and Dongre, S. (2013), *Class Imbalance Problem in Data Mining Review*, available at: <http://arxiv.org/pdf/1305.1707>.
- Lonky, N.M., Mohan, Y., Chiu, V.Y., Park, J., Kivnick, S., Hong, C. and Hudson, S.M. (2017), "Hysterectomy for benign conditions. Complications relative to surgical approach and other variables that lead to post-operative readmission within 90 days of surgery", *Women's health (London, England)*, Vol. 13 No. 2, pp. 17–26.
- OECD (2018), *Health care utilisation*, OECD Publishing.
- Penn, C.A., Morgan, D.M., Rice, L.W., Harris, J.A., Rauh-Hain, J.A. and Uppal, S. (2016), "Timing of and Reasons for Unplanned 30-Day Readmission After Hysterectomy for Benign Disease", *Obstetrics and gynecology*, Vol. 128 No. 4, pp. 889–897.
- Philp, L., Covens, A., Vicus, D., Kupets, R., Pulman, K. and Gien, L.T. (2017), "Feasibility and safety of same-day discharge after laparoscopic radical hysterectomy for cervix cancer", *Gynecologic oncology*, Vol. 147 No. 3, pp. 572–576.
- Rahm, E. and Do, H.H. (2000), "Data Cleaning: Problems and Current Approaches", in *Zinc Industry*, Woodhead Pub, S.I., Introduction/page i-Introduction/page ii.
- Sattar, A., Kang, B.-h., Sokolova, M., Japkowicz, N. and Szpakowicz, S. (Eds.) (2006), *Beyond Accuracy, F-Score and ROC: A Family of Discriminant Measures for Performance Evaluation: AI 2006: Advances in Artificial Intelligence*, Springer Berlin Heidelberg.
- Schapire, R.E. (1990), "The strength of weak learnability", *Machine Learning*, Vol. 5 No. 2, pp. 197–227.
- Seiffert, C., Khoshgoftaar, T.M., van Hulse, J. and Napolitano, A. (2008), "RUSBoost. Improving classification performance when training data is skewed", in *19th International Conference on Pattern Recognition, 2008: ICPR 2008 ; 8 - 11 Dec. 2008, Tampa, Florida, USA, Tampa, FL, USA, 8/12/2008 - 11/12/2008*, IEEE, Piscataway, NJ, pp. 1–4.
- Shmueli, G. and Koppius, O. (2011), "Predictive Analytics in Information Systems Research", *MIS Q*, Vol. 35 No. 3, pp. 553–572.
- Summitt, R.L., Stovall, T.G., Lipscomb, G.H., Washburn, S.A. and Ling, F.W. (1994), "Outpatient hysterectomy. Determinants of discharge and rehospitalization in 133 patients", *American journal of obstetrics and gynecology*, Vol. 171 No. 6, 1480-4; discussion 1484-7.
- SUN, Y., Wong, A.K. and Kamel, M. (2009), "Classification of imbalanced data. A review", *International Journal of Pattern Recognition and Artificial Intelligence*, Vol. 23 No. 04, pp. 687–719.
- Weinreich, M., Nguyen, O.K., Wang, D., Mayo, H., Mortensen, E.M., Halm, E.A. and Makam, A.N. (2016), "Predicting the Risk of Readmission in Pneumonia. A Systematic Review of Model Performance", *Annals of the American Thoracic Society*, Vol. 13 No. 9, pp. 1607–1614.
- Yu, L. and Liu, H. (2003), "Feature Selection for High-Dimensional Data: A Fast Correlation-Based Filter Solution", paper presented at Proceedings, Twentieth International Conference on Machine Learning.

Zhou, H., Della, P.R., Roberts, P., Goh, L. and Dhaliwal, S.S. (2016), "Utility of models to predict 28-day or 30-day unplanned hospital readmissions: an updated systematic review", *BMJ Open*, Vol. 6 No. 6, e011060.

## Copyright

**Copyright:** © 2018 authors. This is an open-access article distributed under the terms of the [Creative Commons Attribution-NonCommercial 3.0 Australia License](https://creativecommons.org/licenses/by-nc/3.0/australia/), which permits non-commercial use, distribution, and reproduction in any medium, provided the original author and ACIS are credited.

# The impact of information systems on work structure and culture in an emergency department

## **Atlarelang Basetsana Kesiilwe**

School of Computing and Information Systems  
The University of Melbourne, Victoria, Australia  
Email: akesiilwe@student.unimelb.edu.au

## **Reeva Lederman**

School of Computing and Information Systems  
The University of Melbourne, Victoria, Australia  
Email: reeva.lederman@unimelb.edu.au

## **Suelette Dreyfus**

School of Computing and Information Systems  
The University of Melbourne, Victoria, Australia  
Email: suelette@unimelb.edu.au

## **Jonathan Knott,**

Department of Emergency Medicine,  
The Royal Melbourne Hospital, Victoria, Australia  
Email: Jonathan.Knott@mh.org.au

## **Abstract**

This paper describes a study where consultants in an emergency department will be observed and interviewed with the aim of evaluating the impact of the progressive implementation of an information system in an emergency department in a metropolitan hospital in Australia. The study is the third stage of a 3-stage longitudinal study which is building on data from two previous studies that were conducted in the same setting in 2008 and 2012. The evaluations will be based on predefined task categories to investigate how information systems in health settings affect time and prioritisation of tasks. The study aims to understand how the changes brought by information systems implementation can be managed to fit in with the structure and culture of work in the hospital setting. The outcome of this research will inform guidelines for how information systems for hospitals can be designed and implemented.

**Keywords:** emergency department, information systems, time-motion studies.

## 1 Introduction

Emergency medicine provides rapid management of acute illness and injury. According to the Australian Institute of Health and Welfare, there were 7.8 million presentations across Australian emergency departments (EDs) in the period 2016-2017. This is an increase in comparison to the period 2015-2016 where 7.3 million presentations were reported. The report states that between the periods 2012-2013 and 2015-2016 there was an increase of 3.7% on average of presentations every year, and between the periods 2015-2016 and 2016-2017, the presentations increased by 3.9% on average (Emergency Department Care 2016-2017 Australian Government). The increase in ED presentations is due to varying reasons such as the financial burden of primary care (Jones and Thornton 2013), an aging population (Lowthian et al. 2012) and ED visits by people living in lower socio-economic areas (Australian Bureau of Statistics 2014) who cannot access other modes of care. Despite an increase in online care access (Fan et al. 2010; Fan et al. 2013; Fan and Lederman 2018; Lederman et al. 2014), patients under stress still present constantly at the ED. This increase in ED demand leads to complexities such as variation in patient conditions; overcrowding which may lead to longer waiting times, increased mortality rates and a shortage of resources such as beds (Bernstein et al. 2009; Forero et al. 2010; Moskop et al. 2009), which makes the ED workflow non-linear and challenging (Wang 2009).

The practice of medicine in EDs is often compromised by factors such as the need for time-sensitive patient care decisions, the frequent lack of key patient information and the extreme variation in presenting complaints and medical conditions (Hoffman et al. 2013). To overcome the complexities in EDs, information technology (IT) is often integrated into ED processes. This, as stated by Shekelle et al (2006), is due to the fact that information technology use in healthcare is seen as strategic in creating efficiencies and improvements that are cost effective and beneficial to patients. In emergency medicine, information technology is ideal in supporting the collaborative work and information needs of clinicians thus optimising the delivery of better patient care (Berg 2003; Laxmisan et al. 2007; Taylor 2004) in terms of timely treatment, attendance and execution, and the reduction of ED waiting time. As a result, Information Systems (IS) implementation in the ED is increasingly aimed at contributing to a patient-centred approach to care (Lederman and Ben-Assuli 2017; Taylor et al. 2017), to improve clinical outcomes through the provision of a platform for shared multidisciplinary and continuous patient care and a facilitation of communication between healthcare providers (Vezyridis et al. 2014).

### 1.1 Context of the study

The ED is a busy and fast paced environment and information systems (IS) are often implemented to support activities and clinical tasks. The proposed study is the third stage of a 3-stage exploratory longitudinal study (Kee et al. 2012; Lederman et al. 2015; Peng et al. 2010; Peng et al. 2013;) where data collected in the years 2008, 2012 and 2018 will be compared to understand the progressive change in information systems use and deployment in an emergency department.

Before the current EDIS was introduced the ED had a paper-based system and a number of stand-alone computer systems. These systems included the hospital admission system, test result retrieval system and a picture archiving and communications system (PACS) for storing and viewing radiology results. The current system was implemented in 2012 to automate administration, triage and tracking, clinical notes, test ordering and conditional data collection. The system in use is about to be replaced as it is no longer supported in Australia, and a new IS is to be implemented. With this new implementation, there is an expectation of integrating some functions and an opportunity for more flexibility in improving the workflows and information exchange as it captures real time patient data. We intend to analyse its impact compared to collected data from the previous studies discussed below:

#### 1.1.1 Overview of the 2008 study

This study aimed at evaluating how consultants spend time on various tasks based on a list of pre-determined task categories. These categories are clinical care, transiting, documentation, computer use, communication, pharmacy, non-clinical tasks and communication. When this study was conducted, paper-based patient records were still in use and the EDIS (Emergency Department Information System) was used to document the patient pathway from arrival till consultation. The study was conducted over a period of 2 months with a total of over 130 hours of recorded observations of duty and resuscitation consultants. On each hourly observation, it was recorded that a total of 101 tasks were performed by the consultants.

### **1.1.2 Overview of the 2012 study**

The second study was conducted over a period of 59 days with a total of 400 hours of recorded observations. The observations were based on the structuration theory to determine the patterns of work activities that emerge during the implementation of an information system and quantify the time spent on activities that are involved in direct care of patients and also activities that are involved in indirect patient care. The implementation of the information system as highlighted in the study resulted in changes to work routines: information processing for the different groups of clinicians changed due to the centralisation of information collection, storage and access; task prioritisation became an issue as staff were pressured to make decisions based on competing priorities of patient care quality vs economic demands.

This longitudinal study will provide insights into the impact of changing/updating an IS in an ED environment. The comparison of data from the two studies discussed above revealed that implementation of information systems affects clinical practices in terms of both structure and culture. The intended study is important as it extends the scope of the previous studies beyond the impact of IS on time spent on work activities to examining work routines and assessing how the resulting change is managed. The information system will be examined from a technical dimension – the perceived usefulness of the technology, the social dimension – how the technology fits in with existing working roles and; the organisational dimension – existing workflows (Cresswell and Sheikh 2013). Social consequences that affect the outcomes of IS implementation will also be examined as they reflect the difficulties that stem from the integration of the new technology with existing working practices of users as well as with organisational processes (Cresswell 2016).

## **2 Literature Review**

### **2.1 The evolution of IS in healthcare**

The application of IS in healthcare has allowed for easy access to patient information, facilitated decision making as well as the support of administrative tasks such as appointments scheduling, registration and discharge of patients (Mohamadali and Zahari 2017).

The healthcare industry has lagged behind the business environment in the introduction of information technology. The use of information systems in medicine is often dated to the 1950s with the work of Robert Ledley, who applied computers of the time to dentistry (and later developed the first computed tomography scanner). The size of computing devices of the time limited their application to clinical practice, but with the development of microcomputers in the 1970s and 1980s, use at the bedside became possible (Hoffman et al. 2013). In the United States the Health Information Technology for Economic and Clinical Health (HITECH) Act was implemented in order to promote meaningful use of information technology – the act was implemented to promote widespread of information technology (Congressional Research Service, 2009); in the UK in 2014, the National Health Service (NHS) launched the five year forward view which aims at improvements in quality and service by harnessing technology and innovation to achieve digitisation in healthcare (Honeyman et al. 2016); in Australia, the Australian Digital Health Agency launched the National Digital Health Strategy which is aimed at achieving outcomes such as improved access to patient information; better availability of information on medications and prescriptions; digitally-enabled models of care that drive improved accessibility, quality, safety and efficiency by the year 2022 (Australian Digital Health Agency).

### **2.2 IS Implementation in the ED**

Emergency care involves the provision of short term treatment on patients and efficient performance of complex tasks – most patients that present to the ED are critical patients and examination of patients needs to be performed quickly due to high patient volume (Lenz and Reichert 2007). In recent years, the role of the ED has expanded to also provide primary care which has added to the work load in ED settings. Thus, the implementation of information systems in ED is a complex process due to the multi-faceted and reciprocal relation between IS and organization. Often in emergency departments IS implementation is perceived as disruptive to work routines and the workflow. This, as noted by Rodriguez, Aziz, and Chatwin, (2014, p.88) is due to the fact that “emergency departments (EDs) workflows require robust coordination between resources for treatment, referral, admission and discharge purposes in order to maintain a swift and accurate patient flow through the different stages during their ED visit”. Information system studies in regard to workflow have shown that users often experience difficulty in integrating the technology in their routine clinical practices, and despite the perceived benefits of the technology, difficulties have been reported in assimilating the use of the



technology in their work (Callen et al. 2013). These difficulties as stated by the authors are in relation to significant data entry demands required and the time taken and are often seen as contributing to workflow disruptions. IS implementation also changes the patient care processes because the aim of such systems implementations is to promote efficiency (Vartak et al. 2009).

The infusion of health information technologies in ED environments is driven by the need to facilitate communication, promote ease of information flow and workflow and enhance decision making and patient safety (Kane and Luz 2015). It has been reported that health information technologies (HIT) capabilities lead to improvement in ED efficiency by reducing waiting times and improving turnaround times when ordering tests and medications during patient visits (Selck and Decker 2016).

### **2.3 IS implementation evaluation**

The implementation of IS, which refers to the process of planning, testing, adopting and integrating IS to ensure the integration of the technology into organisational routine is a complex process which is often met with challenges such a slow implementation process, integration issues between the system and work place practices, (Cresswell and Sheikh 2013). To understand the impact of IS implementation in EDs and gain insights into how IS impacts clinical efficiency, it is imperative that the work processes and workflows are studied (Zheng et al. 2011). As noted by the authors, “to develop such an understanding requires rigorously conducted research that can generate compatible and comparable results to inform effective technology designs and implementation approaches” (Zheng et al. 2011, p. 704). Such studies allow a deeper understanding of IS use by providing insights into IS implementation in EDs. As explained by Jones et al (2012), the IT paradox comprises of three categories being mismeasurement, mismanagement, and poor usability. Therefore, an understanding of information system use can enable the design and implementation of systems that are specific to the unique needs of emergency medicine practitioners thereby promoting usability of the systems and enabling ways of measuring system use.

Reduced costs and improved patient care quality are often the drivers of IS implementation in most healthcare settings (Cresswell et al. 2013). Measurement and prediction of outcomes of IS implementations allow the conceptualisation of the required transformations. Evaluations of IS implementations are often done at the individual level to investigate what drives individuals to adopt IS; at the group level to investigate issues such as resistance towards adoption; and at the organisational level which investigate the readiness of an organisation to adopt IS (Lapointe and Rivard 2007). The need for orderly routines in patient care provision and the need for sensitivity to variation in patient conditions is what characterizes healthcare delivery settings. Often the tension between the routine and the variability in presentations lead to complexities surrounding the implementation and usage of IS as is the case in most ED settings (Agarwal et al. 2011). These authors emphasise the importance of learning to determine the best way to align both technology and organisation to achieve a good fit between the capabilities afforded by the technology and the desired patterns of actual use. The intended study serves as a basis for learning about the implications of the implementation of IS on clinicians' work tasks in terms of quality and speed; and the impact on patient care in terms of the time spent interfacing with patients.

## **3 Methodology**

This study will use a time-motion approach (Kesilwe et al. 2018) to explore the impact of technology use on clinical activities and identify patterns of use to generate findings that can inform the design of IT based interventions for patient care. The evaluation will use a mixed methods case study based approach where both quantitative and qualitative methods will be used for data gathering. The combined use of both the qualitative and quantitative methods in a single evaluation will yield results that a single approach may not yield, and because the limitations of using either method is offset by the other (Creswell and Clark 2011). A mixed methods approach also creates a synergy whereby one method enables the other to be more effective and together both methods would provide a complete understanding of the evaluation (Greene and Caracelli 1997).

A case study research approach will be used as it enables a focus on an intensive assessment of events that occur within the structure of the organisation and the selection of cases is representative of the phenomenon under study (Wynn and Williams 2012). Case study is suitable for this study since it's an exploratory study, the case study methodology as noted by Yen (2003), allows for results to be interpreted directly and allows transferability of solutions and Gomm et al (2000) also advocates that good case studies allow for the recognition of complexity of social truths as well as the generalisability of a solution or instances of that solution.

Quantitative data will be collected through continuous observations using the “shadowing technique” which allows one person to be observed and studied in detail at a time as is common with time motion studies. Time-motion studies have been conducted in health care settings such as emergency department, general medicine and surgical environment to assess if medical practitioners maximise the time spent on patient care by timing their activities (Hollingsworth et al. 1998). The use of time motion studies have been in existence since the early twenties as a result of a recognition of inefficiencies and a wastage of resources from industrial processes which led to the development of techniques aimed at reducing process times to achieve efficiency (Taylor 1914) and the technique was also adopted in the healthcare industry to assess inefficiencies and promote cost reduction (Baumgart and Neuhauser 2009). The medical staff will be shadowed for a period of time using a tablet that has a specialised time stamp software to capture the activities being performed as well as to time the execution of the activities. This technique has been adopted by a few studies in Australia (Lo et al. 2010; Westbrook et al. 2008;), with the aim to quantify the time medical staff spent in patient care activities. 19 consultants/senior doctors in the ED will each be observed at random and each observation session will last for 2 hrs. Observations will be conducted for the first two weeks of each month and 2 observation sessions will be carried out on week days for a period of 3 months.

Qualitative data will be collected through structured interviews with the same participants that were shadowed. When conducting semi structured interviews 'open, direct, verbal questions will be used to elicit detailed narratives and stories' (DiCicco-Bloom and Crabtree 2006) as cited in Whiting (2008).

## 4 Conclusion

This study is a continuation into stage three of a longitudinal study which evaluates how the introduction of IS can affect organisational change over time with regards to work structure and time spent on the different tasks relating to patient care. We will reach a deeper understanding than previous studies which have focussed on differences in working hours and habits as opposed to broader socio-logical and cultural issues that affect the ways tasks are carried out. A final goal of the project is to propose a systematic and practical way of managing the implementation of hospital IS for better achievement of intended organisational goals.

## 5 References

- Agarwal, R., Gao, G., DesRoches, C., and Jha, A.K. 2011. “The role of information systems in healthcare: Current research and road ahead,” *Information Systems Research*, (22), July, pp 419-428.
- Emergency department care 2016–17: Australian hospital statistics. <https://www.aihw.gov.au/reports/hospitals/ahs-2016-17-emergency-department-care/contents/table-of-contents>. Retrieved 26 July 2018.
- Australian Digital Health Agency. <https://conversation.digitalhealth.gov.au/australias-national-digital-health-strategy> Retrieved 26 July 2018.
- Baumgart, A., and Neuhauser, D. 2009. “Frank and Lillian Gilbreth: scientific management in the operating room,” *Quality and Safety in Health Care*, (18:5), July, pp 413-415.
- Bernstein, S., Aronsky, D., Duseja, R., Epstein, S., Handel, D., Hwang, U., McCarthy, M., John McConnell, K., Pines, J., Rathlev, N., Schafermeyer, R., Zwemer, F., Schull, M. and Asplin, B. 2009. “The Effect of Emergency Department Crowding on Clinically Oriented Outcomes,” *Academic Emergency Medicine*, (16:1), July, pp.1-10.
- Berg, M. 2003. “The search for synergy: interrelating medical work and patient care information systems,” *Method of Information in Medicine*, (42), June, pp 337–344.
- Cameron, P.A., Bradt, D.A., and Ashby, R. 1996. “Emergency medicine in Australia,” *Annals of Emergency Medicine*, (28:3), July, pp 342-346.
- Chaudhry, B., Wang, J., Wu, S., Maglione, M., Mojica, W., Roth, E., Morton, C., and Shekelle, P.G. 2006. “Systematic review: impact of health information technology on quality, efficiency, and costs of medical care,” *Annals of internal medicine*, (144:10), July, pp 742-752.
- Cresswell, J.W., and Clark, V.L.P. 2011. *Designing and Conducting Mixed Methods Research*. SAGE Publications Inc, California.

- Cresswell, K. 2016. *Evaluation of Implementation of Health IT* in: E. Ammenwerth, M. Rigby (eds.), Evidence-Based Health Informatics, Stud Health Technol Inform 222, IOS Press, Amsterdam, 2016.
- Cresswell, K.M., Bates, D.W., and Sheikh, A. 2013. "Ten key considerations for the successful implementation and adoption of large-scale health information technology," *Journal of the American Medical Informatics Association*, (20:e1), October, pp e9-e13.
- Cresswell, K., and Sheikh, A. 2013. "Organizational issues in the implementation and adoption of health information technology innovations: An interpretative review," *International Journal of Medical Informatics*, (82:5), June, pp e73-e86.
- Fan, H., and Lederman, R. 2018. "Online health communities: how do community members build the trust required to adopt information and form close relationships?" *European Journal of Information Systems*, (27: 1), October, pp 62-89.
- Fan, H., Lederman, R., Smith, S., and Chang, S. 2014. "How Trust Is Formed in Online Health Communities: A Process Perspective", *Communications of the Association for Information Systems*, (34), Article 28.
- Fan, H., Lederman, R., Smith, S., and Chang, S. 2010. "Why People Trust in Online Health Communities: An Integrated Approach", *21st Australasian Conference on Information Systems*, December 1-3.
- Fan, H., Lederman, R., Smith, S., and Chang, S. 2013. "How Online Health Forum Users Assess User-Generated Content: Mixed-Method Research", *European Conference in Information Systems*
- Forero, R., Hillman, K., McCarthy, S., Fatovich, D., Joseph, A. and Richardson, D. 2010. "Access block and ED overcrowding," *Emergency Medicine Australasia*, (22:2), June, pp 119-135.
- Gomm, R., Hammersley, M., and Foster, P (eds.). 2000. *Case Study Methods*. London: Sage Publications.
- Hoffman, J.M., Zorc, J.J., and Harper, M.B. 2013. "IT in the ED: Past, Present, and Future," *Paediatric Emergency Care*, (29:3), June, pp 402-405.
- Honeyman, M., Dunn, P., and McKenna, H. 2016. "A digital NHS? An introduction to the digital agenda and plans for implementation." <https://www.kingsfund.org.uk/publications/digital-nhs> Retrieved 26 July, 2018.
- Jones, P.G. and Thornton, V. 2013. "Does cost drive primary care patients to New Zealand's emergency departments? A systematic review," *New Zealand Medical Journal*, (126:1387), June, pp 15.
- Kane, B., and Luz, S. 2015. "Medical teamwork, collaboration and patient-centred care," *Behaviour & Information Technology*, (34:6), pp 543-547, DOI: 10.1080/0144929X.2015.1033181 Retrieved August 6 2018
- Kee, R., Knott, J.C., Dreyfus, S., Lederman, R., Milton, S., and Joe, K. 2012. "One hundred tasks an hour: An observational study of emergency department consultant activities", *Emergency Medicine Australia*, (24:3), October, pp 294-302.
- Kesilwe, A, Lederman, R., Dreyfus, S., and Knott, J. 2018. "A time Motion Study Evaluating the Impact of Information Technology on Emergency Department Consultant Activities," *Twenty-Sixth European Conference on Information Systems (ECIS2018), Portsmouth, UK, 2018*.
- Lapointe, L., and Rivard, S. 2007. "A triple take on information system implementation," *Organization Science*, (18:1), April, pp 89-107.
- Laxmisan, A., Hakimzada, F., Sayan, O.R., Green, R.A., Zhang, J., and Patel, V.L. 2007. "The multitasking clinician: decision-making and cognitive demand during and after team handoffs in emergency care." *International Journal of Medical Informatics*, (76:11), July, pp 801-811.
- Lederman, R., and Ben-Assuli, O. 2017. "Editorial: Patient-centered health information technology: Preparing for a new era." *Health, Policy and Technology*, (6: 1), October, pp 1-2.
- Lederman, R., Fan, H., Smith, S., and Chang, S. 2014. "Who can you trust? Credibility assessment in online health forums" *Health, Policy and Technology*, (3:1), October, pp 13-25.
- Lederman, R., Kurnia, S., Peng, F., and Dreyfus, S. 2015. "Tick a box, any box: a case study on the unintended consequences of system misuse in a hospital emergency department", *Journal of Information Technology Teaching Cases*, (5:2) October, pp 74-83.

- Moskop, J.C., Sklar, D.P., Geiderman, J.M., Schears, R.M. and Bookman, K.J. 2009. "Emergency department crowding, part 1—concept, causes, and moral consequences," *Annals of Emergency Medicine*, (53:5), May, pp 605-611.
- Peng, F., R., Kurnia, S., Lederman, R. and Dreyfus, S. 2013. "Exploring the Impact of Information System Introduction: The Case of an Australian Hospital Emergency Department", *46th Hawaii International Conference on System Sciences*.
- Peng, F., Sharma, R., Kurnia, S., Lederman, R. and Dreyfus, S. 2010. "Organisational culture and organisational impacts of information systems: A review of the empirical literature". *21st Australasian Conference on Information Systems*, October, pp 1-12.
- Redhead, C.S. 2009. "The Health Information Technology for Economic and Clinical Health (HITECH) Act, The Congressional Research Service." <https://digital.library.unt.edu/ark:/67531/metadc743451/> Retrieved 3 August 2018.
- Selck, F.W., and Decker, S.L. 2016. "Health information technology adoption in the emergency department," *Health services research*, (51:1), July, pp 32-47.
- Shekelle, P., Morton, S.C., and Keeler, E.B. 2006. "Costs and benefits of health information technology,". *Evidence Report/Technology Assessment No. 132*. (Prepared by the Southern California Evidence-based Practice Center under Contract No. 290-02-0003.) AHRQ Publication No. 06-E006. Rockville, MD: Agency for Healthcare Research and Quality.
- Taylor, N., Lederman, R., and Bosua, R. 2017. "Person-centred information for discharge home" The *28th Australasian Conference in Information Systems*, Hobart, Dec 4-7.
- Taylor, T.B. 2004. "Information management in the emergency department." *Emergency medicine clinics of North America*, (22), July, pp 241–257.
- Wang, L. 2009. "An agent-based simulation for workflow in emergency department," *In Systems and Information Engineering Design Symposium*. SIEDS'09 July, pp 19-23
- Vartak, S., Crandall, D.K., Brokel, J.M., Wakefield, D.S., and Ward, M.M. 2009. "Professional practice and innovation: transformation of emergency department processes of care with EHR, CPOE, and ER event tracking systems," *Health Information Management Journal*, (38:2), October, pp 27-32.
- Vezyridis, P., Timmons, S., and Wharrad, H. 2011. "Going paperless at the emergency department: a socio-technical study of an information system for patient tracking." *International Journal of Medical Informatics*, (80:7), July, pp 455-465.
- Westbrook, J.I., Duffield, C., Li, L., and Creswick, N.J. 2011. "How much time do nurses have for patients? A longitudinal study quantifying hospital nurses' patterns of task time distribution and interactions with health professionals," *BMC Health Services Research*, (11:1), pp 319. <https://doi.org/10.1186/1472-6963-11-319> Retrieved 20 July 2018
- Wynn Jr, D., and Williams, C.K. 2012. "Principles for Conducting Critical Realist Case Study Research in Information Systems," *MIS Quarterly*, (36:3), July, pp 787-810.
- Zheng, K., Guo, M.H., and Hanauer, D.A. 2011. "Using the time and motion method to study clinical work processes and workflow: methodological inconsistencies and a call for standardized research," *Journal of the American Medical Informatics Association*, (18:5), April, pp 704-710.

## Copyright

**Copyright:** © 2018 authors. This is an open-access article distributed under the terms of the [Creative Commons Attribution-NonCommercial 3.0 Australia License](https://creativecommons.org/licenses/by-nc/3.0/au/), which permits non-commercial use, distribution, and reproduction in any medium, provided the original author and ACIS are credited.

## Telehealth Adoption: Three case studies at the organisational level

### **Sophie Cockcroft**

School of Management and Enterprise  
University of Southern Queensland  
Springfield QLD Australia  
Email: [sophie.cockcroft@usq.edu.au](mailto:sophie.cockcroft@usq.edu.au)

### **Jane Hendy**

Brunel Business School  
Brunel University, London  
Email: [jane.hendy@brunel.ac.uk](mailto:jane.hendy@brunel.ac.uk)

We present the results of an inductive analysis using interview data to establish core themes in organisational level adoption of telehealth. The source of the interview data was a large study to evaluate how telehealth can promote long term health and independence and improve quality of life for people suffering from chronic health conditions. The study took place over three different pilot sites and 41 interviews were conducted with healthcare professionals who collectively had responsibility for over 5000 patients. We explore the data from the perspective of the organisation, focussing on the unique features of each pilot site and seeking evidence for themes of adoption success at the organisational level, particularly via organisational identity. We explore the data via a set of propositions based on organisational identity theory and models of technology adoption. The major finding of this work is that experience in the adoption of telecare was found to detract from telehealth adoption success.

**Keywords** Telehealth, Telecare, Telemedicine, Organizational theory, Technology adoption

# 1 Introduction and definitions

The present work is a qualitative study at the confluence of Information Systems (IS) and management. It is focussed on Healthcare at the organisational level. It explores how the nature of macro and meso levels (top and middle) in an organisation impact on technology adoption. Likewise in IS there are a preponderance of studies exploring the individual level of IS interaction, but less at the organisational level (Burton-Jones and Gallivan 2007). However, there has been an emergence of context specific theories, as opposed to general theories, surrounding adoption and use, which by their nature have a more organizational focus (Hong et al. 2013). Theories exist within IS that have evolved with a focus on external validity. That is the more general a theory is, the wider its applicability. Context specific theories are those which acknowledge that technology cannot be studied outside its social context. In particular such work explores how a network of affordances, i.e. factors that support use, lead to the achievement of organizational goals and how these affordances are put into action (Strong et al. 2014). The work presented here is specific to the context of telehealth adoption.

Telemedicine and telehealth have received some interest in the Information Systems literature but comparatively few papers explore organisational aspects (Al-Qirim 2007; Bower et al. 2011; Christensen et al. 2014; Elbanna and Linderoth 2015; Harrop 2001; Hu et al. 2002; LeRouge et al. 2012; Norum et al. 2007a; Norum et al. 2007b; Tarakci et al. 2009). A significant contribution to telemedicine research is the momentum project in Europe, deliverable 3.4 of which, published in 2016 (Jensen et al. 2016) reveals some findings in common with the present work. Which are discussed at the end of this paper.

We propose that one contributing factor in this research gap is that the organization has not been examined as an actor with agency in its own right with history and work practices that need to be accounted for. In this work we look at a unique set of cases in which the mandate for adoption came from the national level. By examining the history and culture (as expressed by organizational characteristics) of each of the three organizations and via a comprehensive set of interview data, we use inductive analysis to develop initial theoretical prepositions based on organizational theory, theory of effective use and models of technology adoption. We then perform a deductive analysis, following the approach of (Rivard et al. 2011) to test our propositions on the relationship between telehealth intervention and admissions, barriers to participation, experience of frontline health care professionals and organizational alignment. One interesting finding was that prior adoption experience was found to detract from adoption success. The major contributions of the work are first, the identification of themes that account for an organizational level of adoption and, second, the development of a model of organizational identity and processes and their impact on outcomes in technology adoption.

For the purposes of this study we adopt the following definitions of Telecare, Telehealth and telemedicine (Bower et al. 2011)

*Telecare is the remote, automatic and passive monitoring of changes in an individual's condition or lifestyle (including emergencies) in order to manage the risks of independent living. Examples include movement sensors, falls sensors, and bed/chair occupancy sensors. These technologies are generally provided to patients with social care needs.*

*Telehealth describes a system that allows the remote exchange of data between a patient (at home) and health care professionals (at a Monitoring Centre) to assist in the management of an existing long-term condition(s) (Chronic obstructive pulmonary disease (COPD), diabetes, heart failure). The peripheral devices used by intervention participants in the Whole System Demonstrator (WSD) Telehealth Trial to monitor vital signs were tailored to their clinical needs and could include a blood pressure monitor, blood glucose monitor, blood oxygen monitor and weight scales*

*Telemedicine is the most comprehensive of the three definitions and is sometimes conceptualised as encompassing them. The WHO definition of telemedicine or e-health is, 'the practice of medical care using interactive audio-visual and data communications. This includes the delivery of medical care, diagnosis, consultation and treatment, as well as health education and the transfer of medical data'*

## 1.1 Research Question:

How does organisational identity at the meso level impact on the adoption of innovations in the context of healthcare?

## 1.2 Background and Propositions

King et al. (2010) highlighted the need to understand explicate and research the qualities of organizations as social actors. Organizations are typically portrayed as aggregations of individuals, or actors in a social network without agency in their own right. In an earlier study Albert and Whetten (1985) identified the features of an organizational identity as central, enduring, and distinctive/distinguishing (CED). A Central feature is one that has changed the history of the company; if this feature was missing, the history would have been different. Enduring features are deeply engrained in the organization; they have stood the test of time and are often explicitly considered sacrosanct or embedded in the organizational history. Distinguishing features are used by the organization to separate itself from other similar organizations, but can also set minimum standards and norms for that type of organization.

King et al also discussed the notion of identity evolving within organizations. Organizations in their early stages of existence are more amenable to change. Hendy, Chrysanthaki and Barlow (Hendy et al. 2012) draw on the existing literature describing this change process describing how in order to succeed organizations need to go through a process of identity transformation. With reference to Fiol (2002) they argue that it is conceptually incorrect to regard organizations as nothing more than aggregated human behaviour. It is emerging that the uniqueness of organizations as social actors has implications for organization level research.

From the IS perspective, Bélanger et al. (2014) explored multilevel research specifically in the IS context, of interest here is the research area identified, that rejects the reductionist, individualist view of IS evaluation in favour of relational variables of the group such as conflict cohesion confidence and trust. Specifically in terms of Health Information Technology (HIT), Rivard, Lapointe and Kappos (2011) identified conflicting imperatives in clinical IS implementation. And finally at a more general level (Venkatesh et al. 2003) sought organizational impacts on IS success. We contend that the implementation of health systems in particular demands organizational level evidence for the purposes of accountability and interpretation of government mandates. Based on the studies described above, we put forward the following propositions

P1 Organisations in earlier stages of technological maturity will be more likely to succeed in implementing telehealth innovations (King, Felin et al. 2010)

P2 Esteem/Kudos and confidence within organisations promote adoption (Belanger et al. 2014)

P3 The conflict of strategic imperatives across professional groups (cost reduction and care) impact the success of telehealth innovations (Rivard et al. 2011)

P4 organisational context for example leadership, technological literacy impact on success of telehealth innovations (Venkatesh et al. 2003)

## 2 Description of the study

This work is based on a large, UK government funded, evaluation program surrounding the UK Whole System Demonstrator Programme (WSD) which ran from 2008-2011 it was the largest multisite evaluation of telehealth technologies to date. The study as a whole involved 6191 patients and 238 general practitioner practices. The evaluation (subset of project described here) concerned implementation, impact and acceptability of telecare and telehealth (Chrysanthaki et al. 2013). It was structured as a randomised control trial (RCT) in which some participants used telehealth innovations and others a more traditional telecare model. In this work we focus on telehealth adoption, as this was the main policy driver for the work because it was novel (and thought be cost saving) but was also largely unknown and not adopted (unlike telecare which was already widely spread throughout the UK). Healthcare professionals were engaged in delivering Telehealth devices to the target segment of patients and educating them in their use. Telehealth concerns the more data driven technical aspects of telemedicine as distinct from telecare which derives from a focus on home care via telecommunications. In terms of site selection the originators of the study framed the trial as a large scale, pragmatic health technology assessment trial, designed to randomise suitably large numbers of patients and assess the impact of a broad class of telemonitoring technologies in the context of routine delivery of NHS care. The impetus for this study was policy driven via the UK department of health.

In accomplishing the roll out of the new systems the Department of Health (DH) and local level organizations had very different interpretations of policy and goals and implementation process. We develop the concepts around this, and an analytical framework via formal brainstorming techniques and a modified grounded theory approach (Gioia et al. 2013). This research process is known as analytic induction.

The three sites in our study show contrasting characteristics; the first is an urban London borough with high density housing and culturally diverse population. The remaining two cases concern rural areas and demonstrate challenges more associated with remoteness, lack of public transport and an ageing population. The three organizations also had key differences in management approach. Differences are evident in terms of management styles and positioning of power, autonomy of professionals, and strategic alignment of cost of care and clinical effectiveness. The expected pace of implementation also differed. In particular, the sites all had the same project deadlines but their implementation delivery time differed. The rhetoric between sites differed quite markedly in terms of how they viewed the effective use of technology and how they understood success. In particular there is some conflict between Local authorities who traditionally manage social care and primary care trusts (PCTs) who take a more medicalised view. PCTs were largely administrative bodies, responsible for commissioning primary, community and secondary health services from providers. Since the study PCTs have been abolished in favour of clinical commissioning groups.

## **2.1 Case 1 Newham**

Newham is characterised as an urban, low socio-economic area with a large volume social housing. Public transport links are good. In Newham the organizational lead came from the Local Authority (LA), the London borough of Newham. They had a previous successful telecare service and there had been two minor telehealth trials one for diabetes and one for antenatal care. The money to run this service came from the social care budget of the borough council. They had a project champion in the form of the Mayor who made an early and significant investment in telecare. The project carried a lot of Kudos in the local community. In the transition to the WSD and the more medical approach of telehealth there were some challenges in communication between the LA and the Primary care trust (PCT). Health and social care, but they were encouraged by early success in this integration and winning the WSD bid to conduct the trial in Newham. There were expectations from the borough about large financial savings. The PCT and the LA which were attempting to integrate had separate IS and Finance departments which made the level of integration needed for WSD difficult. The ethnic diversity in the borough led to some difficulties with recruiting participants for the RCT. In adopting telehealth Newham started with new technology from Philips with which the LA was not familiar.

## **2.2 Case 2 Kent**

Kent is a rural community, with poor public transport links, and mixed employment opportunities. In Kent the organizational lead also came from the local authority. It is the largest local authority in England with 1.3 million people at the time of the study. They had a project champion in the form of a general practitioner (GP) but that person was in a minority amongst their profession. Many GPs felt alienated by the project and saw it as another overhead on their time. It was, however embraced by the community matrons. There was a high level of enthusiasm in phase I, but it waned in phase II. IT literacy among staff was assisted by the fact that they used the same telehealth provider (Viterion) as they had done in a prior successful trial (pre 2008). Kent had three primary care trusts, and this provided even greater communication challenges than Newham. In accomplishing the roll out of the new systems the Department of Health (DH) and local level organizations had very different interpretations of policy and goals and implementation process.

## **2.3 Case 3 Cornwall**

Cornwall is a coastal and rural community with some isolated communities and low employment rates. In Cornwall the organizational lead came from the PCT. There was a Local administration team – Cornwall NHS based in a central office, and TH monitoring nurses and Community matrons were attached to various GP surgeries throughout Cornwall. Cornwall had a delayed start due to a change in the choice of technology. However, when they were up and running, they had a quicker implementation. Cornwall started lower than the other two WSD sites in the sense that there had been no prior trials. In addition to organizational lead from the PCT they employed a management team to oversee the



implementation. WSD introduced a culture of competition between the sites, and while there was little time or opportunities to share knowledge and experience, in this case there was some discussion between West Kent and Cornwall which resulted in them taking up some of the same technology.

### 3 Methodology

Interviews were conducted, by experts, with stakeholders at all levels in the organization the study took place over three different pilot sites and 41 interviews were conducted with healthcare professionals and others who collectively had responsibility for over 5000 patients. The interviewees comprised 10 Local authority managers, 14 National Health Service Managers and 17 other associated staff. The interview data was analysed using a modified grounded theory approach described below.

(Gioia et al. 2013) provide guidelines for analysing interview data into first and second-order categories and developing these categories into a more structured form known as a data structure (see Figure 1). The data structure was developed via a brain storming session, and using the interview data. In the first-order analysis, interviewees' figures of speech were used and there was little attempt to develop explicit categories for open coding in a similar fashion to that proposed by Strauss and Corbin (2004). In the process advocated by Strauss and Corbin, where there is not a direct quote that can be drawn from the interview transcripts (yet a construct clearly exists) a short descriptive phrase is developed. In the second-order analysis, the authors extracted similarities and differences between these categories (i.e. we engaged in what Strauss and Corbin (2004) term axial coding) in order to develop the 1st order codes into themes. Finally, we aggregated similar second-order themes into five dimensions that make up the basis of the emergent data structure. Whilst no implicit relationship between second order factors is captured, this data analysis approach allows 'a recursive process-oriented, analytic procedure that continued until we firmly grasp the emerging theoretical relationships and additional interviews failed to reveal new data relationships' (Lapointe and Rivard 2005 p. 183). By this means we identified tensions, struggles, and fractures, at the intersection between local and DH policy.

### 4 Results

The interview data is encapsulated and summarised in the Gioia data structure (Figure 1) which tells the story of telehealth adoption at the three sites, and the common themes emerging. Generally organisations reacted to external policies/triggers from the department of health (left side of Figure 1), by drawing on identity, specific skills and expertise, and IT capabilities and Infrastructure. These would then trigger a search for meaning within the professional groups within the organisation, often engendering some misalignment, which impacted the success or otherwise of the telehealth delivery. This analysis reveals dynamic relationship around the intersection of policy at the UK government Department of health (DH - macro) and local (organizational - meso) level sometimes referred to as the level of the hive (Abrahams 2002), and how the organization as actor with identity, agency, history, context and local policy impacts on the adoption of innovation. In particular the effects of external factors (e.g. changes in government, and meso level tensions emanating from leadership and "followership" and the alignment of strategic objectives at different levels). That is, both changes in government at a national level and changes at a local level such as a change in the director of a local authority are likely to be the source of external factors. Followership is quality demonstrated by employees within an organization typified by a willingness to accept direction and guidance from leaders recognising that any effective organization needs both leaders and followers. The triggers for implementation at the macro level, came from a need to develop efficient ways of managing people with long term conditions. Some impetus for joining the study on behalf of the sites studied came from the *kudos* of being an early adopter. As the project progressed fractures emerged at various levels. In particular some professionals felt their autonomy was being taken away when they had to put aside patient care in favour of the RCT – for example not offering telehealth style monitoring to someone who could benefit from it. Or similarly, when pressure was felt to pursue cost saving over patient well-being. Thus the shared understanding of the meaning of care and what constituted success of the project was lost as the project progressed. In Newham the level of political connectedness to the macro or DH level was more pronounced with the presence of a Mayor who championed the project. In terms of WSD management structures, Cornwall emerged as an unexpected success story, having comparatively less telecare experience of IT infrastructure, the participants accepted the deployment of a management team to oversee the implementation.

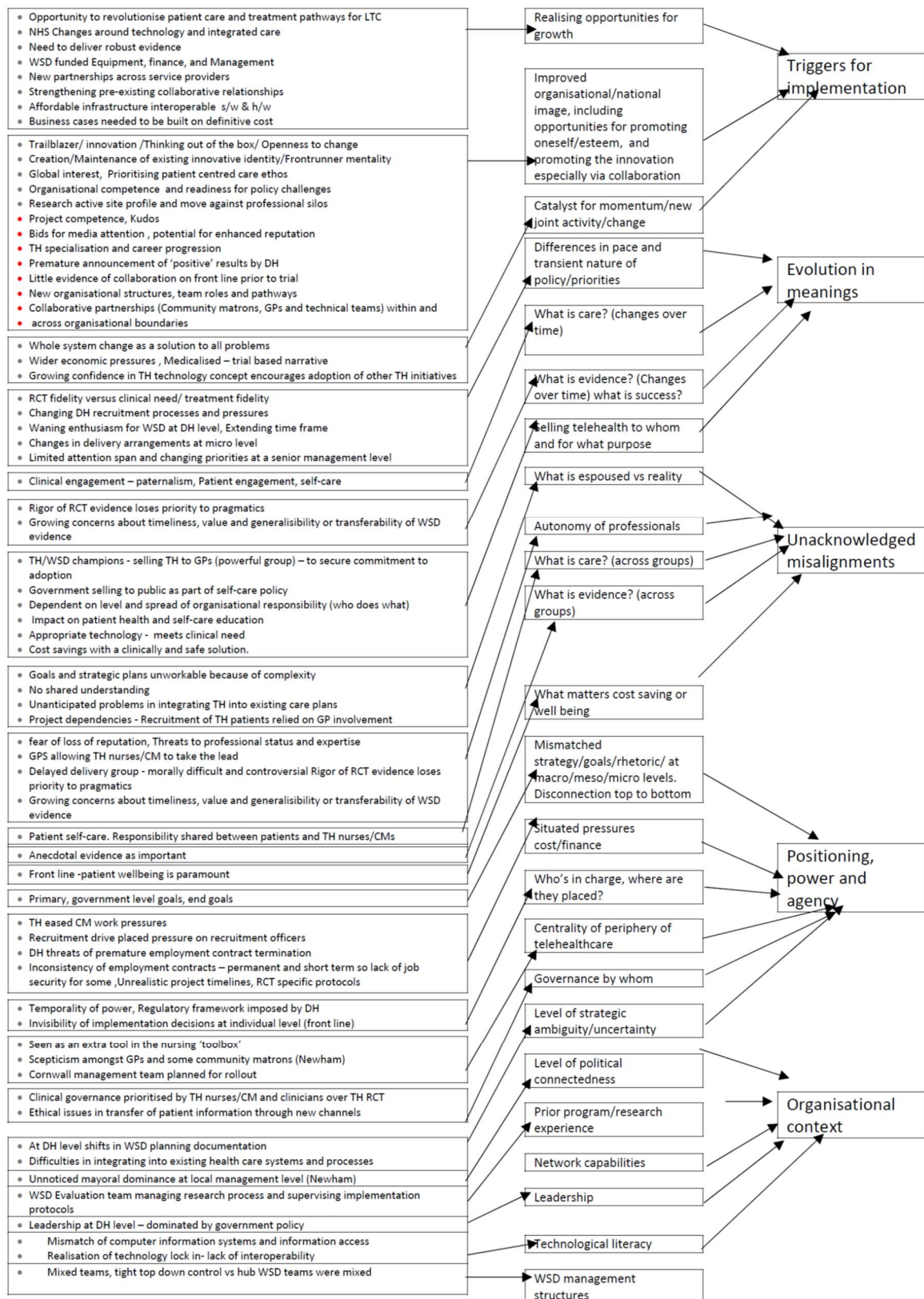

Figure 1 Gioia data structure

## 5 Discussion

In the early phase, the project managers wanted to present image of competence and were often very keen to go mainstream before they got the results of the trial and further. In addition the pace of the project was dictated by the DH and, in contrast at the local level, there was more emphasis on getting things right. Whilst the pressure of this permeated down it did not affect those at the bottom level. Between these two levels there was a switch between the priority being cost and the priority of wellbeing. This phenomenon was at the core of the mismatch in strategy as the policies permeated down.

GPs had enormous power and in some cases changed how the randomised control trial was run. In some cases interviewees suggested that GPs put up obstacles. Both nurses and doctors had monitoring schemes but the Doctors did not want to get involved with using them. Nurses were often on short term contracts. Many professionals felt that they had power in recruitment but not in delivery. On the flip side there was (anecdotally some power that was not visible in the form of nurses “rebellious” and deciding who should have telehealth). There was power in relation to governance National Institute for Health and Care Excellence (NICE) guidelines were promulgated from above but levels of accountability seemed to differ between sites. Some sites were more politically connected, for example Newham had the mayor on board. Cornwall did not have strategic certainty but their power derived from the fact that they employed a specialist management team to oversee the Nurses and equipment. Early analysis suggests that this qualitative study provides some support for theory from traditional IS adoption literature, but further analysis is required to provide pointers to the nature of mid-range context specific theory needed to explore the meso-level constructs unearthed in this work. In a general sense these findings overlap with the Key Performance Indicators identified by Jensen et al (2016) in the Momentum study. Specifically in regard to cultural readiness, the presence of a champion, and change management planning.

## 6 References

- Abrahams, M. 2002. "The Beehive of Organisational Excellence: Entrenching Workplace Practices That Lead to High Performance." Stellenbosch: Stellenbosch University.
- Al-Qirim, N. 2007. "Championing Telemedicine Adoption and Utilization in Healthcare Organizations in New Zealand," *International Journal of Medical Informatics* (76:1), pp. 42-54.
- Albert, S., and Whetten, D.A. 1985. "Organizational Identity," *Research in organizational behavior*.
- Belanger, F., Cefaratti, M., Carte, T., and Markham, S.E. 2014. "Multilevel Research in Information Systems: Concepts, Strategies, Problems, and Pitfalls," *Journal of the Association for Information Systems* (15:9), pp. 614-650.
- Bélanger, F., Cefaratti, M., Carte, T., and Markham, S.E. 2014. "Multilevel Research in Information Systems: Concepts, Strategies, Problems, and Pitfalls," *Journal of the Association for Information Systems* (15:9), p. 614.
- Bower, P., Cartwright, M., Hirani, S.P., Barlow, J., Hendy, J., Knapp, M., Henderson, C., Rogers, A., Sanders, C., Bardsley, M., Steventon, A., Fitzpatrick, R., Doll, H., and Newman, S. 2011. "A Comprehensive Evaluation of the Impact of Telemonitoring in Patients with Long-Term Conditions and Social Care Needs: Protocol for the Whole Systems Demonstrator Cluster Randomised Trial," *BMC Health Services Research* (11:1), p. 184.
- Burton-Jones, A., & Gallivan, M. J. 2007. Toward a deeper understanding of system usage in organizations: a multilevel perspective. *MIS quarterly*, pp 657-679.
- Christensen, H.B., Hansen, K.M., Kyng, M., and Manikas, K. 2014. "Analysis and Design of Software Ecosystem Architectures - Towards the 4s Telemedicine Ecosystem," *Information and Software Technology* (56:11), pp. 1476-1492.
- Chrysanthaki, T., Hendy, J., and Barlow, J. 2013. "Stimulating Whole System Redesign: Lessons from an Organizational Analysis of the Whole System Demonstrator Programme," *Journal of Health Services Research & Policy* (18), pp. 47-55.
- Corley, K.G., and Gioia, D.A. 2004. "Identity Ambiguity and Change in the Wake of a Corporate Spin-Off," *Administrative Science Quarterly* (49:2), pp. 173-208.
- Elbanna, A., and Linderoth, H.C.J. 2015. "The Formation of Technology Mental Models: The Case of Voluntary Use of Technology in Organizational Setting," *Information Systems Frontiers* (17:1), pp. 95-108.
- Fiol, C.M. 2002. "Capitalizing on Paradox: The Role of Language in Transforming Organizational Identities," *Organization Science* (13:6), pp. 653-666.
- Gagnon, M.P., Simonyan, D., Ghandour, E.K., Godin, G., Labrecque, M., Ouimet, M., and Rousseau, M. 2016. "Factors Influencing Electronic Health Record Adoption by Physicians: A Multilevel Analysis," *International Journal of Information Management* (36:3), pp. 258-270.
- Gioia, D.A., Corley, K.G., and Hamilton, A.L. 2013. "Seeking Qualitative Rigor in Inductive Research: Notes on the Gioia Methodology," *Organizational Research Methods* (16:1), pp. 15-31.
- Harrop, V.M. 2001. "Virtual Healthcare Delivery: Defined, Modeled, and Predictive Barriers to Implementation Identified," *Journal of the American Medical Informatics Association*), pp. 244-248.
- Hendy, J., Chrysanthaki, T., Barlow, J., Knapp, M., Rogers, A., Sanders, C., Bower, P., Bowen, R., Fitzpatrick, R., and Bardsley, M. 2012. "An Organisational Analysis of the Implementation of Telecare and Telehealth: The Whole Systems Demonstrator," *BMC health services research* (12:1), p. 1.
- Hong, W., Chan, F.K., Thong, J.Y., Chasalow, L.C., and Dhillon, G. 2013. "A Framework and Guidelines for Context-Specific Theorizing in Information Systems Research," *Information Systems Research* (25:1), pp. 111-136.
- Hu, P.J.H., Chau, P.Y.K., and Sheng, O.R.L. 2002. "Adoption of Telemedicine Technology by Health Care Organizations: An Exploratory Study," *Journal of Organizational Computing and Electronic Commerce* (12:3), pp. 197-221.
- Jensen, L.K., Knarvik, U., Pedersen, C.D., Wenche, T., and Whitehouse, D. 2016. "Deliverable 3.4 Personalised Blueprint for Telemedicine Deployment: Validated and Tested Version."
- King, B.G., Felin, T., and Whetten, D.A. 2010. "Perspective-Finding the Organization in Organizational Theory: A Meta-Theory of the Organization as a Social Actor," *Organization Science* (21:1), pp. 290-305.
- Lapointe, L., and Rivard, S. 2005. "A Multilevel Model of Resistance to Information Technology Implementation," *MIS quarterly*), pp. 461-491.
- LeRouge, C., Garfield, M.J., and Collins, R.W. 2012. "Telemedicine: Technology Mediated Service Relationship, Encounter, or Something Else?," *International Journal of Medical Informatics* (81:9), pp. 622-636.

- Norum, J., Pedersen, S., Størmer, J., Rumpsfeld, M., Stormo, A., Jamissen, N., Sunde, H., Ingebrigtsen, T., and Larsen, M.-L. 2007a. "Prioritisation of Telemedicine Services for Large Scale Implementation in Norway," *Journal of telemedicine and telecare* (13:4), pp. 185-192.
- Rivard, S., Lapointe, L., and Kappos, A. 2011. "An Organizational Culture-Based Theory of Clinical Information Systems Implementation in Hospitals," *Journal of the Association for Information Systems* (12:2), p. 123.
- Strong, D.M., Volkoff, O., Johnson, S.A., Pelletier, L.R., Tulu, B., Bar-On, I., Trudel, J., and Garber, L. 2014. "A Theory of Organization-Ehr Affordance Actualization," *Journal of the Association for Information Systems* (15:2), pp. 53-85.
- Tarakci, H., Ozdemir, Z., and Sharafali, M. 2009. "On the Staffing Policy and Technology Investment in a Specialty Hospital Offering Telemedicine," *Decision Support Systems* (46:2), pp. 468-480.
- Venkatesh, V., Morris, M.G., Davis, G.B., and Davis, F.D. 2003. "User Acceptance of Information Technology: Toward a Unified View," *MIS quarterly*), pp. 425-478.

## Copyright

**Copyright:** © 2018 Cockcroft & Hendy. This is an open-access article distributed under the terms of the [Creative Commons Attribution-NonCommercial 3.0 Australia License](https://creativecommons.org/licenses/by-nc/3.0/au/), which permits non-commercial use, distribution, and reproduction in any medium, provided the original author and ACIS are credited.

# A New Design Approach and Framework for Elderly Care Robots

## **Adam Poulsen**

School of Computing & Mathematics  
Charles Sturt University  
Bathurst, New South Wales  
Email: apouls02@postoffice.csu.edu.au

## **Oliver K. Burmeister**

School of Computing & Mathematics  
Charles Sturt University  
Bathurst, New South Wales  
Email: oburmeister@csu.edu.au

## **David Tien**

School of Computing & Mathematics  
Charles Sturt University  
Bathurst, New South Wales  
Email: dtien@csu.edu.au

## **Abstract**

A relatively new area within information systems is the design of robotic healthcare. This narrative review considers the question, how does one ethically design an elderly care robot? To answer this question, robot ethicists consider the ethical impact of robots, how designers ought to design robots ethically, and how a robot design ought to be, so its behaviour is ethical. The latter consideration defines another field of study, machine ethics. Machine ethicists ask, how does one design a robot information system to behave ethically? Thus, robot ethics is concerned with the ethics of design practice, whereas machine ethics is concerned with the ethics of the product designed. The findings from this narrative review point the way forward to how one can answer both questions with a new design approach that is grounded in care and professional ethics, value sensitive design, and the integration of two machine ethics schools of thought.

**Keywords** Ethics, Robot, Care, Systems, DSR.

## 1 Introduction

The question of how to conduct ethical design practice is not new, however, it is when applied to elderly healthcare robotics. In attempting to answer the robot ethics question, robot ethicists present care robot *design approaches*. Human-computer interaction (HCI) has long been an important area of information systems (IS) research relating to healthcare. For example, a proven healthcare IS approach, user-centred design (UCD) (Burmeister et al. 2016; Burmeister et al. 2015; Hagedorn et al. 2016; Pakrasi et al. 2015; Schnall et al. 2016), and another, value sensitive design (VSD) (Burmeister 2010; Burmeister 2016; Burmeister and Kreps 2018; Friedman 1996; Friedman et al. 2006; Teipel et al. 2016), have both been used and adapted to guide care robot design. Human-robot interaction (HRI) is relatively new in IS healthcare research. Care centered value sensitive design (CCVSD) (van Wynsberghe 2013a) is one of those adaptations of traditional approaches that accounts for HRIs. It is an approach that outlines the design theories, concepts, processes, methods, and evaluation criteria for ethically creating a care robot design. As shown in the continued literature review below, both UCD and VSD have been used in care robot design.

Recently machine ethicists have focussed on determining what a robot's behaviour ought to be—within the design process. As yet this is not done well and one of the contributions of this study is to help address this important consideration in IS research. Machine ethicists have tried to answer this question by contributing *design frameworks* to literature. A framework consists of a guiding school of thought, a set of ethics, an ethics-delivery method for providing a machine with ethics or how to turn ethics into behaviours, and an exemplary design. The following sections review the literature, beginning with robot ethics and related research. Next, the new approach suggested by the literature review is described.

## 2 Literature Review

The methodology for this study followed that of the narrative literature review beginning with a wide search that yielded 80 articles and then refining the results further to 31. It has been suggested that a narrative review of even five studies with a wide range of methods on a topic could draw sound conclusions because narrative literature reviews differ from empirical reviews of a large number of studies (Baumeister and Leary 1997). First, they can answer broad questions by identifying patterns and making connections across a number of studies on a topic with differing methodologies. Second, they can develop and validate conclusions and theories after the findings of individual empirical studies have been published. Third, they can accept questions not being answered by the current data and can instead highlight and offer ways to address underlying problems. Fourth, they can make different conclusions from the data, namely that the hypothesis was correct, could be correct but not proven, may or may not be correct, or is proven wrong. Finally, using a number of studies on a topic with differing methodological approaches can identify flaws, raise doubts in past conclusions and offer alternatives for any particular method.

Although narrative reviews have been criticised for being vulnerable to author bias, it has also been suggested that such criticism could be addressed by using a systematic approach to establish rigorous and evidence-based conclusions for both qualitative and quantitative reviews (Green et al. 2006). As such, this study applied an objective and scientific approach for selecting and reviewing the literature and included components generally expected by different guidelines for reporting studies, such as, Consolidated Standards of Reporting Trials (CONSORT), STrengthening the Reporting of OBServational studies in Epidemiology (STROBE), Preferred Reporting Items for Systematic Reviews and Meta-Analyses (PRISMA), and Standards for Reporting Diagnostic accuracy studies (STARD) (International Committee of Medical Journal Editors 2016).

To locate literature specifically about robotic healthcare, an advanced search criterion was employed. Using Charles Sturt University's Primo search engine, the following 4 strings were searched: "care robot", "care robots", "care robot design", and "care robot ethics". The potential results of each of the 4 searches were limited to only include journal articles published during or after 2005. Books, reviews, reports, and video presentations, as well as anything published before 2005, were excluded. The results were sorted by relevance. The first 2 pages of each of the 4 searches, each having 10 articles, were used. This presented a total of 80 articles published since 2005. Each abstract of those 80 articles was read to determine if the paper presented either an approach or a framework. Thirty-one articles were found to fit that brief, 9 approach related articles and 22 framework related articles. Of the 9 approach related articles, 6 were selected to highlight the use of traditional approaches, as well as adapted approaches, in care robot design. Moreover, of the 22 framework related articles, 11 were selected as exemplary representations for the purposes of this paper.

## 2.1 Robot & Machine Ethics

Robot ethics is concerned with the ethical impact of robots, how designers ought to design robots ethically, and how a robot design ought to behave (Malle 2016). The latter consideration is machine ethics, the study of how robots ought to act (Wallach and Allen 2009). A clear distinction between robot and machine ethics can be made in relation to a shared concern—design. Robot ethics explores the ethics of the designer while undertaking the design process. Robot ethics research considers how a roboticist goes about designing a robot ethically (a design approach). By contrast, machine ethics explores the ethics of the robot. Machine ethics research considers how a robot is to act ethically, how the design of the robot ought to be so that it is ethical, and how to provide those ethics (a design framework). A legal perspective provides a clear distinction between the two. In exploring the regulation of robot design and robot behaviour design, Leenes and Lucivero (2014) identify the legal distinction between the regulation of human beings (robot ethics) and the regulation of robot behaviour through design (machine ethics).

Design approaches describe how a designer ought to undergo the practice of design. Each approach provides practical design practices for one or more of the following for the design process: data gathering, data analysis, discussion of data, and application of data to the design process. UCD is an approach which brings users into the design process (Duarte and Guerra 2012; Vredenburg et al. 2002); by doing so it hopes to create products which are focussed on bettering the user experience (Abrams 2004; Strömberg 2005). VSD, another approach, aims to produce systems which are sensitive to indirect and direct stakeholders’ values by involving them in the design process (Friedman et al. 2006). UCD has been used for designing socially assistive long-term care robots (Di Nuovo et al. 2018), elderly care service robot interactions (Mast et al. 2012), and recommendations for every day, domestic robots (Sung 2011). VSD has also been applied to care robot design. It has been used for designing seizure detection systems (van Andel et al. 2015), retrospective analysis of therapeutic care robots (Melson et al. 2005), and humanoid care robot design (Cheon and Su 2016). These are examples of attempting to answer the robot ethics question. CCVSD is another attempt. CCVSD is a care robot specific approach that incorporates care ethics and Tronto’s (1993) care values as moral elements of a care practice as normative criteria for evaluating a care practice (van Wynsberghe 2013b).

Two machine ethics schools of thought can be identified. Moral robotics defines robots which are capable of making moral decisions (Wallach and Allen 2009). Moreover, moral robots are explicit (or full) ethical agents in the sense that they have ethical principles explicitly represented in their system for them to use to make moral decisions (Moor 2006). The antithesis of an explicitly ethical moral robot is an implicit ethical agent, belonging to good robotics, which has ethics embedded into its strictly preprogrammed implicit behaviour (Moor 2006). Machine ethicists present moral and good robot frameworks to try to answer the machine ethics question. A design framework encompasses the following components involved in designing the ethical behaviour of a care robot.

1. School – The machine ethics school of thought followed. The school is either moral robotics where the author recommends a design which has explicit ethical decision-making, or good robotics where the author recommends a design which is implicitly ethical.
2. Ethics set – A set of the ethics which ought to be provided to a care robot.
3. Ethics-delivery method – A method for translating the ethics into ethical behaviours.
4. Exemplary design – An exemplary care robot design.

Moral robotics frameworks are easy to derive from literature. Machine ethicists following the moral robotics school are attempting to provide a care robot with explicit ethical behaviours, thus the set of ethics and ethics-delivery method are explicitly stated. Good robotics frameworks, on the other hand, aren’t as clear; this is inherent in designing implicit ethical agents. Implicit agents, or good robots, are designed to be ethical, not to make ethical decisions. Thus, a good robot framework doesn’t strictly require a method, although one may be derived if the designer describes the technical details. However, they certainly feature a set of ethics that a designer either intentionally or unintentionally followed when making design decisions. Table 1 shows exemplary frameworks from both schools.

Author(s)	School	Ethics set	Ethics-delivery method	Exemplary design
-----------	--------	------------	------------------------	------------------



Shaw et al. (2018)	Moral robotics	Relative and evolving ethics. Human-like transparency to allow the care robot to justify its decisions. Imperfect ethics like a human.	Bottom-up learning method to provide ethics. Evolution of ethics that allows the care robot to learn new ethics in practice. A group-dynamic decision-making principle.	A care robot design which learns ethics subjectively without top-down limitations. The design includes a 'robot brain' with many 'voices' that test each other to reach a consensus.
(Anderson and Anderson 2008; 2017)	Moral robotics	Rossian deontology. Deontology declares universal moral duties and considers actions to be either moral or immoral based on the act itself rather than the consequence (Alexander and Moore 2016). Duties can collide and thus W.D. Ross suggested that the actual duty to be followed was that which was most stringent or ' <i>prima facie</i> ' ('first face') based on an individual's obligation.	A hybrid method made up of bottom-up case-based learning and a top-down principle that controls the learning process. The ethical training cases are predetermined, by an ethicist, to represent good or bad ethical decisions. Thus, the ethical principle that is learnt is inferred by the decisions of the ethicist; what is learnt is not random, it is predetermined.	A care robot design that is controlled by Rossian deontological <i>prima facie</i> duties, but the way it chooses which duty is right in situ is taught to the care robot explicitly and with predetermined results.
Sharkey and Sharkey (2011; 2012a; 2012b); Sparrow (2002; Sparrow and Sparrow (2006)	Good robotics	Deontology ethics		Collectively, the authors suggest a design that acts implicitly ethically, programmed with behaviours judged to be good by deontological standards. Contrasting the last framework, this one features no ethical decision-making. The authors promote respecting patient autonomy and dignity as key ethical duties.
Meacham and Studley (2017)	Good robotics	Care ethics	An action-driven method in which ethics are implicitly coded into care robot actions. The authors hold action to be the most important thing in robot delivered care, not robotic moral competence, agency, or any other element of moral robotics.	A care robot design that is implicitly ethical in its actions which are determined by a designer determining what 'meaningful context' is.

Table 1. Exemplary ethical design frameworks from both schools of machine ethics

## 2.2 Good Care

IS research has shown the importance of values in systems design thinking in many areas, including online applications (Chesney et al. 2009), in areas of e-Health (Boonstra and Van Offenbeek 2010), and emerging technologies (Dainow 2017). IS in healthcare is no exception. Good human-delivered care is grounded in both care ethics (Beauchamp and Childress 2009; Pakrasi et al. 2015) and professional ethics (Bernoth et al. 2016; Bower et al. 2006; Burmeister 2017); robot-delivered care should be no different. Care ethics describes good care decisions as being “determinative in practice” (Beauchamp 2004). They come from a caregiver’s subjective interpretation of a patient’s unique needs, which determines how we ought to behave to ensure those needs are met. Just as a human carer must make decisions affecting those in their care, during the practice of caring (Upton 2011), so too care robots must do so at run-time. In care ethics, it is considered ethical if a moral decision arises from the ‘good’ which is internal to practice, rather than external normative moral criteria or principles (Vallor 2011). Care ethics present principles that describe moral behaviour and action when taking care of someone (Vanlaere and Gastmans 2011), or patient care values that should be respected. Professional ethics, made up of codes of ethics, set ethical principles, values, practices, and processes for caregivers to uphold. Principles and processes do not determine the act which is best in specific situations. Instead, carers make this determination in practice, and care robots should do the same. However, that said, there are some normative principles within professional ethics that are intrinsic to care and must be respected by industry or organisation regulation. For example, the safety of a patient is regulated by professional codes of ethics and it is not up to carers to decide not to ensure intrinsic safety; however, how to achieve it is to be determined in practice. Thus, care ethics are determined by a carer’s interpretation of a patient’s individual needs as observed in the carer-patient relationship. Moreover, professional ethics are determined objectively by other parties. The European parliament’s report on robot legislation (Commission on Civil Law Rules on Robotics 2017), International Organisations of Standardization’s standard for care robots (International Organization for Standardization 2014), and International Council of Nurses’ code of ethics (2012) all describe professional ethics required in robot-delivered care.

Care values describe the principles and behaviours which recipients of care expect from social interactions. Due to its non-normative grounding in the importance of the subjective context, care ethics is best for describing the extrinsic care values in care practices. By contrast, due to its normative grounding in the importance of objective safety and a basic level of care, professional ethics best describes the intrinsic values of care practices. Extrinsic values are those that help to achieve intrinsic ones (Zimmerman 2015). Extrinsic care values are a patient’s unique wants and desires within a care practice, whereas intrinsic care values are those which describe the end goal of the care practice. Van Wynsberghe (2013a) claims that it is through the manifestation of values, during the design process of care robots, that one comes to understand what care really is in practice. Thus, care values are a good basis for design as they simply express patient needs, can be transformed into coded behaviours, and are supported by literature on technology design.

## 2.3 Previous Frameworks Integrating Moral and Good Robotics Design Considerations

Madl and Franklin (2015) suggest that a care robot be provided with a decision-making mechanism that is constrained to the domain and functionalities where the robot was intended to function, consists of a combination of explicit rules and implicit, heuristic strategies when processing decisions, and is adaptive. Constraining the robot’s ability to act and giving it implicitly ethical decision processes is making it implicitly ethical, or a good robot. Moreover, allowing it to make decisions from explicit rules and allowing it to adapt its decision-making is making it explicitly ethical, or a moral robot.

Madl and Franklin (2015) do not provide a design approach for how to design for such considerations, nor do they make a clear distinction between extrinsic and intrinsic values; while the authors’ framework answers the machine question by integrating moral and good robotics, it doesn’t answer the robot ethics question. A framework that does make such a distinction has been presented by Poulsen and Burmeister (2018). The authors offer ‘the attentive framework’, an elderly care robot design framework that recommends a moral robot design which is governed by dynamic extrinsic values to provide care ethics, as well as unchanging intrinsic values to provide professional ethics (although they do not identify the latter, nor connect them to the schools). The validity of the framework has been proven in a heuristic expert evaluation and an international online survey. Participants were presented with an exemplary design created using the framework, a medicine delivery robot that made dynamic value trade-offs in run-time. That is, it was a moral robot that adapts its behaviour to extrinsic patient values but always respected intrinsic values. The care robot presented to participants had an ethical decision-making

process that hypothetically allows it to interpret patient care values, structure extrinsic ones into a list, set value priorities in that list depending on how much the patient desired them (as interpreted by the robot), reaffirmed the priority consistently, and adapted its behaviour based on the ordering of extrinsic values to customise care to each patient. As for intrinsic values, those were said to be off-limits to the robot, thus it couldn't ever decide which intrinsic value was more important than another nor let an extrinsic value consideration be held higher than an intrinsic one. Upon testing the framework and design as a hypothetical artefact, 3 of the 4 experts and 76% of the survey participants thought the care robot was sensitive in making dynamic, extrinsic value decisions. The full results and further discussion are published elsewhere (Poulsen 2018; Poulsen et al. 2018a; Poulsen et al. 2018b). The study presented a framework and therefore attempted to answer the machine ethics question, which it did in theory. However, the authors never answered the robot ethics question, they did not provide an approach to practically designing a care robot based on the framework. Furthermore, what is missing from that work is a clear identification and integration of moral and good robotics and a concerted effort to merge robot and machine ethics. Therefore, this proposed research presents a new design approach to do just that. One that accounts for ethical design practice, the integration of the schools, and a merging of robot and machine ethics while attempting to design a care robot outlined by that framework.

The literature review has indicated several challenges with current approaches and frameworks. First, approaches fail to provide guidance in designing the ethical behaviour of a care robot (machine ethics design concerns). Second, frameworks are unhelpful in guiding design practice (robot ethics design concerns). Third, approaches and frameworks do not demonstrate good care as is described here. The literature review also suggests how to overcome these problems—an innovatively combined approach-framework (referred to simply as the new design approach). In the new approach, the non-contradictory, advantageous design elements of the machine ethics schools of thought are merged to support the creation of a CCVSD-adapted, implicit-explicit approach. The approach declares that robotic behaviour ought to be ethical by making them an implicitly and explicitly ethical agent so that the care provided is implicitly and explicitly good. That is, both questions can be answered with an approach that accounts for the design concerns of both robot and machine ethics together, rather than as exclusive design considerations. The new approach also accounts for good care through its grounding in care and professional ethics.

### 3 A New Approach is Needed

The new approach suggested by the above literature review needs to be grounded in good care determinants and needs to integrate the good robotics and moral robotics schools. This innovative design approach, which is merged with a framework, would inherently integrate robot and machine ethics with the shared concern for design—this integration answers the robot and machine ethics questions at the same time. The focus on design means that the design approach must present a comprehensive and guiding design approach and an interweaved framework suited to the approach. The design focus also distinguishes it from previous integration attempts that are centrally concerned with regulation and ethics. The design approach could be adapted from CCVSD where values are dependent on specific care practices, however with a small difference. To be grounded in good care determinants, it should take patient care values, and value interpretations, to be constantly changing. Moreover, the approach should recognise that each care practice has values that are unique to each patient and that those values change as patients age, are exposed to new experiences, or have interactions with new technologies (Sharkey 2014; van Wynsberghe 2013a). To integrate the two schools, the robot design itself should also be able to adapt to changing care values. Thus, accounting for individual interpretations of values, each patient's different value priorities, differences in value types, and how each patient's values may change is central to the new design approach—values in motion design (VMD).

To undertake VMD, first, a VSD conceptual investigation should commence. Conceptually, a designer should establish a model of user requirements and an initial framework adapted from the attentive framework. Second, a VSD empirical-technical investigation should start and participants for a *design workshop* should be recruited. A design workshop describes a focus group that brings in elderly persons, elderly caregivers, and a researcher to serve as a guide to conduct the VMD design process. In the design workshop, participants should be presented with the model of user needs and the initial framework which they will use to produce a care robot design. If possible, an ethicist and a robotics or HRI expert should be brought in as design workshop participants to help from their unique perspectives. However, if such participants cannot be sourced, the researcher may serve their roles. Participatory design such as this is a well-founded method in design practice (Duarte and Guerra 2012; Vredenburg et al. 2002).

From a care ethics perspective, VMD could promote and support the provision of subjective, dynamic care. From a professional ethics perspective, caregivers must uphold codes of ethics to ensure a standard

of quality care. From a VSD perspective, care ethics decisions could be described as the respecting of extrinsic patient care values whereas professional ethics decisions can be described as ensuring that intrinsic patient care values are provided. Putting extrinsic and intrinsic care values to use in the design approach's design process should be done with the *value tool*. VMD would be more focused on IS design considerations than physical ones, thus the value tool and framework emphasise software and robot behaviour design. To guide a practitioner undertaking the design process outlined by the approach, they would be provided with the value tool to help distinguish between extrinsic and intrinsic values, as well as a framework to provide design guidelines on how to translate values into a care robot design.

### 3.1 The Value Tool

Previously it was mentioned that values are dependent on care practices, a concept supported by literature (Tronto 1993; van Wynsberghe 2013a). Designers undertaking VMD would need a method to unravel a care practice to reveal all the values, distinguish between extrinsic and intrinsic values, and design a care robot to account for each value correctly according to its type. The value tool might serve as that method. The value tool consists of a table and steps for using the table. The steps have been adapted from the CCVSD methodology which explains how to extract values from a care practice by elaborating on it in a human-delivered care scenario, and then in a robot-delivered care scenario. With those two elaborations in competing contexts, the practitioner can compare them to reveal the positive and negative effects on care values due to the care robot introduction. The tool is to be used first by experts to establish a care robot design which satisfies all intrinsic values, as well as some recommendations for extrinsic values. Then it is to be used by design workshop participants to identify any further extrinsic values and amend the design to account for them. Using the value tool during the initial expert design stage, as well as for the design workshop, is to be carried out as follows.

#### *Expert steps*

1. Select a care practice and elaborate it, in two competing contexts, to reveal all relevant values. List it in the value tool table.
2. Identify which values are intrinsic and extrinsic in the care practice. List them in the value tool table.
  - a. To identify which values are intrinsic, experts are to consult regulation, nursing codes of conduct, and healthcare standards. Moreover, experts can provide insight into what is required in terms of patient safety and basic care in the care practice under consideration.
  - b. To identify which values are extrinsic, experts should simply to consider all values which aren't intrinsic as extrinsic.
3. Design for professional ethics care decisions by taking intrinsic values and discussing what end goals are needed to ensure intrinsic values, then consider hardcoded robot components to ensure those goals are always achieved. Use the value tool table to structure that discussion and list the design elements. Consult the framework to see how that can be achieved.
4. Design for care ethics decisions by taking extrinsic values and discussing how the robot could adapt its behaviour to respect each extrinsic value while achieving its intrinsic value goals, then design dynamic robot components for it to do so in practice. Use the value tool table to structure that discussion and list the design elements. Consult the framework to see how that can be achieved.

#### *Workshop participant steps*

1. Examine the care robot designed by experts.
2. Select a care practice listed in the value tool table and elaborate it, in two competing contexts, to reveal all relevant extrinsic values only. Elaboration might consist of having a walkthrough of the care practice with multiple participants, as well as discussing it as a group.
3. Identify which values are extrinsic in the care practice. List them in the value tool table.
  - a. To identify which values are extrinsic, elderly persons and caregivers who are participating could be consulted. The elderly persons should be encouraged to discuss what they desire from a caregiver who is performing a care practice. What their desires are is the extrinsic values of that care practice.

4. Design for care ethics decisions by taking extrinsic values (those identified by both the experts and the participants) and discussing how the robot could adapt its behaviour to respect each extrinsic value while achieving its intrinsic value goals, then design dynamic robot components for it to do so in practice. Use the Table 2 value tool to structure that discussion and list the design elements. Consult the framework to see how that can be achieved.

Care practice	Intrinsic values	Robot design elements needed to ensure intrinsic values	Extrinsic values	Robot design elements needed to ensure extrinsic values
---------------	------------------	---	------------------	---

Table 2. The value tool table

### 3.1.1 Example of Using the Value Tool

Take the care practice ‘bath patient’ for example. Without VMD, designers may program a robot to close the curtains around the bath to respect the patient’s dignity. However, what if the patient feels threatened by that, or they feel alone with a robot they do not entirely understand or trust, or they do not like enclosed spaces, or they feel like they are endangered because they are hidden from a human caregiver seeing them if they were drowning, or perhaps they would like to talk to their partner in the doorway. Instead what if intrinsic and extrinsic values were declared. One could examine nursing codes of ethics to reveal the intrinsic values of bathing a patient: hygiene and safety for example. Then if caregivers and patients are consulted, extrinsic values could be discovered: privacy, dignity, social contact, emergency help, happiness, touch, eye contact, independence, and comfort for example. The intrinsic values should be embedded into the design of the care robot, the assurance of them shouldn't be conflicted by any other possible action. In this case, to ensure the value of hygiene the robot could have a cleaning function to clean the patient, have cameras to see any dirt on the patient, and arms and hands to hold a sponge. To ensure safety, the cameras might observe the patient to ensure their head is above water and to see any distress and one arm could be at the ready to grab the patient under the arm to pull them up if they are drowning. Now that hygiene and safety have been implicitly embedded into the design, one can consider the extrinsic values. Such values should be represented explicitly in the robot’s physical and information systems. One can design any number of functions/behaviours (that can even conflict with each other) and provide them to the IS for it to determine during run-time which is the best behaviour to suit the patient’s desires. For privacy, the robot could avert its anthropomorphic eyes and could delete the video logs (a few hours after the bath just in case the patient is hurt, and the recordings are needed for liability. The robot ought to be able to sense when an injury occurs to account for this). For dignity, the robot could shut a curtain around the bath. For happiness, the robot could turn on the radio or TV or talk to the patient. Do this for all extrinsic values. Such behaviours may conflict because the care robot is to observe patients and decide which behaviour they would prefer during run-time—what the attentive framework presented above called dynamic value trade-offs in run-time. This feature is also recommended by VMD since it merges with the attentive framework.

Care practice	Intrinsic values	Robot design elements needed to ensure intrinsic values	Extrinsic values	Robot design elements needed to ensure extrinsic values
Bath patient	Hygiene	A cleaning function to clean the patient. Cameras to see any dirt on the patient. Arms and hands to hold a sponge.	Privacy	Avert anthropomorphic eyes. Delete video recordings (a few hours after the bath just in case the patient is hurt, and the recordings are needed for liability).
	Safety	Cameras could observe the patient to ensure their head is above water and to see any distress.	Dignity	Shut a curtain around the bath.

Table 3. An example use of the value tool table

## 4 IS Systems Thinking is Required

Following the design-science research (DSR) methodology is a proven best practice for IS design research (Helms et al. 2010; Hevner et al. 2004; Peffers et al. 2007). DSR is described by Hevner et al.

(2004) as being both a set of activities (process) and a design product (artefact). It focuses on developing innovative or more efficient and effective ways to address unresolved problems (Hevner et al. 2004). DSR research must be relevant and rigorous. That is, it must have a clear contribution to literature and that one must construct that contribution (a design artefact) with iterative build-evaluate phases (Hevner et al. 2004). DSR might prove a good research methodology for testing VMD. In keeping with the DSR methodology, VMD could be empirically tested to determine its practicality. Furthermore, it could be evaluated for its effectiveness and efficacy compared to existing approaches, or what DSR refers to as methods (Hevner et al. 2004). Through testing VMD, a new care robot design, or what DSR labels an instantiation (Hevner et al. 2004), would emerge. The instantiation would consist of physical robotic components and an IS. This could also be evaluated against criteria for meeting user needs, or what DSR refers to as a model (Hevner et al. 2004). Following DSR processes, based on an evaluation of the method and the instantiation, the method could be amended from an analysis of that evaluation to make it more effective and efficient for practitioner use, as well as to make sure it best meets user needs as described by the model. In this way, DSR could be used to produce an effective and efficient approach which accounts for good care and addresses the robot and machine ethics questions.

## 5 Conclusion

The narrative review points to how VMD design could be an all-in-one solution to the robot and machine ethics questions. VMD is an instructive approach grounded in good care and CCVSD for guiding design practice (robot ethics). It is supplemented by the recommended framework which is also grounded in good care (machine ethics). With VMD, designers could ethically produce a care robot design that demonstrates good care through the provision of implicitly safe and good professional ethics decisions (good robotics), as well as explicitly customised care ethics decisions (moral robotics). DSR could be used to empirically test the efficiency and effectiveness of VMD in practice to bring it out of theory and into the hands of practitioners. Although this paper has focussed on care for elderly persons, there is no reason why VMD could not be used in care for others such as the handicapped, soldiers suffering from post-traumatic stress disorder, or cancer patients weakened by chemotherapy.

## 6 References

- Abras, C., Maloney-Krichmar, D., Preece, J. 2004. "User-Centered Design," in: *Encyclopedia of Human-Computer Interaction*, W. Bainbridge (ed.). Thousand Oaks: Sage Publications.
- Alexander, L., and Moore, M. 2016. "Deontological Ethics," in: *The Stanford Encyclopedia of Philosophy*, E.N. Zalta (ed.). Stanford, CA: Stanford University.
- Anderson, M., and Anderson, S. L. 2008. "Ethel: Toward a Principled Ethical Eldercare System," *AAAI Fall Symposium: AI in Eldercare: New Solutions to Old Problems*.
- Anderson, M., and Anderson, S. L. 2017. "A Value Driven Agent: Instantiation of a Case-Supported Principle-Based Behavior Paradigm," in: *AAAI 2016 Workshop on AI, Ethics & Society*.
- Baumeister, R. F., and Leary, M. R. 1997. "Writing Narrative Literature Reviews," *Review of General Psychology* (1:3), p. 311.
- Beauchamp, T. L. 2004. "Does Ethical Theory Have a Future in Bioethics?," *The Journal of Law, Medicine & Ethics* (32:2), pp. 209-217.
- Beauchamp, T. L., and Childress, J. F. 2009. *Principles of Biomedical Ethics*. Oxford: Oxford University Press.
- Bernoth, M., Burmeister, O. K., Morrison, M., Islam, M. Z., Onslow, F., and Cleary, M. 2016. "The Impact of a Participatory Care Model on Work Satisfaction of Care Workers and the Functionality, Connectedness and Mental Health of Community-Dwelling Older People," *Issues in Mental Health Nursing* (37:6), pp. 1-7.
- Boonstra, A., and Van Offenbeek, M. 2010. "Towards Consistent Modes of E-Health Implementation: Structural Analysis of a Telecare Programme's Limited Success," *Information Systems Journal* (20:6), pp. 537-561.
- Bowern, M., Burmeister, O. K., Gotterbarn, D., and Weckert, J. 2006. "Ict Integrity: Bringing the Acs Code of Ethics up to Date," *Australasian Journal of Information Systems* (13:2), pp. 168-181.
- Burmeister, O. K. 2010. "Websites for Seniors: Cognitive Accessibility," *International Journal of Emerging Technologies and Society* (8:2), pp. 99-113.
- Burmeister, O. K. 2016. "The Development of Assistive Dementia Technology That Accounts for the Values of Those Affected by Its Use," *Ethics and Information Technology* (18:3), pp. 185-198.
- Burmeister, O. K. 2017. "Professional Ethics in the Information Age," *Journal of Information, Communication & Ethics in Society* (15:4), pp. 348-356.

- Burmeister, O. K., Bernoth, M., Dietsch, E., and Cleary, M. 2016. "Enhancing Connectedness through Peer Training for Community-Dwelling Older People: A Person Centred Approach," *Issues in Mental Health Nursing* (37:6), pp. 1-6.
- Burmeister, O. K., Islam, M. Z., Dayhew, M., and Crichton, M. 2015. "Enhancing Client Welfare through Better Communication of Private Mental Health Data between Rural Service Providers," *Australasian Journal of Information Systems* (19), pp. 1-14.
- Burmeister, O. K., and Kreps, D. 2018. "Power Influences Upon Technology Design for Age-Related Cognitive Decline Using the Vsd Framework," *Ethics and Information Technology* (20:3).
- Cheon, E., and Su, N. M. 2016. "Integrating Roboticist Values into a Value Sensitive Design Framework for Humanoid Robots," in: *The Eleventh ACM/IEEE International Conference on Human Robot Interaction*. Christchurch, New Zealand: IEEE Press, pp. 375-382.
- Chesney, T., Coyne, I., Logan, B., and Madden, N. 2009. "Grieving in Virtual Worlds: Causes, Casualties and Coping Strategies," *Information Systems Journal* (19:6), pp. 525-548.
- Commission on Civil Law Rules on Robotics. 2017. "P8\_Ta(2017)0051."
- Dainow, B. O. 2017. "Threats to Autonomy from Emerging Icts," *Australasian Journal of Information Systems* (21), pp. 1-16.
- Di Nuovo, A., Broz, F., Wang, N., Belpaeme, T., Cangelosi, A., Jones, R., Esposito, R., Cavallo, F., and Dario, P. 2018. "The Multi-Modal Interface of Robot-Era Multi-Robot Services Tailored for the Elderly," *Intelligent Service Robotics* (11:1), pp. 109-126.
- Duarte, J., and Guerra, A. 2012. "User-Centered Healthcare Design," *Procedia Computer Science* (14), pp. 189-197.
- Friedman, B. 1996. "Value-Sensitive Design," *Interactions* (3:6), pp. 17-23.
- Friedman, B., Kahn, P. H. J., and Borning, A. 2006. "Value Sensitive Design and Information Systems," in *Human-Computer Interaction and Management Information Systems: Foundations*, P. Zhang and D. Galletta (eds.). New York: M. E. Sharpe, pp. 348-372.
- Green, B. N., Johnson, C. D., and Adams, A. 2006. "Writing Narrative Literature Reviews for Peer-Reviewed Journals: Secrets of the Trade," *Journal of Chiropractic Medicine* (5:3), pp. 101-117.
- Hagedorn, T. J., Krishnamurty, S., and Grosse, I. R. 2016. "An Information Model to Support User-Centered Design of Medical Devices," *Journal of Biomedical Informatics* (62), pp. 181-194.
- Helms, R., Giovacchini, E., Teigland, R., and Kohler, T. 2010. "A Design Research Approach to Developing User Innovation Workshops in Second Life," *2010* (3:1).
- Hevner, A. R., March, S. T., Park, J., and Ram, S. 2004. "Design Science in Information Systems Research," *MIS Q.* (28:1), pp. 75-105.
- International Committee of Medical Journal Editors. 2016. "Preparing for Submission." from <http://www.icmje.org/recommendations/browse/manuscript-preparation/preparing-for-submission.html>
- International Council of Nurses. 2012. "The ICN Code of Ethics for Nurses." from <http://www.icn.ch/who-we-are/code-of-ethics-for-nurses/>
- International Organization for Standardization. 2014. "Robots and Robotic Devices -- Safety Requirements for Personal Care Robots." from <https://www.iso.org/standard/53820.html>
- Leenes, R., and Lucivero, F. 2014. "Laws on Robots, Laws by Robots, Laws in Robots: Regulating Robot Behaviour by Design," *Law, Innovation and Technology* (6:2), pp. 193-220.
- Madl, T., and Franklin, S. 2015. "Constrained Incrementalist Moral Decision Making for a Biologically Inspired Cognitive Architecture," in *A Construction Manual for Robots' Ethical Systems: Requirements, Methods, Implementations*, R. Trappl (ed.). Cham: Springer International Publishing, pp. 137-153.
- Malle, B. F. 2016. "Integrating Robot Ethics and Machine Morality: The Study and Design of Moral Competence in Robots," *Ethics and Information Technology* (18:4), pp. 243-256.
- Mast, M., Burmester, M., Krüger, K., Fatikow, S., Arbeiter, G., Graf, B., Kronreif, G., Pignini, L., Facal, D., and Qiu, R. 2012. "User-Centered Design of a Dynamic-Autonomy Remote Interaction Concept for Manipulation-Capable Robots to Assist Elderly People in the Home," *J. Hum.-Robot Interact.* (1:1), pp. 96-118.
- Meacham, D., and Studley, M. 2017. "Could a Robot Care? It's All in the Movement," in *Robot Ethics 2.0: From Autonomous Cars to Artificial Intelligence*, P. Lin, K. Abney and R. Jenkins (eds.). Oxford University Press.
- Melson, G. F., Peter H. Kahn, J., Beck, A. M., Friedman, B., Roberts, T., and Garrett, E. 2005. "Robots as Dogs?: Children's Interactions with the Robotic Dog Aibo and a Live Australian Shepherd," in: *CHI '05 Extended Abstracts on Human Factors in Computing Systems*. Portland, OR, USA: ACM, pp. 1649-1652.
- Moor, J. H. 2006. "The Nature, Importance, and Difficulty of Machine Ethics," *IEEE Intelligent Systems* (21:4), pp. 18-21.

- Pakrasi, S., Burmeister, O. K., McCallum, T. J., Coppola, J. F., and Loeb, G. 2015. "Ethical Telehealth Design for Users with Dementia," *Gerontechnology* (13:4), pp. 383-387.
- Peppers, K., Tuunanen, T., Rothenberger, M. A., and Chatterjee, S. 2007. "A Design Science Research Methodology for Information Systems Research," *Journal of Management Information Systems* (24:3), pp. 45-77.
- Poulsen, A. 2018. "Dynamic Value Trade-Offs in Run-Time to Provide Good, Customised Patient Care with Robots." Charles Sturt University, p. 116.
- Poulsen, A., and Burmeister, O. K. 2018. "Overcoming Carer Shortages with Care Robots: Dynamic Value Trade-Offs in Run-Time," *Australasian Journal of Information Systems* (22).
- Poulsen, A., Burmeister, O. K., and Kreps, D. 2018a. "The Ethics of Inherent Trust in Care Robots for the Elderly," in: *This Changes Everything – ICT and Climate Change: What Can We Do?*, D. Kreps, C. Ess, L. Leenen and K. Kimppa (eds.). Poznan, Poland: Springer International Publishing, pp. 314-328.
- Poulsen, A., Burmeister, O. K., and Tien, D. 2018b. "Care Robot Transparency Isn't Enough for Trust," in: *2018 IEEE Region 10 Symposium (TENSYP)*. Sydney, Australia.
- Schnall, R., Rojas, M., Bakken, S., Brown, W., Carballo-Dieguez, A., Carry, M., Gelaude, D., Mosley, J. P., and Travers, J. 2016. "A User-Centered Model for Designing Consumer Mobile Health (Mhealth) Applications (Apps)," *Journal of Biomedical Informatics* (60), pp. 243-251.
- Sharkey, A. 2014. "Robots and Human Dignity: A Consideration of the Effects of Robot Care on the Dignity of Older People," *Ethics and Information Technology* (16:1), pp. 63-75.
- Sharkey, A., and Sharkey, N. 2011. "Children, the Elderly, and Interactive Robots," *Robotics & Automation Magazine, IEEE* (18:1), pp. 32-38.
- Sharkey, A., and Sharkey, N. 2012a. "The Eldercare Factory," *Gerontology* (58:3), pp. 282-288.
- Sharkey, A., and Sharkey, N. 2012b. "Granny and the Robots: Ethical Issues in Robot Care for the Elderly," *Ethics and Information Technology* (14:1), pp. 27-40.
- Shaw, N. P., Stockel, A., Orr, R. W., Lidbetter, T. F., and Cohen, R. 2018. "Towards Provably Moral AI Agents in Bottom-up Learning Frameworks," in: *AAAI/ACM Conference on Artificial Intelligence, Ethics, and Society*. New Orleans, USA.
- Sparrow, R. 2002. "The March of the Robot Dogs," *Ethics and Information Technology* (4:4), pp. 305-318.
- Sparrow, R., and Sparrow, L. 2006. "In the Hands of Machines? The Future of Aged Care," *Minds and Machines* (16:2), pp. 141-161.
- Strömberg, H., Leikas, J., Ikonen, V., Iivari, N., Jokela, T., & Leurs, N. 2005. "User-Centred Design Guidelines for Methods and Tools," Nomadic Media.
- Sung, J. Y. 2011. "Towards the Human-Centered Design of Everyday Robots," in: *College of Computing*. Georgia Institute of Technology.
- Teipel, S., Babiloni, C., Hoey, J., Kaye, J., Kirste, T., and Burmeister, O. K. 2016. "Information and Communication Technology Solutions for Outdoor Navigation in Dementia," *Alzheimer's & Dementia: The Journal of the Alzheimer's Association* (12:6), pp. 695-707.
- Tronto, J. C. 1993. *Moral Boundaries a Political Argument for an Ethic of Care*. Abingdon, United Kingdom: Routledge.
- Upton, H. 2011. "Moral Theory and Theorizing in Health Care Ethics," *Ethical Theory and Moral Practice* (14:4), pp. 431-443.
- Vallor, S. 2011. "Carebots and Caregivers: Sustaining the Ethical Ideal of Care in the Twenty-First Century," *Philosophy & Technology* (24:3), pp. 251-268.
- van Andel, J., Leijten, F., van Delden, H., and van Thiel, G. 2015. "What Makes a Good Home-Based Nocturnal Seizure Detector? A Value Sensitive Design," *PLOS ONE* (10:4), p. e0121446.
- van Wynsberghe, A. 2013a. "Designing Robots for Care: Care Centered Value-Sensitive Design," *Science and Engineering Ethics* (19:2), pp. 407-433.
- van Wynsberghe, A. 2013b. "A Method for Integrating Ethics into the Design of Robots," *Industrial Robot: An International Journal* (40:5), pp. 433-440.
- Vanlaere, L., and Gastmans, C. 2011. "A Personalist Approach to Care Ethics," *Nursing Ethics* (18:2), pp. 161-173.
- Vredenburg, K., Mao, J.-Y., Smith, P. W., and Carey, T. 2002. "A Survey of User-Centered Design Practice," in: *Proceedings of the SIGCHI Conference on Human Factors in Computing Systems*. Minneapolis, Minnesota, USA: ACM, pp. 471-478.
- Wallach, W., and Allen, C. 2009. *Moral Machines: Teaching Robots Right from Wrong*. New York: Oxford University Press.
- Zimmerman, M. J. 2015. "Intrinsic Vs. Extrinsic Value," in: *The Stanford Encyclopedia of Philosophy*, E.N. Zalta (ed.). Stanford, CA: Stanford University.



**Copyright:** © 2018 Adam Poulsen, Oliver K. Burmeister, and David Tien. This is an open-access article distributed under the terms of the [Creative Commons Attribution-NonCommercial 3.0 Australia License](https://creativecommons.org/licenses/by-nc/3.0/australia/), which permits non-commercial use, distribution, and reproduction in any medium, provided the original author and ACIS are credited.

# Using Online Photo Sharing to Support Parents with Type One Diabetic Children

## Hajar Alamri

Department of Computer Science and Information Systems  
King Khalid University  
Abha, Saudi Arabia  
&  
Department of Computing and Information Systems  
University of Melbourne  
Victoria, Australia  
Email: [halamri@student.unimelb.edu.au](mailto:halamri@student.unimelb.edu.au)

## Reeva Lederman

Department of Computing and Information Systems  
University of Melbourne  
Victoria, Australia  
Email: [reeva.lederman@unimelb.edu.au](mailto:reeva.lederman@unimelb.edu.au)

## Rachelle Bosua

BPM and IT Group  
Open University of The Netherlands  
Netherlands  
Email: [rachelle.bosua@ou.nl](mailto:rachelle.bosua@ou.nl)

## Abstract

The rise of online photo sharing platforms has encouraged an increasing number of people to share online their lived experience as a carer of a child with a chronic condition. This study aims to explore the effectiveness of using online photo sharing platforms to support parents of chronically ill children. We use individual interviews and an analysis of Instagram posts to study parents of Type 1 diabetic children who actively engage in photo sharing. Findings show online photo sharing supports parents in coping with their child's condition and in sharing their experience with and supporting other parents. Photos have a significant capacity to deliver personal experience and therefore in enhancing relationships between participants. Participants express the greater ability of photos over text in validating their experience. More specifically, personal photos create more trust in the provided information. This supports the idea that photo sharing can provide opportunities for emotions-focused coping skills, not as easily provided by text.

**Keywords** Coping theory, Photo sharing, Parent, Carer, Instagram, Type 1 Diabetic.

## 1 Introduction

Online photo sharing through Instagram has grown significantly as a social media service on the Internet. Since its debut in 2010, more than 300 million Instagram stories have been shared by active users on a daily basis (Instagram 2018). Although Instagram photo sharing started initially with entertainment and social connectivity purposes in mind, its advantages have extended to education, marketing, business, health and many other areas (Huh et al. 2014; Kim et al. 2017). In the healthcare field, social media has generally played an important role in delivering explicit health messages. These include raising awareness, connecting health providers with patients, and helping patients connect with peers in order to obtain social and emotional support (Laranjo 2016).

Over time, users have moved gradually from posting only textual content about their experiences with chronic diseases, to posting photos that are mostly personal. However, there is a lack of research that investigates photo sharing on social networks related to chronic disease. Previous research refers to the role of visual content to deliver health messages and enhance health communication between patients in online health communities (O'Donnell & Willoughby 2017; Rus & Cameron 2016).

While there has been work done on online media for carers (Gleeson et al. 2017a), there is no research that investigates the influence of photo sharing on coping skills of patients who care for their children with chronic disease. Therefore, the aim of this study is to explore the effectiveness of using online photo sharing to support parents in coping with the conditions of their chronically ill children (particularly children with Type 1 diabetes). We use stress and coping theory as a lens to explore our work. This study is a stage of a larger project to explore chronic disease patients' engagement in photo sharing platforms.

In view of this aim, our research question is: *How does online photo sharing support and influence the lived experiences of parents coping with caring for chronically ill children?*

In this research we conduct semi-structured interviews and analysis of the Instagram postings of participants from online groups of parents of children with Type 1 Diabetes. We found that participants had a variety of objectives and coping strategies when using online photo sharing. While participants used photo sharing as a source of social support, they were also constrained by privacy concerns. This novel work, in a previously underexplored area, provides interesting findings for the design of photo sharing platforms.

## 2 Literature Review

### 2.1 Photography and Online Photo Sharing Platforms

Until recently, sharing of information using social media has been predominantly text based, with many illness groups represented in text-based online health communities (Fan et al. 2013; Fan et al. 2014; Fan and Lederman, 2018). However, the addition of photo sharing capabilities, which have altered the way people produce and share knowledge and provided opportunities for rich interactions online (Rose 2013).

The literature suggests that photo sharing is used to build relationships, for self-expression, for self-presentation, and for information sharing (Beldad & Hegner 2017; Huh et al. 2014). Users post photos to reflect their ideas (Eftekhar et al. 2014) and to present more precise forms of themselves (Beldad & Hegner 2017). Users of online photos sharing platforms want to be linked to groups and feel a sense of belonging (Beldad & Hegner 2017; Malik et al. 2015). and extend their social circle (Thelwall et al. 2015). This leads users to seek affection and attention in their circle by obtaining likes and comments on their photos thus validating their photo sharing efforts (Malik et al. 2015).

However, we know little about why or how photo sharing is used as a form of emotional support for specific health related communities. O'Donnell and Willoughby (2017) find that using photos to share health information is more effective than text especially when the target is young users through social networks. Photos discussing self-management or health information are particularly noted as having high user engagement through likes and comments (Paige et al. 2015).

### 2.2 Social Support

Photo sharing often takes place in online communities where many families of Type 1 diabetic individuals use social media to derive support from their peers (Ho et al. 2014). Support groups exist in the form of chatrooms, forums, mailing lists, blogs, groups on Facebook, hashtags, accounts on Twitter

and Instagram. Social support from other parents is a strong motivation for participation (Gleeson et al. 2017b; Zhang et al. 2013). However, previous studies on the support provided by online diabetes communities focus on either local specialized portals controlled by professionals, or social media pages related to diabetes organizations (Merkel & Wright 2012; Nordfeldt et al. 2013).

### 2.3 Health Information and Personal Experience Sharing

An increasing number of diabetes patients and their families prefer to search for health information themselves in online health communities rather than contacting their local clinics (Nordfeldt et al. 2013). This trend has led to an increasing number of moderated and non-moderated diabetes forums and social media groups, which are managed by non-government organizations (NGOs), governmental organisations, commercial agents, and individuals, with the information provided often difficult to understand and absorb (Dreyfus et al. 2011; Smith et al. 2012). Health diabetes information published in online forums and social media are either produced by professionals, created by users, or evidence-based (Fergie et al. 2016). Some studies suggest that patients and their families value the personal health experiences of peers more than the solid health information provided by health professionals (Zhang et al. 2013). In addition, adolescents with Type 1 diabetes and their parents engage in online diabetes programs and Facebook groups in order to increase their diabetes knowledge, peruse health information posted by health professionals and peers, and request disease-specific information and guidance (Ho et al. 2014; Petrovski et al. 2015).

Furthermore, some Diabetes foundations and organizations now encourage patients to engage in online posts (Hunt & Koteyko 2015). For example, they use questions to invite users to contribute to discussions and share their experiences and opinions. This approach has significant implications for the way in which people deal with health information sharing. Patients have become more open and show more willingness to share personal health information and experiences and to identify themselves as diabetes patients (Giménez-Pérez et al. 2016; Hunt & Koteyko 2015).

### 2.4 Factors in Engagement

The design of online forums has an impact on engagement. Users prefer user-friendly, accessible, and convenient websites to keep engaging with others (Fan et al. 2010; Ho et al. 2014; Lederman et al. 2014; Nicholas et al. 2012; Nordfeldt et al. 2013), while others prefer online communities that provide grouping features and one to one contact (Johnston et al. 2013). The tone of message content also impacts on engagement. A message with positive content is more likely to obtain a high number of likes and favourites than ones with negative content (Hunt & Koteyko 2015). Moreover, image is a critical feature that influences the response to the message where positive image seems to be a motivational factor for user interaction and encourages users to participate in the discussion. Rus and Cameron (2016) indicate that messages with images have a greater possibility of obtaining more likes and shares than messages without images.

### 2.5 Coping Theory

In considering this literature we can see that it suggests a number of ways in which social media can assist parents in coping with their lived experience as carer for a sick child. Coping has been defined by the **stress and coping theory** as “The cognitive and behavioural efforts made to master, tolerate, or reduce external and internal demands and conflicts among them” (Lazarus & Folkman 1984). Coping skills can be distinguished by their focus, which include emotion-focused coping and problem-focused coping (Lazarus & Folkman 1984). While *problem-focused coping* refers to identifying the cause of stress and dealing with stress through methods such as information seeking, problem solving, and obtaining instrumental social support, *emotion-focused coping* deals with stress by managing emotions as a result of stress such as writing diaries, seeking emotional support, avoidance, and suppression (Grey 2000; Lazarus & Folkman 1984). For a chronic disease like Diabetes, it is important for the patient and the carer to engage in both forms of coping strategies (Grey 2000). However, since Type 1 Diabetes is a chronic disease and the source of stress is enduring, positive emotion-focused coping is more effective (Grey 2000).

## 3 Research Design

We use qualitative methods to collect and analyze interviews and Instagram posts. First, semi-structured interviews were conducted over a four months period. Interviews are important to gather rich data from participants and to better understand the intentions behind specific behavior (Yin 2016). Following the interviews, 1,290 user’s Instagram posts were collected over two months followed by an analysis of these posts for each participant. Participants’ posts consist of their online photo sharing

activities i.e. the photos, comments in accompanying posts and hashtags used. While there are several methods to deal with visual data, in this context, content analysis seems to be the ideal choice for many reasons. First, it deals with a large sample size (Pauwels 2012). Second, it is context focused to explore trending topics in the online platforms and makes it possible to deal with photo and text together (McMillan 2000).

Prior to commencing with the data collection, ethics was sought and granted by the Human Ethics Advisory Group (HEAG) of the Melbourne School of Engineering at the University of Melbourne (Ethics ID 1647308). Following ethics approval, the first author set out to recruit study participants- parents of at least one Type 1 diabetic child or adolescent. This choice is justified by the fact that parents are the main individuals responsible for their children’s disease management and hence are more likely to have parental stress (Streisand et al. 2008). Parent needed to have spent at least three months already engaged in social media and on Instagram in particular. In addition, participants had to identify themselves on the Instagram profile as a parent of a Type 1 diabetic child and be actively posting photos on this platform. For recruitment, direct Instagram messaging was used allowing the sending of a short message as invitation to participate suggested through two hashtags #t1dmom #t1ddad. Only 10 mothers expressed their interest to participate. The mean age for the participants was 32 years and they were from four different countries. All participant data was de-identified using a pseudonym to refer to each participant (P1 to P10) as required by the ethics. Participant details are outlined in the table below:

Participant Number	Gender	Parent Group	Age	Child Group	Age	Diagnosis
P1	Female	41-45		10-13		2 years
P2	Female	31-35		3-5		6 months
P3	Female	26-30		6-9		2 years
P4	Female	36-40		14-16		3 years
P5	Female	36-40		6-9		2 years
P6	Female	26-30		6-9		4 years
P7	Female	21-25		1-2		6 months
P8	Female	36-40		10-13		8 years
P9	Female	31-36		6-9		4 years
P10	Female	31-36		6-9		1 year

Table 1: Background information of participants

### 3.1 Interviews

Participants engaged in an individual 20 minutes online semi-structured interview on SKYPE to collect background information, to understand their intentions in using Instagram, to share their experience as parents of children with Type 1 diabetes and to obtain rich information about their positive and/or negative experiences of using Instagram. Interviews aimed to examine whether parents could obtain the social support they needed, and to what extent Instagram enabled them to cope with their children’s conditions as a result of online engagement. The questions were open ended allowing participants to reflect on their journey through photo sharing. Table 2 shows a sample of the interview questions. Each interview is analyzed into corresponding codes, categories, and themes (Miles & Huberman 1994). Themes emerged from the interviews and the posts’ text were classified based on the application of coping theory to identify any coping skills.

Interview Questions
Why do you choose Instagram to share your child’s diabetes journey?
What motivates you to share your experience in the form of photos?
Do you prefer to use any other social media application for the same purpose? If so, what are they and why?
What are the benefits you gain by posting your child’s diabetic life? Please explain.
Have you experienced any negative sides to sharing diabetes-related photos on Instagram? Give an example?
Do you think using Instagram to share your child’s life could provide you the emotional support you need? How and why?
How do other parent’s posts about their journey influence you?
Do you think posting photos motivates you to cope with your child’s conditions? How and why?

Table 2: A sample of the interview questions.

### 3.2 Instagram Account Data

The second source of data was Instagram posts shared with others. This included each participant’s posts of the following: photos, captions, comments, hashtags and likes. We found 1,290 posts that were related to diabetes across the 10 accounts. The range of diabetes-related posts was between 12 to 579 for each account (see Table 3 for a statistical analysis of the topics discussed in the participants accounts).

This content was extracted from each participant’s account on Instagram. To reduce the amount of the data, only diabetes-related posts were included. To ensure including all of these different types of data, quantitative and qualitative analysis was conducted.

Posts and photos collected from Instagram were analyzed as follows:

- First, we performed a discrete statistical analysis to obtain an overview of interaction in the account including number of followers, the commenting mean, and the ‘like(s)’ mean.
- Second, we labelled each photo by manually interpreting its content. Then categories are created to reflect the photos’ content (Table 3).
- Third, we coded the textual content of each post that including captions and comments.
- Last, the themes that emerged from an analysis of the posts’ content were analyzed by comparing them with the coding themes that emerged from the interviews. The last step was important from a validity perspective to ensure that both instruments lead to the same findings and interpretations.

The initial statistical analysis showed differences in the most discussed topics for each account based on their objectives. In addition, the number of followers and the purpose of the accounts highly affected the way people commented and liked any post. The most significant discussed topics were related to raising awareness and sharing positive everyday activities related to parent’s caring for their children.

Participant	Total Number of posts	Likes (mean)	Comments (mean)	Followers	Posts Topics (number of posts)										
					Positive Everyday	Negative Everyday	Hoping for Cure	Nutrition related	Frustration	Promoting for diabetes	Raising awareness	Educating	Promoting for specific products	Joking	Others
P1	89	14.73	1.86	184	21	9	11	0	13	15	7	8	0	5	0
P2	12	27.09	2.16	236	3	4	1	0	0	0	0	2	2	0	0
P3	107	15.76	0.75	266	27	13	9	0	11	17	9	5	13	3	0
P4	91	17.45	1.76	760	21	14	16	0	9	2	18	2	0	9	0
P5	19	23.86	2.6	1081	2	7	1	0	8	0	1	0	0	0	0
P6	28	306.50	17.67	13844	4	0	0	0	0	7	2	8	7	0	0
P7	141	17.71	5.48	1529	0	1	8	34	3	0	43	49	3	0	0
P8	579	33.58	6.37	2504	11	5	12	146	0	15	141	203	12	16	18
P9	187	22.19	2.89	2045	2	9	18	38	8	3	37	64	0	0	8
P10	37	17.88	2.76	82	7	3	1	3	0	0	11	8	4	0	0

Table 3: Initial statistical analysis for the topics discussed in the participants accounts.

## 4 Findings

This section describes three themes that emerged from the qualitative data analysis (i.e. interpretations of the interview data) in combination with the interpretation of the topics that emerged from data analysis of the content of Instagram posts.

### 4.1 Coping Strategies Through Photo Sharing Platforms

Parents in this study indicated that their adoption of photo sharing helped them to develop many coping strategies to reduce parental stress related to their children’s conditions. Many of these strategies were enabled by social media where most of the coping strategies are positive emotion-focused: i) having gratitude for technological, human and spiritual supports; ii) visualizing their children’s positive activities, and iii) emotional social support. In addition, problem-focused coping strategies occur in limited activities online including: i) engaging and raising awareness of diabetes campaigns and ii) educating other parents who have children with Type 1 diabetics.

#### 4.1.1 Positive emotion-focused coping

- Sharing a visual diary and experience through photos

Participants appreciated the experience of sharing their life through photos. In fact, there was a conflict between the way they talked about the positivity of their experience in the interviews and the fact that more than half of the shared photos in their accounts did not get high numbers of comments or likes. However, participants explained the real relief they felt when going through old photo posts. They commented on the progress they've made in their journey which gave them a motive to provide more support for their children and empower them to cope with their situation:

“Everything in my whole life is online including my son, what we're going through and challenges since we were at the hospital, I like [it] when I go back to see where we were and what we are doing now” (P1, Q1) (key: P1=participant 1, Quote 1).

In addition, sharing diabetes experiences has many forms such as: sharing how parents suspected the disease to unfold and symptoms experienced, pictures since the first day of diagnoses and feelings about that, and how parents dealt with the highs and lows associated their children's every-day diabetes challenges.

“This was the day when everything changed. My baby girl was diagnosed with Type 1 Diabetes and our world was turned upside down... It was her teacher that noticed she was losing weight, drinking a lot of water & just wasn't acting like herself... I worried so much” (P4, Q2).

- Expressing feelings of gratefulness for sources of support

Another emotional coping strategy used by the participants was through posting to other parents how they were grateful to the source(s) of support in their lives. Sources of support specifically mentioned included spiritual, diabetes-related technologies, partners, and other family members.

“I am NOT thankful for this chronic disease in our family life that hit us like a bus 8 months ago. But I am becoming grateful for the strength God has given us to handle what we were given” (P5, Q3).

Moreover, advanced diabetes control devices made dealing with diabetes easier, especially for parents. Although they were not available for all, parents who could benefit from them were thankful for their existence and encouraged other parents to try using these devices.

In addition, participants always referred to the support of their partners and other siblings in helping to care for their diabetic children and how this support could reduce parental stress.

“My oldest treated her sister, low [hypoglycaemia] and laid with her to make sure she didn't miss an alarm.” (P1, Q4)

- Picturing diabetic children's positive activities

Sharing photos of the regular life of diabetic children was clear accounts for a range of between 2% and 29% in total posts for individual accounts. Participants' posts were varied in the way they showed the personal life of their children related to diabetes. Across all posts, parents always tried to show the positive side of everyday activities, and that diabetes would not stop their children participating in regular activities. An analysis of Instagram posts aimed to identify sentiments of positive and negative activity as shown from the evidence below:

*Positive activity:* “My sweet girl is off to D-camp! First away camp ever! so proud of her” (P1, Q5)

*Negative activity:* “I despise changing Dexcom sensors... No amount of breathing or counting will ever make that pit in my stomach go away...” (P4, Q6)

- Direct and indirect emotional social support

Through the interviews and Instagram posts, participants referred to different forms of social support through Instagram. Although the majority of the participants sought emotional support from other parents on Instagram, two of them declared that they use Instagram to provide support for others, as they do not need it themselves as they have moved on in the coping journey.

Participants who sought emotional and social support claim they use hashtags and search features in Instagram to reach out to other parents and Type 1 diabetes patients. They obtain emotional support either through positive comments and discussions on their posts or through private conversation using the Instagram's Direct Message feature.

“To all my T1 mama bears! You are awesome! Thank you for being my support! I love you and you should love yourselves more!” (P4, Q7)

The majority of the participants referred to another form of emotional and social support where they introduce themselves to other parents on Instagram and then create new support groups through other social media applications such as Facebook and WhatsApp that provide more private environments and an easier way to discuss their children’s issues and how to deal with them

“Instagram helped me to get contacted with other moms and specialists who also have diabetes through WhatsApp” (P6, Q8)

#### 4.1.2 Problem-focused coping

- Seeking health information and personal experience

Participants show the need to obtain more information even though they may trust information from health providers. They look for more information and personal experience on Instagram to obtain feedback from other parents about specific conditions or supplies.

“I connect with health professionals’ profiles and other moms. Sometimes to check information for me and my kid and to know about new technologies like pumps that we’re not using yet whether it is comfortable or not.” (P4, Q9)

- Engaging in diabetes campaigns and raising awareness

This strategy was considered one of the favourite themes in posts of all participating parents. They believed they could make a difference by raising awareness about the disease’s symptoms and its complications. The main target for the majority of the participants was family and friends as they discussed diabetes in their accounts to show their family and their children’s friends what the daily diabetes experience looks like.

“My friends and family are interested to know [more] about diabetes... Several of her [my child’s] friends follow me. Now I just want them to understand” (P3, Q10)

Raising awareness posts ranged between posting on diabetes health information, photos of parents with their children engaging in diabetes campaigns, and posts to others encouraging donations for diabetes organisations, or using trending hashtags about diabetes.

- Educating other parents about Type 1 diabetes

The last coping strategy used by participating parents is posts to educate other parents about Type 1 diabetic children. The most discussed topics are feedback about the latest technology related to diabetes, and nutrition information and how to count carbohydrates and deal with highs and lows based on their experiences.

“My purpose is to educate other moms in order to get better management of diabetes.” (P9, Q11)

## 4.2 Photos as a Preference

The majority of the participants emphasized that photos have a greater impact than text alone. In particular photos sharing individual journeys of hardship and angst parents experienced as a result of caring for their children strengthened social ties in the network.

“I want them to see it through my eyes and sometimes words don’t always give the justice that you see on pictures...” (P1, Q12)

Photos were referred to as a ‘shortcut’ to reading a whole article – one could write a few words with a photo that describes everything. The importance of photos was not limited to only parents of diabetic children, but also Type 1 diabetic children, as photos were considered a language that was understandable by all people.

On the other hand, participating parents preferred to use Instagram due to its accessibility to different age groups, its user-friendly interface, ease-of-use, and the availability of hashtags and search features that helped to reach other parents of Type 1 diabetics accounts.

“Instagram is pretty user friendly and I am most comfortable to use it. It allows me to search for people who like me using hashtags about diabetes, type one diabetes, insulin dependent and then we can start conversation” (P4, Q13)



Statistical analysis of posts confirmed the affective use of photos to deliver messages and to attract other users to read, comment, and like the posts.

### 4.3 Benefit of Personal Photo Sharing

Many participants referred specifically to the benefit of personal photos of real people as a way to get their message across and provide validity to the information they were sharing:

“I saw many Kuwaiti moms accounts who talk about diabetes but do not share their children photo, so I could not see the impact as when the child speaks. You can see his own life what looks like.” (P10, Q14)

“My family and my mother could not understand what we are going through. However, photos now could explain everything, and they understand the situation and how is the life with diabetes” (P10, Q15)

## 5 Discussion

We see in this study that participants used Instagram as a coping strategy in different ways that include sharing personal experience with other parents, picturing positive everyday activities, engaging in diabetes campaigns online, raising awareness, and encouraging others to donate for diabetes research organisations. Some parents describe the purpose of their accounts as purely educational while others refer to an opportunity to share daily life moments with diabetes with close family members and peers (see Q5, Q15). The third group posts photos to specifically seek social support in their journey on adapting to caring for children with Type 1 diabetes. This behaviour is consistent with the literature (Rus and Cameron 2016) which suggest that posts with personal experiences or the seeking of emotional support are likely to obtain higher engagement. Personal photos can be used to describe participants' own and their children's experiences which is important to describe the situation to family and friends, raise awareness about the disease, and raise donations for diabetes research (see Q10). The increase in the willingness to share more personal health information online is supported by Hunt & Koteyko (2015). Moreover, participating parents refer to sharing photos that explain their experiences with the disease as a 'relief', although some of the photos did not attract the expected number of likes or comments (see Q1).

Participants posted concerns about privacy and trustworthiness issues. Through the content analysis of postings on participants' accounts, there were significant behaviours identified related to problematic privacy practices, particularly where photos were accompanied by text. The majority of the participants openly shared their names and children's names, their children's health situation and regular check results, as well as complications related to their children's chronic disease. Although it has become more common behaviour on social media recently to share openly (Malik et al. 2015), the effect of this behaviour is not fully known.

Participants refer to the ease with which they can deal with photos technically and emotionally (see Q18). These findings suggest two forms of emotional social support through Instagram, i.e. *direct* and *indirect social support*. Direct emotional social support is attained through likes, positive comments, expressions of empathy, well wishes, and hope for cures in discussion, which are similar to what Zhang et al. (2013) found in their study. Indirect social support through Instagram is identified in this study as participating parent's use of Instagram hashtags and search features allowing individuals to find other parents and invite them to join private online diabetes discussion and collaboration groups through Facebook and WhatsApp. These groups provide more private and specialised environments for parents of Type 1 diabetics that Instagram does not offer.

Significantly, the value of photo sharing relies on the capabilities of the social media application. Findings indicate the features of the application that encourage or discourage people from using it. While there are multiple online photo sharing platforms, not all of them are favoured by the parents in the sample. The ability to provide temporal sequences of photos creates a story line for parents who prefer to review how they deal with the disease over time. The ability to capture and post photos with the least expected technical issues is another key factor. This factor is consistent with the literature where Ho et al. (2014) and Nicholas et al. (2012) mention that users prefer user-friendly and convenient online platforms. The last factor is the value of searching through hashtags that allows patients with any disease and their families to meet and find peers all over the world. In addition, participants all agree that visual posts including photos and short videos have more power in delivering their messages than other tools that include text and longer videos. Rus and Cameron (2016) refer to this point in their study

indicating that posts with photos attract more user interaction and engagement. They see photos as presenting much more information than text.

Participants suggest that using online photo sharing helped them to create new relationships with other parents around the world. In addition, initial photo sharing can create more trust between participants where they go on to invite parents to closed groups through WhatsApp and Facebook. Fan and Lederman (2018) indicate that trust in online health communities is influenced by the interaction level between the users. Our study suggested that parents look for peers through their online photo sharing activities where they build more trust to engage in private communication. Due to privacy concerns, this finding shows a new style of communication on online communities where there is no moderator to control the platform.

Photo sharing provides opportunity for relationship building that could not be easily achieved otherwise. Participants in this study recognize themselves in profile information as parents with Type 1 diabetic child which helps to create possible new ties with other parents who visited their profiles as well as using hashtags to further increase access to others in a shared community of interest. This finding is supported by Beldad & Hegner (2017) where they find users normally share photos online to create new social ties and relationships.

Most significant to the role of coping theory in the context under examination is the claim that personal real photos provide a more valid or more substantiated form of evidence than text in the online context (Q14, 15). Findings indicate different emotion-focused coping skills compared to limited problem-focused coping through photos which could be linked to the nature of Type 1 Diabetes as a chronic disease. With regard to coping theory, photos were seen to substantiate the truth of the personal experience more than text and thus generate easier ways to cope with emotions (Q1-Q8). While tentative in this limited context, this is a significant and important finding suggesting the greater possible power of photo sharing in positive emotions-focused coping than text based media.

## 6 Conclusion

This study explores the support provided to carers of children with Type 1 diabetes by online photo sharing platforms. This study finds that photos create a storyline for their experience as well as an opportunity to express their positive and negative feelings about their experience, to share strategies and personal experiences, to discuss sources of support, to create positivity and to build awareness of both the condition and fundraising opportunities. The paper also explores the idea of coping through digital photo sharing. Our contribution is to consider the idea of coping with stress in this specific context of photo-sharing in a health community. Our tentative finding is that such platforms can be designed to facilitate engagement with other patients and the adoption of coping skills related to health issues. This finding is worthy of further exploration.

## 7 Limitations

This paper has limitations due to the small sample size and its focus on only a group of parents with a specific chronic disease. The study is limited to the case of parents of children with Type 1 diabetes in online photo sharing and may not be applicable in other situations due to the small sample size and using the use of qualitative research tools.

Parents with more than one child with Type 1 diabetes or family history with diabetes are excluded from the study. The findings are based on a single photo-sharing platform and did not discuss user engagement in other photo based social media such as Facebook and Twitter. This study uses coping and stress theory to explore the effectiveness of using online photo sharing in health. However, it excludes the influence of multiple social factors such as socio-economic status. Moreover, this study cannot be generalized due to the previous reasons in addition to its dependence on qualitative data.

## 8 References

- Beldad, A. D., and Hegner, S. M. 2017. "More Photos from Me to Thee: Factors Influencing the Intention to Continue Sharing Personal Photos on an Online Social Networking (OSN) Site among Young Adults in the Netherlands," *International Journal of Human-Computer Interaction* (33:5), Taylor & Francis, pp. 410–422. (<https://doi.org/10.1080/10447318.2016.1254890>).
- Dreyfus, S., Lederman, R. M., Smith, S. P., and Monagle, P. T. 2011. "Customising pathology report design for patient use". *eJournal of Health Informatics*, 6 (2).

- Eftekhar, A., Fullwood, C., and Morris, N. 2014. "Capturing Personality from Facebook Photos and Photo-Related Activities: How Much Exposure Do You Need?," *Computers in Human Behavior* (37), Elsevier Ltd, pp. 162–170. (<https://doi.org/10.1016/j.chb.2014.04.048>).
- Fan, H., Lederman, R., Smith, S., and Chang, S., 2010. "Why People Trust in Online Health Communities: An Integrated Approach", *21st Australasian Conference on Information Systems*, December 1-3.
- Fan, H., Lederman, R., Smith, S., and Chang, S., 2013. "How Online Health Forum Users Assess User-Generated Content: Mixed-Method Research", *European Conference in Information Systems*.
- Fan, H., Lederman, R., Smith, S., and Chang, S., 2014. "How Trust Is Formed in Online Health Communities: A Process Perspective", *Communications of the Association for Information Systems*: Vol. 34, Article 28.
- Fan, H., and Lederman, R. 2018. "Online Health Communities: How Do Community Members Build the Trust Required to Adopt Information and Form Close Relationships?," *European Journal of Information Systems* (27:1), Taylor & Francis, pp. 62–89. (<https://doi.org/10.1080/0960085X.2017.1390187>).
- Fergie, G., Hilton, S., and Hunt, K. 2016. "Young Adults' Experiences of Seeking Online Information about Diabetes and Mental Health in the Age of Social Media," *Health Expectations* (19:6), pp. 1324–1335. (<https://doi.org/10.1111/hex.12430>).
- Giménez-Pérez, G., Recasens, A., Simó, O., Aguas, T., Suárez, A., Vila, M., and Castells, I. 2016. "Use of Communication Technologies by People with Type 1 Diabetes in the Social Networking Era. A Chance for Improvement," *Primary Care Diabetes* (10:2), Primary Care Diabetes Europe, pp. 121–128.
- Gleeson, J., Koval, P., Eleftheriadis, D., Lederman, R., Herrman, H., Bendall, S., Cotton, SM., & Alvarez-Jimenez, M. 2017. "Moderated online social therapy for carers of young people recovering from first-episode psychosis: study protocol for a randomised controlled trial", *TRIALS*, vol. 18.
- Gleeson, J., Lederman, R., Koval, P., Wadley, G., Bendall, S., Cotton, S., Herman, H., Crisp, K. & Alvarez-Jimenez, M. 2017. Moderated Online Social Therapy: A Model for Reducing Stress in Carers of Young People Diagnosed with Mental Health Disorders. *Frontiers in Psychology*, 8, 485-497.
- Grey, M. 2000. "Lifestyle and Behavior: Coping and Diabetes," *Diabetes Spectrum* (13:3), p. 167.
- Ho, Y.-X., O'Connor, B. H., and Mulvaney, S. A. 2014. "Features of Online Health Communities for Adolescents with Type 1 Diabetes," *Western Journal of Nursing Research* (36:9), pp. 1183–1198. (<https://doi.org/10.1177/0193945913520414>).
- Huh, J., Liu, L. S., Neogi, T., Inkpen, K., and Pratt, W. 2014. "Health Vlogs as Social Support for Chronic Illness Management," *ACM Transactions on Computer-Human Interaction* (21:4), pp. 1–31. (<https://doi.org/10.1145/2630067>).
- Hunt, D., and Koteyko, N. 2015. "What Was Your Blood Sugar Reading This Morning? Representing Diabetes Self-Management on Facebook," *Discourse & Society* (26:4), pp. 445–463. (<https://doi.org/10.1177/0957926515576631>).
- Instagram. 2018. "Press News." (<https://www.instagram.com/press/?hl=en>).
- Johnston, A. C., Worrell, J. L., Di Gangi, P. M., and Wasko, M. 2013. "Online Health Communities," *Information Technology & People* (26:2), pp. 213–235. (<https://doi.org/10.1108/ITP-02-2013-0040>).
- Kim, D. H., Seely, N. K., and Jung, J. H. 2017. "Do You Prefer, Pinterest or Instagram? The Role of Image-Sharing SNSs and Self-Monitoring in Enhancing Ad Effectiveness," *Computers in Human Behavior* (70), Elsevier Ltd, pp. 535–543. (<https://doi.org/10.1016/j.chb.2017.01.022>).
- Laranjo, L. 2016. "Social Media and Health Behavior Change," *Participatory Health through Social Media*, Elsevier Inc. (<https://doi.org/10.1016/B978-0-12-809269-9.00006-2>).
- Lazarus, R. & Folkman, S. 1984. *Stress, Appraisal, and Coping*, New York: Springer Pub. Co. (<https://doi.org/10.1037//0033-2909.116.2.340>).
- Lederman, R. M., Wadley, G. R., Gleeson, J., Bendall, S., and Alvarez, M. 2014. "Moderated online social therapy: Designing and evaluating technology for mental health". *ACM Transactions on Computer-Human Interaction*, 21(1).

- Malik, A., Dhir, A., and Nieminen, M. 2015. "Uses and Gratifications of Digital Photo Sharing on Facebook," *Telematics and Informatics* (33:1), pp. 129–138. (<https://doi.org/10.1016/j.tele.2015.06.009>).
- McMillan, S.J. 2000. "The microscope and the moving target: The challenge of applying content analysis to the World Wide Web," *Journalism & Mass Communication Quarterly*, 77(1), pp.80-98.
- Merkel, R. M., and Wright, T. 2012. "Parental Self-Efficacy and Online Support among Parents of Children Diagnosed with Type 1 Diabetes Mellitus," *Pediatr Nurs* (38:6), p. 303–8; quiz 309. (<https://doi.org/10.1016/j.pedhc.2015.08.002>).
- Miles, M. B., and Huberman A. M. 1994. *An Expanded Sourcebook: Qualitative Data Analysis (2nd Ed.)*. Thousand Oaks, CA, Sage Publications.
- Nicholas, D. B., Fellner, K. D., Frank, M., Small, M., Hetherington, R., Slater, R., and Daneman, D. 2012. "Evaluation of an Online Education and Support Intervention for Adolescents with Diabetes.," *Social Work in Health Care* (51:9), pp. 815–27. (<https://doi.org/10.1080/00981389.2012.699507>).
- Nordfeldt, S., Ångarne-Lindberg, T., Nordwall, M., and Krevers, B. 2013. "Parents of Adolescents with Type 1 Diabetes - Their Views on Information and Communication Needs and Internet Use. A Qualitative Study," *PLoS ONE* (8:4). (<https://doi.org/10.1371/journal.pone.0062096>).
- O'Donnell, N. H., and Willoughby, J. F. 2017. "Photo-Sharing Social Media for eHealth: Analysing Perceived Message Effectiveness of Sexual Health Information on Instagram," *Journal of Visual Communication in Medicine* (40:4), Informa UK Limited, trading as Taylor & Francis Group, pp. 149–159. (<https://doi.org/10.1080/17453054.2017.1384995>).
- Paige, S. R., Stollefson, M., Chaney, B. H., and Alber, J. M. 2015. "Pinterest as a Resource for Health Information on Chronic Obstructive Pulmonary Disease (COPD): A Social Media Content Analysis," *American Journal of Health Education* (46:4), pp. 241–251. (<https://doi.org/10.1080/19325037.2015.1044586>).
- Pauwels, L. .2012. "Contemplating the State of Visual Research: An Assessment of Obstacles and Opportunities". *Advances in Visual Methodology*, 3–24. (<https://doi.org/10.4135/9781446250921>)
- Petrovski, G., Zivkovic, M., and Stratrova, S. S. 2015. "Social Media and Diabetes: Can Facebook and Skype Improve Glucose Control in Patients with Type 1 Diabetes on Pump Therapy? One-Year Experience," *Diabetes Care* (38:4), pp. e51–e52. (<https://doi.org/10.2337/dc14-2487>).
- Rose, G., 2013. *Visual methodologies: An introduction to researching with visual materials*. sage
- Rus, H. M., and Cameron, L. D. 2016. "Health Communication in Social Media: Message Features Predicting User Engagement on Diabetes-Related Facebook Pages," *Annals of Behavioral Medicine* (50:5), *Annals of Behavioral Medicine*, pp. 678–689. (<https://doi.org/10.1007/s12160-016-9793-9>).
- Smith, S. P., Lederman, R. M., Monagle, P. T., Alzougool, B. M., Naish, L., and Dreyfus, S. 2012. Individually tailored client focused reports for ubiquitous devices: An experimental analysis. In the 23rd Australasian Conference on Information Systems ACIS.
- Streisand, R., Mackey, E. R., Elliot, B. M., Mednick, L., Slaughter, I. M., Turek, J., and Austin, A. 2008. "Parental Anxiety and Depression Associated with Caring for a Child Newly Diagnosed with Type 1 Diabetes: Opportunities for Education and Counselling," *Patient Education and Counselling* (73:2), pp. 333–338. (<https://doi.org/10.1016/j.pec.2008.06.014>).
- Thelwall, M., Stuart, E., Goriunova, O., Vis, F., Burns, A., Faulkner, S., and D'Orazio, F. 2015. "Chatting Through Pictures? A Classification of Images Tweeted in One Week in the UK and USA". *Journal Of The Association For Information Science And Technology*, 67(11), pp. 2575-2586.
- Yin, R. K. 2016. *Qualitative Research from Start to Finish*. New York. Guilford Press.
- Zhang, Y., He, D., and Sang, Y. 2013. "Facebook as a Platform for Health Information and Communication: A Case Study of a Diabetes Group," *Journal of Medical Systems* (37:3). (<https://doi.org/10.1007/s10916-013-9942-7>).

## Shared Experiences

*Mike Seymour*  
*University of Sydney*  
*Sydney, NSW, Australia*  
*mike.seymour@sydney.edu.au*

*Dirk S. Hovorka*  
*University of Sydney*  
*Sydney, NSW, Australia*  
*dirk.hovorka@sydney.edu.au*

*Judy Kay*  
*University of Sydney*  
*Sydney, NSW, Australia*  
*Judy.kay@sydney.edu.au*

### Abstract

Disciplines often approach phenomena from different perspectives and with different research tools. We offer this example of our efforts to embrace the wider CHI values through the exploration of emotive digital humans deployed in HCI. We designed and conducted an HCI experiment with mixed methods. In building an infrastructure that benefits from the strengths of both AIS SIGHCI and ACM SIGCHI research communities, we chose an approach that could reveal undisclosed worlds, hard to see from just one perspective. As technology offers HCI digital humans, new combined shared approaches may be needed to gain insights, especially prior to their wide scale deployment. As bridging related disciplines have failed in the past, perhaps a new approach is needed, one of shared experiences, especially when exploring new technological phenomenon.

**Keywords** Human Computer Interface, research approach.

## 1 Introduction

Humans have highly developed neural pathways for facial interpretation and yet we provide no emotionally rich 'face' for interactions with our computational tools or 'partners'. Humans already interact with a wide range of cognitive agents, for example Apple's Siri or Amazon's Alexa. The application of highly accurate digital faces may add to the effectiveness of these cognitive agents and also may be effective as avatars in VR and as actors in communication and learning forums.

We offer a research example of "facing the computer" applying realistic interactive digital people. Our research benefited from using the shared experiences of both IS HCI and IT CHI. This hybrid approach was also informed by AI techniques, now being applied by HCI researchers, and applications of machine learning being increasingly visible in the HCI literature (Grudin, 2009). We offer this multi-staged research program as an example of how to approach the issue, while leaving the specific research questions and results to various separate publications handling each of the specific research projects. We note that using methods from two different approaches is not necessarily new, but as shown here, it can be very informative.

The research program spanned a range of research including a Delphi study, elements of Design Science Research, qualitative and quantitative data gathering. The program continues today with new research building on this successful base.

To clarify labels, in this paper, we adopt the convention of stating that Computer Human Interfaces (CHI) belongs as a label to the community that researchs and publishes in the Information Technology (IT) discipline, for example the ACM SIGCHI community. This is a narrower focus than the Human Computer Interface (HCI), Information Systems (IS) community, that might publish in the AIS SIGHCI (Grudin, 2017). We shall adopt the one 'HCI' label convention to encapsulate the interface discussion contained in our research document.

### 1.1 Facing the computer

The "facing the computer" research program using realistic interactive digital people benefited from applying a hybrid approach of research methodologies. The program also benefited from the AI techniques available to CHI researchers and the applications of machine learning being increasingly visible in the HCI literature (Grudin, 2009). We simulated AI components in our experiments by using machine learning (ML) and deep learning (DL) to implement the research projects.

#### 1.1.1 Study background

For the actual second study, following on from the Delphi research we used a field study to investigate whether users had different affinity, trustworthiness, and preferences for avatars with two levels of realism, one photo-realistic and one a cartoon caricature. We collected survey data and conducted one-on-one interviews with SIGGRAPH conference attendees who watched a live interview carried out utilising two avatars, either on a large screen 2D video display or via 3D VR headsets. 18 sessions were conducted over four days, with the same person animating the photo realistic avatar but with different individuals animating the caricature avatars. While the actual details of this study will be publicised elsewhere, in summary, the participants rated the photo-realistic avatar more trustworthy, had more affinity for it, and preferred it as a virtual agent. Participants who observed the interview through VR headsets had even stronger affinity for the photo-realistic avatar and stronger preferences for it as a virtual agent.

### 1.2 Common language

When we speak broadly of two worlds CHI and HCI, dichotomies are problematic, but there is more overlap than difference. Defining the two communities as representing IS and IT is both limiting and implies separation rather than commonality with differing perspectives. We found both groups cover much of the same intellectual ground, but with different terminology describing the same thing, or equally, a common term is used differently between them. For example, a 'process' from one perspective refers to a 'CPU process' but a 'business process' from the other. This gap is not new, Grudin (2017) notes several such instances. A successful 'implementation' may mean code in one world and introduction to an organisation in another. What IS might call 'systems', an IT community may refer to as 'applications'. 'Task Analysis' is an organisational decomposition of work for IS, and in CHI it is more likely to be a cognitive decomposition (Grudin, 2017). Similarly, what one group may refer to in their literature as 'Common Understanding', may be similar to (but not identical to) 'Community of Practice' from a

different group. Such differences do not directly map to the literature of the CHI or the HCI communities, and within each of these HCI communities there are also different groups with diverse perspectives.

From their own web sites, ACM SIGCHI's CHI focus is on interaction between one or more humans and one or more computational machines ("ACM SIGCHI Curricula for Human-Computer Interaction : 2. Definition and Overview of Human-Computer Interaction," n.d.), while the AIS HCI's focus is the IS community, emphasizing applications in business, managerial, organizational, and cultural contexts (Association for Information Systems., n.d.).

### 1.3 Institutionalised division

One of the principle reasons for the divided community, apart from language and terminology, has been the different academic engagement and communication strategies of each community. Those researchers identifying with the IT community are rewarded for publishing at conferences, while the IS community values journal publications. It was estimated, at the opening of the 2004 HICSS conference, that less than 15% of the work in CHI sponsored conference research reaches journal publication. Whereas IS conference organizers have estimated that 80% of research presented at a leading IS conference progressed to a journal<sup>1</sup>.

### 1.4 A historical failure to bridge

For many years, bridging the disciplines has failed. Even in an environment where interdisciplinary cooperation is encouraged, and there is a lack of literature speaking against such bridge building efforts, there is an absence and gap of successful cases to draw on. IS has broadly sort overarching theory and focused on hypothesis testing. IT has become atheoretical and moved to less-rigorous methods such as cognitive walkthroughs in an effort to gain a deeper understanding when context is critical and unfamiliar (Grudin, 2017).

- a) This difference and gap has happened even as many of the same issues have been researched in each of the two communities.
- b) Our enquiry benefited from both specific interface interaction and exploring broader business ethical and theoretical issues.

### 1.5 Areas of interest and matters of concern

While bridging two different worlds has failed historically, the term 'bridging' also suggests the problem is that there are two separate and different worlds. As mentioned, this is not representative as the areas of interest overlap greatly. But equally what is not needed is a transdisciplinary solution that would fully span both worlds. There are legitimate and important differences. The solution is not a simple spanning, combining or bridging of two worlds.

It is apparent that new areas of HCI, such as fully realistic digital humans, has created what Latour called (positively) 'matters of concern' (Latour, 2004). The research of digital humans has many varied groups interested, from educators to the military. We need a space where the participants can gather and research the topic, that is not bound by one discipline's strict approach.

We attempted to overcome the dichotomization, which is largely institutional, by suggesting not a new or combined discipline, nor even a multi-discipline approach. We suggest a new focus on complexity studies by shared experiences from two disciplines, drawing on strengths from both groups, but without labeling or specifically targeting one or the other.

### 1.6 Facing the future

Our prior work was to build an *in situ* 'digital human' and that led to this hybrid research approach. For example, when the digital human is driven by a real person (as in an *avatar*), is the avatar ascribed with the traits of the user controlling it? Or is it a separate entity even if it is known to be controlled by a human, in much the same way a puppet can appear to be separate from the puppeteer who voices it? Users may see the avatar either standing apart from the user or as a direct extension of the user. This research project benefited from both an engineering inclined perspective, as well as a philosophical view. We joked that our work has benefited from 'cutting edge code with existential phenomenology'.

---

<sup>1</sup> Nunamaker, J. Opening remarks of HICSS-38.

It should also be noted that this area of human simulation is closely related to current resurgent discussions on Artificial Intelligence. It has been stated that AI and HCI are currently converging (Grudin, 2009). Due to the deployment of many waves of technology such as Intelligent systems, Enterprise-wide Decision Support Systems, Expert Systems, etc. there is a long-standing link between the HCI community and the AI business research focused communities. Recent developments such as realistic virtual human agents once again under scores this point. While our research used ML to deal with technical issues. It is worth noting, for research design reasons, we choose to separate the specific implementation of AI human emulation from our program of research. While super-intelligent computers are speculated about, we assume that they are not imminent. While people may andromorphise these interfaces, we see them as digital partners that only amplify human agency. They may appear 'Intelligent', but they do not possess actual intelligence.

We designed a complex and highly advanced program involving multiple digital humans at different levels of realism, engagement and modal interaction in a contextual research environment. We did this so we could explore the issues raised by our initial Delphi study conducted with 13 senior industry experts from around the world.

We are researching a world of human computer symbiosis where people and computers share tasks and work together to reach goals. This supportive role of computers has the devices typically receding into the background. We aimed to reduce novelty by using primarily informed participants in the research. This was deemed to be key as many of the technologies were brought together for the first time for this research using a global research team involving four different countries (USA, Serbia, UK, and Australia).

We aimed to provide actual significant interactions so as to make the interaction as valid as possible. By engaging the avatars through a variety of platforms (i.e. on screen, in person and in VR) we also explicitly aimed to eliminate interface inferred biases.

People may be aware that their appliances have computers at their operational core, from fridges to phones, but these devices are not referred to as 'computers' but rather as 'smart' devices. These devices could potentially use new digital human interfaces and hence draw the user's attention to the foreground. The interface becomes the focus of attention as the technology is personified and humanised.

## 2 Opening the Black Box : HCI

There is a valid HCI interest in exploring how a user interface can recede into the background, as part of the User Experience. Attention is thus focused on the task, and the awareness of interface recedes so interaction becomes frictionless. Such research has explored ubiquitous smart rooms or nomadic mobile technology that is ever accessible, without drawing attention to itself. In the past, this has led to a notion of black boxing the technology (Orlikowski & Iacono, 2001).

In contrast, a first-person experience of an emotional interactive expressive human face represents a shift in research focus. Manifesting a cognitive agent as an emotionally engaging and intuitively responsive digital human would *deliberately gather the focus of attention*. The subject would be responding to and anticipating a human-looking face, wanting to make eye-contact and reading micro-gestures of empathy. What is the interpretation of such an experience? This area of digital humans provides the opportunity to research HCI as interfaces both recede from view and simultaneously gather attention.

From this perspective, a cognitive agent could not be isolated as *an interface* to technology, as it cannot be black boxed as an arbitrary piece of technology that stands apart with an identifiable interface. Here echoes can be heard of Merleau-Ponty's thought experiment when he asks the reader to imagine a blind man navigating a city street with a cane. What is the relationship and limits between that cane and the man's perceptual apparatus? (Matthews, 2010). Philosophers such as Merleau-Ponty disputed the Cartesian view that the mind and the brain/body can be considered anything other than one non-decomposable whole (Matthews, 2010). Similarly, we felt the implications of the technology could not be disclosed by discussion or looking at the IT artifact in isolation. The experience of the interaction must take its part in the referential whole. The notion of a black box standing apart is not valid.

From the IS toolbox, we used the approach of a qualitative Delphi study and from IT, the notion of prototyping. Combined with further qualitative and quantitative research, this provided a rich and dense level of insight and understanding.



Conversely, while exploring sense making of this new evolving technology we did so without looking back at past IS tools. TAM is the most widely cited research in the IS community (Davis, Bagozzi, & Warshaw, 1989). In the IS community, the central issue addressed by this prescriptive theory is one built around perceived ease of use, and perceived usefulness. TAM exemplifies the long term organisational view of technology and a top down MIS focus. In the IT CHI community 'perception' is secondary to "user satisfaction". In the CHI world, discretionary technology is *Adopted* by users not *Accepted*. A TAM approach was not used in our research. TAM comes from an IS context of internal organisational use of computer systems. The technology was bounded by the business structure. We expect the deployment of digital humans to not be an internally controlled or deployed vehicle of HCI. The focus will not be on a niche audience lead by the CIOs and CTOs of businesses, but the external broader social media landscape with cloud computing and consumer applications. In this respect, possible 'adoption' was explored with more of a CHI mixed methods approach that embraced exploration over hypothesis testing of potential 'acceptance'. TAM is indicative of an approach of compartmentalizing technology into a black box.

Similarly, regarding IT's tools, we noted that the nature of our exploration of future digital human agents is the interaction and meaning constructed as part of that interaction. It is holistic and inseparable, and it seemed worthy of both theoretical and philosophical reflection. The agent is an intrinsic part of the holistic environment and the co-defined dynamic interaction, yet it can be argued that current CHI research requires less of a theory. The continued focus on conferences reflects the focus on small scale, less theoretical research. CHI has a tendency, in a highly changing, technologically shifting environment, to focus on impact on individuals in society. It reflects a fast-moving tech world, but it can also presuppose smaller ethical and societal discussions of implications.



*Figure 1: The realistic avatar could be rendered at 90 frames a second, interactively in Epic's UE4 engine, driven by markerless motion capture on stage, in real time and seen in Virtual Reality*

### 3 A Research Solution

Our approach to exploring this area started with

- A multi-year Delphi study of leading industry and academic experts to define a vector for exploration.
- Building on those perspectives, we prototyped a real-time avatar system over an 18 month period (see figure 1, figure 2).

The impediment to adoption of digital humans in an HCI context has been strongly influenced by a 1970s theory known as the *Uncanny Valley* (see figure 3).

Much research has examined how users respond to more realistic characters or avatars (Wang, Lilienfeld, & Rochat, 2015). Of particular interest is the uncanny valley phenomenon, which refers to the effect that user affinity increases as realism increases, but drops sharply (hence a valley) as digital characters become almost but not quite human realistic (Mori, 1970; Mori, Kageki, & MacDorman, 2012). Prior research has primarily examined user reactions to viewing static images or scripted pre-recorded videos of avatars (Mathur & Reichling, 2016; Wang et al., 2015). Hence, a key unanswered

question is how *interaction* (i.e., unscripted communication) affects user perceptions, as such user engagement moves beyond simply the judgement of physical appearance to direct involvement with such characters. In this research, we focused our main investigation on interactions with *avatars* – characters controlled by humans – to remove the variant issue of the realism of any artificial intelligence (AI) needed to enable non-human virtual agents to interact with humans in a meaningful way.

Our aim was to explore if we could cross the Uncanny Valley by producing a photo-real avatar which exhibited more 'affinity' with users. While 'affinity' is the best translation of the original Japanese word *Shinwakan* (親和感), we reasoned trust was conceptually more informative in HCI (Mori et al., 2012). Trust is a core value to both communities.

Our approach was to present both a cartoon like caricature avatar and a highly realistic avatar in conversation and allow users to witness this on screen, in person and in Virtual Reality. (See figure 5). We also explored if our photo-real avatar provided more affinity and if it did, if this correlated with more trustworthiness. This was triangulated with open ended qualitative interviews. The production of such highly responsive computer avatars was extremely complex requiring a global combined effort of several teams in four countries.

This research benefited from the infrastructure generated and the insight gained in the building. Countless decisions were required during the development phase, each of which, by the very asking, provide greater insight into what is and can be researched. For example, hand gesturing proved more significant than prior discussion had considered, this resulted in one character having articulated hands and one not (figure 4). Based on prior research into the algorithmic component of artificial agents (Sagar, Seymour, & Henderson, 2016), our next stage of research was focused on the interpretation of what happens when a person engages with virtual humans. At the heart of the experience is the issue of agency and whose identity the observers believed they are experiencing, or how they view the embodiment.



*Figure 2: A 3D rendered close up of the more realistic of the two avatars. See Figure 4 below for an example of the more 'cartoon' second avatar*

In our experiment two people meet in VR. One meets with a cartoon avatar, the other with a highly realistic avatar. They are observed interacting by an audience in VR and on standard screens in real time. As both avatars represent experts, we examine how each was accepted. This research explores new areas of possible HCI so neither community's prior work, fully embraced the specific ethical issues we speculated about. Namely, issues surrounding trust and the role of avatars as stand-ins for ourselves in everyday life.

Our framing of the problem involves:

1. Defining the multiple phenomena including technical, attitudinal (acceptance) and phenomenological (trust and presence).
2. Measuring these phenomena of interest with mixed methods.

Generalizability of findings through the lens of existential presence.

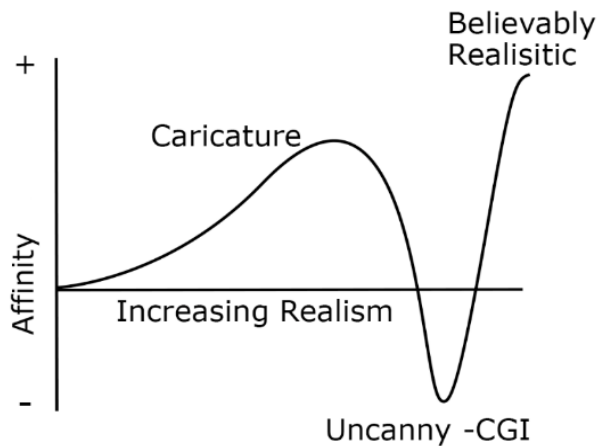

*Figure 3: The Uncanny Valley theory refers to the effect that user affinity increases as character realism increases, but drops sharply as digital characters become almost but not quite human realistic. This is reversed again as the likeness becomes highly realistic. This non-linear effect has been cited as the reason for limited virtual character adoption.*

#### 4 Blending of research experiences

We learned that shared experiences from both IT and IS are a rich source of insight. It is vital that we explore the actual interaction of real people when presented with a new and novel experience enabled by technology. A key feature is that technology is not presented as technology with a distinct interface for the user to manipulate. The need to holistically explore the interaction and not see the interaction as a state machine model of separated users and black box technology, required the building of new technology based on expert opinion.



*Figure 4: An example cartoon caricature as seen in the VR gear, note the second character's hands.*

#### 5 Summary

The research benefited from embracing perspectives from the practical lessons of building infrastructure and the philosophical nature of presence and experience theory. In so doing we believe valuable insights have been gained. A shared approach demonstrated a powerful way to explore new HCI technologies.

##### 5.1. Future Research

The specific finding of improved trustworthiness, both qualitative and quantitative, are to be published separately in journals and at conferences. This reflects and acknowledges that there

exists institutional dichotomization, which cannot be ignored. It is also true that the barriers of a common language can be time consuming. A shared understanding, within a discipline, does allow for validation of approaches and thinking. Tribalism, such as it is, aids understanding by commonality of language and approach.

Our decision to exclude an actual AI engine as the digital human driver during the avatar-human observed interactions was due to the research program constraints and the constructs under evaluation. But actual rather than emulated avatars without AI is an important future research opportunity. Such a digital human experiment would explore further the implications of broad AI to HCI adoption.

Looking to the future, building on this work from a very different perspective might be instructive. For example, exploring the nature of the research approach and language differences by outlining the CHI/HCI research using the 'same' approach. In other words, outlining how to approach the same research question(s) from both a strong *IT Design Science Research* approach and independently (from an equally rigorous) *IS Design Science Research* approach. There may be much to be learnt by examining how this topic could have been approached differently by a variety of different methodologies common yet different in each discipline. The side by side comparison of how each discipline would frame this problem may be informative in both the differences and the similarities.

## 5.2 Shared Experiences

While the stated focus of the different research communities may be different, there is much to be gained by embracing the benefits of the shared experiences when viewing new emerging HCI worlds, such as interactive virtual humans. AIS SIGHCI and ACM SIGCHI communities are different enough to be considered different disciplines, but they span much of the same space. By bringing their views and strengths together on innovative projects, we believe we can explore new ground, that neither perspective could explore as well independently.

## 6 References

- ACM SIGCHI Curricula for Human-Computer Interaction : 2. Definition and Overview of Human-Computer Interaction. (n.d.). Retrieved March 10, 2018, from <http://old.sigchi.org/cdg/cdg2.html>
- Association for Information Systems. (n.d.). *AIS transactions on human-computer interaction*. Association for Information Systems. Retrieved from <http://aisel.aisnet.org/thci/>
- Davis, F. D., Bagozzi, R. P., & Warshaw, P. R. (1989). User acceptance of computer technology: comparison of two theoretical models. *Management Science*, 35(8), 982–1003.
- Grudin, J. (2009). AI and HCI: Two Fields Divided by a Common Focus. *AI Magazine*, 30(4), 48. <https://doi.org/10.1609/AIMAG.V30I4.2271>
- Grudin, J. (2017). From Tool to Partner: The Evolution of Human-Computer Interaction. *Synthesis Lectures on Human-Centered Informatics*, 10(1), i-183. <https://doi.org/10.2200/S00745ED1V01Y201612HCI035>
- Latour, B. (2004). Why Has Critique Run out of Steam? From Matters of Fact to Matters of Concern. *Critical Inquiry*, 30(2), 225–248. <https://doi.org/10.1086/421123>
- Mathur, M. B., & Reichling, D. B. (2016). Navigating a social world with robot partners: A quantitative cartography of the Uncanny Valley. *Cognition*, 146, 22–32. <https://doi.org/10.1016/j.cognition.2015.09.008>
- Matthews, E. (2010). Maurice Merleau-Ponty: Phenomenology of perception. In *Central Works of Philosophy Volume 4: The Twentieth Century: Moore to Popper* (pp. 177–194). <https://doi.org/10.1017/UPO9781844653614.011>
- Mori, M. (1970). The uncanny valley. *Energy*, 7, 33–35. Retrieved from [http://ieeexplore.ieee.org/xpls/abs\\_all.jsp?arnumber=6213238](http://ieeexplore.ieee.org/xpls/abs_all.jsp?arnumber=6213238)
- Mori, M., Kageki, N., & MacDorman, K. F. (2012). The Uncanny Valley. *IEEE Robotics & Automation Magazine*, (June), 98–100.

- Orlikowski, W. J., & Iacono, S. (2001). Desperately seeking the 'IT' in IT research: A call to theorizing the IT artifact. *Information Systems Research*, 12(2), 121–134. <https://doi.org/10.1287/isre.12.2.121.9700>
- Sagar, M., Seymour, M., & Henderson, A. (2016). Creating connection with autonomous facial animation. *Communications of the ACM*, 59(12), 82–91. <https://doi.org/10.1145/2950041>
- Wang, S., Lilienfeld, S. O., & Rochat, P. (2015). The Uncanny Valley: Existence and Explanations. *Review of General Psychology*, 19(4), 393–407. <https://doi.org/10.1037/gpr0000056>

## Copyright

**Copyright:** © 2018 authors. This is an open-access article distributed under the terms of the [Creative Commons Attribution-NonCommercial 3.0 Australia License](#), which permits non-commercial use, distribution, and reproduction in any medium, provided the original author and ACIS are credited.

# The Existential Doctorate: Liminality in Industry-Academic Doctoral Partnerships

## **Natalie Hardwicke**

Discipline of Business Information Systems  
The University of Sydney Business School  
Sydney, New South Wales, Australia

## **Tim Mahlberg**

Discipline of Business Information Systems  
The University of Sydney Business School  
Sydney, New South Wales, Australia  
Email: tim.mahlberg@sydney.edu.au

## **Kai Riemer**

Discipline of Business Information Systems  
The University of Sydney Business School  
Sydney, New South Wales, Australia  
Email: kai.riemer@sydney.edu.au

## **Abstract**

Formalised industry-academic doctoral partnerships are increasingly sought as a way to bring academia and industry closer together. However, existing approaches appear to either reinforce the divide between the two “worlds” or acknowledge their independence. By focusing on both the doctoral candidate and their supervisor, we problematise existing doctoral partnership models in order to foreground our own “liminal” and “existential” doctoral experience. We provide self-reflections to discuss how the worlds of industry and academia can be transcended through the “liminal self”, as matters of being and belonging are brought into question as the embedded doctoral researcher navigates the two worlds. As a sensemaking process, our paper showcases an innovative and promising approach towards doctoral research; one where the candidate’s philosophical contemplation of their identity comes to play an irrevocable role in the exploration of an empirical phenomenon.

**Keywords** Doctoral Research, Industry-Academic, Liminality, Identity, Theory-Practice

## 1 Introduction

Information Systems (IS) has traditionally been an applied discipline that actively seeks to work with industry and society in the exploration of socio-technical research (Orlikowski and Barley 2001). In Australian universities, we find that expectations of IS scholars to engage meaningfully with industry appear to be increasing. In our own local department these expectations have given rise to an industry co-sponsored scholarship scheme. Naturally, PhD candidates in this scheme are expected to make contributions to both academia and industry. However, the worldviews held by academic peers in other IS contexts, and of course those of industry colleagues, can often seem “worlds apart”, leading to difficulties for the doctoral candidate who is required to navigate the different forms of knowledge embodied by people who comprise each world (Van de Ven 2007).

As two industry-sponsored doctoral candidates, we are writing this paper, with our shared supervisor, as a “confessional account” (Mathiassen and Sandberg 2013) to explore the particular nature of our doctoral projects and experiences which we have come to understand, through reflection and through writing this paper, as the “existential doctorate”. While all industry-focused PhD projects struggle with bridging the divide between theory and practice in their own kinds of ways, the existential doctorate is different in important ways, bridging this divide not merely as a matter of practicality in doing the research, but as a matter of principle in defining the research.

The demarcation of two distinct “worlds”, industry and academia, is often discussed in the IS literature in the context of bridging the so-called “theory-practice divide”. In this view, the world of industry is often seen as embodying “practice”, whilst “theory” is seen as belonging to the world of academia (e.g. Hay 2003; Smith 2006; Klein and Rowe 2008), which leads to tensions and practical problems of translating between these worlds in terms of both language and the particular aims of each. In the following we focus on how scholars have theorised ways in which to bridge the demarcation between the world of academia, and the world of industry, with a view to discuss the role of different kinds of formalised doctoral (PhD) partnerships for doing so.

We will utilise this as a backdrop to discuss the nature, purpose and challenges of the existential doctorate. We will argue that, what sets apart the existential doctorate as exemplified by our own doctoral projects, is that the candidate comes to problematise (Alvesson and Sköldbberg 2009) certain assumptions that underpinned their former role in industry. Such problematisation opens a productive space for enquiry, yet necessitates a kind of existential crisis whereby the candidate dwells in a liminal space between worlds, both practically in terms of how the research is organised and in terms of self-understanding. We do not purport that this model is in any way better for bringing the two worlds together. We do posit, however, that the most common approaches either reinforce the divide between the two worlds, or at least acknowledge their independence. In our own shared “worldview” however, we take the stance that a clear theory-practice distinction can never be made, as social phenomena are always disclosed through the unity of the two seemingly separate constructs (Feldman and Orlikowski 2011).

We draw upon Van Gennep’s (1909) rites of passage, and Turner’s view of liminality in such passage stages (1987), to explore how the industry-academic divide can be transcended by focusing on the doctoral candidate themselves, rather than the two worlds. In our own specific contexts, we show that our personal backgrounds have come to play a key role in the liminal experience as we play the roles of both “practitioner” and of “researcher” in iterative engagements across the two world settings. As such, we encounter experiences of belonging within and between both worlds simultaneously. What has emerged for us has been the ambiguous experience of trying to navigate, and make sense of (Weick 1995), the “epistemological chasm” that unfolds in such navigation between industry and academia. Writing this paper is thus itself part of a shared broader sensemaking process, as we attempt to articulate how the identities we assume across the two worlds cannot be divorced from ourselves as individuals, as we try to make overall sense of our respective doctoral research.

Our paper proceeds by first outlining and exploring two common “types” of formalised industry-academic partnership doctoral models that we identified as prevalent in the literature and academic practice. For each, we explore how the two worlds of industry and academia are seen in relation to the candidate and their supervisor, and then contrast these with our own self-reflections. We demonstrate our experiences to-date by taking inspiration from Feldman and Orlikowski’s (2011) paper in which the authors offered their own lived experiences of studying practice. In providing reflections of our lived experience to-date, we paint the doctorate as an existential endeavour, as we critically question views of engaged scholarship by outlining how our liminal “self” unifies the two worlds of industry and academia.

## 2 Industry-Academic Partnerships

Establishing doctoral partnerships as a way to bridge the divide between industry and academia is not new. For example, in our own Australian context, the cooperative research centre (CRC) program was established by the government in the early 1990s for doctoral candidates to become “boundary spanners” across industry, government, and university research bodies (Manathunga et. al 2012). The initiative acknowledged that different forms of knowledge exist in and across localised contexts, and promoted various career opportunities for the doctoral candidates in developing skills across such contexts. Similarly, in some European countries, formalised partnerships have been established from the perspective of doctoral candidates to gain access to more relevant “data”, promoting a collaborative research effort for real-world problem solving, and leading to more creative solutions for knowledge exchange between partnered organisations and academia (Borrell-Damian et. al 2010).

We suggest that these industry-partnered research approaches are distinguished from more traditional research that also involves access to industry. A dominant approach would be instances whereby “friendly” industry representatives open their organisation’s doors to let the doctoral candidate (and supervisor) “in” for data access, without any expectation of returns in the form of knowledge or learning. For the purposes of this paper, we are staying within the context of formalised partnerships where there is genuine interest and active involvement from parties on both sides. This can often include industry contributions towards some form of doctoral stipend, but will more importantly involve regular interaction throughout the candidature, such as joint decision making for research direction, progress meetings, and ongoing communication as the research unfolds.

We focus on formalised doctoral partnerships for three reasons. Firstly, our own partnerships were established as part of our university’s strategy to foster research interaction with industry partners more generally. Secondly, the overall goal of a doctoral thesis is a novel contribution to knowledge, grounded in the rigour of academic methods and theory. In industry partnerships, this creation of knowledge is arguably shaped not only by the candidate’s previous status as a practitioner or student, but also in their situated partnership context. Lastly, doctoral programs highlight the candidate in the context of their probationary status as scholars. This, we suggest, is amplified in industry-academic partnerships, as such models are not always developed, or chosen, by the candidate for the aim of creating a purely academic career at the outset.

## 3 Common Approaches to Doctoral Partnerships

In exploring different doctoral models, our search and analysis of the literature proceeded with the aim to identify industry-academic partnerships that were similar, but also distinctly different, from our own. A key element in our literature approach was to look at the problematization of research questions (Boell and Cecez-Kecmanovic 2014), which in formalised contexts draws attention to the empirical “problem” the candidate is looking to address from either an industry or academic perspective. The purpose of engaging with the literature in this manner has been to uncover how the doctoral candidate is perceived across different doctoral contexts within both business schools and universities more broadly. The nature of the two “worlds” that comprise the partnership not only highlights the purpose behind the research, but also how the candidate may approach, and perceive, the divide.

We do not purport to present a complete list of partnered industry-academic cases, past or present. Rather, for the purpose of this paper, we provide three primary partnership approaches that we uncovered in our search. Note that we will for each provide a stylized account that is not intended to describe accurately how such a “model” would be enacted in practice in particular cases. We suggest that the first two general approaches reinforce the divide existing between industry and academia, whereas the alternative third model actively attempts to bridge this divide. We will problematize this third model to foreground our own approach of the “liminal” doctorate as unifying the two worlds.

### 3.1 The Industry Problem-Solving Doctorate

The first model of industry partnered doctoral research we uncovered begins with a motivated industry representative reaching out to a university to “commission” research around a problem they wish to solve (e.g. Roberts 2018). In our own university, there are several partnered scholarships of this variety. An industry partner grants the selected doctoral candidate access to their organisational data specifically to solve a defined problem. As a result, the problem itself appears “pre-packaged” and determined prior to the candidate being selected. The candidate is expected to use the industry data and draw on academic theory in order to support an empirical approach towards solving the industry partner’s problem.



In turn, the research outcome is intended to contribute back to the academic literature. This view of industry-driven problem solving seems to somewhat mirror the established approach of theory “gap-filling” we find commonly in the literature and in general doctoral research approaches; whereby knowledge is missing, and data is collected, analysed, and subsequently used to address this gap (e.g. Westphal and Khanna 2003).

In such a model, however, minimal attention appears to be given to the particular candidate’s background in industry, or their own desires for research. The doctoral candidate rather serves as an “academic instrument”, suggesting that their role is mostly viewed in terms of their academic research skills rather than any particular industry knowledge. The candidate predominately stays within the academic world and engages with industry at arms-length for data collection purposes, and the sharing of the eventual solution.

The role of the supervisor is mainly to guide and monitor, ensuring the candidate is approaching the industry problem from established theories and research methodologies. Importantly, if we removed the candidate, the research could arguably still be done by the supervisor. This approach could be considered as a typical form of industry problem-solving, with the additional by-product of academic training, in that the candidate is enrolled into the practice by standing in for and being mentored by the senior researcher.

### **3.2 The Practitioner-Doctorate**

The second model sees a practitioner who works in industry approach a university to undertake a doctorate, often on a part-time basis. Termed the practitioner-doctorate, this approach has grown in popularity in both the UK and Australia since the early 2000s (Lester 2004) and is set up with the aim to develop the candidate as a “scholarly professional” rather than an academic researcher (e.g. Stewart and Chen 2009). Here, the doctoral research appears secondary in focus as priority is given to the practitioner’s primary work role. In some universities this model has been institutionalised as a Doctor in Business Administration (DBA).

In this model, the doctoral candidate is predominately situated in industry and engages with academia in direct response to their practitioner context. The appeal of such a model for academia is that the candidate addresses a “wicked problem” they have identified or are currently experiencing. The engagement with academia may be viewed as legitimising a practice-driven framework that the candidate is trying to establish through scholarship. As such, the model draws on the theory and rigour of methodologies developed in academia for engaging in highly-specialised practitioner contexts; ones which require a research element. Hence, the focus is on the application of certain techniques, rather than specifically on a contribution to academic theory, which may be of lower priority or even the provenance of the doctoral supervisor.

The role of the supervisor is thus quite different compared to the first model. The doctoral research only exists because of the expertise that the practitioner brings to the process. Although the industry context that the candidate is situated in can also be explored by the supervisor, the expertise of the candidate cannot be replicated. As such, the supervisor has to learn and make sense of aspects of the practitioner-situated context in order to advise the candidate on relevant theories and methodological approaches. This also brings into question how the supervisor would perceive such a relationship, as the academic contribution is seen as secondary to the industry one.

### **3.3 Critical Appraisal of the Two Models**

Both the industry problem-solving and practitioner-doctoral models reinforce the notion of a divide between industry and academia. This is because in both cases, the doctoral candidate is situated firmly within one world while their relationship with the other world is predominantly transactional. In the first case, industry provides a problem for the application of academic theory and research methodology, solved by the doctoral candidate; whilst in the second case, academia provides theory and research methodology for the doctoral candidate to use in their own practical problem. In both cases, one world defines the project by utilising aspects of the other world, and the candidate is regarded as either an instrument or an instigator for bringing the two worlds together.

Importantly, the doctoral candidate in each instance will draw their sense of identity firmly from the context of one respective “world”. The industry problem-solving doctoral candidate remains in and of the world of academia, with their identity firmly as that of an academic apprentice who belongs to, and aims to graduate, into the university ranks. The practitioner-doctoral candidate remains in and of the world of industry as a professional, borrowing the academic processes and references of theory in order

to further their industry-based career. Neither doctoral candidate is truly bridging nor living-in both worlds, and as such can be viewed as reinforcing the industry-academia divide.

### 3.4 The Engaged Doctorate

Unlike in the first two models, an engaged doctorate aims for a more “open door” policy between the worlds of academia and industry. The doctoral candidate is able, metaphorically speaking, to walk back-and-forth across the bridge between worlds, because the engaged model requires in-situ involvement of the candidate within and across both worlds. This can be from the perspective of a doctoral candidate currently working as a practitioner, but who is able to “come-and-go” within the academic context, meaning they can engage with different people who comprise each respective world, as well as split their time and physically work out of each world in iterative encounters (e.g. Mathiassen and Sandberg 2013). This approach is also evident from the other perspective, in which the doctoral candidate is seen as having prior industry expertise, and who can also come-and-go within an industry context under the guise of functioning as or like a practitioner (e.g. Cater-Steel et. al 2017).

Although the engaged doctorate model still has the candidate as being situated in one world more than the other, the “coming-and-going” (Nicolini 2012) relationship allows for the exploration of an empirical problem to be identified and then solved, rather than it being pre-packaged as we outlined for the first two models. The idea is that the iterative movement across the two worlds allows the candidate to be a “learner-in-context”, rather than as an instrument or a vehicle for required problem solving of a pre-packaged empirical topic.

Mathiassen and Sandberg (2013), for example, report on a case in which the industry expertise of the doctoral candidate interacted with their supervisor who served as an active mentor. The candidate experienced frustrations and difficulties in navigating both worlds, as the mentoring role of the supervisor, combined with the role of theory, came to be applied when the practitioner was re-situated back in their industry context. As a result, the candidate made a pragmatic attempt to bridge the knowledge divide between the two worlds.

Outlining another set of examples, Cater-Steel et. al (2017) reported on doctoral candidates engaging in design-science and action research studies, where the candidates worked closely with industry practitioners attempting to solve a problem, which in turn shaped the iterative engagement the candidates needed to have with academia, such as the exploration of existing theories, as well as actively working to explore and solve the industry problem.

### 3.5 Critical Appraisal of the Engaged Doctorate

Although the engaged doctoral model is arguably a more promising way that aims to address the industry-academic divide, it treats bridging of the two worlds as a practical matter. Firstly, doctoral programs themselves are generally set up as a pathway or an apprenticeship process into academia. Much like the first two models, the engaged doctorate still firmly positions the candidate as developing a career in the world they are predominately situated in from the outset. Secondly, there is generally still an expectation, on the industry side, that a concrete problem will be solved by the candidate; the only difference being that the candidate plays a more active role in shaping and solving such a problem through their interactive and iterative engagement across both worlds.

Lastly, the two worlds are seen as “bridged” mostly due to the outcome of the research that ideally benefits both worlds through the iterative process. The existence of the divide between the two worlds is generally acknowledged as an important issue or “wicked problem” to be addressed, which has implications for the experience of the doctoral researcher themselves, who acts as the “boundary spanner” between worlds. What we suggest is missing, however, is a recognition of the emerging other “world” which is shaped through this research approach — that experienced by the doctoral candidate who performs the iterative shifting between worlds, which importantly shapes the research process.

The three approaches we have discussed focus on the doctoral candidate in relation to the two worlds of industry and academia. However, each model downplays, or at worst neglects, the fundamental and essential role of the doctoral candidate themselves; the very individual, we argue, who is not only responsible for bringing the two worlds together through the doctoral research process, but who is the irrevocable element for any sort of “bridge crossing” or “unification” to occur. We will now explore how our own experiences as “embedded” doctoral candidates can be considered as a particular kind of engaged scholarship, and how our approach of being situated in both worlds simultaneously, rather than merely interacting between worlds, allows us to *transcend* the industry-academic dichotomy, as well as identify and explore unique empirical phenomena which directly depends on the liminal existence on the boundary between both worlds.

## 4 The Existential Doctorate: Our Stories

Our respective doctoral research approaches build on the engaged scholarship model in that we find ourselves in the iterative space of “coming-and-going” between two worlds, yet in a way that we both experience as “living-in” both worlds. Importantly, in our approach we foreground the doctoral candidate and our experience and journey as being key to the research. We are each sponsored by separate professional consultancy firms and are both situated in the discipline of Business Information Systems at the University of Sydney Business School. While our supervisor and third author established both scholarships with our respective industry partners, we have each been free to explore a social phenomenon of our choosing, so long as it relates to the respective topic areas around the digital workplace and disruptive technologies, such as enterprise social networking (ESN), which is of interest to both industry partners. What we have each chosen to explore, and how, has been premised by the “why” behind our doctoral research and our own backgrounds prior to embarking on the research.

Unlike the other models, which firm up career perspectives at the outset or aim to solve an industry problem, we have engaged in our research from a personal perspective of wanting to explore research issues that are, in important ways, quite personal. Furthermore, and unlike with the other models, there was no immediate expectation on us to deliver a concrete “solution” to our industry partner at the completion of our dissertation, despite the fact that both scholarships include a formalised financial contribution from the industry partners. The reason for this, in one of our contexts, is because the candidate already contributes to the industry practice each time they are engaged with them. In the other context, the partner seeks to have a formal academic relationship to strengthen their consultancy bravado and interest in research. The main way each of our partners can benefit from our research is by learning and self-reflecting on their own practices, as told through our eyes. In the following we discuss our own respective stories, taking cue from Feldman and Orlikowski (2011). We then explore how our identities have come to play a key role in our doctoral approach in transcending the divide.

### 4.1 Natalie’s Story

My PhD was advertised as an industry-partnered scholarship exploring ESN. I had built my career as a business analyst, but at the time of seeing the advertisement, had been employed as an internal communications (IC) manager; someone responsible for implementing and managing social “channels”, such as ESN, inside a workplace context. I was also in the process of completing my part-time master’s thesis exploring how ESN was changing the theory and practice of the IC function. I had also published industry book chapters about how IC teams can still achieve their objectives of top-down communication, and promoting employee engagement, despite ESN putting power in the hands of end-users. My work and master’s research focused on ESN in reference to the needs of IC. However, in order to commence my PhD, my prior industry work had to be given up.

From week one of my PhD, I began accompanying my scholarship company, Ripple Effect Group (REG) under the guise of being one of their practitioners. REG are a small consultancy group specialising in design thinking approaches towards the digital workplace; specifically, designing solutions for how social technology can be introduced and used by employees inside the workplace. I knew very little about their working practice, so had to learn “on the job”, which I later discovered was part of their approach to design, of taking people on a journey of “doing”. I would attend their client meetings as a practitioner, and would later ask the team members questions, as a researcher, about what we had experienced. I would then go to my supervisor to discuss both of these contexts, who would then suggest literature for me to read. At the same time, I also had coursework and teaching commitments within the academic context. My time across both world settings has had this even split throughout my candidature.

Within the first two months of my dual practitioner-researcher role, I noticed a pattern. All of REG’s clients were coming from an enabling business function, just like the one that I myself had worked in prior, such as IC, and they all wanted to impose social technology onto their employees, much like what my previous industry role had required and what my master’s thesis explored. However, the client worldview of the people-technology relationship was distinctly different to that of my scholarship company (and that of my supervisor). As a result, conflicts and tensions between client and consultant emerged (see Hardwicke 2017). I knew I wanted this to be the topic of my PhD research around the six-month stage, as this was when I experienced a kind of existential crisis. I had realised that my prior “self” had sensitised me towards this phenomenon, but in order for me to explore it empirically, I had to unlearn everything I thought I knew about technology and the IC function. This was not easy, as it meant re-evaluating my entire industry career, and renouncing the contribution of my master’s thesis. But at the same time this insight and existential struggle was what allowed me to problematize in effective ways

the approach to technology implementation embodied by the IC function (and much of the IS literature), and by my prior self.

## 4.2 Tim's Story

Prior to starting my doctoral studies, I worked in a large Australian financial services organisation. My earlier roles leveraged my postgraduate masters in organisational psychology in a more traditional way as an internal consultant. However, over several years of job transitions, I'd found myself working in a unique role that would be considered quite innovative and on the "fringes" of a typical career in this industry. Always intending to do further study, but not knowing exactly what area in, I was alerted to my doctorate opportunity through a social media post by a colleague. The broad focus of the topic, "exploring the future of work", appealed to me both in its relevance to my own recent experience, and the ability for me to shape my research direction. It was an industry conversation that I wanted to contribute meaningfully to, and which I currently do outside of my doctorate through independent consulting work, drawing on both my previous experience and increasingly my doctoral research.

In the first year of my candidature, I spent a lot of time in the offices of my sponsoring organisation, a global professional services firm, informally interviewing individuals and attending events which seemed relevant to my broad research area. Over time, I noticed a distinct pattern in the individuals I met there which I found most interesting; they were helping the firm to adapt and evolve by performing knowledge work that went above and beyond their formal role in the organisation, and they often used social media to facilitate this. From this observation, I've drawn on identity theory to conceptualise this alternative knowledge work as the performance of an "alter-identity", whereby multiple professional identities are lived simultaneously (Mahlberg 2017).

Importantly, this phenomenon, now central to my doctoral thesis, both reflects my earlier career working in the financial services firm, and my concurrent consulting work where I act as a "catalyst" operating on the "fringes" of my client organisation in order to sense-make new directions, drive innovation, and design new services. In this way my research traces my own story, which is the very reason that I was attuned to see this phenomenon. Most recently, I reflected on this as I completed a number of in-depth interviews with employees from my sponsoring company, professing to my co-author colleague that "I feel like I have been interviewing myself".

It is a strange experience to simultaneously identify with my interviewee and "belong", but also be on the outside looking into their world as a researcher. I could say the same for "being" a doctoral candidate, as I regularly reflect on both belonging (as a doctoral candidate) and not-belonging (as a practitioner-consultant) in the academic world, as I perform other various identities around the university, including those of mentor and teacher. It is quite befitting that my emerging research direction has sensitised me not only to the multiple identities I performed in my work prior to the doctorate, but also now across different contexts, and how it has challenged my prior convictions and worldview as an organisational psychologist, in ways that has allowed me to see the unique nature of the alter-identity phenomenon.

## 5 Discussion

In comparison to the doctoral partnership models outlined earlier, we suggest three specific areas in which our "embedded" doctorate approach offers unique extensions: the role and identity of the researcher, the liminal nature of our research process, and the changing role of the supervisor. We explore each of these through our preliminary shared sensemaking of our research journeys, and outline what this allows us to do differently compared to the other models.

### 5.1 Identity: Matters of Being

In both our cases, our identities and sense of belonging play a central role in our research. Instead of being merely "engaged" doctoral candidates, we are "embedded" and "invested" within both worlds. What appears in each case is a performance of multiple identities within each world, whereby the identity of both practitioner and researcher is performed with the partnership company, depending on the context. Similarly, on the academic side, identities of doctoral candidate, coursework student, mentor or teacher are performed, depending on the context. Performing multiple identities has sensitised us, as individuals, to a "meta" view of ourselves; whereby our "moving between" identities and contexts leads to a questioning of *where* we belong as we make sense of our overall doctoral experience (Weick 1995).

This "meta-identity" is also being performed by each of us as we conceptualise and write this very paper. This shared experience has emerged organically over time, leading us to not only forge an "alliance" with

one another in our sensemaking, but to recognise a supplementary phenomenon in addition to our primary empirical one; the contemplation of the “self” in the epistemological “chasm”. In other words, iterations of coming-and-going between industry and academic worlds mean that our experience within one world shapes the experience we come to have in the other world, though we do not identify as belonging in one world more so than the other. Instead, the coming-and-going changes the “self” who navigates between, rather than the navigation bringing the two worlds together. The changing self becomes the metaphorical bridge. Although the self remains the “constant” across such navigation, it is the changing self which enables each world to “converse” and create meaning with the other.

Our shared sensemaking alliance formed through our observation that both of us feel we are investigating an aspect of our prior industry “selves” through our empirical research, and thus also problematising the professions we held before embarking upon our doctoral studies. This has been augmented by the relationship with our supervisor who has challenged us to rethink what it means to “be” in the world in the first place (Dreyfus and Wrathall 2005). In turn, we have not only come to question our prior practitioner identities, but also our prior academic identities, which were based on different ontological paradigms compared to our current doctoral studies. We suggest that this is a unique feature and existential challenge that has arisen from our “embedded” doctoral research approach, which led us to coin the term “existential doctorate”.

What is not shared in our stories above is the lived experience of this coming-and-going between worlds; the tensions and frustrations, the emotions behind identity breakdowns, and the existential crises that this experience gives rise to. Ironically, these experiences are what we have also come to document in our empirical research as we encounter our respective phenomenon in the context of our partnered organisations. Exploring this is beyond the scope of this paper, but a promising, albeit deeply philosophical direction, to which we wish to take our enquiry further.

Importantly, we hope to highlight that the role of identity in our doctoral research becomes more personal and therefore more demanding; requiring significant “identity work” (Alvesson & Wilmott 2001). Our model goes beyond just drawing on the prior professional expertise of the candidate, as expected in the practitioner-doctorate approach, but brings the individual more intimately into the topic and phenomenon of investigation, in that the research is shaped *through* the individual.

Furthermore, we argue that the research phenomenon is identified *because* of the individual and their unique worldview that forms from being and going in-between worlds. The “whole” individual becomes the interpretive tool in the research process; the self who is being sensitised and recalibrated in iterative engagements in the context of exploring an organisational phenomenon. This makes our experiences distinctly different from other partnership approaches.

## 5.2 Liminality: Matters of Belonging

For the purposes of this paper in exploring questions of self, identity and belonging between worlds, we found it useful to draw on Van Gennep’s rites of passage (1909) and Turner’s (1987) view of liminality. Van Gennep suggests three rites of passage before individuals are accepted into, and belong to, any social practice. Until such passage is achieved, an individual remains “on probation”. In the first stage, an individual must abandon their prior identity and navigate the unfamiliar territory of the community they seek to join. In the second stage, the individual experiences a sense of transition – of no longer identifying themselves with their previous community, yet still not being fully included in the new community. In the final stage, an individual completes their probation and becomes a community member.

In our doctoral contexts, we see ourselves in the second stage of being in-transition. We have abandoned our previous practitioner “selves”, but do not currently hold status or belonging in either world that comprises our respective industry-academic contexts. The role of liminality, in this second stage, is our lived experience of being “betwixt and between” these two worlds (Turner 1987). We experience “encounters” of belonging as we navigate the two worlds in iterative engagements.

In our cases, the liminal engagement of being planted in both worlds simultaneously, but not being a full community member of either, means the destination at the outset of our doctoral degree is not clear. Unlike the previously discussed approaches, we do not belong in, nor identify ourselves as being in, one world more so than the other world. However, we argue that to not identify or belong in either world is a strength of the “liminal doctorate” experience. In exploring our phenomenon from a stance of ontological inseparability (Riemer and Johnston 2017) in which we cannot divorce ourselves from navigating the two worlds, our empirical phenomena becomes explored via the “holistic self” in the ambiguous in-between space.

Thus, being embedded in both worlds, but belonging to neither, means that our liminal experience allows us to explore an empirical phenomenon that would not otherwise be possible. It is only through such liminal engagement in which our sense of identity has played a key role, that a Gestalt shift has been able to take place. In both of our examples, our prior practitioner selves foregrounded our respective empirical phenomenon. However, in no longer identifying in that role, and now not belonging as members in either of our current industry-academic contexts, our identity breakdown has become the instigator of this Gestalt shift. The “break” with the former self is what has allowed for an intellectual “opening” for our respective research to take shape.

Through this break we have been able, as researchers, to be outsiders looking-in to the practices we once identified with (as practitioners), but for which we had not previously been sensitised to as we are now. As we were once on the “inside” of these practices, our passing through the first rite of passage stage is what has allowed for an “outsider” contemplation that we employ in our current second passage stage. Previously familiar aspects of this practitioner world have now come into focus as strange *because* we now have experience of being outside, yet we are nevertheless able to draw on the intimate knowledge of having once been part of it, which was the very basis for doing the research.

In sum, the liminal journey of simultaneously navigating the old and new worlds is what gives rise to the contemplative self; one who takes a “middle-way” between two worlds and existentially questions themselves in the process of such a journey. This makes for a productive opening for critically reflecting and thus carrying out the research about the former world, without having been restricted by becoming fully part of the new one. Although beyond the scope of this paper, this view of the self as being the unifying element for the bridging of two perceived worlds is a central tenet of the Chinese philosophical notion of yin-and-yang, whereby the ‘S’ line between the two parts of the black-and-white symbol is regarded as the middle path – the route an individual takes for harmonising opposite states (Chen 2002).

### 5.3 Role of the Supervisor: Matters of Existential Questioning

Finally, we suggest that our “embedded” doctorate calls for a different role of the supervisor. Given that there is greater entanglement between the individual’s identity(s), experiences and the emerging research topic, the supervisor is required to be more involved in a sensemaking capacity than might be expected in other partnership doctorates where advice concentrates more on process and methods. This is partly due to the absence of clearly expected research outcomes provided from the outset that comes from either academia or industry in the other models, but also because of the more “wicked”, and indeed existential problems that may be tackled through the existential doctorate.

Our approach also acknowledges that the thesis topic is intimately entangled with and in reference to both worlds, even though the supervisor is situated in the academic world. As such, the personal nature of the doctorate experience requires greater sensitivity from the supervisor to the existential line of enquiry that will emerge. The identity of the supervisor and their prior involvement with industry partners may also play a key role. In our case, our supervisor had an academic relationship working with both of our industry partners prior to our doctoral commencement, which was essential for securing the openness of the industry partner which we suggest was critical to enable our embedded, liminal study. Therefore, the supervisor’s role is required to go beyond that of a custodian of the rites of passage of the academic world, to that of “philosopher-guide”, supporting the candidate to uncover knowledge and truths which are meaningful for them, as well as being open to exploring new aspects of the industry partner they had prior engagement with.

Importantly, the supervisor must see the researcher as more than merely incidental to the research process, but rather central to it, and respect the iterative nature of open self-discovery over the course of the research process as this is key to making sense of the research topic at hand. We argue that this also requires a different epistemological understanding of how knowledge is created, and ontological appreciation for the lived experience of the doctoral candidate. Further inquiry into the supervisor relationship in the liminal doctoral experience seems promising, especially given the observation that in our particular context, where we have shared the same liminal phenomenon, we have also shared the same supervisor.

## 6 Conclusion

What we have foregrounded in this paper is an innovative, novel approach to doctoral research in formalised industry-academic partnership contexts. By taking a more embedded approach and focusing on the individual doctoral candidate, we have explored how existential questions of performing multiples identities across, within and between the worlds of industry and academia can help in the

uncovering and exploration of a novel organisational phenomenon. The focus on the doctoral candidate not belonging within either world allows for transcendence of industry and academic worlds through an experience of liminality; of unlearning one's prior identity, and not belonging in either side of an industry-academic partnership. As the writing of this paper has in itself been a sensemaking activity for ourselves, we have used the process to explore the "meta" identity aspects of our respective doctoral journeys. We want to keep exploring and elaborating on the ideas expressed in this paper in a future publication, as this paper forms part of our initial (public) sensemaking process.

## 7 References

- Alvesson, M., and Sköldbberg, K. 2009. *Reflexive Methodology: New Vistas for Qualitative Research (Second Edition)*. London: Sage Publications Inc.
- Alvesson, M., and Willmott, H. 2001. "Identity Regulation as Organizational Control : Producing the Appropriate Individual," pp. 1–32.
- Boell, S.K. and Cecez-Kecmanovic, D. 2014. "A hermeneutic approach for conducting literature reviews and literature searches," *CAIS*, 34, p.12.
- Borrell-Damian, L., Brown, T., Dearing, A., Font, J. and Hagen, S. 2010. "Collaborative doctoral education: University-industry partnerships for enhancing knowledge exchange," *Higher education policy*, vol. 23, no. 4, pp. 514;493;-514.
- Cater-Steel, A., Toleman, M. and Rajaeian, M.M. 2017. "An analysis of design science research adoption in Doctoral projects in Australia", In *Proceedings of the 28th Australasian Conference on Information Systems (ACIS 2017)*, Australian Association for Information Systems.
- Chen, M. 2002. "Transcending paradox: The Chinese "middle way" perspective," *Asia Pacific Journal of Management*, 19 (2-3), pp.179-199.
- Dreyfus, H. and Wrathall, M. 2005. "Martin Heidegger: An introduction to his thought, work, and life," *A companion to Heidegger*, pp.1-15.
- Feldman, M. S. and Orlikowski, W. J. 2011. "Theorizing Practice and Practicing Theory," *Organization Science* (22:5), pp. 1240–1253.
- Hardwicke, N. 2017. "Practices in Juxtaposition: Tensions in social software appropriation projects", in *Proceedings of the 28th Australasian Conference on Information Systems (ACIS 2017)*, Australasian Association for Information Systems, Hobart.
- Hay, G.W. 2003. "Executive PhDs as a solution to the perceived relevance gap between theory and practice: a framework of theory-practice linkages for the study of the executive doctoral scholar-practitioner," *International Journal of Organizational Behaviour*, 7 (2), 375–393.
- Klein, H.K. and Rowe, F. 2008. "Marshalling the professional experience of doctoral students: a contribution to the practical relevance debate," *MIS Quarterly*, 32 (4), 675–686.
- Lester, S. 2004. "Conceptualizing the practitioner doctorate," *Studies in Higher Education*, 29 (6), pp.757-770.
- Mahlberg, T. 2017. "Alter-Identity Work via Social Media in Professional Service Contexts." in *Proceedings of the 28th Australasian Conference on Information Systems (ACIS 2017)*, Australasian Association for Information Systems, Hobart.
- Manathunga, C., Pitt, R., Cox, L., Boreham, P., Mellick, G. and Lant, P. 2012. "Evaluating industry-based doctoral research programs: perspectives and outcomes of Australian Cooperative Research Centre graduates," *Studies in Higher Education*, vol. 37, no. 7, pp. 843-858.
- Mathiassen, L. and Sandberg, A. 2013. "How a professionally qualified doctoral student bridged the practice-research gap: a confessional account of Collaborative Practice Research," *European Journal of Information Systems*, 22, no. 4: 475-492.
- Nicolini, D. 2012. *Practice theory, work, and organization: An introduction*, Oxford University Press.
- Orlikowski, W.J. and Barley, S.R. 2001. "Technology and institutions: What can research on information technology and research on organizations learn from each other?," *MIS Quarterly*, 25(2), pp.145-165.
- Riemer, K., and Johnston, R.B. 2017. "Clarifying Ontological Inseparability with Heidegger's Analysis of Equipment," *MIS Quarterly*, (41:4), pp. 1059-1081.
- Roberts, A.G. 2018. "Industry and PhD engagement programs: inspiring collaboration and driving knowledge exchange," *Perspectives: Policy and Practice in Higher Education*, pp.1-9.

- Smith, M.L., 2006. "Overcoming theory-practice inconsistencies: Critical realism and information systems research," *Information and organization*, 16(3), pp.191-211.
- Stewart, R.A. and Chen, L., 2009. "Developing a framework for work integrated research higher degree studies in an Australian engineering context," *European Journal of Engineering Education*, 34(2), pp.155-169.
- Turner, V. 1987. *Betwixt and between: The liminal period in rites of passage*, Betwixt and between: Patterns of masculine and feminine initiation, pp.3-19.
- Van de Ven, A.H. 2007. *Engaged Scholarship: A Guide for Organizational and Social Research*. Oxford University Press, Oxford.
- Van Gennep, A. 1909. *The Rites of Passage*, London: Routledge and Kegan Paul.
- Weick, K.E. 1995. *Sensemaking in organizations*, Sage Publications, Michigan.
- Westphal, J., and Khanna, P. 2003. "Keeping directors in line: Social distancing as a control mechanism in the corporate elite," *Administrative Science Quarterly*, 48: 3.

## Acknowledgements

We wish to pay our respects to our dear colleague, friend and confidant, Natalie Hardwicke, who passed away suddenly and unexpectedly while this paper was under review. You are with us every day as we continue to experience this worldly existence. Thank you for sharing this journey.

## Copyright

© 2018 Natalie Hardwicke, Tim Mahlberg & Kai Riemer. This is an open-access article distributed under the terms of the [Creative Commons Attribution-Non Commercial 3.0 Australia License](https://creativecommons.org/licenses/by-nc/3.0/australia/), which permits non-commercial use, distribution, and reproduction in any medium, provided the original author and ACIS are credited.



# Privacy Concerns and Acceptance of Government Surveillance in Australia

## Joel Kininmonth

School of Management  
Curtin University  
Perth, Australia  
Email: joel.kininmonth@postgrad.curtin.edu.au

## Nik Thompson

School of Management  
Curtin University  
Perth, Australia  
Email: nik.thompson@curtin.edu.au

## Tanya McGill

School of Engineering and Information Technology  
Murdoch University  
Perth, Western Australia  
Email: t.mcgill@murdoch.edu.au

## Anna Bunn

Curtin Law School  
Curtin University  
Perth, Australia  
Email: a.bunn@curtin.edu.au

## Abstract

Increases in routine data collection and surveillance in recent years have resulted in ongoing tension between citizens' privacy concerns, perceived need for government surveillance and acceptance of policies. We address the lack of Australia focussed research through an online survey of 100 Australian residents. Data was analysed using PLS, revealing that privacy concerns around collection influence acceptance of surveillance but do not influence enactment of privacy protections. Conversely, respondents' concerns about secondary use of data were unrelated to their levels of acceptance, yet were a significant determinant of privacy protections. These findings suggest that respondents conflate surveillance with collection of data, and may not consider subsequent secondary use. This highlights the multi-dimensional nature of privacy which must be studied at sufficiently granular level to draw meaningful conclusions. Our research also considers the role of trust in government, and perceived need for surveillance and these findings are discussed with their implications.

**Keywords** Privacy Concerns, Government Surveillance, Acceptance of Surveillance, meta-data retention, Australia

## 1 Introduction

In recent years, citizens in many jurisdictions have found themselves subject to increasing levels of routine government surveillance (Denemark 2012). This position is generally justified by policy makers as a necessary response to protect the population from criminal or terrorist activities. However, there is potential for these measures to lead to a perceived erosion of privacy. As an example, in Australia, the recently implemented metadata retention regime mandates that service providers log their customers' location data and online activities for a period of two years. This has broad reach and is of concern to many residents, potentially leading them to reject the justification for this collection, and/or to enact privacy protections to safeguard themselves.

Anecdotal evidence at various points in time supports this position. For instance, internet searches for privacy protections such as VPN or Tor increased immediately after Edward Snowden's leaks regarding government surveillance, and later after the implementation of the metadata retention legislation in Australia (Google Trends 2018a; Google Trends 2018b). This suggests that citizens may be responding to this perceived intrusion by considering means to circumvent such surveillance measures and protect themselves online.

Evidence from the US and Europe reveals several factors that can influence the public acceptance of surveillance measures: these include privacy concerns (Dinev and Hart 2006; Dinev et al. 2008), the perceived need for surveillance (Brown and Korff 2009; Dutton et al. 2005), trust in the government and its management of data (Trüdinger and Steckermeier 2017) and the use of privacy protections (Joh 2013). Despite this, there has been little research conducted in an Australian context as to the factors influencing public acceptance of government surveillance.

Our central research question is thus: What are the determinants of acceptance of government surveillance of the Australian public? We address the research gap by developing a model considering the factors that drive public acceptance of surveillance. We then empirically evaluate this model by gathering survey data from 100 Australian residents and analysing the results using Partial Least Squares (PLS) structural equation modelling. In the remaining sections of the paper we consider the background and justification for our hypotheses, followed by our data analysis and discussion of results. The paper closes by considering implications for both theory and practice.

## 2 Theoretical Framework and Research Hypotheses

Prior literature suggests that there is lack of systematic understanding of the public's view on government surveillance (Reddick et al. 2015; Robert 2015). In recent years, surveillance has been increasingly normalised, with multiple facets of daily life subject to increased scrutiny and "datafication". As noted, our literature review revealed that most work has been conducted in the US with little work situated in an Australian context. This is relevant, as national differences in legal frameworks, societal norms or even culture may influence the acceptance of government surveillance. Furthermore, the Australian metadata retention regime is one of the motivations for this study, as both the success and the acceptance of this significant and wide reaching project may hinge on some of the factors being considered in this research.

Whatever the ends served by government surveillance, public perceptions of government surveillance practices are important. As the Australian Law Council has recently observed in relation to proposed identity-matching legislation, the government should be "highly conscious of how the law is seen to operate and, in particular, maintain robust levels of transparency and accountability" (Bailes 2018). Dutton et al. (2005) explored the role of cyber trust in government. They identified a "trust tension" between the need to collect data on individuals as the basis for providing services, and anxieties about data surveillance or the inappropriate use of personal information gathered, stored, and analysed using information technologies. Through this exploration, they identified strategies which the government could employ in order to enhance the level of trust, including establishing identity, the implementation of guidelines and legal frameworks, and the importance of legislation being implemented in ways that enhance, rather than undermine trust. In this research, we study several potential determinants of this trust, or acceptance, including privacy concerns, perceived need for surveillance, and trust in the government and its management of data. The theoretical foundation of our research builds on the model developed by Dinev et al. (2008), which we extend with constructs from other related work (e.g. Siegrist et al. 2003; Trüdinger and Steckermeier 2017). The justification for inclusion of these constructs and the associated hypotheses are discussed in the following sections.

## 2.1 Privacy Concerns of Collection and Secondary Use of Data

Privacy as a concept has proven notoriously difficult to define (Smith et al. 2011), not least due to its multi-faceted and highly contextualised nature – that is, privacy means different things to different people and can be understood differently depending on where and when one is situated (e.g. Thierer 2013; Whitman 2003). Several overlapping categories, or domains, of privacy have been identified (Banisar and Davies 1999), including information privacy, territorial privacy, bodily privacy and privacy of communications. In terms of information privacy, Smith et. al (1996) identified key areas of privacy concerns held by individuals as including the collection of, improper access to, and unauthorised usage of information. In terms of internet privacy concerns, these have been identified (Dinev and Hart, 2006a) as “perceptions about opportunistic behaviour related to the disclosure of personal information submitted over the Internet”, and it is these concerns that are at the forefront of people’s minds. The general perception of threats to information privacy is in a gradual shift away from the threats posed by the private sector (private entities utilising data for commercial gain), towards threats posted by governmental national security and intelligence activities (Wilton 2017).

Despite the prevalence of definitions of privacy, a number of scholars argue that privacy is best understood as being about control, whether in relation to certain domains, such as personal information (Westin 1967) or, more generally, in the sense of controlling access to oneself (Altman 1976) or the management of social interaction (Foddy and Finighan 1980). Given that government surveillance involves, among other things, collection and use of data, including in the online context, and given that surveillance is ubiquitous and a practice over which individuals have limited control, it might be expected that individuals who are concerned about the collection and/or use of their personal information would be less likely to accept government surveillance. Thus we hypothesise:

*H1: Privacy concerns regarding the collection of data will negatively influence the acceptance of surveillance*

*H2: Privacy concerns regarding the secondary use of data will negatively influence the acceptance of surveillance*

## 2.2 Perceived Need for Surveillance

Although government surveillance is directed to various purposes, including prevention of crime, enforcement of revenue law and monitoring of voters, a central purpose of surveillance is national security. Indeed, one of the main arguments raised by governments to justify the implementation or increase of government surveillance is the need to protect its citizens from harm by preventing and responding to threats to national security in a more efficient manner. When large scale tragedies occur, it is often easy to suggest that lack of information prior to the event was a contributing factor. Following the terror attacks in Sydney, 2014, and Paris, 2015, the Australian Government promoted the idea that a metadata retention scheme was essential in order to protect national security, even though many questioned whether the extent of the measures was proportionate (Suzor et al. 2017). Dinev et al. (2008) found that, despite a slight decline since 9/11, there was still broad support among US citizens’ for law enforcement to have even greater powers. More recently, a 2016 UK study, regarding the move to expand surveillance powers of UK intelligence organisations, found that 63% of those polled supported the expansion, with “27% claiming their opinion has changed due to recent terror activities” (Computer Business Review 2016). These results indicate that fear from ongoing attacks and/or governmental pressure is indicative of acceptance of such measures. Thus we hypothesise:

*H3: Perceived need for surveillance will positively influence the acceptance of surveillance*

## 2.3 Trust in Government, and its Management of Data

Trust in government is becoming an increasingly significant issue in many advanced democracies such as the US or UK (Hardin 2013). Many recent high-profile intrusions, such as unwarranted wire-tapping of phones (Baldwin Jr and Shaw 2006) and indiscriminate mass surveillance by government security agencies (Wilton 2017) have threatened trust in government and may influence the perception of government agencies’ ability to adequately maintain data securely.

Even prior to implementation of the Australian metadata retention scheme, Australian law-enforcement agencies were already under scrutiny for accessing web histories, without a relevant warrant (Grubb 2014). In addition to high-profile leaks occurring in the United States, the leaking of confidential documents has been prominent in the Australian media in recent years (McGhee and McKinnon 2018). The loss of hundreds of highly classified documents made headlines in early 2018,

after government furniture containing a trove of classified information was sold to the public (McGhee and McKinnon 2018). Also in 2018, a high profile leak of documents appeared to reveal a proposal for the Australian Signals Directorate (ASD) to increase the scope of its monitoring to include Australian citizens (Belot 2018). These are just two recent examples of top-secret information getting into the hands of the public and the media, potentially degrading the credibility of Australia's security agencies and their ability to hold information securely.

Levels of political trust may, in turn, have implications for the extent to which citizens support government surveillance. Trüdinger and Steckermeier (2017) found a positive relationship between political trust and the support of surveillance measures in Germany. Thus we hypothesise:

*H4: Trust in government will positively influence acceptance of surveillance*

*H5: Trust in government data management will positively influence acceptance of surveillance*

## **2.4 Privacy Protections**

Joh (2013), described a broad range of "Privacy Protests" by which individuals are able to maintain their level of privacy and reduce their digital trail, including Tor, the encryption of digital communications, the use of temporary email addresses, burner (disposable) phones, and the emphasis on using cash or prepaid debit cards. According to Wilton (2017), consumers are becoming increasingly aware of the merits of using such obfuscating tools. The difficulty in evading technological surveillance may therefore be lessening, given that all technologies can be outsmarted, given enough time, resources or ingenuity (Lyon 2003). In the context of metadata retention, for example, simply utilising a VPN, which can be obtained freely, will mean that much of the data intended to be captured will be unreadable to the ISP and that the targets of surveillance, such as criminals or terrorists, will continue to evade detection (Ockenden 2017). Choi et al. (2018) found a positive association between higher levels of privacy concerns and stronger actions taken to protect individual privacy. The US Pew Research Center showed that 34% ( $n = 475$ ) of the people who were aware of the government surveillance programs exposed by former NSA contractor Edward Snowden had changed the way they protected themselves, by utilising at least one measure to shield themselves from government scrutiny (Shelton et al. 2015). That same awareness also led to 25% of individuals modifying the way they used technology "a great deal" or "somewhat" (Shelton et al. 2015). In line with these findings we hypothesise:

*H6: Privacy concerns regarding the collection of data will positively influence privacy protections*

*H7: Privacy concerns regarding the secondary use of data will positively influence privacy protections*

*H8: Acceptance of surveillance will negatively influence privacy protections*

## **3 Research Method and Design**

An anonymous online survey was developed and administered using the Qualtrics platform. All participants were 18 or over and were residents of Australia. Snowball sampling was employed, with the initial distribution being conducted through the researchers own social networks, including LinkedIn and Facebook. The survey was open for data collection between April 2018 and May 2018. Human Research Ethics Committee approval was sought from our human research ethics committee prior to commencing data collection.

### **3.1 Survey development**

The introductory section of the survey gathered general demographic information about participants including age, gender and political affiliation. The core questions to test the above hypotheses were based on validated instruments from previously published research. The dimensions considered and sources are summarized in Table 1. Survey items are available in full from the cited papers and for brevity are not replicated.

The items to measure respondents' perceptions were measured on 5 point Likert scales from 1 "Strongly Disagree" to 5 "Strongly Agree". Privacy Protections were measured using a list of ten items and respondents indicated whether or not they had adopted measures such as the use of a VPN, temporary email address or changing social media privacy settings. The overall measure of Privacy Protections was thus calculated as the sum of the responses to these ten items.

<b>Construct</b>	<b>Definition</b>	<b>Source</b>
Privacy Concerns of Collection	Individuals' concern that data about their personalities, background or activities is being accumulated.	Smith et al. (1996) <i>Collection &amp; Improper access sub-scales</i>
Privacy Concerns of Secondary Use	Individuals' concern that any collected information may then be re-purposed or disclosed to other parties without authorization.	Smith et al. (1996) <i>Secondary use sub-scale</i>
Perceived Need for Surveillance	Perception that government surveillance is necessary for the protection of citizens.	Dinev et al. (2008)
Trust in Government	Individuals' level of trust in the government and legal system.	Trüdinger and Steckermeier (2017)
Trust in Government Data Management	Individuals' level of trust in the government's ability to protect data, and honesty in communicating any risks.	Siegrist et al. (2003) <i>Social Trust sub-scale</i>
Acceptance of Surveillance	Individuals' acceptance of a range of surveillance activities.	Trüdinger and Steckermeier (2017)/New items for Australian metadata retention of IP address, phone call and location data
Privacy Protections	Protective behaviours enacted to preserve online privacy.	Shelton et al. (2015)

Table 1: Survey item sources

## 4 Results and Analysis

Following the closure of the data collection period, a total of 129 responses had been gathered. Initial checking revealed that 29 responses were incomplete and these were not included in the data analysis. Of the 100 complete survey respondents, 55% were male and 45% female and 34% of the respondents were between the ages of 25-34 and 23% from 35-44. There were no outliers in the data, as assessed by inspection of a boxplot. Participants were also asked the political party that they felt most aligned with. Labor held the highest margin (32%), with Liberal/National affiliation ranking second (28%). When aggregated into their respective left/right position on the political spectrum, there was a 16% greater support for the left-leaning parties than for the right-leaning ones amongst participants.

Mean Privacy Concerns of Collection and Secondary Use were high (4.38 /5 and 4.76/5); most individuals strongly felt the need for protection of their privacy. The mean levels of Trust in Government Data Management were relatively low (2.38/5), with many individuals believing the government is not transparent in its acquisition of, or communication about the implications of holding private data. The mean levels of Perceived Need for Surveillance (2.90/5) and Trust in Government (2.93/5) were also slightly lower than neutral suggesting that, on average, respondents felt a relatively low need for surveillance, and were lacking trust in the government.

The average individual utilised between three and four Privacy Protections out of a possible ten. The top three Privacy Protections were “*changing your privacy settings on social media*”, “*using more complex passwords*” and “*giving inaccurate or misleading information about yourself*”, all of which are easily accomplished by many individuals. Over a third of the sample use a VPN, while only 10% have used Tor. There were individuals who had adopted all Privacy Protections, while some had adopted none. These findings are summarized below in Table 2.

<b>Construct</b>	<b>Minimum</b>	<b>Maximum</b>	<b>Mean</b>	<b>SD</b>
Privacy Concerns of Collection	2.71	5	4.38	0.56
Privacy Concerns of Secondary Use	3.5	5	4.76	0.37
Perceived Need for Surveillance	1	4.75	2.92	0.99
Trust in Government	1	5	2.93	0.83
Trust in Government Data Management	1	4.67	2.38	1.01
Acceptance of Surveillance	1.2	5	3.09	0.94
Privacy Protections	0	10	3.41	2.41

Table 2: Descriptive statistics

#### 4.1 PLS Modelling

Since a single survey was used to collect all of the variables, we assessed the potential threat of common method variance (CMV) through a Harmon one-factor analysis. The results showed that the most variance explained by one factor was 27.9%. Therefore, CMV is unlikely to be a serious concern in this data set. The model was next tested with PLS using SmartPLS 2.0 (Ringle et al. 2005), using a bootstrap resampling method with 1000 iterations to determine the significance of the paths.

Convergent validity was confirmed by testing that all item loadings were significant and above the cut-off value of 0.50 (Hulland 1999); the composite reliabilities and Cronbach Alpha of all constructs were above 0.70 (Hulland 1999). Average variance extracted (AVE) of all constructs was above the threshold of 0.50 (Hulland 1999) with the exception of Privacy Concerns of Collection, which was marginally lower at 0.47. This was retained, as the items were drawn from a single validated scale and removal of items to increase AVE did not change the significance of paths in subsequent analysis. Discriminant validity was tested by ensuring that the square root of AVE for each construct exceeded the correlations between that construct and any other construct, and this is summarized below in Table 3. Thus, the measures of the reflective constructs demonstrated good psychometric properties.

	<b>1</b>	<b>2</b>	<b>3</b>	<b>4</b>	<b>5</b>	<b>6</b>	<b>7</b>
Acceptance of Surveillance	<b>0.73</b>						
Privacy Protections	-0.35	<b>single</b>					
Trust in Government Data Management	0.50	-0.39	<b>0.83</b>				
Trust in Government	0.63	-0.26	0.63	<b>0.81</b>			
Privacy Concerns of Collection	-0.35	0.22	-0.30	-0.36	<b>0.68</b>		
Privacy Concerns of Secondary Use	-0.21	0.29	-0.08	-0.16	0.44	<b>0.72</b>	
Perceived Need for Surveillance	0.71	-0.28	0.53	0.58	-0.26	-0.17	<b>0.87</b>

Table 3: Correlation between constructs and square-root of AVEs (on-diagonal)

We then examined the structural model (see Figure 1). Acceptance of Surveillance was negatively influenced by Privacy Concerns of Collection ( $\beta = -.10$ ,  $p < .05$ ), and positively influenced by Perceived Need for Surveillance ( $\beta = .50$ ,  $p < .001$ ) and Trust in Government ( $\beta = .29$ ,  $p < .001$ ) leading us to accept H1, H3 and H4. We did not find significant support for influence of either Privacy Concerns of Secondary Use or Trust in Government Data Management thus leading us to reject H2 and H5.

In terms of protective behaviours, the results indicate that Privacy Concerns of Collection does not influence the enactment of Privacy Protections, leading us to reject H6. Interestingly, Privacy Concerns of Secondary Use does positively influence Privacy Protections ( $\beta = .24$ ,  $p < .001$ ) lending support for H7. Finally, there is a strong relationship between Acceptance of Surveillance and Privacy Protections

as hypothesised in H8. These factors together explained 58.4% of variance for Acceptance of Surveillance and 17.6% of the variance in Privacy Protections.

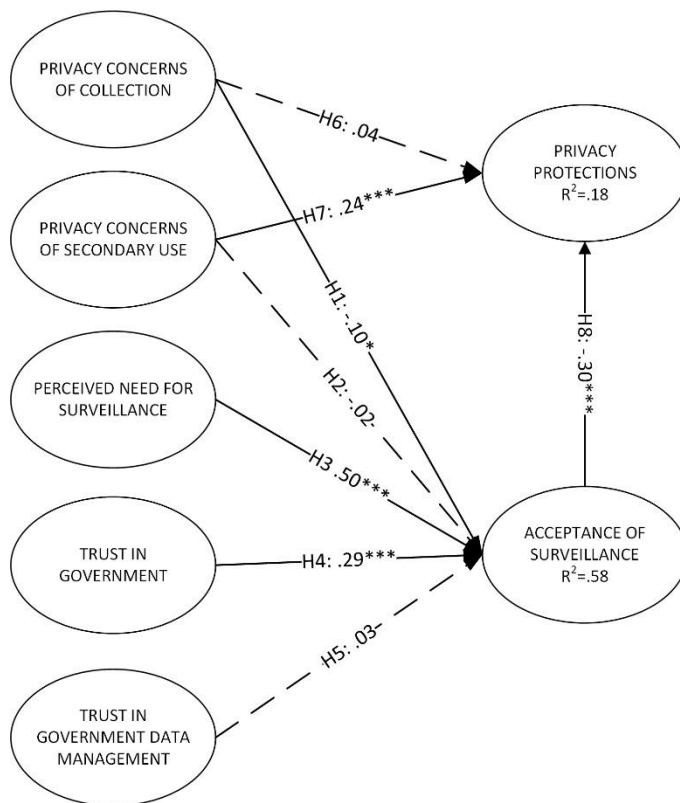

Note: \* $p < .05$ , \*\* $p < .01$ , \*\*\* $p < .001$ .

Figure 1: Calculated model

## 5 Discussion

The purpose of this research was to test the relationships between Privacy Concerns, the use of Privacy Protections, the Perceived Need for Surveillance, Trust in Government and Trust in Government Data Management and to identify the determinants of Acceptance of Surveillance. Five out of the eight hypotheses were supported by the results, as seen in Figure 1.

Privacy concerns about the collection of data were found to significantly influence acceptance of surveillance. This is as expected, and supports H1. Those generally concerned about their private information being gathered during online interactions, are also less accepting of government surveillance. Perhaps more interesting, is the lack of significance between privacy concerns about secondary use of data and the acceptance of surveillance: that is, concerns around secondary use did not influence use of acceptance. Although these are closely related concepts (i.e. it is common practice to store collected data for later repurposing), the respondents appear to have not associated the two. One explanation for this is that individuals may hold a simplistic mental model (Thompson and McGill 2017) that surveillance is analogous to “watching” or “observing” and may not even consider the potential secondary use of this same data. However, it is also possible that some people simply do not regard being subject to surveillance as an interference with privacy. As Solove has noted (2007, 748): “When discussing whether government surveillance and data mining pose a threat to privacy, many people respond that they have nothing to hide.” Yet this says nothing about whether those same people would be concerned about a secondary use of any data captured during surveillance. For example, a person might accept surveillance by CCTV but find it unacceptable if that footage was broadcast to a general audience as part of a television documentary. Given that the questions relating to privacy concerns about secondary use related to more general use, another possible explanation here is that people have more faith that data captured during government surveillance will not be used (or misused) for secondary purposes than they have that data captured by the private sector will not be repurposed.

Those who believed that government surveillance was needed were more likely to accept surveillance, as were those who had trust in the government: thus supporting hypotheses H3 and H4. However, there was no significant link between respondents' trust in the government's data management and the acceptance of surveillance, as had been hypothesised in H5. A possible explanation for this is that, as already discussed above, people may not consider surveillance per se as an interference with their privacy, even if they would consider the use (or misuse) of data captured during surveillance as an interference. Alternatively, people may simply fail to associate the act of surveillance with the use of data obtained during it.

Privacy concerns about the collection of data found to not be a significant determinant of privacy protections, as had been hypothesised in H6. One possible explanation for this is that where individuals make active decisions around collection of their personal information, or feel they are making such decisions, it is possible that collection of personal information is not experienced as a loss of control, and thus not as an interference with their privacy. Another possible explanation is that while individuals are concerned about collection of their data, they nevertheless regard that collection as a "necessary evil" – the price to pay, perhaps, for receiving goods or services – and one that is not necessarily overcome by the use of privacy protections. For example, using a fake email address is not going to assist if one is purchasing goods online. Moreover, in a social media context, as Tufekci (2008) has pointed out, some people may be prepared to trade off privacy in order to reap the benefits of disclosure and publicity. This does not necessarily mean, of course, that those individuals are not concerned about the collection of their personal information, only that they may be more concerned about other things.

On the other hand, privacy concerns about secondary use of data do significantly influence the employment of privacy protections, as was hypothesised in H7. This could be for reasons similar to those explained by Brandimarte et al (2009), who found that when individuals themselves publish private information online, they believe they retain some form of control over the access and use of that information by others. Conversely, where a third party publishes that data, individuals perceive a loss of control and realise that once private information is posted online it can be accessed and used by others, even without authorisation. By analogy, and as also suggested above, it is possible that individuals possess an illusion of control in respect of information that is collected from them (because they perceive the provision of that information as an agentic act, similar to publication) but do not possess a similar perception of control in respect of the subsequent use or repurposing of that information. Moreover, as discussed above, individuals may believe that the benefits of allowing collection of their personal information outweigh the benefits of taking certain privacy protections. In terms of the secondary use of such data, however, the risks or disadvantages may be perceived to outweigh any benefits, thus influencing the utilisation of privacy protections.

Finally, as hypothesised in H8, individuals who are accepting of government surveillance measures are significantly less likely to employ privacy protections. This is consistent with Choi et al. (2018), and also provides a possible reason why the spike in searches for privacy topics (Google Trends 2018a; Google Trends 2018b) may not result in higher mean privacy protections. As longitudinal data is not available, it is however impossible to draw any inferences about trends over time.

## **5.1 Implications for Research and Practice**

The research model employed in this study is the first to integrate these constructs into a single model which may be adopted for future research projects. Findings from this study demonstrate that individuals' perceived need for surveillance remains to be the strongest predictor of acceptance. This has practical implications, as history has shown that changes to government surveillance policies are often made as a reaction to tragic situations, and thus public acceptance of these hinges on the emotional response to these events (Reddick et al. 2015). Policy makers should exercise caution, however, as reliance on emotional responses could potentially lead to counter-productive effects if a similarly emotionally evocative story or campaign were to diminish perceived need for surveillance, leading to widespread rejection and evasion of government security policies. Arguably, this is particularly likely if such a campaign were to undermine public trust in the government, given that an individual's general trust in the government also significantly determines the acceptance of surveillance. Efforts to maintain transparency around the use of surveillance methods and techniques would potentially improve general public trust in the government, and also lead to sustained or even increased acceptance. Malhotra et al. (2004) found that when individuals are informed about surveillance policies and when clear and transparent information is provided around what is collected, feelings of control are reinforced. Consistent with control-based conceptions of privacy, therefore,



individuals who feel in control may not experience surveillance as an interference with privacy, thereby increasing acceptance of surveillance.

## 6 Limitations and Future Work

This research was conducted in the midst of multiple, high-profile and heavily publicised privacy and security events, including the implementation of the General Data Protection Regulation in the European Union the collection of up to 87 million Facebook users' personally identifiable information by Cambridge Analytica, discussion around forcing technological organisations to provide a "backdoor" for security agencies in Australia, and the leaking of multiple classified pieces of information by Australian security agencies. These events brought notions of privacy, security and trust into the spotlight and may have influenced the responses in the cohort.

The method of study recruitment was through a snowball sampling, with participants initially recruited through social media. By utilising more systematic methods of survey sampling and gathering information from wider areas of Australia, it would be possible to attain a larger sample of the entire Australian population, which may support the generalizability of the findings. As the scope of this research focussed only on Australia, international variations of this study, utilising this model, should be conducted. As much related work has been conducted in the US, another western culture, it is not yet possible to infer if there are cultural influences in these results. It would be valuable to conduct research in a non-western culture which may, for instance, be differentiated in terms of individualism or power-distance dimensions.

Finally, it is interesting to note that a third of respondents used a VPN. This single privacy protection is sufficient to counteract the objective of the entire metadata retention scheme in Australia, as it applies to online metadata. Therefore, it may well be that respondents are selective in their adoption of protections and opt for quality over quantity and/or that those who adopt particular privacy protections (such as use of a VPN) are generally suspicious of government surveillance. This is an area that lends itself to further investigation.

## 7 Conclusion

The pervasive nature of technology, the need to keep people safe and be seen to be doing so, as well as a wider awareness of "big data", has led to an expansion in government surveillance and data collection. Yet, as the Law Council of Australia has observed, it is "unacceptable to assume the majority of Australians, who are not criminals and have the expectation to be kept safe by the state, are willing to succumb to heightened surveillance" (Bailes 2018). In order to be seen as legitimate, therefore, government surveillance needs to be widely accepted. The main contribution of this research is the identification of factors which influence acceptance of such measures. It has also served to highlight the nature and extent of protective behaviours, or privacy protections, employed and some of the drivers behind the utilisation of those protections. Ultimately, however, it must be remembered that privacy concerns are nuanced and subjective: some individuals, for example, may not perceive the practice of surveillance as an interference with their privacy at all, but would nevertheless consider the reuse and repurposing of data captured during surveillance as a privacy harm. Others may see surveillance and collection of their data as threats to their privacy, but ones they are prepared to accept as part of a broader trade off, whether for enhanced safety, personal utility or other reasons. Therefore drawing valid conclusions about privacy concerns and the drivers of those is something which can only be done if such concerns as studied at sufficiently granular level.

## 8 References

- Altman, I. 1976. "Privacy : A Conceptual Analysis," *Environment and behavior* (8:1), pp 7-29.
- Bailes, M. 2018. "Time to Draw the Line on Government Surveillance of Citizens." Retrieved 22 July 2018, from <https://indaily.com.au/opinion/2018/05/04/time-draw-line-government-surveillance-citizens/>
- Baldwin Jr, F.N., and Shaw, R.B. 2006. "Down to the Wire: Assessing the Constitutionality of the National Security Agency's Warrantless Wiretapping Program: Exit the Rule of Law," *University of Florida Journal of Law and Public Policy* (17), pp 429-472.

- Banisar, D., and Davies, S. 1999. "Global Trends in Privacy Protection: An International Survey of Privacy, Data Protection, and Surveillance Laws and Developments," *Journal of Computer & Information Law* (18), p 1.
- Belot, H. 2018. "Security Leak About Spy Agency Referred to AFP, Labor Raises Concerns with Government." from <http://www.abc.net.au/news/2018-04-29/labor-blames-government-for-security-leak/9708594>
- Brandimarte, L., Acquisti, A., Loewenstein, G., and Babcock, L. 2009. "Privacy Concerns and Information Disclosure: An Illusion of Control Hypothesis," in: *iConference 2009*. North Carolina.
- Brown, I., and Korff, D. 2009. "Terrorism and the Proportionality of Internet Surveillance," *European Journal of Criminology* (6:2), pp 119-134.
- Choi, H., Park, J., and Jung, Y. 2018. "The Role of Privacy Fatigue in Online Privacy Behavior," *Computers in Human Behavior* (81), 2018/04/01/, pp 42-51.
- Computer Business Review. 2016. "Two Thirds of Brits Support Mass Internet Surveillance Following Recent Terror Strikes." from <https://www.cbronline.com/news/mobility/security/two-thirds-of-brits-support-mass-internet-surveillance-following-recent-terror-strikes-120116-4774512/>
- Denemark, D. 2012. "Trust, Efficacy and Opposition to Anti-Terrorism Police Power: Australia in Comparative Perspective," *Australian Journal of Political Science* (47:1), pp 91-113.
- Dinev, T., and Hart, P. 2006. "Internet Privacy Concerns and Social Awareness as Determinants of Intention to Transact," *International Journal of Electronic Commerce* (10:2), pp 7-29.
- Dinev, T., Hart, P., and Mullen, M.R. 2008. "Internet Privacy Concerns and Beliefs About Government Surveillance – an Empirical Investigation," *The Journal of Strategic Information Systems* (17:3), pp 214-233.
- Dutton, W., Guerra, G., Zizzo, D., and Peltu, M. 2005. "The Cyber Trust Tension in E-Government: Balancing Identity, Privacy, Security," *Information Polity* (10:1-2), pp 13-23.
- Foddy, W.H., and Finighan, W. 1980. "The Concept of Privacy from a Symbolic Interaction Perspective," *Journal for the Theory of Social Behaviour* (10:1), pp 1-18.
- Google Trends. 2018a. "Tor: Australia." Retrieved 12/03/2018, 2018, from <https://trends.google.com/trends/explore?date=2015-04-01%202015-04-30&geo=AU&q=tor>
- Google Trends. 2018b. "VPN: Australia." Retrieved 12/03/2018, 2018, from <https://trends.google.com/trends/explore?date=2014-02-09%202018-03-12&geo=AU&q=vpn>
- Grubb, B. 2014. "Telstra Found Divulging Web Browsing Histories to Law-Enforcement Agencies without a Warrant." Retrieved 17/06/2018, 2018, from <https://www.smh.com.au/technology/telstra-found-divulging-web-browsing-histories-to-lawenforcement-agencies-without-a-warrant-20140819-106112.html>
- Hardin, R. 2013. "Government without Trust," *Journal of Trust Research* (3:1), pp 32-52.
- Hulland, J. 1999. "Use of Partial Least Squares (PLS) in Strategic Management Research: A Review of Four Recent Studies," *Strategic management journal* (20:2), pp 195-204.
- Joh, E.E. 2013. "Privacy Protests: Surveillance Evasion and Fourth Amendment Suspicion," *Arizona Law Review* (55), pp 997-1213.
- Lyon, D. 2003. "Technology Vs 'Terrorism': Circuits of City Surveillance since September 11th," *International Journal of Urban and Regional Research* (27:3), pp 666-678.
- Malhotra, N.K., Kim, S.S., and Agarwal, J. 2004. "Internet Users' Information Privacy Concerns (Iuipc): The Construct, the Scale, and a Causal Model," *Information Systems Research* (15:4), pp 336-355.
- McGhee, A., and McKinnon, M. 2018. "The Cabinet Files." from <http://www.abc.net.au/news/2018-01-31/cabinet-files-reveal-inner-government-decisions/9168442>
- Ockenden, W. 2017. "Metadata Retention Scheme Deadline Arrives, Digital Rights Advocates Say 'Get a VPN'." from <http://www.abc.net.au/news/2017-04-13/metadata-retention-scheme-deadline-arrives/8443168>

- Reddick, C.G., Chatfield, A.T., and Jaramillo, P.A. 2015. "Public Opinion on National Security Agency Surveillance Programs: A Multi-Method Approach," *Government Information Quarterly* (32:2), pp 129-141.
- Ringle, C.M., Wende, S., and Will, S. 2005. "Smartpls 2.0 (M3)." Hamburg.
- Robert, A. 2015. "Outcry over French Intelligence Bill." Retrieved 13/03/2018, 2018, from <http://www.euractiv.com/sections/infosociety/outcry-over-french-intelligence-bill-313779>
- Shelton, M., Rainie, L., Madden, M., Anderson, M., Duggan, M., Perrin, A., and Page, D. 2015. "Americans' Privacy Strategies Post-Snowden," Pew Research Centre.
- Siegrist, M., Earle, T.C., and Gutscher, H. 2003. "Test of a Trust and Confidence Model in the Applied Context of Electromagnetic Field (EMF) Risks," *Risk Analysis: An International Journal* (23:4), pp 705-716.
- Smith, H., Dinev, T., and Xu, H. 2011. "Information Privacy Research: An Interdisciplinary Review," *MIS Quarterly* (35:4), pp 989-1016.
- Smith, H., Milberg, S., and Burke, S. 1996. "Information Privacy: Measuring Individual's Concerns About Organizational Practices," *MIS Quarterly* (20:2), p 167.
- Suzor, N.P., Pappalardo, K.M., and McIntosh, N. 2017. "The Passage of Australia's Data Retention Regime: National Security, Human Rights, and Media Scrutiny," *Internet Policy Review* (6:1), pp 1-16.
- Thierer, A. 2013. "The Pursuit of Privacy in a World Where Information Control Is Failing," *Harvard Journal of Law & Public Policy* (36), pp 409-455.
- Thompson, N., and McGill, T. 2017. "Mining the Mind—Applying Quantitative Techniques to Mental Models of Security," *Australasian Conference on Information Systems 2017 (ACIS 2017)*.
- Trüdinger, E.-M., and Steckermeier, L.C. 2017. "Trusting and Controlling? Political Trust, Information and Acceptance of Surveillance Policies: The Case of Germany," *Government Information Quarterly* (34:3), pp 421-433.
- Tufekci, Z. 2008. "Can You See Me Now? Audience and Disclosure Regulation in Online Social Network Sites," *Bulletin of Science, Technology & Society* (28:1), pp 20-36.
- Westin, A.F. 1967. *Privacy and Freedom*. London: The Bodley Head Ltd.
- Whitman, J.Q. 2003. "The Two Western Cultures of Privacy: Dignity Versus Liberty," *Yale Law Journal* (113), pp 1151-1222.
- Wilton, R. 2017. "After Snowden – the Evolving Landscape of Privacy and Technology," *Journal of Information, Communication and Ethics in Society* (15:3), pp 328-335.

**Copyright:** © 2018 authors. This is an open-access article distributed under the terms of the [Creative Commons Attribution-NonCommercial 3.0 Australia License](https://creativecommons.org/licenses/by-nc/3.0/au/), which permits non-commercial use, distribution, and reproduction in any medium, provided the original author and ACIS are credited.

# Gender Differences in Information Security Perceptions and Behaviour

## **Tanya McGill**

School of Engineering and Information Technology  
Murdoch University  
Perth, Australia  
Email: T.Mcgill@murdoch.edu.au

## **Nik Thompson**

School of Management  
Curtin University  
Perth, Australia  
Email: Nik.Thompson@curtin.edu.au

## **Abstract**

Information security is of universal concern to computer users from all walks of life. Though gender differences in technology adoption are well researched, scant attention has been devoted to the study of gender differences in information security. We address this research gap by investigating how information security perceptions and behaviours vary between genders in a study involving 624 home users. The results reveal that females exhibit significantly lower overall levels of security behaviour than males. Furthermore, individual perceptions and behaviours in many cases also vary by gender. Our work provides evidence that gender effects should be considered when formulating information security education, training, and awareness initiatives. It also provides a foundation for future work to explore information security gender differences more deeply.

**Keywords** Information security, Gender, Home computer, Human factors, Security behaviour

## 1 Introduction

Information security is becoming increasingly important for individuals as well as organisations as information technology becomes part of all aspects of everyday life. Approximately 25% of data breaches in organisations are caused by end-users (Ponemon Institute 2013), similarly home users often fail to adopt basic security measures (Alshammari et al. 2015) or comprehend common security issues such as spam or phishing emails (Rajivan et al. 2017). Technical protections are part of the solution but human security behaviour is integral to effective protection. Security education, training, and awareness initiatives can help inform users' appraisals of security threats and provide guidance on how to effectively respond to these threats (Puhakainen and Siponen 2010). There has, however, been limited research on how demographic differences influence information security behaviour (Gratian et al. 2018), yet understanding this could be important in identifying users who may be more likely to have poor information security behaviour (McCormac et al. 2017). Understanding these differences can be used to tailor initiatives to increase their effectiveness.

This paper focuses on one key individual difference – gender – with the aim of investigating the role of gender differences in security behaviours and perceptions in order to identify differences that may have implications for securing home users' devices, software and data. It is the first large scale study that both targets a broad range of personal information security behaviours and considers gender differences in terms of the potential contributors to security behaviour proposed by Protection Motivation Theory (PMT) (Rogers 1975; Rogers 1983) and information security research that has arisen from it (e.g., Anderson and Agarwal 2010; Thompson et al. 2017; Tsai et al. 2016). It addresses the scarcity of research on gender differences in information security behaviour.

## 2 Background

Very little research has examined gender differences in information security behaviour, but differences have been identified in information technology use and perceptions associated with it. Women have been found to be more anxious about using information technology (Broos 2005; Chua et al. 1999; He and Freeman 2009). They also perceive software to be more useful than men do, but less easy to use (Gefen and Straub 1997; Venkatesh and Morris 2000). Women are also more influenced by ease of use in their e-learning adoption decisions (Ong and Lai 2006) and have less information technology experience, knowledge and computer self-efficacy (He and Freeman 2009).

The gender differences in security behaviour that have been found in the information security domain include females having a greater susceptibility to phishing attacks (Jagatic et al. 2007; Sheng et al. 2010), poorer password behaviour (Gratian et al. 2018), and lower likelihood of adopting privacy protecting behaviours (Milne et al. 2009). Females have, however, been reported to have higher levels of security concerns (Hoy and Milne 2010; Laric et al. 2009; Mohamed and Ahmad 2012). Findings such as these suggest that further research is needed to understand the reasons for these findings, and their implications.

Models such as PMT (Rogers 1975; Rogers 1983) have been used to help understand information security behaviour. PMT was originally developed in the context of health behaviour research and proposes factors that potentially influence intentions to undertake recommended behaviours. Studies applying PMT in the information security domain have successfully explained a substantial amount of the variance in information security behavioural intentions (Sommestad et al. 2015). Previous information security research that has used PMT suggests that user perceptions relating to perceived vulnerability, perceived severity, security self-efficacy, response costs and response efficacy can all influence security intentions (e.g., Boss et al. 2015; Liang and Xue 2010; Mwangwabi et al. 2018). In addition, subjective norm and descriptive norm have been shown to play a role in previous personal information security behaviour research, with subjective norm influencing intentions to protect personal computers and descriptive norm influencing intention to perform security behaviours relating to the Internet (Anderson and Agarwal 2010).

The role of gender is, however, less clear. Some studies have considered whether it has a direct influence on security intentions or behaviour (Gratian et al. 2018; Herath and Rao 2009; Mamonov and Benbunan-Fich 2018), whereas others model it as a precursor of constructs such as: perceived risk (Garbarino and Strahilevitz 2004); information privacy concern (Mohamed and Ahmad 2012); and perceived vulnerability, response efficacy and security self-efficacy (Chen and Zahedi 2016). It has also been modelled as a moderating influence (Luciano et al. 2010). This study provides a starting point for further investigation by exploring which security behaviour precursors exhibit gender differences.

### 3 Research Questions and Hypotheses

Home information technology users face numerous security threats (e.g. attacks on software vulnerabilities and phishing) and need to protect themselves by taking security measures such as backing up, creating secure passwords and installing security software. However, they generally have less access to security training and support. The research described in this paper is designed to compare the security behaviours and perceptions of males and females in order to identify differences that may have implications for securing home users' devices, software and data. As discussed above, PMT (Rogers 1975; Rogers 1983) proposes factors that potentially influence intentions to undertake behaviours and has been widely used in information security behaviour research. Research that has used PMT suggests that user perceptions relating to perceived vulnerability, perceived severity, security self-efficacy, response costs and response efficacy all influence security intentions (e.g., Boss et al. 2015; Liang and Xue 2010; Mwangabi et al. 2018). In addition, subjective norm and descriptive norm have been shown to play a role in previous research (Anderson and Agarwal 2010). These constructs are briefly defined below in Table 1.

Perception	Definition
Perceived severity	The degree to which a user believes that the consequences of security threats would be severe
Perceived vulnerability	The degree to which a user believes that they are likely to experience security related threats
Security self-efficacy	The degree to which a user is confident in their own ability to take protective action against security threats
Response efficacy	The degree to which a user believes that available protective measures are effective
Response cost	The degree to which a user believes that there are costs associated with recommended protective behaviours
Subjective norm	A user's beliefs as to whether others want them to perform security behaviours
Descriptive norm	A user's beliefs as to what most other people do in terms of protective security behaviours

*Table 1: Definitions of information security related perceptions considered in the study*

These factors as well as common security behaviours were therefore considered in order to answer the central research questions:

*RQ1: What, if any, differences are there in information security behaviours relating to personal computing between female and male users?*

*RQ2: What, if any, differences are there in information technology experience and information security perceptions between female and male personal computing users?*

Some previous research has identified gender differences in security behaviour, but the results have been mixed. Sheng et al. (2010) found that female users were more likely to click on links in phishing emails and continue on to provide personal information. Gratian et al. (2018) also found that females had weaker password behaviours in terms of password strength, regularly changing passwords and using different passwords for different accounts; they also had weaker updating behaviours such as not immediately installing updates. However Gratian and colleagues (2018) did not find differences in terms of device securement, and Pattinson et al. (2015) found no significant gender differences in work related computer-based security behaviour. Based on this, we anticipate that there will be differences across individual security behaviours such as password use and backup behaviour, and as the current study focusses on personal information security behaviour, we hypothesise that:

*H1: Females will have lower overall levels of information security behaviour than males*

Early research on gender differences found that computer use may be seen as a masculine activity (Williams et al. 1993) and that females were more anxious about using computers in general (e.g., Broos 2005). They were also found to perceive a higher risk in online purchasing (Garbarino and Strahilevitz 2004). A more recent meta-analysis suggests that there has only been a minimal reduction of the general difference in attitudes between genders, but that differences may be more pronounced in

specific areas of attitude (Cai et al. 2017); for instance in the context of online privacy concerns, with females being more concerned (Hoy and Milne 2010; Laric et al. 2009; Mohamed and Ahmad 2012). Thus it is likely that gender differences may exist in information security perceptions that have been shown to influence security behaviour (e.g., Anderson and Agarwal 2010; Boss et al. 2015; Liang and Xue 2010; Mwangi et al. 2018) and we hypothesise that:

*H2: Differences in information security perceptions will exist between females and males*

In exploring possible reasons for why females were more susceptible to phishing attacks, Sheng et al. (2010) found that their female participants had less technical knowledge and training than the male ones and proposed this as a partial explanation for differences in susceptibility to phishing attacks. Therefore, we hypothesise that:

*H3: Females will have less information technology skill and previous information security training than males*

## 4 Method

The target population for this study was people who use information technology devices such as home computers, tablets and smartphones for personal use, and data was collected using an anonymous online questionnaire.

### 4.1 Participants and Procedures

In order to obtain participants from a wide spectrum of backgrounds a third party recruiting company used census balanced random sampling to identify potential participants from their panel members. Potential participants in the United States were contacted via email and invited to participate by completing an anonymous online questionnaire that was hosted on SurveyMonkey. All participants were 18 or over and had both a home computer and a mobile device.

### 4.2 Survey Instrument

The first section of the questionnaire asked about gender, previous information security training and self-reported level of skill with information technology. The second section of the questionnaire asked questions about the participants' security perceptions and behaviours relating to one of their devices. To get a broad range of responses, participants were randomly allocated to answer questions about either their home computer use, or about their mobile device use. The security perceptions measured were: perceived vulnerability, perceived severity, security self-efficacy, response efficacy, response cost, subjective norm, and descriptive norm (see Table 1 above for brief definitions of these constructs). To ensure validity and reliability of the items, we selected items that had been validated in previous information security research wherever possible and the items were modified for the personal computing domain as necessary.

The items to measure information security perceptions were measured on 7 point Likert scales from 1 "Strongly Disagree" to 7 "Strongly Agree" (see Appendix for all security perception items and their sources). Once data collection and preparation were completed, reliability testing was conducted to ensure that the constructs demonstrated sufficient internal consistency. All Cronbach alphas were above 0.9, and the scales were thus found to be reliable (Nunnally 1978). A summary measure of each of these constructs was then calculated for each respondent as the average of the responses to the items.

Security behaviour was measured using six items, each of which asked the participant about whether or not they performed a specific common security behaviour (see Table 2 for a list of these behaviours). These items were chosen as representative of recommended personal information security behaviours, and responses to each were coded as 1 for "Yes" or 0 for "No" or "Unsure". An overall measure of information security behaviour was also calculated as the sum of the responses to the six items.

## 5 Results

A total of 624 valid responses (62.5% female and 37.5% male) were used for the analysis. As can be seen from Table 2, there were significant differences between females and males for three of the six individual security behaviours. There were gender differences in whether users had recent backups of their device ( $\chi^2(2, N=624) = 11.064; p = 0.004$ ), with females less likely to have recent backups (43.3% versus 53.8%). It was also interesting to note that females were more likely not to know whether they had recent backups (13.8% versus 6.4%). There were also significant differences between females and males in whether they had installed security software such as anti-malware themselves ( $\chi^2(2, N=624) = 7.805$ ;

$p = 0.020$ ), with females less likely to have done so. But there were no differences in terms of whether they used security software ( $\chi^2(2, N=624) = 3.749$ ;  $p = 0.153$ ).

	Females			Males			Sign. Diff?
	Yes (%)	No (%)	Unsure (%)	Yes (%)	No (%)	Unsure (%)	
Have recent backups	43.3	64.2	13.8	53.8	39.7	6.4	✓
Installed security software	49.7	40.5	9.7	59.8	35.0	5.1	✓
Use security software	63.3	26.9	9.7	68.4	26.1	5.6	✗
Enabled automatic updating of software	58.7	29.2	12.1	65.8	26.1	8.1	✗
Device secured with password	69.0	25.6	5.4	71.4	25.2	3.4	✗
Have a firewall enabled on home network	64.1	18.2	17.7	77.4	13.7	9.0	✓

*Table 2. Individual security behaviours comparison*

Females and males were not significantly different in terms of whether they enabled automatic updating of software ( $\chi^2(2, N=624) = 3.858$ ;  $p = 0.145$ ), nor in whether they secured their device with a password ( $\chi^2(2, N=624) = 1.346$ ;  $p = 0.510$ ). There were, however, significant differences between females and males in whether they had a firewall enabled in their home network ( $\chi^2(2, N=624) = 13.241$ ;  $p = 0.001$ ), with females less likely to have done so (64.1% versus 13.7%); females were also more likely not to know whether one had been enabled (17.7% versus 9.0%).

To compare levels of overall security behaviour, a non-parametric Mann-Whitney U test was used as the data did not meet the assumption of normality. As can be seen in Table 3, females had significantly lower levels of overall security behaviour than males (Mdn 4.00 vs 5.00;  $U=38,480$ ,  $Z=-3.33$ ,  $p=0.001$ ).  $H_1$  was therefore supported.

	Females		Males		p	Sig. Diff?
	Mean	SD	Mean	SD		
Security behaviour	3.48	1.91	3.97	1.91	0.001	✓
Perceived severity	6.08	1.18	5.72	1.28	<0.001	✓
Perceived vulnerability	4.68	1.41	4.75	1.21	0.614	✗
Security self-efficacy	5.12	1.31	5.30	1.08	0.160	✗
Response efficacy	5.07	1.31	5.02	1.11	0.387	✗
Response cost	3.30	1.49	3.36	1.47	0.507	✗
Subjective norm	3.86	1.60	3.88	1.56	0.655	✗
Descriptive norm	4.97	1.38	4.69	1.34	0.011	✓

*Table 3. Overall security behaviour and security perceptions comparison*

Table 3 also provides a gender comparison of the mean levels of each of the security perceptions relating to personal computing that were considered in this study. Differences in these perceptions were analysed using non-parametric Mann-Whitney U tests as the data did not meet the assumption of normality. Significant gender differences were found for two of the perceptions that were considered. Females were found to have significantly higher levels of perceived severity than males (Mdn 6.50 vs 6.00;  $U=36,642$ ,  $Z=-4.21$ ,  $p<0.001$ ); that is, they believed that the impact of a security event would be worse for them than males did. They did not however feel more vulnerable to security threats (Mdn 4.67 vs 4.83;  $U=44,532$ ,  $Z=-0.50$ ,  $p=0.614$ ).



The other significant gender difference related to descriptive norm. Females were more likely than males to believe that other people implement security measures to protect their devices (Mdn 5.00 vs 4.75;  $U=40125$ ,  $Z=-2.54$ ,  $p=0.011$ ). They did not, however, differ in their perceptions as to whether other people want them to undertake security behaviour to protect themselves (Mdn 4.67 vs 4.83;  $U=44,675$ ,  $Z=-0.45$ ,  $p=0.655$ ). No significant gender differences were found for the coping appraisal perceptions: security self-efficacy (Mdn 5.00 vs 5.33;  $U=42,574$ ,  $Z=1.40$ ,  $p=0.160$ ), response efficacy (Mdn 5.00 vs 5.00;  $U=43,756$ ,  $Z=-0.86$ ,  $p=0.387$ ) and response cost (Mdn 3.50 vs 3.57;  $U=44,186$ ,  $Z=-0.66$ ,  $p=0.507$ ).

These results provide partial support for H2, suggesting that there are some gender specific differences in information security perceptions, with female users believing that the impacts of security events will be more severe, and that others are more likely to be taking action to protect themselves. It was surprising that no significant difference in security self-efficacy was found, given previous research that suggests that females have less technical information technology knowledge and training (Sheng et al. 2010) and that female students have lower levels of computer self-efficacy (He and Freeman 2009). This was explored further in testing H3.

Table 4 summarises participants' self-rated skill with information technology and their previous security training. Differences between genders were analysed using chi-square tests. The majority of participants rated their skill with computers as good or excellent (64.7%), however only 18.9% had previously received any information security training. There were significant differences between females and males in both self-rated skill with information technology ( $\chi^2(4, N=624) = 15.510$ ;  $p = 0.004$ ), and whether they had previously received information security training ( $\chi^2(1, N=624) = 11.061$ ;  $p = 0.001$ ). That is, females were less likely to have received information security training in the past and considered themselves to have lower levels of skill with information technology. Therefore H3 was supported.

	Females	Males
Self-rated skill with information technology		
Poor	0.5%	0.9%
Below average	3.8%	1.9%
Average	35.1%	26.5%
Good	45.6%	44.9%
Excellent	14.9%	26.1%
Previous information security training		
Yes	14.9%	25.6%
No	85.1%	74.4%

Table 4. Skill with information technology and previous information security training comparison

## 6 Discussion

This study investigated gender differences in a range of personal information security behaviours as well as potential contributors to security behaviour. As hypothesised, gender differences in security behaviour were found, with males exhibiting stronger behaviour overall. This is consistent with previous research (Gratian et al. 2018; Sheng et al. 2010). Males did not, however, consistently protect themselves better across all of the individual security behaviours considered. The three behaviours where no gender difference was found were: enabling automatic updating of software, securing devices with passwords, and using security software (once installed). These behaviours require less technical skill than those where differences were found: installing security software, enabling firewalls and keeping regular backups, supporting Sheng et al.'s (2010) suggestion that gender effects on security behaviour are mediated by technical knowledge and training, as our results also show that females report lower levels of information technology skill and information security training.

Gender differences were found for some security perceptions but not others. It is interesting that female users believed that the effects of a security threat would be worse for them than males users did, but did not feel more vulnerable, despite believing themselves to have less information technology skill. The higher levels of perceived severity are consistent with females having higher levels of information privacy concerns (Hoy and Milne 2010; Laric et al. 2009; Mohamed and Ahmad 2012), but the lack of

difference in terms of perceived vulnerability is not. However, in research on security perceptions Sasse et al. (2001) found that users tend not to consider their information to be of value to others and therefore view it as not important enough to be targeted. Therefore, while female users appear to perceive the outcomes of a security event as being worse they do not view themselves as more likely to be attacked, perhaps devaluing the worth of their information.

It was surprising to find that there were no significant differences in perceptions of security self-efficacy between female and male users despite the lower levels of information technology skill and security training that female users reported. This finding is inconsistent with early research that showed differences in computer self-efficacy for complex tasks, but not simple ones (Busch 1995) and requires further research.

In terms of general computer attitudes, females have been shown to be driven more by social norms than males (Venkatesh and Morris 2000). Both descriptive norm and subjective norm were considered in the current study and females were found to have higher levels of descriptive norm, but not subjective norm. That is, females were more likely to believe that other people actively protect their own information security, but their perceptions as to whether other people want them to take security measures did not differ from those of males. Descriptive norm has been shown to be a more important predictor of security behaviour than subjective norm in the personal information technology context (Thompson et al. 2017), therefore gender differences in this are likely to contribute to the differences in security behaviour that were observed.

The differences in levels of factors that may influence security behaviour and perceptions identified in this study have implications for how security education, training, and awareness initiatives are designed and conducted, and suggest that knowledge and training differences should be targeted. However, the fact that female levels of the coping appraisal factors of security self-efficacy, response efficacy and response cost were not significantly lower than those of males suggests that there is not a need for gender specific campaigns targeting these factors. The gender differences in security behaviour do not appear to arise from them.

A limitation of this study is that it only involved US participants. Cyr et al. (2017) found that psychological gender (i.e. values such as masculinity or femininity) plays a more important role in website perceptions than biological gender, therefore as different cultures show differences in masculinity/femininity (Hofstede 1983) the potential role of this dimension of national culture in information security behaviour should be considered in future research that builds on the work of Rocha Flores et al. (2014) in the organisational security context.

Future research should also further explore the differences that have been observed in this study, and why they arise. One avenue to consider is that of personality. In a study on organisational information security behaviour, McCormac et al. (2017) found that gender differences in information security awareness disappeared when the personality traits of conscientiousness and agreeableness were taken into account.

## 7 Conclusion

In this work, we analysed the influence of gender on security behaviours and perceptions in a home computing environment. We have addressed the scarcity of research on gender differences in information security by reporting the first large scale study home users, considering both a range of personal information security behaviours as well as how gender differences may impact determinants of security behaviour. We collected data from a broad range of respondents, and were not limited to a particular subset (e.g. students). Our findings reveal significant differences between males and females for three of the six individual security behaviours, and that overall levels of security behaviour were significantly lower for females than for males. In terms of security perceptions, we found that females were also more likely to perceive a higher level of severity of security threats than males, but perceived their vulnerability to be lower – possibly contributing to the lower overall security behaviour observed. Finally, gender differences were found in social norms with females being more likely to believe that other people implement security measures, although they did not differ in perceptions of whether other people may want them to undertake security measures.

These findings contribute to the behavioural information security field by considering a key individual difference – gender – in the context of security behaviours and perceptions. The results may be of particular relevance when designing security education, training, and awareness initiatives for the broader community as these are often based on models such as PMT (Rogers 1975; Rogers 1983). We

believe that the efficacy of technical and behavioural security countermeasures may be positively influenced by developing them with these individual differences in mind.

## 8 References

- Alshammari, N.O., Mylonas, A., Sedky, M., Champion, J., and Bauer, C. 2015. "Exploring the Adoption of Physical Security Controls in Smartphones," in: *Proceedings of the International Conference on Human Aspects of Information Security, Privacy, and Trust*. Switzerland: Springer International Publishing, pp. 287-298.
- Anderson, C.L., and Agarwal, R. 2010. "Practicing Safe Computing: A Multimethod Empirical Examination of Home Computer User Security Behavioural Intentions," *MIS Quarterly* (34:3), pp 613-643.
- Boss, S.R., Galletta, D.F., Lowry, P.B., Moody, G.D., and Polak, P. 2015. "What do Systems Users have to Fear? Using Fear Appeals to Engender Threats and Fear that Motivate Protective Security Behaviors," *MIS Quarterly* (39:4), pp 837-864.
- Broos, A. 2005. "Gender and Information and Communication Technologies (ICT) Anxiety: Male Self-Assurance and Female Hesitation," *CyberPsychology & Behavior* (8:1), pp 21-31.
- Busch, T. 1995. "Gender Differences in Self-Efficacy and Attitudes toward Computers," *Journal of Educational Computing Research* (12:2), pp 147-158.
- Cai, Z., Fan, X., and Du, J. 2017. "Gender and Attitudes toward Technology Use: A Meta-Analysis," *Computers & Education* (105), pp 1-13.
- Chen, Y., and Zahedi, F.M. 2016. "Individuals' Internet Security Perceptions and Behaviors: Polycontextual Contrasts between the United States and China.," *MIS Quarterly* (40:1), pp 205-222.
- Chua, S.L., Chen, D.-T., and Wong, A.F.L. 1999. "Computer Anxiety and Its Correlates: A Meta-Analysis," *Computers in Human Behavior* (15:5), pp 609-623.
- Cyr, D., Gefen, D., and Walczuch, R. 2017. "Exploring the Relative Impact of Biological Sex and Masculinity–Femininity Values on Information Technology Use," *Behaviour & Information Technology* (36:2), pp 178-193.
- Garbarino, E., and Strahilevitz, M. 2004. "Gender Differences in the Perceived Risk of Buying Online and the Effects of Receiving a Site Recommendation," *Journal of Business Research* (57:7), pp 768-775.
- Gefen, D., and Straub, D.W. 1997. "Gender Differences in the Perception and Use of E-Mail: An Extension to the Technology Acceptance Model," *MIS Quarterly* (21:4), pp 389-400.
- Gratian, M., Bandi, S., Cukier, M., Dykstra, J., and Ginther, A. 2018. "Correlating Human Traits and Cyber Security Behavior Intentions," *Computers & Security* (73), pp 345-358.
- He, J., and Freeman, L. 2009. "Are Men More Technology-Oriented Than Women? The Role of Gender on the Development of General Computer Self-Efficacy of College Students," in: *Proceedings of the Americas Conference on Information Systems (AMCIS)*.
- Herath, T., and Rao, H.R. 2009. "Encouraging Information Security Behaviors in Organizations: Role of Penalties, Pressures and Perceived Effectiveness," *Decision Support Systems* (47:2), pp 154-165.
- Hofstede, G. 1983. "National Cultures in Four Dimensions: A Research-Based Theory of Cultural Differences among Nations," *International Studies of Management & Organization* (13:1-2), pp 46-74.
- Hoy, M.G., and Milne, G. 2010. "Gender Differences in Privacy-Related Measures for Young Adult Facebook Users," *Journal of Interactive Advertising* (10:2), pp 28-45.
- Ifinedo, P. 2012. "Understanding Information Systems Security Policy Compliance: An Integration of the Theory of Planned Behavior and the Protection Motivation Theory," *Computers & Security* (31:1), pp 83-95.
- Jagatic, T.N., Johnson, N.A., Jakobsson, M., and Menczer, F. 2007. "Social Phishing," *Communications of the ACM* (50:10), pp 94-100.

- Laric, M.V., Pitta, D.A., and Katsanis, L.P. 2009. "Consumer Concerns for Healthcare Information Privacy: A Comparison of US and Canadian Perspectives," *Research in Healthcare Financial Management* (12:1), pp 93–111.
- Liang, H., and Xue, Y. 2010. "Understanding Security Behaviors in Personal Computer Usage: A Threat Avoidance Perspective," *Journal of the Association for Information Systems* (11:7), pp 394-413.
- Luciano, E.M., Mahmood, M.A., and Maçada, A.C.G. 2010. "The Influence of Human Factors on Vulnerability to Information Security Breaches.," in: *Proceedings of the Americas Conference on Information Systems (AMCIS)*.
- Mamonov, S., and Benbunan-Fich, R. 2018. "The Impact of Information Security Threat Awareness on Privacy-Protective Behaviors," *Computers in Human Behavior* (83), pp 32-44.
- McCormac, A., Zwaans, T., Parsons, K., Calic, D., Butavicius, M., and Pattinson, M. 2017. "Individual Differences and Information Security Awareness," *Computers in Human Behavior* (69), pp 151-156.
- Milne, G.R., Labrecque, L.I., and Cromer, C. 2009. "Toward an Understanding of the Online Consumer's Risky Behavior and Protection Practices," *Journal of Consumer Affairs* (43:3), pp 449–473.
- Mohamed, N., and Ahmad, I.H. 2012. "Information Privacy Concerns, Antecedents and Privacy Measure Use in Social Networking Sites: Evidence from Malaysia," *Computers in Human Behavior* (28:6), pp 2366-2375.
- Mwagwabi, F., McGill, T., and Dixon, M. 2018. "Short-Term and Long-Term Effects of Fear Appeals in Improving Compliance with Password Guidelines," *Communications of the Association for Information Systems* (41:1), pp Article 7 (147-182).
- Nunnally, J.C. 1978. *Psychometric Theory*, (2nd ed.). New York: McGraw-Hill.
- Ong, C.-S., and Lai, J.-Y. 2006. "Gender Differences in Perceptions and Relationships among Dominants of E-Learning Acceptance," *Computers in Human Behavior* (22:5), pp 816-829.
- Pattinson, M., Butavicius, M., Parsons, K., McCormac, A., and Calic, D. 2015. "Factors that Influence Information Security Behavior: An Australian Web-Based Study," in: *Proceedings of the International Conference on Human Aspects of Information Security, Privacy, and Trust*. Cham: Springer, pp. 231-241.
- Ponemon Institute. 2013. "Cost of Data Breach Study: Global Analysis." <https://www.ponemon.org/local/upload/file/2013%20Report%20GLOBAL%20CODB%20FINAL%205-2.pdf> Retrieved 12 October, 2018.
- Puhakainen, P., and Siponen, M. 2010. "Improving Employees' Compliance through Information Systems Security Training: An Action Research Study," *MIS Quarterly* (34:4), pp 757-778.
- Rajivan, P., Moriano, P., Kelley, T., and Camp, L.J. 2017. "Factors in an End User Security Expertise Instrument," *Information & Computer Security* (25:2), pp 190-205.
- Rocha Flores, W., Antonsen, E., and Ekstedt, M. 2014. "Information Security Knowledge Sharing in Organizations: Investigating the Effect of Behavioral Information Security Governance and National Culture," *Computers & Security* (43), pp 90-110.
- Rogers, R.W. 1975. "A Protection Motivation Theory of Fear Appeals and Attitude Change," *Journal of Psychology* (91:1), pp 93-114.
- Rogers, R.W. 1983. "Cognitive and Physiological Processes in Fear Appeals and Attitude Change: A Revised Theory of Protection Motivation," in: *Social Psychophysiology*, J.T. Cacioppo and R.E. Petty (eds.). New York: Guilford Press, pp. 153-176.
- Sasse, M., Brostoff, S., and Weirich, D. 2001. "Transforming the 'Weakest Link'—a Human/Computer Interaction Approach to Usable and Effective Security," *BT Technology Journal* (19:3), pp 122-131.
- Sheng, S., Holbrook, M., Kumaraguru, P., Cranor, L.F., and Downs, J. 2010. "Who Falls for Phish?: A Demographic Analysis of Phishing Susceptibility and Effectiveness of Interventions. ," in: *Proceedings of the Sigchi Conference on Human Factors in Computing Systems*. ACM, pp. 372-382.

- Siponen, M., Mahmood, A., and Pahnla, S. 2014. "Employees' Adherence to Information Security Policies: An Exploratory Field Study," *Information & Management* (51:2), pp 217-224.
- Sommestad, T., Karlzén, H., and Hallberg, J. 2015. "A Meta-Analysis of Studies on Protection Motivation Theory and Information Security Behaviour," *International Journal of Information Security and Privacy* (9:1), pp 26-46.
- Taylor, S., and Todd, P.A. 1995. "Understanding Information Technology Usage: A Test of Competing Models," *Information Systems Research* (6:2), pp 144-176.
- Thompson, N., McGill, T.J., and Wang, X. 2017. "'Security Begins at Home': Determinants of Home Computer and Mobile Device Security Behavior," *Computers & Security* (70), pp 376-391.
- Tsai, H.-y.S., Jiang, M., Alhabash, S., LaRose, R., Rifon, N.J., and Cotten, S.R. 2016. "Understanding Online Safety Behaviors: A Protection Motivation Theory Perspective," *Computers & Security* (59), pp 138-150.
- Venkatesh, V., and Morris, M.G. 2000. "Why Don't Men Ever Stop to Ask for Directions? Gender, Social Influence, and Their Role in Technology Acceptance and Usage Behavior," *MIS Quarterly* (24:1), pp 115-139.
- Williams, S.W., Ogletree, S.M., Woodburn, W., and Raffeld, P. 1993. "Gender Roles, Computer Attitudes, and Dyadic Computer Interaction Performance in College Students," *Sex Roles* (29:7-8), pp 515-525.
- Woon, I., Tan, G., and Low, R. 2005. "A Protection Motivation Theory Approach to Home Wireless Security," in: *Proceedings of the Twenty-Sixth International Conference on Information Systems*. Las Vegas: pp. 367-380.
- Workman, M., Bommer, W.H., and Straub, D. 2008. "Security Lapses and the Omission of Information Security Measures: A Threat Control Model and Empirical Test," *Computers in Human Behavior* (24:6), pp 2799-2816.

## Appendix

Construct	Items
Perceived severity (Ifinedo 2012; Woon et al. 2005; Workman et al. 2008)	<p>A security breach on my <i>device</i> would be a serious problem for me</p> <p>Loss of information resulting from hacking would be a serious problem for me</p> <p>Having my confidential information on my <i>device</i> accessed by someone without my consent or knowledge would be a serious problem for me.</p> <p>Having someone successfully attack and damage my <i>device</i> would be very problematic for me</p> <p>I view information security attacks on me as harmful</p> <p>I believe that protecting the information on my <i>device</i> is important</p>
Perceived vulnerability (Ifinedo 2012; Siponen et al. 2014; Woon et al. 2005)	<p>I could be subject to a serious information security threat</p> <p>I am facing more and more information security threats</p> <p>I feel that my <i>device</i> could be vulnerable to a security threat</p> <p>It is likely that my <i>device</i> will be compromised in the future</p> <p>My information and data is vulnerable to security breaches:</p> <p>I could fall victim to a malicious attack if I fail to follow good security practices</p>
Response cost (Woon et al. 2005; Workman et al. 2008)	<p>Taking security measures inconveniences me</p> <p>There are too many overheads associated with taking security measures to protect my <i>device</i></p> <p>Taking security measures would require considerable investment of effort</p> <p>Implementing security measures on my <i>device</i> would be time consuming</p> <p>The cost of implementing recommended security measures exceeds the benefits</p> <p>The impact of security measures on my productivity exceeds the benefits</p>

---

Response efficacy (Woon et al. 2005)	Enabling security measures on my <i>device</i> will prevent security breaches Implementing security measures on my <i>device</i> is an effective way to prevent hackers Enabling security measures on my <i>device</i> will prevent hackers from stealing my identity The preventative measures available to stop people from getting confidential personal or financial information on my <i>device</i> are effective
Self-efficacy (Anderson and Agarwal 2010)	I feel comfortable taking measures to secure my <i>device</i> Taking the necessary security measures is entirely under my control I have the resources and the knowledge to take the necessary security measures Taking the necessary security measures is easy I can protect my <i>device</i> by myself I can enable security measures on my <i>device</i>
Subjective norm (Adapted from Taylor and Todd 1995)	Friends who influence my behavior think that I should take measures to secure my <i>device</i> Significant others who are important to me think that I should take measures to secure my primary <i>device</i> My peers think that I should take security measures on my primary <i>device</i>
Descriptive norm (Anderson and Agarwal 2010)	I believe other people implement security measures on their <i>devices</i> I believe the majority of people implement security measures on their <i>devices</i> to help protect the Internet I am convinced other people take security measures on their <i>devices</i> It is likely that the majority of home computer users take security measures to protect themselves from an attack by hackers

---

## Copyright

**Copyright:** © 2018 McGill and Thompson. This is an open-access article distributed under the terms of the [Creative Commons Attribution-NonCommercial 3.0 Australia License](https://creativecommons.org/licenses/by-nc/3.0/au/), which permits non-commercial use, distribution, and reproduction in any medium, provided the original author and ACIS are credited.

# Technology humanness, trust and e-government adoption

## Lemuria Carter

School of Information Systems & Technology Management  
University of New South Wales  
Sydney, New South Wales, Australia  
Email: Lemuria.Carter@unsw.edu.au

## Dapeng Liu

School of Business  
Virginia Commonwealth University  
VA, United States  
Email: liud22@vcu.edu

## Abstract

With regards to technology adoption, users may be influenced by trust in two forms – human-like trust (e.g., benevolence, integrity, and ability) and system-like trust (e.g., helpfulness, reliability, and functionality). While the literature interestingly differentiates the use of these two types of trust, insufficient efforts have been devoted to examine and explain which type of trust should be used in the context of e-government. Additionally, when government agencies increasingly experience security breaches, insufficient literature examines how human-like trust and system-like trust may be influenced by such important antecedents as security threats and citizens' security concerns in e-government settings. We propose a conceptual model to address this gap in the literature.

**Keywords:** e-government, human-like trust, technology-like trust, system adoption, security concerns

## 1 Introduction

Information systems (IS) studies have been manifesting increasingly individuals trust in information technologies. Extant literature shows users' trust can crucially influence their intention of technology adoption. A large portion of IS researchers conceptualized trust in technology as if the technology were a human, utilizing and measuring the human-like trust constructs of integrity, ability/competence, and benevolence (Lankton, McKnight, & Tripp, 2015). In contrast, other IS scholars use system-like trust constructs to measure trust, such as reliability, functionality, and helpfulness (McKnight, Carter, Thatcher, & Clay, 2011).

e-Government utilizes information and communication technology (ICT) to provide open and secure online services that can enhance the process of public service, administration and participation (Janowski, 2015). Trust beliefs are important in fostering e-government adoption. While IS literature interestingly differentiates the human-like trust and system-like trust (Lankton et al., 2015) and suggests that trust beliefs may not be invariant across various settings (e.g., cultures and contexts) (Jarvenpaa, Tractinsky, & Saarinen, 1999), insufficient studies exist to examine and explain which type of trust should be used in the settings of e-government service. Additionally, no e-government literature demonstrates how human-like trust and system-like trust are affected by such important antecedents as security threats and citizens' security concerns when government agencies are increasingly falling victims to cyber-attacks.

Given that current research is limited in its exploration of human-like trust and system-like trust in e-government settings, our study addresses this gap in the literature by exploring the following research question: how does human-like trust and system-like trust impact e-government service adoption? To explore this question, we present a conceptual model to examine human-like trust or system-like trust and their antecedents in e-government adoption. In particular, we adapt Lankton et al. (2015) to an e-government context. Given the potential impact of security concerns on trust in the digital environment, we extend the model to incorporate security breach concern. The proposed model provides a parsimonious approach to exploring the role of trust and security concerns in e-government.

## 2 Relevant Concepts and Theoretical Background

### 2.1 Trust – System-like Trust and Human-like Trust in Technology

Trusting in information technology proves to be reasonable —editors can trust office processing software to process text and web users can trust the Internet to transfer data (Lankton et al., 2015).

Interpersonal trust is often measured in three dimensions of human-like beliefs: integrity, competence, and benevolence (Lankton et al., 2015; McKnight, Choudhury, & Kacmar, 2002) (Figure 1). IS studies have used these human-like trust to study technology because people tend to ascribe human characteristics to information technology (Nowak & Rauh, 2005). Integrity is the belief that a trustee “adheres to an acceptable set of principles” (Lankton et al., 2015). Ability/competence is the belief that a trustee has the ability, skills or competencies to implement a task or to be influential in a specific domain. Benevolence is the belief that a trustee “wants to do good to the trustor aside” (Lankton et al., 2015). These human-like trust has been examined to be significantly influential towards system adoption (Lankton et al., 2015; Wang & Benbasat, 2005).

While human-like trust in technology assume that technology “have volition (the power to choose)”, other studies have developed alternative trust measurements that do not assume technologies have volition, such as utility, reliability, and predictiveness (Lippert & Swiercz, 2005) and reliability, functionality, and helpfulness (Lankton et al. (2015). This study will use Lankton et al. (2015)'s conceptualization of system-like trust in a technology (reliability, functionality, and helpfulness) for two-fold reasons: on the one hand, this study is a follow-up study of Lankton et al. (2015), empirical examining whether and how system-like trust and human-like trust differentially performs in e-government adoption; on the other hand, the attributes of system-like trust from Lankton et al. (2015) were conceptually congruent with those in human-like trust.

Human-like trust and system-like trust portray users' trust in e-service from two different perspectives. This differentiation applies in the practice of building e-government services which aims at providing enhanced system friendliness and accordingly increasing user satisfaction. In this sense, e-government services are increasingly subject to more humanness (or human-like characteristics). Social cognitive theories posit that people categorize subjects into humans, animals, or objects (Nowak & Rauh, 2005). While a technology has historically been categorized as an object (i.e., not human), IS/IT can “display certain human characteristics that make them seem quite human-like” (Cassell & Bickmore, 2000). We



are motivated to test how human-like trust performs versus system-like trust in the specific setting of e-government.

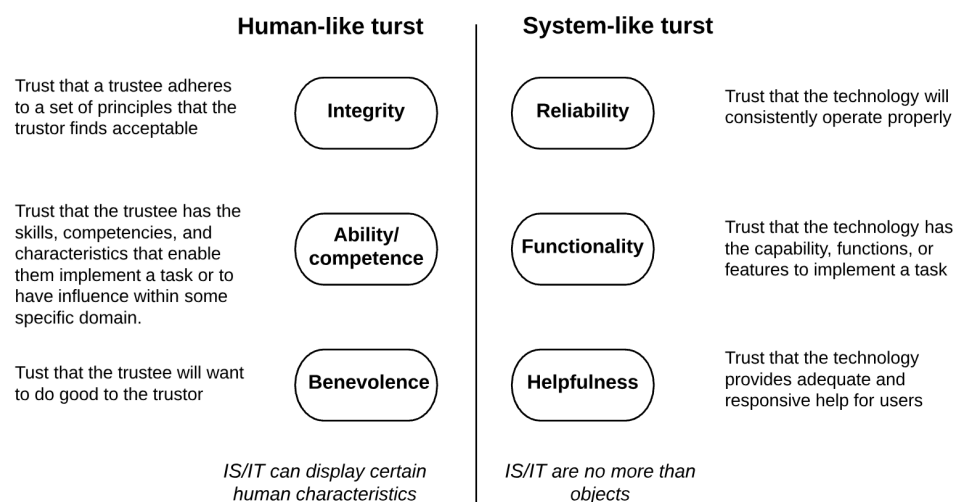

Figure 1. Trust in Technology Adapted from Lankton et al. (2015)

## 2.2 Security threats and concerns

Security in e-government settings is of crucial importance to citizens, businesses, and government agencies. Security breaches of e-government transactions and databases will harm citizens' confidential information (e.g., social security number, address, and password) and can result in identity theft (Featherman, Miyazaki, & Sprott, 2010).

In reality, security breaches are occurring at a growing rate. In recent years, government agencies continue to lose citizens' confidential information. In 2016, government agencies reported 30,899 data breach incidents, 16 of which are deemed as major incidents. For example, in the Internal Revenue Service (IRS) breach covering September 2016 to March 2017, approximately information of 100,000 taxpayer may have been compromised (Ng, 2017).

Among internet users' concerns, system security breaches ranked at the top (Miyazaki & Fernandez, 2001). System users report that security concerns adversely affect their behaviour towards adoption (Featherman et al., 2010). While an investigation of security concerns surrounding the adoption of e-government services is necessary, IS literature manifest limited efforts.

Acknowledging insufficient efforts have been devoted to the examination of security threats and security concerns in e-government setting, this study will fill this gap by examining their effects towards trust in terms of system-like trust and human-like trust.

## 3 Hypothesis Development

### 3.1 Security Threat, Security Breach Concern and Trust

In the IS context, system security threats can be visualized in terms of the individual assessment of the severity of potential security threats and the probability of exposure to substantial security threats (Herath & Rao, 2009, p. 111). According to the Protection Motivation Theory (PMT), security threats may arouse security concerns which can be defined as "the level to which an employee believes that her/his organizational information assets are threatened" (Herath & Rao, 2009, p. 111). In the e-government context, if citizens perceive that a security threat can impose notable damages or losses, they are more likely to be concerned. Conversely, if citizens do not perceive severe security threats, they will give no or less concern. In other words, security breach severity and probability arouse in system users the security concerns, potentially offsetting the trust in e-government and the convenience afforded to citizens.

**H1a** *Perceived Probability of Security Breach will negatively affect Human-like Trust*

**H1b** *Perceived Probability of Security Breach will negatively affect System-like Trust*

**H1c** *Perceived Probability of Security Breach will positively affect Security Breach Concern*

**H2a** *Severity of Security Breach will negatively affect Human-like Trust*

**H2b** *Severity of Security Breach will negatively affect System-like Trust*

**H2c** *Severity of Security Breach will positively affect Security Breach Concern*

Literature highlights that individual concerns are an essential influential antecedent factor of trust (Bansal & Gefen, 2010; Bansal, Zahedi, & Gefen, 2016; Van Slyke, Shim, Johnson, & Jiang, 2006). Security breaches subject citizens' confidential information to loss or theft and may severely harm them financially or socially (Mothersbaugh, Foxx, Beatty, & Wang, 2012) and raise security concerns. Security breach concern, considered as a personal belief, may lower trust towards the e-government. In other words, a high level of security breach concern is likely to be associated with a low-level trust in e-government service in terms of the human-like trust or system-like trust. Therefore, we posit that security breach concerns negatively impact trust.

**H3a** *Security Breach Concern will negatively affect Human-like Trust*

**H3b** *Security Breach Concern will negatively affect System-like Trust*

## 3.2 Trust and Dependent Variable

Trust holds a crucial stance in influencing individual perceptions and behaviours (Schurr & Ozanne, 1985), especially in an uncertain environment (Chellappa & Pavlou, 2002). Hence, trust is crucial in online relationships between individual and organization where there often exists asymmetrical information (Moody, Lowry, & Galletta, 2017), context (Graebner, 2009) and expectations (Hann, Hui, Lee, & Png, 2007), manifesting system success (Bélanger & Carter, 2008; Gefen, Karahanna, & Straub, 2003; McKnight et al., 2002; Pavlou & Gefen, 2004).

### 3.2.1 Trust and Perceived Usefulness

In the setting of e-government, perceived usefulness is an important indicator portraying how a person believes that using the e-government system will enhance his/her performance or outcome. It is a well-documented belief that the users will be more likely to successfully accomplish their tasks with the supporting e-service which can be trusted. Trust builds the e-service credibility in "providing what has been promised" (Gefen et al., 2003). Conversely, working with an e-service which is not credible and cannot be trusted often result in detrimental consequences. E-government research also manifests trust being influential towards perceived usefulness (Horst, Kuttschreuter, & Gutteling, 2007). Therefore, we hypothesize trusting beliefs (human-like and system-like) into e-government would benefit citizens' perception of usefulness.

**H4a** *Human-like trust will positively affect perceived usefulness.*

**H4b** *System-like trust will positively affect perceived usefulness.*

### 3.2.2 Trust and Enjoyment

Enjoyment can be defined as the degree to which performing an activity is perceived as providing pleasure and joy in its own right, other than perceived performance consequences (e.g. perceived usefulness) (Igarria, Schiffman, & Wieckowski, 1994). In the context of IS, enjoyment is often measured by the perceived fun pleasure of using a system or online service (Lankton et al., 2015). While enjoyment is a behavioral belief that represents pleasure-relevant motivation for e-government use, trusting beliefs may impact enjoyment in the way that the more individuals trust a technology and perceive that e-government has trustable features that may reduce uncertainty, the more they will feel comfortable (and, thus, enjoy) using e-government services. Literature has examined the relationship between trust and enjoyment and found that both human-like trusting beliefs and system-like trust significantly influence enjoyment in online payment systems (Lankton et al., 2015). Therefore, we synthesize that:

**H5a** *Human-like trust will positively affect Enjoyment.*

**H5b** *System-like trust will positively affect Enjoyment.*

### 3.2.3 Trust and Trusting Intention

Trusting beliefs are object-specific beliefs about characteristics of IT/IS system or relevant entities (Wixom & Todd, 2005). Trusting intention depicts an object-oriented attitude which results from trusting belief in these technology characteristics and reflects users' evaluative response to these characteristics (Benamati, Fuller, Serva, & Baroudi, 2010). In e-government setting, trusting beliefs should influence trusting intention because citizens who have high trusting beliefs will perceive that the trustee (e.g., e-government service) has desirable characteristics that enable trusters (e.g., citizens) to depend on it. Previous literature demonstrated that trust beliefs have significant influences on trust intentions (McKnight et al., 2002). Especially, researchers have found a relationship between both human-like (Benamati et al., 2010; Lankton et al., 2015) and system-like (Lankton et al., 2015) trusting beliefs and trusting intention.

**H6a** *Human-like trust will positively affect Trusting Intention.*

**H6b** System-like trust will positively affect Trusting Intention.

### 3.2.4 Trust and Continuance Intention

Trust strongly impacts technology adoption (Warkentin, Gefen, Pavlou, & Rose, 2002). Especially, citizens' trust in the government agencies' capability of providing secure e-services is vitally important for e-government adoption (Carter, Weerakkody, Phillips, & Dwivedi, 2016). Existent literature provides accumulated empirical evidences that trust in technology foster acceptance or continued acceptance of various technologies such as online banking service (Lin, 2011), supply chain information systems (Lippert, 2007), recommender system (Wang & Benbasat, 2005), e-commerce (Corbitt, Thanasankit, & Yi, 2003), and e-government services (Bélanger & Carter, 2008; Carter et al., 2016). More specifically, as trust in the form of human-like trust and system-like trust, portray user's wholistic belief in e-government service, we hypothesize that:

**H7a** Human-like trust will positively affect Continuance Intention.

**H7b** System-like trust will positively affect Continuance Intention.

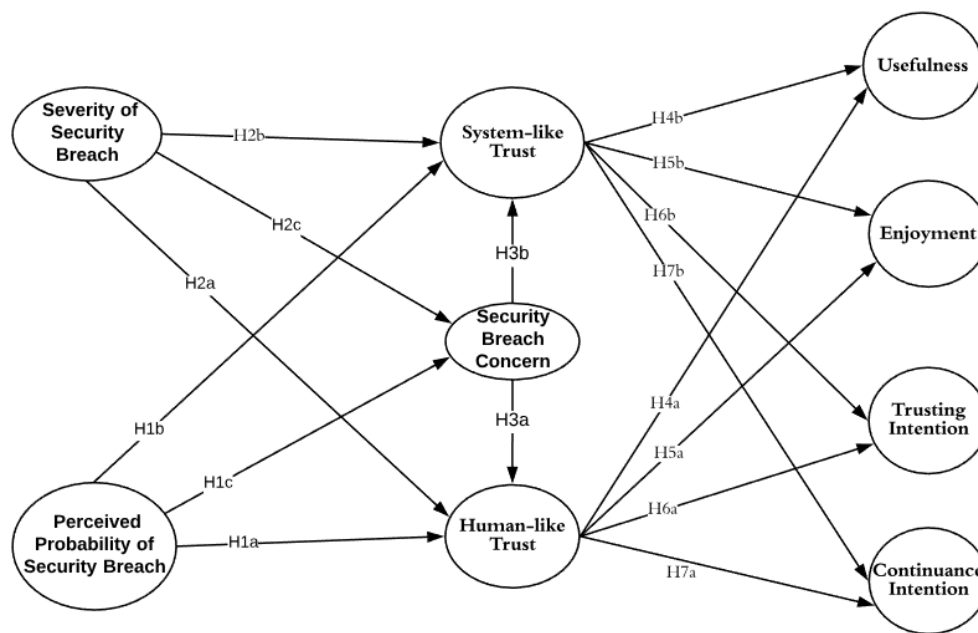

Figure 2. Conceptual Model

## 4 Research Model Conceptualization

Based on the aforementioned analysis, this research proposes the model (in Fig. 2). Seven groups of hypotheses derived from the model are summarized as H1-H7 mentioned above. As is shown in the research model in Figure 2, this conceptualization investigates the roles of security threat (severity of security breach and perceived probability of security breach), security concerns, and trust (system-like and human like) that leads to dependent variable of interest in e-government adoption.

## 5 Methodology

To test the proposed research model, we will administer a survey to e-government users in the United States. Empirically testing the proposed research model, which highlights security concerns, trust (system-like trust and human-like trust) and dependent variable listed in Lankton et al. (2015), will address an existing gap in the literature. The instruments to be used are listed in Table 1. All of the questions in the instruments are validated and tested questions in the cited studies, the use of which will reduce the problems with the reliability and validity of results (Straub, 1989). Each item in the instrument involved a 7-point Likert scale which indicate how a respondent agree with the statements.

Construct	Definition	Source
Severity of Security Breach	Seriousness or severity of breach events/incidents in e-government use	Herath and Rao (2009)

Perceived Probability of Security Breach	Perceived vulnerability, in terms of probability, to the threat of breach events/incidents in e-government use	Herath and Rao (2009)
Security Breach Concern	Concern over the e-government breach threat and the coping response efficacy	Herath and Rao (2009)
System-like Trust	System-like trusting beliefs regarding system integrity, ability and benevolence	Lankton et al. (2015)
Human-like Trust	Human-like trusting beliefs regarding system reliability, functionality and helpfulness	Lankton et al. (2015)
Usefulness	Perceived usefulness of e-government services regarding the performance, productivity and effectiveness etc.	Lankton et al. (2015); (Davis, 1989)
Enjoyment	Perceived enjoyment when using e-government services	Davis, Bagozzi, and Warshaw (1992); Lankton et al. (2015)
Trusting intention	Individual trusting intentions on e-government services-willingness to depend on e-government	Lankton et al. (2015); McKnight et al. (2002)
Continuance intention	Intended continued use of a system, which, in turn, will determine actual adoption of e-government services	Lankton et al. (2015);

Control variable: disposition to trust technology, experience, age and gender

Table 1. Constructs and Definitions

## 6 Discussion

In this paper, we utilize Lankton et al. (2015)'s model of trust to explore the role of human-like and system-like trust on e-government adoption. Given the potential impact of security concerns on trust in the digital environment, we extend the model to incorporate security breach concern. The proposed model provides a parsimonious approach to exploring the role of trust and security concerns in e-government. Implications for research and practice will be discussed at the conference.

## 7 References

- Bansal, G., & Gefen, D. (2010). The impact of personal dispositions on information sensitivity, privacy concern and trust in disclosing health information online. *Decision Support Systems*, 49(2), 138-150.
- Bansal, G., Zahedi, F. M., & Gefen, D. (2016). Do context and personality matter? Trust and privacy concerns in disclosing private information online. *Information & Management*, 53(1), 1-21.
- Bélanger, F., & Carter, L. (2008). Trust and risk in e-government adoption. *The Journal of Strategic Information Systems*, 17(2), 165-176.
- Benamati, J., Fuller, M. A., Serva, M. A., & Baroudi, J. (2010). Clarifying the Integration of Trust and TAM in E-Commerce Environments: Implications for Systems Design and Management. *IEEE Transactions on Engineering Management*, 57(3), 380-393.
- Carter, L., Weerakkody, V., Phillips, B., & Dwivedi, Y. K. (2016). Citizen adoption of e-government Services: Exploring citizen perceptions of online services in the United States and United Kingdom. *Information Systems Management*, 33(2), 124-140.
- Cassell, J., & Bickmore, T. (2000). External manifestations of trustworthiness in the interface. *Communications of the ACM*, 43(12), 50-56.
- Chellappa, R. K., & Pavlou, P. A. (2002). Perceived information security, financial liability and consumer trust in electronic commerce transactions. *Logistics Information Management*, 15(5/6), 358-368.
- Corbitt, B. J., Thanasankit, T., & Yi, H. (2003). Trust and e-commerce: a study of consumer perceptions. *Electronic Commerce Research and Applications*, 2(3), 203-215.
- Davis, F. D. (1989). Perceived usefulness, perceived ease of use, and user acceptance of information technology. *MIS Quarterly*, 13(3), 319-340.
- Davis, F. D., Bagozzi, R. P., & Warshaw, P. R. (1992). Extrinsic and intrinsic motivation to use computers in the workplace 1. *Journal of Applied Social Psychology*, 22(14), 1111-1132.
- Featherman, M. S., Miyazaki, A. D., & Sprott, D. E. (2010). Reducing online privacy risk to facilitate e-service adoption: the influence of perceived ease of use and corporate credibility. *Journal of Services Marketing*, 24(3), 219-229.

- Gefen, D., Karahanna, E., & Straub, D. W. (2003). Trust and TAM in online shopping: An integrated model. *MIS Quarterly*, 27(1), 51-90.
- Graebner, M. E. (2009). Caveat venditor: Trust asymmetries in acquisitions of entrepreneurial firms. *Academy of Management Journal*, 52(3), 435-472.
- Hann, I.-H., Hui, K.-L., Lee, S.-Y. T., & Png, I. P. (2007). Overcoming online information privacy concerns: An information-processing theory approach. *Journal of Management Information Systems*, 24(2), 13-42.
- Herath, T., & Rao, H. R. (2009). Protection motivation and deterrence: a framework for security policy compliance in organisations. *European Journal of Information Systems*, 18(2), 106-125.
- Horst, M., Kuttschreuter, M., & Gutteling, J. M. (2007). Perceived usefulness, personal experiences, risk perception and trust as determinants of adoption of e-government services in The Netherlands. *Computers in Human Behavior*, 23(4), 1838-1852.
- Igbaria, M., Schiffman, S. J., & Wieckowski, T. J. (1994). The respective roles of perceived usefulness and perceived fun in the acceptance of microcomputer technology. *Behaviour & Information Technology*, 13(6), 349-361.
- Janowski, T. (2015). Digital government evolution: From transformation to contextualization. *Government Information Quarterly*.
- Jarvenpaa, S. L., Tractinsky, N., & Saarinen, L. (1999). Consumer trust in an Internet store: A cross-cultural validation. *Journal of Computer-Mediated Communication*, 5(2), JCMC526.
- Lankton, N. K., McKnight, D. H., & Tripp, J. (2015). Technology, humanness, and trust: Rethinking trust in technology. *Journal of the Association for Information Systems*, 16(10), 880-918.
- Lin, H. F. (2011). An empirical investigation of mobile banking adoption: The effect of innovation attributes and knowledge-based trust. *International Journal of Information Management*, 31(3), 252-260.
- Lippert, S. K. (2007). Investigating postadoption utilization: an examination into the role of interorganizational and technology trust. *IEEE Transactions on Engineering Management*, 54(3), 468-483.
- Lippert, S. K., & Swiercz, P. (2005). Human resource information systems (HRIS) and technology trust. *Journal of Information Science*, 31(5), 340-353.
- McKnight, D. H., Carter, M., Thatcher, J. B., & Clay, P. F. (2011). Trust in a specific technology: An investigation of its components and measures. *ACM Transactions on Management Information Systems (TMIS)*, 2(2), 12.
- McKnight, D. H., Choudhury, V., & Kacmar, C. (2002). Developing and validating trust measures for e-commerce: An integrative typology. *Information Systems Research*, 13(3), 334-359.
- Miyazaki, A. D., & Fernandez, A. (2001). Consumer perceptions of privacy and security risks for online shopping. *Journal of Consumer Affairs*, 35(1), 27-44.
- Moody, G. D., Lowry, P. B., & Galletta, D. F. (2017). It's complicated: explaining the relationship between trust, distrust, and ambivalence in online transaction relationships using polynomial regression analysis and response surface analysis. *European Journal of Information Systems*, 26(4), 379-413.
- Mothersbaugh, D. L., Foxx, W. K., Beatty, S. E., & Wang, S. (2012). Disclosure antecedents in an online service context: the role of sensitivity of information. *Journal of Service Research*, 15(1), 76-98.
- Ng, A. (2017). Hackers Use College Student Loans Tools to Steal \$30 million. Retrieved from <https://www.cnet.com/news/hackers-used-college-student-loans-tool-to-steal-30-million/>
- Nowak, K. L., & Rauh, C. (2005). The influence of the avatar on online perceptions of anthropomorphism, androgyny, credibility, homophily, and attraction. *Journal of Computer-Mediated Communication*, 11(1), 153-178.
- Pavlou, P. A., & Gefen, D. (2004). Building effective online marketplaces with institution-based trust. *Information Systems Research*, 15(1), 37-59.
- Schurr, P. H., & Ozanne, J. L. (1985). Influences on exchange processes: Buyers' preconceptions of a seller's trustworthiness and bargaining toughness. *Journal of Consumer Research*, 11(4), 939-953.
- Straub, D. W. (1989). Validating instruments in MIS research. *MIS Quarterly*, 147-169.
- Van Slyke, C., Shim, J., Johnson, R., & Jiang, J. J. (2006). Concern for information privacy and online consumer purchasing. *Journal of the Association for Information Systems*, 7(1), 415-444.
- Wang, W., & Benbasat, I. (2005). Trust in and adoption of online recommendation agents. *Journal of the Association for Information Systems*, 6(3), 72-101.
- Warkentin, M., Gefen, D., Pavlou, P. A., & Rose, G. M. (2002). Encouraging citizen adoption of e-government by building trust. *Electronic Markets*, 12(3), 157-162.
- Wixom, B. H., & Todd, P. A. (2005). A theoretical integration of user satisfaction and technology acceptance. *Information Systems Research*, 16(1), 85-102.

# Information Security Perceptions of Users, Levels of Engagement and Developer Resistance

**Dale Kleeman**

School of Information Technology and Systems  
University of Canberra  
Canberra, Australia  
Email: dale.kleeman@canberra.edu.au

## Abstract

This paper reports on a case study considering the propensity for a range of stakeholders to engage with information security issues during a major development project as part of a project considering the user involvement with the elicitation of information security requirements. Also examined were the attitudes of IT managers and project team members.

The research found that many users have an interest in being involved with information security issue, but their concerns meant they would need to be supported during any information security requirements gathering process. While business areas were interested in being involved, there was resistance from developers and this would require careful management. It was found that most users had a simplistic view of information security, largely limited to issues around access privileges.

**Keywords:** information security; user awareness, user participation, user requirements

## 1 Introduction

Information security research and literature has generally followed the views from practice where users are frequently seen as a weak link in the implementation of information security measures and their role in the overall information security system should be minimised if possible. This is evident in information systems security development approaches, both in the research literature and in practice, where users generally do not have a role in the security requirements elicitation process. This situation appears contrary to the more general information systems development literature where participative practices have become commonplace.

This study recognises the critical role that users can play in information security, and reports on a case study concerned with the implementation of an Electronic Document and Records Management System (EDRMS) in a public sector organisation. Issues concerned with user involvement in the elicitation of the information security requirements were explored using interview and document analysis.

The main research question with this work looking at the EDRMS case study was to consider the propensity and willingness for a range of stakeholders to engage with information security issues during a major development project. The case study also examined the attitudes of IT managers and project team members to user involvement in information security and the nature of these perspectives, particularly as they impacted on participatory practices in the development and specification of information security requirements. Users perception of information security and the impacts of information security measures on their work were also considered.

The motivations for this work stem from the patchy record of information security awareness and education programs and the desire to explore whether engagement with user area staff during development can have an impact on outcomes in this area through increased buy-in to the resultant security measures and improved understanding by all stakeholders of security requirements.

## 2 Background and review of the literature

The issue of user involvement in systems development activities has been an area of major interest in IS research since the early days of the discipline (Barki and Hartwick 1989; He and King 2008; Hirschheim 1983; Iivari et al. 2010; King and Cleland 1971). An aspect of this interest is a concern with high rates of project failure, with one of the dimensions of this failure being poor understanding of user requirements (often because of poor user participation practices), and the developed system (if completed) not being what was required by the user community. Deficiencies around requirements specification is now often claimed as the greatest single cause of failures of software projects (Hansen and Lyytinen 2010). This connection between some level of user participation and the elicitation of quality user requirements, or even more broadly, overall project success, has been the subject of IS research. As an example, Harris and Weistroffer (2009) surveyed much of the relevant literature in this area and use this to establish a strong connection between levels of user participation and project success. It is not the intent here to fully survey these issues, except to note that they are also relevant to the elicitation of information security requirements.

When considering the issue of user participation with information security issues within projects, and the potential for user-centric approaches, it is useful to look at user awareness of and involvement in information security. Most of the current references and texts deal with this mainly through the need for users to be aware of information security issues so that they can enforce the relevant countermeasures and detect various intrusions or breaches of security mechanisms. That is, they establish the key role of users as important participants in information security, rather than as designers of the security requirements. This is the main form of awareness promoted in some of the current texts such as Merkow and Breithaupt (2014); Whitman and Mattord (2017); and academic literature such as Safa et al (2016).

Rainer et al. (2007) also note that managerial issues are high on the list of issues that information security professionals need to be aware of. They point out the need for business managers and information security professionals to move more toward each other on the spectrum – where business managers need to become more aware of information security technical issues and information security professionals needing to become more aware of business management issues. Tracey (2007) makes a case for making security “the default thinking mode” in today’s organisations and suggests that this can be accomplished through “including security in business decision-making process” and using organisational procedures to enforce this with the emphasis being mainly concerned with

developing a security culture that will help to improve the effectiveness of the existing security measures.

Information security awareness and training has also been extensively explored with the view that outcomes for organisations are patchy, at best, with increasing numbers of breaches being reported, even in organisations with information security training and awareness programs in place (Mahfuth et al 2017; Alshaikh et al 2018). Alshaikh et al note that “this trend may indicate that many current security training and awareness programs are not as effective as they should be”.

Siponen and Vance (2010) discuss the issue of employee’s failure to comply with information security policies, and their application of neutralisation techniques as a means of rationalising this behaviour. The implication from this research is that user education needs to focus on the rationale underpinning the information security measures, so that the users are informed of: what the measures are that they need to comply with; how they work; and what they are meant to achieve with respect to the business processes that the users are engaged with.

DiGioia and Dourish (2005) note that “what ‘secure’ means at any given moment is a determination that only an end user can make” and that “attempts to make systems inherently secure, then, are problematic because they presuppose what ‘secure’ might be, taking that decision out of the users’ hands”.

This raises a question around the issue of user awareness of the security mechanisms operating in their environment. The transparency questions that Dourish et al. 2004 were interested in related to users’ perceptions of security and how they know systems are secure enough for them and their work. It seems that they would be unable to answer that question if their awareness of security in their environment was low, and in these situations they would be relying heavily on the assurances given by the technical experts that adequate protection mechanisms had been put in place. In addition, Siponen and Vance (2010) would also suggest that they are less likely to comply with security measures in these circumstances.

This suggests, that for some users at least, there is a need to have a reasonable level of awareness about security mechanisms in their environment and, as a minimum, this is likely to be partly developed through appropriate consultation mechanisms. It could be argued that the more involved users are in establishing their security environment, the more aware they will become of these issues, and thus, more confident that the environment will be properly constituted to meet their needs in this area. This involvement should be more with the higher levels of security requirements along with regular feedback against performance measures, than at a detailed technical specification. To be involved at the technical levels would require significant technical skills that could only be gained through time consuming training activities and well beyond the level of effort most users would want to put into this activity.

Kleeman (2013) proposed a model for participation by stakeholders concerned with information security issues in systems development processes with the suggestion that this would positively impact on user awareness and ownership of information security control measures. The buy-in ensuing from this participation would then help to overcome many of the compliance issues identified by Siponen and Vance (2010).

### 3 Research approach

This paper reports on case study work involving a project for the implementation of an EDRMS in a local public sector organisation with approximately 1000 employees. The project is referred to as the ‘E-records project’, and the system is called the ‘E-records’ system in this paper. The E-records project was considered from a case study perspective, where the processes around the implementation of the E-records system would be used as a vehicle to understand issues associated with user engagement with aspects of information security.

The case study was considered through a multifaceted approach, including:

- the collection and assessment of a range of documents relating to the project;
- the participation by the researcher in various project related activities, including steering committee meetings; and
- interviewing a series of people involved in the project, including project team members, IT managers, and representatives of a range of user areas.

Documents reviewed during the research effort with the E-records project included:



- documents relating to the initial funding and establishment of the project, including the business case and a statement of requirements;
- various tender preparation and evaluation documents
- steering committee progress reports;
- various outputs from the business analysis processes, including detailed analysis of the workflows around document processing and a range of 'workflow maps'.

The researcher also participated as a member of the Project Reference Group. This role on the Reference Group provided background to the project which enabled it to be seen as a suitable candidate for the research effort, and the selection of this project for the research effort was then discussed with the key players within the project before proceeding with the research activity. Staff consulted about this selection of the project included the head of IT Management, the project owner from within IT Management, and the Corporate Records Information Manager. After agreement had been reached around the selection of the project for the research effort, the ethics approval was received for the research project.

Interviews were conducted with a total of 18 staff members of the organisation. The interviews were conducted in a semi-structured manner with a range of concepts used to seed the conversation. Answers provided by the participants were then used to determine the direction and extent of the interview. After the collection of basic demographic data (gender, age range, nature of work position), the following themes were covered in most of the interviews:

- the extent of any general awareness of information security issues and knowledge of any relevant organisation policy and standards (such as AS4360 and the ISO27000 series);
- the extent to which participants had previously participated in specifying general functional requirements on ISD projects, and had previously participated in specifying information security requirements;
- an exploration around whether any information security measures have adversely interfered with the performance of any aspects of their work; and
- the desire and motivation to be involved in establishing information security requirements with future IT projects.

The interviews were recorded, transcribed and edited to provide the data for this analysis. They were then coded using a simple coding mechanism, with key issues from each interview tabulated and used for data analysis.

Interviewees have been identified with codes that represent the work area in which they were based. Staff from the ICT area were labelled ICT1-5; the finance department FN1-4; and the two other user areas AC1-4 and ST1-5.

## 4 Findings from the case study

This section describes the issues that have emerged from the analysis of the various documents and interview data. These issues have some interesting implications for information security practice in organisations. The major issues arising from the analysis that are reported on in this paper include:

- motivations of users to be involved with information security
- information security perceptions of users, and
- information security measures adversely interfering with the performance of work.

### 4.1 Motivations of users to be involved with information security

All of the interviews with staff from user areas produced useful comments on desire of users to be involved with information security issues during requirements gathering processes. It was clear from these comments that many users have an interest in being involved with information security issue, at least to some degree, but have significant limitations around time, and to a lesser extent, concerns about their expertise. This may mean that they would be happy to be involved to the extent of being consulted, but would be unlikely to want to commit significant amount of time to the process. Also, if the consultation processes had some formal structure to them – perhaps in the form of group workshops, with involvement driven by the more senior staff – then people would likely feel much more comfortable to be involved, in contrast to individual one on one involvement.

It was also clear from these comments that users would need to be adequately supported during any information security requirements gathering processes. If they were just asked 'what information

security measures do you want in your systems?' then it is unlikely they would be able to produce a comprehensive answer, or even feel confident that they were able to answer such questions. However, if there were supporting materials that outlined a range of measures (expressed at a relatively conceptual level) that were likely to be the kinds of information security controls relevant to a user context, then they would be much better placed to engage with this information security requirements gathering process.

Looking at other evidence around these issues, most interviews included questions about the desire and motivation of interviewees to be involved in establishing information security requirements with future IT projects and their willingness to be involved in workshops concerned with eliciting information security control requirements with the E-records system.

Interviewees provided a mix of responses when asked about their desires to be involved in establishing information security requirements with ten respondents expressing an interest or a strong desire to be involved, six respondents were not all that interested, one who was ambivalent about this, and one not responding to this question.

However, there was quite a different response to a question about whether the interviewees would be willing to participate in a one- to two-hour workshop facilitated by the researcher that would help with the eliciting of information security requirements around the implementation of the E-records system. With the 13 respondents from outside of the ICT department, only one said they were not interested in participating in these workshops and a few others expressed some concern about whether they knew enough in order for them to be able to make a useful contribution. Two other respondents expressed some reservations based on their time availability, but if the arrangements fitted in with their other priorities they were interested in being involved.

This indicates that there were some respondents who were not interested in being involved with specifying information security requirements, but were happy to participate in workshops that were mainly focussed on eliciting specific information security requirements. The interview data suggested this willingness to engage with the issues through the workshop process was a way of getting involved without being threatened, particularly around low levels of information security knowledge.

It was also quite clear that those with less desire and motivation to be involved with these issues were further down the hierarchy in the organisational structures. Those in more managerial positions, or those more connected with IT issues in their work generally, were more interested and motivated to be involved and saw the need for users to be involved with these issues.

There were a number of responses relating to the establishment of information security requirements that were of note:

- AC1, who had significant information security and project management experience, expressed strong views about the need to consult with user groups about a range of issues, including information security issues.
- AC4, who also had had some IT audit experience noted that 'security to me has always been just another requirement'.
- ST1, a manager from a business area, expressed a strong interest in issues around access controls and business continuity, and while he wanted to be involved in most of this, had low expectations that he could have a much influence over the business continuity of the E-records system. One of the comments he made was 'motivation stems from self-interest'.
- AC2 noted that she was probably not interested in being involved in establishing information security requirements but has 'sat there in awe at some of the decisions that have been made'.
- ICT5, a respondent from IT Management noted that he had significant previous involvement with establishing information security requirements with a range of IT systems and processes, but with respect to the E-records project, stated that 'I must admit I would probably be happy <not being involved> until I found that it prevented some functionality that I deemed necessary, or that it exposed me to a risk that wasn't acceptable'.
- ST2 noted that 'I liked being involved to the extent that I was, or am, but beyond that probably not' (due largely to workload and time factors). He subsequently talked about information security issues he was currently involved with around access to the student records system which suggested a much deeper level of interest.
- ST5, a lower level member of staff indicated that she was not all that interested in being involved, except with regard to some very specific issues. She gave the impression of being a bit overwhelmed by all of this.

- Some of the comments from the Finance area included FN1 saying: ‘Yes, I think everyone realises that they are important, but I am sure they all think, crikey, I hope someone else picks up the ball with this and runs with it and gets the process in place. I don’t think anybody here regards this as a trivial issue, but I suppose taking responsibility for it is another thing, but I think that has really been forced upon us now as a result of the audit findings, so it is something that we have to embrace’; and FN3 saying ‘Really, really keen to be involved’.

## 4.2 User engagement with information security and developer resistance

It was evident from the work in this case study that user areas were generally interested in engaging with information security issues, but it was apparent that they had been given few opportunities to do this prior to the interviews being conducted. Two of the user areas considered in the study had already been through the requirements-gathering phase of the project prior to this point, where the general user requirements had been discussed with representatives from these areas and system specification documents produced. Comments made by interviewees indicated that information security was not a topic in the requirements-gathering process and this was confirmed by members of the project team.

The E-records project team expressed the view that allowing the users some degree of control over the access privileges of documents that they had lodged in the E-records system would provide them with an opportunity to engage with the information security issues at a local level, and this meant that it was not necessary to comprehensively deal with this issue during the requirements-gathering phase. This view was also clear when the workflow maps from these areas were examined (these documents contained the detailed outputs of the business analysis processes in these two user areas). There was little in these documents about information security other than some basic comments about access controls and many of the interviews also indicated that there had only been superficial consultation with user areas around information security and access controls within the E-records project if at all.

It was therefore clear from these user requirements documents and the discussions with representatives from these user areas that ICT had made critical decisions around many of these matters without any significant user area involvement. Elements of this were also evident in the interviews with ICT1, ICT2 and ICT3 – key members of the E-records project team. Other informal discussions with the E-records project manager supported this view. The consultation that had occurred related mainly to the basic issues around access controls, essentially concerned with who would have access to what data items, with little, if any consideration given to the overall access control policy and the process issues with the administration and maintenance of access controls over time.

To illustrate this matter, there were a range of policy issues where user input could have provided some useful benefits. One example was within the E-records system where there were questions about whether access security policy should be set by the group or the individual. This question arose in a number of the interviews and it was evident in project discussions and documentation that the E-records project team had made a decision about this without any user consultation.

This example can be demonstrated by an analogy to an academic situation where access to teaching materials may be at issue. In this situation an individual academic may wish to restrict access to the teaching materials used in delivering a teaching unit, whereas the academic’s discipline group may have a view that all teaching materials should be made available to the other academics within the group. Views highlighting the relative importance of individual and group access were expressed during interviews with staff from a range of user areas.

This is likely to lead to a tension between the individuals’ desires and actions, and what is potentially desired by the group. Without any active discussion around this issue within user groups, it is quite likely that no group policy would be set (which appeared to be the outcome within the E-records project). This could lead to a situation where individuals end up with the control to do what they want, and more often than not, limiting access to records under their control. Retrieving this situation subsequently to a group policy setting could then prove problematic.

While having local control of access does allow users to engage with aspects of information security, there is no doubt that individual access control settings are only a small part of the information security picture, particularly around administration and maintenance of these settings. Most user areas would be quite unprepared to deal with these issues once the system came online, leaving many of these issues to surface through use. Some of these matters could prove quite problematic to deal with after the fact, with a likely consequence of leaving the system with poorer information security

controls than would be desirable, or possible if these issues had been tackled during the development phase.

While it would be difficult to quantify the return on these efforts, it is likely that the relatively small additional effort in engaging with the users on information security issues during the requirements gathering phase would have produced significantly better outcomes with the information security measures following implementation. This engagement could have been easily integrated with discussions about other functional requirements.

A further example arose in the E-records implementation that illustrates aspects of this issue, particularly around the developers' reluctance to engage with users. There was a difference between the attitudes of the organisation's records manager and that of IT services to information access policies. Implementation of these views, one way or another could have a significant impact on whether information security measures impacted on users and their ability to do their work (as discussed below).

The records manager was of the view that users should start with access to everything, unless there is a case made around the need to restrict things (in which case they would be denied access to these things), whereas the development team approach was to only give access to anything where there was a need – essentially, a least privilege approach to access controls.

There also appeared to be a difference between how the records manager and other members of the E-records project team found out about requirements in these areas. The records manager appeared to have a greater sensitivity to the user perspective, whereas the E-records project team members appeared to be applying principles about this matter from their experience and had not consulted with the records manager or other relevant users.

While differences such as these will invariably exist with most projects, there did not appear to be any structured process for resolving such differences. It was also apparent that the resolution of this problem, which was to implement the least privilege option, was likely to have been heavily driven by the opinions of the IT security function – a situation that often occurs when the lack of formal processes with these matters is evident.

These examples around the interactions between business analysts (and other members of the E-records project team) with users show a significant reluctance on their part to engage with users on eliciting information security requirements. The project manager also placed low value on outcomes from the proposed workshops intended to elicit information security requirements and is further confirmation of this developer resistance to user participative practices, particularly as they relate to information security.

Some of this resistance, particularly at the project manager level, could be attributed to the need to complete projects on time, and the perception that user participative practices are likely to have an impact in this area, however, it was also apparent that there were perceptions that users generally had little knowledge of information security and were unlikely to make much of a contribution to appropriate information security controls. It was also evident that there were entrenched practices in this area, possibly driven by a lack of information security knowledge by business analysts. Changing these practices in this area could be problematic and may require careful management.

### **4.3 General perceptions on information security**

In analysing and coding the interview data, consideration was given to how the various interviewees perceived the information security domain, and how they interpreted questions about information security.

It was clear that with almost all of the interviewees (from both user and IT areas), the immediate issues of concern when the topic of information security was raised was that of access controls, with a particular emphasis around who could have access to what data. Consideration of the broader aspects of access controls was rarely evident in the responses from any of those interviewed – this included the ongoing dynamics and administration around access controls (including process issues and the way in which access controls are implemented and modified). Within the information security domain, these issues are often seen as being as important as the initial decisions around who should have what level of access to the various data items.

Six of the interviewees broadened their view of information security to other areas, including data integrity and availability (the 'I' and the 'A' from the confidentiality, integrity and availability (CIA) model) when prompted by the interviewer. The emphasis here was mostly on the availability issue,

with a number of these interviewees directly impacted by an earlier incident when a critical system was unavailable for more than five days at a peak processing time, with this incident being referred to by some of the interviewees. This increased awareness is consistent with findings in the information security literature that one of the factors impacting on security awareness is experience with previous adverse events (for example, Smith and Jamieson 2006).

Only three of the interviewees demonstrated a very broad view of all of the elements of the CIA model without any prompting from the interviewer – these three interviewees included two senior staff from the IT area (ICT4 and ICT5) along with one user area respondent with a strong background in IT and information security (AC1).

On the whole, this did not mean that the majority of the interviewees were completely unaware of these other (non-access control related) issues, it was just that they did not automatically associate them with the information security domain, and potentially, in most cases, considered these other areas to be largely outside of the users areas sphere of influence, these being things that should mostly be left to the IT or information security experts.

It was clear from this discussion that users can have a simplistic view of information security despite the basic training on information security that most staff receive. While this is not surprising given their general lack of expertise with these matters, it can have an impact when business analysts are engaging with users around their requirements for information security. Supporting users with material that broadened these perceptions could prove helpful during an information security elicitation process.

#### **4.4 Information security measures adversely interfering with the performance of work**

Interviewees were also asked about whether any previous experience with information security measures had had adverse impacts with the performance of their work.

15 interviewees responded to questions on whether information security measures had interfered with their work in some ways and 12 of these interviewees noted a range of incidents where this was the case. In five of these interviews, the cases were relatively minor, with seven others noting significant incidents, with most of these being issues around access to data. It was also apparent that some information security measures were seen as an unnecessary hindrance and are sometimes only implemented because of external requirements and compliance factors.

With the other three interviewees who responded to this question, incidents of the opposite nature were noted. In these cases, the lack of security related measures had caused some issues with either their work or that of the organisations where they were located at the time. There was also some interest from some user area managers in improving elements of information security in order to allow for the implementation of a range of automated processes that had the potential to improve things, either for themselves or for the users of the services they provide. There did not appear to be any strong connection with the responses in this area and other facets of the data.

It is clear from the responses that there is a mixed view about aspects of information security with only a minimal association between the response and the role of the user in the organisation.

It is evident from this discussion that information security measures can impact on the performance of work, and this can sometimes create negative perceptions about such measures. There was also some evidence that those who had been involved in the implementation of information security measures had a more positive perception of such measures. While restrictive measures are necessary at times, engaging with users on their security requirements could be one way to raise awareness of these measures and help to counter negative perceptions about the impact of information security measures on the performance of work.

## **5 Conclusion**

This paper has described the E-records case study and the information security issues that have emerged from the analysis of the data that was collected. The major issues arising from the E-records case study help inform the considerations around end user involvement in the elicitation of information security requirements and include:

### *Motivations of users to be involved with information security*

Many users have an interest in being involved with information security issues, at least to some degree, but have significant limitations around time, and to a lesser extent, concerns about their expertise. It is likely they would be happy to be involved to the extent of being consulted, but would be unlikely to want to commit significant amount of time to the process. Users would also need to be adequately supported during any information security requirements gathering processes.

### *User engagement with information security during requirements gathering and developer resistance*

Business areas are generally interested in engaging with information security issues, but opportunities to do this could be compromised by the resistance from developers to such processes. The relatively small additional effort in engaging with the users on information security issues during the requirements gathering phase could produce significantly better outcomes with the information security measures following implementation; however, developer resistance to these processes could be problematic and may require careful management.

### *Information security perceptions of users*

Users generally had a fairly simplistic view of information security, which was largely limited to issues such as the allocation of access privileges. Supporting users with material that broadened these perceptions could prove helpful during an information security elicitation process.

### *Information security measures adversely interfering with the performance of work*

It was clear that information security measures can impact on the performance of work, and this can sometimes create negative perceptions about such measures. While restrictive measures are necessary at times, engaging with users on their security requirements could be one way to raise awareness of these measures and help to counter negative perceptions about the impact of information security measures on the performance of work.

This series of issues that have arisen from this case study work stand as interesting findings on aspects of information security, and also have implications for information security practice.

## **6 References**

- Alshaikh, M., Maynard, S. B., Ahmad, A., and Chang, S. 2018. "An Exploratory Study of Current Information Security Training and Awareness Practices in Organizations," *51st Hawaii International Conference on System Sciences (HICSS)*.
- Barki, H., and Hartwick, J. 1989. "Rethinking the Concept of User Involvement," *MIS Quarterly* (13:1), pp. 53-63.
- DiGioia, P., and Dourish, P. 2005. "Social Navigation as a Model for Usable Security," *2005 Symposium on usable privacy and security*, Pittsburgh, Pennsylvania: ACM Press, pp. 101-108.
- Dourish, P., Grinter, R. E., de la Flor, J. D., and Joseph, M. 2004. "Security in the Wild: User Strategies for Managing Security as an Everyday, Practical Problem," *Personal Ubiquitous Computing* (8:6), pp. 391-401.
- Hansen, S., and Lyytinen, K. 2010. "Challenges in Contemporary Requirements Practice," in: *43rd Hawaii International Conference on System Sciences (HICSS), 2010 IEEE*, pp. 1-11.
- Harris, M. A., and Weistroffer, H. R. 2009. "A New Look at the Relationship between User Involvement in Systems Development and System Success," *Communications of the Association for Information Systems* (24:42), pp. 739-756.
- He, J., and King, W. R. 2008. "The Role of User Participation in Information Systems Development: Implications from a Meta-Analysis," *Journal of Management Information Systems* (25:1), pp. 301-331.
- Hirschheim, R. A. 1983. "Assessing Participative Systems Design: Some Conclusions from an Exploratory Study," *Information & Management* (6:6), pp. 317-327.
- Iivari, J., Isomäki, H., and Pekkola, S. 2010. "The User – the Great Unknown of Systems Development: Reasons, Forms, Challenges, Experiences and Intellectual Contributions of User Involvement," *Information Systems Journal* (20:2), pp. 109-117.

- King, W. R., and Cleland, D. I. 1971. "Manager-Analyst Teamwork in MIS: Cooperation Vital in Systems Design," *Business Horizons* (14:2), pp. 59-68.
- Kleeman, D. 2013. "A Theoretical Model for Participation by Stakeholders Concerned with Information Security Issues in Systems Development Processes," *24th Australasian Conference on Information Systems*, Melbourne, Australia, pp. 1-10.
- Mahfuth, A., Yussof, S., Baker, A. A., and Ali, N. a. 2017. "A Systematic Literature Review: Information Security Culture," *Research and Innovation in Information Systems (ICRIIS), 2017 International Conference on: IEEE*, pp. 1-6.
- Merkow, M. S., and Breithaupt, J. 2014. *Information Security Principles and Practices*, (2nd ed.). Pearson.
- Rainer Jr, R. K., Marshall, T. E., Knapp, K. J., and Montgomery, G. H. 2007. "Do Information Security Professionals and Business Managers View Information Security Issues Differently?" *Information Systems Security* (16:2), pp. 100-108.
- Safa, N. S., Von Solms, R., and Furnell, S. 2016. "Information Security Policy Compliance Model in Organizations," *Computers & Security* (56), pp. 70-82.
- Siponen, M., and Vance, A. 2010. "Neutralization: New Insights into the Problem of Employee Information Systems Security Policy Violations," *MIS Quarterly* (34:3), pp. 487-502.
- Smith, S., and Jamieson, R. 2006. "Determining Key Factors in E-Government Information System Security," *Information systems management* (23:2), pp. 23-32.
- Tracy, R. P. 2007. "It Security Management and Business Process Automation: Challenges, Approaches, and Rewards," *Information Systems Security* (16:2), pp. 114-122.
- Whitman, M. E., and Mattord, H. J. 2017. *Management of Information Security*, (5th ed.). Stamford, CT: Cengage Learning.

## Copyright

**Copyright:** © 2018 Dale Kleeman. This is an open-access article distributed under the terms of the [Creative Commons Attribution-NonCommercial 3.0 Australia License](https://creativecommons.org/licenses/by-nc/3.0/australia/), which permits non-commercial use, distribution, and reproduction in any medium, provided the original author and ACIS are credited.

# Understanding the Influencing Factors of the Effectiveness of Trusted Third Party's Trust Transformation

## Cong Cao

School of Computing and Information Technology  
University of Wollongong  
New South Wales, Australia  
Email: cc994@uowmail.edu.au

## Jun Yan

School of Computing and Information Technology  
University of Wollongong  
New South Wales, Australia  
Email: jyan@uow.edu.au

## Mengxiang Li

School of Business  
Hong Kong Baptist University  
Hong Kong SAR, China  
Email: mengxiangli@hkbu.edu.hk

## Abstract

Through the experimental data analysis, this paper found that trusted third parties (TTPs) can effectively reduce the trust barrier of consumers. Furthermore, we point out that TTPs have the function of trust transfer, which provides a meaningful framework for our understanding of the mechanism of TTPs. According to this research, consumers' trust in unfamiliar enterprises is built on their trust of TTPs. The chain relationship of TTPs' trust and certification of enterprises and consumers' recognition of TTPs enables the transfer of consumer trust to enterprises and finally leads to consumers' trust in these enterprises. Also, the reputation and presentation of TTPs can have a significant influence on the trust transfer. The results further reveal the internal mechanism of TTPs and clarify the regulatory factors that influence the trust transfer. These findings are helpful for understanding and extension of relevant theories and enterprises' decision making on TTPs.

**Keywords** online shopping, trusted third party, trust formation, trust transformation, reputation, presentation type.



## 1 Introduction

Electronic commerce (e-commerce) continues to maintain a high pace of development. In 2015, the e-commerce market accumulated a staggering \$1.672 trillion, which accounted for 7.3% of total global retail sales of \$22.822 trillion (Chung 2015). According to National Australia Bank Limited statistics released in 2017, the online shopping amount of Australian reaches \$21.65 billion across both physical goods and digital services in 2016 (National Australia Bank Limited 2017). This is a total increase spend of 10.4% compared to 2015 (National Australia Bank Limited 2017). However, behind the prosperity, the development of e-commerce is also confronted with some challenges. An important issue is how to build trust between the parties involved in the online transaction (Corbitt et al. 2003). In fact, whatever stage the e-commerce has developed to, the building, maintaining and enhancing of online trust are always an issue of primary importance (Kim et al. 2008). The Australian Competition and Consumer Commission (ACCC) receives around 105,000 scam complaints in 2015, which is 14,000 more than that in 2014. The reported lost money increases by 4% and totals \$85 million (Australian Competition and Consumer Commission 2015). In the same period, the Australian Cybercrime Online Reporting Network (ACORN) reveals reported losses of over \$127 million due to e-commerce scams and lack of trust on the virtual market (Australian Competition and Consumer Commission 2015). The results of research reported by Hong-ling and Guang-xing (2011) indicate that the trust is one of the important promoting factors of achieving success in e-commerce. The problems in the early stage of development of e-commerce have been gradually solved when related technologies are advancing, and the infrastructure is perfected, such as online payment, information security, logistics and distribution, policy and laws (Hsu 2008). Currently, in order to further expand e-commerce, how to build up and maintain the level of trust between the transaction counterparties become a very important issue to be solved (Cheung and Lee 2006).

Researchers and practitioners in the field of e-commerce attempt to build and promote online trust by different means. Enhancing the trustworthiness with Trusted Third Parties (TTPs) has become a strategy widely adopted by enterprises. Researchers have carried out profound studies of the influence of TTPs on consumer trust, but no consensus has been achieved in respect of the influence of TTPs on the trust intention. For example, some studies argue that TTPs can significantly improve consumer trust in enterprises (Head and Hassanein 2002; Hu et al. 2010; Kim et al. 2008), but other studies point out that no significant influence can be found. Therefore, in our opinion, more in-depth research must be undertaken (McKnight et al. 2004; Moores 2005; Moores and Dhillon 2003).

On the other hand, although it is expected to build trust in a relatively unknown Internet environment by using services offered by TTP, the TTP-based online trust mechanism and its relative effectiveness are still not sufficiently understood. The online trust building in an Internet environment can be well comprehended only after knowing the specific role of TTP in the process of trust building and transfer, as well as the effectiveness of TTP on consumer trusting behaviours. This may also provide an effective practical guide for online trust strategies. Therefore, the objective of this research is:

*To investigate the influencing factors of the effectiveness of TTP trust transfer.*

The questionnaire-based empirical research is usually used by previous studies to explore the influence of TTPs on consumers' behaviours (Cook and Luo 2003; McKnight et al. 2004; Özpölat and Jank 2015). But it is difficult to make an accurate judgement about the causal relationship between the independent variable (TTPs) and the dependent variable (trust intention) due to the widespread existence of extraneous variables. For these reasons, we decided to examine the influence of TTPs on consumers' trust intention through laboratory testing in a controlled environment.

This paper investigates the mechanism of TTPs in the online shopping environment and points out that they have an important function of enabling the trust transfer during online consumers' trust formation. Further, we examine the influence and regulatory roles of TTPs' different types of reputation and forms of presentation on the trust transfer. A laboratory experiment is performed with  $2 \times 2$  treatment groups to validate the research model and hypotheses proposed herein. The experimental data analysis with the Partial Least Squares Structural Equation Modeling (PLS-SEM) and Partial Least Squares Multi-Group Analysis (PLS-MGA) shows that TTPs can influence consumers' trust intention and behaviours by their trust transfer function. The reputation of TTPs has a positive influence on trust transfer. In addition, it is also found that the detailed and specific TTP description and presentation can significantly enhance consumers' trust expectations and reduce their risk perception. The results not only enrich relevant theories of TTPs, but also provide some reliable guidance for enterprises in using and selecting TTPs.

The remaining sections of this paper are organised as follows. In the second section, we conduct a literature review of online trust and TTPs. The third section gives an introduction to the theoretical basis

and research hypothesis of this research. In the fourth section, the research methodology is explained in detail. The fifth section presents the analysis results of the experimental data. In the sixth section, the research findings and significance have been made clear, and the limitations and suggestions for further research are pointed out. The last section provides an overview of the major findings and arrives at conclusions.

## 2 Literature Review

The e-commerce has attracted increasingly more attention from merchants and consumers because of the advantages of the internet being highly interactive and convenient. Meanwhile, online trust plays a critical role in the online transaction environment due to the virtual nature and time-space separation (Cao and Yan 2014). According to existing studies, online trust is widely accepted as one of the key factors that can influence and promote online transactions (Gefen et al. 2003; Guan and Lala 2017). Therefore, it is important to analyse the main factors for the formation of online trust and study the online trust building mechanism during the development of e-commerce.

Researchers indicate that online trust can play the roles of increasing the predictability of behavioural outcomes, decreasing transaction costs, lessening opportunistic behaviours and reducing uncertainties in partners, thus making the transaction relations more foreseeable and meeting needs (Fam et al. 2004; Fang et al. 2014; Head and Hassanein 2002). From the above research results, it can be observed that if enterprises can prove to consumers that online shopping is trustworthy, this will reduce their risk perception and finally be helpful for the development of online transactions (Hong-ling and Guang-xing 2011; Lim et al. 2006).

A lot of researchers have made insightful studies of consumers' initial trust-building mechanism and formation factors of online trust. The results of the empirical studies show that consumers' perceived usefulness, ease of use and security of web pages are important preconditions for the formation of trust (Sia et al. 2009). Further studies indicate that the reputation of enterprises, consumers' trust intention and structural assurance (namely institution-based trust) have a significant influence on consumers' trust intention (Guo and Jaafar 2011; Hoffman et al. 1999; Kim et al. 2008).

In the industry, a large number of TTPs appear to solve the issue of consumer trust in online transactions. These TTPs provide support for the success of online transactions by different technical means and offering intermediary services. For example, VeriSign secures consumers' online transactions, and TRUSTe provides privacy seal to demonstrate enterprises' compliance with their commitment to privacy protection, thus effectively easing users' concern about their privacy.

In recent years, the research of TTPs has aroused the widespread attention of researchers. Relevant research points out that TTP, as a control mechanism for online transactions, can restrict opportunistic behaviour, effectively eliminate consumers' distrust, increase the number of potential transactions in the future and help to build up a long-term trust relationship between both parties (Benassi 1999; Kimery and McCord 2002). These articles provide valuable contributions to our understanding of the significance and functions of TTPs. However, there are also different voices. For example, based on data collected from questionnaires, some studies argue that TTPs have no significant influence on consumers' trust intention (Cook and Luo 2003; McKnight et al. 2004; Moores 2005; Moores and Dhillon 2003).

As stated above, in our opinion, it is necessary to study the real influence of TTPs on the trust intention by laboratory experiments with the control of extraneous variables. Moreover, the existing research often expounds the influence of TTPs on consumers' behaviours, but seldom explains the mechanism and influencing factors. Therefore, we create  $2 \times 2$  treatment groups for an in-depth discussion of the functions of TTPs and the corresponding regulatory factors, so as to achieve an insightful understanding of TTP.

## 3 Theoretical Background and Hypotheses

Due to some characteristics of online shopping, such as separation of transaction counterparties in space, asynchronous payment and delivery in time, and use and disclosure of personal information (such as name, address, credit card information etc.), online transactions face greater risks compared with the traditional transaction mode (Head and Hassanein 2002). On the other hand, because consumers are unlikely to have all the information about the products and enterprises, they possibly make wrong decisions and even give up transactions (Hong-ling and Guang-xing 2011). At this point, if enterprises accurately transfer the signals containing their own advantages to consumers (e.g. higher quality signage, description of more reasonable prices, easier return policy, trustworthy credentials and third-party

certifications), this can lessen consumers' cost of information collection, reduce their risk perception, promote the formation of trust and increase the quantity of finalized transactions (Fang et al. 2014; Head and Hassanein 2002).

In order to effectively solve the problems above, there emerges a lot of TTPs on the e-commerce market to act as a credit intermediary, whose economic function is to provide the trustworthiness of other enterprises by their trustworthiness formed in the long-term business operation, especially newly incorporated unknown enterprises. This aims to reduce the asymmetry of information on the e-commerce market and reduce consumers' transaction costs, thus promoting their online sales.

Therefore, TTPs have the information transfer function that can facilitate the flow of trustworthy information among online transaction parties and enable consumers to have a more reliable understanding of the trustworthiness of enterprises before transactions. By such function of TTPs, it is easier for both parties of an online transaction to establish a trust relationship.

In the presence of TTPs, the trustworthy information of both parties of the transaction flows between consumers and enterprises through TTPs and finally results in the transfer of both parties' trustworthy information. Consumer trust in unfamiliar enterprises is built on their trust of TTPs. Due to TTPs' certification of enterprises and consumers' trust of TTPs, this kind of chain relationship transfers consumer trust to enterprises and finally leads to their trust in enterprises.

To test the trust transfer function of TTPs in a laboratory environment, we construct the research framework for this research based on the Theory of Planned Behavior (TPB) and the online trust model, as presented in **Figure 1**.

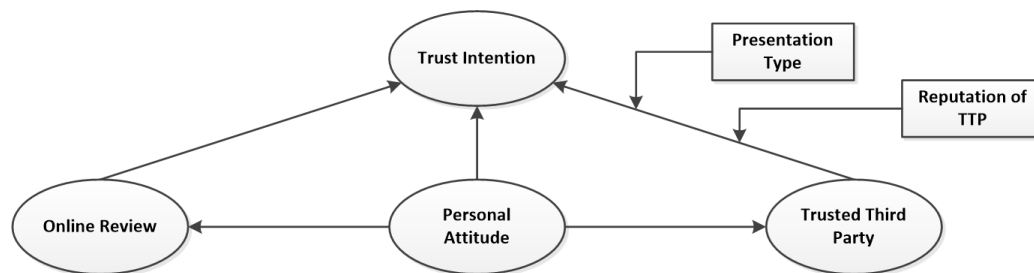

Figure 1: Research Framework

In our opinion, consumers' behaviours are generally in line with the explanation of TPB, that is, the behavioural decision is controlled by their own will and rational. When they have time to think over their behaviours, the behavioural intention is the best way to examine their behaviours. To be specific, with regards to the development of trust behaviour and buying decision in the online shopping environment, consumers are often restricted by time, money, information and personal ability, so their behavioural intention is influenced by other factors. As further pointed out by Cao and Yan (2014)'s research, consumers' personal attitude, online reviews and TTP are three main influencing factors of behavioural intention in the online environment. Taking online trust as an example, if consumers' trust attitude and online reviews are more positive and TTPs provide stronger support, consumers have more trust intention, vice versa.

Based on the above theories, we mainly divide the influencing factors of consumers' trust intention into personal attitude, online reviews and TTPs. The trust intention is the dependent variable and TTP is the independent variable of this experiment. Other influencing factors of the trust intention, such as online reviews and consumers' personal attitude, are extraneous variables under strict control in this laboratory experiment. By control of extraneous variables, their influence on the experimental results are limited, and a relatively high internal validity is obtained, thus laying a solid basis for explaining the causal relationship between TTP and trust intention.

In an e-commerce environment lack of trust, a reliable TTP can play an enormous role. In a virtual environment, consumers often transact with a particular enterprise for the first time, so they expect extra reliable third-party protection. According to Head and Hassanein (2002), the trust of TTPs can effectively enhance consumer trust. Guan and Lala (2017) further point out that the trusted third party has the most important influence on consumer trust. Kimery and McCord (2002)'s research also proves that TTP has a significant influence on consumer trust. Hence, the following hypothesis is put forward:

**H1.** Consumer-perceived TTP has a positive influence on consumers' trust intention.

To further explore the mechanism and influencing factors of TTPs, we first examine a variety of TTPs on the market. It is found that in addition to some TTPs with very high popularity and reputation, there are also some emerging TTPs on the market. Judging from the reputation and popularity, there are two types of TTPs, namely, high reputation and low reputation. Of course, these companies often adopt different strategies in pricing and charging modes. According to the explanation of the Signaling Theory, enterprises transfer their trustworthy signals to consumers through TTPs, thereby influencing consumers' trust intention. Accordingly, we believe that TTPs with higher reputation can transfer stronger signals and have a more significant influence on consumers. Therefore, we propose the following hypothesis:

**H2.** *The reputation of TTP shows the moderation effect on the relationship between TTPs and trust intent.*

Through the exploration of the TTPs used by enterprises and their form of presentation on web pages, the research indicates that TTPs are mainly presented in two forms: abstract logo and concrete description. For example, some enterprises display the certification logo issued by TTPs to support their eligibility. This form of presentation is mainly used to show various types of security certifications, payment certifications and privacy certifications. By displaying TTP's logo visibly on the webpage, they achieve the influence of consumers' trust intention. Another form of presentation uses concrete description to explain the corresponding certifications obtained by the enterprise. For example, a description is provided to the service type and the start and end times of the service certification. Enterprises try to explain the role of TTP services to consumers through detailed descriptions and further influence consumers' behavioural intention. By concrete information disclosure and service description, enterprises can effectively reinforce the trustworthy signals perceived by consumers, reduce the risk expectation and enhance their trust in enterprises. Therefore, this paper believes that:

**H3.** *The form of presentation of TTP shows the moderation effect on the relationship between TTPs and trust intent.*

## 4 Research Methodology

### 4.1 Experimental Design

In order to explore the trust transfer mechanism and influencing factors of TTPs, we create  $2 \times 2$  treatment groups according to the reputation (high or low reputation) and form of presentation (abstract and concrete) to test the research hypotheses. We design an online shopping webpage with a professional appearance to simulate the real online shopping environment. We have carefully chosen products to be sold on the webpage, primarily digital products such as smartphones, cameras and acoustics. Further, the introduction, description, reviews, replacement and return policy and company profile of these products are designed and displayed to resemble real e-commerce websites. For the experiment, we have used four versions of web pages and displayed TTP services at easily visible places.

To minimise the interference of extraneous variables on the experimental results, we mainly take the following measures during the experiment:

First, as revealed by the related study, the design, style, function and features of the webpage can have a certain degree of influence on consumer attitude (Ganguly et al. 2009; Ganguly et al. 2010). To avoid the interference of these factors, a well-known online seller (JB Hi-Fi Group Pty Ltd) is selected as the reference case for this experiment. The webpage used in the experiment is designed based on the JB Hi-Fi's webpage (<https://www.jbhifi.com.au>). Then, 15 volunteers are recruited to test and validate the webpage used in the experiment, for ensuring that the experimental environment can simulate the real online shopping scenarios.

Second, as Cao and Yan (2014) explained in their trust model, consumers' trusting intention is influenced not only by TTPs, but also by reviews of other consumers, consumers-perceived reputation and their propensity to trust. All these factors are likely to interfere with the results observed in the experiment in the form of extraneous variables. To further control the influence of these factors on consumer behaviours, based on the online trust model proposed by Cao and Yan (2014), this research divides extraneous variables into the following two types: consumer attitude and reviews perceived by consumers. The possible influence of consumer attitude on the experiment is effectively controlled through the qualification review of participants. By presenting the neutral consumer reviews, the potential influence of online reviews on participants can be further controlled in the experimental simulation environment.

With the above-mentioned design control approach of the experiment, the control is established for specific extraneous variables (e.g. personal attitude, level of disposition to trust, webpage and reviews) that can influence consumers' behavioural intentions and the variables to be tested in this experiment (presentation and reputation) are operated to obtain a high internal validity and reduce the influence and interference of extraneous variables on the experimental results.

## 4.2 Participants

The participants in this experiment are college students, who voluntarily participate without receiving any compensation and are randomly distributed to four different treatment groups. **Table 1** shows the demographic characteristics. 54% of participants are male, and the most of them (89%) fall into the age group from 18 to 35. More than half of participants shop online for over 12 times and have a very high level of internet skills (mean = 5.84, S.D. = 1.03, on a 7-point Likert scale with 1 = lowest and 7 = highest).

Measure	Category	N	Per cent
Gender	Male	54	54.00%
	Female	46	46.00%
Age	18-24	47	47.00%
	25-34	42	42.00%
	Over 35	11	11.00%
Education	College	22	22.00%
	Undergraduate	61	61.00%
	Postgraduate	17	17.00%
Shopping Frequency (per year)	0-6	7	7.00%
	7-11	32	32.00%
	>12	61	61.00%

Table 1. The Demographic Profile of Respondents (N=100)

## 4.3 Procedures

Before the experiment formally starts, participants are required to enter the computer laboratory, sit down and open the description file stored in computers. Then a brief description is given to the purpose and procedure of the experiment in 5 minutes and guides participants to read the description file stored in computers. Then participants in different treatment groups are instructed to open different versions of web pages and browse them carefully in 15 minutes. Next, a piece of the questionnaire is filled by each participant in 10 minutes so as to collect their demographic characteristics and data about trust intention and behaviours for further analysis. Finally, gratitude is expressed to all participants in this experiment. The experiment has been performed for four times lasting 30 to 35 minutes each. One treatment group has 25 participants, and a total of 100 pieces of data are collected.

## 4.4 Data Analysis

The PLS-SEM has good explanatory power in the case of a small sample size, but without requiring the normal distribution of data, so this approach is utilised for testing the research model and hypotheses proposed herein. First of all, the measurement model is assessed to test the reliability and validity of different constructs. Then, through the assessment of the structural model, we examine the relations of different constructs and the model predictability. Finally, the PLS-MGA is applied for exploring the regulatory role of other relevant factors on the trust transfer.

# 5 Results

## 5.1 Measurement Model

In this research, the Composite Reliability (CR) and Cronbach's  $\alpha$  (CA) are used to test the internal consistency reliability, and the outer loadings are used to test the indicator reliability. In **Table 2**, the CR and CA values of all latent variables are larger than 0.7, and the outer loadings of the constructs of all measurement indicators are larger than 0.708. All these facts indicate that the measurement model of this research has very good reliability (Hair et al. 2012).

Constructs	Items	CA	CR	AVE
Trust Intention (TI)	5	0.864	0.902	0.648
Online Review (OR)	3	0.910	0.944	0.848
Personal Attitude (PA)	5	0.930	0.947	0.781
Trusted Third Party (TTP)	4	0.912	0.938	0.792

Table 2. The Descriptive Statistics for the Constructs

The average variances extracted (AVE) is used for assessing the convergent validity of the measurement model, and the Fornell-Larcker criterion and the cross-loadings for assessing the discriminant validity. As shown in **Table 2**, the AVE values of all constructs are larger than 0.5, indicating good convergent validity (Barclay et al. 1995). The outer loadings of constructs of any indicators in **Table 3** are larger than the cross-loadings between them and other constructs. Also, as shown in **Table 4**, the AVE of any construct in the model is larger than corresponding correlation values with other constructs. All these facts indicate that the measurement model has sufficient discriminant validity (Hair et al. 2012).

	TI	OR	PA	TTP
TI.1	<b>0.805</b>	-0.178	-0.221	0.139
TI.2	<b>0.846</b>	-0.117	-0.204	0.146
TI.3	<b>0.745</b>	-0.115	-0.096	0.001
TI.4	<b>0.776</b>	-0.157	-0.193	0.21
TI.5	<b>0.847</b>	-0.123	-0.235	0.16
OR.1	-0.179	<b>0.869</b>	-0.33	0.011
OR.2	-0.178	<b>0.857</b>	-0.236	-0.055
OR.3	-0.111	<b>0.902</b>	-0.321	-0.011
PA.1	-0.256	-0.370	<b>0.919</b>	-0.543
PA.2	-0.165	-0.284	<b>0.874</b>	-0.545
PA.3	-0.178	-0.253	<b>0.860</b>	-0.523
PA.4	-0.203	-0.295	<b>0.861</b>	-0.545
PA.5	-0.258	-0.297	<b>0.904</b>	-0.571
TTP.1	0.181	-0.031	-0.569	<b>0.908</b>
TTP.2	0.141	-0.006	-0.564	<b>0.896</b>
TTP.3	0.083	-0.042	-0.488	<b>0.852</b>
TTP.4	0.179	0.004	-0.568	<b>0.902</b>

Notes: Bold number indicate item loading on the assigned constructs.

Table 3. The Factor Loadings and Cross Loadings

	TI	OR	PA	TTP
TI	<b>0.805</b>			
OR	-0.171	<b>0.876</b>		
PA	-0.207	0.033	<b>0.899</b>	
TTP	0.32	0.218	-0.611	<b>0.909</b>

Notes: Boldface values on the diagonal are the square root of the AVE.

Table 4. The Correlation Between the Dimensions

## 5.2 Structural Model

By bootstrapping in the Smart PLS, the t-test of significance is conducted for the path coefficient. The original number of samples is 100, and the maximum number of iterations is 5000. The path coefficient and the significance test results are shown in **Figure 2**. The results of the empirical research show that consumers' perception of TTP services can significantly influence their trust intention of online shopping.

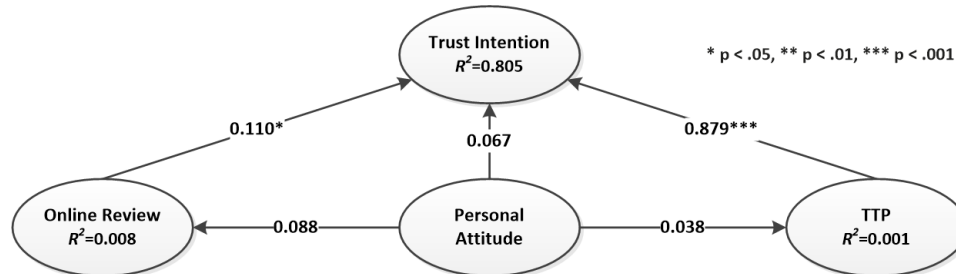

Figure 2: PLS-SEM Analysis Results

The coefficient of determination ( $R^2$ ) reflects the degree of explanation of extraneous latent variable to endogenous latent variable. If  $R^2 > 0.67$ , the latent variable has strong explanatory power,  $R^2 = 0.33$  denotes moderate explanatory power, and  $R^2 = 0.19$  means weak explanatory power (Hair et al. 2012). The value of  $R^2$  is 0.805 for consumers' trust intention in the model hereof and reaches a high level. This indicates that the model proposed herein has good explanatory power.

## 5.3 Multi-group Analysis

In order to understand the influence of TTP reputation and form of presentation on the trust transfer in the online shopping environment, in this research, the parametric approach to PLS-MGA proposed by Sarstedt et al. (2011) has been used for testing the existence of heterogeneity. Through the f PLS-MGA and the independent samples t-test, the results show that they play a regulatory role to the trust transfer. The data are presented in **Table 5** and **Table 6**.

Path	Path Coefficients Difference	t-Value	p-Value
PA->OR	0.012	0.054	0.957
PA->TTP	0.167	1.539	0.125
OR->TI	0.316	1.273	0.204
PA->TI	0.226	1.436	0.152
<b>TTP-&gt;TI</b>	<b>0.805</b>	<b>3.381***</b>	<b>0.001</b>

Table 5. The Parametric Significance Test - High Reputation vs Low Reputation

Path	Path Coefficients Difference	t-Value	p-Value
PA->OR	0.028	0.128	0.898
PA->TTP	0.063	0.585	0.559
OR->TI	0.269	1.066	0.287
PA->TI	0.194	1.374	0.17
<b>TTP-&gt;TI</b>	<b>0.414</b>	<b>1.962*</b>	<b>0.05</b>

Table 6. The Parametric Significance Test - Abstract Presentation vs Concrete Presentation

## 6 Discussion and Implications

### 6.1 Summary of Results

The enterprises' credit information cannot be effectively transferred to consumers due to obstruction and no circulation of information in the online shopping environment, thus causing their distrust of

enterprises (Kim et al. 2008). Being unable to access effective information, consumers are often very cautious in the process of online transactions and lack of trust in merchants. This further results in their reject of potential transactions even in the face of trustworthy enterprises (Guo and Jaafar 2011).

The emergence of TTPs has effectively eased the problems above, reduced the information asymmetry, decreased the cost of searching for information by consumers, facilitated the establishment of a trust relationship and further promoted the development of e-commerce (Özpolat and Jank 2015). Through the analysis of experimental data, this study first provides the reliable evidence that TTPs have a significant influence on consumers' trust intention. In other words, TTPs are favourable for consumers' understanding of enterprises' trustworthy information and effectively promote the level of trust between consumers and enterprises, thus possibly increasing the potential transaction volume.

Further, this research explains the trust transfer function of TTPs in the e-commerce environment and how TTPs transfers consumers' trust in them to target enterprises. In the process of trust transfer, the reputation and presentation of TTPs will play an important regulatory role. Specifically, the higher the reputation of TTP, the higher consumers' recognition, and further the degree of consumer trust in enterprises will be significantly enhanced. On the other hand, the concrete presentation is easier to receive consumers' recognition of TTPs than the abstract presentation, and thus significantly promoting their trust in enterprises.

In our opinion, the influence of TTPs on consumers' behavioural intention is realised by means of trust transfer. Therefore, the degree of consumer trust in TTPs and the effectiveness of trust transfer can significantly influence the level of trust between consumers and enterprises.

There are primarily three parties involved in the online transaction, including consumers, TTPs and enterprises. TTPs build up very good trustworthiness in their long-term market operations. Enterprises transfer their trustworthy information to consumers through TTP services for reducing risks perceived by consumers and enhances their trust in enterprises. Two key points exist in this process of trust transfer, namely consumers' trust in TTP and TTP's certification of enterprises. The former determines the degree of trust transfer, and the latter determines the effect of trust transfer. That is to say, the higher the reputation TTPs have, the more trust consumers will have in them. According to our research, consumers are more willing to accept and recognise the guarantee and certification provided by high-reputation TTPs for other enterprises. Moreover, when enterprises present the TTP guarantee and certification, the concrete and detailed description can more easily influence consumers' perception of trust. In summary, the trust transfer mechanism of TTP is influenced by its reputation and form of presentation, both of which have a significant regulatory effect on consumers' trust intention.

## 6.2 Theoretical and Industrial Significance

With the prosperous development of online shopping, research interests on TTP are increasing with gradually enriched achievements. On the whole, this research also makes some contribution to this field. First of all, we elaborate on the trust transfer function of TTP and explain how the TTP certification service transfers trust to unfamiliar online enterprises. These have enriched related literature in the field of TTP. Secondly, we also have an in-depth discussion of the internal mechanism of TTPs and point out the reputation and form of presentation are the two important factors that can influence and regulate the trust transfer. These results further enrich related theories and extend our understanding of TTPs. Finally, the laboratory environment constructed in this research provides a very high degree of control and thereby resulting in a relatively high level of internal validity. This creates a favourable condition for us to explore and investigate the influence of TTPs on consumers' behaviours.

As regards enterprises, our research provides valuable guidance for their decision on TTP use. TTPs positively influence consumers' trust intention, so enterprises should try their best to adopt the services provided by TTPs, for effectively enhancing consumers' trust level and promote potential transaction volume.

How to choose among all kinds of TTPs on the market is a challenge for enterprises. Our research results show that TTPs with higher reputation have a more significant influence on consumers' trust intention. Accordingly, enterprises should cooperate with TTPs with high reputation on the market, such as TRUSTe, VeriSign and BBBOnline, because they can more effectively transfer the trustworthy information to potential customers, strengthen their trust in enterprises and influence future transactions.

Moreover, our research provides valuable insight for TTPs and their users. Our experimental results indicate that concrete presentation, that is, the detailed description and promotion of the service and certification provided by TTP can effectively enhance the degree of consumer trust in enterprises.



Accordingly, enterprises should not just display simple and abstract icons when presenting TTPs, but give a detailed description of the services and requirements provided by the TTPs and show their trustworthy information to consumers, so as to reduce consumers' perception of risks and create a friendly online shopping environment.

### 6.3 Limitations and Future Research

Although this research has carried out a beneficial exploration of the trust transfer mechanism of TTPs in the online shopping environment, there are still limitations. First, 100 samples satisfy the requirement of minimum sample size by the PLS, but more samples can effectively improve the model predictability and accuracy. Next, the age and education of participants are confined only to college students, so the experimental results cannot be simply extended to consumers made up of different groups in the real online shopping environment. In our future research, it is necessary to more widely collect data of different consumer groups for more reasonably explain the experimental results. Finally, due to the characteristics of a laboratory experiment, there may be demand artifact among participants, and the external validity is also lower than the field experiment. Therefore, the applicability of these experimental results to the real world is possibly weak. In future research, the field experiment may be conducted, for example, real buying behaviours of consumers on online shopping websites with TTPs.

## 7 Conclusion

Due to the virtual nature, anonymity and separation of time and space in the online shopping environment, online trust plays an indispensable role (Fam et al. 2004). Past empirical studies have pointed out that the various services provided by TTPs can effectively alleviate uncertainties consumers face in shopping and enhance their sense of trust, thus improving online transactions of enterprises and promote the development of e-commerce (Hu et al. 2010; Kimery and McCord 2002). Although related research reports that TTPs can significantly influence consumers' trust intention and shopping behaviour decision-making, existing research is seldom carried out by means of laboratory experiments, nor explores the internal mechanism of TTPs. Based on experimental data, this research not only enterprises the significant influence of TTPs on consumers' behaviour, but further explains their trust transfer function in the online shopping environment. Moreover, it also reveals regulatory factors of the trust transfer, namely the reputation and form of presentation of TTPs. Our research results show that the certification service of enterprises provided by TTPs with high reputation can significantly improve the degree of consumer trust in enterprises. The concrete and detailed description and presentation of TTP services can effectively enhance consumers' cognition of TTP services and therefore influence their behavioural intention. In general, the explanation of the trust transfer function and influencing factors of TTPs in this research not only fills the gap of TTP research, but also provides useful guidance for enterprises in choosing TTP services. Of course, we also make clear the limitations and the direction for future research.

## 8 Acknowledgements

The research described in this paper was supported by a grant from the State Scholarship Fund by China Scholarship Council (File No. 201308200014) and a grant from the International Postgraduate Tuition Award by the University of Wollongong, Australia.

## 9 References

- Australian Competition and Consumer Commission. 2015. "Targeting Scams: Report of the Accc on Scam Activity 2015."
- Barclay, D., Higgins, C., and Thompson, R. 1995. *The Partial Least Squares (Pls) Approach to Casual Modeling: Personal Computer Adoption and Use as an Illustration*.
- Benassi, P. 1999. "Truste: An Online Privacy Seal Program," *Communications of the ACM* (42:2), pp. 56-59.
- Cao, C., and Yan, J. 2014. "Towards a Trust Model for Trust Establishment and Management in Business-to-Consumer E-Commerce," *IEEE 11th International Conference on Autonomic and Trusted Computing* pp. 479-486.
- Cheung, C. M., and Lee, M. K. 2006. "Understanding Consumer Trust in Internet Shopping: A Multidisciplinary Approach," *Journal of the American society for Information Science and Technology* (57:4), pp. 479-492.
- Chung, H.-S. 2015. "Online Adr for the E-Commerce: European Union's Adr Legislation for Cross-Border Online Trade," *J. Arb. Stud.* (25), p. 135.

- Cook, D. P., and Luo, W. 2003. "The Role of Third-Party Seals in Building Trust Online," *e-Service Journal* (2:3), pp. 71-84.
- Corbitt, B. J., Thanasankit, T., and Yi, H. 2003. "Trust and E-Commerce: A Study of Consumer Perceptions," *Electronic commerce research and applications* (2:3), pp. 203-215.
- Fam, K. S., Foscht, T., and Collins, R. D. 2004. "Trust and the Online Relationship—An Exploratory Study from New Zealand," *Tourism Management* (25:2), pp. 195-207.
- Fang, Y., Qureshi, I., Sun, H., McCole, P., Ramsey, E., and Lim, K. H. 2014. "Trust, Satisfaction, and Online Repurchase Intention: The Moderating Role of Perceived Effectiveness of E-Commerce Institutional Mechanisms," *Mis Quarterly* (38:2).
- Ganguly, B., Dash, S. B., and Cyr, D. 2009. "Website Characteristics, Trust and Purchase Intention in Online Stores:-an Empirical Study in the Indian Context," *Journal of Information Science & Technology* (6:2).
- Ganguly, B., Dash, S. B., Cyr, D., and Head, M. 2010. "The Effects of Website Design on Purchase Intention in Online Shopping: The Mediating Role of Trust and the Moderating Role of Culture," *International Journal of Electronic Business* (8:4-5), pp. 302-330.
- Gefen, D., Karahanna, E., and Straub, D. W. 2003. "Trust and Tam in Online Shopping: An Integrated Model," *MIS quarterly* (27:1), pp. 51-90.
- Guan, L., and Lala, V. 2017. "Role of Trust and Involvement in the Effectiveness of Digital Third-Party Organization Endorsement," *Atlantic Marketing Journal* (6:1), p. 5.
- Guo, J., and Jaafar, N. I. 2011. "A Study on Consumers' Attitude Towards Online Shopping in China," *International Journal of Business and Social Science* (2:22).
- Hair, J. F., Sarstedt, M., Ringle, C. M., and Mena, J. A. 2012. "An Assessment of the Use of Partial Least Squares Structural Equation Modeling in Marketing Research," *Journal of the academy of marketing science* (40:3), pp. 414-433.
- Head, M. M., and Hassanein, K. 2002. "Trust in E-Commerce: Evaluating the Impact of Third-Party Seals," *Quarterly Journal of Electronic Commerce* (3), pp. 307-326.
- Hoffman, D. L., Novak, T. P., and Peralta, M. 1999. "Building Consumer Trust Online," *Communications of the ACM* (42:4), pp. 80-85.
- Hong-ling, M., and Guang-xing, S. 2011. "An Overview of Trust Mechanism and Applications of E-Commerce," *Management and Service Science (MASS), 2011 International Conference on*, pp. 1-5.
- Hsu, C.-J. 2008. "Dominant Factors for Online Trust," *Cyberworlds, 2008 International Conference on: IEEE*, pp. 165-172.
- Hu, X., Wu, G., Wu, Y., and Zhang, H. 2010. "The Effects of Web Assurance Seals on Consumers' Initial Trust in an Online Vendor: A Functional Perspective," *Decision Support Systems* (48:2), pp. 407-418.
- Kim, D. J., Ferrin, D. L., and Rao, H. R. 2008. "A Trust-Based Consumer Decision-Making Model in Electronic Commerce: The Role of Trust, Perceived Risk, and Their Antecedents," *Decision Support Systems* (44:2), pp. 544-564.
- Kimery, K. M., and McCord, M. 2002. "Third-Party Assurances: The Road to Trust in Online Retailing," *System Sciences, 2002. HICSS. Proceedings of the 35th Annual Hawaii International Conference on*, p. 10 pp.
- Lim, K. H., Sia, C. L., Lee, M. K., and Benbasat, I. 2006. "Do I Trust You Online, and If So, Will I Buy? An Empirical Study of Two Trust-Building Strategies," *Journal of management information systems* (23:2), pp. 233-266.
- McKnight, D. H., Kacmar, C. J., and Choudhury, V. 2004. "Shifting Factors and the Ineffectiveness of Third Party Assurance Seals: A Two - Stage Model of Initial Trust in a Web Business," *Electronic Markets* (14:3), pp. 252-266.
- Moores, T. 2005. "Do Consumers Understand the Role of Privacy Seals in E-Commerce?," *Commun. ACM* (48:3), pp. 86-91.
- Moores, T. T., and Dhillon, G. 2003. "Do Privacy Seals in E-Commerce Really Work?," *Commun. ACM* (46:12), pp. 265-271.
- National Australia Bank Limited. 2017. "Nab Online Retail Sales Index." from <https://business.nab.com.au/wp-content/uploads/2017/11/norsi-sept-2017.pdf>
- Özpolat, K., and Jank, W. 2015. "Getting the Most out of Third Party Trust Seals: An Empirical Analysis," *Decision Support Systems* (73), pp. 47-56.
- Sarstedt, M., Henseler, J., and Ringle, C. M. 2011. "Multigroup Analysis in Partial Least Squares (PLS) Path Modeling: Alternative Methods and Empirical Results," in *Measurement and Research Methods in International Marketing*. Emerald Group Publishing Limited, pp. 195-218.
- Sia, C. L., Lim, K. H., Leung, K., Lee, M. K., Huang, W. W., and Benbasat, I. 2009. "Web Strategies to Promote Internet Shopping: Is Cultural-Customization Needed?," *Mis Quarterly*), pp. 491-512.

# Exploring Knowledge Sharing Practices for Raising Security Awareness

## **Hiep-Cong Pham**

School of Business and Management  
RMIT University Vietnam  
Ho Chi Minh City, Vietnam  
Email: hiep.pham@rmit.edu.vn

## **Irfan Ulhaq**

School of Business and Management  
RMIT University Vietnam  
Ho Chi Minh City, Vietnam  
Email: irfan.ulhaq@rmit.edu.vn

## **Mathews Nkhoma**

School of Business and Management  
RMIT University Vietnam  
Ho Chi Minh City, Vietnam  
Email: mathews.nkhoma@rmit.edu.vn

## **Minh Nhat Nguyen**

School of Business and Management  
RMIT University Vietnam  
Ho Chi Minh City, Vietnam  
Email: minh.nguyennhat@rmit.edu.vn

## **Linda Brennan**

School of Media & Communication  
RMIT University Australia  
Melbourne, Victoria, Australia  
Email: linda.brennan@rmit.edu.au

## **Abstract**

This study aims to explore the types of information can be effectively communicated in three knowledge-sharing methods and their impact on employees' security practice. On one end, guarding the organisation's information system against cyber-attacks is critical and improving users' knowledge and skills is a common approach to any security program. On the other end, organisations lack a clear understanding in determining what types of security information should be delivered through various methods of communication to be effective in boosting users' knowledge and compliance behaviour. The study employed a qualitative method using semi-structured interviews with business users in Vietnam. The initial findings indicate a single method of knowledge and skill development is not sufficient to assist users to deal with complex and constant changing security needs. It is necessary to further experiment methods of encouraging formal and peer knowledge sharing that can support individual effort in complying with security policies.

**Keywords:** knowledge sharing, types of security information, social media, security compliance

## 1 Introduction

Organizations at the verge of information security risks due to higher data breaches. Although organizations are putting in place technical measures, Juniper Research predicts data breaches would cost \$8 trillion globally by 2022 (Juniper Research 2017). However, it is human factor that causes most organisational security risks as security incidents are indirectly caused by employees often failing to comply with organizational policies (Pattabiraman 2018).

Prior studies have established that users' internal factors such as attitude, self-efficacy and perceived response cost towards security tasks can affect their commitment to complying with information security policies (Safa et al. 2016; Sommestad et al. 2015). Security self-efficacy describes an individual's security knowledge and expertise that enables him/her to perform their security tasks, as well as cope with changing security requirements. Contrary to this above, lacking cyber security knowledge could result in users' lack of confidence, higher dissatisfaction, and a sense of helplessness (Salanova et al. 2013), causing confusion to deal with security incidents in practice (Tarafdar et al. 2011). As a result, employees often struggle to find a solution to deal with cyber security issues.

Role of knowledge sharing among employees is paramount for business success. Knowledge sharing in relation to information security is often achieved through training and through provision of security policy procedures (Park 2017; Puhakainen and Siponen 2010). Encouraging knowledge sharing among employees can enhance their understanding of organizational issues and promote their commitment (Park 2017). However, few studies have examined how employees practice knowledge sharing in the context of cyber security (Rocha et al. 2014), and whether to use knowledge acquisition and sharing at work as the potential channels to improve the cyber security system internally. Furthermore, researchers found that these methods often remain inefficient in the dissemination of required knowledge. For example, the complexity and technical aspects of information security knowledge are often seen prime inhibitors at individual level among employees (Safa and Von Solms 2016).

This study aims to explore what types of security information that employees discuss and share on various communication methods at work and assess their impacts on users' security practice. By acquiring better understanding of sharing methods on user security behaviour, organisations can design and develop suitable channels to increase their employees' cyber security knowledge and encourage their security compliant commitments. The next section presents the significance of knowledge sharing in security practice, followed by a review of knowledge sharing channels. Next proposed study method and initial findings are provided. Lastly, future research is outlined.

## 2 Significance of Security Awareness and Knowledge Sharing to Security Compliance

Of the three types of information security measures (i.e. physical, technical and administrative), effectiveness of administrative measures relies greatly on levels of awareness and compliance among IT users. Administrative security measures are mainly specified in information security policies (Höne and Eloff 2002). In fact, most research on security compliance has focused on understanding factors influencing users to comply with security policies (Safa 2018; Sommestad et al. 2014). Lack of sufficient cyber security awareness can lead to the unsafe behaviour which can pose as a threat to the proactive safeguarding in organisations (Knapp et al. 2006).

Previous research has shown that knowledge sharing among users within an organisation is an efficient way to increase the awareness of employees and their compliance with information security policies (Mallinder and Drabwell 2013; Safa and Von Solms 2016). Given the increasing number of cyber risks, the issue of effective knowledge sharing is more critical to ensure employees stay vigilant against potential risks. Furthermore, complex tasks such as securing information assets cannot be completely accomplished without an efficient knowledge sharing process (Jafari and Charband 2016; Zhang et al. 2012).

Cummings (2004) describes two approaches of knowledge sharing: formal method including disseminating information security policies and formal trainings. Warkentin et al. (2011) found that through informal sharing methods such as support from colleagues, informational material, verbal discussions, feedback sessions and observations help individuals to improve the security behavior and policy compliance. Feledi et al. (2013) emphasized the need of trust among the staff members to enhance the information security knowledge sharing. Safa and Von Solms (2016) discussed the importance of experts and staff with the capabilities of information security knowledge are effective means to enhance security behavior. Several factors have been identified to affect effective security knowledge sharing are

connection between practice and needs of end-users, communication method of security policies and security support services (Jafari and Charband 2016).

Design of information security practices is important since it is an efficient way to generate positive feelings and willingness of employees towards the information assets protection behaviour (Belsis et al. 2005). However, due to emerging threats in the cyberspace often security policy documents become outdated (Liu et al. 2011), leading to higher threats to overall organization (Rocha et al. 2014). In this regard, support from IT experts and peers is important to encourage employees to keep up to date with information protection techniques (Pham et al. 2016; Wang and Hou 2015). By developing a culture where people are always willing to share knowledge and have a trusted and effective channel to communicate, an organisation is not only be able to encourage their employees to improve the knowledge but also to reduce the potential external attacks by increasing the awareness level of information safety and compliance towards the policies internally (Safa 2018).

### **3 Three Methods of Awareness-Raising in Cyber Security**

The first method of raising user security awareness is formal training which has been regarded highly effective in sharing knowledge and developing safe security behaviour of employees (Puhakainen and Siponen 2010). Training has been found as an efficient way to deliver theoretical explanations that are necessary for users to understand 'why' and 'how' of information security compliance (Clark 2008). Training also involves people to think and apply the cognitive thinking about a specific issue or problem they face in information security context (Clark 2008). The cognitive process includes variety of thinking levels in the learning process, including 'remembering, understanding, applying, analysing, evaluating and creating levels (Idris 2016; Meerbaum-Salant et al. 2013). The cognitive process can encourage people to have the critical thinking enabling self-regulation, which directly lead to the stable and long-term sustained behaviours.

The second method is through virtual communities and social media platforms which have emerged as a new way of group knowledge sharing, which allow people to share information and experience without meeting face-to-face (Chang et al. 2015). Social media offers more cooperative platform to share thoughts, experiences, opinions, feedbacks and perspectives (Kaplan and Haenlein 2010). Furthermore, social media platforms offer a better way to acquire new knowledge from peers, networks and through live engagements (Wasko and Faraj 2000). Additionally, information is disseminated through variety of methods including videos, photos and audios (Kwahk and Park 2016). Although, the role of social media as knowledge sharing platform is well recognized (Gupta and Brooks 2013; Hajli and Lin 2016), however, the use of social media for security knowledge sharing within an organisational workplace has been neglected.

The third one can be done through designated information security experts in each department. A departmental security expert refers to an individual who is recognised for being knowledgeable and having more domain technical skills than other colleagues. By facilitating the knowledge sharing within a specific working community, departmental experts can reduce the waiting time and cost for their organisation from investing in cyber security technical system (Safa et al. 2016). There are two types of departmental experts, including formal ones such as managers or supervisors, and informal ones, any single employee who is respected from others toward a security field. Supervisory support was found to be an important factor that increases knowledge sharing among employees by reinforcing positive attitudes and feelings of employees (Shafiq et al. 2013). Such support can be expressed implicitly through the reactions of supervisors when managing mistakes, thus, positively influence the adapting efforts, self-responsibility, collaboration and knowledge sharing of employees towards the expected environments in workplace (Raineri and Paillé 2016). In addition, with the control and discretionary power to make decisions, managers are able to allocate training schedules, develop training strategies, and build competence programs and act as potential channels for providing advices for specific security problems (Kettinger et al. 2015).

On one end, guarding the organisation's IS against cyber-attacks is critical and improving users' awareness and skills is a common approach to any security program. On the other end, organisations lack a clear understanding in determining what types of IS security information should be delivered through various methods of communication to be effective in boosting users' knowledge and compliance behaviour. The study sets out to ascertain how business users perceive the effectiveness of three identified knowledge-sharing methods on their security practice. The expected findings would elaborate how suitable platforms for encouraging knowledge sharing practice among users can improve security awareness and skill development, which may lead to better security compliance.

## 4 Research Method

This study employs qualitative approach using semi-structured group interviews to explore security knowledge/information sharing practice among employees in organisations. Interview questions were open-ended, enabling researchers to discover, comprehend and get the insights of the participants on how they perceive and assess effectiveness of various knowledge sharing methods (Denzin and Lincoln 2018). The subject of this study concentrates on employees and their interaction with security communication, hence only end business users are to be recruited for the interviews. Managers of several organisations that the researchers had connections with were contacted to join the study. Accepted organisations were asked to recommend available employees to participate the interviews. So far eight interviews, averaging 45 to 60 minutes each, with 25 participants from eight organisations were conducted. Participants were asked to provide years of work experience in the company, job position, department, level of IT expertise and their experience of discussing cyber security issues at work.

Since multiple interviews were conducted, the findings from previous interviews were used guide the following ones to explore more aspects or confirm previous findings of security knowledge sharing practices. By interviewing users from different organisations, the diverse security environments in different organisations enabled to explore a range of security practices. Due to inherent complexity and unclarity of security concepts, participants were shown a set of photos (e.g. security warning icons and logos, physical security artefacts) depicting different security-related factors that might gauge the participants' experience and thoughts towards cyber security. The interviews were conducted in both English and Vietnamese, and the Vietnamese ones were transcribed into English. The answers of participants were transcribed, coded, and grouped by common key themes using Nvivo version 11, a text analysing software for qualitative research. From the transcripts, data were filtered and classified to identify and elaborate participants' responses on information types and sharing methods.

## 5 Initial Study Results

There are diverse views towards topics to be communicated on each method. Most participants agreed that they did not discuss or share security topics among colleagues, rather they should be directed to IT staff. When employees face some risky situations, they normally prefer to call IT staff for help. Security training is still the main method to provide awareness and skills to comply with security policies. Though this method is far from satisfying users' needs due to lacking timely and up to date guidance. Most participants agreed that alternative methods of peer sharing of security topics can be important and helpful for paying attention to their security practice.

### 5.1 Security Training for Policy Updates

Training was commonly agreed among participants as a common and effective method to equip employees with necessary security knowledge and come along with the suggestion that it need to be customised with different working natures. Majority of participants agreed that the IT department could provide more training courses and send employees to workshops to update their knowledge about cyber security. Responses from participants also viewed IT training as providing too technical and unfamiliar knowledge in an unattractive format to most users. They insisted that trainings that contain fun, interactive and authentic activities would stimulate more interest.

Many also raised concerns that trainings were not conducted frequently enough and focused more on educating policies than how to deal with security risks. Users may not find them useful in day to day or security crisis.

### 5.2 Social Media for Instant Major Security Updates

Participants from local financial organisations reported the use of several social media application at work as an unofficial group information sharing channel. Some of these social professional groups comprised more than fifty people from both inside and outside an organization, although the details of these communications were confidential. Groups of stock traders or advisers daily used social media tools such as Facebook Messenger, Skype and Zalo (a local Vietnam developed chat application). Using social media applications for knowledge sharing is preferred by the participants because of its convenience and immediateness without being attached to a computer, which allows employees to share and update their knowledge relating to the information security faster and in a more timely manner.

Most participants preferred using social media to share urgent and significant security warnings to the use of organisational emails. Additionally, information posted on social media should be framed to directly relate to each group's interest to avoid flooding irrelevant updates on their professional

channels. However, many of them were not aware of any security implications using social media. Furthermore, they were not aware of consequences that may occur from disclosing financial information on potentially open and unsecure channels that may end up with people outside the organisation

### 5.3 Departmental Experts as a Domain-Specific Source for Security Knowledge

Many participants recommended the use of department experts as unofficial security support to new staff members due to their domain knowledge and deep understanding of security culture. Seeking their advice was viewed as an effective way of resolving immediate security tasks without going through time-consuming IT support channel.

Participants highlighted that some organisations did not have formal staff orientation for new staff, who normally did not have sufficient domain knowledge to properly respond to security issues at the right time and right place, which other formal channels could not prove effective. Therefore these experts can provide them with task-related security knowledge and requirements. Sharing knowledge between a designated security expert to other colleagues is, therefore, not only another potential way to enhance knowledge of employees about information security but can also be a cost-effective approach in solving security compliance problems.

## 6 Future Research

The study's initial findings indicate that initiating regular informal information and knowledge sharing among employees can be effective in improving users' situational awareness and security compliance. Employees tend to take cautions right after a major security incident and soon losing attention afterwards. Initial findings show that organisations still rely on formal training courses to equip users with required awareness. Whereas employees criticise that training does not provide timely and updated knowledge at the time of dealing with security incidents. Given the popularity and anywhere, anytime of mobile technology, organisation can explore use mobile social media tools to facilitate and encourage employees in sharing timely and contextual security knowledge and concerns. Though precautions need to be taken when sensitive security information is shared on these tools. Departmental experts have been found to be valued among participants thanks to quick access to advice for unique business requirements.

It is important for organisations to develop the robust knowledge sharing practice with supporting channels that utilise latest technology development in social media and mobile technology. Next stage of the study will focus on expanding specific types of information advice and contextual use of that information on which sharing methods and how they affect employees' security practice. More emphasis will also be put on detailing how a comprehensive security communication strategy can be developed to cover most aspects of users' security information needs.

## 7 References

- Belsis, P., Kokolakis, S., and Kiountouzis, E. 2005. "Information Systems Security from a Knowledge Management Perspective," *Information Management & Computer Security* (13:3), pp. 189-202.
- Chang, C. M., Hsu, M. H., and Lee, Y. J. 2015. "Factors Influencing Knowledge-Sharing Behavior in Virtual Communities: A Longitudinal Investigation," *Information Systems Management* (32:4), pp. 331-340.
- Clark, R. C. 2008. *Building Expertise: Cognitive Methods for Training and Performance Improvement*. John Wiley & Sons.
- Cummings, J. N. 2004. "Work Groups, Structural Diversity, and Knowledge Sharing in a Global Organization," *Management Science* (50:3), pp. 352-364.
- Denzin, N. K., and Lincoln, Y. S. 2018. *The Sage Handbook of Qualitative Research*, (Fifth edition. ed.). Los Angeles: Sage.
- Feledi, D., Fenz, S., and Lechner, L. 2013. "Toward Web-Based Information Security Knowledge Sharing," *Information security technical report* (17:4), pp. 199-209.
- Gupta, R., and Brooks, H. 2013. *Using Social Media for Global Security*. John Wiley & Sons.
- Hajli, N., and Lin, X. 2016. "Exploring the Security of Information Sharing on Social Networking Sites: The Role of Perceived Control of Information," *Journal of Business Ethics* (133:1), pp. 111-123.

- Höne, K., and Eloff, J. H. P. 2002. "Information Security Policy — What Do International Information Security Standards Say?," *Computers & Security* (21:5), pp. 402-409.
- Idris, G. 2016. "The Evaluation of the Cognitive Learning Process of the Renewed Bloom Taxonomy Using a Web Based Expert System," *TOJET : The Turkish Online Journal of Educational Technology* (15:4).
- Jafari, N. N., and Charband, Y. 2016. "Knowledge Sharing Mechanisms and Techniques in Project Teams: Literature Review, Classification, and Current Trends," *Computers in Human Behavior* (62), pp. 730-742.
- Juniper Research. 2017. "Cybercrime & the Internet of Threats." Retrieved 30 May, 2018, from <https://www.juniperresearch.com/document-library/white-papers/cybercrime-the-internet-of-threats-2017>
- Kaplan, A. M., and Haenlein, M. 2010. "Users of the World, Unite! The Challenges and Opportunities of Social Media," *Business Horizons* (53:1), pp. 59-68.
- Kettinger, W. J., Li, Y., Davis, J. M., and Kettinger, L. 2015. "The Roles of Psychological Climate, Information Management Capabilities, and It Support on Knowledge-Sharing: An Moa Perspective," *European Journal of Information Systems* (24:1), pp. 59-75.
- Knapp, K. J., Marshall, T. E., Kelly Rainer, R., and Nelson Ford, F. 2006. "Information Security: Management's Effect on Culture and Policy," *Information Management & Computer Security* (14:1), pp. 24-36.
- Kwahk, K.-Y., and Park, D.-H. 2016. "The Effects of Network Sharing on Knowledge-Sharing Activities and Job Performance in Enterprise Social Media Environments," *Computers in Human Behavior* (55), pp. 826-839.
- Liu, D., Ji, Y., and Mookerjee, V. 2011. "Knowledge Sharing and Investment Decisions in Information Security," *Decision Support Systems* (52:1), pp. 95-107.
- Mallinder, J., and Drabwell, P. 2013. "Cyber Security: A Critical Examination of Information Sharing Versus Data Sensitivity Issues for Organisations at Risk of Cyber Attack," *Journal of Business Continuity & Emergency Planning* (7:2), p. 103.
- Meerbaum-Salant, O., Armoni, M., and Ben-Ari, M. 2013. "Learning Computer Science Concepts with Scratch," *Computer Science Education* (23:3), pp. 239-264.
- Park, S.-K., Lee, S.-H., Kim, T.-Y., Jun, H.-J., & Kim, T.-S. 2017. "A Performance Evaluation of Information Security Training in Public Sector," *Journal of Computer Virology and Hacking Techniques* (13:4), pp. 289-296.
- Pattabiraman, A., Srinivasan, S., Swaminathan, K., & Gupta, M. 2018. "Fortifying Corporate Human Wall: A Literature Review of Security Awareness and Training," in *Information Technology Risk Management and Compliance in Modern Organizations*, R.S. M. Gupta, J. Walp, & P. Mulgund (Eds.) (ed.). Hershey, PA: IGI Global, pp. 142-175.
- Pham, C. H., El-den, J., and Richardson, J. 2016. "Stress-Based Security Compliance Model-an Exploratory Study," *Journal of Information and Computer Security* (24:3), pp. 326-347.
- Puhakainen, P., and Siponen, M. 2010. "Improving Employees' Compliance through Information Systems Security Training: An Action Research Study," *MIS Quarterly* (34:4), pp. 757-778.
- Raineri, N., and Paillé, P. 2016. "Linking Corporate Policy and Supervisory Support with Environmental Citizenship Behaviors: The Role of Employee Environmental Beliefs and Commitment," *Journal of Business Ethics* (137:1), pp. 129-148.
- Rocha, F. W., Antonsen, E., and Ekstedt, M. 2014. "Information Security Knowledge Sharing in Organizations: Investigating the Effect of Behavioral Information Security Governance and National Culture," *Computers and Security* (43), pp. 90-110.
- Safa, N. S., Maple, C., Watson, T., & Von Solms, R. 2018. "Motivation and Opportunity Based Model to Reduce Information Security Insider Threats in Organisations," *Journal of Information Security and Applications* (40), pp. 247-257.
- Safa, N. S., and Von Solms, R. 2016. "An Information Security Knowledge Sharing Model in Organizations," *Computers in Human Behavior* (57), pp. 442-451.
- Safa, N. S., Von Solms, R., and Furnell, S. 2016. "Information Security Policy Compliance Model in Organizations," *Computers & Security* (56), pp. 70-82.



- Salanova, M., Llorens, S., and Cifre, E. 2013. "The Dark Side of Technologies: Technostress among Users of Information and Communication Technologies," *International Journal of Psychology* (48:3), pp. 422-436.
- Shafiq, M., Zia-ur-Rehman, D. M., and Rashid, M. 2013. "Impact of Compensation, Training and Development and Supervisory Support on Organizational Commitment," *Compensation & Benefits Review* (45:5), pp. 278-285.
- Sommestad, T., Hallberg, J., Lundholm, K., and Bengtsson, J. 2014. "Variables Influencing Information Security Policy Compliance: A Systematic Review of Quantitative Studies," *Information Management & Computer Security* (22:1), pp. 42-75.
- Sommestad, T., Karlzén, H., and Hallberg, J. 2015. "The Sufficiency of the Theory of Planned Behavior for Explaining Information Security Policy Compliance," *Information and Computer Security* (23:2), pp. 200-217.
- Tarafdar, M., Tu, Q., Ragu-Nathan, T., and Ragu-Nathan, B. 2011. "Crossing to the Dark Side: Examining Creators, Outcomes, and Inhibitors of Technostress," *Communications of the ACM* (54:9), pp. 113-120.
- Wang, W.-T., and Hou, Y.-P. 2015. "Motivations of Employees' Knowledge Sharing Behaviors: A Self-Determination Perspective," *Information and Organization* (25:1), pp. 1-26.
- Warkentin, M., Johnston, A. C., and Shropshire, J. 2011. "The Influence of the Informal Social Learning Environment on Information Privacy Policy Compliance Efficacy and Intention," *European Journal of Information Systems* (20:3), pp. 267-284.
- Wasko, M. M., and Faraj, S. 2000. "It Is What One Does": Why People Participate and Help Others in Electronic Communities of Practice," *The Journal of Strategic Information Systems* (9:2), pp. 155-173.
- Zhang, X., Pablos, P. O. d., and Zhou, Z. 2012. "Effect of Knowledge Sharing Visibility on Incentive-Based Relationship in Electronic Knowledge Management Systems: An Empirical Investigation," *Computers in Human Behavior* (29:2), pp. 307-313.

# **Assessing the Determinants of Business Value Related to IT Projects: A Strategic Alignment Perspective of Public-Sector Organisations in Saudi Arabia**

## **Abdulaziz Al-Ghazi**

School of Computing and information technology  
University of Wollongong  
Australia-NSW  
Email: aa485@uowmail.edu.au

## **Tingru Cui**

School of Computing and information technology  
University of Wollongong  
Australia-NSW  
Email: tingru@uow.edu.au

## **Samuel Fosso**

Toulouse Business School  
France- Toulouse  
Email: fossowam@gmail.com

## **Mengxiang Li**

Hong Kong Baptist University  
Hong Kong  
Email: mengxiang.li85@gmail.com

## **Jun Shen**

School of Computing and information technology  
University of Wollongong  
Australia-NSW  
Email: jshen@uow.edu.au

## **Abstract**

Strategic alignment is considered an important construct in the study of business value related to IT projects. The proposed research study aims to identify and analyse the key determinants of business value related to IT projects using a business/IT strategy alignment perspective in Saudi public-sector organisations. The study will utilise a mixed methods design that includes a sample of senior managerial staff drawn from the financial and economic sectors in Saudi Arabia. Qualitative data will be collected via semi-structured interviews (n=15-20 participants) and quantitative data will be collected via survey (n=150-200 participants). Quantitative data will be analysed using SmartPLS software and qualitative data will be analysed using the NVivo software. The key findings from the data set will be discussed in depth to provide a deeper understanding of the determinants of business value related to IT projects from a strategic alignment perspective in public-sector organisations in Saudi Arabia.

**Keywords:** Business and IT strategy alignment, digital transformation strategy, IT governance mechanisms, top management support, quality of IT project planning, public sector, Saudi Arabia.

# 1 INTRODUCTION

## 1.1 Introduction

Strategic alignment is considered an important area of focus in the study of business value related to Information Technology (IT) projects (Coltman et al. 2015; Dulipovici and Robey 2013; Gerow et al. 2014). It is therefore not surprising that this topic has remained a top management (TM) priority for business and IT executives (Gerow et al. 2014; Gerow et al. 2015; Wu et al. .,2015). Indeed, business-IT strategic alignment is an enabler of business performance (Coltman et al. 2015; Cui et al. 2015) and a factor of critical importance and continuous challenge within the information systems (IS) discipline (Gerow et al. 2014; Luftman and Derksen 2012). As stated by Coltman et al. (2015) “organizations will perform well when key IT resources – physical IT infrastructure components, technical and managerial IT skills, and knowledge assets – are aligned with business strategy and when appropriate structures are used to supervise the deployment and effective management of these resources.”

Indeed, the value of IT projects to Saudi public sector organisations is well established. Al-Khowaiter, Dwivedi and Williams (2015) for instance point to benefits of well-aligned business-IT goals related to enhanced competitiveness due to improvements in resource uses as well as more streamlined human resource management procedures. Indeed, the management of information is increasingly crucial to modern human resource function in public organisations (Al-Khowaiter et al., 2015). It is therefore not surprising that the “creation of agile public organisations (Saudi Ministry of Economy and Planning, 2017). is central to the National Transformation Program 2020 and the Kingdom’s Vision 2030. Such agility emerges from improved operational efficiency, in which IT projects have a central role. It is for this reason that the Saudi governments has commitment to increase its investments in IT systems (Saudi Government n.d.). Public sector organisations in Saudi Arabia also recognise the value of IT projects to facilitate higher quality and more effective service delivery. New ICTs increasingly provide Saudi government organisations particularly with greater capacity of citizen engagement alongside more efficient operational outcomes. As Al-Barrak, Carr and Ryan (2016) state, the Saudi government “realises the enormous benefits” of ICTs and understands the importance of business-IT goal alignment in public sector organisations to its efforts to invigorate the public sector.

Although prior research has proposed a set of useful theoretical viewpoints for understanding strategic alignment, very few studies have been directed towards the role of IT projects in the context of strategic alignment assessment. Therefore, this research is an initial attempt to bridge the existing knowledge gap in the literature. More specifically, this research draws on prior studies on strategic alignment to answer the following research questions:

## 1.2 Research Questions

1. What is the impact of IT governance mechanisms on Business-IT strategic alignment in the context of IT projects?
2. What are the effects of TM characteristics (e.g. TM support, TM knowledge of IT, TM participation in business planning, and participation in strategic IT planning) on Business-IT strategic alignment and IT governance mechanisms in the context of IT projects?
3. What is the impact of Business-IT strategic alignment on the quality of IT project planning and for moderating the impact of organisational characteristics on this relationship?
4. What is the impact of the quality of IT project planning on IT project outcomes (organisational performance, service innovation, and operational excellence)?

## 1.3 Significance of the Research Problem

One of the leading factors contributing to the failure of IT projects is misalignment between the IT and business strategy (Alsudiri et al. 2013). As Barnes (2017) explains, a key reason for the misalignment to occur is the limited information available to IT business leaders regarding the nature of the relationship between project alignment, performance outputs, and successful project outcomes. The successful implementation of IT projects is an issue of relevance to SA. There are presently a range of technological, cultural, organisational, and social issues facing the SA government in its efforts to implement its National e-Government Strategy. However, only a limited number of studies have focused on how organisations achieve the alignment between IT and business strategies while developing or implementing IT projects. This study is therefore important to address business/IT strategy alignment/misalignment issues for public-sector organisations in SA and developing countries. The findings may also be valuable to the Saudi government during the implementation of the national

strategy to increase productivity and efficiency outcomes for public-sector organisations as part of the initiative to diversify the economy.

## **2 LITERATURE REVIEW**

### **2.1 Gaps in our Academic Understanding**

A review of the literature revealed a general lack of understanding and analysis of how different industries compare in relation to Business-IT strategy alignment issues and their resolution. The studies of strategic alignment reviewed primarily focused on a specific industry or workplace setting; for example, project management in telecommunications companies (Alsudiri et al. 2013), business performance in e-commerce industries (Schniederjans and Cao 2009), and governance factors in the banking sector (Reynolds and Yetton 2015). Comparative studies on strategic alignment across different business sectors and industries will therefore help to explain the primary catalysts of Business-IT strategy alignment as well as expand our understanding of potential solutions to Business-IT strategy alignment issues.

Furthermore, the absence of integrated IT strategies with business goals and objectives is always associated with a lack of IT credibility and a subsequent reduction in IT investment. As a result, proactive systems are created within a corporation instead of reactive ones (El-Telbany and Elragal 2014). In turn, a key finding to emerge from a review of the literature is that IT planning and shared domain knowledge such as TM knowledge of IT, TM participation in business planning, and participation in strategic IT planning are important factors when assessing the impacts of contextual factors on Business-IT strategic alignment.

### **2.2 Theoretical Perspectives of Strategic Alignment**

Various theoretical perspectives have been applied in the study of strategic alignment including the RBV (Barney, 1991) and Dynamic Capability (DC) approach.

#### **2.2.1 Resource based view, dynamic capability and knowledge view**

The RBV was developed by Barney (1991) as a strategic tool to facilitate understanding of the source of a firm's competitive advantage. He argued that to create and sustain a competitive advantage a firm should possess resources that are valuable, rare, inimitable and non-substitutable (VRIN). The RBV has been extensively used in IS research to identify IT resources leading to improved organizational performance (Guangming Cao et al., 2016; Ravichandran and Lertwongsatien 2005). For instance, Park et al. (2017) used the RBV to conceptualize internal and external IT governance. Then, they proposed three alignment types between approaches to governance and assess their impact on organizational performance and found a hierarchy-based alignment structure improves the operational efficiency of firms.

The Dynamic Capability (DC) approach was proposed by Teece et al. (1997) as an extension of the RBV to explain how a firm creates and sustains a competitive advantage in dynamic and turbulence environments. The DC has proven to be a valuable theory in IS (Bradley 2002; Paul and Omar 2006, 2010; Shaker and Gerard 2002).

#### **2.2.2 IT governance and top management literature**

Governance of IT primarily deals with the effective use of IT (Wu et al. 2015) and usually falls under the responsibility of a firm's TM and board of directors (Turel et al. 2017). Drawing on IT governance and the RBV, Wu et al. (2015) developed a model that suggests IT governance mechanisms influence IS strategic alignment, which in turn influences organizational performance. The authors found "a positive, significant, and impactful linkage between IT governance mechanisms and strategic alignment and, further, between strategic alignment and organizational performance" (Wu et al. 2015 p. 497). Turel et al. (2017) studied the key determinants that help translate IT governance approaches by the board of directors into improved organisational performance. Drawing on two empirical studies, the authors found that "strategic alignment partially mediates the effect of board-level IT governance on performance" (p. 117).

## 2.3 Proposed Research Model

Drawing on the above discussion, the following research model was developed (see Figure 1):

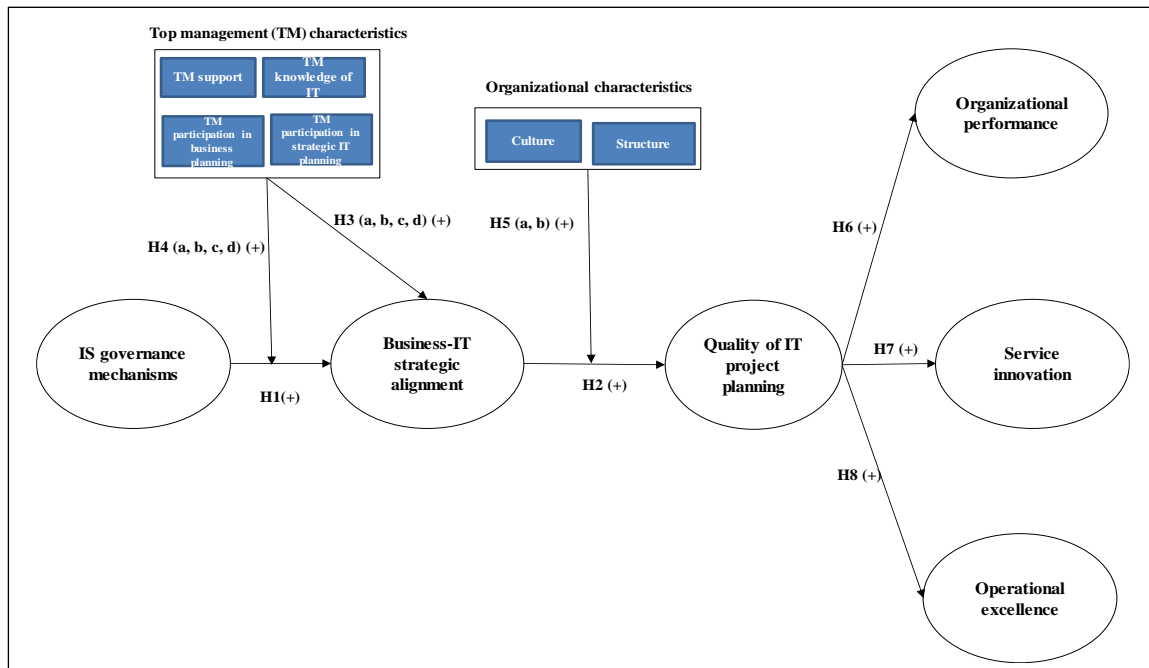

*Figure 1 The proposed research model*

In the proposed model, IT governance mechanisms influence IS strategic alignment, which in turn influences organizational performance (Wu et al. 2015). Therefore, the following two hypotheses have been formulated:

H1: IS governance mechanisms have a positive significant impact on Business-IT strategic alignment.

H2: Business-IT strategic alignment has a positive significant impact on the quality of IT project planning.

Research studies have also reported a relationship between IT governance practices (e.g. from TM and the board of directors) and IT project outcomes; for example Turel et al. (2017), and Kearns and Sabherwal (2006). To further examine the nature of this relationship, the following two hypotheses, each with four sub-divisions have been formulated:

H3a: TM support has a positive significant impact on Business-IT strategic alignment.

H3b: TM knowledge of IT has a positive significant impact on Business-IT strategic alignment.

H3c: TM participation in business planning has a positive significant impact on Business-IT strategic alignment.

H3d: TM participation in strategic planning has a positive significant impact on Business-IT strategic alignment.

H4a: TM support has a moderating effect on the relationship between IS governance mechanisms and Business-IT strategic alignment.

H4b: TM knowledge of IT has a moderating effect on the relationship between IS governance mechanisms and Business-IT strategic alignment.

H4c: TM participation in business planning has a moderating effect on the relationship between IS governance mechanisms and Business-IT strategic alignment.

H4d: TM participation in strategic planning has a moderating effect on the relationship between IS governance mechanisms and Business-IT strategic alignment.

Prior studies (e.g. Roberts et al. 2016) have reported the potential for organizational factors such as identity, culture, structure, and entrepreneurial orientation to impact the business value of IS. Drawing on these findings, the following hypotheses have been formulated:

H5a: Organisational culture will moderate the relationship between Business-IT strategic alignment and the quality of IT project planning.

H5b: Organisational structure will moderate the relationship between Business-IT strategic alignment and the quality of IT project planning.

Lastly, recent studies (e.g. Coltman et al. 2015; Wu et al. 2015) have also identified a correlation between factors related to Business-IT strategic alignment and organizational outcomes. Therefore, the following three hypotheses have been formulated in the context of Business-IT strategic alignments:

H6: The quality of IT project planning has a positive significant impact on organizational performance.

H7: The quality of IT project planning has a positive significant impact on service innovation.

H8: The quality of IT project planning has a positive significant impact on organizational operational excellence.

### 3 METHODOLOGY

The intent of this study is to understand and analyse key determinants of business value related to IT projects using a business/IT strategy alignment perspective in Saudi public-sector (government) organizations.. Focus in the examination is on Business-IT alignment maturity; namely, IT governance mechanism factors, TM characteristic factors, organizational characteristic factors and quality of IT project planning factors.

#### 3.1 Challenges to Enhancing Business-IT alignment in SA e-Government

The failure to leverage IS may significantly decrease a business' performance and feasibility (Besson and Rowe 2012). Furthermore, the absence of IT strategies amongst business goals and objectives is always associated with a lack of IT credibility and subsequent reduction in IT investment. Despite the importance of IT to achieving government milestones or business goals, many challenges hinder the attainment of Business-IT alignment ( Alaceva and Rusu 2015; Dent 2015). Governments tasked with providing services sometimes adopt high-end technologies for use in their systems and fail to make the necessary changes within the specific institutions to ensure that the system they have adopted is optimized. Moreover, many IT projects in businesses are fully directed by technology-driven IT organizations with a limited understanding of the actual needs of a business (Krotov 2015). In terms of SA, Shehry et al. (2011) has claimed that one of the most significant challenges to the SA e-government initiative is the lack of alignment between organizational goals and IT projects.

#### 3.2 Study Design

This study will adopt a mixed-methods approach (i.e. quantitative and qualitative research paradigms) to explore how Business-IT strategy alignment perspectives are deployed to examine the aspects of strategy alignment (see Figure 2).

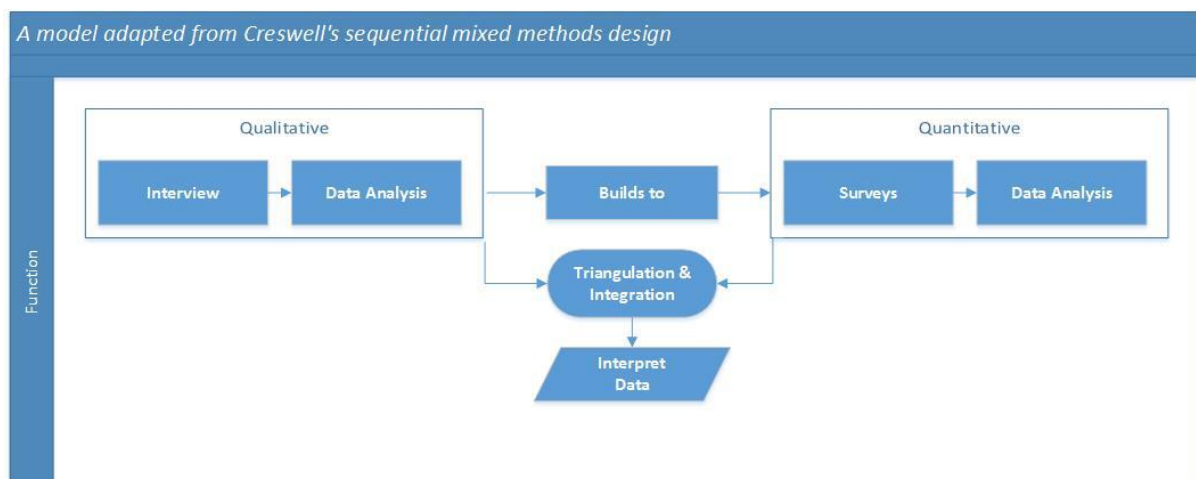

Figure 2 A model adapted from Creswell's (2013) sequential mixed methods design

The rationale for applying a mixed-methods design is to develop a deeper and inclusive understanding of the research phenomenon within the chosen population (Creswell, 2013). A sequential mixed-methods design will be used to explore the maturity level of alignment between business and IT. According to (Cooper et al., 2012), the proposed method provides the perfect opportunity to closely investigate all research aspects across multiple organisations. It also provides a deep level of understanding regarding the current situations and conditions of the research problem.

### **3.3 Expected Research Contribution**

#### **3.3.1 Theoretical contribution**

This study will contribute to our academic and practical understanding of Business-IT strategy alignment through an analysis of the main causal factors of IT and business alignment and how alignment impacts organizational performance. There has been limited research to date to examine IT/business strategy alignment, in public-sector organisations in developing countries. Thus, this empirical study of IT/business strategy in Saudi public-sector organisations will enhance the development of alignment avoidance models and theories to guide managers in their decision making on the organization's IT and business strategy alignment. Moreover, the proposed research model and the findings of this study may extend the theories of RBV and Dynamic Capabilities and can contribute to overall knowledge and to the literature

#### **3.3.2 Practical contribution**

This study will contribute to preliminary knowledge in the following areas: the factors influencing IT performance and alignment between IT strategy and business strategy; the operational measures utilised in organisations to promote alignment and avoid misalignment; and the perspectives of misalignment as revealed the relevant research and academic literature and its implications for organisational performance.

## **4 REFERENCES**

- Alaceva, C. and Rusu, L. 2015. "Barriers in Achieving Business/IT Alignment in a Large Swedish Company: What we have Learned?", *Computers in Human Behavior* (51), pp 715-728.
- Al-Barrak, K., Carr, L., & Ryan, M. (2016, September). Towards a Model for Monitoring Public Services Projects in Saudi Arabia. In 10th European Conference on Information Systems Management: ECISM 2016 (p. 1). Academic Conferences and publishing limited.
- Al-Khowaiter, W. A., Dwivedi, Y. K., & Williams, M. D. (2015). Examining the role of social influence, usefulness and ease of use for determining the mandatory use of a human resource information system in the context of Saudi Ministries. *International Journal of Electronic Government Research (IJEGR)*, 11(3), 24-42.
- Alsugiri, T., Al-Karaghoul, W., and Eldabi, T. 2013. "Alignment of Large Project Management Process to Business Strategy: A Review and Conceptual Framework," *Journal of Enterprise Information Management* (26:1), March, pp 596-615.
- Aversano, L., Grasso, C., and Tortorella, M. 2010 "Measuring the Alignment Between Business Processes and Software Systems: A Case Study," *Proceedings of the 2010 ACM Symposium on Applied Computing*, 2010. ACM, pp 2330-2336.
- Barney, J. 1991. "Firm Resources and Sustained Competitive Advantage," *Journal of Management* (17:1), March, pp 99-120.
- Besson, P., and Rowe, F. 2012. "Strategizing Information Systems-Enabled Organizational Transformation: A Transdisciplinary Review and New Directions," *The Journal of Strategic Information Systems* (21:2), June, pp 103-124.
- Bradley, C.W. 2002. "NEBIC: A Dynamic Capabilities Theory for Assessing Net-Enablement. *Information Systems Research* (125:2), June, pp 125-146.
- Cao, G., Duan, Y., Cadden, T., and Minocha, S. 2016. "Systemic Capabilities: The Source of IT Business Value," *Information Technology & People*, pp 556-567.
- Coltman, T., Tallon, P., Sharma, R., and Queiroz, M. 2015. "Strategic IT Alignment: Twenty-Five Years On. *Journal of Information Technology* (30:1), March pp 91-100.
- Cooper, H.E., Camic, P.M., Long, D.L., Panter, A.T., Rindskopf, D.E., and Sher, K.J. (Eds.) 2012. *APA Handbook of Research Methods in Psychology, Vol 2: Research Designs: Quantitative, Qualitative, Neuropsychological, and Biological*, Washington, DC, US: American Psychological Association.
- Creswell, J.W. 2013. *Research Design: Qualitative, Quantitative, and Mixed Methods Approaches* Thousand Oaks, CA: SAGE.

- Cui, T., Ye, H., Teo, H.H. & Li, J. 2015. "Information Technology and Open Innovation: A Strategic Alignment Perspective, *Information & Management* (52:3), April pp 348-358.
- Dent, A. 2015. "Aligning IT and Business Strategy: An Australian University Case Study *Journal of Higher Education Policy and Management* (37:5), September, pp 519-533.
- Dulipovici, A., and Robey, D. 2013. "Strategic Alignment and Misalignment of Knowledge Management Systems: A Social Representation Perspective *Journal of Management Information Systems* (29:4), April, pp 103-126.
- El-Telbany O., and Elragal A. 2014. "Business-Information Systems Strategies: A Focus on Misalignment," *Procedia Technology* (16:1), January, pp 250-262.
- Gerow, J.E., Grover, V., Thatcher, J.B., and Roth, P.L. 2014. "Looking Toward the Future of IT-Business Strategic Alignment through the Past: A Meta-Analysis," *MIS Quarterly* (38:4), December, pp 1159-1186.
- Gerow, J.E., Thatcher, J.B., and Grover, V. 2015. Six Types of IT-business Strategic Alignment: An Investigation of the Constructs and their Measurement," *European Journal of Information Systems* (24:5), September, pp 465-491.
- Kearns, G.S., and Sabherwal, R. 2006. Strategic Alignment Between Business and Information Technology: A Knowledge-Based View of Behaviors, Outcome, and Consequences," *Journal of Management Information Systems* (23:3), December, pp 129-162.
- Krotov, V. 2015. Bridging the CIO-CEO Gap It Takes Two to Tango, *Business Horizons* (58:1), pp275-283.
- Luftman, J., and Derksen, B. 2012. "Key Issues for IT Executives 2012: Doing More with Less," *MIS Quarterly Executive* (11:4), December, 1-15.
- Park, J., Lee, J.N., Lee, O.K.D., and Koo, Y. 2017. "Alignment Between Internal and External IT Governance and Its Effects on Distinctive Firm Performance: An Extended Resource-Based View," *IEEE Transactions on Engineering Management* (64:3), August, pp 351-364.
- Pavlou, P.A., and El Sawy, O.A. 2006. "From IT Leveraging Competence to Competitive Advantage in Turbulent Environments: The Case of New Product Development," *Information Systems Research* (17:3), December, pp 198-227.
- Ravichandran, T., Lertwongsatien, C., and Lertwongsatien, C. 2005. "Effect of Information Systems Resources and Capabilities on Firm Performance: A Resource-Based Perspective," *Journal of Management Information Systems* (21:3), April, pp 237-276.
- Reynolds, P., and Yetton, P. 2015. "Aligning Business and IT Strategies in Multi-Business Organizations. *Journal of Information Technology* (30:2), June, pp 101-118.
- Roberts, N., Campbell, D.E., and Vijayasarathy, L.R. 2016. "Using Information Systems to Sense Opportunities for Innovation: Integrating Postadoptive Use Behaviors with the Dynamic Managerial Capability Perspective," *Journal of Management Information Systems*(33:1), January, pp 45-69.
- Schniederjans, M., and Cao, Q. 2009. "Alignment of Operations Strategy, Information Strategic Orientation, and Performance: An Empirical Study," *International Journal of Production Research* (47:10), May, pp 2535-2563.
- Shehry, A.A., Rogerson, S., Fairweather, N.B., and Prior, M. 2009. "The Key Organisational Issues Affecting E-Government Adoption in Saudi Arabia," *International Journal of Electronic Government Research* (5:4), September, pp 1-13.
- Teece, D.J., Pisano, G., and Shuen, A. 1997. "Dynamic Capabilities and Strategic Management," *Strategic Management Journal* (18:7), August, pp 509-533.
- Turel, O., Liu, P., and Bart, C. 2017. "Board-Level Information Technology Governance Effects on Organizational Performance: The Roles of Strategic Alignment and Authoritarian Governance Style," *Information Systems Management* (34:1), June, pp 117-136.
- Venkatesh, V., Brown, S.A., and Sullivan, Y.W. 2016. "Guidelines for Conducting Mixed-Methods Research: An Extension and Illustration," *Journal of the Association for Information Systems* (17:7), July, pp 435-449.
- Wu, S.P.J., Straub, D.W., and Liang, T.P. 2015. "How Information Technology Governance Mechanisms and Strategic Alignment Influence Organizational Performance: Insights from a Matched Survey of Business and IT Managers," *MIS Q.* (39:2), June, pp 497-518.
- Zahra, S.A., and George, G. 2002. "The Net-Enabled Business Innovation Cycle and the Evolution of Dynamic Capabilities," *Information Systems Research* (13:2), June, pp 147-150.

**Copyright:** © 2018 Abdulaziz Al-Ghazi, Tingru Cui, Samuel Fosso, Mengxiang Li and Jun Shen. This is an open-access article distributed under the terms of the [Creative Commons Attribution-NonCommercial 3.0 Australia License](https://creativecommons.org/licenses/by-nc/3.0/australia/), which permits non-commercial use, distribution, and reproduction in any medium, provided the original author and ACIS are credited



## Title: Assessing the Determinants of Business Value Related to IT Projects: A Strategic Alignment Perspective of Public-Sector Organisations in Saudi Arabia

Reviewer 1 comments	Action	Response
<p>1. This paper reviewed various theoretical perspectives with regard to study of strategic alignment. However, there is no need to mentioned all of theoretical perspectives since they did not need all of them in the following arguments. For example, I did not see content about knowledge view.</p>	<p>Appreciate your recommendation. Done as recommended</p>	<p>The knowledge review content removed in response to the comment in the Theory Development section.</p>
<p>2. The hypothesis part looks like a mixture which just putting previous studies together, the authors did not mention how they apply resource based view and dynamic capability to develop their theoretical model. The authors argued that previous studies have validated the relationship so they could apply it again. In that case, what is the innovation part of this study? The model include various factors but the author did not have a unified perspective so I am wondering why they could investigate these factors together.</p>	<p>Thank you for your valuable comment.</p> <p>The way the hypotheses have been introduced have been rephrased in response to reviewer comment in the Theory Development (2) 'hypotheses' section</p>	<p>Research studies have also reported a relationship between IT governance practices (e.g. from TM and the board of directors) and IT project outcomes; for example, Turel et al. (2017), and Kearns and Sabherwal (2006)., To further examine the nature of this relationship, the following two hypotheses each with four sub-divisions have been formulated:</p>
<p>3. Methodology part looks great. But because of the arguments I mentioned before, I have little confidence in the implications as articulated by the authors. In summary, this paper has an interesting research question, but need to strengthen the motivation and theoretical novelty.</p>	<p>One paragraph added in response to this comment in the introduction part.</p>	<p>Indeed, the value of IT projects to Saudi public sector organisations is well established. Al-Khowaiter, Dwivedi and Williams (2015) for instance point to benefits of well-aligned business-IT goals related to enhanced competitiveness due to improvements in resource uses as well as more streamlined human resource management procedures. Indeed, the management of information is increasingly crucial to modern human resource function in public organisations (Al-Khowaiter et al., 2015). It is therefore not surprising that the "creation of agile public organisations (Saudi Government p. 64) is central to the National Transformation Program 2020 and the Kingdom's Vision 2030. Such agility emerges from improved operational efficiency, in which IT projects have a central role. It is for this reason that the</p>

			<p>Saudi governments has commitment to increase its investments in IT systems (Saudi Government n.d.). Public sector organisations in Saudi Arabia also recognise the value of IT projects to facilitate higher quality and more effective service delivery. New ICTs increasingly provide Saudi government organisations particularly with greater capacity of citizen engagement alongside more efficient operational outcomes. As Al-Barrak, Carr and Ryan (2016) state, the Saudi government “realises the enormous benefits” of ICTs and understands the importance of business-IT goal alignment in public sector organisations to its efforts to invigorate the public sector.</p>
<b>Reviewer 2 comments</b>	<b>Action</b>	<b>Response</b>	
<p>1. You try to consider all the determinants of business value related to IT projects in this study, including IS governance mechanisms, strategic alignment, quality of IT project planning, TM’s and organizational characteristics. By doing so, I am sure this research will take a significant progress. However, the research model is so complex that I am afraid of the reliability of the results. Although quantitative and qualitative methods will be considered, I still strongly suggest that more details should be design in the research, for example you’d better control other TM’s characteristics (e.g. experiences) and environmental factors.</p>	<p>Thanks, noted and will be considered modified</p>	<p>All will be considered when implemented the study and the following TM’s characteristics will be tested:</p> <ol style="list-style-type: none"> <li>1. Top managers’ knowledge of information technology</li> <li>2. Top managers’ participation in business planning</li> <li>3. Top managers’ participation in business planning</li> <li>4. Top management support</li> </ol> <p>And other factors related to IT Governance Mechanisms, innovation, Organizational structure and culture.</p>	
<p>2. It is easy to understand that business-IT strategic alignment will have a positive impact on IT project (not only planning, but also execution). Therefore, I suggest the author(s) explain why only quality of IT project is considered in the study. In addition, if the execution of IT project is controlled, it would be more credible</p>	<p>Many thank you for your valuable feedback and comments. We will consider this in our extended work.</p>		
<p>3. The relationships among TM’s participation in business planning, TM’s participation in strategic planning and alignment should be taken carefully. If the</p>	<p>Many thank you for your valuable feedback and comments. We will</p>		

<p>mission of business-IT strategic alignment is mainly executed by TM, it is a big challenge that you try to separate the activity of participation in business planning and participation in strategic planning. May it possible to be considered as one variable?</p>	<p>consider this in our extended work.</p>	
--	--	--

\*Note: pages 8, 9 and 10 will removed before publishing the paper.

# Information System resilience among Non-profits: Peak led collaboration as strategy for development

**Anushke Guneratne**

Department of Computing,  
Macquarie University,  
NSW 2109, Australia.  
Email: anushke.guneratne@hdr.mq.edu.au

## Abstract

Community legal centres (CLCs) are a special type of non-profit in Australia. These communities based organisations have operated in a considerably volatile funding environment. The funding limitations compounded by the relative size, and lightweight administration are a significant source of vulnerability which cannot be reduced by individual organisations. Their key strength is in community, engaging stakeholders and collaborating, which has helped CLCs continue functioning. This paper uses the development of a Customer Relationship Management system (CRM) by a peak body to investigate the notion that collaboration as a development strategy improves Information System development resilience. The strategic role of a peak body in relationship to its constituent organisations in the non-profit sector was found to be very important in creating system resilience.

**Keywords:** Non-profit, community legal centres, collaboration for resilience, Information System development, IT Strategy

## 1 Introduction

Non-profit organisations (NPOs) come in many forms. It is quite common for these organisations to not have a formal administrative structure. This means that there is a lack of planning organisational resilience or longevity (Helmig et al. 2004). However, the many roles and service by NPOs are invaluable to society. Resilience planning in NPOs is a challenge due to their very nature, but should be a topic of considerable importance due to their role in society.

Community legal centres (CLCs) in Australia are a special type of NPO. Despite being NPOs they have been formalised through years of existence and donor/funder conditions (Giddings and Noone 2004). There are over 200 CLCs located throughout Australia (National Association of Community Legal Centres 2018), both in rural and urban contexts. As a whole, CLCs receive the majority of their funding from the government. Reliance on a single funding source is a source of vulnerability. An example of this vulnerability was seen in 2017, where the National Association for Community Legal Centres (NACLC) had to rally CLCs nationwide to reach out to their stakeholder base to improve Commonwealth budget commitments.

This paper investigates the impact of technological change and resilience in the context of funding changes at CLCs. More specifically, it highlights the importance of collaboration and the role of peak bodies in shaping strategy for resilience in the CLC sector. The first section of the paper provides the background in which the collaboration took place. This is followed by a section which provides definitions and existing literature which underpins the research. This will be followed by the methods, case study, discussion and conclusion.

## 2 Background

Community Legal Centres New South Wales (CLCNSW) is the peak body for CLCs in NSW, and has a membership of 38 centres. These 38 members comprise of 18 generalist CLCs, 18 specialist CLCs and 2 associate members. A generalist CLC covers many areas of law and serves within a particular region, city or suburb, while a specialist CLC focuses on law relating to a specific area. CLCs are an important part of the Australian legal system, providing “individual legal advice and assistance as well as law reform, test case litigation, referrals and community legal education activities aimed at addressing systemic problems” (p.258 Giddings and Noone). Funding for these non-profits has been primarily from state and federal government.

Funding arrangements vary and has seen changes over the years. Giddings and Noone (2004) note that government policy changes have resulted in funding changes for CLCs. Some such changes disregard the need for CLCs to be connected to the community, and having a voluntary service. The impact of these funding changes resulted in 109 CLCs having to turn away 169,513 people due to lack of resources and capacity (National Association of Community Legal Centres 2017b).

CLCs are known to underutilize Information Technology (IT), relying on external contractors to oversee the maintenance of their IT infrastructure, neglecting its strategic use. An internal report commissioned by CLCNSW, recommends that the peak body take up strategic servicing of sector wide IT needs. The report concluded that IT uptake in the sector is deficient, recommending better IT and Information System (IS) services are desirable for improving the sector. CLCNSW has undertaken deployment of a key identified infrastructure project; developing a Customer Relationship Management (CRM) system. In the absence of strategic input at individual CLCs, the lead taken by CLCNSW builds resilience. The case study uses the CRM development project to highlight sector wide collaboration serving as a strategy for building IS resilience.

## 3 Literature review

### 3.1 Community organisations and the changing environment

Voluntary sector organisations (VSO) such as CLCs provide services and information to disadvantaged segments of community. Te'eni and Young (2003) especially note that in the network economy, non-profit organisations (NPO) are facing a broadening of their role in serving information needs. They base their assertion on the traditional excellence of NPOs in “facilitating transactions and creating relationships based on their information-related advantages (Te'eni and Young 2003) p.398”. CLCs are recorded to have arisen out of the need to correct the disadvantage of access to legal information, advice and representation (Giddings and Noone 2004). Giddings and Noone (2004) highlight that the establishment of CLCs was the result of a collective and activist approach which emphasised on social

reform, rather than a case by case individual approach, and was distinctive in the involvement of non-lawyers approaching legal problems in the context of all the needs of the disadvantaged. CLCs therefore clearly represent the type of information providing NPOs which are important to society.

A key feature of the CLC sector is the use of volunteers in the delivery of services. National Association for Community Legal Centres (NACLC) reports that in the 2016/17 financial year 6,773 volunteers at 112 CLCs contributed nearly 890,000 hours (National Association of Community Legal Centres 2017b). Since this is only from about half the CLCs in Australia, it is quite likely that actual hours will be close to double that number. Giddings and Noone (2004) highlights the same factors where a core of salaried experienced legal workers are able to provide oversight to volunteers, composed mostly of lawyers and law students, as a core effective strength.

Despite the importance of CLCs in society, the nature of VSOs makes them susceptible to changes in their operations. One of the dominant challenges is the nature of the administration present in CLCs, which Helmig et al. (2004) mentions as “amateur (p. 102)”. Identifying IT adoption Zorn et al. (2011) “suggest that NPOs adopting and using ICTs tended to be self-perceived leaders or those who [...] tended to have organizational decision makers with the expertise (p. 1)”. In the case of CLCs Giddings and Noone (2004) note that a distinguishing characteristic of the early CLCs from their private counterparts was the lack of formal organisation and administrative systems. This is an understandable characteristic considering the size of CLCs, where having a comprehensive administrative team in a small organisation would consume a significant amount of resources (Crump and Peter 2013). This means CLCs would find IS resilience to be a challenge.

There clearly is an opportunity for technology to assist CLCs in delivering better targeted information to more people.

### **3.2 Vulnerability sources for CLCs**

The nature of CLCs makes them inherently vulnerable to certain risks. The key vulnerability would be in funding, where a lack of long-term funding threatens operation and continuity. The second key vulnerability would be in weak administrative and management structures which can inhibit long term strategy.

Organisational resilience is achieved when an organisation is able to achieve its core objectives despite issues that crop up (Seville et al. 2006). However it should be noted that “organisations deal with uncertainties and unexpected events all the time [...] Above a certain scale however, crisis events differ from day-to-day management, in that organisations have to operate out of their comfort zone” (Seville et al. 2006). CLCs are unique, that even though they are independent organisations, they operate as a larger entity when facing crises, exemplified by the sector wide campaigns in 2017 (National Association of Community Legal Centres 2017a). This indicates that there is a precedent in the CLC sector in facing crises in a united manner, and successfully reducing the threat. i.e. that collaboration is used to create resilience.

### **3.3 NPO collaboration**

The CLC sector has a significant amount of collaboration. Guo and Acar (2005) researched into collaboration among non-profits, specifically looking into resource sufficiency, institutional factors and network effects and how it influenced collaboration. They found that formal collaboration takes place when organisations are older, receiving government funding, and has board linkages. The CLC sector bears all of the characteristics identified by Guo and Acar (2005).

The NSW Council of Social Services (NCOSS) studied possible models of access to shared services as well as possible challenges. A background paper prepared in 2008 identifies several drivers which are relevant to CLCs. It identifies government pressure to achieve economies of scale, increases in compliance costs, and skill and wage restrictions in hiring employees able to meet compliance needs as drivers for accessing shared services (NSW Council of Social Services 2008). Government “funding policies and practices [which] do not meet the full costs (administration/ infrastructure costs) of service delivery (NSW Council of Social Services 2008)” are already in place, which therefore restricts strategic capability (Giddings and Noone 2004). This provides incentive for strategic activity to take place in a shared manner.

Models of cooperation are also identified in the NCOSS (2008) paper. One of those identified is the peak body providing business centres. The benefits of this model are; the peak already having relationships with its constituent members, the peak body already providing services and therefore has a trust relationship established.

Considering the interest of funding bodies in improving or expanding services without increasing funds, the economies of scale required can be achieved in collaboration. Crump and Peter (2013) in their study found that administrative overheads for smaller organisations can be around 10-15% higher than large organisations, and that such organisations were willing to pay up to 5% of their budget towards shared services(Crump and Peter 2013). This creates a niche for shared services.

## 4 Methodology

The case study focuses on the question of whether CLCs are keen on improving their ability to reach stakeholders, with the assumption that this will have an effect on improving donations and also campaigning capabilities. It will rely on data gathered from a survey conducted to ascertain the feasibility, support and scope of developing a CRM. The willingness of CLCs to contribute or participate will be treated as a proxy to answer the research question: are CLCs collaborating to increase technology resilience.

The survey received 48 responses from 32 organisations, out of a total 40 organisations. In instances where individual CLCs had multiple respondents, the respondent answers were combined manually to arrive at a consolidated response where needed.

The case study was formulated from the author’s experience being part of both the technical and steering committees driving the project. Details of the project requirements and their formulation was gained from internal reports and discussions. The author is also employed in a technical capacity at a CLC, and has engaged in consulting across the CLC sector, which creates a general awareness of resourcing and other environmental factors common to the CLC sector.

## 5 Boot strapped IS development in the CLC sector

The CLCNSW project for a CRM for CLCs was funded by Legal Aid NSW through an administrative efficiencies grant. The case for developing this tool was drawn from a previous sector wide analysis (Table 1) which found a low overall technology maturity level in the sector. It was undertaken as collaboration between CLCNSW, the Tenants’ Union of NSW (TUNSW), and NACLCL. The TUNSW is a CLC, resourcing body for a state-wide tenants’ advice and advocacy program (TAAP), and a registered training organisation and has a dedicated IT and resourcing team which has experience developing systems for the TAAP network. NACLCL is the National body for CLCs, and has deployed a case management information system nationwide.

<b>Client and Stakeholder engagement</b>		
Supporter base	There is a critical and urgent need to find a solution to help CLCs effectively manage their supporters, and expand their supporters and donors.	CLCNSW is required to provide the Centre with some recommended options for managing supporters moving forward, as key stakeholders and also a source of funding/donations.

*Table 1: Recommendation for stakeholder engagement from sector wide IT audit (Community Legal Centres NSW 2016)*

Engagement of the wider CLC sector took place in the form of surveys and regular updates as well as workshops which took place during a quarterly event. Many CLCs were interested and keen on using a CRM to effectively manage their stakeholders, volunteers and campaign activities.

The main collaboration partners formed two groups: a steering committee which would look at policy, needs and provide feedback on overall features and direction, and a smaller technical working group which was comprised of the IT staff in who would provide technological recommendations to the steering group. A notable point of discussion in both groups was the structuring of data on a shared system to maintain privacy and confidentiality while providing better collaboration.

Early on, there was significant interest using open source products, or a system fully owned by the sector to prevent commercial capture. There was keenness to avoid off-the-shelf systems. This was partly driven by the sector’s experience with proprietary systems which did not receive updates for both security and compatibility, while also being difficult to customise or migrate away from.

The technical committee provided guidelines on infrastructure provisioning. The recommendations considered cost, security, on-going maintenance and scalability. Scalability was treated as non-critical as it would have a stable predictable user base.

### 5.1 Currently used tools

One measure of technological maturity at a CLC would be to look at existing systems and processes in place to communicate with key stakeholders. The responses to the tools being used were diverse. Since the project was for developing a CRM that would integrate many communication functions, Table 2 summarises the responses indicating which of the CLCs already use a CRM.

Question	CRM as response
How does your CLC manage volunteers?	2
How does your CLC manage and communicate with stakeholders?	2
How does your CLC manage interactions with media outlets?	0

Table 2: Total number of CLCs indicating current use of a CRM

For systems to manage volunteers, 30 respondents from 17 CLCs indicated that they have no system in place. Similarly, for using an online donation collection system, 13 respondents indicated that there was no collection while 10 used a non-integrated free platform targeted at NPOs. Stakeholder communication was better as 12 indicated that they were using a popular commercial campaign mailing tool. However, there were still 8 respondents who indicated that it was a manual system.

The results of the survey are not surprising as it reflects the findings of the IT audit report which concluded low technology maturity. The report strongly recommended CLCNSW develop these services. The report and its findings most importantly indicated a strategy gap as responsible for holding the sector back from developing better technology.

### 5.2 Stakeholder management using CRM

The project selected CiviCRM an open source CRM. The tight budget available required selecting primary features which will appeal to many CLCs. Consideration was given to the possibility of ‘seeding’ the development through contributions to the open source community. Despite the interest in this option, factors such as uncertain timelines and budget constraints resulted in selecting an older version as the base system. The features considered were: discussion forums, e-learning, volunteer/stakeholder management tools, event management tools, online donations/payment gateway, and adaptable website templates. The final priority features decided upon were the volunteer/stakeholder management tools and adaptable website templates.

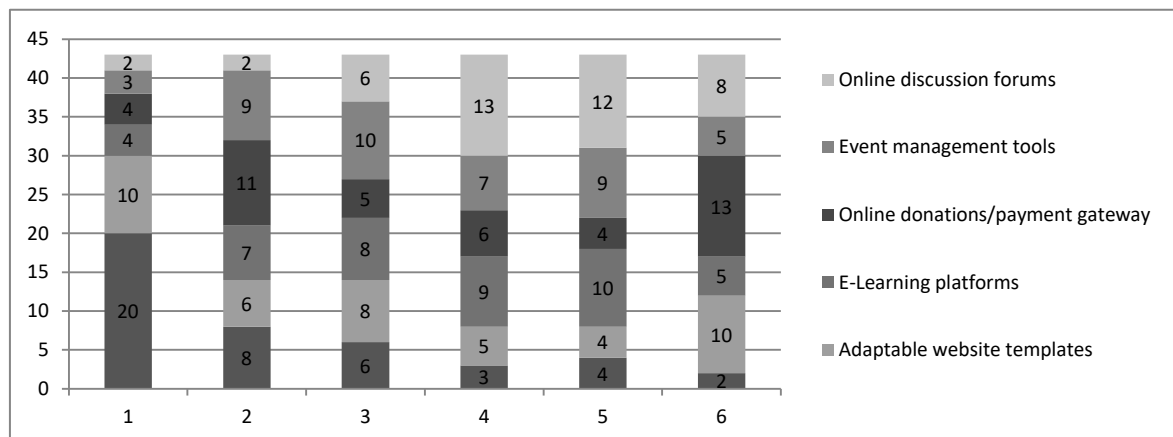

Figure 1: Feature ranking by user

The survey ranking the features provided insight into the diversity of the sector. There were only 43 responses from the 48 respondents for this question. The ranking of the features are summarised in Figure 1.

There was a lack of consensus on system priorities within a service, making it difficult to identify priorities. The survey did not expect CLCs to internally discuss and nominate their preferences. In instances where there were multiple respondents from the same CLC, a significant variation of priorities was seen. This diversity of responses from the sector and from within organisations point to the apparent strategic weakness which was identified common among VSOs.



The strategic gap can be filled by providing the correct resources. Since CLCs are unable to individually resource a person capable of providing strategic guidance, the role would seem likely to fall upon a trusted party with proven capability. As such CLCNSW had the proper credentials and connections to champion the project, while also being able to draw on the support of organisations with relevant experience.

### 5.3 Varied engagement levels

When responses were aggregated, of the 32 responding CLCs 14 indicated that they were interested in only information about the project and participating in surveys. This could be due to lack of resources. This indicates internal barriers or resistance to participating in technology development, i.e. internal barriers to technological resilience.

Answer for engagement willingness	No. of CLCs
Keep me up to date with what's going on	23
Happy to participate in online surveys	21
Keen to be more closely involved in the design	10
My CLC could pilot an aspect of the systems	13

*Table 3: Willingness of engagement aspects indicated by each CLC*

The levels of participation would likely be lower if the product was offered by a commercial entity, as has been the case for many CLCs. From anecdotal experience, a system which was offered as a cloud based solution resulted in lots failures during its operation over two years, primarily due to the lack of a technologically liaison. The service was not resilient in that aspect until a staff person was available to properly select a suitable system at a quarter of the cost, and has not had any major faults till now. Overall the willingness to collaborate shows the importance of trust relationships, and its role in forging a collaborative strategy.

## 6 Discussion

Due to funding limitations IT strategy is not prioritised, especially since the cost is believed to be not justified and better used in client services. My case study follows a peak organisations role in strategic IS development. Prior to the systems implementation, only manual or non-integrated systems were used. The project delivers an integrated solution, with the possibility for future extensions. Four CLCs are prepared to participate in the pilot stage. The on-going nature of the project is a drawback, as success or failure of implementation cannot be included for this study. However, CLCNSW as a peak body has managed to set up other strategic IT services, providing confidence that the CRM will also be successful.

One of the unique features of developing the CRM was the setting of project principles such as software selection requirements and the attempt to use sector based experience as much as possible. On-going financial requirements for the project are planned to be met through the monetization of completed components and other ICT services. This is possible due to the project being undertaken as part of a larger strategy allowing for a dedicated ICT staff position. This strategic approach and CLCNSWs past record indicates resilience in this collaborative approach. Furthermore, there was significant interest nationally with other peak bodies expressing their willingness to collaborate. This means that the developed system could have a larger user base creating financial viability for the IT services being offered.

Specifically, in regard to the project undertaken for NSW, the survey and sector level interest clearly indicates that while the project was needed, diversity can be a detriment to the project. In addition, the lack of resourcing both in general administrative and IT prevents a clear strategic direction for organisations individually and collectively. Such organisational diversity can only be moderated by a party that is trusted, which is why a state peak body such as CLCNSW has succeeded. The other smaller IT services which were offered as part of the larger program was quite successful.

Non-profit peak bodies have an important role to play in resourcing member organisations. In the development of the CRM, if each organisation had individually developed or contracted to develop a CRM or subscribed to an off the shelf service, it is quite likely that costs will be higher and the product unsatisfactory and fail to be resilient. In collaborating with the peak body, each organisation had an opportunity to participate while lowering overall costs for the entire sector.

## 7 Conclusion

The CLC sector is not composed of homogenous organisations. It was identified that strategic IT capacity to develop a CRM individually was lacking. The study found that in the non-profit sector, organisations limited by funding and unable to access strategic decision making, collaborated through a peak body and resiliently developed a system. However future research will be required to identify the long term success or failure of this specific project, and what influences that outcome.

In NSW, CLCNSW using a one of grant developed a viable CRM which is being rolled out. The development process, collaboration and relationships indicate a high level of trust between resource-strapped organisations. However, diversity among and within CLCs were brought to the surface, which makes the decision-making process complicated. Considering these dynamics, it is possible to outline recommendations which will help improve non-profit technological resilience.

Administrative overheads for employing dedicated staff for small organisations such as NPOs can be quite significant, while outsourcing can be inefficient. In light of this, it can be recommended that funders common to a sector can achieve better IS outcomes by creating a resourcing organisation or by better funding an existing peak body to provide relevant services and systems.

As a strategy resourcing through a peak body has many benefits. In this instance it lowered the cost of facing vulnerability. The collaboration created an overall improvement in technological resilience by creating a resource that was otherwise out of reach for small organisations. This indicates that non-profit sector collaboration can be a resilience strategy, and also indicates that peak organisations have a bigger role in developing resilience and addressing risk for entire sectors composed of small organisations.

## 8 References

- Community Legal Centres NSW. 2016. "Community Legal Centres NSW It Services Review Findings."
- Crump, B., and Peter, R. 2013. "A Case for Non-Profit Organisations to Engage in the Use of Shared Computing Services," *Electronic Journal of Information Systems Evaluation* (16:4), p. 270.
- Giddings, J., and Noone, M. A. 2004. "Australian Community Legal Centres Move into the Twenty-First Century," *International Journal of the Legal Profession* (11:3), pp. 257-282.
- Guo, C., and Acar, M. 2005. "Understanding Collaboration among Nonprofit Organizations: Combining Resource Dependency, Institutional, and Network Perspectives," *Nonprofit and voluntary sector quarterly* (34:3), pp. 340-361.
- Helmig, B., Jegers, M., and Lapsley, I. 2004. "Challenges in Managing Nonprofit Organizations: A Research Overview," *Voluntas: International Journal of Voluntary and Nonprofit Organizations* (15:2), pp. 101-116.
- National Association of Community Legal Centres. 2017a. "Annual Report 2016-2017." Retrieved 14/06/2018, from <http://www.naclc.org.au/resources/2017-10-30-NACLCL-Annual-Report-final-web.pdf>
- National Association of Community Legal Centres. 2017b. "National Census of Community Legal Centres 2016 National Report." Retrieved 10/06/2018, from <http://www.naclc.org.au/resources/NACLCL%20Census%202016%20National%20Report%20-%20FINAL.pdf>
- National Association of Community Legal Centres. 2018. "Find a CLC." Retrieved 14/06/2018, from [http://www.naclc.org.au/clc\\_directory.php](http://www.naclc.org.au/clc_directory.php)
- NSW Council of Social Services. 2008. "Shared Services in the Ngo Sector Background Paper." from [https://www.ncoss.org.au/sites/default/files/public/SharedServices\\_NGO.pdf](https://www.ncoss.org.au/sites/default/files/public/SharedServices_NGO.pdf)
- Seville, E., Brunsdon, D., Dantas, A., Le Masurier, J., Wilkinson, S., and Vargo, J. 2006. "Building Organisational Resilience: A New Zealand Approach," *Resilient Organisations Research Programme. Disponível em: www.resorgs.org.nz*.
- Te'eni, D., and Young, D. R. 2003. "The Changing Role of Nonprofits in the Network Economy," *Nonprofit and Voluntary Sector Quarterly* (32:3), pp. 397-414.
- Zorn, T. E., Flanagan, A. J., and Shoham, M. D. 2011. "Institutional and Noninstitutional Influences on Information and Communication Technology Adoption and Use among Nonprofit Organizations," *Human Communication Research* (37:1), pp. 1-33.

## Acknowledgements

The author thanks CLCNSW for allowing access to the development project for research use and the Tenants' Union of NSW for facilitating the use of resources to complete the paper. The author acknowledges the support of his family, and guidance of his supervisor Stephen Smith.

**Copyright:** © 2018 Anushke Guneratne. This is an open-access article distributed under the terms of the [Creative Commons Attribution-NonCommercial 3.0 Australia License](https://creativecommons.org/licenses/by-nc/3.0/australia/), which permits non-commercial use, distribution, and reproduction in any medium, provided the original author and ACIS are credited.

# Strategic Resilience: A Case of Collaborative Exploration of Land-use Planning and Total Defence

**Christofer Tolis**

Combitech AB  
Gustavslundsvägen 42, 3 tr  
SE-167 51 Bromma  
Sweden  
Email: christofer.tolis@combitech.se

## Abstract

Strategic resilience concerns broad societal issues and long-term processes to successfully handle severe disturbances such as crises and war. This paper presents a case study of a Swedish exploration project to investigate how civil defence interests may influence land-use planning through legislation on national interests. The project brought together two disparate areas and involved collaborative exploration through representatives from both communities. Through a large workshop, representatives from a number of governmental agencies came together to develop and discuss examples of national interests for civil defence. Continued work following the workshop revealed five key questions, each contributing towards a shared understanding of specific possibilities and limitations. The questions concerned issues of boundaries, contents, importance, location, and value, thereby providing input to a proposed sector description to be used when deciding whether to start handling actual national interest claims for civil defence or not. Through the work reported, the paper illustrates recurring challenges with handling divergent and shared meanings, balancing of logical and physical aspects, and bridging of means and ends in collaborative exploration.

**Keywords** Collaborative exploration, Civil defence, National interests.

## 1 Introduction

How our society use its resources and how we defend it are two areas of concern for many people. Not only professionals in each area, but also ordinary people care about their living environment and their safety. Despite different challenges and possibilities within the two areas, they can be seen to meet in the concept of resilience, especially from a large-scale and long-term strategic perspective. Resilience is commonly used to describe a wide range of complex systems (cf. Nelson et.al. 2007) and has been applied to for example individuals, organisations, and nations. Distinguishing between “stability” and “resilience”, Holling (1973) describes the latter property as “a measure of the persistence of systems and of their ability to absorb change and disturbances and still maintain the same relationships between populations or state variables” (ibid., p. 14).

But how can the relationship between land-use planning and total defence work in practice, influencing strategic resilience? And how can this relationship be explored to collectively identify challenges and develop possibilities? Although allowances in Swedish law for letting both military and civil defence interests influence land-use planning have existed for some thirty years, these provisions have so far only been utilised by the military side. A legal framework of so-called national interests provides the possibility of taking into account also the civil side of total defence, along with a number of other sectors such as communications, cultural heritage, and industrial development (SFS 1998:808).

### 1.1 Focus of paper

In early 2017, the Swedish Civil Contingencies Agency procured an exploration project to be performed by a large consulting company. The company agreed to the task of developing a proposal for a so called sector description for the agency to use in deciding whether or not to begin utilising the national interest legislation for civil defence.

This paper documents the design, execution, results and experiences of the project in the form of a case study (cf. Yin 2003). It covers the period from April to September 2017, when the work was performed by the author together with a consultant colleague and two representatives for the Swedish Civil Contingencies Agency. The aim of the paper is to provide insights for those involved in land-use planning and total defence, as well as researchers interested in the collaborative exploration. The content of this paper represents the experiences of the author and does not necessarily correspond to the views of the agency.

From a practical perspective, this work highlights issues of collaboratively working to define a joint domain of concern that brings together two disparate areas. It provides experiences and insights into the exploration of needs and solutions. It also enables results of interest for each area individually. From a theoretical perspective, the work identifies main challenges relevant to collaborative exploration efforts. It provides the opportunity to further the understanding of joint development across organisational and community boundaries by gradually utilising ideas from knowledge management, business development, and information systems development.

### 1.2 Methodology and structure

From a methodological point-of-view, the work undertaken has been driven by explicit requirements to practically support the agency in reaching the outcomes desired. Following this, the author has employed a clinical perspective of helping the client (Schein 1987), focusing on the issues at hand rather than applying a prescribed method or framework. The work can thus be seen as mainly empirically driven, based on a specific context and organisational setting. Instead of starting from theoretically derived propositions, the work has been guided by a bottom-up grounded theory-like approach (Glaser and Strauss 1967). Given the explorative character of the project, practical relevance has been stressed over theoretical rigor (cf. Keen 1991).

All this has consequences for the content of the paper. To provide as rich insights as possible, the majority of the references used are the ones that directly appeared in the exploration project. A limited set of additional references have been added after the completion of the project, mostly in order to set the stage in this introduction and to illustrate the theoretical underpinnings influencing the work and the conclusions.

Following this introduction, the remainder of the paper is structured in four main sections: background, workshop results, key questions, and conclusions.

## 2 Background

Because the project brings together two areas, land-use planning and total defence, this section gives a background to each. Based on the larger context, the specific issues of each area are highlighted to set the stage for the project and its results.

### 2.1 Land-use planning and national interests

Planning the future of a society has many contributing aspects. A key aspect is land-use planning, dealing with how we best make use of available land and water. The physical environment is shaped through various plans and ultimately decisions on different levels. Legislation provides the legal basis for handling different interests in the planning process, prescribing principles, activities and documents.

How a specific piece of land or water is being used over time is influenced by a number of planning decisions. These are governed by a range of laws regarding the development of facilities such as houses, roads, railways, airports, pipelines for natural gas, high-voltage electricity cables, etc. The particular regulations for each type of facility are guided by references to more overarching values and principles contained in the so called Environmental code (SFS 1998:808), Sweden's core legislation in the environmental area.

As one means of balancing individual interests, the Environmental code details the concept of national interests. National interests are specified in two forms, both as particular geographic areas and as particular types of activities that may need protection. In total, there are twelve activity types that are candidates for national interests, and for each of them one or two governmental agencies are nominated for providing relevant information within their areas of responsibility (SFS 1998:896), as shown in table 1 below.

National interest	Governmental agency
Reindeer herding	Sami Parliament
Professional fishing	Swedish Agency for Marine and Water Management
Natural heritage and outdoor life	Swedish Environmental Protection Agency and Swedish Agency for Marine and Water Management
Cultural heritage	Swedish National Heritage Board
Geological prospecting	Geological Survey of Sweden
Industrial production	Swedish Agency for Economic and Regional Growth
Energy production and distribution	Swedish Energy Agency
Nuclear waste deposition	Swedish Radiation Safety Authority
Communications	Swedish Transport Administration and Swedish Post and Telecom Authority
Waste management	Swedish Environmental Protection Agency
Water supply	Swedish Agency for Marine and Water Management
Total defence	Swedish Armed Forces and Swedish Civil Contingencies Agency

*Table 1. Overview of legislated types of national interests with nominated actors*

The governmental agency responsible for overseeing the whole national interest system is the National Board of Housing, Building and Planning, and they interact with each of the national interest agencies for each societal sector (Boverket 2013). Specifically, for the total defence sector, the legislation prescribes that "Land and water areas of relevance for total defence shall as far as possible be protected from actions that significantly may counteract total defence interests. Areas that are of national interest because they are needed for total defence facilities shall be protected from actions that significantly may hinder the creation or use of the facilities" (SFS 1998:808, 3 chapter 9 §).

## 2.2 Total defence and civil defence

For the last couple of years, the focus of defence issues in Sweden has increased. Beside the military side, this has meant a renewal of interest also for civil defence; the two together comprising what is known as total defence. According to relevant law, “Total defence are activities needed to prepare Sweden for war. To strengthen the defence capability of the country, the alert level can be heightened. Heightened alert is either high alert or highest alert. During highest alert, total defence is all societal activities that are to be performed. Total defence comprises military activities (military defence) and civil activities (civil defence)” (SFS 1992:1403, 1 §).

The goal of civil defence consists of three mutually reinforcing parts: “Protect the civilian population, ensure the most important societal functions, and contribute to the Swedish Armed Forces’ capability during an armed attack or war in our surroundings” (Försvarsdepartementet 2015a, page 59). Rather than being linked to any particular organisation, civil defence focuses on activities that ultimately affect most actors in society. Therefore, the term “civil defence” can be seen as a shorthand for the “total defence’s civil parts”, and these two expressions are used as synonyms in the following.

To emphasise the importance of civil defence, and the interaction with military defence, the Swedish government in 2015 decided to reinstate an overall total defence planning (Försvarsdepartementet 2015b). Various assignments (Justitiedepartementet 2015; Försvarsdepartementet 2017) have thereafter been given to the two main governmental organisations involved in military and civil defence, respectively, i.e. the Swedish Armed Forces and the Swedish Civil Contingencies Agency.

## 3 Workshop results

An important part of the project was to arrange a larger workshop where participants concerned with national interest and civil defence could contribute. The idea was both to communicate the work currently underway, and to get input from the participants to delimit and characterise the sector.

Invitations were sent to a number of governmental agencies and County Administrative Boards across Sweden. The participants were divided into five different groups, each comprising around 6-7 people representing their organisations. The background of the participants varied; some worked primarily with land-use planning whereas others had a focus on security and defence.

A key task during the workshop was to have the participants discussing possible examples of national interests for civil defence. The group were asked to come up with examples, and for each example outline four aspects to describe it: Activity, Facility, Area, and Needs. Activity concerned the operations that the facility contributes to, whereas Facility concerned the type of construction used in the activity. Area concerned land or water area of importance, and Needs the reasons why the area is needed. A total of 14 examples were generated by the participants collaborating in their groups, as shown in table 2 below.

	Activity	Facility	Area	Needs
1	Transportation, supply	Harbour	Whole/parts of harbour area (land and water), depots	Protection, transportation
2	Lab analyses, CBRNE	Research facility	Perimeter	Transportation, protection
3	Water supply	Desalination plant	Production and distribution area	Water intake, transportation, energy supply, protection
4	Fuel supply	Harbour, depot, refinery, truck & road, filling station	Harbour area, depot area	Fulfil goals of civil defence
5	Tele communications	Important communication facility	Underground shelter	
6	Management, communication, collaboration	Command and control site and communications		Manage civil defence, support to Armed Forces

7	Supply	Harbour		Distribution, related civil defence, Armed Forces' conditions, societal conditions
8	Emergency healthcare	Emergency hospital and university hospital	Buildings and surrounding land areas (above and below ground)	Access, supply, logistics
9	Electricity supply	National, regional and local grid with nodes and control centres	Areas in direct proximity to the facilities	Physical protection of facilities
10	Protection of population during air raids	Shelters	Current shelters with room for expansion, areas for new shelters	Existing shelters, proper use, maintain physical protection
11	Coordination of operations	Command and control site	Small physical area	Communication system (e.g. Tetra-based), electricity
12	Supply	Bridge	Small area (height above / deep beneath)	Ensure communications
13	Fuel supply and storage	Depot	Large areas	Transportation, fuel for backup power
14	Electricity production	Nuclear plant	Land, water	Transportation, cooling, protection, electricity

Table 2. Overview of examples produced by the participants of the workshop

## 4 Key questions

As described in the previous sections, material from the workshop was collected and analysed to get closer to a general sector description of National interest for civil defence, together with clarifying criteria to support the identification and evaluation of specific candidates. However, a gap in perspective was identified during a quest to attract participants for a second – this time internal – workshop targeted at employees of the agency having a focus on civil defence. The realisation was that much of the communication in the project, as well as the sector description and criteria themselves, might be of a larger interest to the land-use planning community than that of civil defence.

To close this gap, an extra step of analysis was inserted in order to form and address key questions of value for the civil defence community. This could be seen as an exercise in perspective switching, moving from the perspective of the solution (national interest) to the perspective of the need (civil defence). A total of five key questions were created from literature and workshop material and then answered. In addition to attracting the people interested in civil defence, the belief was also that the key questions, together with their answers, would contribute to a more usable sector description and corresponding criteria.

In an analysis best characterised as abductive (cf. Fann 1970), rather than purely deductive or inductive, the set of questions was arrived at after repeatedly going back and forth between the contexts of national interests and civil defence. The five questions eventually formed around the boundaries of civil defence, the contents of civil defence, the idea of national-level importance, the meaning of location and confinement, and the value of national interest for civil defence. Each question is addressed in a separate sub section below.

### 4.1 Boundaries of civil defence

What “civil defence” is, and what it is not, is a key question for the successful application of the legislation of national interests. It is also important for people interested in the area, as well as the general public, especially following the increased attention over the last couple of years. How to delimit and define a widely used term such as civil defence is seldom uncontested, and there can be reasons for the boundaries to be kept a bit vague, flexible and wide-ranging. Nevertheless, a shared awareness of the basic



boundaries towards other areas is particularly helpful when people from different work practices and knowledge communities need to work together.

In defining civil defence, the initial focus will be on the second, main, part of the term and the boundary towards non-defence. "Defence" is used in different circumstances, and common dictionaries defines it along the lines of "the act or action of defending", with "defend" meaning "to drive danger or attack away from" (Merriam-Webster n.d.). Hence, defence imply activities where somebody/something (the defender) defends somebody/something (the defendee) against somebody/something (the danger or attack). In practical use, "defence" often also covers related activities of preventing, planning, evaluating, improving, etc, the actual moments of defending.

Analysing the broad range of activities that the term "defence" applies to, they can be projected along several dimensions. Most notable, this includes differences in scope and severity, and also whether the defence is aimed at somebody's attack or something dangerous. Examples include an attack from foreign armed forces, a terrorist or a robber. Or the dangers of a pandemic, a flooding, or a domestic fire. Partially because of the association of the term "defence" with specific organisations in most countries that represent some kind of armed defence forces, defence against foreign armed forces are often seen as more prototypical than defence against for example a domestic fire. As seen earlier, this is mirrored in the legislation for Sweden's total defence where the first sentence read "Total defence are activities needed to prepare Sweden for war" (SFS 1992:1403).

As there are no clear-cut boundaries between "defence" and for example "protection" and "preparedness" the differences towards related terms are sometimes more of difference in degree than a difference in kind. The rough boundary implied by the legislation seem to be contextual and hinge on the societal situation, so that actual moments of defending only happens in situations of heightened alert, but that related activities of preventing, planning, evaluating, improving the defence may and should happen also in other situations. In the planning of the civil defence, the government noted that "it is important that lessons learned and resources from accident protection and emergency preparedness also are used for planning the civil defence. In several respects, the goal for emergency preparedness is matched by the goal for civil defence. However, the government believes that civil defence requires additional activities that have not been deemed necessary for emergency preparedness. This could for example include demands for certain protection activities, certain important society functions, and that scarce resources can be distributed to prioritised activities in heightened alert" (Försvarsdepartementet 2015a, page 60).

Turning to the first part of the term "civil defence", it is now possible to discuss the boundary towards other forms of defence, thereby further clarifying the delimitations of total defence's civil parts. Potentially, the prefix "civil" could be used as a delimiter in each of the three different aspects of defence identified above: regarding either the defender, the defendee, or the danger/attack. Going back to the underlying legislation, where civil defence was described alongside military defence as the two parts comprising total defence (SFS 1992:1403), it is clear that the prefix is in fact a delimitation focusing on the first of these dimensions, distinguishing a certain type of defender. Military defence is hence performed by armed forces whereas civil defence is performed by other, non-military, actors. The distinction between armed forces and civilians is defined in the Geneva Convention, especially protocol 1 (United Nations 1977). However, please note that in the Geneva Convention, "civil" in "civil defence" is primarily used as a delimitation of the defendee, i.e. what is being defended, rather than of the defender.

Notwithstanding the above, in the legislative context of national interests the precise division between civil and military defence is of no real significance as all of total defence is included, but rather a practical matter in terms of division of labour between different governmental organisations. For example, in the current claims for national interests for total defence, the Swedish Armed Forces states that "In the concept military defence, also civil agencies within the defence sector are included, such as the Swedish Defence Research Agency, the National Defence Radio Establishment, and Swedish Defence Materiel Administration, whose interests the Swedish Armed forces represents" (Försvarsmakten 2015, page 4). Moreover, the Swedish Armed Forces also handles national interest claims regarding weather radar stations owned by Swedish Meteorological and Hydrological Institute, something that could change if Swedish Civil Contingencies Agency were to begin handling civil defence national interests in the future.

## 4.2 Contents of civil defence

Whereas the first question about delimitation looked at civil defence more or less as a black box, the question of content opens up the box to look at its constituents. In the same way as an extensional definition complements an intensional definition, exploring the contents of civil defence can be as valu-

able as defining its boundaries. Irrespectively of whether the exploration of content is aiming for a complete list, or only a list of examples, the result can be helpful not only for finding and/or evaluating specific proposals for national interests, but also for understanding and developing civil defence for a wider audience.

Different things that can be found within the boundaries of civil defence, and these can be divided in different ways. Because civil defence is ultimately about activities performed, focusing on the ways these activities are characterised and grouped will add to the insights into the contents of civil defence. As stated by the Swedish government, “Civil defence consists of activities that responsible actors performs to make it possible for society to deal with situations of heightened alert. Civil defence is therefore not an organisation. The activities are performed by governmental agencies, municipalities, counties, private businesses, and voluntary organizations” (Försvarsdepartementet 2015a, page 12).

We will use the goal of Swedish civil defence mentioned earlier as a starting point, using its three parts. The first part, “protect the civilian population”, has been the traditional focus of civil defence after World War II. As noted above, the Geneva Convention embody this notion when it presents a list of specific tasks following the statement that “civil defence” means “the performance of some or all of the undermentioned humanitarian tasks intended to protect the civilian population against the dangers, and to help it to recover from the immediate effects, of hostilities or disasters and also to provide the conditions necessary for its survival” (United Nations 1977).

The second part of the goal, “ensure the most important societal functions”, focus on the workings of society to make sure that its key activities are operating also in difficult times. In 2010, the Swedish government commissioned the Swedish Civil Contingencies Agency to develop a strategy for the protection of vital societal functions (MSB 2011). In the strategy, “a vital societal function is defined as a function of such importance that its loss or severe disruption to it could entail major risks or hazards for the life and health of the population, the functionality of society or society’s fundamental values” (MSB 2011, page 10). A total of 11 societal sectors, in which vital societal functions may be found, were identified: Energy supply; Financial services; Foodstuffs; Health, medical and care services; Information and communication; Public administration – management; Safety and security; Social insurance; Technical municipal services; Trade and industry; and Transport (MSB 2011, page 21).

The third and final part of the goal, “contribute to the Swedish Armed Forces’ capability during an armed attack or war in our surroundings”, focus on areas where civil defence may support the military defence in certain circumstances. Relevant areas may of course vary over time, but some have been stated by the Government: “For example, transportation and logistics, supply of food, fuel, electricity and telecommunications, and access to healthcare resources will make up special needs for the military defence” (Försvarsdepartementet 2015a, page 108).

Cooperation area	Societal sector (approximate match only)	Protect civilians	Ensure society	Contribute capability
Hazardous substances	Protection, safety and security	X	X	
Protection, rescue and care	Health, medical and care services	X	X	X
Economic security	Financial services Social security Trade & industry		X	
Geographic responsibility	Public administration		X	
Technical infrastructure	Energy supply Information and communication Municipal technical services Foodstuffs		X	X
Transportation	Transport		X	X

Table 3. Overview of contents of civil defence based on cooperation areas

Having looked at each of the parts of the goal for civil defence, we can now turn to how relevant legislation structures the actual work. In addition to the provisions given to a number of governmental agencies, assigned as “responsible for monitoring”, a set of six different cooperation areas are used, where each of these agencies participate in one or more areas. The areas are Hazardous substances; Protection, rescue and care; Economic security; Geographic responsibility; Technical infrastructure; and Transportation (SFS 2015:1052). The legislation states that “In order to facilitate a holistic view in the planning for emergency preparedness and heightened alert, the planning for agencies listed in the appendix to this ordinance should be performed within cooperation areas” (SFS 2015:1052, 7 §).

Table 3 above shows the contents of civil defence in terms of the six cooperation areas, alongside the societal sector(s) most closely matching, and the part(s) of the goal aimed at. Although precise delimitations are not strictly needed for working with national interests, the areas outlined contribute to make civil defence more concrete when identifying and evaluating claims for national interests.

### **4.3 Importance on a national level**

One cornerstone of the general system of national interests is the idea that certain areas of the country are important on a national level. For civil defence, the importance of a geographical area is largely linked to the facilities that may be created or used on that location. Depending on how easy it is to qualify for an interest to be important on a national level, the number of claims for national interests can be expected to range from very few to an endless number.

The governmental agency responsible for the national interest system – National Board of Housing, Building and Planning – outlines three general criteria for something being of national interest: large national value, committed internationally, or nationally important structures (Ryding 2017). Whereas the first and last case could be said to concern what is directly important to the population, the middle case concerns requirements to fulfil commitments the nation has made to other countries, thereby concerning the population more indirectly.

Looking more closely at the first case, this can be seen as the prototypical example of when something is of important on a national level. This represent the case when there are no, or only a few, alternatives available to something of value to the population. Examples could include the place where the national parliament resides, or a rocket launching range. Here the whole population, or a large portion thereof, could be said to be reliant on the specific area and its facilities.

The third case opens up the possibility that something can be of national importance by virtue of being part of a larger structure. As noted by the representative of the Swedish Civil Contingencies Agency in this project, there are three different alternatives when also parts can be of national importance. One alternative concerns parts of physical infrastructures, for example a railroad station. The other alternative concerns parts of information infrastructures, for example a communication tower. The final alternative concerns decentralised parts with multiple forms of interaction among them, for example a hospital.

Although a specific part of a larger structure in itself may not be of value to the whole population, or a large portion thereof, its demise may have significant repercussions on a larger scale and thereby making it important also on a national level. In the context of national interests, this will perhaps require a bit more judgement compared to the first two cases where the direct or indirect value to a large portion of the population might be easier to establish.

### **4.4 Location and confinement for civil defence**

When working with national interests, the question is not only if something is important on a national level, but also how confined and dependent it is on the particular location. Because national interests deals with specific areas of land and water, a key question is what this means for the activities being performed, whether it is the place for the national parliament or a hospital. Basically, the easier it is to move a civil defence activity to another location, the weaker the argument is to judge its current location as an area of national interest.

In general, an activity can be more or less confined to a specific location. For example, it is easier to perform mental calculations in various locations than it is to launch a rocket into space. The main difference lies in the materials and surroundings needed to perform the activity. While some material is easy to move to another location, other is more permanently fixed. Prime examples of the latter are buildings, factories and infrastructure – hence the recurring focus on facilities in the context of national interests.

Compare the situations of performing healthcare at a fixed emergency hospital and at a mobile field hospital. Whereas the former requires considerable time, energy and money to move, the latter is less confined to its current location and can easier be moved to a different place. In addition to the confinement due to the facilities and materials, the issue of surroundings can be equally challenging. Even if the time, energy and money to move can be mustered, there might be few, if any, alternative locations available. The same applies to cases of future facilities, where forthcoming civil defence activities may require new facilities in certain locations.

#### **4.5 Value of national interest for civil defence**

The final key question concerns when national interest is of value for civil defence. As with all tools, their value depends on the specific context and the needs within that context. For people engaged in civil defence, this means realising the specific advantages that national interest might have on the activities and goal of civil defence. But equally important, to understand the limitations, and possible drawbacks, of national interest in the context of civil defence.

As described in this paper, the legislation for national interests is designed to influence the individual decisions made to change the utilisation of land and water. Whether related to a building permit for a new house, or the concession for a new highway, the decision makers are obliged to take existing national interests into account when making their decisions. For the Swedish Civil Contingencies Agency to take up the role of responsible for national interests for civil defence, there has to be enough advantages to top possible disadvantages.

Starting with the pros, one advantage is that national interests might make future expansions easier for civil defence in existing locations. Or that additional facilities might become easier to establish in new locations. Another advantage is that national interests might make reduce the limitations posed on civil defence activities by changes in the surrounding environment. Or that the activities eventually become so negatively affected that the only alternative is for them to have to move. A third advantage is that national interests provides an opportunity for civil defence to examine and possibly rethink its activities and use of facilities. Exploring the conditions of national importance and confinement to specific locations, might yield important insights also when a possible claim for national interest turn out not to be applicable or beneficial.

A possible disadvantage is that claims for national interests are tested anew in each decision, which means that there are no guarantees that they will prevail every time. Although national interests for civil defence carry more weight than other national interests, much of the outcome hinges on how well the interest is motivated. Another possible disadvantage is that the whole system of national interests is designed for transparency and openness. Although the Swedish Armed Forces have devised procedures for also handling secret facilities, the basic premise of national interests is that of non-secrecy.

### **5 Conclusions**

In the project conducted, material for a sector description, together with accompanying criteria, have been developed. This was done through existing literature, a workshop with a large number of invited representatives for different governmental agencies, and recurring discussions within the project group. Putting the different fragments together yielded a proposed sector description along the following lines:

“Civil defence comprises defence-related activities performed by civil actors during, and in preparation for, heightened alert. The activities are pertinent to the goal of civil defence, and are relevant for at least one of the cooperation areas for emergency preparedness and heightened alert. In cases where the activities are dependent on facilities and equipment not easily relocated, and they are directly or indirectly important for a significant portion of Sweden’s population, appropriate areas of land or water are candidates for national interests for civil defence”.

This paper has shown how data from two disparate areas have been used in a collaborative exploration effort to facilitate upcoming decisions and strengthen strategic resilience. These decisions include both the general one, whether to start handling actual national interest claims for civil defence, and if so, the specific decisions dealing with individual claims. In addition to the Swedish Civil Contingencies Agency, this collaboration also involves the other actors being represented at the reported workshop, since a successful solution will depend on the participation of a range of different actors. Although the sector description being evolved will embody a condensed version of the knowledge gained, many of the benefits with the project have to do with the underlying work to build a shared understanding between the two areas of land-use planning and total defence.

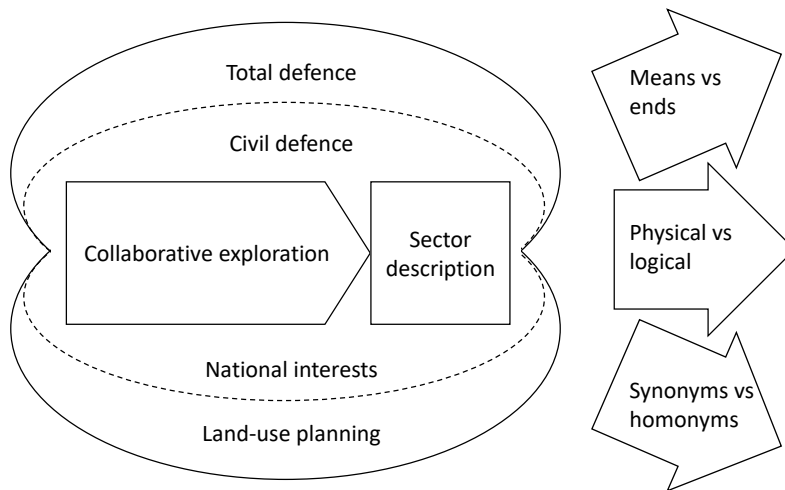

Fig. 1. Specific and general results of the project.

As summarised by Figure 1, the paper has also provided more general insights into critical challenges arising in collaborative exploration efforts. First, this include challenges of sense-making (Weick 1979), with divergent meanings of common words used in both contexts, for example the notion of “protection”. In the context of civil defence, protection is primarily conceived against an adversary whose threats could have immediate consequences of destroyed property or lost lives. In national interests, protection is instead primarily conceived against official decisions that could have long-term consequences and ultimately lead to activities having to scale-down or relocate.

Second, the paper illustrates the challenges of bridging logical and physical issues in development work, navigating the fundamental distinction between infological and datalogical aspects of the world (Langefors 1993). Whereas it often is important to be able to let go of physical constraints in order to realise underlying needs and devise new possibilities, many working solutions require physical artefacts and surroundings that exist in specific places and have specific characteristics.

Third, the paper shows how the exploration of means and ends provides important challenges when problems are set and solved. Whether it is a new information system that provides benefits to a business (Markus and Keil 1994), or as in this case, a piece of legislation that can be used as a tool towards certain goals of an organisation or society in general. In each case, there is a need for ‘customers’ to express needs and requirements, and ‘suppliers’ to express value and benefits.

## 6 References

- Boverket. 2013. *Riksintressen – nationella värden och möjligheter* [National interests – National values and possibilities], Karlskrona, Sweden: Boverket [National Board of Housing, Building and Planning].
- Fann, K.T. 1970. *Peirce’s Theory of Abduction*, The Hague, The Netherlands: Martinus Nijhoff.
- Försvarsdepartementet, 2015a. *Försvarspolitisk inriktning – Sveriges försvar 2016–2020* [Defence policy – Sweden’s defence 2016-2020], Proposition 2014/15:109, Stockholm: Regeringen [Government Offices of Sweden].
- Försvarsdepartementet, 2015b. *Uppdrag till Försvarsmakten och Myndigheten för samhällsskydd och beredskap avseende totalförsvarsplanering* [Assignment to the Swedish Armed Forces and the Swedish Civil Contingencies Agency regarding total defence planning], Regeringsbeslut 5, Stockholm: Regeringen [Government Offices of Sweden].
- Försvarsdepartementet, 2017. *Uppdrag till Försvarsmakten och Myndigheten för samhällsskydd och beredskap att främja och utveckla en sammanhängande planering för totalförsvaret* [Assignment to the Swedish Armed Forces and the Swedish Civil Contingencies Agency regarding facilitating and developing a holistic planning for total defence], Regeringsbeslut 2, Stockholm: Regeringen [Government Offices of Sweden].
- Försvarsmakten, 2015. *Redovisning av riksintressen och områden av betydelse för totalförsvarets militära del enligt 3 kap §9 Miljöbalken i Stockholms län* [Description of national interests and areas of significance for total defence’s military part according to 3 chapter §9 Environmental

- code in Stockholm county], Appendix to FM2015-3297:1, Stockholm: Högkvarteret, Försvarsmakten [Swedish Armed Forces].
- Glaser, B.G. and Strauss, A.L. 1967. *The Discovery of Grounded Theory: Strategies for Qualitative Research*, New Brunswick, NJ: Aldine.
- Holling C.S. 1973. "Resilience and stability of ecological systems", *Annual Review of Ecology and Systematics*, Vol. 4, pp. 1-23.
- Justitiedepartementet, 2015. *Planeringsanvisningar för det civila försvaret* [Planning directive for civil defence], Regeringsbeslut II:16, Stockholm: Regeringen [Government Offices of Sweden].
- Keen, P.G.W. 1991. "Relevance and Rigor in Information Systems Research: Improving Quality, Confidence, Cohesion and Impact in Information Systems Research", in Nissen, H.E., Klein, H. and Hirschheim, R. (eds.) *Contemporary Approaches and Emergent Traditions*, pp. 27-49, Amsterdam, The Netherlands: Elsevier Science Publishers.
- Langefors, B. 1993. *Essays of Infology*, Gothenburg Studies in Information Systems, Report 5, Göteborg, Sweden: University of Göteborg.
- Markus, M.L. and Keil, M. 1994. "If We Build It, They Will Come: Designing Information Systems That People Want to Use", *Sloan Management Review* 35(4).
- Merriam-Webster. n.d. "Defense" and "Defend", Retrieved May 23, 2018, from <https://www.merriam-webster.com/dictionary>
- MSB, 2011. *A functioning society in a changing world: The MSB's report on a unified national strategy for the protection of vital societal functions*, MSB 341, Karlstad, Sweden: Myndigheten för samhällsskydd och beredskap [Swedish Civil Contingencies Agency].
- Nelson, D.R., Adger, W.N. and Brown, K. 2007. "Adaptation to environmental change: contributions of a resilience framework", *Annual Review of Environment and Resources*, Vol. 32, pp. 395-419.
- Ryding, O. 2017. *Riksintrittssystemet* [The national interest system], Presentation 2017-05-22, Karlskrona, Sweden: Boverket [National Board of Housing, Building and Planning].
- Schein, E.H. 1987. *The Clinical Perspective in Fieldwork*, Vol 5, Qualitative research methods series, Thousand Oaks, CA: Sage Publications.
- SFS 1992:1403. *Lag om totalförsvaret och höjd beredskap* [Act for total defence and heightened alert], Stockholm: Försvarsdepartementet [Ministry of Defence].
- SFS 1998:808. *Miljöbalk* [Environmental code], Stockholm: Miljö- och energidepartementet [Ministry of the Environment and Energy].
- SFS 1998:896. *Förordning om hushållning med mark- och vattenområden* [Ordinance for husbandry of land and water areas], Stockholm: Miljö- och energidepartementet [Ministry of the Environment and Energy].
- SFS 2015:1052. *Förordning om krisberedskap och bevakningsansvariga myndigheters åtgärder vid höjd beredskap* [Ordinance for emergency preparedness and tasks during heightened alert of agencies with monitoring responsibility], Stockholm: Socialdepartementet [Ministry of Health and Social Affairs].
- United Nations, 1977. *Protocol additional to the Geneva Conventions of 12 August 1949, and relating to the protection of victims of international armed conflicts (Protocol I)*, I-17512, UN Treaty Series Vol. 1115, New York: United Nations.
- Weick, K.E. 1979. *The Social Psychology of Organizing*, Second edition, New York: McGraw-Hill.
- Yin, R.K. 2003. *Case Study Research - Design and Methods*, Third edition, Thousand Oaks, CA: Sage Publications Inc.

## Acknowledgements

The author is very grateful to the Swedish Civil Contingencies Agency and its two representatives for providing valuable feedback on this paper. The author also acknowledges much appreciated collaboration with his colleague Helena Brandt and support from Combitech AB, the consulting company they both worked for during the project described.

## Copyright

**Copyright:** © 2018 authors. This is an open-access article distributed under the terms of the [Creative Commons Attribution-NonCommercial 3.0 Australia License](#), which permits non-commercial use, distribution, and reproduction in any medium, provided the original author and ACIS are credited.

## Older Women Online: Engaged, Active and Independent

**Helen Hasan**

Australian Health Services Research Institute,  
University of Wollongong  
Wollongong Australia  
Email: hasan@uow.edu.au

**Henry Linger**

Australian Health Services Research Institute,  
Monash University  
Melbourne Australia  
Email: henry.linger@monash.edu

### Abstract

Older women in our communities are becoming marginalised through their lack of technical awareness and capability. Digital applications now dominate the way governments, business, communities and even families interact with all of us. As respected elders of our society, women not only need access to services which support their wellbeing as they age, but also have an important role to play in passing on their knowledge and wisdom to new generations. Through digital exclusion, older women often relied on others, particularly their spouses, to transact online activities. As they become carers for their ageing spouse or are widowed, they need to learn to do this for themselves. An action research approach recorded responses of seniors to individualised computer-learning sessions. Our research shows that they can learn digital skills, and this is leading to greater independence and social wellbeing. Everyone benefits as our women elders become digitally included.

**Keywords** living connected, social wellbeing, economic wellbeing older women, digital devices, internet, digital inclusion.



## 1 Introduction

As in most developed countries, Australia is facing challenges due to its ageing population (Christensen et al 2009) and, as people age, they may need more assistance to attend to the demands of daily living (Seidel et al 2011). At the same time, business, government, community and individuals are transitioning to greater reliance on digital devices and online applications in all aspects of modern life (ADII 2017). Many older citizens, i.e. those over 65 years of age, face challenges in adjusting to demands of the digital age. However, when sufficiently mastered, new forms of digital technologies can provide opportunities for positive ageing (Denvir et al 2014). Indeed, economic and social use of digital technologies can play a useful role in meeting the social and economic challenges posed by the ageing populations.

In reviewing the literature on the use of digital technologies by older people, we have not found any research that addresses gender differences in the factors, needs and desires that motivate the use of digital technology. Having conducted research in this area over several years, we believe that there are significant gender differences and that they are worth investigating.

This paper reports on ways that digital inclusion can meet the specific needs of older women, enabling them to remain more engaged, active and independent as they age. Our message is based on the findings of our research conducted with older computer users in regions south of Sydney in New South Wales. Adopting an ongoing action-research approach we investigate how guided digital technology use can improve the economic, social and emotional wellbeing of older citizens (Hasan and Linger 2016, 2017; Burgess et al 2012).

Paying attention to the wellbeing of older citizens is important. Whether in care or at home, many older citizens are becoming increasingly isolated as they age and are no longer able to get around as they once could (Grenade and Boldy 2008). However, with suitable support and more useable technology, this can change so that participation in online activities and communities can enhance the economic and social wellbeing (Taylor 2011).

The most recent findings of our years of research concern the way that older women in our communities can become increasingly marginalised through their lack of technical, experience, awareness and capability. Life expectancy in Australia for women is 85 years in contrast to 80 for men (Australian Bureau of Statistics 2017). This gender gap means that many women outlive the men on whom they relied to do tasks needing digital skills. Studies have shown that, on average, older Australian women are significantly less digitally included than men (ADII 2017). What is more, women now in their 70s and 80s had less education, less time at work and in lower status positions than men of the same age (Burgess et al 2012).

This paper presents recent research which shows how, with suitable devices and ongoing support, older women who have not previously used a computer can develop the digital capability to undertake many tasks that help them maintain independent living and control over decisions affecting their lives. The alternative is that older women become chronically isolated as they age in an increasingly digitised society. This has significantly detrimental impact on their wellbeing. They become disconnected from family, friends and community with little ability to engage in meaningful activities. They become increasingly dependent on others for assistance in attending to the demands of daily living lowering their self-esteem and dignity (Netten et al 2009).

Our research provides evidence of positive instances where older women are learning to use digital devices and online applications to remain connected to, and engaged in, the community as well as access to stimulating activities online. On the one hand, the research reveals the diverse challenges that women face in developing and maintaining digital capability as they age. On the other hand, it has uncovered the many benefits of participation in online activities and communities that contribute to positive ageing. The capability for connected living through online social engagement has the potential to radically enhance positive ageing and revolutionize the efficacy of the social and economic systems of aged care (Hasan and Linger 2016, 2017; Burgess et al 2012; Alcock et al 2014).

The research results show the importance of taking an individualized approach to meeting the needs of each older novice user who is motivated to learn and the importance of making this learning fun. It also reveals how mastering just one or two digital applications can not only enhance social wellbeing but also enable women to have more control of their lives and have less reliance on help from others.

## 2 Background

This section of the paper first presents the reasons why many older women over 65 are more digitally excluded than men. Then it summarises evidence of the negative consequences of isolation and the problems women face in access, affordability and capability when it comes to digital technology. Also discussed are the domains of wellbeing that can be improved through appropriate digital inclusion.

### 2.1 Factors limiting the Digital Capability of Older Women

The Australian Digital Inclusion Index (ADII) provides evidence at a population level of differences between the digital inclusion of older men and women (ADII 2017). While the gap between men and women is marginal in younger age cohorts (0.8 points for people aged 14–24 years and 1.0 points for those aged 25–34), it expands to 2.9 points in the 35–49-year cohort and is greatest amongst those aged 65+. On average, the score for older women on the ADII is 2.0 points below that of men. We note that this score is designed for aggregation so that from our perspective the ADII is not a useful research measure as an individual score and so not appropriate for our research.

A review of the literature revealed several contributing factors are that women currently in their 70s and 80s had fewer opportunities for education than men, spent less time at work and more time at home duties than men of the same age. When they were young, girls were encouraged to leave school as soon as possible, get an office job which they stayed in only until they got married. Men were the bread winners who managed the family financial affairs (Seidel et al 2011). This has meant that many women, who outlive their husband or must care for one who is incapacitated, must learn to manage affairs themselves. What is more, most of the tasks whereby an individual manages their affairs can best be done using online applications where digital skills and capability is required.

### 2.2 Problems of Isolation

It is common for isolation to increase with age. For those still living at home, this can be the result of environmental barriers, such as unsafe neighbourhoods, inaccessible housing and inadequate resources for socializing (Cohen-Mansfield et al 2016). While these issues affect older men and women they are critical for the wellbeing of older women. While the evidence is inconclusive, isolation and loneliness within residential aged-care settings may be even greater than it is for older citizens living in the community due to reduced social support (Grenade and Boldy 2008). Isolation is also associated with boredom and inactivity due to increased lack of mobility; recent losses of family and friends, as well as mental health issues leading to shame and fear (Cohen-Mansfield et al 2016).

Isolation is known to have negative impacts on social and emotional wellbeing that can lead to severe problems such as depression (Luo et al 2012). Of particular concern, are the many studies (Luo et al 2012; Cornwell and Waite 2009; Nikmat et al 2015) that have revealed strong correlation between social disconnectedness and physical and mental wellbeing. Many aged-care policies assume that it is inevitable that older people gradually become mentally inactive and unproductive (Norrie 2012; Perland 2004). However, there is a large body of evidence that remaining active, socially connected and emotionally satisfied is a major contributor to health and wellbeing (Netten et al 2009; Diene and Chan 2011; Hagan et al 2014). The World Health Organisation (WHO 2001) sees active ageing in terms of the health, independence and productivity of older people. Positive and productive ageing can improve social and emotional wellbeing in the best interests of both society and the individual (Kaye et al 2003).

### 2.3 Problems of Access, Affordability and Capability.

Research has identified inequalities of access to online information and services within the older population of contemporary ageing societies (Olsson and Viscovi 2016). Lack of access to digital technology excludes many older people from its benefits. As governments strive to replace conventional service delivery with e-government, many of the older demographic are missing out (Choudrie et al 2013). This is also true of access to online banking (Diniz et al 2012), and health information (Heart and Kalderon 2013). In Australia, the government emphasizes the use of online services such as my.gov.au and myagedcare.gov.au which assumes that all citizens should have access to such online services.

There is an assumption among many in the aged-care sector that older women have a limited level of digital literacy and little potential to actively engage online. Studies have found that many older citizens do not have access to digital technologies such as email, Skype, productivity tools and social media, or have the relevant skills to use them (Hakkarainen 2012; Lelkes 2013; Hargittai and Dobransky 2017). It is widely accepted that even well-motivated older people have a range of physical,

cognitive and motivational traits and computer-awareness that together impact on their potential to develop sufficient skills to use digital technology effectively (Burgess et al 2012). However, some recent research has reported growing acceptance of digital technology by older women (Niehaves and Plattfaut 2013; Zheng et al 2015) where improved technology, such as new tablet computers, is playing a role (Xie and Jaeger 2008).

## 2.4 Attributes of Wellbeing

Improving wellbeing of older people is the primary motivation for our research but wellbeing is difficult to quantify. Wellbeing is normally associated with people's experience of their quality of life (QOL) determined by satisfaction with their lives and a sense of personal development in their social context (NEF 2013) and, more recently, the social care-related QOL (SCRQoL). The ASCOT project of community care in the UK (Netten et al 2009) identified seven domains of SCRQoL wellbeing among older adults receiving community care services. Research shows that the first four domains (Accommodation, Personal Cleanliness, Food and Nutrition, Safety) are well served by care packages in the UK, Australia and presumably in other developed countries. The next three higher level domains (Occupation, Control, Social Participation) are not. The biggest gaps between needs and how they are being met lie in the higher-level domains on the right: those of engagement (connecting with people and community), activity (having meaningful and rewarding ways to occupy time) and independence (being in control of life).

The findings of the initial stages of our research indicate that these three domains are where digital inclusion could greatly improve the wellbeing of older people: maintaining their independence, keeping them connected to significant others and finding meaningful ways to spend their time (Hasan & Linger 2016, 2017). We now explain and justify our research methodology.

## 3 Research Methodology

As noted above, quantitative measures of wellbeing for individual older citizens, using QOL for example, were found to be unsuited to research involving older participants. Similarly, we found no quantitative measure of an individual's digital capability, such as the ADII score, that suited this older cohort. Two very recent quantitative studies (Heo et al 2015; Quintana et al 2018; Szabo et al 2018) have reported general links between internet use on the wellbeing of older people but little detail results from this approach. Previous literature has shown that limited, and even conflicting, results have come from studies that use surveys or experiments with older participants (Hagan et al 2014). For these reasons, the research described in this paper adopted an inductive, qualitative approach where we identify positive outcomes from the online activities and communities in which participants chose to engage.

### 3.1 Action Research

An action research approach (Mathiassen et al 2012; McKay and Marshall 2001) was adopted throughout the project. Action research is a form of applied research that is iterative, rigorous and collaborative, using informed interventions to develop a solution to a practical problem that is of value to the people with whom the researchers are working, while at the same time developing theoretical knowledge of value to a research community (Davison et al 2004).

Our research design involved interventions in the form of computer learning sessions with residents in local aged-care facilities over a period of five years. This had practical benefits for the participants and well as providing qualitative data for our research. We designed and implemented these interventions to enable and encourage the use of digital devices and Internet amongst residents. Our project has involved over 100 participants in six different care facilities and in several other sites. Our initial research design consisted of the provision of *computer kiosks* in a corner of the aged-care facilities' recreation rooms and the conduct of weekly sessions to help residents, who volunteered, learn to use computers and other digital devices for activities of their choosing. More recently we have been holding similar sessions for senior citizens in regional community centres where participants bring their own mobile devices and the problems they have with them.

The qualitative data was collected and subjected to the *collection reduction* and *display* phases recommended by Miles and Huberman (1994) so that conclusions could be derived from the results of the thematic analysis. Data was *collected* on the impact of our interventions in a manner that other researchers have found appropriate to the circumstances of working with the elderly. We followed the inductive approach of similar research to ours (Xie and Jaeger 2008; Ng 2007) combined with

innovative informal methods of data collection and analysis (Sayago et al 2013; Naumanen and Tukiainen 2007). In our research, data consisted of progress updates and field notes where “observations” and “lessons learned” files were kept in which we recorded activities that were interesting, noteworthy, troubling, surprising, or indicated something that worked well (or not). During our data collection, the data was *reduced* using thematic network analysis and the resulting thematic networks were *displayed* using a standard social network analysis tool.

### 3.2 The Research Settings

We have had continuous access to five aged-care facilities, in regional Australia, to conduct interventions over the five-year period of the project. The interventions consisted of the provision of what some called *computer kiosks* in a corner of their recreation area and help sessions run by the researchers. The first facility had taken a few residents to government-run computer classes in the local town. They had discontinued this initiative as the elderly participants had found that the teachers went too fast and did not have the time or patience to address the needs of the elderly. Additionally, between classes many participants had no devices on which to practice, and those that did have a device had no-one to help them when they encountered problems. Following the insistence of the small group of residents who had participated in those classes, the facility owners approved our project.

Managers at the other facilities noted what was happening at our first facility and asked us to set up similar computer kiosks in their facilities. We had several discussions with a range of stakeholder at all sites about the project design and on data collection. The owners, governors and managers allowed us to proceed provided they did have to pay and that we did not annoy participants with interviews or surveys. Our action research methodology was well received. We were able to continue to run the kiosks with the help of local volunteers and a small amount of research funding from our university.

Over the past year we have opened seven public “drop-in” sites at community centres across our region with support from government funding to continue the work. This has constituted the practice outcomes of our action research.

### 3.3 The Interventions

Our interventions are constructed as one-on-one help sessions where participants bring their own device if they have one or use one provided. They learn what their device can do and how to do whatever that interests them. They are provided with individual assistance with problems as they arise in use. These sessions are run by the researchers and other suitable volunteer instructors. We make considerable effort to create a happy, fun and relaxed environment to make this complex context safe-fail, time-paced, diverse and tolerant of dissent. In other words, the elderly did what they could with the technology, learnt at their own pace, were able to laugh at their mistakes and, most importantly, set the learning agenda. Moreover, each participant was able to use the devices they felt most comfortable with.

### 3.4 Data Collection and Initial Analysis

Data was collected from the interventions. The researchers and other instructors would observe these sessions and encourage participants to reflect on their activities. All kept notes of what was observed and heard, listening to the voices of participants. In this way extensive qualitative data has been collected from the activities of over 100 participants. Additionally, we would regularly engage in discussion with all stakeholders: facility owners, managers, residents, staff and volunteers who participated, as well as other visitors to the facilities, family and friends of residents. These discussions were also documented and provide alternate voices to those of the direct participants in their sessions.

At regular meetings the researchers analysed their notes and observations and identified emergent themes which were *reduced* to a generic set by systematic analysis. By the end the second year of the research we reached saturation with no new themes being identified. The results at this stage have been published using vignettes to illustrate the emergent themes of: connection, being occupied, self-sufficiency, self-worth/esteem, productivity, personal development, being in control, and enjoyment (Hasan and Linger 2016, 2017).

It was at this point we became aware of the research undertaken by the ASCOT team (see above) and realised the similarity of our findings. The themes arising from the research were compared with the ASCOT domains of Occupation, Control, and Social Participation (Netten et al 2009). Table 1 demonstrates the alignment of our research themes with the ASCOT domains.

<b>ASCOT Domain</b>	<b>Themes arising from the Research</b>
Occupation	being occupied, productivity, personal development
Control over daily life	self-sufficiency, being in control
Social participation and involvement	connection, self-worth, enjoyment

*Table 1 Alignment of the Themes with the relevant ASCOT Domains*

Following the interest shown in our work we have been encouraged to continue our computer help sessions in aged care facilities and community centres. The sessions have been supported by volunteers with some government and community funding. As researchers we have stayed involved, observing and recording happenings at the sessions whenever possible and analysing the data when the opportunity arises according to the themes identified previously. We also looked for the emergence of new themes and this led us to identify issues that are common to many older women among our participants.

## 4 New Findings

### 4.1 Our older Women Participants

Our participants are older people who choose to come to our computer help sessions for a wide variety of reasons from pure curiosity to assistance with specific problems associated with their use of digital devices. Over the five-year period of the research more women (consistently around 70%) than men have attended the sessions. In addition to the capability factors mentioned previously, this is also due to the lower self-esteem of older women where technology is concerned and the reluctance of many men to admit that they need help. Another aspect we have observed over the years is that men tend to retain the view of a computer as the large, serious device they used at work whereas women, particularly those who have never used computers, are readily enticed by the touch-screen interface of tablets and iPads.

Consistent with our previous publications we present our findings by summarising our observations as representative stories for each of our identified themes.

### 4.2 Stories of Women Representing each Theme

As mentioned above, the result of our initial two-year study was a list of emergent themes of wellbeing related to digital inclusion as follows: connection, being occupied, self-sufficiency, self-worth/esteem, productivity, personal development, being in control, and enjoyment. In a previous publication we illustrated each theme with vignettes which summarised our data (Hasan & Linger 2016, 2017).

What follows are new stories of women among our participants to illustrate these themes in our more recent findings.

*Connection:* One group of participants we met a few years ago were all women who had migrated to Australia decades ago and settled in the area when their husbands got work in the local steel works. They invited us to give some computer help at a social meeting they held weekly at the local community centre. Most said that they didn't know how to use a computer and probably would never be able to so. We asked how they kept in touch with family in the old country and many said they used Skype. This was when we realised that, with older women, it was important to focus on what people want to do, not on the technology. Learning to use a computer does not interest them but finding ways to be connected to family does. We have since had family members who ask us to help when they have given grandma an iPad and a quick introductory lesson but later find the iPad collecting dust on top of a cupboard.

*Being Occupied:* Older people often have plenty of time on their hands and little to do. With a device that suit their individual needs, isolated older women can do something meaningful with their time even when on their own. Many of our female participants are amazed with what they can find just surfing the web. One lady in her 70s had suffered with a life-inhibiting affliction since she was thirteen but had never really understood much about it. We found a reputable medical website and she learnt so much that she wished she had known when she was younger. Many others love to use google maps street view to see what has happened to places where they once lived. Perhaps the most popular activity that older people do online is their family history. Once they have the skills they spend hours working on their family tree.

*Self-sufficiency:* One of the comments that most of the older participants make from time to time is their desire to do things for themselves and not have to rely on others. A lady who joined recently said that her husband did everything on the computer to keep them connected with their children and manage all important online documents. However, he was not good at organising all their digital pictures they had which had got into a mess. She wanted to learn enough so she could make sure that all these precious pictures were not lost and in albums that she could access herself.

*Self-worth/esteem:* Despite assurances that they had made progress with their computing skills, many of the older women express a view that they are dummies compared with younger people. Unfortunately, this attitude is often reinforced by ageist comments from others. Our interventions endeavoured to engender a sense of accomplishment when participants mastered some aspect of the digital world. One example where this was particularly effective was a resident in an aged care facility who was younger than other residents; being in her 60s. Her need for care was debilitating obesity and she had no family or friends to act as caregiver. She never had visitors and had very low self-esteem. She was relatively computer savvy but could not afford a computer or internet access. Participating in the research, she borrowed one of the iPads the research provided and enrolled in several online courses on various topics. As her confidence grew, she began to attend some of the weekly kiosk sessions and was pleased when other residents asked for her help.

*Productivity:* Many of our older participants write very well. One former school principle who came to our sessions at one aged-care facility wrote beautiful poems and short stories. With some basic instruction, she learnt to use a word processor to produce a nicely formatted collection that she gave to her grandchildren. This brought them together and the grandchildren reciprocated with stories of their own. This encouraged other residents to do the same. Some even published their efforts online.

*Personal Development:* A few participants discovered massive, open, online courses (MOOCs) and arranged a program of online courses on topics of interest that they previously had no time or opportunity to study. One lady resident at a multicultural aged-care village had become friends with another lady who came from Spain. Like many people for whom English is a second language, this lady was losing her English language skills as she aged and resorted to her native Spanish. The first lady wanted to learn some Spanish to speak with her friend and we found an online program that helped her do this.

*Being in control:* Many participants struggled to deal with the confusing array of services that influence their lives such as banking and social security. One participant is not very mobile and has left all such matters to her husband who had died recently. She does not have any close family or friends that she can really trust to manage her affairs. In the kiosk sessions she had learnt to do many of her affairs online. She could check her bank account, pay bills and do other transactions. She felt more in control and is no longer worried that others may be taking advantage of her position.

*Enjoyment:* Entertainment is provided for residents in aged care but there is not a great deal of variety. Residents argue about which channel to watch on the community TV or which movies to show. Access to streamed entertainment on individual devices gets around this limitation and provides access to many forms of entertainment. The ABC's iView and SBS on Demand are particularly popular. In addition, a couple of women who came to the weekly sessions expressed their desire to travel but they could not afford to do so. They continued to come to the kiosk sessions in order to surf the Internet together and plan where they would go if they could. They loved to do virtual tours of towns, museums, historic sites and gardens all over the world.

## 5 Practical Support for the Digital-Inclusion of Older Women

Action research has outcomes that are both theoretical and practical. The theoretical research outcomes have been published (Hasan and Linger 2016, 2017) providing in depth understanding of the processes involved as older people develop the capability to use digital for their social wellbeing. The research provides insights that can inform others who want to set up similar practical programs in their aged-care facilities. These insights have been incorporated into a practical community service in our region called Living Connected which is now being provided for older people who want to set up and use computers and other digital devices at home. Based on the research findings, the guidelines for this practical service include the following:

**1. Focus on an activity that is important to the user not on the technology.** The home service begins with a discussion on what the older person wants to do or on what is getting harder to do as they age. With women this is particularly important as it relegated the technology to the background. Families often make the mistake of giving older members a device with a quick overview

and expect them to use it without any discussion on what they would want to use it for. Our service turns this around so that learning to use a device happens as a by-product of doing something else that is meaningful for the user.

**2. Get the right technology for the individual and what they want to do:** We don't ignore the technology altogether. Many older people already have a computer or have access to one. They may just need to have it set up and be provided with help to learn to use it for what they want and need. If they don't have a computer, or have one that is not suitable, maybe they need advice on what would be suitable and within their budget. Research has shown that internet use among older people has increased with the popularity of tablet devices (Tsai et al 2014). Women, who have never used computers, can often learn to use a tablet easier than a man for whom a computer, as experienced at work, is a device in a large box with a keyboard and screen.

**3. Get connected to the Internet:** This is where many older citizens need most help and advice. There is increasingly free WIFI in public places and even some aged-care facilities. There are different home options that vary in price and suitability. Older citizens need someone trustworthy and reliable to help them find the right option for them. The increasing popularity of smart phones has meant that many older women can use these as their Internet connection. However, many take some time to realise the difference between their phone data and a connection to the internet via Wi-Fi.

**4. Simple introductory lessons.** We have found that most women using a digital device for the first time should focus on something identified in step 1 above that engages them such as playing a game, doing some web surfing, taking a photo, typing some text into a word processor or using Google maps. Some basic computing skills are picked up along the way. Once they have mastered just one thing that they find interesting or fun, they are motivated to learn more of the basic computing skills they need to go further.

**5. Provide ongoing help as needed:** Every beginner will inevitably need some way to get appropriate ongoing help if they get stuck. Most problems can be solved by someone with basic IT skills, plenty of patience and good humour. Each older person that gets started with us needs to find the right person to provide occasional help for them, maybe a family member, neighbour or student on a community service program.

## 6 Discussion

This action research has yielded both academic and practical outcomes. The work has been published in academic journals and has resulted in a practical service to help older people improve their wellbeing using digital devices.

Participants in our study differed in terms of their computer-awareness, skills, and the physical and cognitive constraints that affect their ability to use a digital device. In this paper we have focused on some of the differences between women and men among older members of society. They come with different previous experiences with technology and women are mostly less experienced and less confidence than men. Women had different preferences as what they needed most where use of digital technology could assist. Our interventions helped participants in our programs to gain and extend their capability to the point where they could use digital device and the internet to do things that interested them and enhanced their wellbeing.

Our research findings are based on themes we have identified that illustrate social wellbeing rather than any objective or subjective measure. Our analysis identified the themes, which we illustrated above, as *connection, self-worth/esteem and personal development, productivity, occupation, self-sufficiency, being in control, and enjoyment*. We are confident that after five years of research these themes are comprehensive within our cohort although we acknowledge further themes could arise in other cohorts. We believe that these themes align with three of the ASCOT high-level domains, namely (1) *social participation and involvement*, (2) *occupation*, and (3) *control over daily life* (Netten et al 2009).

Within the context of the societal system of aged care, social and economic use of digital technology has the potential to assist in the social wellbeing of older women by keeping them independent and engaged. We observed that older women are less inhibited in admitting they don't know and tend to under play what they do know. Men are more reluctant to admit their problems. Women very appreciative of help and more focussed on what they can do with technology than on the technology itself.

## 7 Conclusion

The challenge of an ageing population is an extremely significant societal issue in communities everywhere. The social wellbeing of the elderly is a problem that has not had as much attention as medical or economic issues. Our project identified the complexity of this problem domain and revealed that straightforward empirical studies are not feasible. The current population of older women had little exposure to computers during their lives and received less technical education. Now as they outlive men in a digital world, it is important for them to acquire some digital capability to provide them with both economic and social independence and engagement. Significantly, our research identifies an approach to engage with the older women to enhance their ability to remain productive. It provides them with the opportunity to exploit and explore digital devices to meet their economic and social needs. It opens alternate options to wellbeing that are valid and meaningful and, importantly, are compatible with the complexity of productive ageing.

## 8 References

- ADII (2017) Measuring Australia's Digital Divide The Australian Digital Inclusion Index 2017 last accessed July 2018 from <https://digitalinclusionindex.org.au/the-index-report/report/>
- Alcock, C., Burgess, L. & Hasan, H. (2014). Connecting isolated senior citizens: illustrating the complexity of social information systems development. In H. Hasan (Eds.), *Being Practical with Theory: A Window into Business Research* (pp. 126-130). Wollongong, Australia: THEORI.
- Australian Bureau of Statistics (2017) 3302.0.55.001 - Life Tables, States, Territories and Australia, 2014-2016, last accesses July 2018 from <http://www.abs.gov.au/>
- Burgess, L., Hasan, H. & Alcock, C. (2012) Information Systems for the Social Wellbeing of Senior Australians, *Proceedings of ISD2012*, Prato, Italy
- Choudrie, J., Ghinea, G., & Songonuga, V. N. (2013). Silver surfers, e-government and the digital divide: An exploratory study of UK local authority websites and older citizens. *Interacting with Computers*, <http://iwc.oxfordjournals.org/content/early/2013/02/06/iwc.iws020.full>
- Christensen, K., Doblhammer, G., Rau, R., & Vaupel, J. W. (2009). Ageing populations: the challenges ahead. *The Lancet*, (Vol 374 No 9696 pp 1196-1208).
- Cohen-Mansfield, J., Hazan, H., Lerman, Y., & Shalom, V. (2016). Correlates and predictors of loneliness in older-adults: a review of quantitative results informed by qualitative insights. *International Psychogeriatrics*, 28(04), 557-576
- Cornwell, E & Waite, L (2009) Social Disconnectedness, Perceived Isolation, and Health among Older Adults, *Journal of Health and Social Behavior* (Vol 50 No 1 pp 31-48).
- Davison, R. M., Martinsons, M. G., & Kock, N. (2004). Principles of Canonical Action Research, *Information Systems Journal* (Vol 14 No 1 pp 65-86).
- Denvir C., J. Balmer N.J. & Pleasence P. (2014). Portal or pot hole? Exploring how older people use the 'information superhighway' for advice relating to problems with a legal dimension. *Ageing and Society*, 34, pp 670-699 doi:10.1017/S0144686X12001213
- Diene, E. & Chan, M. (2011) Happy People Live Longer: Subjective Well-Being Contributes to Health and Longevity, *Applied Psychology: Health and Well-Being* 1-43).
- Diniz, E., Birochi, R., & Pozzebon, M. (2012). Triggers and barriers to financial inclusion: The use of ICT-based branchless banking in an Amazon county. *Electronic Commerce Research and Applications*, 11(5), 484-494.
- Grenade, L. & Boldy, D. (2008). Social isolation and loneliness among older people: issues and future challenges in community and residential settings. *Australian Health Review*, 32(3), 468-478
- Hagan, R., Manktelow, R., Taylor, B. & Mallett, J. (2014) Reducing loneliness amongst older people: a systematic search and narrative review. *Ageing & Mental Health*, (Vol 18 No 6 pp 683-693).
- Hakkarainen P (2012) 'No good for shovelling snow and carrying firewood': Social representations of computers and the internet by elderly Finnish non-users, *New media and Society*, 14(7) 1198-1215.



- Hargittai, E., & Dobransky, K. (2017). Old Dogs, New Clicks: Digital Inequality in Skills and Uses among Older Adults. *Canadian Journal of Communication*, 42(2).
- Hasan H. & Linger H (2017) Connected Living for Positive Ageing, in Steven Gordon ed."Online Communities as Agents of Change and Social Movements." pp 203-223
- Hasan H. & Linger H (2016) Enhancing the wellbeing of the elderly: Social use of digital technologies in aged care , *Journal of Educational Gerontology*, 42/11 749-757
- Heart, T., & Kalderon, E. (2013). Older adults: are they ready to adopt health-related ICT?. *International journal of medical informatics*, 82(11), e209-e231
- Heo, J., Chun, S., Lee, S., Lee, K. H., & Kim, J. (2015). Internet use and well-being in older adults. *Cyberpsychology, Behavior, and Social Networking*, 18(5), 268-272.
- Kaye, L. Butler S. & Webster N. (2003) Towards a Productive Ageing Paradigm for Geriatric Practice, *Ageing International* (Vol 28 No 2 pp 200-213).
- Lelkes, O. (2013) Happier and less isolated: internet use in old age, *Journal of Poverty and Social Justice* (Vol 21 No 1 pp 33-46).
- Luo, Y., Hawkey L., Waite L., & Cacioppo, J. (2012) Loneliness, health, and mortality in old age: A national longitudinal study, *Social Science & Medicine*, (Vol 74 NO 6 pp 907–914).
- Mathiassen, L., Chiasson, M., & Germonprez, M. 2012. Style Composition in Action Research Publication. *MIS Quarterly*, 36(2), 347-363.
- McKay J & Marshall P (2001) The dual imperatives of action research, *Information Technology and People*, 14(1) 46-59.
- Miles MB and Huberman AM 1994 *Qualitative Data Analysis*, 2<sup>nd</sup> Edition, Thousand Oaks, CA, Sage Publications.
- Naumanen M. & Tukiainen M. 2007 Guiding the Elderly into the use of Computers and Internet – lessons taught and learnt IADIS International Conference on Cognition and Exploratory Learning in Digital Age (CELDA 2007)
- NEF (2013) *Social Indicators: Individual* Retrieved September 30 2013 from <http://www.proveandimprove.org/meaim/individuals.php>
- Netten, A., Burge P., Malley J., Potoglou N. Brazier, J. Flynn T. & Forder J. (2009) Outcomes of Social Care for Adults (OSCA): Interim Findings, *PSSRU Discussion Paper 2648~2*, Retrieved October 10 from <http://www.PSSRU.ac.uk>
- Ng, C. H. (2007). Motivation among older adults in learning computing technologies: A grounded model. *Educational Gerontology*, 34(1), 1-14.
- Niehaves, B. & Plattfaut, R. (2013) Internet adoption by the elderly: employing IS technology acceptance theories for understanding the age-related digital divide. *European Journal of Information Systems*, (Vol 23 No 6 pp 708-726).
- Nikmat, A., Hawthorne, G. & Al-Mashoor, S. (2015) The comparison of quality of life among people with mild dementia in nursing home and home care—a preliminary report *Dementia* (Vol 14 No 1 pp 114-125).
- Norrie, J. (2012) *Loneliness on the rise as our cities atomise*. Retrieved October 10 2013 <http://theconversation.edu.au/loneliness-on-the-rise-as-our-cities-atomise-6068>
- Olsson, T., & Viscovi, D. (2016). Remaining divides: Access to and use of ICTs among elderly citizens. *Politics, Civil Society and Participation: Media and Communications* 273 <http://www.researchingcommunication.eu>
- Perland, D. (2004) European and Canadian studies of loneliness among seniors. *Canadian Journal on Aging*. (Vol 23 No 2 pp 181–188).
- Quintana, D., Cervantes, A., Sáez, Y., & Isasi, P. (2018). Internet use and psychological well-being at advanced age: evidence from the English Longitudinal Study of Aging. *International journal of environmental research and public health*, 15(3), 480

- Sayago, S., Forbes, P., & Blat, J. 2013. Older people becoming successful ICT learners over time: challenges and strategies through an ethnographical lens. *Educational Gerontology*, 39(7), 527-544.
- Seidel, D., Brayne, C. & Jagger, C. (2011). Limitations in physical functioning among older people as a predictor of subsequent disability in instrumental activities of daily living. *Age and Ageing*, Retrieved October 10 2013 from doi: 10.1093/ageing/afr054
- Szabo, A., Allen, J., Stephens, C., & Alpass, F. (2018). Longitudinal Analysis of the Relationship Between Purposes of Internet Use and Well-being Among Older Adults. *The Gerontologist*.
- Taylor, A. (2011) *Social Media as a Tool for Inclusion*, Research Report, Canada.
- Tsai, H. Y. S., Shillair, R., & Cotten, S. 2014. Social Support and 'Playing Around': An Examination of How Older Adults Acquire Digital Literacy with Tablet Computers. In 2014 TPRC Conference Paper.
- UN (2018) Empowering women in the digital age WHERE DO WE STAND? UN Commission on the Status of Women 14 March NYC
- WHO (2001) Active ageing: From evidence to action. Geneva, World Health Organization.
- Xie, B. & Jaeger, P. (2008) Computer training programs for older adults at the Public Library. *Public Libraries*. Sept/Oct 2008: pp 52-59.
- Zheng, R., Spears, J., Luptak, M. & Wilby, F. (2015) Understanding Older Adults' Perceptions of Internet Use: An Exploratory Factor Analysis, *Educational Gerontology*, (Vol 41 No 7 pp 504-518).

**Copyright:** © 2018 Helen Hasan. This is an open-access article distributed under the terms of the [Creative Commons Attribution-NonCommercial 3.0 Australia License](https://creativecommons.org/licenses/by-nc/3.0/australia/), which permits non-commercial use, distribution, and reproduction in any medium, provided the original author and ACIS are credited.

# The Influence of IT on Women's Entrepreneurial Intention in the Saudi Context

## **Asma Aleidi**

School of Information, Systems and Modelling  
University of Technology Sydney;  
Princess Nourah bint Abdulrahman University  
Email: [asma.i.aleidi@student.uts.edu.au](mailto:asma.i.aleidi@student.uts.edu.au)

## **Daniel Chandran**

School of Information, Systems and Modelling  
University of Technology Sydney  
Email: [Daniel.Chandran@uts.edu.au](mailto:Daniel.Chandran@uts.edu.au)

## **Abstract**

IT entrepreneurship is becoming an increasingly vital source for promoting socio-economic growth, innovation and job opportunities. Despite the increasing awareness of this importance, evidence indicates that women participation in entrepreneurship with a particular focus on technological entrepreneurship remains low. Furthermore, there has been minimal research about female entrepreneurship from a technological point of view. Our goal in this study is to propose a model that extends the theory of planned behavior by incorporating the technological factors into established entrepreneurial models. Investigating such factors is beneficial for motivating a new generation of women entrepreneurs in the IT context. In addition, it helps to provide a further understanding to IS researchers and practitioners.

**Keywords** IT Entrepreneurship, Female Entrepreneurship, Entrepreneurial Intentions, Innovation, Saudi Arabia

## 1 Introduction

Entrepreneurial business and small ventures contribute to economic growth and innovation. More specific, we could observe an increasing awareness of the importance of IT entrepreneurship and innovation (Aleidi and Chandran 2017b; Chen 2013; Chen 2014; Dutta et al. 2015). However, recent studies indicate that despite the growing attainment within the engineering and technology (SET) sector, women entrepreneurs are heavily underrepresented (Chandran and Aleidi 2018; Ezzedeen and Zikic 2012; Hampton et al. 2011; Marlow and McAdam 2012). In particular, female entrepreneurship from the IT perspective is in its infancy. In spite of this indication, there is little research in this area. Consequently, as technological entrepreneurship continues to grow, and given the lack of women's IT entrepreneurial activities there is a need for further investigation. In particular, in order to encourage women tech-entrepreneurs, there is a need for identifying and understanding the factors and decision-making processes that affect women's engagement in such businesses. As Saudi government in particular has recently commenced various initiatives in an effort to support entrepreneurial leadership among Saudi youth, and enhance women's role in the labor force and economic sector through entrepreneurship leadership, it is essential to understand what influences individual's specific intention to engage in innovation and technological entrepreneurship. This understanding would also help to support and empower women's progress as entrepreneurs, and ultimately benefit our society through increased the culture of entrepreneurship, economic activity, innovation and creation of jobs. Moreover, this understanding could help to motivate new female generation for technological entrepreneurship as an attractive career. As has been argued by Almobaireek, and Manolova (2013), in contrast to findings from studies on entrepreneurial motivations in the context of Western Europe and the USA, young Saudi university women report a narrower range of entrepreneurial motivations, compared to men. Finally, for those women who have already entered the ranks of IT-related business founders, it is also important to develop an understanding of them to achieve successful and sustainable IT entrepreneurship and innovation. Our research contributes to this emerging body of work by aiming to answer the following research questions:

- What role do attitude, entrepreneurial self-efficacy, and subjective norms play in the explanation of women's IT entrepreneurial intention?
- How do technological factors affect women's IT entrepreneurial intention?

We position these constructs by drawing upon the theory of planned behavior (TPB) and the literature on IS and female entrepreneurship to establish a model of women's IT entrepreneurial intention to understand the phenomenon in which little is yet known such as female IT entrepreneurial behavior in developing countries such as Saudi Arabia. Understanding what influences an individual's specific intention to engage in innovation and technological entrepreneurship; better guidance can be a new driver of IT entrepreneurial behavior to a disadvantaged population with high economic potential such as women in the Saudi context.

## 2 Literature Review

### 2.1 IT Entrepreneurship Space

In recent years, technological entrepreneurship has been one of the most important drivers of economic growth, social value, and innovation (Chen 2013; Chen 2014; Dutta et al. 2015; Marvel and Lumpkin 2007; Willie O et al. 2011). As a starting point, technological entrepreneurship, also referred to as technology-based entrepreneurship is defined as the setting up of new firms by individuals or corporations to exploit technological innovation (Willie O et al. 2011). The dominant perspective on technological entrepreneurship views it as a relationship of enterprising individuals and systems of innovation. In this perspective, Autio (1997) define a new technological entrepreneurship as a firm with highly technology intensive, which is based on the exploitation of technological knowledge and capability (Autio 1997). Chen (2013; 2014) shows that the industry of IT is one of the most important and influential businesses, which rapidly incubate entrepreneurs. Such businesses have played an enormous role by creating entire new industries such as the computer industry, software industry, and Internet industry (Chen 2013, 2014).

IT entrepreneurs are understood as individuals, who organize, manage and accept the risk of IT entrepreneurship (Chandran and Aleidi 2018; Nichols and Armstrong 2003). Studies indicate that IT entrepreneurs have distinctive behavioral characteristics and different antecedents' factors, which are highly related to technical skills and perceptions (Aleidi and Chandran 2017a; Chen 2013; Chen 2014; Dutta et al. 2015). They are expected to have more technical related knowledge in addition to higher

innovation capabilities and attitudes. For instance, Marvel and Lumpkin (2007) found that formal education and prior knowledge of IT are important determinants to innovation outcomes of technology entrepreneurs (Marvel and Lumpkin 2007). Similarly, Chen (2014), prove that computer self-efficacy and personal innovativeness with IT significantly explain intention to start up an IT-related business. Furthermore, Dutta et al. (2015) show that personal innovativeness in IT and related knowledge and experience of the IT entrepreneur act as key drivers.

## **2.2 Women Entrepreneurs in Saudi Arabia**

In recent years, Saudi Arabia has witnessed strong growth in entrepreneurship in general and more specifically in female entrepreneurship. Although, women are traditionally restricted to join the economic field for a long time (Almobaireek and Manolova 2013), there is a quantum leap of women status in this area, driven largely by changing the direction of the Saudi government to support women's empowerment and gender equality (Aleidi and Chandran 2017a; Chandran and Aleidi 2018). According to Global Entrepreneurship Monitor 2016, the male rate of participation in the early-stage entrepreneurial activity (TEA) is 12.9% and the female rate 9.7% in the Saudi context. Although participation in TEA has been increasing across both genders, women have been rapidly closing the gap since 2009 (Roomi et al. 2017). The Saudi government has launched many entrepreneurship initiatives in an effort to support the entrepreneurial culture, develop entrepreneurial leadership among Saudi youth, and enhance women's role in the labor force and economic sector through entrepreneurship leadership. For example but not limited to, Aramco Entrepreneurship Center, and Badir Program from the scientific organization of King Abdulaziz City for Science and Technology (Chandran and Aleidi 2018). More recently, Vision 2030, which is a recent policy view of Saudi government marks a new phase in the development by promoting and supporting Small and Medium Enterprises (SMEs) to create suitable job opportunities for Saudi citizens as well as increasing women's participation in the workforce (Chandran and Aleidi 2018). It aims to support the Kingdom's sustainable development in the light of global trends that focus on technology, and innovation in the knowledge-based economy. In this regard, Misk, which is inspired by the vision, provides a variety of fellowship and traineeship programs for women to support the government's efforts in achieving the Kingdom's Vision 2030, which encompasses the improvement of women's participation as well as capacity building and empowerment in order to increase their contribution to the development (Misk 2018).

## **3 Research Model and Hypotheses Development**

The primary research goal is to conceptualize a women's IT entrepreneurial intentions model based on relevant research and current empirical studies to investigate the factors that affect women's IT entrepreneurial intention in the Saudi context. Two major streams of literature provide the theoretical foundations for this research. First, the literature on entrepreneurial behaviour, illustrating the role of intention as well as its antecedents including attitude toward entrepreneurship, entrepreneurial self-efficacy, and subjective norms. Second, the literature on information systems (IS), elaborating the role and importance of three context-specific factors computer self-efficacy, personal innovativeness in IT, and related knowledge and experience in technology as key drivers of entrepreneurial intention in technological entrepreneurship.

### **3.1 Theory of Planned Behavior**

A considerable amount of literature argues that intention plays a relevant role in decision making to start a new firm and predict entrepreneurial behavior (Díaz-García and Jiménez-Moreno 2010; Krueger et al. 2000). Theory of planned behaviour (TPB) by Ajzen (1991) is a broad theory of human behavior, which has been successfully adopted to predict and explain intentions to perform behaviors (Ajzen 1991; Autio et al. 2001). Ajzen's theory has also become the most influential and increasingly common framework in entrepreneurial intention literature (Autio et al. 2001; Díaz-García and Jiménez-Moreno 2010; Krueger et al. 2000) among others. According to the TPB, entrepreneurial intention illustrates the effort that is required from individuals to acquire the entrepreneurial behavior (Krueger et al. 2000). And so, it is considered to be influenced by three antecedents. First, individual's attitude, subjective norms, and the degree of perceived behavioral control (Ajzen 1991; Díaz-García and Jiménez-Moreno 2010). The perception of behavioral control construct is similar to the construct of perceived self-efficacy (Díaz-García and Jiménez-Moreno 2010), which is adopted in this study. Both concepts reflect one's perceived ability to achieve a particular goal or behavior (Ajzen 1991; Anna et al. 2000). Utilizing intention-based model, Chen (2014) and Dutta et al. (2015) proposed models that identify important technological dimensions as key drivers of IT entrepreneurial intention, including computer self-efficacy, personal innovativeness with IT, and related knowledge and experience in IT. Figure 1 shows the research model. (More details are provided in the hypotheses development section).

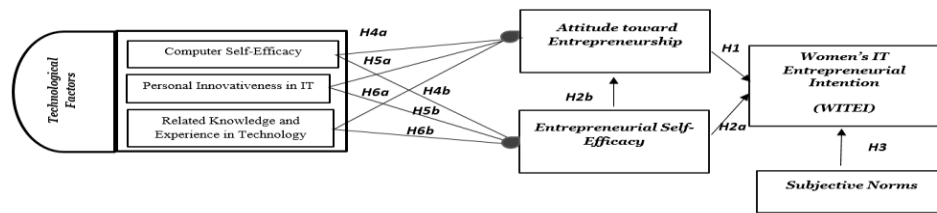

Figure 1: Research Model

### 3.2 Hypotheses Development

**Attitude** toward entrepreneurship refers to the degree to which an individual has a positive or negative personal evaluation about willingness to be an entrepreneur (Díaz-García and Jiménez-Moreno 2010). Higher positive attitude, greater the intention will be to perform a particular behavior including the entrepreneurial behavior (Autio et al. 2001; Chandran and Aleidi 2018; Díaz-García and Jiménez-Moreno 2010) among others. Attitudes influence the development of women entrepreneurial intention and assessed as inside dimensions of the individual to perform the actual behaviour. Accordingly, the following hypothesis is proposed

**H1:** Attitude towards entrepreneurship influences positively women's IT entrepreneurial intention.

**Entrepreneurial self-efficacy** (ESE) reflects an individual's perceived capability to perform entrepreneurial roles successfully (Chen et al. 1998). Many studies suggest that individual's with higher entrepreneurial self-efficacy has higher entrepreneurial intentions (Chen et al. 1998; Krueger et al. 2000). However, the literature shows that, compared to men, women tend to perceive themselves and the entrepreneurial environment less desirable (Langowitz and Minniti 2007). This perception in turn influences their self efficacy, intentions and subsequent lower levels of entrepreneurial behavior (Wilson et al. 2007; Zhao et al. 2005). Additionally, there is evidence that women are more likely than men to limit their career choice and interests due to their low perception of the necessary skills (Aleidi and Chandran 2018; Wilson et al. 2007). Palmer et al. (2015) find that the relationship between gender and entrepreneurial intentions was reduced when self-efficacy was considered (Palmer et al. 2015). Therefore, it is important to consider that women perceptions of themselves play a greater role in the decision to start a business. Furthermore, women who exhibited higher beliefs regarding their capabilities, their motivation and attitudes toward entrepreneurship will be stimulated and increased specifically when these women show a lower level of entrepreneurial attitude. This finding is consistent with Bandura (1986) indicating that self-efficacy causally influences expected outcomes of behavior, but not vice versa (Bandura 1986; Chen 2013). Whereas expected outcomes is linked to the attitude in Ajzen's TPB (Krueger et al. 2000). Accordingly, this study proposes the following hypotheses:

**H2a:** Entrepreneurial self-efficacy influences positively women's IT entrepreneurial intention.

**H2b:** Entrepreneurial self-efficacy influences positively attitude toward entrepreneurship.

**The subjective norms construct** is a social perception, which refers to perceived social pressure from people including family, friends and others to perform a certain behaviour (Ajzen 1991; Díaz-García and Jiménez-Moreno 2010). A recent research has recognized that subjective norms have a great impact on entrepreneurial intention. The higher the perceived social pressure, the higher the IT entrepreneurial intention (Chandran and Aleidi 2018; Díaz-García and Jiménez-Moreno 2010). Therefore, we could observe that the environment and subjective norms play an important role in women's IT entrepreneurial intention. From IS perspective, this proposition is consistent with Venkatesh & Morris (2000) assertion that women are strongly influenced by subjective norms perceptions of IT and IT usage intentions (Chandran and Aleidi 2018). Accordingly:

**H3:** Subjective norms influence positively women's IT entrepreneurial intention.

**Computer self-efficacy** (CSE) refers to the individual's belief in his/her capability to use computers in different situations (Compeau and Higgins 1995). Scholars demonstrate that CSE is a key component of an individual's behavior in using computers (Chen 2013; Chen 2014; Compeau and Higgins 1995; Venkatesh 2000). He and Freeman (2010a) illustrate that CSE beliefs can have an effect on behavioral intention through attitude (He and Freeman 2010). Furthermore, Chen (2013; 2014) demonstrated that CSE has a direct and positive impact on ESE, which in turn influences entrepreneurial intention. Consequently, it is reasonable to consider that CSE as an antecedent to attitude as well as entrepreneurial self-efficacy. CSE can be helpful increase the level of entrepreneurial attitude. It can

help also to reduce the effects of low self-efficacy of women as previous studies show that compared to men, women more frequently have a reduced perception of their own entrepreneurial skills, regardless their real skills, particularly in sectors that are seen traditionally as male domains (Wilson et al. 2007). This is consistent with a finding that shows users who possess high CSE are more likely to form positive perceptions of IT and IT usage intentions (Venkatesh 2000). Based on the arguments explored above, the following hypotheses are proposed:

**H4a:** Computer self-efficacy positively influences women's attitude towards entrepreneurship.

**H4b:** Computer self-efficacy positively influences women's entrepreneurial self-efficacy.

**Personal innovativeness in IT (PIIT):** a considerable amount of IS literature has demonstrated that PIIT is associated with IT adoption and usage (Agarwal and Prasad 1998; Chen 2014; Dutta et al. 2015). PIIT represents "the willingness of an individual to try out any new information technology" (Agarwal and Prasad 1998, p. 3). From IS perspective, entrepreneurs highly depend on technological innovation to create new technology enterprises and new technologies (Chen 2014; Dutta et al. 2015). Some well-empirical studies have tested the relationship between PIIT and individual's behavior providing evidence of a significant relationship (Agarwal and Prasad 1998; Chen 2014; Dutta et al. 2015). Furthermore, it is also reasonable to expect that PIIT could play a critical role in the development of the poor attitude toward IT entrepreneurship as well as the increasing of entrepreneurial self-efficacy. This proposition confirms previous studies showing that individual with high PIIT will improve his/her ability, motivate him/her to incubate technological innovation and look for ways it could be deployed to transform technology innovation into market opportunity (Dutta et al. 2015). Thus, the following hypotheses are proposed:

**H5a:** Personal innovativeness in IT positively influences women's attitude towards entrepreneurship.

**H5b:** Personal innovativeness in IT positively influences women's entrepreneurial self-efficacy.

**Related knowledge and experience (RKE)** play a critical role with regarding the development of IT entrepreneurial intention. Computer knowledge refers to the self-perception of the extent of knowledge regarding the use of computers across different application domains. A prior computing experience is defined as the frequency of using computers across different tasks and purposes. Both factors reflect an individual's direct experience with computers from the past and the present (He and Freeman 2010). Individuals with a high level of RKE will enable them to connect the previous relevant knowledge with the new knowledge, which in turn helps to identify and develop opportunities at the intersection (Dutta et al. 2015; Marvel and Lumpkin 2007). Furthermore, assimilation of new knowledge and technologies such as software process innovations is facilitated when individuals have greater related knowledge (Dutta et al. 2015; Fichman and Kemerer 1997; Lenox and King 2004). From these viewpoints, Dutta, et al, (2015) were able to demonstrate that RKE of the entrepreneur act as key drivers in virtual worlds' business, which positively influence the development of entrepreneurial self-efficacy and attitude. Therefore, the following hypotheses are developed:

**H6a:** Related knowledge and experience positively influence women's attitude towards entrepreneurship.

**H6b:** Related knowledge and experience positively influence women's entrepreneurial self-efficacy.

## 4 Research Method

This study has used a quantitative method to collect numerical data from respondents. According to the literature, most studies of entrepreneurial intention have relied on student samples (Autio et al. 2001; Chen 2014; Díaz-García and Jiménez-Moreno 2010) among others. In this study, we surveyed a broad range of samples to increase the generalizability of undergraduate student populations to older, who would provide different levels of knowledge, experience, and perception. Hence, the sample consists of female university students in their last years, majoring in different disciplines including but not limited to students majoring in IT and other related areas as well as subjects related to business and management. Also, it includes female nascent entrepreneurs who are not entrepreneurs yet, but are pondering on it and in the process of starting a business (McGee et al. 2009). The data for the study was gathered based on an online survey of 475 responses from November 2017 until January 2018. With respect to the female university students, data has been collected in large, public universities in Saudi Arabia, which are Princess Nourah Bint Abdurrahman in Riyadh, which is the largest university for women in the world, female colleges at King Saud University in Riyadh, and female colleges of King Abdulaziz University in Jeddah. To identify the nascent entrepreneurs, technology incubator, and entrepreneurship programs were targeted, including Badir's program from the scientific organization of King Abdulaziz City for Science and Technology, as well as King Salman Institute for Entrepreneurship program at King Saud University. The data were analysed using Partial Least Squares (PLS) Structural Equation Modelling (SEM) approach using the SmartPLS version 3 (Ringle et al. 2014). PLS allows the

researchers for evaluating the model of structural coefficients and the measurement tools. In this study, the proposed model has both formative and reflective variables. All factors are considered as the reflective indicators, because they were considered as effects of latent variables. This is consistent with prior research, such as (Chen 2013; Chen 2014; Dutta et al. 2015; Liao and Welsch 2005). The exception to this is subjective norms, which is formative in nature because it is a multi-dimensional factor that covers various referent groups such as family, friends and colleagues, following the guidelines by Eckhardt et al. (2009) for social influence as a formative construct (Eckhardt et al. 2009).

## 5 Conclusion and Expected Contribution

This study aims to make a significant contribution by examining empirically women's IT entrepreneurial intention as well as the impact of IT based on the theory of planned behaviour. Based on previous literature, the model has been proposed to answer the research questions. By investigating the effects of such factors, this study is expected to contribute to the literature in several ways. First, it contributes to information systems and female entrepreneurship literature by enhancing our understanding of aspects influencing the decisions of women to create new business in the IT-related industries, where women are underrepresented. It explores how IT level could play a role in the formulation of entrepreneurial intention. Furthermore, this study is a reconfirmation of the theory of planned behavior in predicting the entrepreneurial intentions from developing countries context in general and Saudi women context in particular. The IT entrepreneurial intention model developed in this study can be a new driver of IT entrepreneurial behavior among women, which has rich practical implications for enhancing entrepreneurship, economic growth and innovation. Significantly, our study also contributes to support Kingdom's new economic direction that aims to increase SME contribution to the economy, increase women's participation in the workforce and transferring the economic system from its oil-based economy to a knowledge-based economy through innovation and technology.

The methodology used in this study, which is a quantitative method, would allow the researcher to obtain a greater generalization of the result to generalize the entire population of women in Saudi Arabia. However, the research results were not of universal applications and might not be fully generalizable to other developing countries since the research was conducted in a specific context. The results of this research might be generalized through further examination and testing in other countries. Finally, like any research this study has limitations. Although, as explained earlier, the election of intentional theory is justified by their acceptance and generalized use to explain entrepreneurial intentions in different contexts and areas, we confirm that entrepreneurial intention is not the actual behavior. Thus, this is an area for future research to consider the IT entrepreneurial behaviour as well.

## 6 References

- Agarwal, R., and Prasad, J. 1998. "A Conceptual and Operational Definition of Personal Innovativeness in the Domain of Information Technology," *Information systems research* (9:2), pp. 204-215.
- Ajzen, I. 1991. "The Theory of Planned Behavior," *Organizational behavior and human decision processes* (50:2), pp. 179-211.
- Aleidi, A., and Chandran, D. 2017a. "Does Institutional Environment Promote Women's It Entrepreneurial Intention in Saudi Arabia? Technological and Institutional Perspectives," *PACIS 2017 Proceedings*. 208.).
- Aleidi, A., and Chandran, D. 2017b. "Technological and Institutional Perspectives of Women's It Entrepreneurial Intention in Saudi Arabia,").
- Aleidi, A., and Chandran, D. 2018. "Budding Female It Entrepreneurs in Saudi Arabia: Impact of It and Institutional Environment,").
- Almobaireek, W. N., and Manolova, T. S. 2013. "Entrepreneurial Motivations among Female University Youth in Saudi Arabia," *Journal of Business Economics and Management* (14:sup1), pp. S56-S75.
- Anna, A. L., Chandler, G. N., Jansen, E., and Mero, N. P. 2000. "Women Business Owners in Traditional and Non-Traditional Industries," *Journal of Business venturing* (15:3), pp. 279-303.
- Autio, E., H. Keeley, R., Klofsten, M., GC Parker, G., and Hay, M. 2001. "Entrepreneurial Intent among Students in Scandinavia and in the USA," *Enterprise and Innovation Management Studies* (2:2), pp. 145-160.
- Bandura, A. 1986. *Social Foundations of Thought and Action: A Social Cognitive Theory*. Prentice-Hall, Inc.
- Chandran, D., and Aleidi, A. 2018. "Analyzing the Influence of Gender Stereotypes and Social Norms on Female It Entrepreneurial Intention in Saudi Arabia," *Proceedings of the 51st Hawaii International Conference on System Sciences*.



- Chen, C. C., Greene, P. G., and Crick, A. 1998. "Does Entrepreneurial Self-Efficacy Distinguish Entrepreneurs from Managers?," *Journal of business venturing* (13:4), pp. 295-316.
- Chen, L. 2013. "It Entrepreneurial Intention among College Students: An Empirical Study," *Journal of Information Systems Education* (24:3), p. 233.
- Chen, L. 2014. "Understanding It Entrepreneurial Intention: An Information Systems View," *Journal of Computer Information Systems* (55:1), pp. 2-12.
- Compeau, D. R., and Higgins, C. A. 1995. "Computer Self-Efficacy: Development of a Measure and Initial Test," *MIS quarterly*, pp. 189-211.
- Díaz-García, M. C., and Jiménez-Moreno, J. 2010. "Entrepreneurial Intention: The Role of Gender," *International Entrepreneurship and Management Journal* (6:3), pp. 261-283.
- Dutta, D. K., Gwebu, K. L., and Wang, J. 2015. "Personal Innovativeness in Technology, Related Knowledge and Experience, and Entrepreneurial Intentions in Emerging Technology Industries: A Process of Causation or Effectuation?," *International Entrepreneurship and Management Journal* (11:3), pp. 529-555.
- Eckhardt, A., Laumer, S., and Weitzel, T. 2009. "Who Influences Whom? Analyzing Workplace Referents' Social Influence on It Adoption and Non-Adoption," *Journal of Information Technology* (24:1), pp. 11-24.
- Ezzedeen, S. R., and Zikic, J. 2012. "Entrepreneurial Experiences of Women in Canadian High Technology," *International Journal of Gender and Entrepreneurship* (4:1), pp. 44-64.
- Fichman, R. G., and Kemerer, C. F. 1997. "The Assimilation of Software Process Innovations: An Organizational Learning Perspective," *Management Science* (43:10), pp. 1345-1363.
- Hampton, A., McGowan, P., and Cooper, S. 2011. "Developing Quality in Female High-Technology Entrepreneurs' Networks," *International Journal of Entrepreneurial Behavior & Research* (17:6), pp. 588-606.
- He, J., and Freeman, L. A. 2010. "Understanding the Formation of General Computer Self-Efficacy," *Communications of the Association for Information Systems* (26:1), p. 12.
- Krueger, N. F., Reilly, M. D., and Carsrud, A. L. 2000. "Competing Models of Entrepreneurial Intentions," *Journal of business venturing* (15:5), pp. 411-432.
- Langowitz, N., and Minniti, M. 2007. "The Entrepreneurial Propensity of Women," *Entrepreneurship theory and practice* (31:3).
- Lenox, M., and King, A. 2004. "Prospects for Developing Absorptive Capacity through Internal Information Provision," *Strategic Management Journal* (25:4), pp. 331-345.
- Liao, J., and Welsch, H. 2005. "Roles of Social Capital in Venture Creation: Key Dimensions and Research Implications," *Journal of small business management* (43:4), pp. 345-362.
- Marlow, S., and McAdam, M. 2012. "Analyzing the Influence of Gender Upon High-Technology Venturing within the Context of Business Incubation," *Entrepreneurship Theory and Practice* (36:4), pp. 655-676.
- Marvel, M. R., and Lumpkin, G. T. 2007. "Technology Entrepreneurs' Human Capital and Its Effects on Innovation Radicalness," *Entrepreneurship Theory and Practice* (31:6), pp. 807-828.
- McGee, J. E., Peterson, M., Mueller, S. L., and Sequeira, J. M. 2009. "Entrepreneurial Self-Efficacy: Refining the Measure," *Entrepreneurship theory and practice* (33:4), pp. 965-988.
- Misk. 2018. "Misk." 2018, from <https://misk.org.sa/fellowship/she-means-business/>
- Nichols, S. P., and Armstrong, N. E. 2003. "Engineering Entrepreneurship: Does Entrepreneurship Have a Role in Engineering Education?," *Antennas and Propagation Magazine, IEEE* (45:1), pp. 134-138.
- Palmer, J., Griswold, M., Eidson, V., and Wiewel, P. 2015. "Entrepreneurial Intentions of Male and Female University Students," *International Journal of Business & Public Administration* (12:1).
- Ringle, C., Wende, S., and Becker, J. 2014. "Smartpls 3," in: *Hamburg: SmartPLS*.
- Roomi, M. A., de la Vega, I., AlAshri, O., and Coduras Martínez, A. 2017. *Global Entrepreneurship Monitor Saudi Arabia 2016/17*.
- Venkatesh, V. 2000. "Determinants of Perceived Ease of Use: Integrating Control, Intrinsic Motivation, and Emotion into the Technology Acceptance Model," *Information systems research* (11:4), pp. 342-365.
- Willie O, S., Helen O, A., Abiodun A, E., and Maruf, S. 2011. "Framework for Technological Entrepreneurship Development: Key Issues and Policy Directions," *American Journal of Industrial and Business Management* (2011).
- Wilson, F., Kickul, J., and Marlino, D. 2007. "Gender, Entrepreneurial Self-Efficacy, and Entrepreneurial Career Intentions," *Entrepreneurship theory and practice* (31:3).
- Zhao, H., Seibert, S. E., and Hills, G. E. 2005. "The Mediating Role of Self-Efficacy in the Development of Entrepreneurial Intentions," *Journal of applied psychology* (90:6), p. 1265.

# What Drives Post Adoption Behavior in Virtual Traffic Community: The Role of Utilitarian and Hedonic Values

**Trang Nguyen**

Institute of International Management  
National Cheng Kung University  
Tainan, Taiwan  
Email: trangnth@uel.edu.vn

**Jengchung Victor Chen**

Institute of International Management  
National Cheng Kung University  
Tainan, Taiwan  
Email: victor@mail.ncku.edu.tw

## Abstract

This study examines how satisfied experience enhance continuance intention of travel and navigation mobile application through the perceived value. It is proposed that user satisfaction stems from both utilitarian and hedonic value. Using a sample of 241 respondents and structural equation modeling, this study confirms that all aspect of perceived quality (information, system, service) enhances the perceived functionality of the app, while the sociability is the main determinant of the enjoyment perception. Both utilitarian and hedonic value are crucial in driving satisfaction, and eventually continuance intention of the apps. The findings are translated into practical implications and revenues for future research.

**Keywords** Perceived utilitarian value, Perceived hedonic value, Sociability, Continue to use

## 1 Introduction

The advanced technology allows the popularity and growth of virtual platforms with easy access and participation (Lu & Yang, 2011), for instance SNSs as Twitter, Facebook, Wikis, Blogs, forums, news group etc, where people meet online to share, communicate and exchange information with others. In addition, the Internet available with the ubiquitous mobile devices facilitate an active, updated and informative virtual communities, (Lu & Yang, 2011; Zheng, Zhao, & Stylianou, 2013). The benefits obtained from the use of virtual communities with millions of users is obvious in economic marketing and social and educational perspectives (Chiu, Hsu, & Wang, 2006). One instance relates to the User-generated content in traffic navigation purpose. Importantly, as complex and burdened traffic congestion is increasing, technology is expected to offer smarter solution to traffic and transportation services and solve the extreme loss of productivity caused by the traffic congestion (Heiskala, Jokinen, & Tinnilä, 2016). Therefore, digitalized traffic and transportation has been increasingly concerned as solution to these issues by the application of sensor and connectivity technology to roads and traffic lights, making it smarter compared to the traditional infrastructure. In addition, unlike the traditional one-way and passive communication, commuters switched to two-way communication in which both the providers and the audiences or users has become useful sources of information (Olsen, 2014) and effectively connect individuals with mutual goals to exchange benefits in virtual communities.

It is obvious that the widespread use of social media is not only by big IT names like Google but also new agencies with good reputation to build relationship and keep in touch with the customers and audiences. Moreover, audiences are even promoted to share news they have missed, which indicates the desire to let customers continue using, eventually, become more loyal to service providers (Olsen, 2014). Ma and Agarwal (2007) agreed that just a few virtual platforms successfully achieve users' continuance intention while many are losing their members. One of the possible reasons is the information insufficiency on virtual communities that makes it hard to retain users as the information quality can enhance the value of the virtual communities (Butler, 2001; Gu, Konana, Rajagopalan, & Chen, 2007). Besides, individuals use and share information through their devices and application. As such, system quality (e.g. ease of use) plays an important role in making users to feel more engaged and enjoyable in the interaction (Zheng et al., 2013). Prior research have confirmed the importance of both information quality and system quality in user satisfaction (H. F. Lin (2008)). Another important determinant for user continuance usage relates to service quality, according to (Delone & McLean, 2003; Xu, Benbasat, & Cenfetelli, 2013).

Despite the important role, the factor of quality may not be able to fully explain user continuance intention to use. Social interaction is also regarded as an essential element to engage members together. Being technologically sociable is no longer a new concept under the boom of technological development. The ongoing and advanced technologies offer platforms where users can engage, interact, and socialize with others. Accordingly, the concept of sociability would be introduced in this study as a human's want and need to socialize with peers via technology usage. Socializing with others is considered intrinsic need of human beings (e.g., Biocca, Harms, and Gregg (2001); Biocca, Harms, and Burgoon (2003)). Some efforts have been made to find out the significance of hedonic values and pleasure in getting individual motivated to use the IS (e.g., Van der Heijden (2004); Igbaria, Parasuraman, and Baroudi (1996); Agarwal and Karahanna (2000); Venkatesh and Davis (2000)) regardless the efficiency and effectiveness gains of this hedonic value is unlikely to be measured (Brown & Bell, 2006). Accordingly, the reasons for individuals to use an IS are no longer purely for its utility value, or ease of use value but also for the enjoyment obtained from the interaction with strangers that we can relate to in some way.

Therefore, this research aims to investigate what factors influence the continuance intention to use in traffic information virtual community which has been neglected by researchers. To our best understanding, much attention has been paid to understand the effort to improve travelers' performance but not at the successful factors for the performance of those applications.

## 2 Theoretical Background and Research Context

### 2.1 IS Success Model

Based on the idea of information influence theory by Mason (R. O. Mason, 1978) combined with Shannon and Weaver's work (Shannon & Weaver, 1949), six dimensions for IS success model was proposed by DeLone and Mc Lean including system quality, information quality, system use, user satisfaction, individual impact, and organizational impact (DeLone & McLean, 1992). This model has attracted several modifications from other researchers such as Pitt et al (Pitt, Watson, & Kavan, 1995), which refers to the activity of measuring the information received by users as well as the service quality

offered by employees through the use of IS (R. O. Mason (1978), Kettinger and Lee (1994)). Based on this idea, DeLone and McLean (Delone & McLean, 2003) added “service quality” dimension and further extended the application of IS success model to web applications, which is featured by another so-called “net benefits” dimension as a result of joining the effect of both individual and organizations. In another modification effort, “intention to use” has been added to generate an updated six-dimension model and the application was widened to Internet area as well. The definition of each dimension is summarized as table below.

	<b>Definition</b>
<b>System quality</b>	The expected quality feature regarding how available, usable and reliable a web-based environment is.
<b>Information quality</b>	A measurement of how complete, personalized, and relevant a web-based environment is.
<b>Service quality</b>	A measurement of how assurable, responsive, empathetic and dependent a web-based environment provided by the IT units or outsourced to service providers is
<b>User satisfaction</b>	A reaction to the use of system output.
<b>Intention to use”</b>	An attitude,” is a system phenomenon-related behavior, including the nature, level, appropriateness, and frequency of use.
<b>Net benefits</b>	A measurement of success in capturing the combined results of both good and bad effect of the system.

*Table 1: IS success model dimensions definition*

According to DeLone and McLean, how a user employs a system and their satisfaction is affected by the quality of the system, the information provided and the service. If a user gets more satisfied with a system, they are understandably to have higher intention to use, which eventually affect the actual use. Moreover, net benefits are also found to be varied under the effect of system use and user satisfaction. In summary, prior researches have applied the updated IS success model proposed by DeLone and McLean’s to deal with health IT implementation, to conceptualize and empirically examine important model antecedents or constructs, system quality, information quality, and service quality (Yu Su, Than Win, Fulcher, and Chia Chiu (2009), Lau, Price, and Keshavjee (2011), Bossen, Jensen, and Udsen (2013), Akter, D’Ambra, and Ray (2013)).

## 2.2 Sociability

Sociability refers to the level at which social interactions and social connectivity (Gao, Dai, Fan, & Kang, 2010) that are promoted and supported by the communication environment including the goals of social interaction shared among group members (Preece, 2000). The emphasis of Sociability is on members’ organization of social practices and construction of their identity (Phang, Kankanhalli, & Sabherwal, 2009). Simmel (Simmel (1910); Simmel and Hughes (1949)) demonstrates sociability relates to how people develop a tendency to associate with others and he assigned sociability as a non-utilitarian purpose. The association can appear in many forms but share the common feature characterized by a feeling of togetherness and union with others and by a satisfaction for that feeling (p. 254). For instance, in “sociological play-form” (p. 258), sociability is determined by the joy of others (p. 257) It could directs a person to deliver as many sociable values to other people as the reciprocal values he/ she obtains from these individuals during their interaction. In other words, sociability illustrates how an individual is inspired or desire to search for being accompanied by others have experience with joys and pleasure. Hence, sociability describes how a user look for the company of the others in the platform or community to get pleasurable experience in return. Evolving from this idea, we argue “sociability” as an additional element that is defined as users’ need to socialize and could be met through the connectivity and interaction with others in a system.

The determinants for users’ perception of the sociability of social software have been discussed in prior study. This research adopts the sociability concept including four dimensions social presence, social benefit, social support, and self-presentation from Gao et al (Gao et al., 2010). Social presence represents how a user perceive about the platform (Kreijns, Kirschner, & Jochems, 2003). In this sense, social presence is conceptualized as the extent to which a user is perceived as a “real person” in mediated communication (Park & Cameron, 2014). Social benefit is employed to indicate the mental benefits and goals gained thanks to using social commerce sites such as the emotional bonding of liking or the feeling of being close or intimate or tolerate with others’ mistakes or the feeling of familiarity shared between social network friends. Meanwhile social support refers to the facilitation gained from social interactions (Lee & Kwon, 2011). In other words, it indicates how an individual is aware of gaining the care, support and response from other members in the social group such as informational support and emotional

support (Hajli (2014), Shanmugam, Sun, Amidi, Khani, and Khani (2016)). Finally, self-presentation describes the means to express a customer's self and how he/she seeks for supporting responses from other members through traffic community.

### 2.3 Waze

Waze is known as an application for community-based traffic and navigation, with about 90 million active users worldwide, targeting at serving mainly car and motorcycle drivers. Founded by Ehud Shabtai in 2008 and acquired by Google in 2013, Waze visions that other than any sources of information, information from people is the best channel that can help their peers to correct information on traffic map as people's purpose is to sort out the most effective way to get to their destination in the shortest time expected. Therefore, Waze believe that people can provide real-time information to other users, and take use of this information source to automatically redirect users to ensure on-time schedule through other user's recent experience and report<sup>1</sup>.

## 3 Hypothesis Development

### 3.1 Information Quality, System Quality and Service Quality and Perceived Utilitarian Value

Information quality refers to the desired characteristics of the technological outputs (Petter, DeLone, & McLean, 2008; Petter & McLean, 2009). In different settings, the desired characteristics of information can differ. Gu et al. (2007) suggest that low-quality information increases users' efforts for seeking and processing information. Good-quality information can lead to the efficiency. For traffic information, it is essential for users to have an up-to-date, accurate, complete information for the effectiveness of decision making. Moreover, the information must be what they truly need and presented in an easy-to-understand format because they may not have much time when they are on the roads and have to make a quick decision due to the available information at that time

System quality refers to the performance of IS measurements can vary in different online settings. Markus (2005) suggests that the IS features are important to facilitate user interaction and subsequently result in its success. The system should be designed for users to access information and participate in the virtual communities effectively (Blanchard, 2008). In addition, it is fundamental for virtual communities to offer a well-organized and understandable navigation system so that users can perform their participation or usage effectively and efficiently (Gu et al., 2007). Moreover, system quality not only facilitates the usage of consuming and providing information, but also leads to the desired performance (Zheng et al., 2013).

Service Quality is an additional construct in the updated IS success model. The service in the model refers to the service that users receive from IS departments or IS system support service. After the growth of web 2.0 systems, service quality has become very important to various IS contexts e.g. e-commerce (Scott, DeLone, & Golden, 2011, June). In the recent study of Petter, DeLone, and McLean (2013), responsiveness and empathy are found to be the most important aspects to consumers/users when they look for assistance from the IS support teams.

Perceived value is generally conceptualized as the customer's or users' overall evaluation of what they consume upon give and take logical sense. (Zeithaml, 1988). Therefore, it is the perceived difference between what users give and what they receive (benefit and cost). This would apply to any context including the traffic information virtual communities in which the benefit is all the quality users receive from the platform and cost is considered as time and effort they spend in such a platform. Previous research state that perceived quality is a direct antecedent of perceived value (Teas & Agarwal, 2000) in which consequently affect the intention to reuse or repurchase (Cronin Jr, Brady, & Hult, 2000; Patterson & Spreng, 1997). Similarly, perceived value has also been proved to affect the customer loyalty, e.g. Dodds, Monroe, and Grewal (1991); Grewal, Monroe, and Krishnan (1998); Parasuraman and Grewal (2000). The quality-value-loyalty chain has been tested in many consumer behavior studies e.g. Durvasula, Lysonski, Mehta, and Tang (2004); Patterson and Spreng (1997); Zeithaml (1988) Dlačić, Arslanagić, Kadić-Maglajlić, Marković, and Raspor (2014). and IS studies e.g. Y. S. Wang (2008).

Under social virtual setting, perceived values include 3 values: utilitarian value which is expressed by how users cognitively evaluate the utility feature of a virtual community especially regarding need-meeting and problem-solving (Babin, Darden, & Griffin, 1994). Accordingly, we argue that the

---

<sup>1</sup> <https://www.waze.com>

information, system and service reflect the utility of the traffic information virtual community platforms to form the hypotheses as below:

H1. Information quality positively influences perceived utilitarian value.

H2. System quality positively influences perceived utilitarian value.

H3. Service quality positively influences perceived utilitarian value

### **3.2 Sociability and Perceived Hedonic Value**

As mentioned above, sociability has been argued to represent a “play-form” (Simmel and Hughes (1949), p. 258) of users as their satisfied experiences are linked with the relationship with other peers. Previous studies also mention predecessors of enjoyment (i.e. the extent to which a user perceive the system usage as fun ) includes attached feeling, motivation for serving their general prosperity (Leary and Baumeister (2000), Lou, Chau, and Li (2005)), relationship commitment, perceived critical mass (Lou et al., 2005), flow, arousal (L. C. Wang, Baker, Wagner, & Wakefield, 2007), and social norms and curiosity (Rouibah, 2008). It is understandable that the behaviors of sharing and exchanging feeling and thoughts can lead to a more enjoyable experience. Moreover, if negative feeling such as worries, concerns, stress, and anxieties, are shared and released, positive emotion can be developed (Leary & Baumeister, 2000). Similar rule applies to relationship commitment or the ambition to be a part of a relationship (Lou et al., 2005). In short, pleasure sharing among others can generate the “true pleasure” from behavioral performance per se, which allows us to hypothesize as:

H4. Sociability influences positively perceived hedonic value

### **3.3 Perceived Utilitarian Value, Perceived Hedonic and Satisfaction**

Within this study scope, we view perceived value as a primarily cognitive variable, emphasizing the distinction between get and give elements whereas satisfaction is treated as an affective construct. There is a strong support for the antecedent relationship between Perceived value and users’ satisfaction (Tam, 2004) as well as that in virtual communities. (Eggert & Ulaga, 2002; Lin & Wang, 2006; Y. S. Wang, 2008; Yang & Peterson, 2004). Consequently, it is reasonable to conclude that perceived value of using traffic information virtual communities can result in user satisfaction.

Further, the virtual community platform does not only offer the utilitarian value but also hedonic value through the enjoyable feeling users get from interaction with the platform. Hedonic value refers to the fun and relaxing feeling or good emotions generated through joyful experience of an action for its own sake, (Babin et al., 1994). It is found that hedonic value makes users feel satisfied under different contexts, particularly in online platform where the border between functionality and enjoyment cannot be clearly defined (Chea & Luo, 2008). As supported by (Stafford, Stafford, & Schkade, 2004), the satisfaction of users of online platform or in virtual world can be generated thanks to the hedonic value (Verhagen, Feldberg, van den Hooff, Meents, & Merikivi, 2011). Thus, we hypothesize as:

H5. Perceived utilitarian value positively influences user satisfaction.

H6. Perceived hedonic value positively influences user satisfaction.

### **3.4 User Satisfaction and Continuous Usage**

User satisfaction is defined as a certain state of emotion and psychology created after the experience with an IS. As discussed in both IS and Marketing literature, satisfaction refers to is an effusive reaction that are able to predict continuance and repurchase intention (Bhattacharjee, 2001; Chea & Luo, 2008; McKinney, Yoon, & Zahedi, 2002; Oliver, 1994), These intentions are critical to the success for virtual communities (Blanchard, 2008). If user satisfaction is not kept up, they tend to lose the connection with the platform and develop the intention to discontinue the usage or replace by another virtual platform for more informative and beneficial results (Gu et al., 2007). As a result, we form Hypothesis 7 as:

H7. User satisfaction positively influences continuance usage

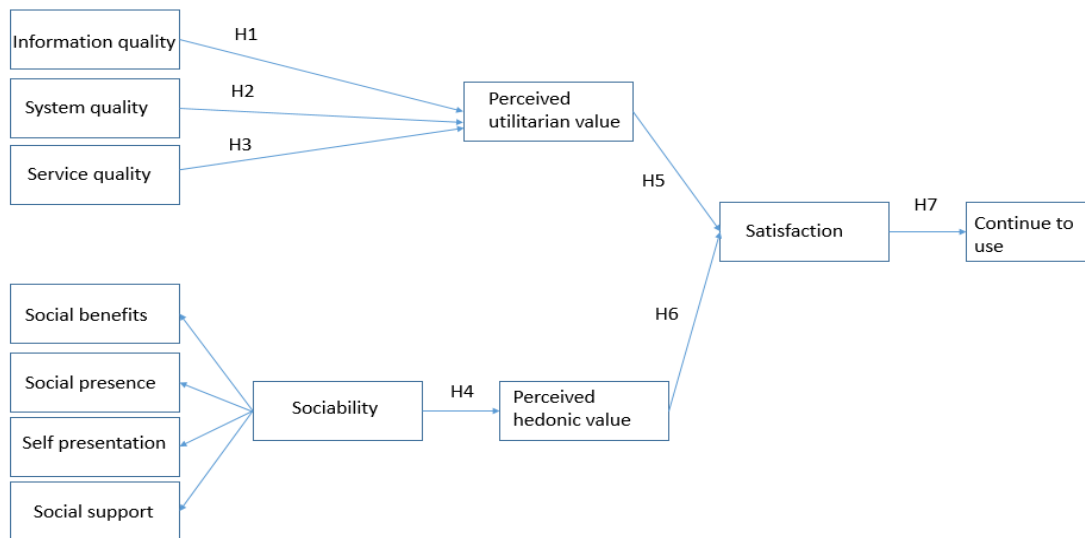

Figure 1: Research model

## 4 Research Methodology

### 4.1 Data Collection

The survey questionnaire was collected from Waze users in United State through Amazon M-Turk which is a reliable source of participants for academic research (W. Mason & Suri, 2012; Sprouse, 2011). After screening unusual and unengaged responses, a total number of respondents are 241 with 122 Male (50.6%) and 119 Female (49.4%). Among this group of participants, 56% are between 25 and 35 years old and 49.4% users holding a bachelor degree.

### 4.2 Measures

The questionnaire uses a 7 point Likert scale, with 1 for “strongly disagree” and 7 for “strongly agree.” Information Quality items are adapted from the study of (H.-F. Lin, 2008), System Quality items are adopted from (Liang, Ho, Li, & Turban, 2011); (H.-F. Lin, 2008); (Y. S. Wang, 2008) , Service Quality items are specifically adopted from W.-T. Wang, Wang, & Liu, 2016, Perceived Utilitarian Value items are adapted from (Parasuraman, Zeithaml, & Malhotra, 2005); (Zhou, Fang, Vogel, Jin, & Zhang, 2012), Social presence items are adapted from Animesh et al. (Animesh, Pinsonneault, Yang, & Oh, 2011), Social support items are based on Liang et al.’s (Liang et al., 2011) study, Social benefit six items are adapted from Ng (Ng, 2013) and Lee and Kwon (Lee & Kwon, 2011), Self-representation items are adapted from Seidman (Seidman, 2013) and Shin and Kim (Shin & Kim, 2010), *Perceived Hedonic Value* items are adopted from Zhou et al. (2012), Van der Heijden (2004), *User Satisfaction* are adapted from H. F. Lin (2008); Y. S. Wang (2008); Zheng et al. (2013)

## 5 Data Analysis

### 5.1 Factorial Validity and Reliability

Construct	CA	CR	AVE
Information quality	0.883	0.915	0.682
System quality	0.895	0.919	0.656
Service value	0.887	0.917	0.689
Perceived utilitarian value	0.878	0.917	0.733
Social presence	0.910	0.937	0.787
Social benefit	0.931	0.948	0.784
Self-presentation	0.938	0.953	0.803
Social support	0.919	0.939	0.755

Perceived hedonic value	0.938	0.951	0.765
Satisfaction	0.864	0.907	0.710
Continue to use	0.879	0.925	0.805

*Table 2. Cronbach's alpha, Composite reliability, and AVE scores of major constructs*

To test the reliability of instrument, Cronbach's alpha and composite reliability are examined. As shown in Table 2, those two value are all above the criteria of 0.7.

Factorial validity is established by convergent validity and discriminant validity. Convergent validity is examined based on item loadings and the average variance extracted (AVE). The results indicate that most loadings are greater than the minimum value of 0.70 (SS1 is the only item to be removed as its loading is lower than the required threshold). In addition, the Average Variance Extracted (AVE) are also higher than the threshold of 0.5. The first order factors also have sufficient loading to the second factor, i.e. sociability. To examine if there is a threat from multi-collinearity, the variance inflation factor (VIF) statistic was computed. The result shows that none of the VIF values were greater than the benchmark of 3.33. Hence, multi-collinearity is not an issue in this study.

In addition to this, discriminant validity is assessed to test if two constructs are distinct constructs. The table 3 shows that square root of the AVEs are greater than the correlations among the constructs, so we can conclude that the discriminant validity is satisfactory (Fornell & Larcker, 1981)

	<i>Mean</i>	<i>SD</i>	<i>CON</i>	<i>IQ</i>	<i>PHV</i>	<i>PUV</i>	<i>SAT</i>	<i>SB</i>	<i>SE</i>	<i>SYQ</i>	<i>SP</i>	<i>SPR</i>	<i>SS</i>
<i>CON</i>	5.520	1.288	0.897										
<i>IQ</i>	5.386	1.023	0.693	0.826									
<i>PHV</i>	4.590	1.459	0.342	0.390	0.875								
<i>PUV</i>	5.430	1.106	0.747	0.832	0.410	0.856							
<i>SAT</i>	5.216	1.167	0.760	0.728	0.562	0.774	0.843						
<i>SB</i>	4.243	1.637	0.235	0.270	0.769	0.302	0.411	0.885					
<i>SE</i>	4.970	1.122	0.550	0.676	0.600	0.702	0.685	0.567	0.830				
<i>SYQ</i>	5.533	0.974	0.659	0.754	0.345	0.750	0.655	0.226	0.586	0.810			
<i>SP</i>	5.430	1.106	0.354	0.437	0.725	0.443	0.522	0.723	0.607	0.380	0.887		
<i>SPR</i>	3.801	1.779	0.161	0.170	0.753	0.165	0.370	0.830	0.510	0.119	0.624	0.896	
<i>SS</i>	4.773	1.318	0.309	0.397	0.742	0.404	0.469	0.796	0.626	0.340	0.784	0.687	0.869

*Table 3. Measurement model statistics*

## 5.2 Hypothesis Testing

Table 4 presents the results of the structural model estimation by using bootstrapping procedure to test the significance of all paths. As shown in Table 4, all proposed hypotheses in the research model were found to be supported. More specifically, Information quality, system quality and service quality were found to have a positive effect on perceived utilitarian value with statistical significance at the  $p < .001$  level; rendering supports for H1, H2, H3.

The significant positive effect of sociability on perceived hedonic value supports H4. In addition, both perceived utilitarian and perceived hedonic value positively affects satisfaction, supporting H5, H6. Finally, the paths from satisfaction to continue to use is also found to be significant as hypothesized, supporting supports H7.

<i>Hypothesis</i>	<i>Path</i>	<i>Path coefficient</i>	<i>T-value</i>	<i>P Values</i>	<i>Hypothesis testing</i>
<i>H1</i>	<i>IQ -&gt; PUV</i>	0.496	6.568	0.000	Supported
<i>H2</i>	<i>SYQ -&gt; PUV</i>	0.245	3.809	0.000	Supported
<i>H3</i>	<i>SE -&gt; PUV</i>	0.223	3.760	0.000	Supported
<i>H4</i>	<i>SOC -&gt; PHV</i>	0.832	35.680	0.000	Supported
<i>H5</i>	<i>PUV -&gt; SAT</i>	0.654	14.433	0.000	Supported



<i>H6</i>	<i>PHV -&gt; SAT</i>	<i>0.294</i>	<i>6.076</i>	<i>0.000</i>	<i>Supported</i>
<i>H7</i>	<i>SAT -&gt; CON</i>	<i>0.760</i>	<i>21.646</i>	<i>0.000</i>	<i>Supported</i>

*Table 4. Summary of hypothesis testing*

## 6 Discussion and Implications

### 6.1 Discussion of Findings

This research examined the factors that influences continuous behavior in virtual traffic communities from both perceived utilitarian and hedonic value perspective. The first three hypotheses (H1, H2, H3) present the effects of information quality, system quality and service quality on perceived utilitarian value. All three hypotheses are supported. In the context of this research, people take advantage of traffic app to access for the traffic information for their daily travelling. Hence, offering up to date and accurate information is an essential criterion to retain and enhance users' perceived value. In other words, the higher level of information quality, the more functional values are perceived by users. Regarding to system quality, the stability and ease-of-use facilitate user's interaction with the app, thus resulting in higher perceived usefulness toward the system. Service quality refers to the responsiveness and empathy of supporting teams to users when necessary. If The system can give more attention to individual user and offering timely assistance, it will surely enhance their perception on perceive utilitarian value.

With respect to the perceived hedonic value, sociability and its dimensions are explored. The results show that those indicators are the reflection of sociability and they positively impact perceived hedonic value. In particular, these affordances include: social presence, social benefits, self-presentation and social support. As the results present, maximizing each of the four antecedents can increase perceived hedonic value. This is consistent with theoretical arguments in which individuals desire to seek out the company of others to have pleasurable social experiences. Subsequently, a system that could facilitate social interaction is more likely evoke intrinsic value to users.

Finally, both perceived utilitarian and hedonic value significantly increase continuance behavior. This could be explained since the ongoing and advanced technologies tend to offer platforms where users can get both functional benefits and social benefits. By doing so, users are encouraged to continue usage since they could accomplish their desire to capture traffic information as well as get more fun and joyful moments.

### 6.2 Theoretical Contributions

This research contributes to the continuance behavior literature by integrating both utilitarian and social- hedonic perspective in the case of traffic information virtual communities, which have not been widely researched. The hypotheses testing help enhances the existing knowledge by extending the post adoption behavior's antecedents in hedonic and utilitarian components.

### 6.3 Managerial Implications

For managerial perspective, the results can capture what users actually value the most for their usage continuance. This will help management to consider what to emphasize and improve to retain their users. In order to retain users, it is really important to understand what brings users to the community and be in their top-of-mind position. The findings show what are the values affecting users' usage continuance. This will benefit management to develop the business strategy to enhance and retain users. In order to do this, maximizing the functional benefits as the core value and facilitating attractive social interacting environment will bring users to the community and make the traffic information platform more competitive.

### 6.4 Limitations and Future Research

This research is limited by data collection method. The data was collect from those Waze's users in the US only. This way could limit generalizability of the findings to other groups of users from other countries. Moreover, this research adapts the definition of sociability from (reference) which could be bias since there are many components affecting sociability such as activity support, context support (ref). Hence, the future research should address this gap by investigating deeply on the concept sociability. The continuance behavior in this research is still general since users using virtual communities for different purposes such as sharing information or consuming information only. Therefore, the continuance behavior could be divided as providing and consuming. These types of post adoption behavior may be another issue for future studies to consider.

## 7 References

- Agarwal, R., & Karahanna, E. (2000). Time flies when you're having fun: Cognitive absorption and beliefs about information technology usage. *MIS quarterly*, 665-694.
- Akter, S., D'Ambra, J., & Ray, P. (2013). Development and validation of an instrument to measure user perceived service quality of mHealth. *Information & Management*, 50(4), 181-195.
- Animesh, A., Pinsonneault, A., Yang, S.-B., & Oh, W. (2011). An odyssey into virtual worlds: exploring the impacts of technological and spatial environments on intention to purchase virtual products. *MIS quarterly*, 789-810.
- Babin, B. J., Darden, W. R., & Griffin, M. (1994). Work and/or fun: measuring hedonic and utilitarian shopping value. *Journal of consumer research*, 20(4), 644-656.
- Bhattacharjee, A. (2001). Understanding information systems continuance: An expectation-confirmation model. *MIS quarterly*, 12(3), 351-370.
- Biocca, F., Harms, C., & Burgoon, J. K. (2003). Toward a more robust theory and measure of social presence: Review and suggested criteria. *Presence: Teleoperators & virtual environments*, 12(5), 456-480.
- Biocca, F., Harms, C., & Gregg, J. (2001). *The networked minds measure of social presence: Pilot test of the factor structure and concurrent validity*. Paper presented at the 4th annual international workshop on presence, Philadelphia, PA.
- Blanchard, A. L. (2008). *The Encyclopedia of e-Collaboration*. New York: Information Science Reference.
- Bossen, C., Jensen, L. G., & Udsen, F. W. (2013). Evaluation of a comprehensive EHR based on the DeLone and McLean model for IS success: approach, results, and success factors. *International journal of medical informatics*, 82(10), 940-953.
- Brown, B., & Bell, M. (2006). Play and sociability in there: Some lessons from online games for collaborative virtual environments *Avatars at work and play* (pp. 227-245): Springer.
- Butler, B. S. (2001). Membership size, communication activity, and sustainability: A resource-based model of online social structures. *Information Systems Research*, 12(4), 346-362.
- Chea, S., & Luo, M. M. (2008). Post-adoption behaviors of e-service customers: The interplay of cognition and emotion. *International Journal of Electronic Commerce*, 12(3), 29-56.
- Chiu, C.-M., Hsu, M.-H., & Wang, E. T. (2006). Understanding knowledge sharing in virtual communities: An integration of social capital and social cognitive theories. *Decision Support Systems*, 42(3), 1872-1888.
- Cronin Jr, J. J., Brady, M. K., & Hult, G. T. M. (2000). Assessing the effects of quality, value, and customer satisfaction on consumer behavioral intentions in service environments. *Journal of retailing*, 76(2), 193-218.
- DeLone, W. H., & McLean, E. R. (1992). Information systems success: The quest for the dependent variable. *Information systems research*, 3(1), 60-95.
- Delone, W. H., & McLean, E. R. (2003). The DeLone and McLean model of information systems success: a ten-year update. *Journal of Management Information Systems*, 19(4), 9-30.
- Dlačić, J., Arslanagić, M., Kadić-Maglajlić, S., Marković, S., & Raspor, S. (2014). Exploring perceived service quality, perceived value, and repurchase intention in higher education using structural equation modelling. *Total Quality Management & Business Excellence*, 25(1-2), 141-157.
- Dodds, W. B., Monroe, K. B., & Grewal, D. (1991). Effects of price, brand, and store information on buyers' product evaluations. *Journal of Marketing Research*, 28(3), 307-319.
- Durvasula, S., Lysonski, S., Mehta, S. C., & Tang, B. P. (2004). Forging relationships with services: The antecedents that have an impact on behavioural outcomes in the life insurance industry. *Journal of Financial Services Marketing*, 8(4), 314-326.
- Eggert, A., & Ulaga, W. (2002). Customer perceived value: a substitute for satisfaction in business markets? *Journal of Business & industrial marketing*, 17(2/3), 107-118.
- Fornell, C., & Larcker, D. F. (1981). Structural equation models with unobservable variables and measurement error: Algebra and statistics. *Journal of marketing research*, 382-388.
- Gao, Q., Dai, Y., Fan, Z., & Kang, R. (2010). Understanding factors affecting perceived sociability of social software. *Computers in Human Behavior*, 26(6), 1846-1861.
- Grewal, D., Monroe, K. B., & Krishnan, R. (1998). The effects of price-comparison advertising on buyers' perceptions of acquisition value, transaction value, and behavioral intentions. *The journal of marketing*, 62(2), 46-59.
- Gu, B., Konana, P., Rajagopalan, B., & Chen, H.-W. M. (2007). Competition among virtual communities and user valuation: The case of investing-related communities. *Information systems research*, 18(1), 68-85.

- Hajli, M. N. (2014). The role of social support on relationship quality and social commerce. *Technological Forecasting and Social Change*, 87, 17-27.
- Heiskala, M., Jokinen, J.-P., & Tinnilä, M. (2016). Crowdsensing-based transportation services—An analysis from business model and sustainability viewpoints. *Research in Transportation Business & Management*, 18, 38-48.
- Igbaria, M., Parasuraman, S., & Baroudi, J. J. (1996). A motivational model of microcomputer usage. *Journal of Management Information Systems*, 13(1), 127-143.
- Kettinger, W. J., & Lee, C. C. (1994). Perceived service quality and user satisfaction with the information services function. *Decision sciences*, 25(5-6), 737-766.
- Kreijns, K., Kirschner, P. A., & Jochems, W. (2003). Identifying the pitfalls for social interaction in computer-supported collaborative learning environments: a review of the research. *Computers in Human Behavior*, 19(3), 335-353.
- Lau, F., Price, M., & Keshavjee, K. (2011). Making sense of health information system success in Canada. *Health Q*, 14(1), 39-46.
- Leary, M. R., & Baumeister, R. F. (2000). The nature and function of self-esteem: Sociometer theory. *Advances in experimental social psychology* (Vol. 32, pp. 1-62): Elsevier.
- Lee, Y., & Kwon, O. (2011). Intimacy, familiarity and continuance intention: An extended expectation–confirmation model in web-based services. *Electronic Commerce Research and Applications*, 10(3), 342-357.
- Liang, T.-P., Ho, Y.-T., Li, Y.-W., & Turban, E. (2011). What drives social commerce: The role of social support and relationship quality. *International Journal of electronic commerce*, 16(2), 69-90.
- Lin, H.-F. (2008). Determinants of successful virtual communities: Contributions from system characteristics and social factors. *Information & Management*, 45(8), 522-527.
- Lin, H.-H., & Wang, Y.-S. (2006). An examination of the determinants of customer loyalty in mobile commerce contexts. *Information & Management*, 43(3), 271-282.
- Lin, H. F. (2008). Determinants of successful virtual communities: Contributions from system characteristics and social factors. *Information & Management*, 45(8), 522-527.
- Lou, H., Chau, P. Y., & Li, D. (2005). Understanding individual adoption of instant messaging: An empirical investigation. *Journal of the Association for Information Systems*, 6(4), 5.
- Lu, Y., & Yang, D. (2011). Information exchange in virtual communities under extreme disaster conditions. *Decision Support Systems*, 50(2), 529-538.
- Ma, M., & Agarwal, R. (2007). Through a glass darkly: Information technology design, identity verification, and knowledge contribution in online communities. *Information Systems Research*, 18(1), 42-67.
- Markus, M. L. (2005). Technology-shaping effects of e-collaboration technologies: Bugs and features. *International Journal of e-Collaboration*, 1(1), 1-23.
- Mason, R. O. (1978). Measuring information output: A communication systems approach. *Information & Management*, 1(4), 219-234.
- Mason, W., & Suri, S. (2012). Conducting behavioral research on Amazon's Mechanical Turk. *Behavior research methods*, 44(1), 1-23.
- McKinney, V., Yoon, K., & Zahedi, F. M. (2002). The measurement of web-customer satisfaction: An expectation and disconfirmation approach. *Information Systems Research*, 13(3), 296-315.
- Ng, C. S.-P. (2013). Intention to purchase on social commerce websites across cultures: A cross-regional study. *Information & Management*, 50(8), 609-620.
- Oliver, R. L. (1994). Conceptual issues in the structural analysis of consumption emotion, satisfaction, and quality: Evidence in a service setting. *Advance in Consumer Research*, 21(0), 16-22.
- Olsen, N. C. (2014). *The social news system: Examining the relationship between psychological sense of community, social network site use, and news sharing behaviors*. (Doctoral Dissertation), University of Minnesota, Minnesota.
- Parasuraman, A., & Grewal, D. (2000). The impact of technology on the quality-value-loyalty chain: a research agenda. *Journal of the academy of marketing science*, 28(1), 168-174.
- Parasuraman, A., Zeithaml, V. A., & Malhotra, A. (2005). ES-QUAL: A multiple-item scale for assessing electronic service quality. *Journal of service research*, 7(3), 213-233.
- Park, H., & Cameron, G. T. (2014). Keeping it real: Exploring the roles of conversational human voice and source credibility in crisis communication via blogs. *Journalism & Mass Communication Quarterly*, 91(3), 487-507.
- Patterson, P. G., & Spreng, R. A. (1997). Modelling the relationship between perceived value, satisfaction and repurchase intentions in a business-to-business, services context: An empirical examination. *International Journal of service Industry management*, 8(5), 414-434.

- Petter, S., DeLone, W., & McLean, E. (2008). Measuring information systems success: models, dimensions, measures, and interrelationships. *European journal of information systems*, 17(3), 236-263.
- Petter, S., DeLone, W., & McLean, E. R. (2013). Information systems success: The quest for the independent variables. *Journal of Management Information Systems*, 29(4), 7-62.
- Petter, S., & McLean, E. R. (2009). A meta-analytic assessment of the DeLone and McLean IS success model: An examination of IS success at the individual level. *Information & Management*, 46(3), 159-166.
- Phang, C. W., Kankanhalli, A., & Sabherwal, R. (2009). Usability and sociability in online communities: A comparative study of knowledge seeking and contribution. *Journal of the Association for Information Systems*, 10(10), 2.
- Pitt, L. F., Watson, R. T., & Kavan, C. B. (1995). Service quality: a measure of information systems effectiveness. *MIS quarterly*, 173-187.
- Preece, J. (2000). *Online communities: Designing usability and supporting socialbility*: John Wiley & Sons, Inc.
- Rouibah, K. (2008). Social usage of instant messaging by individuals outside the workplace in Kuwait: A structural equation model. *Information Technology & People*, 21(1), 34-68.
- Scott, M., DeLone, W. H., & Golden, W. (2011, June). *IT quality and egovernment net benefits: a citizen perspective*. Paper presented at the European Conference on Information Systems, Helsinki.
- Seidman, G. (2013). Self-presentation and belonging on Facebook: How personality influences social media use and motivations. *Personality and Individual Differences*, 54(3), 402-407.
- Shanmugam, M., Sun, S., Amidi, A., Khani, F., & Khani, F. (2016). The applications of social commerce constructs. *International Journal of Information Management*, 36(3), 425-432.
- Shannon, C. E., & Weaver, W. (1949). *The Mathematical Theory of Communication* (Champaign, IL. Urbana: University of Illinois Press.
- Shin, H. K., & Kim, K. K. (2010). Examining identity and organizational citizenship behaviour in computer-mediated communication. *Journal of Information Science*, 36(1), 114-126.
- Simmel, G. (1910). How is society possible? *American Journal of Sociology*, 16(3), 372-391.
- Simmel, G., & Hughes, E. C. (1949). The sociology of sociability. *American Journal of Sociology*, 55(3), 254-261.
- Sprouse, J. (2011). A validation of Amazon Mechanical Turk for the collection of acceptability judgments in linguistic theory. *Behavior research methods*, 43(1), 155-167.
- Stafford, T. F., Stafford, M. R., & Schkade, L. L. (2004). Determining uses and gratifications for the Internet. *Decision Sciences*, 35(2), 259-288.
- Tam, J. L. (2004). Customer satisfaction, service quality and perceived value: An integrative model. *Journal of marketing management*, 20(7-8), 897-917.
- Teas, R. K., & Agarwal, S. (2000). The effects of extrinsic product cues on consumers' perceptions of quality, sacrifice, and value. *Journal of the academy of marketing science*, 28(2), 278-290.
- Van der Heijden, H. (2004). User acceptance of hedonic information systems. *MIS quarterly*, 695-704.
- Venkatesh, V., & Davis, F. D. (2000). A theoretical extension of the technology acceptance model: Four longitudinal field studies. *Management science*, 46(2), 186-204.
- Verhagen, T., Feldberg, F., van den Hooff, B., Meents, S., & Merikivi, J. (2011). Satisfaction with virtual worlds: An integrated model of experiential value. *Information & Management*, 48(6), 201-207.
- Wang, L. C., Baker, J., Wagner, J. A., & Wakefield, K. (2007). Can a retail web site be social? *Journal of Marketing*, 71(3), 143-157.
- Wang, Y. S. (2008). Assessing e-commerce systems success: a respecification and validation of the DeLone and McLean model of IS success. *Information Systems Journal*, 18(5), 529-557.
- Xu, J. D., Benbasat, I., & Cenfetelli, R. T. (2013). Integrating service quality with system and information quality: An empirical test in the e-service context. *MIS quarterly*, 37(3).
- Yang, Z., & Peterson, R. T. (2004). Customer perceived value, satisfaction, and loyalty: The role of switching costs. *Psychology & Marketing*, 21(10), 799-822.
- Yu Su, Y., Than Win, K., Fulcher, J., & Chia Chiu, H. (2009). Measuring end-users' opinions for establishing a usercentred Electronic Health Record (EHR) system from the perspective of nurses. *Journal of theoretical and applied electronic commerce research*, 4(2), 55-63.
- Zeithaml, V. A. (1988). Consumer perceptions of price, quality, and value: A means-end model and synthesis of evidence. *The journal of marketing*, 52(3), 2-22.
- Zheng, Y., Zhao, K., & Stylianou, A. (2013). The impacts of information quality and system quality on users' continuance intention in information-exchange virtual communities: An empirical investigation. *Decision Support Systems*, 56, 513-524.

Zhou, Z., Fang, Y., Vogel, D. R., Jin, X.-L., & Zhang, X. (2012). Attracted to or locked in? Predicting continuance intention in social virtual world services. *Journal of management information systems*, 29(1), 273-306.

# **Sense-Giving Strategies of Media Organisations in Social Media Disaster Communication: Findings from Hurricane Harvey**

## **Julian Marx**

Professional Communication in Electronic Media/Social Media  
University of Duisburg-Essen  
Duisburg, Germany  
Email: julian.marx@uni-due.de

## **Milad Mirbabaie**

Professional Communication in Electronic Media/Social Media  
University of Duisburg-Essen  
Duisburg, Germany  
Email: milad.mirbabaie@uni-due.de

## **Christian Ehnis**

Discipline of Business Information Systems  
The University of Sydney  
Sydney, Australia  
Email: christian.ehnis@sydney.edu.au

## **Abstract**

Media organisations are essential communication stakeholders in social media disaster communication during extreme events. They perform gatekeeper and amplification roles which are crucial for collective sense-making processes. In that capacity, media organisations distribute information through social media, use it as a source of information, and share such information across different channels. Yet, little is known about the role of media organisations on social media as supposed sense-givers to effectively support the creation of mutual sense. This study investigates the communication strategies of media organisations in extreme events. A Twitter dataset consisting of 9,414,463 postings was collected during Hurricane Harvey in 2017. Social network and content analysis methods were applied to identify media communication approaches. Three different sense-giving strategies could be identified: retweeting of local in-house outlets; bound amplification of messages of individual to the organisation associated journalists; and open message amplification.

**Keywords** media organisations, social media, crisis communication, disaster communication, sense-giving

## 1 Introduction

Social media platforms are used as essential communication channels during crisis events. Different stakeholders such as individuals from the public, emergency management agencies (EMAs), non-government organisations (NGOs), and media organisations use social media to seek and share information. We know that individuals use these platforms to share their experiences or information (Imran et al. 2014), to organise help (Bunker et al. 2015), and for emotional support (Qu et al. 2011). EMAs use social media to provide trustworthy information, to share warnings, to engage with the public, or as a source (Reuter et al. 2012) for building situational awareness (Power and Kibell 2017). Literature in the domain of social media crisis communication mostly makes EMAs and their use of social media the focal point of research (e.g. Ahmed 2011; Palen et al. 2010), and investigates how EMAs are embedded in the collective sense-making process (Stieglitz et al. 2018; Weick 1988). Media organisations, too, have a crucial role in this process (Stieglitz et al. 2017) as they provide information and commentaries on the unfolding events. However, there has been little attention given to the role of journalistic coverage and its distribution in social media. At the same time, there is a knowledge gap on how information providers, as opposed to information seekers, contribute to collective sense-making. In an intra-organisational context, such actors are labelled as sense-givers (Giuliani 2016), but there is little known on how they contribute to public disaster coverage.

Disasters are chronicled from multiple sources by linking audio-visual media to social media messages, which enhances its perception. Particularly, users close to the site of events tend to include photographs and videos in their reporting (Bruns et al. 2012; Oh et al. 2010). This changes the nature of media coverage of disasters, as online communities can act as connected eyewitnesses who are not framed by mainstream media (Mortensen 2015). Traditional media outlets have entered the competition of social media news coverage and may apply the same logic to their practices. Media organisations may be considered to be sense-givers due to the fact that they pursue the interest of broadcasting information, thus, influencing perceptions on a disaster (Giuliani 2016; Pratt 2000). In this study, we focus on sense-giving strategies of media organisations in social media disaster communication. Therefore, the vital research questions are:

**RQ1:** How do media organisations distribute crisis information in social media?

**RQ2:** What are the strategies of media organisations to exert sense-giving during extreme events?

To uncover communication approaches of media organisations, we analyse their social media performance during a large scale natural disaster event – Hurricane Harvey in 2017. We created a Twitter dataset consisting of 9,414,463 tweets posted during the event. We apply social network analysis and content analysis techniques to interpret this data.

The paper is structured as follows. First, we provide an overview of the literature around crisis communication on Twitter and sense-making. Afterwards, we outline our research design, including data collection and data analysis procedures. Our findings section covers the outcomes of our data analysis. We then discuss the findings based on the theoretical construct. We conclude this paper with contributions, limitations, and implications for future research.

## 2 Literature Review – Crisis Communication on Twitter

In recent years, crisis communication participants have come to recognise that, Twitter, in particular, is the social medium of choice when it comes to exchanging crisis-related information online (Reuter et al. 2012). Disaster communications on Twitter includes the reporting of eyewitness accounts and relief activities (Hughes and Palen 2009; Oh et al. 2010). Twitter is not only a platform for sourcing information, but also soliciting donations, organising volunteers, publicising the names of missing persons, or broadcasting immediate needs during disaster events (Starbird and Palen 2012). While Twitter started out as a supplementary platform to link to external resources, the service has evolved to a source for mainstream media coverage itself (Bruns et al. 2012). Crawford (2010) describes Twitter as a network in which “rituals and transmissions are imbricated: communities of interest form clusters, and messages pass between them, with the occasional message being circulated to a much wider group” (p.150). The characteristics of Twitter, among other social media, added a novel logic to the dynamics between mass media, organisations and individuals (Dijck and Poell 2013). Literature often focusses on EMAs as organisations directly involved. EMAs may greatly benefit from voluntarily provided information on Twitter (Ehnis and Bunker 2013; Subba and Bui 2017). Studies indicate that EMAs often do not effectively position themselves as influential actors during crisis communication phases on Twitter, compared to other societal roles (Bakshy et al. 2011; Stieglitz et al. 2017). The validation and trustworthiness of information remains a crucial challenge (Schenk and Sicker 2011). Well-established

media organisations and individual role types such as journalists, celebrities, or bystanders tend to amplify the dissemination of valuable information with greater magnitude (Mirbabaie and Zapatka 2017; Starbird and Palen 2012).

Influential communication participants can be characterised by large numbers of retweets of their posts, but also through actively retweeting others (Bruns et al. 2012). Local EMAs can often be regarded as topic authorities on Twitter communications which only contribute in a few discussions or relevant events (Pal and Counts 2011). In contrast, Media organisations tend to be general authorities, frequently publishing about a variety of topics and holding a large following. Scholars have examined credibility of journalistic coverage on Twitter (Castillo et al. 2011), and how disaster reporting influences traditional media coverage and vice versa (Valenzuela et al. 2017). Still, it is unclear how media reports diffuse through Twitter and gain decisive influence.

### 3 Theoretical Background

#### 3.1 Deconstructing Sense-making through Role-based Approaches

Achieving a common understanding of the unfolding events during a disaster is important. Different communication participants vary in how much power and influence they can exert on inter-subjective knowledge creation. To uncover patterns, several studies employ a role-based approach by assigning social media users to different categories based on their characteristics (e.g. Blum et al. 2014; Ehnis et al. 2014). The study on hand might benefit from pre-defined classifications based on societal roles (Mirbabaie et al. 2014), network positioning (Mirbabaie and Zapatka 2017), and content (Blum et al. 2014). This allows researchers to better conceptualise how event participants utilise platforms to interact and communicate; carry out relationships and processes (Cornelissen 2012); and perform various tasks against the background of specific events.

Case study research of this kind aims to reproduce relational patterns between involved entities (Kohlbacher 2006). Those are still somehow attached to the events of the corresponding crisis case, but might be transferred onto other contexts if bundled under the superstructure of role-specific archetypes of social media communication. Those types may be determined through breaking down social expectations and integrate users into a spectrum of role clusters, i.e. political groups, individuals, commercial organisations, non-governmental organisations, EMA, and media organisations (Mirbabaie et al. 2014).

#### 3.2 Making and Giving Sense in Crisis Situations

We employ sense-giving as a subsumable concept of sense-making. Originating in the context of organisational theory, sense-making was extensively devised by Karl Weick, who qualifies it as a process that “*unfolds as a sequence in which people [...] engage ongoing circumstances from which they extract cues and make plausible sense retrospectively, while enacting more or less order into those ongoing circumstances*” (Weick et al. 2005, p.409). Crisis situations, particularly, surface the need for sense-making within organisations due to low probability of events and involved actors being unprepared (Weick 1988). Scholars have shown eclectic creativity on how to transfer the concept of sense-making onto other domains and contexts. The applicability of sense-making within the sphere of public crisis communication seems indisputable. Inverting the observations that could be made within organisations to an unbound societal perspective holds promising realisations for research on public crisis communication. Communities may collectively work toward mutual sense by means of social media, or find even more uncertainty on an individual level if collective efforts fail (Dailey and Starbird 2015).

The contra effect of information seeking and its provision is mirrored in sense-making theory. Sense-demanding (Vlaar et al. 2008) is up against sense-giving (Pratt 2000), or even sense-breaking (Giuliani 2016). While these sub-concepts describe possible occurrences or deliberate actions during the sense-making process, they are not exclusive. A single communication participant may exert effects on more than one stream of meaning, e.g. performing sense-demanding and sense-giving efforts on different fronts of knowledge. Sense-giving describes the attempt to influence or change the way others perceive a situation and steer actions towards a favourable direction (Aanestad and Blegind 2016). The way crisis communication participants perform sense-giving is yet to be investigated. Therefore, our study aims to explore acts of sense-giving by media organisations during Hurricane Harvey.



## 4 Case Background – Hurricane Harvey 2017

In late August of 2017, the coastline of Texas and parts of Louisiana faced the destructive force of category 4 hurricane ‘Harvey’. It approached the mainland of Texas near Corpus Christi on the 26<sup>th</sup> of August. Officials declared a state of disaster and several counties decided to evacuate residential areas. The storm resulted in severe floods and winds had gust speeds up to 215 km/h. Shortly after, Harvey reached the urban areas of Houston and continued to release heavy rainfalls that swamped large parts of the city. The hurricane lost strength on August 30<sup>th</sup> after which recovery and reconstruction measurements commenced (Sternitzky-DiNapoli 2017). In contrast to human-induced incidents such as terror attacks or other unforeseen events, Hurricane Harvey had the character of a predictable crisis. Weather forecasts gave insight for planning and anticipated the effects of the event before unfolding. Strong public interest and extensive media coverage developed in the course of the crisis.

## 5 Research Design

### 5.1 Data Collection

The projected case study builds upon a dataset of relevant Twitter data concerning Hurricane Harvey. By the means of a self-developed Java crawler and the open source library Twitter4J3, six days of Twitter communication from the 26<sup>th</sup> (0:00 UTC) to the 31<sup>st</sup> (23:59 UTC) of August 2017 was collected. To obtain only relevant data, only content containing the keywords *hurricaneharvey*, *harvey*, *hurricane* was crawled. The selection of keywords was based on their usage frequency during the crisis as well as the predominant usage of hashtags, which are included in the selected keywords. Moreover, the crawler was set to only gather data provided with English language settings. This data tracking resulted in a dataset of 9,414,463 tweets. The extracted data was stored in a MySQL database for further pre-processing.

### 5.2 Data Analysis

The data was analysed with social network analysis and content analysis techniques (Stieglitz et al. 2018a). To utilise these research methods, the dataset needed to be processed further. First, the dataset needed to match the requirements of a social network analysis tool. Second, the data material had to be made accessible for content analysis procedures. To determine influence on Twitter, we turn to literature that suggests a combined set of metrics including original tweets, retweets, mentions as well as characteristics from graph theory (Pal and Counts 2011). Subsequent to methodical steps involving data analytics, collating a study’s findings with network and content behavioural archetypes from the literature might be substantial towards understanding the sense-making efforts of single user roles (Mirbabaie and Zapatka 2017; Blum et al. 2014). Hence, the research design of this study is constructed upon a combined approach of network metrics and user roles. To increase the manageability of the dataset, it was divided into six segments consisting of tweets for each day. The number of segments was determined to match the criteria of (a) complying with the chronological sequence of events and (b) conforming to the requirements of analysis tools, i.e. reducing the data volume for each social network analysis (Stieglitz et al. 2018b).

#### 5.2.1 Social Network Analysis

Data was processed in order to be displayed in a social network analysis tool, including the configuration of both edges (links) and nodes (vertices) of the network (graph). According to graph theory, centrality measures of may reveal characteristics and social ties of certain network participants (Wasserman and Faust 1994). In a directed retweet network, the in-degree represents the number of retweets a user received and serves as a strong indicator for the reach of a message (Kwak et al. 2010). Power users are defined as the communication participants who receive the highest number of retweets in relation to the frequency of their overall output (Oh et al. 2015). We use these power users as an approximation for influential users. To obtain representative power users of predefined communication roles, accounts were ranked based on their in-degree value and subsequently assigned to the fitting role category. This sample of power users provided a manageable set of tweets for qualitative content analysis. We used social network analysis procedures to (1) compile a sample of influential tweets, and (2) reveal relevant power users, in particular media organisations.

#### 5.2.2 Content Analysis

To determine what types of messages were influential during Hurricane Harvey, we created a sample of power users and their respective tweet sets. We focused on power users, because each media organisation is classified as a power user. By implication they hold influential positions in the network

and, therefore, complies with our definition of sense-givers. We scanned through the daily ranking of top 100 power users in descending order until each role type (adapted from Mirbabaie and Zapatka 2017) occurred at least five times among the most visible power users. The six daily rankings per role were merged to one overall ranking to eliminate double entries. This was necessary to ensure an uncluttered view on the entire activity profile of potentially influential media-related accounts over the course of the crisis. We then coded the tweets of journalists and media organisations on the basis of a self-developed codebook, following the guidelines of Mayring (2000, 2014). It was developed using pre-defined role types from the literature (Mirbabaie 2014; Stieglitz et al. 2017), to distinguish media organisations and journalists from each other and remaining communication roles. After separately coding the sample, the inter-rater reliability was calculated to verify if all coders used the codebook in an equal manner. Using Krippendorff's alpha, a score of .887 was calculated. Our coding can be rated as reliable as  $\alpha \geq .800$  (Krippendorff 2013).

## 6 Findings

In total, there were 9,414,463 tweets in the dataset, authored by 1,093,349 unique users. Considering our power-user sample of 100 influential accounts per day, media organisations made up the most active role type during the six-day period, as 57.7% of the sample's content stems from involved media outlets, followed by EMA (15.5%) and journalists (8.8%). These figures, as shown in table 1, relate only to original tweet frequency, with no consideration of the actual reach of such messages.

Role type	Number of accounts	Tweet volume	Percentage
Media Organisation	12	734	57.70%
EMA	12	198	15.50%
Journalists	20	112	8.80%
Private Person	20	69	5.40%
Politicians	18	56	4.40%
Influencers/Bloggers	20	55	4.30%
Celebrities	19	50	3.90%

Table 1. Activity of top 5 power users per role type and per day (combined).

In order to serve our research objective, we narrow down the subsequent analysis to media organisations and journalists. The resulting sub-sample contains a total of 846 tweets. As part of the content analysis, we classified each tweet according to its information type. The underlying codebook was equipped with 17 different information types. As with the role classification, only occurring information types were listed in table 2. This listing also includes retweeting or replying one of the information types, e.g. a journalist retweeting an official statement.

Role type (Tweets)	Official statement	News/Crisis Information	Personal opinion	Personal Experience	Forwarding message	Solicitousness	Marketing
Media Organisation (739)	11(1%)	626(85%)	0(0%)	40(5%)	54(8%)	3(1%)	5(1%)
Journalist (73)	0(0%)	66(60%)	12(11%)	11(10%)	18(16%)	3(3%)	0(0%)

Table 2. Information types used by each role

Media organisations primarily focussed on the distribution of crisis information and news (85%). The numbers of crisis information provided by media organisations have the highest absolute score in the sample (626). Journalists' postings, too, contain mostly crisis information (60%).

To take another glimpse beneath the surface of how information is being disseminated through media organisations, illustrative examples of this role type and an in-depth analysis of representing accounts provides valuable insight. The initial codebook provided a distinction between national media outlets and international media organisations. However, throughout the analysis, an additional subcategory emerged within the realm of media organisations. Whereas international media organisations are not represented in our sample, a clear distinction could be made between national and regional media organisations. The sample contained a total of 12 accounts that represent a media outlet, which are listed in table 3. Among those accounts, one account (@thehill), received retweets from postings prior to the tracking, but was not authoring about Hurricane Harvey during the six-day period. Nine accounts actively tweeted and are considered national (or widely recognised) media outlets (@MSNBC, @NBCNews, @washingtonpost, @ABCNews, @CBSNews, @CNN, @FoxNews, @AP, @nytimes), and two are classified as regional media outlets (@abc13houston, @HoustonChron).

Media outlet	Tweets	Retweets	Replies	T/h*	Indegree**	Betweenness centrality***
ABC News	4	1	0	0.03	30,310(2)	0.00
ABC13Houston	73	65	0	0.96	12,768(5)	120,533,523.78
CBS News	4	3	0	0.05	13,705(2)	480,742.74
CNN	22	2	0	0.17	44,828(4)	16,535,160.94
Fox News	125	0	0	0.87	17,419 (6)	484,511.93
Houston Chronicle	266	99	1	2.54	8,618(4)	110,538,287.61
MSNBC	0	7	0	0.05	17,516(1)	7952881.12
NBC News	33	11	0	0.31	38,472(2)	170,269,093.88
New York Times	0	2	0	0.01	7,973(6)	26,062,251.89
The Associated Press	3	12	0	0.1	13,137(6)	485,304.48
The Hill	0	0	0	0	19,123(1)	0.00
Washington Post	1	0	0	<0.01	12,530(1)	230,110.90

\*tweet frequency=original tweets+retweets+replies/6\*24 hours

\*\*highest daily indegree value during 6-day period (day)

\*\*\*value corresponding to max. indegree (same day)

*Table 3. Media organisation's total metrics*

Some of the national media organisations focussed on retweeting information from external sources (@MSNBC, @AP, @nytimes). Others produced content and forwent retweeting (@washingtonpost, @CNN, @FoxNews). The regional outlets, however, show significantly higher numbers in terms of creating original content as well as retweeting other sources. The Houston Chronicle Twitter account, which represents a local daily newspaper, sent out 2.54 tweets per hour, whereas the most frequently tweeting national media outlet (@FoxNews) only posted 0.87 Harvey-related tweets per hour. At the same time, both regional media outlets score significantly high on betweenness centrality. Frequently authoring and retweeting relevant tweets, a high indegree and betweenness centrality are indicators for highly influential users (Pal and Counts, 2011). Table 4 shows the different approaches of both media outlets on how to distribute information. The @HoustonChron account retweeted almost exclusively journalists. The three exceptions occurred, when the Houston Chronicle account retweeted local EMA.

Regional media outlet	Performed retweets	Retweeted private persons	Retweeted journalists	Retweeted others
ABC 13 Houston	65	12	28	25
Houston Chronicle	99	0	96	3

*Table 4. Comparison of regional media outlets' retweet activity*

Taking a closer look at the retweeted journalist accounts, revealed that every single account (28 unique users) belongs to reporters/employees of the Houston Chronicle. The account frequently retweeted eyewitness reports experienced by their reporters (e.g. Chron\_MattYoung). After retweeting this eyewitness report, which was complemented by an image, the @HoustonChron account turned the information into an original tweet.

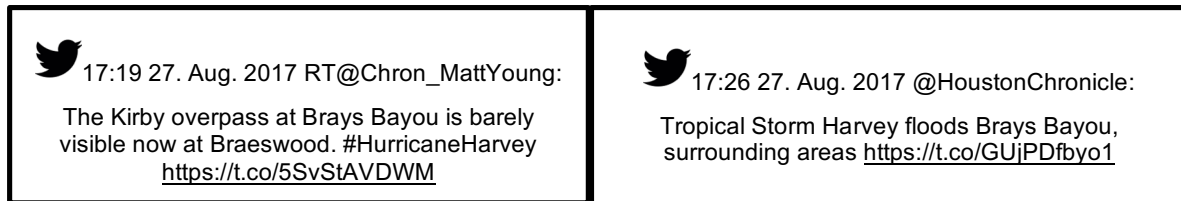

Other than @HoustonChron, the Twitter presence of the regional TV station @abc13houston included eyewitness reports authored by private persons into their publishing strategy. In an earlier tweet, @abc13houston encouraged their followers to submit eyewitness reports using #ABC13Eyewitness.

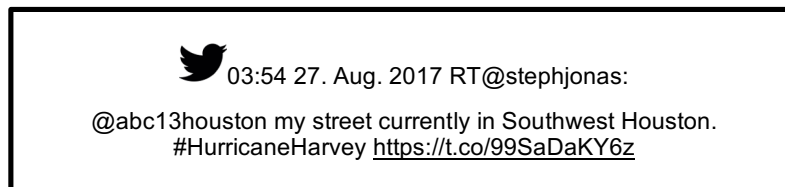

The journalists retweeted by @abc13houston were, similar to @HoustonChron, reporters of their own branch. Figure 1 shows the ego-network graphics of both media outlets on August 26th, the first day of the six-day period. It visualises all retweets that were sent from each account (@abc13houston's outdegree=33; @HoustonChron's out-degree=22). The size of a node indicates the influence of an account on that day (indegree value). The ten users with the highest indegree were labelled for more clarity. The colour of an edge as well as the node colours emphasise the role type of an account (blue=media organisation, green=EMA, grey=private person, red=politician, purple=journalist).

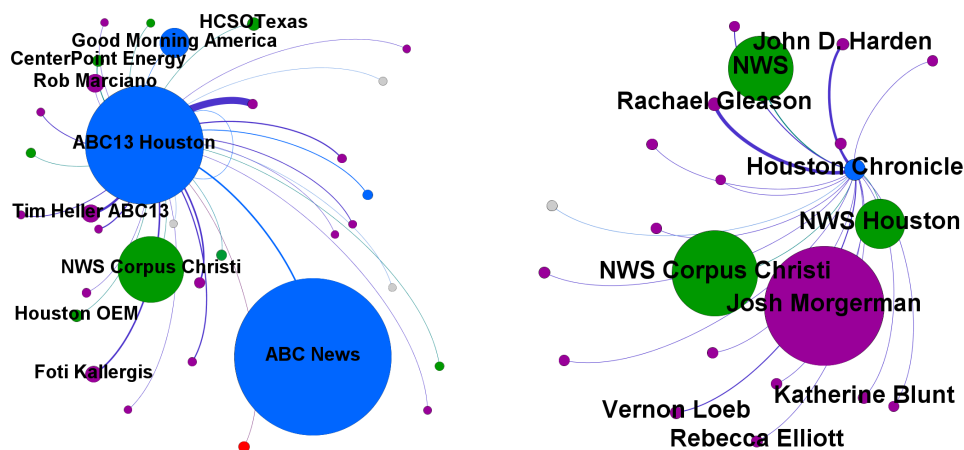

Figure 1: Ego-network @abc13houston (left) and ego-network @HoustonChron (right)

Both local media outlets differ in how influential their accounts were with regards to the indegree. @abc13houston was retweeted 8748 times, whereas @HoustonChron counts an indegree value of 652. Both accounts retweeted mostly journalists. The @abc13houston account forwarded messages of 18 journalists, 1 politician, 3 private persons, 8 EMAs and 3 other media organisations. The @HoustonChron account, however, limited their retweet recipients to 3 EMA, and 19 journalists, who are officially denoted as reporters of the Houston Chronicle. Another observation pointing to the dynamics of national, regional and on the spot information can be made by looking at the retweet behaviour of @AP, which is the Twitter account of the nationwide media outlet “The Associated Press”. The activity of this account amounts for retweeting @APCentralRegion 10 times (out of 12 total retweets). In this case, a nationwide media outlet retweeted its regional branch. The @abc13houston account, in contrast, did not receive any retweets by @ABCNews.

## 7 Discussion

Due to the predictable character of the Hurricane Harvey crisis, official institutions as well as media organisations, were able to pre-arrange social media communication strategies and put systems of coverage in place. Our data shows that media organisations author a large number of unique content, but also function as bridges between users of other role categories. The examination of media organisations as a central communication role during Hurricane Harvey revealed three strategies of media organisations to leverage their social media reach during crisis events. As shown in figure 2, media organisations can use (1) popularity arbitrage by retweeting their local in-house outlet. During Hurricane Harvey, The Associated Press (@AP) did rarely author original content related to the crisis. Instead, their nation-wide account focussed on retweeting @APCentralRegion.

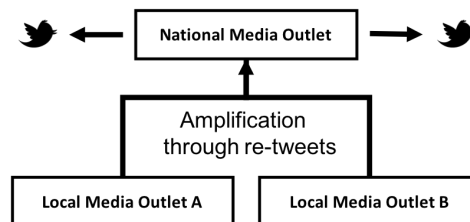

Figure 2: Strategy 1- Popularity arbitrage by retweeting their local in-house outlets

Another strategy to increase network-related influence is (2) bound amplification through quality assured sources such as in-house journalists. The local newspaper @HoustonChron strategically retweeted journalists exclusively reporting for the Houston Chronicle. Due to the large number of individual journalists (28), this accumulation of eyewitness reports covered a major part of the crisis region as the reporters were distributed over the entire Houston area. It scaled the reach of those messages as all 28 journalists used their individual Twitter account to instantaneously report from the crisis scene. Eventually, their content was edited and uploaded to the Houston Chronicle website and posted as an original tweet via @HoustonChron. At the same time, this strategy (figure 3) served as quality assurance – a factor of trustworthiness personal experiences and eyewitness reports often do not provide (Schenk and Sicker 2011).

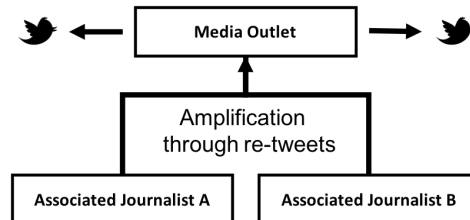

Figure 3: Strategy 2- Bound amplification through quality assured sources such as in-house journalists

Including public tweets in an organisation's Twitter activity leads to (3) open amplification. Demonstrated by @abc13houston, this strategy involves eyewitness reports of any role type but primarily private persons. During Hurricane Harvey, the news outlet even called out for contributions by using the hashtag #ABC13Eyewitness or mentioning @abc13houston in the tweet. This procedure does not only engage members of the public to actively report crisis information but also serves as a mechanism to overcome information overload. Even though @abc13houston performed a well-organised social media strategy and positioned themselves as an authority in terms of both network and content, potential leverage was left unattended. The popular parent account @ABCNews refrained from retweeting its regional branch. Scholars defined the issue of effectively listening and filtering social media crisis communication as one of the most crucial challenges for crisis responders (Oh et al., 2010). Leveraging influence as shown in figure 4 clearly addresses this shortcoming among crisis responders and might be useful for practical implications.

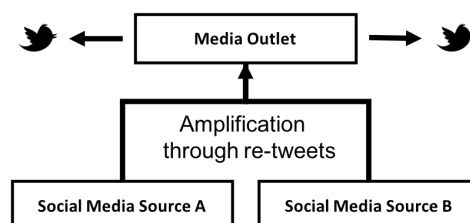

Figure 4: Strategy 3- Open amplification of social media sources

Overall, media organisations were found to leverage their influence and, therefore, contribute to sense-making by providing crisis information. This qualifies media organisations to be seen as sense-givers who support collective knowledge creation (Aanestad and Blegind 2016). Sense-giving is an attempt to steer actions towards a favoured direction (Giuliani 2016). Media organisations who focalise sense-giving efforts are capable of creating an information prevalence. These efforts, if information are accurate, may result in improved knowledge or relief actions. In our case, local media outlets such as @HoustonChron and @abc13houston gathered public information through retweeting reporters and/or private persons. This three-level hierarchy of national, local, and individual journalism comprises of useful strategies to reduce complexity and benefit collective sense-making.

## 8 Conclusion and Further Research

This study attempts to unfold social media communication strategies of media organisations during disasters. To that matter, we conducted a content analysis on Twitter postings that were distributed during the critical phase of Hurricane Harvey in 2017. We combined this method with social network analysis procedures to be able to carry out a more precise examination of the media outlets that were most engaged in the communication network. Our results reveal local media outlets, in particular, play a critical role in disseminating of crisis information, and thus, to be decisive sense-givers. We identified three different sense-giving strategies of media organisations: retweeting local in-house outlets; bound amplification of messages of individual associated journalists; and open message amplification.

Our study contributes to the existing body of knowledge on social media disaster communication as it emphasises the standing of media organisations as an authority to complement crisis response operations. Whereas most scholars focus on enhancing social media utilisation for EMAs, we bring attention to media organisations. This provides a more differentiated view on the coexistence of certain societal roles which hold stakes in social media crisis communication. Additionally, we pursued to translate the notion of sense-giving onto the domain of social media disaster communication. Theorising our findings in this way may help to reach an improved understanding of how knowledge is being created during extreme events. EMAs should have the conception of themselves to be a publishers of crisis information during extreme events. EMAs, too, are often organised as local and nationwide branches. Hence, the same amplification mechanics concern EMAs, which may take publishing strategies of media organisations as a paragon for information distribution. Our study comes with limitations as we focused on Twitter data exclusively, which has specific characteristics. This snippet of communication recording does not cover the entire crisis communications, but mirrors social media's major share, as Twitter has become leading-edge for disaster coverage. Moreover, restricting the data collection to certain keywords and a confined timespan may exclude relevant messages. Even though the six-day period covers a majority of the Harvey-related Twitter communication, our tracking missed postings from before and after the main events.

Further research in this area might cover the challenges for media organisations when facing an unpredictable crisis event. Delving deeper into this could encompass interviews with media organisations. Moreover, one could extend the investigation of crisis coverage to other social media platforms and examine the intersection of social media strategies with traditional media reporting. On a theoretical level, adjoining sub-concepts of sense-making such as sense-demanding or sense-breaking with regards to media organisations seem worthwhile to investigate.

## 9 References

- Aanestad, M., and Blegind, T. 2016. "Collective Mindfulness in Post-Implementation IS Adaptation Processes" in *Information and Organization* (26:1), pp. 13–27.
- Ahmed, A. 2011. "Using Social Media in Disaster Management" in *Proceedings of the International Conference on Information Systems*, Shanghai: China, pp. 16–27.
- Bakshy, E., Hofman, J. M., Mason, W. A., and Watts, D. J. 2011. "Everyone's an Influencer" in *Proceedings of the ACM International Conference on Web Search and Data Mining*, Hong Kong: China, pp. 65–74.
- Blum, J., Kefalidou, G., Houghton, R., Flintham, M., Arunachalam, U., and Goulden, M. 2014. "Majority Report: Citizen Empowerment through Collaborative Sensemaking" in *Proceedings of the International Conference on Information Systems for Crisis Response and Management*, University Park, Pennsylvania: USA, pp. 767–771.
- Bruns, A., Burgess, J., Crawford, K., and Shaw, F. 2012. "#qldfloods and @QPSMedia: Crisis

- Communication on Twitter in the 2011 South East Queensland Floods” in *Brisbane: ARC Centre of Excellence for Creative Industries and Innovation*, pp. 1–57.
- Bunker, D., Sleight, T., Levine, L., and Ehnis, C. 2015. “Disaster Management: Building Resilient Systems to Aid Recovery” in *Research Proceedings from the Bushfire and Natural Hazards CRC & AFAC Conference*, pp. 1–6.
- Castillo, C., Mendoza, M., and Poblete, B. 2011. “Information Credibility on Twitter” in *Proceedings of the International Conference on World Wide Web*, Hyderabad: India, pp. 675–684.
- Cornelissen, J. P. 2012. “Sensemaking Under Pressure: The Influence of Professional Roles and Social Accountability on the Creation of Sense” in *Organization Science* (23:1), pp. 118–137.
- Crawford, K. 2010. “News To Me: Twitter and the Personal Networking of News” in *News Online*, pp. 135–156.
- Dailey, D., and Starbird, K. 2015. ““It’s Raining Dispersants” Collective Sensemaking of Complex Information in Crisis Contexts” in *Proceedings of the ACM Conference on Computer Supported Cooperative Work & Social Computing*, Vancouver, BC: Canada, pp. 155–158.
- Dijck, J. Van, and Poell, T. 2013. “Understanding Social Media Logic” in *Media and Communication* (1:1), pp. 2–14.
- Ehnis, C., and Bunker, D. 2013. “The Impact of Disaster Typology on Social Media Use by Emergency Services Agencies: The Case of the Boston Marathon Bombing” in *Proceedings of the Australasian Conference on Information Systems*, Melbourne: Australia, pp. 1–12.
- Ehnis, C., Mirbabaie, M., Bunker, D., and Stieglitz, S. 2014. “The Role of Social Media Network Participants in Extreme Events” in *Proceedings of the Australian Conference of Information Systems*, Auckland: New Zealand, pp. 1–10.
- Giuliani, M. 2016. “Sensemaking, Sensegiving and Sensebreaking” in *Journal of Intellectual Capital* (17:2), pp. 218–237.
- Hughes, A., and Palen, L. 2009. “Twitter Adoption and Use in Mass Convergence and Emergency Events” in *International Journal of Emergency Management* (6:3/4), p. 248–260.
- Imran, M., Castillo, C., Diaz, F., and Vieweg, S. 2014. “Processing Social Media Messages in Mass Emergency: A Survey” in *ACM Computing Surveys* (47:4), pp. 1–38.
- Kohlbacher, F. 2006. “The Use of Qualitative Content Analysis in Case Study Research” in *Forum: Qualitative Social Research* (7:1), pp. 1–30.
- Krippendorff, K. 2013. *Content Analysis: An Introduction to Its Methodology*, (3rd edition), Thousand Oaks, CA: Sage.
- Kwak, H., Lee, C., Park, H., and Moon, S. 2010. “What Is Twitter, a Social Network or a News Media?” in *Proceedings of the International World Wide Web Conference*, Raleigh, North Carolina: USA, pp. 1–10.
- Mayring, P. 2000. “Qualitative Content Analysis,” in *Forum Qualitative Research* (1:2), p. 1–10.
- Mayring, P. 2014. *Qualitative Content Analysis: Theoretical Foundation, Basic Procedures and Software Solution*, Klagenfurt.
- Mirbabaie, M., Ehnis, C., Stieglitz, S., and Bunker D. 2014. “Communication Roles in Public Events - A Case Study on Twitter Communication” in *Proceedings of the Working Conference on Information Systems and Organizations*, Auckland: New Zealand, pp. 207–218.
- Mirbabaie, M., and Zapatka, E. 2017. “Sensemaking in Social Media Crisis Communication - A Case Study on the Brussels Bombings in 2016” in *Proceedings of the European Conference on Information Systems*, Guimarães: Portugal, pp. 2169–2186.
- Mortensen, M. 2015. “Connective Witnessing: Reconfiguring the Relationship between the Individual and the Collective,” in *Information Communication and Society* (18:11), pp. 1393–1406.
- Oh, O., Eom, C., and Rao, H. R. 2015. “Role of Social Media in Social Change: An Analysis of Collective Sense Making During the 2011 Egypt Revolution” in *Information Systems Research* (26:1), pp. 1–14.
- Oh, O., Kwon, K. H., and Rao, R. H. 2010. “An Exploration of Social Media in Extreme Events: Rumor

- Theory and Twitter during the Haiti Earthquake 2010” in *Proceedings of the International Conference on Information Systems*, St. Louis: USA, pp. 1–15.
- Pal, A., and Counts, S. 2011. “Identifying Topical Authorities in Microblogs” in *Proceedings of the ACM International Conference on Web Search and Data Mining*, Hong Kong: China, p. 45-54.
- Palen, L., Anderson, K. M., Mark, G., Martin, J., Sicker, D., Palmer, M., and Grunwald, D. 2010. “A Vision for Technology-Mediated Support for Public Participation & Assistance in Mass Emergencies & Disasters” in *Proceedings of ACM-BCS Visions of Computer Science*, Edingburgh: United Kingdom, pp. 1–12.
- Power, R., and Kibell, J. 2017. “The Social Media Intelligence Analyst for Emergency Management” in *Proceedings of the Hawaii International Conference on System Sciences*, pp. 313–322.
- Pratt, M. G. 2000. “The Good, the Bad, and the Ambivalent: Managing Identification among Amway Distributors,” in *Administrative Science Quarterly* (45:3), p. 456-493.
- Qu, Y., Huang, C., Zhang, P., and Zhang, J. 2011. “Microblogging after a Major Disaster in China” in *Proceedings of the ACM Conference on Computer Supported Cooperative Work*, Hangzhou: China, p. 25-34.
- Reuter, C., Marx, A., and Pipek, V. 2012. “Crisis Management 2.0” in *International Journal of Information Systems for Crisis Response and Management* (4:1), pp. 1–16.
- Schenk, C. B., and Sicker, D. C. 2011. “Finding Event-Specific Influencers in Dynamic Social Networks” in *Proceedings of the IEEE International Conference on Privacy, Security, Risk and Trust*, Boston: USA, pp. 501–504.
- Starbird, K., and Palen, L. 2012. “(How) Will the Revolution Be Retweeted?: Information Diffusion and the 2011 Egyptian Uprising” in *Proceedings of the ACM Conference on Computer Supported Cooperative Work*, pp. 7–16.
- Sternitzky-DiNapoli, D. 2017. Timeline of Hurricane Harvey, for those who don't know what day it is, *Houston Chronicle*. Last retrieved on October 10<sup>th</sup> 2018: <https://www.chron.com/news/houston-weather/hurricaneharvey/article/Hurricane-Harvey-timeline-12169265.php>
- Stieglitz, S., Meske, C., Ross, B., and Mirbabaie, M. 2018. “Going Back in Time to Predict the Future - The Complex Role of the Data Collection Period in Social Media Analytics” in *Information Systems Frontiers* (June), pp. 1–15.
- Stieglitz, S., Mirbabaie, M., Fromm, J., and Melzer, S. 2018. “The Adoption of Social Media Analytics for Crisis Management - Challenges and Opportunities” in *Proceedings of the European Conference on Information Systems*, Portsmouth: United Kingdom, pp. 1-19.
- Stieglitz, S., Mirbabaie, M., and Milde, M. 2018. “Social Positions and Collective Sense-Making in Crisis Communication” in *International Journal of Human-Computer Interaction* (34:4), pp. 328–355.
- Stieglitz, S., Mirbabaie, M., Schwenner, L., Marx, J., Lehr, J., and Brünker, F. 2017. “Sensemaking and Communication Roles in Social Media Crisis Communication” *Proceedings of the Internationale Tagung Wirtschaftsinformatik*, St. Gallen: Switzerland, pp. 1333–1347.
- Subba, R., and Bui, T. 2017. “Online Convergence Behavior, Social Media Communications and Crisis Response: An Empirical Study of the 2015 Nepal Earthquake Police Twitter Project” in *Proceedings of the Hawaii International Conference on System Sciences*, pp. 284–293.
- Valenzuela, S., Puente, S., and Flores, P. M. 2017. “Comparing Disaster News on Twitter and Television: An Intermedia Agenda Setting Perspective” in *Journal of Broadcasting and Electronic Media* (61:4), pp. 615–637.
- Vlaar, P., van Fenema, P., and Tiwari, V. 2008. “Cocreating Understanding and Value in Distributed Work” in *MIS Quarterly* (32:2), pp. 227–255.
- Wasserman, S., and Faust, K. 1994. *Social Network Analysis Methods And Applications*, Cambridge University Press.
- Weick, K. E. 1988. “Enacted Sensemaking in Crisis Situations,” in *Journal of Management Studies* (25:4), pp. 305–317.
- Weick, K. E., Sutcliffe, K. M., and Obstfeld, D. 2005. “Organizing and the Process of Sensemaking” in *Organization Science* (16:4), pp. 409–421.



**Copyright:** © 2018 Julian Marx, Milad Mirbabaie, and Christian Ehnis. This is an open-access article distributed under the terms of the [Creative Commons Attribution-NonCommercial 3.0 Australia License](https://creativecommons.org/licenses/by-nc/3.0/australia/), which permits non-commercial use, distribution, and reproduction in any medium, provided the original author and ACIS are credited.

# Social Bots as Initiators of Human Interaction in Enterprise Social Networks

## Christian Meske

Department of Information Systems  
School of Business & Economics  
Freie Universität Berlin and Einstein Center Digital Future  
Berlin, Germany  
Email: christian.meske@fu-berlin.de

## Ireti Amoj

Department of Information Systems  
School of Business & Economics  
Freie Universität Berlin and Einstein Center Digital Future  
Berlin, Germany  
Email: ireti.amoj@fu-berlin.de

## Abstract

Enterprise Social Networks (ESNs) are said to have the potential to significantly improve communication and collaboration between employees. However, utilization is still a problem in organizations, as participation is voluntary. Current research on Affordance theory in IS research suggests one reason being that users may not always recognize the opportunities for action and the potential outcome of the corresponding actualization. In our qualitative study in a medium-sized company, we investigate how experiencing offline networking with other ESN users will help to recognize online networking potentials, leading to an increased actualization of ESN affordances. In addition, we investigate the role of social bots (here: Lunch Roulette Bot), which provoke interaction by inviting users to meet other employees for lunch, therefore nudging users to experience certain actualizations like offline networking. We find that social bots can be more helpful than conventional one-to-many solicitations of the management and help increase human interaction in ESN.

**Keywords** enterprise social networks, affordance theory, social bots, social media

## 1 Introduction

The presence of technology is evermore noticeable in many aspects of human life. In particular the increasing relevance of technology in enterprise settings shapes and influences not only the way organizations do business but also the way they work and function internally (Leonardi 2013). Enterprise Social Networks (ESN) as such a technology help facilitate communication and collaboration processes between workers across different subsidiaries, departments or hierarchy levels (Riemer et al. 2017). In doing so, ESNs provide opportunities for private messaging between only two actors as well as public messaging in open communication channels. Moreover, users can maintain personal user profiles and interact with other user profiles by liking or commenting on their content. Top level management implements ESNs into organizational infrastructures to enable their workers and improve the flow of information not just across hierarchies but also among employees on the same hierarchical level (Riemer et al. 2015; Stieglitz et al. 2014). Accordingly, in the process of exchanging work-related information on ESNs, employees may also socialize and build personal relationships. This added value of introducing ESN in the work environment and thereby improving enterprise social exchange and decreasing anonymity is becoming a favorable indirect consequence of ESNs. However, research shows that some workers can show low activity in soft factors such as exchanging task-related information resources, socializing with colleagues, or both (Meske and Stieglitz 2013).

According to Affordance Theory, differences in technology adoption such as varying levels of network activity and feature usage are possible due to differences in technology perception and awareness of technology affordances (Leidner et al. 2018). “Affordances” can be understood as a general opportunity for action to individuals who interact with a particular technology (Volkoff and Strong 2013). Basic affordance assumptions and factors determining technology use thereby include individual levels of awareness (here: perception), individual preferences or contextual use, which may vary within collective groups of individuals using the same communication and collaboration tools (Volkoff and Strong 2013). Research shows that for instance, the socializing potential of ESN use in organizations is surprisingly often not perceived and consequently not actualized by ESN users, even if advertised by management (Leidner et al. 2018). Instead of disseminating information of potential use cases top-down, nudging the employees to individually experience the advantages of e.g. socialization is an alternative and promising way to encourage new ESN affordances. One facet of more individualized interaction on social media has been realized through social bots. In the process of the increased enterprise social media diffusion in organizations social bots growingly become a facet of the interaction in the work environment. For this purpose, we argue that instead of top-down management communication, social bots could be used as a resource to nudge ESN users to experience interaction with other colleagues. Namely because social bots can provide a low cost, time- and space-independent version of a key user on the ESN, who provoke interaction as they are often perceived as neutral sources of information, which communicate at eye-level with other users. Social bots are characterized as automatic or semi-automatic computer programs, which mimic human behavior while interacting with humans on the network (Wagner et al. 2012; Davis et al. 2016). Furthermore, in the particular context of organizational ESN, in order to help users understand the advantages of digital interaction potentials, it may also be beneficial to facilitate respective networking-experiences outside of the technology, which in turn can make digital social networking potentials more visible (Zhang and Venkatesh 2013). In consequence, our research question reads: *How can social bot induced offline-interaction lead to a change in perceptions of ESN affordances and actualization?*

To investigate according assumptions, we will survey one specific case in a medium-sized enterprise marketing agency, which uses a social bot to randomly bring ESN users into offline contact. In this case the social bot functions as a programmatically controlled Bot-user who interacts with other ESN users as if it was human. By randomly assigning real world lunch appointments, the potential of interaction with colleagues is made visible to workers across departments and hierarchies in order to decrease social interaction barriers, which consequently may lead to novel ESN affordances and actualizations. For this purpose, we conduct qualitative interviews with workers in the case company who have used the Lunch Roulette Bot. The research objective of this study is hence twofold. First, we investigate the potential of social bots in nudging ESN users to interact. Second, we investigate the recursive effects between experiences in the online and offline environment that affect technology affordances and actualization.

The remainder of this paper is structured as follows: First, we will begin by presenting the status quo on the current scientific discourse about the applicability of ESNs in work environments. We then review the existing literature on social bots, which is a comparatively new object of study in information systems research. Thereafter, we will introduce Affordance Theory as the theoretical foundation of the socio-technical paradigm presented in our work. We then will provide our research design. The paper ends with first findings of our qualitative study.

## 2 Literature Review

### 2.1 Enterprise Social Networks in Organisations

Scott et al. (2016) define ESNs as “platform[s] for tight integration of multiple types of Web 2.0 tools into a single private/semi-private network for businesses and organizations” (p. 2). Basically, ESNs are virtual networks within the company to help enhance work processes by offering different features such as blogs, wikis, and open or closed communication channels as well as discussion boards (Schneider and Meske 2017). In their basic functionality, ESNs can be compared to Social Networks like Facebook or Twitter. Nevertheless, they differ in regard to their accessibility as ESNs are restricted to the Enterprise setting and therefore only grant access to authorized actors. Due to the restriction to enterprise settings and apart from cases in which customers or business partners are granted access (Turban et al. 2011), ESNs provide a new form of Intranet in which the links between two or more actors represent professional relationships. IS researchers have shown the ESN significance to organizations by tending to the various ESN features and their provided opportunities for interaction (Dimicco et al. 2008; Moqbel and Aftab 2015). There is a multitude of ESN features which can support actors to orchestrate their relationships such as possibilities to create customized online profiles for instance. Other features provide opportunities to connect with colleagues and track their activities. Sharing content and experiences by exchanging short messages via direct messages or blogs, or posting, commenting, editing, and linking files during the exchange with others (Leonardi 2013) are also opportunities for feature use.

However, due to the default setting character of the mentioned features in most ESNs, users are more likely to exercise a feature bias towards the technology functionalities they are familiar with or see the most potential given the context in which they use the technology (Leonardi and Vasst 2017). That way feature utilization is more dependent on individual preferences regardless of the potential features an ESN has to offer. A variety of factors may influence feature use such as organizational contexts or personal perception (Chemero, 2001). For instance, research shows that there are intrinsic altruistic motivations and extrinsic motivations that influence network participation (Wasko and Faraj 2005). Intrinsic reasons such as the desire to help others can be viewed as genuine drivers to enhance interaction. A genuine interest in network participation and interaction with colleagues may bring many benefits to the organization. In fact, more recent research focuses on the indirect added value of ESNs in organizations. Thereby key subjects to research are the access to intra organizational exchange of information and knowledge, the overall increased group performance, or the enhancement of social capital. Meanwhile, extrinsic reasons such as increased attention or visibility are short lived as they are not self-sustainable (Ke and Zhang 2010) and may influence interaction seeking only with individuals who are valued as beneficial in realizing extrinsically motivated goals. Research shows that extrinsically motivated people who view the use of an ESN as strictly work related or as something mandatory they are getting paid to do, will not perceive socializing features as valuable (Roberts et al. 2006). Instead they will predominantly utilize ESNs to exchange work related information or finish tasks and refrain from exhausting the full ESN potential. As exhausting ESN potentials to enhance intra organizational interaction remains an overall management goal and the realization of this goal is subject to research in this work, we will now assess possibilities of enhancing intra organizational interaction. Accordingly, social bots will be introduced as a means to enhance interaction in the enterprise setting.

### 2.2 Social Bots

A new type of computer algorithms, known as social media robots and often referred to as social bots or bots have an increasing presence on public social media like Facebook (Wagner et al. 2012). Social bots characterize as automatic or semi-automatic computer programs (Wagner et al. 2012), which produce content (Davis et al. 2016) on social networks. They are unique in that they mimic human behavior while interacting with humans on networks (Boshmaf et al. 2012). Accordingly, social bots have perfected simulating the way humans communicate and interact online (Freitas et al. 2015). Moreover, another important characteristic of social bots is that they have the ability to perform human activities such as posting messages or requesting to connections to other actors, thereby growing their ties within the network (Boshmaf et al. 2012). Though the intentions to deploy social bots in networks are not always bad, they can also be harmful in cases where they are deployed to spread unverified or false information (Ferrara 2017). There are several examples of social bot misuse in the literature ranging from social bots functioning as spam to social bots deployed to mislead publics or slander politicians to artificially gain support and in consequence sway public opinion towards a favorable political candidate (Ferrara 2017). In such cases social bots may target social networks in general or specific online communities to either reach an influential position with the most possible impact on the collective opinion or perform some kind of online surveillance (Boshmaf et al. 2012). Despite the many examples of negative social bot influence, there are other instances where social bots have been deployed to entertain, help, disseminate

information or simply interact with human users on the network (Davis et al. 2016; Ferrara 2017). As the boundaries between human-like and bot-like behavior get harder to decipher, research has tried to identify relevant distinctions to uncover bot networks on social media. One approach to research on social bots by Freitas et al. (2015) assessed key aspects in order to differentiate between content posted by different kinds of social bots as opposed to content posted by humans. On the basis of their findings the researchers then developed a machine learning model as a tool to enable social bot detection more easily (Freitas et al. 2015). Other research approaches are less concerned with social bot detection and rather focus on consequences of social bot interaction. Therein research has developed means to deploy machine learning to predict user's vulnerability to social bot attacks (Wagner et al. 2012).

Despite the broad research interests in both social bot detection as well as assessing the consequences of social bot activity on public social media, much less research has been applied to the role of social bots in enterprise settings. Research results by Wagner et al. (2012) indicate that users who are more susceptible to social interaction in ESNs are also more susceptible to interacting with social bots. Though as social bots mimic social behavior and provoke interaction with humans, there is a potential for social bots to help exhaust the full potential of ESN feature use even in individuals less susceptible to social interaction. Before assessing the role of social bots in closing this gap, we will first assess the theoretical background in differences between ESN features and ESN Affordances to understand why ESN potentials may not be exhausted equally within the same organization.

### 3 Theoretical Background

An important aspect of Affordance Theory is that humans have to recognize (technology) features in order to be able to carry out a respective action (Chamero 2003). Opportunities for action are never endless and can also be constraining (Leonardi 2013). In fact, an individual's goals and abilities determine how he or she affords an object, though the object's affordance may change according to the particular context in which it is used (Faraj and Azad 2012). Meaning, that if a technology user recognizes certain features he or she may actualize features that help satisfy a particular goal and disregard features that do not serve a purpose in a given context. At the same time the option to "like" content in an ESN may be afforded to express applause in one context and to give consent or approval for project agendas in another context. As Chemero (2001) framed it "action is preceded by perception" (p. 115) and until affordances are actualized they remain mere potentials for action. Affordance Theory has its roots in the field of Ecological Psychology. James J. Gibson is the founding father of both, ecological psychology and Affordance Theory. He developed the research approach based on his interest in perceptual psychology and how the environment affords humans a variety of possible actions (Gibson 1966). Further, he stated that humans' actualizations of affordances are perceptually driven and defined environmental cues as information-based accordingly. Following that, the study of perceptual psychology analyses cognition in regard to relations between (human) agents and others systems (Chemero 2003). An important aspect of affordances as opposed to other human-technology centered theories is that both technologies and humans possess agency, meaning the power to influence or modify state of affairs. In IS literature the concept of affordances is viewed from a social-technical paradigm applying the concept of affordances to the relationship between humans and technologies (Chemero 2003; Volkoff and Strong 2013). Thereby, an affordance emerges as an opportunity for action to individuals who interact with a particular technology (Hutchby 2001).

This differentiated view of perception, use, features, action, and outcomes offers a first approach to distinguish the various aspects of affordances which according to research has not yet been given enough attention (Leidner et al. 2018). Every interaction between humans and technologies begins with the technology use and consequently affords the user of the technology certain possibilities for action. As features posit the potential for action, users may continue to actualize some features which they perceive has useful and disregard others. Depending on the feature actualization every technology affordance ends in a particular outcome of the affordance generated by using the technology in the first place (Leonardi, 2011). Accordingly, ESNs are not afforded to provoke social interaction in cases where such affordances are for whatever reason not perceived. This is where research has yet to provide possible solutions as to how such beneficial technology affordance can be nudged. Therefore, we aim to close this gap by assessing the potential role of social bots in driving social interaction. In the following we will now layout our research design and preliminary findings for both, the role of social bots in exhausting ESN potentials as well as the change in ESN affordance after a social bot induced offline interaction.

## 4 Research Design

We adopted the critical realist perspective as fitting to conduct our research within an open, in terms of non-restrictive with unpredicted outcomes (Carlsson 2011), but at the same time enterprise specific and regulated (social) system. Critical realism generally describes an epistemology where micro- and macro level dynamics in the real world are actualized in specific contexts, connecting them to the empirical domain (Bhaskar 2008; Mingers 2010). We found the critical realist notion fitting in explaining potentially new empirical outcomes. Considering social bots in the enterprise context and further assessing their role as human interaction enhancing is rather novel, we set out with a single case study. Thereby, we aim to utilize described potentials of single case studies such as for instance the discovery of unique insights (Seidel et al. 2013), in the attempt to make a valuable contribution to the empirical domain. Moreover, we realize that said potentials also satisfy the reasons for appropriate use of case studies according to Yin (1989): First, most small-and medium sized enterprises (SME) are aware of ESNs and make efforts to implement such technologies in their organization. Nevertheless, much less prominent is assessing the technology efficacy in terms of its individual user actualization in SMEs. This is where our case fits the premise of uniqueness because introducing social bots as a way to increase ESN feature actualization has not been suggested in research. The SME in our case has about 100 employees and is in the consulting business. The ESN “Slack” was introduced in January of 2016 to support networking across hierarchies and departments. In the process of affording Slack there are a variety of different features such as for instance open and closed communication channels or posting pictures provided to the users. A user who has the goal to communicate more with his or her colleagues on ESNs may afford the technology to interact with peers. There are said features like open or closed channels which the user can actualize in pursuit of his or her goals. We will interview about 10-15 employees from the entry-, mid-, and senior-level of authority at the SME to explore the distribution of contextual use and individual goals for ESN affordance. On their ESN, the SME integrated a social bot function, called Lunch Roulette. The Lunch Roulette bot is an algorithm which randomly matches roulette participants who sign up for lunch dates. The social bot then moderates the interaction by informing participants of their assigned dates in a one-to-one message. The SME uses this particular bot function since the beginning of their Slack implementation because it atomizes the matching processes and initiates interaction between anonym participants. What makes Lunch Roulette a typical bot service is its human-like participant interaction. According to the case company, the bot proactively approaches ESN users who are more active as well as nondescript, task-oriented participant users who are more socially withdrawn. Thereby, the bot takes on a neutral role and makes it less socially awkward for people to get in touch.

For our data analysis, we followed the approach by Henfridsson and Bygstad (2013), who describe the following four steps to identify mechanisms to explain new empirical outcomes: identification of the objects in the case, identification of key mechanisms, and analysis of contextual conditions as well as analysis of the outcomes of the mechanisms. In accordance with the Henfridsson and Bygstad (2013), we conduct our own analysis procedure as follows: in a first step we use a self-developed coding scheme to identify the role of social bots in facilitating social interaction among colleagues with high anonymity, and from different departments or hierarchy levels. Thereby, we mainly focus on statements revealing *the role of the Bot in provoking* interaction and the influence thereafter on the continued online interaction. In a second step we code for mentioned affordances prior to social bot interaction to draw a comparison with identified changes in ESN perception and technology use in a third step. In a fourth step we then differentiate between technology use and feature actualization to clearly distinguish new affordances and their said outcomes. Currently, we are in the process of conducting up to 15 interviews with employees from the entry, mid-level and senior level, and have completed 3 of them. In the following we will now show first findings for both, the role of social bots in exhausting ESN potentials as well as the change in ESN affordance after a social bot induced offline interaction.

## 5 Preliminary Results and Implications

Our first three interviews confirm the assumption that social bots influence social interaction and consequently also technology affordances. The interviews resulted in the identification of Slack bots as widely accepted, natural parts of the network structure which request users to do something, provide individualized answers and information or run employer branding measures (Interviewee 2, entry-level). The lunch bot in particular acts as a significant accelerator of social interaction across hierarchical levels and departmental structures. This is also illustrated by Interviewee 3 (senior-level) who said: “(...) *the lunch bot helped me break the ice with colleagues outside of my peer group that I would otherwise not have approached within the first week*”. In terms of consequent online interaction, we learned that a bot-mediated offline interaction in turn provokes an increased online interaction. “Yes, I would

*definitely say that quickly getting to know so many different people offline made my Slack activity increase exponentially (...) for instance I remember feeling encouraged to post an interesting article in the open channel because a colleague I had met previously was super visible on there*" (Interviewee 1). In turn, this suggests a new technology affordance in terms of actualizing the open channel feature, which was not perceived as useful prior to the offline interaction in the SME. Interviewee 3 also stated that she is very output oriented but interacting with new colleagues offline occasioned her to "*initiate private online groups*", which is a Slack feature she knew about but did not perceive as useful prior to meeting colleagues offline. The new Slack affordances and consequent feature actualizations demonstrate that social bot induced offline interaction may influence increased online interaction and connectedness outcomes.

Overall, our findings so far provide several contributions to research and practice. For one, our case study contributes an empirical study to the existing body of knowledge regarding affordance theory. We further introduce social bots into the research field of ESNs and therefore aim to initiate a theoretical debate focused on the future of digital work environments. Moreover, we implicate that social bots may indirectly influence technology affordances and respective actualizations. This being the case our contribution to practice is a renewed awareness of the influence and user-perception of social bots in the work environment. Top level-management and decision makers need be aware of the fact that social bots are widely accepted and welcomed in the SMA. Given this positive perception we could show that social bots can provoke increased interaction and new feature use on the ESN, which in turn leads to an improved utilization of ESN-potentials.

## 6 Conclusion

Our case study highlights the influence of social bots on the user-interaction among workers in an SMA. We were able to assess that the neutrality of the bot and its perceived informality of interaction on the ESN is beneficial in provoking offline interaction in the SMA. Through bot-mediated lunch dates, workers build second-base (social) relationships with their colleagues in a neutral lunch-date environment outside of the enterprise setting. Though lunch-dates did not exclusively lead to increased social ties in the SMA, workers perceived them as significantly impacting their overall socialness in the SMA, especially in terms of meeting colleagues outside of their peer group or comfort zone. Moreover, this initiated (offline) social interaction to some extent provoked an increased interaction in the ESN. According to our case study, bot-induced lunch dates influence certain features-use in the ESN such as communication style and channel use.

## 7 References

- Boshmaf, Y., Muslukhov, I., Beznosov, K., and Ripeanu, M. 2013. "Design and analysis of a social botnet," *Computer Networks* (57:2), February, pp 556–578.
- Carlsson, S. 2011. "Critical Realist Information Systems Research in Action," *Researching the future of Information Systems* (356), June, pp 269–284.
- Chemero, A. 2001. "What We Perceive When We Perceive Affordances: Commentary on Michaels (2000) Information, Perception, and Action," *Ecological Psychology* (13:2), pp 111–116.
- Chemero, A. 2003. "An Outline of a Theory of Affordances," *Ecological Psychology* (15:2), pp 181–195.
- DiMicco, J., Millen, D. R., Geyer, W., Dugan, C., Brownholtz, B., and Muller, M. 2008. "Motivations for social networking at work". In *Proceedings of the ACM 2008 conference on Computer supported cooperative work - CSCW '08*, p. 711.
- Davis, C. A., Varol, O., Ferrara, E., Flammini, A., and Menczer, F. 2016. BotOrNot. In *Proceedings of the 25th International Conference Companion on World Wide Web*, April, pp 273–274.
- Faraj, S., and Azad, B. 2012. *The Materiality of Technology: An Affordance Perspective*. In *Materiality and Organizing: Social Interaction in a Technological World*. Oxford: Oxford University Press.
- Ferrara, E. 2017. "Disinformation and social bot operations in the run up to the 2017 French presidential election," *First Monday* (22:8), July, pp 1–33.
- Freitas, C., Benevenuto, F., Ghosh, S., and Veloso, A. 2015. "Reverse Engineering Socialbot Infiltration Strategies in Twitter". In: *Proceedings of the 2015 IEEE/ACM International Conference on Advances in Social Networks Analysis and Mining*, August, pp 25–32.

- Gibson, J. J. 1966. *The senses considered as perceptual systems*. Oxford: Houghton Mifflin.
- Henfridsson, O., and Bygstad, B. 2013. "The Generative Mechanisms of Digital Infrastructure Evolution," *MIS Quarterly* (37:3), September, pp 896-931.
- Hutchby, I. (2001). Technologies, texts and affordances. *Sociology*, 35, 441–456.
- Ke, W., and Zhang, P. 2010. "The Effects of Extrinsic Motivations and Satisfaction in Open Source Software Development," *Journal of the Association for Information Systems* (11:12), pp 784–808.
- Leidner, D. E., Gonzalez, E., and Koch, H. 2018. "An affordance perspective of enterprise social media and organizational socialization," *Journal of Strategic Information Systems* (27:2), pp 1–22.
- Leonardi, P. M. 2011. "When Flexible Routines Meet Flexible Technologies: Affordance, Constraint, and the Imbrication of Human and Material Agencies," *MIS Quarterly* (35:1), March, pp 147–167.
- Leonardi, P. M. 2013. "When Does Technology Use Enable Network Change in Organizations? A Comparative Study of Feature Use and Shared Affordances," *MIS Quarterly* (37:3), pp 749–776.
- Leonardi, P. M., and Vaast, E. 2017. "Social Media and Their Affordances for Organizing: A Review and Agenda for Research," *Academy of Management Annals* (11:1), October, pp 150–188.
- Meske, C. and Stieglitz, S. 2013. "Adoption and Use of Social Media in Small and Medium-sized Enterprises," In: *Proceedings of the 6th Practice Driven Research on Enterprise Transformation*, pp. 61-75.
- Mingers, J. 2010. "The Contribution of Systemic Thought to Critical Realism," *Journal of Critical Realism* (10: 3), April, pp 303-330.
- Moqbel, M. A., and Aftab, F. 2015. "Employees' Social Networking Site Use Impact on Job Performance: Evidence from Pakistan," *AIS Transactions on Replication Research* (1:6), December, pp 1-11.
- Riemer, K., Stieglitz, S. and Meske, C. 2015. "From Top to Bottom: Investigating the Changing Role of Hierarchy in Enterprise Social Networks," *Business Information Systems Engineering* (57:3), pp. 197-212.
- Roberts, J. A., Hann, I.-H., and Slaughter, S. A. 2006. "Understanding the Motivations, Participation, and Performance of Open Source Software Developers: A Longitudinal Study of the Apache Projects," *Management Science* (52:7), July, pp 984–999.
- Scott, K. S., Sorokti, K. H., and Merrell, J. D. 2016. "Learning "beyond the classroom" within an enterprise social network system," *The Internet and Higher Education* (29), April, pp 75–90.
- Schneider, J. and Meske, C. 2017. "Gender Differences in Enterprise Social Network Usage and Transformation Over Time," In: *Proceedings of the 38th ICIS*, pp 1–12.
- Stieglitz, S., Riemer, K., and Meske, C. 2014. "Hierarchy or Activity? The Role of Formal and Informal Influence in Eliciting Responses From Enterprise Social Networks", In: *Proceedings of the 22nd European Conference on Information Systems (ECIS)*, Track 07, Paper 12.
- Turban, E., Bolloju, N., and Liang, T. P. 2011. "Enterprise social networking: Opportunities, adoption, and risk mitigation," *Journal of Organizational Computing and Electronic Commerce* (21:3), July, pp 202–220.
- Volkoff, O., and Strong, D. 2013. "Critical Realism and Affordances: Theorizing IT-Associated Organizational Change Processes," *MIS Quarterly* (37:3), September, pp 819-834.
- Wagner, C., Mitter, S., Körner, C., and Strohmaier, M. 2012. When social bots attack: Modeling susceptibility of users in online social networks. *CEUR Workshop Proceedings*, April, 41–48.
- Wasko, M., and Faraj, S. 2005. "Why Should I Share? Examining Social Capital and Knowledge Contribution in Electronic Networks of Practice," *MIS Quarterly* (29:1), March, pp 35-57.
- Yin, R. K. 1989. *Case study research: Design and methods*. Applied Social Research Series, Vol. 5.
- Zhang, X., and Venkatesh, V. 2013. "Explaining Employee Job Performance: The Role of Online and Offline Workplace Communication Networks," *MIS Quarterly* (37:3), September, pp 695-722.

**Copyright:** © 2018 authors. This is an open-access article distributed under the terms of the [Creative Commons Attribution-NonCommercial 3.0 Australia License](https://creativecommons.org/licenses/by-nc/3.0/), which permits non-commercial use, distribution, and reproduction in any medium, provided the original author and ACIS are credited.



# The Potential of Social Media Analytics for Improving Social Media Communication of Emergency Agencies

## **Milad Mirbabaie**

Department of Computer Science and Applied Cognitive Science  
University of Duisburg-Essen  
Duisburg, Germany  
Email: milad.mirbabaie@uni-due.de

## **Jennifer Fromm**

Department of Computer Science and Applied Cognitive Science  
University of Duisburg-Essen  
Duisburg, Germany  
Email: jennifer.fromm@uni-due.de

## **Simone Löppenber**

Department of Computer Science and Applied Cognitive Science  
University of Duisburg-Essen  
Duisburg, Germany  
Email: simone.loeppenberg@stud.uni-due.de

## **Sophie Meinig**

Department of Computer Science and Applied Cognitive Science  
University of Duisburg-Essen  
Duisburg, Germany  
Email: sophie.meinig@stud.uni-due.de

## **Matthias Reuße**

Department of Computer Science and Applied Cognitive Science  
University of Duisburg-Essen  
Duisburg, Germany  
Email: matthias.reusse@stud.uni-due.de

## **Abstract**

A growing number of people use social media to seek information or coordinate relief activities in times of crisis. Thus, social media is increasingly deployed by emergency agencies as well to reach more people in crisis situations. However, the large amount of available data on social media could also be used by emergency agencies to understand how they are perceived by the public and to improve their communication. In this study, we examined the Twitter communication about the German emergency agency “Johanniter-Unfall-Hilfe” by conducting a frequency, sentiment, social network and content analysis. The results reveal that a right-wing political cluster politically instrumentalised an incident related to this agency. Furthermore, some individuals used social media to express criticism. It can be concluded that the use of social media analytics in the daily routine of emergency management professionals can be beneficial for improving their social media communication strategy.

**Keywords** social media analytics, crisis communication, emergency agencies, Twitter, political instrumentalisation

## 1 Introduction

A growing number of people turn to social media to interact with family members and friends, share entertaining videos, discuss opinions with others and seek information about brands, products or events (Whiting and Williams 2013). The extensive usage of social media is leading to an increasing amount of available information which could be of interest for organisations. Private sector organisations, for example, already use social media monitoring tools to gain insights into how their brand is perceived by social media users (Bekmamedova and Shanks 2014). These insights are valuable for companies, as they can adjust their social media communication strategy accordingly. Furthermore, social media data advantage the understanding of customer needs and may drive effective advertising and marketing strategies (Bekmamedova and Shanks 2014).

While a lot of companies have developed a social media strategy to establish a bidirectional communication channel with (potential) customers and gain insights based on social media analytics, non-private organisations seem to be more hesitant to implement social media into their operations. At least in Germany, emergency agencies belong to this kind of organisations; however, they are currently starting to experiment with social media. At the present time, emergency agencies in Germany use social media primarily as another broadcasting channel to disseminate warnings or behavioural advice in times of crisis and give insights into their work practices (Eismann et al. 2016). Previous studies have revealed that emergency management professionals are hesitant to use social media analytics to gain additional insights due to a lack of guidelines and training (Stieglitz, Mirbabaie, Fromm, et al. 2018). Nevertheless, they are convinced that social media communication and analytics will be an important part of their future work routine (Reuter et al. 2015).

Therefore, this research seeks to demonstrate the potential of social media analytics for improving the social media communication of emergency agencies. As organisations assisting people in emergencies and crisis situations, it is of high importance for them to maintain a positive and trustful image. The use of social media analytics can provide emergency agencies with insights into how they are perceived by the public. Hence, we examine the following research question:

**RQ: Which insights into the communication about emergency agencies can be gained through social media analytics?**

In this research, we use different methods of social media analytics (frequency analysis, sentiment analysis, social network analysis and content analysis) to analyse the Twitter communication about the German emergency agency “Johanniter-Unfall-Hilfe (JUH)”. This emergency agency is a voluntary humanitarian organisation focusing on training, emergency medical service, disaster relief, social care and international help (Johanniter-Unfall-Hilfe 2018). We decided to analyse the communication on Twitter because the microblogging platform has the advantage of a detailed Application Programming Interface (API), simplifying the access to data (Twitter 2018). Based on the results of the analysis, we derive implications for the use of social media analytics to improve the social media communication of emergency agencies. In the next section, we summarise related work on social media communication and analytics focusing on possible usage of emergency agencies. Then, we describe our research methods and the corresponding results. Afterwards, the implications of these results for the social media communication strategies of emergency agencies are discussed. At the end, the limitations of this study and avenues for further research are presented.

## 2 Background

### 2.1 Emergency Agencies and Social Media Communication

Social media platforms are increasingly used by citizens to make sense of crisis situations, seek information or coordinate relief activities (Mirbabaie and Zapatka 2017; Stieglitz, Bunker, et al. 2017; Stieglitz, Mirbabaie, and Fromm 2018). Meanwhile, social media platforms themselves offer functionalities (e.g. Facebook Safety Check) which enable users to indicate whether they are safe in times of crisis (Takahashi et al. 2015). As social media platforms allow to reach a larger proportion of the population in crisis situations, these platforms are nowadays used by media organisations and emergency agencies as well (Bruns and Burgess 2014). Interviews with emergency management professionals have revealed that they perceive social media as important for presenting their organisation, recruiting volunteers and establishing relationships with other emergency agencies or media organisations (Reuter et al. 2016). As emergency agencies strongly depend on recruiting new generations of volunteers, the relevance of social media for successful self-presentation and establishing relationships to the public increases. In practice, however, the social media usage of emergency agencies

is often limited to broadcasting information to the public via Facebook or Twitter, thus the potential of social media for two-way communication is not fully exploited (Eismann et al. 2016). Emergency agencies currently use these platforms to provide the public with short situational updates, warnings, advice and guidance on how to prevent crises or how to behave during crises (Fosso Wamba and Edwards 2014). After a crisis has been resolved, emergency agencies often publish a final report to reduce uncertainties about what has happened (Reuter et al. 2016). In addition, they make attempts to correct misinformation and counter rumors on social media (Plotnick et al. 2015). An analysis of the tweets of 100 non-profit organizations showed that emergency agencies use Twitter primarily to share information about their organisation and activities but, to a lesser extent, also for fostering relationships to media organisations and the public or calling for actions (Lovejoy and Saxton 2012). Other studies examining the Twitter communication of the Queensland Police Service or the Boston Police Department led to similar results (Ehnis and Bunker 2012, 2013). Furthermore, guidelines and best practices for improving the social media communication of emergency agencies were developed in previous research (Freberg et al. 2013; Lin et al. 2016; Rice and Spence 2016; Ross et al. 2018). These guidelines were developed with the intent to optimise information diffusion in times of crisis and suggest, for example, to use social media as an active two-way communication channel and establish relationships to the public and other organisations (Lin et al. 2016).

## 2.2 Emergency Agencies and Social Media Analytics

In addition to employing it as another communication channel, social media offers sweeping advantages for emergency agencies. A study revealed that emergency management professionals perceive it as particularly important to analyse the large amount of available social media data as well to gain valuable insights during crisis situations and routine times (Fisher Liu et al. 2012). Emergency management professionals of the American Red Cross indicated that they make first attempts at analysing how the public speaks about them on social media and detecting crisis situations earlier by monitoring news accounts (Briones et al. 2011). According to them, they occasionally learn more quickly about a severe situation this way than if they would wait until they are informed by responsible authorities. A case study further reported about the State Control Centre Victoria which recently established a social media analyst position for improving situational awareness during crisis situations (Power and Kibell 2017). In this organisation, it was found that information retrieved by analysing user-generated content (e.g. photos from eyewitnesses) can be useful for planning the necessary resources to respond to an emergency situation early on. Related to this, researchers already developed technical solutions for predicting earthquakes based on the sentiment of tweets (Sakaki et al. 2010) or retrieving relevant information from social media content to improve situational awareness (Imran et al. 2018). However, the use of social media analytics in emergency agencies is still rather an exception due to a wide range of technological, organisational and environmental challenges such as a lack of guidelines, staff trained in data analysis and several legal issues related to the collection and analysis of social media data (Stieglitz, Mirbabaie, Fromm, et al. 2018). In sum, previous studies examined how social media is used during different crisis situations and how emergency agencies in particular use social media to communicate in times of crisis. Furthermore, there are prior studies focusing on the potential of social media analytics for early crisis detection or increasing situational awareness. However, the identification of further social media analytics use cases by examining the social media communication about emergency agencies represents a pivotal research gap.

## 3 Method and Results

### 3.1 Data Collection

In a first step, we used a self-developed Java tool which establishes a connection to the Twitter Search API to collect tweets and retweets including pre-defined keywords. The retrieved dataset included all tweets and retweets in the period from the 25<sup>th</sup> February 2018 to the 13<sup>th</sup> May 2018 in which the German emergency agency JUH was mentioned. For this purpose, the name of the emergency agency (johanniter), their slogan “for the love of life” (aus liebe zum leben) and abbreviations (johnnies) were defined as keywords. Synonyms, related spellings and hashtags were automatically considered by the tracking tool. At the same time, several keywords were excluded because they refer to the “Johanniter-Orden” which is an order of knights with a similar name. After a manual check of the dataset, 370 tweets were removed because it became apparent that the two keywords “johnnys” and “johnnies” were only included in tweets that had no connection to JUH. Overall, the revised dataset contained 1.085 tweets and 533 retweets.

### 3.2 Social Media Analytics

#### 3.2.1 Frequency Analysis

We first conducted a frequency analysis to identify sudden increases in tweet activity which could indicate that an unusual discussion about JUH took place. To analyse the tweet activity over the course of the whole tracking period, we calculated the number of tweets and retweets per day. The visualisation tool Tableau was used to identify the highest peak and the resulting timeline can be seen in Figure 1.

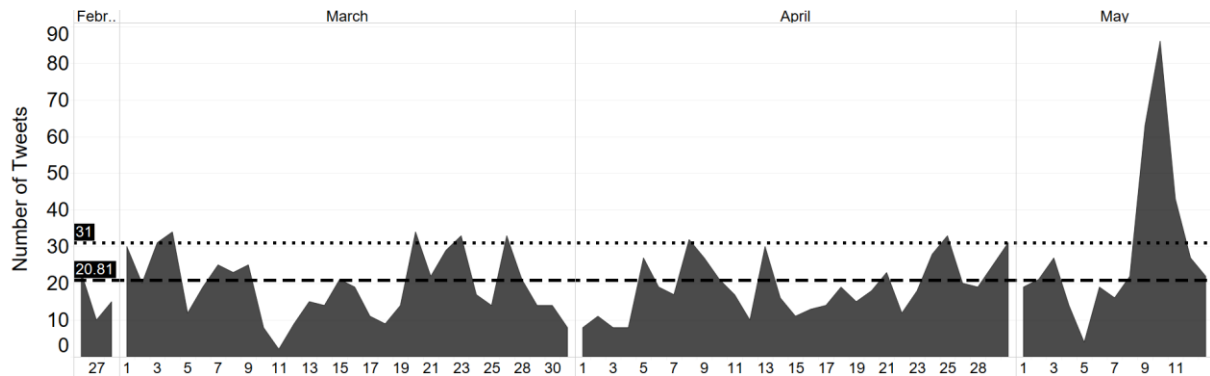

Figure 1: Number of Tweets and Retweets per Day

The average number of tweets and retweets mentioning the emergency agency JUH was 20.81 per day and the highest peak occurred from the 9<sup>th</sup> May 2018 to the 11<sup>th</sup> May 2018. On the 10<sup>th</sup> May 2018, the number of tweets mentioning JUH was 86 which is more than three times higher than the average tweet count.

#### 3.2.2 Sentiment Analysis

In addition to the tweet activity, we also calculated the average sentiment of tweets and retweets per day over the course of the whole tracking period to examine the opinion of Twitter users about JUH. The sentiment within a tweet was extracted by using the opinion mining tool SentiStrength. The tool uses a dictionary-based sentiment detection and considers a set of additional linguistic rules such as negations, booster words and emoticons (Thelwall et al. 2010). In this research, the German sentiment dictionary was used. SentiStrength estimates the negative and positive sentiment strength of a tweet or retweet by reporting two scores (Thelwall et al. 2010). The overall sentiment score of a tweet is calculated by adding the two separate scores and can range from extremely negative (-4) to extremely positive (+4). Figure 2 displays the average sentiment of all tweets and retweets per day.

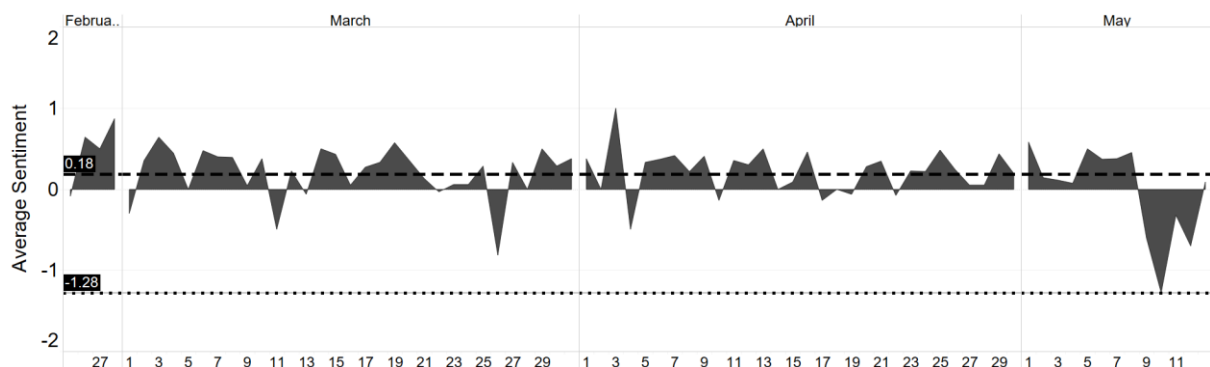

Figure 2: Average Positive and Negative Sentiment per Day

It can be seen that the communication about the emergency agency JUH was slightly positive most of the time as the average sentiment score per day was 0.18. The highest peak during the sentiment analysis could be identified on the 10<sup>th</sup> May 2018 with an average sentiment score of -1.28. This day constituted the highest peak during the frequency analysis as well.

### 3.2.3 Social Network Analysis

Furthermore, we conducted a social network analysis with the graph visualisation tool Gephi to identify influential Twitter users in the communication network around the emergency agency JUH. A retweet graph was created with 526 nodes representing Twitter users and 475 edges representing retweet activities. Then, we calculated the in-degree for each node to identify the ten most influential Twitter users. A high in-degree indicates that a node was more often retweeted than another node with a lower in-degree. Based on an existing categorisation of Stieglitz et al. (2017), the user roles of the ten nodes with the highest in-degree were identified by examining their user names and Twitter descriptions (see Table 1). The retweet network including the ten most influential nodes can be seen in Figure 3. Dyadic and triadic connections have been removed to enhance the visibility of the most influential nodes.

User Name	Role	In-Degree
JungeAlternative NRW	Political Organisation	69
Die Johanniter (JUH)	Emergency Agency	64
Johanniter Worldwide	Emergency Agency	25
AfD_Support	Individual (Political)	20
Hania Wiatrek	Individual (Political)	15
Oliver Janich	Individual (Political)	13
Polizei Mittelfranken	Emergency Agency	12
Bay. Rotes Kreuz	Emergency Agency	12
Politikversagen	Media Organisation (Political)	9
Stadt Dortmund	Government Organisation	9

Table 1. The Ten Most Influential Nodes and Their User Roles Sorted by In-Degree



Figure 3: Retweet Network Including the Ten Most Influential Nodes

It can be seen that there are two main clusters in the network. The first one evolves around the German emergency agency JUH which only operates in Germany. The other influential users in this cluster can also be classified as emergency agencies. The account “Johanniter Worldwide” belongs to the emergency agency JUH but operates in foreign countries. The account “Bay. Rotes Kreuz” does not belong to the same organisation but has similar responsibilities like JUH. The remaining account “Stadt Dortmund” is the official account of a German city. The second cluster can be found around the German political organisation “JungeAlternative NRW” which is known for conservative and right-wing populist viewpoints. This account is closely connected to “AfD\_Support” which is an unofficial Twitter account supporting the German right-wing party AfD. The cluster further includes two individuals and a media organisation both tweeting mainly political content as well as the account of a German police department.

### 3.2.4 Content Analysis

As a peak was identified from the 9<sup>th</sup> May 2018 to the 11<sup>th</sup> May 2018 during the frequency and sentiment analysis, we compared the content of the tweets created on these days with the content of the tweets created on the remaining days. We analysed the content by following the inductive category formation process of Mayring (2014). A category was built based on the content of the first tweet. The following tweets were either sorted into this category or it was decided to create a new category. As a result, the tweets were sorted into the following categories: information, job vacancy, rescue work, praise, criticism, call for action, attacks, warnings and crime. The tweets were manually coded by the research team and Cohen’s kappa was calculated to assess the inter-coder reliability (Stemler 2001). Overall, the coding process was considered as reliable ( $k = 0.79$ ). An example tweet for each category can be found in Table 2.

Category	Example Tweet
Information	Attention can rescue lives: In our first aid tip, you learn how to spot a hypothermic person and how you can help.
Job Vacancy	Employee (m/f) for the department daily help. JUH GmbH, Location: Sankt August.
Rescue Work	#winterbus helps homeless people in Bremen (German city)
Praise	Dear voluntary helpers, thank you very much for your engagement at the #half-marathon in Berlin (German city)!
Criticism	Congratulations to Berlin JUH for the most stupid job commercial based on the motto “Come to us, here you have not even time to shit after work!”
Call for Action	Let us fight on together – for a better future!
Attacks	Attacks on rescue teams have become commonplace in #Merkel’sGermany. Most “incidents” are not made public because proceedings are terminated anyhow. #frustration #migration #cuddlyjustice #AFD (right-wing party)
Warnings	Caution! People who pretend to be JUH employees are collecting donations.
Crime	The wanted person apparently wears a patient bracelet with his name and the JUH logo.

Table 2. Example Tweets for Each Category

The content of the tweets created during non-peak days can be described as follows: JUH was most often mentioned in informational tweets including first aid or health tips, information about staff changes, participation at events and the acquisition of new equipment. Furthermore, Twitter users often retweeted job advertisements of the emergency agency and attempts to recruit volunteers. Some tweets also included information about the rescue work and humanitarian projects of JUH. Moreover, the dataset contained tweets in which individual persons or other emergency agencies thanked the employees of JUH for their engagement in general or during specific events, emergencies and crisis situations. A smaller number of tweets included criticism related to the design of job advertisements, recruitment tactics of the agency, driving style of JUH employees, use of the siren at night, usability of the website and financing of the agency. Calls of JUH to participate in specific events such as first aid courses or to follow them on social media were also shared by a few users. Shortly before the highest peak, users started to retweet a news article about attacks on JUH paramedics during their work. The dataset further included a small number of warnings about persons who pretended to be JUH employees and dangers related to emergency situations or weather changes. The agency was also mentioned in a post of the police who was looking for a person wearing a bracelet with a JUH logo. Due to an incident on the 27<sup>th</sup> April 2018, the content of tweets created during the highest peak had changed considerably. In Figure 4, it can be seen which proportion of tweets were sorted into each category during peak and non-peak times.

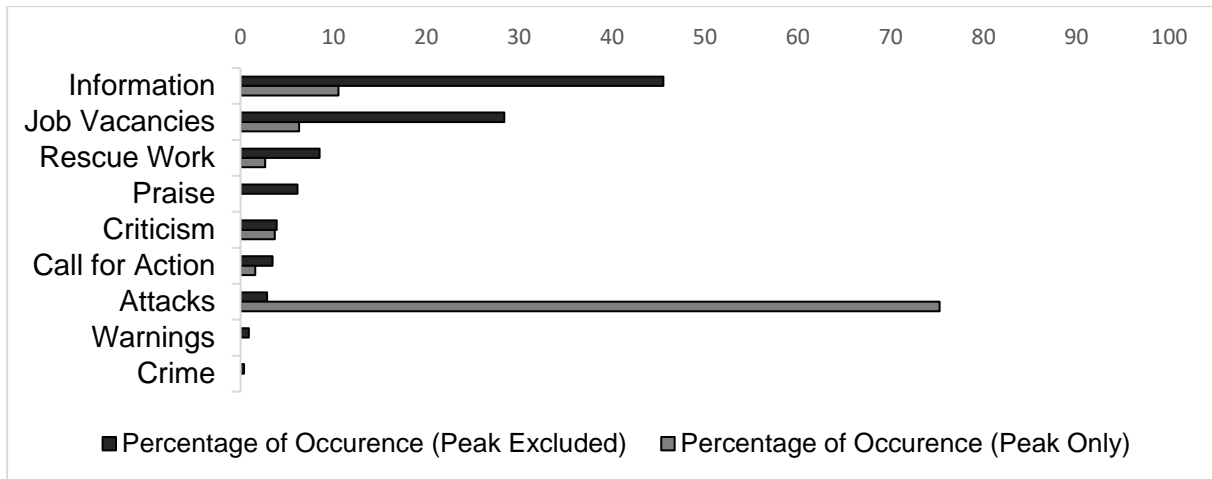

Figure 4: Comparison of Content between Peak and Non-Peak Times

As illustrated in Figure 4, the majority of tweets during peak time were sorted into the category “attacks”. The German online tabloid newspaper “BILD.de” published an article about an interview with an employee of JUH. In this interview, the employee stated that he was attacked by drunken party guests while he wanted to help a 17-year old girl with shortness of breath. The article further included a quote of the employee stating that such attacks have become commonplace and a picture showing the arrest of a man of foreign origin. On Twitter, the German right-wing political organisation “JungeAlternative NRW” published a tweet with a link to this article and the hashtags #frustration #migration #cuddlyjustice and #AfD. In this tweet, the German chancellor is blamed because her migration policy is allegedly the reason for the frequent attacks. Similar tweets were posted by an individual person who claims to support the German right-wing party AfD and another individual person who regularly tweets about crimes committed by refugees in Germany. All three original tweets were frequently retweeted by members of the cluster around “JungeAlternative NRW” which was identified during the social network analysis. The emergency agency JUH was also mentioned in a few tweets criticising a job commercial in which an employee had to embark on a spontaneous rescue mission while sitting on a toilet. The remaining tweets were more neutral and contained information about the rescue work of the emergency agency and job vacancies. Figure 5 provides a comprehensive summary of the most important insights gained about the communication related to JUH through the applied social media analytics methods.

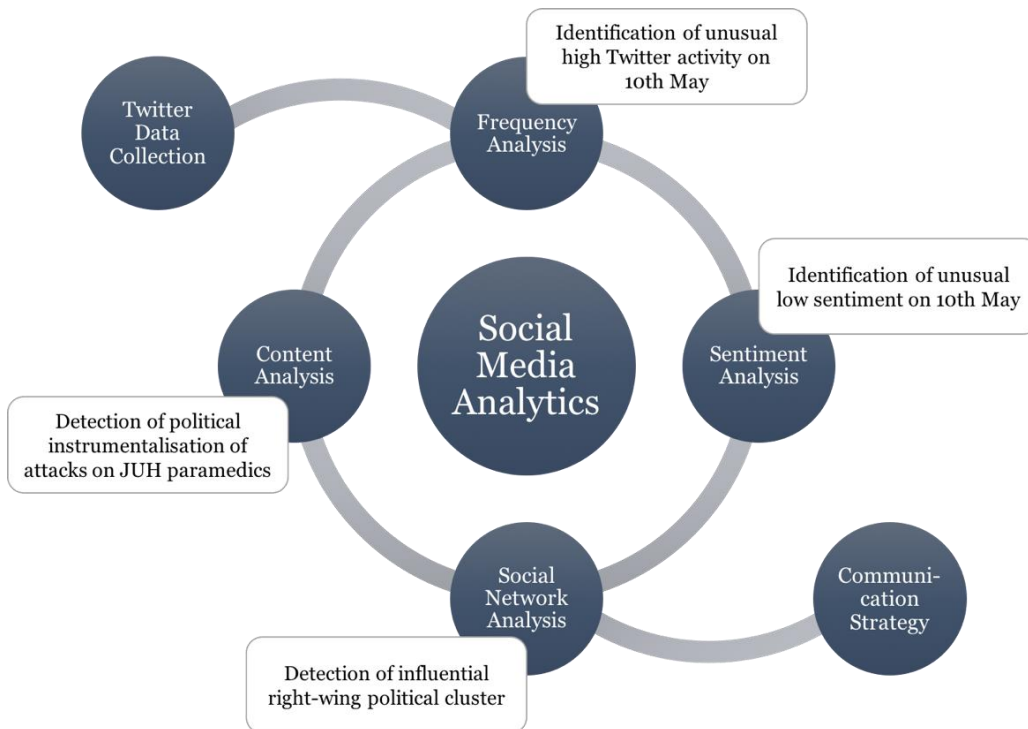

Figure 5: Social Media Analytics Cycle for Emergency Agencies

## 4 Discussion

The aim of this research was to examine which insights into the social media communication about an emergency agency could be gained by analysing available data on social media. The results reveal that social media analytics is well suited to identify important issues related to emergency agencies allowing them to adjust their communication efforts or implement organisational changes accordingly. In the following, we will discuss the benefits gained through the different applied methods of social media analytics in more detail.

The results show that peaks identified during a frequency and sentiment analysis could be a good indicator for unusual incidents related to an emergency agency. In this research, the tweet activity around JUH increased significantly after a news article about attacks on JUH paramedics was published. A sentiment analysis reveals that the emotionality of the Twitter communication about JUH became more negative at the same time. A peak during both types of analysis could be well suited to detect unusual incidents as the results revealed that the number of tweets mentioning JUH was usually rather low and the sentiment of the communication slightly positive. In previous studies, it was already shown that a sudden increase in tweets containing a specific hashtag in combination with a decrease in sentiment could be important feature to detect negative events such as earthquakes (Sakaki et al. 2010). For emergency agencies, it could therefore be relevant to examine the contents of such peaks more closely for being able to develop communication strategies for the identified incident.

The content analysis reveals that the communication during the frequency and sentiment peak differed significantly from the communication during non-peak times. By examining the content, it was found that the political instrumentalisation of attacks on JUH paramedics was the reason for the increase in tweet activity and the decrease in sentiment. While several news articles reported that drunk teenagers attacked JUH paramedics while trying to help a young woman, an article of a German tabloid newspaper about this incident included a picture showing how a man of foreign origin was arrested by the police. Neither media organisations nor the police officially stated that a man of foreign origin was responsible for the attacks. Nevertheless, the German right-wing political organisation “JungeAlternative NRW” shared the article on Twitter and blamed the migration policy of German chancellor Angela Merkel and the justice system in Germany for the attacks. The political instrumentalisation of the JUH-related incident is an example for an immigration threat narrative commonly disseminated by right-wing populist parties worldwide. A comparative study revealed that right-wing populist parties in the US, UK and Australia have in common that they use three types of immigration threat narratives (Hogan and Haltinner 2015). According to this study, right-wing populist parties share stories proposing that immigrants are either an economic, security or culture threat. The narrative created around the attacks on JUH paramedics can be classified as a security threat narrative which is based on the belief that “immigrants increase violence and property crime, bring diseases, and make the nation more vulnerable to terrorism” (Hogan and Haltinner 2015, p. 529). Our study contributes first insights on how social media platforms are used to create and spread such narratives. The study further revealed that news articles which present crimes in relation with people of foreign origin are used to spread right-wing populist narratives in the Twittersphere, which might be of particular relevance for police authorities. It was also shown that the highly emotional political tweets were retweeted much more often than tweets belonging to other categories suggesting that political instrumentalisation might reach more people than informational posts of emergency agencies. This is in line with a previous study revealing that political tweets with a negative sentiment are retweeted more often than neutral tweets (Stieglitz and Dang-Xuan 2013). Thus, emergency agencies should be aware of the possibility that incidents related to them could be politically instrumentalised to develop counteracting strategies for this case.

Another indicator for the political instrumentalisation of the attacks on JUH paramedics was the high influence of right-wing political Twitter users which became apparent during the social network analysis. The tweet of the right-wing political organisation “JungeAlternative NRW” was frequently retweeted by several other users with similar viewpoints. This way, the influence measured by in-degree of this organisation was higher than the influence of the agency JUH itself. This result is especially striking as this influence was only gained through tweets during the three-day peak while the tweets of JUH were retweeted throughout the whole period of data tracking. Employing social network analyses, thus, could be crucial for emergency agencies to identify influential Twitter users who do not belong to their own cluster. By relying solely on Twitter notifications, emergency agencies would only learn about users they are connected to or about users who are directly interacting with them or their tweets. This way, emergency agencies would probably not notice attempts at political instrumentalisation related to their organisation. This assumption is also supported by previous research which revealed that Twitter



users are only seldom exposed to cross-ideological content as they are often part of clusters with a homogenous political orientation (Himmelboim et al. 2013).

Analysing the social media communication about themselves provides emergency agencies not only with the opportunity to detect political instrumentalisation but also allows them to identify what users value about their work and what they are criticising. For example, some users mentioned that job advertisements of JUH were distasteful or not representing the current generation of elderly people properly. Emergency agencies could establish a dialogue with users who are criticising them to learn how they could improve their organisation in the future. However, the analysis also reveals that several individuals and emergency agencies were thankful for the engagement of the organisation's employees. Emergency agencies could try to foster their relationships to the individual persons in particular as these could be recruited as voluntary helpers. Strengthening their relationship to other emergency agencies might also be helpful for recruitment purposes as the content analysis revealed that these organisations frequently retweeted their job advertisements.

## 5 Conclusion

### 5.1 Summary

The aim of this research was to demonstrate the potential of social media analytics for improving social media communication of emergency agencies. A Twitter dataset was retrieved which included all tweets and retweets mentioning the German emergency agency JUH. Subsequently, we conducted a frequency, sentiment, social network and content analysis to examine by whom and in which context the particular emergency agency was mentioned on Twitter. It was found that a major peak occurred from the 9<sup>th</sup> May 2018 to the 11<sup>th</sup> May 2018 as a result of an interview about attacks on paramedics in a tabloid newspaper was used for political instrumentalisation by a cluster of right-wing political Twitter users. In the original article, it was not clear whether the paramedics were attacked by people of foreign origin. Nevertheless, the migration policy of the German chancellor Merkel was presented as reason for the attacks. These results indicate that emergency agencies should be careful how they communicate about incidents during their work which potentially involve people of foreign origin. The peak further included tweets of individuals criticising a job advertisement of the emergency agency for being distasteful. Based on the results, the emergency agency could improve future advertisements and develop strategies for avoiding political instrumentalisation of incidents related to them.

### 5.2 Limitations

In this research, we analysed the Twitter communication about the German emergency agency JUH. Therefore, the results of this paper should be interpreted carefully as they might not be transferable to other social media platforms as well as to different emergency agencies who fulfil other task or operate in another country. The choice of keywords represents a further limitation as it cannot be ensured that the defined list was exhaustive, and therefore some relevant tweets might not be included in the dataset. However, the keyword list was created in consultation with the emergency agency JUH to ensure that as many relevant keywords as possible were included. Another limitation is the use of a dictionary-based approach for analysing the sentiment of tweets as irony or sarcasm might be not detected.

### 5.3 Future Research

By adopting an explorative research approach, an example of political instrumentalisation of incidents related to an emergency agency was detected. It would be worth examining whether incidents or crisis situations to which emergency agencies respond are regularly used for political instrumentalisation. This would require monitoring social media communication about multiple emergency agencies and crisis situations over a longer time period. In this context, it would also be important to provide emergency agencies and other involved actors with strategies allowing them to counteract this phenomenon. Furthermore, it would be relevant to analyse the reactions of other users to assess the impact of political instrumentalisation on Twitter. Additional analyses such as a hashtag-co-occurrence network or a friendship-network could also provide a deeper understanding of the phenomenon. In addition, further studies involving different social media platforms (e.g. Facebook, blogs, reddit) and emergency agencies are required to gain more holistic insights. The results of the present study could also be used to train an algorithm in detecting political instrumentalisation as manual content analysis would not be applicable in larger datasets.

## 6 References

- Bekmamedova, N., and Shanks, G. 2014. "Social Media Analytics and Business Value: A Theoretical Framework and Case Study," in *Hawaii International Conference on System Sciences*, pp. 3728–3737.
- Briones, R. L., Kuch, B., Fisher Liu, B., and Jin, Y. 2011. "Keeping up with the Digital Age: How the American Red Cross Uses Social Media to Build Relationships," *Public Relations Review* (37:1), pp. 37–43.
- Bruns, A., and Burgess, J. 2014. "Crisis Communication in Natural Disasters: The Christchurch Earthquakes," in *Twitter and Society*, K. Weller, A. Bruns, J. Burgess, M. Mahrt, and C. Puschmann (eds.), New York: Peter Lang, pp. 373–384.
- Ehnis, C., and Bunker, D. 2012. "Social Media in Disaster Response Queensland Police Service - Public Engagement during the 2011 Floods," in *Australasian Conference on Information Systems*.
- Ehnis, C., and Bunker, D. 2013. "The Impact of Disaster Typology on Social Media Use by Emergency Services Agencies: The Case of the Boston Marathon Bombing," in *Australasian Conference on Information Systems*.
- Eismann, K., Posegga, O., and Fischbach, K. 2016. "Collective Behaviour, Social Media and Disasters: A Systematic Literature Review," in *European Conference on Information Systems*.
- Fisher Liu, B., Yin, Y., Briones, R., and Kuch, B. 2012. "Managing Turbulence in the Blogosphere: Evaluating the Blog-Mediated Crisis Communication Model with the American Red Cross," *Journal of Public Relations Research* (24:4), pp. 353–370.
- Fosso Wamba, S., and Edwards, A. 2014. "Factors Related to Social Media Adoption and Use for Emergency Services Operations: The Case of the NSW SES," in *Americas Conference on Information Systems*.
- Freberg, K., Saling, K., Vidoloff, K. G., and Eosco, G. 2013. "Using Value Modeling to Evaluate Social Media Messages: The Case of Hurricane Irene," *Public Relations Review* (39:3), pp. 185–192.
- Himmelboim, I., McCreery, S., and Smith, M. 2013. "Birds of a Feather Tweet Together: Integrating Network and Content Analyses to Examine Cross-Ideology Exposure on Twitter," *Journal of Computer-Mediated Communication* (18:2), pp. 154–174.
- Hogan, J., and Haltinner, K. 2015. "Floods, Invaders, and Parasites: Immigration Threat Narratives and Right-Wing Populism in the US, UK and Australia," *Journal of Intercultural Studies* (36:5), pp. 520–543.
- Imran, M., Castillo, C., Diaz, F., and Vieweg, S. 2018. "Processing Social Media Messages in Mass Emergency: A Survey," *ACM Computing Surveys* (47:4), p. 67.
- Johanniter-Unfall-Hilfe. 2018. "Über Uns." (<https://www.johanniter.de/die-johanniter/johanniter-unfall-hilfe/ueber-uns/>, accessed August 2, 2018).
- Lin, X., Spence, P. R., Sellnow, T. L., and Lachlan, K. A. 2016. "Crisis Communication, Learning and Responding: Best Practices in Social Media," *Computers in Human Behavior* (65), pp. 601–605.
- Lovejoy, K., and Saxton, G. D. 2012. "Information, Community, and Action: How Nonprofit Organizations Use Social Media," *Journal of Computer-Mediated Communication* (17:3), pp. 337–353.
- Mayring, P. 2014. *Qualitative Content Analysis: Theoretical Foundation, Basic Procedures and Software Solution*, Klagenfurt: Beltz.
- Mirbabaie, M., and Zapatka, E. 2017. "Sense-Making in Social Media Crisis Communication - A Case Study on the Brussels Bombings in 2016," in *European Conference on Information Systems*.
- Plotnick, L., Hiltz, S. R., Kushma, J. A., and Tapia, A. 2015. "Red Tape: Attitudes and Issues Related to Use of Social Media by US County-Level Emergency Managers," in *Proceedings of the 12th International Information Systems for Crisis Response and Management Conference (ISCRAM)*.
- Power, R., and Kibell, J. 2017. "The Social Media Intelligence Analyst for Emergency Management," in *Hawaii International Conference on System Sciences*.
- Reuter, C., Ludwig, T., Friberg, T., Pratzler-Wanczura, S., and Gizikis, A. 2015. "Social Media and

- Emergency Services? An Interview Study on Current and Potential Use in 7 European Countries,” *International Journal of Information Systems for Crisis Response and Management* (7:2), pp. 36–58.
- Reuter, C., Ludwig, T., Kaufhold, M., and Spielhofer, T. 2016. “Emergency Services’ Attitudes Towards Social Media: A Quantitative and Qualitative Survey Across Europe,” *International Journal of Human-Computer Studies* (95), pp. 96–111.
- Rice, R. G., and Spence, P. R. 2016. “Thor Visits Lexington: Exploration of the Knowledge-Sharing Gap and Risk Management Learning in Social Media during Multiple Winter Storms,” *Computers in Human Behavior* (65), pp. 612–618.
- Ross, B., Potthoff, T., Majchrzak, T. A., Chakraborty, N. R., Lazreg, B., and Stieglitz, S. 2018. “The Diffusion of Crisis-Related Communication on Social Media: An Empirical Analysis of Facebook Reactions,” *Hawaii International Conference on Information Systems*, pp. 2525–2534.
- Sakaki, T., Okazaki, M., and Matsuo, Y. 2010. “Earthquake Shakes Twitter Users: Real-Time Event Detection by Social Sensors,” in *International Conference on World Wide Web*, pp. 851–860.
- Stemler, S. 2001. “An Overview of Content Analysis,” *Research & Evaluation* (7:17).
- Stieglitz, S., Bunker, D., Mirbabaie, M., and Ehnis, C. 2017. “Sense-Making in Social Media during Extreme Events,” *Journal of Contingencies and Crisis Management* (26:1), pp. 4–15.
- Stieglitz, S., and Dang-Xuan, L. 2013. “Emotions and Information Diffusion in Social Media—Sentiment of Microblogs and Sharing Behavior,” *Journal of Management Information Systems* (29:4), pp. 217–248.
- Stieglitz, S., Mirbabaie, M., and Fromm, J. 2018. “Understanding Sense-Making on Social Media during Crises: A Categorization of Sense-Making Barriers and Strategies,” *International Journal of Information Systems for Crisis Response and Management* (9:4).
- Stieglitz, S., Mirbabaie, M., Fromm, J., and Melzer, S. 2018. “The Adoption of Social Media Analytics for Crisis Management - Challenges and Opportunities,” in *European Conference on Information Systems*.
- Stieglitz, S., Mirbabaie, M., Schwenner, L., Marx, J., Lehr, J., and Brünker, F. 2017. “Sensemaking and Communication Roles in Social Media Crisis Communication,” in *International Conference on Wirtschaftsinformatik*.
- Takahashi, B., Tandoc, E. C., and Carmichael, C. 2015. “Communicating on Twitter during a Disaster: An Analysis of Tweets during Typhoon Haiyan in the Philippines,” *Computers in Human Behavior* (50), pp. 392–398.
- Thelwall, M., Buckley, K., Paltoglou, G., and Cai, D. 2010. “Sentiment Strength Detection in Short Informal Text,” *The American Society for Information Science and Technology* (61:12), pp. 2544–2558.
- Twitter. 2018. “Search Tweets.” (<https://developer.twitter.com/en/docs/tweets/search/api-reference/get-search-tweets.html>, accessed August 2, 2018).
- Whiting, A., and Williams, D. 2013. “Why People Use Social Media: A Uses and Gratifications Approach,” *Qualitative Market Research: An International Journal* (16:4), pp. 362–369.

**Copyright:** © 2018 Milad Mirbabaie, Jennifer Fromm, Simone Löppenber, Sophie Meinig, Matthias Reuß. This is an open-access article distributed under the terms of the [Creative Commons Attribution-NonCommercial 3.0 Australia License](https://creativecommons.org/licenses/by-nc/3.0/au/), which permits non-commercial use, distribution, and reproduction in any medium, provided the original author and ACIS are credited.

# Metrics selection for group type identification in Enterprise Social Network (ESN) analytics

## **Kai Riemer**

Discipline of Business Information Systems  
The University of Sydney Business School  
Sydney, Australia  
Email: kai.riemer@sydney.edu.au

## **Laurence Lock Lee**

SWOOP Analytics Pty Ltd  
Sydney, Australia  
Email: llocklee@swoopanalytics.com

## **Cai Kjaer**

SWOOP Analytics Pty Ltd  
Sydney, Australia  
Email: cai.kjaer@swoopanalytics.com

## **Annika Haeffner**

Ulm University  
Ulm, Germany  
Email: annika.haeffner@alumni.uni-ulm.de

## **Abstract**

With the proliferation of Enterprise Social Networks (ESN) measurement of ESN activity becomes increasingly relevant. ESN analytics aims to develop metrics and models to measure and classify ESN user activity to support organisational goals and outcomes. In this paper we focus on a neglected area of ESN analytics, metrics for understanding activity in ESN groups. We engage in explorative research, utilising actual ESN meta data describing activity in 350 groups across three organisations, to identify a set of metrics that divides the group sample into distinct user types. By employing clustering techniques we derive a set of four group types: broadcast streams, information forums, communities of practice and project teams. For ESN analytics research we contribute a set of metrics and group types. For practice we envision a method that enables group managers to compare aspirations for their groups to embody a certain group type, with actual activity patterns.

**Keywords:** Enterprise Social Network, ESN groups, ESN Analytics, Social Media Analytics.

## 1 Introduction

Enterprise Social Networks (ESN), online services that allow employees to connect and converse with each other in a secure space, have made fast inroads into organisations with the promise to foster collaboration and enable new work practices (Leonardi 2015). According to a report by McKinsey (2012), effective use of such services can result in a 20-25 percent improvement in the productivity of knowledge workers. In the case of one large company Forrester Research found a return on investment of 365 percent on their ESN investment over three years (Dodd 2011). More generally, with more organisations adopting ESN, questions about how to measure benefits and success abound (Bughin 2015).

The emerging sub field of ESN analytics (e.g. Schwade and Schubert 2017), which is part of social media analytics (Behrendt et al. 2014b; Stieglitz et al. 2018), aims to develop metrics and models to examine ESN log file and content data to gain a better understanding of actual ESN usage patterns. This comprises both metrics for measuring the health and structural properties of the overall network, as well as metrics to characterise and classify individual ESN user behaviour and user roles (Hacker et al. 2017a). While existing work has presented metrics at the network and individual level, the intermediate, or group level of analysis, has not been covered so far. Yet, groups play an important role in ESN communication and collaboration practices. In this paper we are concerned with identifying metrics to distinguish between ESN group types. We ask the following research questions: *Which metrics are best suited to discriminate ESN groups into distinct types?*

We utilise an ESN activity meta-data set, sourced from the Yammer networks of three organisations, provided by Australian analytics company SWOOP Analytics. We engage in explorative research. We use cluster analysis and explore a range of general social network and ESN-specific activity metrics to see which ones divide a sample of 350 groups into distinct group types.

We find that a combination of three metrics best divided our group sample into clusters that are not only well-interpretable, but relate to, and extend the classification used by Yammer itself: 1) evenness of user participation in the group, 2) the degree to which messages elicit responses from others (reciprocity), and 3) network density, the extent to which users interact with all other users in a group. Clustering with these metrics resulted in four distinct ESN group types, which we named 1) broadcast streams, 2) information forums, 3) communities of practice and 4) project teams.

Our study contributes to ESN research and ESN analytics an initial set of metrics, and a typology of groups based on activity patterns, as the basis for broader research into understanding the role of groups in ESN. For practitioners, such as network managers and group leaders, we outline the scaffold of a method for visualising the discrepancies between aspiration and actual activity in ESN groups. This will help group leaders understand how their group is tracking against the patterns of a particular group type that they envision their group to embody. Given its pioneering nature, the study points to various promising avenues for future research.

## 2 Background

Enterprise Social Networks (ESN) are part of the Enterprise 2.0 phenomenon (McAfee 2009) which describes the application of social technologies such as social networking, blogs, wikis, or microblogging services within organisations (Razmerita et al. 2014). As such, ESN present a variant of public social networking services (Richter et al. 2011). Typical services are Microsoft Yammer, Facebook Workplace, IBM Connections, Chatter by Salesforce, and smaller services such as Mumbacloud, Jive or Tibbr.

### 2.1 ESN definition and characteristics

Common to all social media is that they facilitate user participation, interaction, and the generation of content by users (Boyd and Ellison 2007). Specifically, ESNs are services that are accessed through a web browser or mobile app, that allow people to (1) communicate with their co-workers or broadcast messages to everyone within the organisation; (2) explicitly indicate or implicitly reveal particular co-workers as communication partners; (3) post, edit, and sort text and files linked to themselves or others; and (4) view the messages, connections, text, and files posted, edited and sorted by anyone else in their organisation at any time of their choosing (Leonardi et al. 2013).

Another defining characteristic of ESN is their malleability (Richter and Riemer 2013b). Unlike more traditional information systems that are employed to solve a concrete problem and are thus associated with a concrete task or purpose, ESN are best understood as infrastructures that are intended to create potentials for new ways of communicating and working (Riemer et al. 2009). Hence, the proliferation of ESN often follows a bottom-up approach of implementation, a process that is more inclusive and

egalitarian than that of traditional IS implementations (Schneckenberg 2009). ESN have been associated with a variety of organisational practices such as communication, collaboration (Riemer et al. 2010), knowledge management (Levy 2009) crowdsourcing (Schlagwein and Bjorn-Andersen 2014), open innovation (Dahlander and Gann 2010), or open strategy (Tavakoli et al. 2015). This renders ESN both an interesting and important context for IS research, and a challenge for organisations as they have to keep track of the emerging activity within their ESN. The research presented below aims to help organisations understand important aspects of their own enterprise social networks.

## 2.2 Prior research on ESN

Prior research on ESN typically falls within one of four existing streams. The first stream captures conceptual work outlining typical ESN characteristics (Leonardi et al. 2013; Treem and Leonardi 2012), comparing ESN with traditional ways of relationship building in organisations (Kane et al. 2014), envisioning high-level benefits, such as for knowledge-sharing (Fulk and Yuan 2013; Majchrzak et al. 2013) or interacting in the workplace more generally (DiMicco et al. 2008; Zhang et al. 2010).

The second stream comprises concrete, explorative, usually qualitative case studies investigating usage patterns of ESN. Typical findings reveal benefits of ESN for information sharing and discovery (Zhao and Rosson 2009), for creating awareness within the organisation (Zhang et al. 2010), or for knowledge creation and sharing in professional service contexts (Riemer and Scifleet 2012).

The third stream represents studies that measure the benefits of ESN from different angles and in different contexts; these studies are mostly quantitative in nature, employing either survey-based approaches, e.g. to measure individual ESN benefits for knowledge workers (Mantymaki and Riemer 2016), or they use data obtained from the ESN services directly, such as for studying the connection between social capital and employee performance (Riemer et al. 2015).

Finally, the fourth stream, to which this study contributes, contains generative works that aim to identify metrics and develop analytics frameworks for measurement of ESN activity in organisations. Studies in this context focus on the application of social network analysis (SNA) to reveal emerging informal networks between ESN users (Behrendt et al. 2014a), identify particular value-adding users (Berger et al. 2014), characterise individual user activity profiles (Holtzblatt et al. 2013), or develop a comprehensive framework for identifying user types in knowledge work contexts (Hacker et al. 2017b).

## 2.3 ESN analytics and metrics development

As an emerging stream of research, ESN analytics is a sub field of social media analytics (Stieglitz et al. 2014; Stieglitz et al. 2018). Sometimes called social collaboration (or social software) analytics, it is “a specialized form of examination of log files and content data, to gain a better understanding of the actual usage of ESS.” (Schwade and Schubert 2017, 401). Here, we define ESN analytics as methods and practices for the identification and utilisation of metrics and models for measuring different aspects of user activity in enterprise social networks, including user activity levels and user profiles, network activity levels, structural network characteristics, and network health indicators, in support of support organisational goals and outcomes.

ESN analytics becomes relevant for organisations for two main reasons. Firstly, due to their malleability, concrete implementations of ESN in organisations typically emerge in quite different ways, supporting a range of different use cases and activities (Richter and Riemer 2013a). It is thus important for organisations to be able to track and understand user activity on their own particular ESN. Secondly, ESNs are becoming more integral to organisational communication and collaboration practices, which renders gaining an understanding for the activity on the platform and ways in which to support individuals and social groups within the ESN more important (Schwade and Schubert 2017).

At the same time, there are opportunities in ESN analytics for both academia and industry. First, the particular nature of ESN affords detailed analysis of user activity, because all (or most) user interactions are logged and, in principle, available for analysis. Second, most ESN platforms currently do not provide sophisticated analytics capabilities, leaving room for new offerings by third-party providers and for academia to explore new ways of measuring and accounting for various aspects of ESN activity.

Given the newness of this field the number of studies contributing to establishing metrics or models to support ESN analytics is still limited (cf. Schwade and Schubert 2017). So far two main areas of application for analytics exist. The first area focuses on metrics characterising the social network as such. This is where traditional social network analysis (SNA) techniques are brought to bear (Wasserman and Faust 1994). For example, Riemer et al. (2015) have shown how social capital metrics can be utilised to link certain network characteristics to employee performance. Behrendt et al. (2014b)

provide an overview of SNA metrics and studies for use in ESN contexts. The second area aims to develop new dedicated ESN metrics to characterise individual user behaviours and to generate models that classify user populations into distinct user types. Most notably is the research program by Hacker and colleagues (e.g. Hacker et al. 2017b). Other works include a study by Cetto et al. (2018) who classified users by knowledge sharing and seeking behaviours, and Frank et al. (2017), who utilised log data from Exchange, Microsoft Office 365 and Sharepoint to identify user roles (Frank et al. 2017).

## 2.4 ESN group analytics

What is lacking so far are works that engage with ESN groups, the intermediate level of analysis between the network and that of individuals. Groups play an important role in ESN as they allow for the creation of dedicated spaces for conversations and information exchange between a sub set of users. Given their usefulness many companies find that the number of groups tends to proliferate over time, with some groups very active and many others abandoned. At the same time groups are used for all kinds of purposes, and they exist in different shapes and forms, from very small ones to large behemoths. We suggest that a better understanding of different group types, their structural features and activity patterns, will be useful for decision-makers in better harnessing their ESN for value.

However, we are aware of only one study engaging in detail with ESN user activity at the group level, classifying groups in the context of knowledge work (Riemer and Tavakoli 2013). Yet this study has a very different purpose, and was not useful in the context of ESN analytics, since the classification was based on manual coding of messages, which is impractical for ESN analytics. We re-formulate our research question in more detail as: *Which set of metrics discriminates best a population of ESN groups such that it results in a set of meaningful group types characterised by different activity patterns?*

## 3 Study overview

We utilise ESN activity meta-data from three Yammer networks, obtained from Australian analytics company SWOOP Analytics Pty Ltd (in the following just: SWOOP). We set out to test a range of metrics to see which ones divide the sample of groups in our data set into distinct types. We briefly introduce our research setting and data set, before we outline our method and the metrics included in this study.

### 3.1 Research setting and ESN data set

SWOOP offers a cloud-based platform that provides organisations with analytics for their Yammer, Facebook Workplace and Microsoft Teams networks. When given permission by an organisation to integrate with its network, SWOOP “provide[s] access to more than 30 measurement indicators giving organisations and individuals deep insights into collaboration across the enterprise.” It uses these metrics to provide user profiles, in the form of a typology that classifies each user.

Generally, any action performed by an ESN user is stored in the backend database of the ESN system and available in the form of digital traces, “digitally stored, event-based, chronological records of activities of actors, which result in direct or indirect actor relations or content in different data formats” (Behrendt et al. 2014a, 4). We distinguish usage data, or *meta-data*, from user-generated data, or *content*. Meta-data indicates *how*, *when* and *where* an ESN activity was performed, what kind of interaction it was and *who* was involved; content data contains *what* was posted.

In order to ensure confidentiality SWOOP does not collect any content from organisations, only meta-data. Whereas the Yammer data model is organised around messages, SWOOP provides ESN activity data already organised as interactions between users. Moreover, SWOOP collects from an organisation’s ESN information that is not included in the Yammer database, such as information on ‘Likes’ or ‘Mentions’ of other users (tagging), each of which are represented in the SWOOP data model as particular interactions. SWOOP distinguishes the following interaction types: Post, Reply, Notification, Mention or Like. Table 1 shows what meta data is available for each interaction.

<b>ID</b>	Unique identifier for each interaction
<b>Class</b>	Type of interaction: Post, Reply, Notification, Mention or Like
<b>From</b>	User-ID of user initiating the interaction
<b>To</b>	User-ID of targeted user (not relevant if Class equals Post, as Post is undirected)
<b>Thread ID</b>	Unique ID for every thread, every interaction belongs to a thread, “Post” creates new thread
<b>Date</b>	Timestamp of the interaction
<b>Group ID</b>	Unique ID of the group in which an interaction takes place (if empty, not in group)

Table 1: Meta-data for each interaction in the SWOOP data model

For this study we had access to data from Yammer networks of three firms (two financial services and one professional services company). The data provided by SWOOP (with the firms' permissions) contained meta data of all interactions in the various groups across these networks for a representative 10-week period. To protect user privacy SWOOP only shared anonymised meta-data, which was stripped of user and group names. Users, groups and all interactions remain traceable however through their unique IDs. In total, the data set contained 683,733 interactions by 40,304 users in 350 groups.

### 3.2 Methodology

Our aim was to identify those metrics that best discriminate the sample of ESN groups in a way that results in certain archetypes describing groups regarding their activity patterns. Much like individual user profiles and archetypes already provided by SWOOP, the question we explore in this study is thus, can we identify a set of metrics that provides a similar set of group archetypes?

Given the explorative nature of this question, our research approach needed to be 'creative' and iterate between identification and calculation of metrics and a clustering of groups based on varying sets of metrics. Hence, the steps in this process are: 1) identification of metric candidates, describing both the network structure of a group and user activity, 2) selection of metrics for inclusion in cluster analysis, 3) calculation of metrics for each group, 4) selection of a cluster algorithm and proximity measure, 5) performing of cluster analysis, 6) interpretation of results. A tool was implemented using the software package Matlab to facilitate iterating on steps 2 to 6 until a result emerged that a) discriminated well into distinct group clusters, and b) was interpretable in a way that corresponds with typical ESN use.

A cluster analysis is a method for semi-automated grouping of large numbers of objects based on their similarity described by a vector of quantified characteristics (Hartigan 1975). Previous research already demonstrated that clustering techniques are useful for classifying complex networks of different kinds (Newman and Girvan 2004; Strogatz 2001). For this study we experimented with a number of clustering algorithms (Song et al. 2012). Ultimately agglomerative clustering, in particular the complete-linkage algorithm (Defays 1977; Krznaric and Levkopoulos 1998) with a standardised Euclidean distance measure (Pandit and al. 2011) produced the most useful results.

Cluster analysis is 'semi-automated' because it is up to the researchers to determine whether or not a clustering was successful. According to Everitt (1993) success is given when the researcher, who is familiar with the data, can sensibly interpret the resulting clusters. A good set of clusters shows homogeneous and clearly separable clusters.

To identify clusters we used dendrograms, plotting of metrics and a three-dimensional plot of group locations according to their metric values. In turn, the requirement to judge and interpret the clustering result in each instance, meant that it turned out not to be feasible to include more than three metrics in each clustering attempt. Each clustering was thus done on the basis of triplets of metrics. This allowed surfacing first which individual metrics, and second which metric combinations discriminated the group sample most distinctively (given that some metrics correlate and didn't discriminate in distinct ways). Judgements regarding which metrics combinations discriminate best were jointly made by the paper's two academic authors.

### 3.3 ESN social graph and metrics

Any operationalisation of network metrics in the context of ESN has to begin with the construction of the social network graph (Riemer et al. 2015). Generally, a social network "consists of a finite set or sets of actors and the relation or relations defined on them" (Wasserman and Faust 1994, 20). Whereas in public social networks, such as Twitter or Facebook, networks can be inferred from explicit friend or follower relationships, in ESNs relationships have to be constructed from user activity, as follower relationships either do not exist or are inconsequential to platform activity (Behrendt et al. 2014a).

At the most basic level a dyadic relationship between two individuals is said to exist when one user responds to another's message (Ahuja et al. 2003). This is in line with social network theory, which asserts that relationships emerge from interactions (Granovetter 1973; Krackhardt 1992). ESN meta data can thus be utilised to infer the ensuing network (Behrendt et al. 2014b). For our study, SWOOP provided various types of interactions between users that can be utilised to construct network graphs for each group in our sample. At the same time, the inclusion of different interaction types in graph creation has implications for calculating and interpreting metrics; for example, does liking someone's post constitute a relationship with that person, or should a relationship only be considered based on a reply to a message, as this suggests that the respondent has actually read (and not merely seen) the message and found it stimulating enough to interact?



Drawing on existing research we identified a list of metrics candidates: 1) *ESN group activity metrics* describe different aspects of communication in each group, such as how many users post, how many interactions are carried out, how responsive users are in replying, how many replies each post elicits, how many users engage in each discussion. Our list (see table 2) was adapted from the metrics catalogue provided by Hacker et al. (2016). 2) *Social network metrics* characterize structural properties of the social graph of a group, such as how densely users in a group are linked, how diverse the external links of users to other groups are, or to what extent the network is dominated by particular users, as measured by the Gini coefficient (Yakovenko and Rosser Jr 2009) (see Appendix 1 for Gini calculation).

Metric	Measurement	Interpretation
<b>ESN group activity metrics</b>		
# active users	Number of users who performed at least one interaction inside a group within a timeframe	Allows comparing groups according to different levels of user involvement
# interactions	Number of interactions inside a group within a timeframe	Allows comparing groups regarding different activity levels
Response rate (threads and posts)	The Share of Threads/Posts with at least one reply (Likes are not counted as reply)	Measure the level of engagement in a group
Response rate (includes likes)	Modified response rate that includes also Likes	Measures level of recognition, not just actual responses.
Replies per thread	Average number of replies per message thread	Measures extent to which group engages in longer discussions.
Passivity	Number of Likes divided by number of Replies	Measure the level of mere recognition relative to actual engagement
Users per Thread	Average number of different users that contribute to one thread	An alternative measure of engagement.
<b>Group social network metrics</b>		
Density of directed & undirected graph	Number of actual edges divided by the number of possible edges between nodes	Measures how evenly group members interact with each other.
User diversity (external links)	Average number of groups in which the users of a particular group are active	Measures how diverse the user population of a group is in terms of membership in other groups
Gini coefficient	General measure of equality applied to number of interactions per user (0=all users contribute equally, 1=all contributions by one user).	Measures how equal the contributions in a group are distributed among its users.

Table 2: Overview of key metrics candidates considered during the exploratory analysis

## 4 Findings: four ESN group archetypes

Our explorative analysis ‘tested’ varying triplet combinations of the above metrics by running the cluster algorithm on the sample of 350 groups each time. The analysis converged on a set of three metrics that not only discriminate well within the group sample, but also differentiate the groups into four distinct clusters that are well interpretable and that correspond with known uses of ESN groups in organisations.

### 4.1 Metrics that best discriminate the groups sample

The metrics that best divided the sample of groups into clusters are as follows:

1. **Gini Coefficient:** this metrics stems from economics and was originally intended to measure wealth inequality, that is the unevenness of wealth distribution. In the ESN context, it measures how evenly activity in a group is distributed. The higher the Gini coefficient, the more uneven is the activity distributed in a group. A Gini of 1 means that only one person is responsible for all activity, a Gini of 0 means everyone contributes exactly the same amount of activity.
2. **Density of directed Graph:** for each group a directed graph is created by adding a node for each active user and a directed edge between all node pairs whose user-IDs appear as “From” and “To” in one or more transactions inside the group; the edge points to the node whose user-ID appears as “To”. The density of this graph is defined as the number of existing edges divided by the number of possible edges. Density is a measure of the degree to which members of the group are connected, resulting from people talking directly to each other.
3. **Thread reciprocity:** thread reciprocity measures the share of all posts with at least one reply. It is thus akin to a response rate measure. Groups with a high thread reciprocity are more conversational. Note that a Like is not regarded as a Reply; a genuine response post is required.

## 4.2 Group types resulting from the cluster analysis

From these metrics the clustering algorithm derived a total of initially five clusters (chosen after visual inspection of the resulting dendrogram). After a further detailed analysis of the five clusters we decided to merge the two smallest of the clusters (shown as clusters 3 and 5 in figure 1, and in red and green in figure 2) as they turned out to be quite similar in terms of metrics. Figure 1 demonstrates for each of the three metrics separately how they discriminate between the clusters; figure 2 provides a three-dimensional plot which visually locates all 350 groups; and table 3 names and summarizes the metrics for each of the four clusters. In the following we interpret each of the clusters.

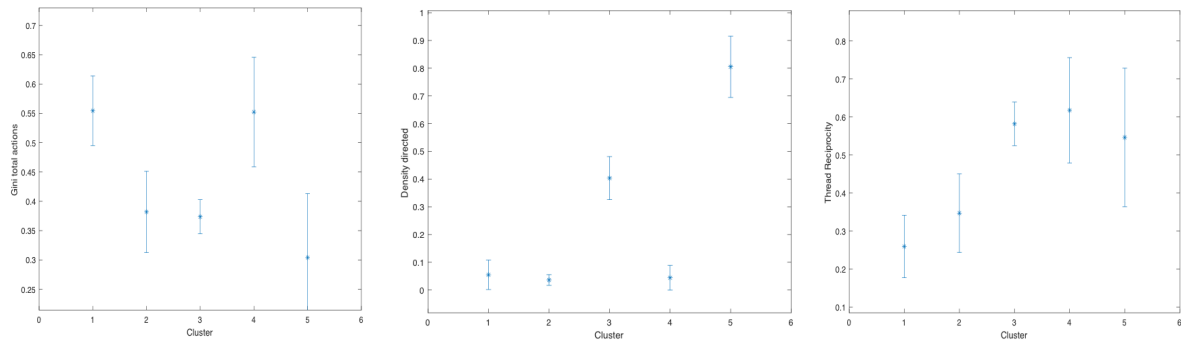

Figure 1: Metrics values for each of the resulting clusters

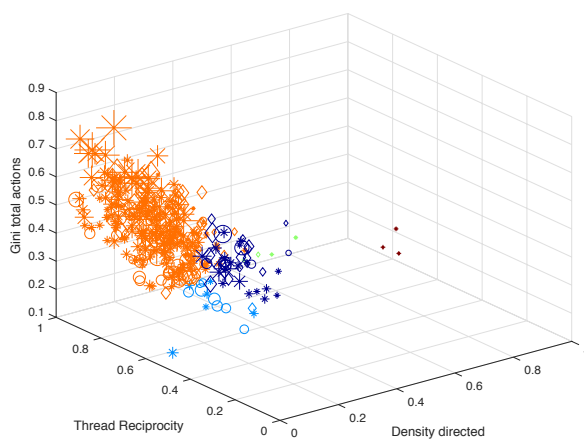

Figure 2: Cluster locations [shape of markers = company; marker size = group size]

Cluster			Metrics			# of active users		
#	Colour	Name	Particip. (Gini)	Density	Reciprocity	Avg	Min	Max
1	Blue	Broadcast streams	uneven	low	low	80.5	13	352
2	Light blue	Information forums	even	low	low	59.0	36	107
4	Orange	Community of practice	uneven	low	high	125.9	9	1018
3/5	Green/red	Project teams	even	med/high	high	9.7	7	13

Table 3: Overview of group classification according to the three metrics

**Broadcast streams:** These groups are quite large in terms of active users (those who interacted at least once in the 10-week period), yet they show only low levels of interaction and participation across the user population. Rather, they feature many single messages written by a small number of participants, and a large number of people who mostly read and only occasionally post. In addition, people are not well-connected with each other. Such characteristics are typical of groups used for announcements and the broadcasting of information. Typical uses are corporate communications or HR departments and business divisions pushing information to users in ways that resemble one-to-many ‘Intranet’ use. Such communication does not require responses from (reciprocity), or interaction among users (density). The relatively large number of active users is explained by ‘Likes’ acknowledging posts.

**Information forums:** Significant about this group type is that, while it shows rather even participation among users posting into the group, these posts do not solicit many replies from other users, or lead to interactions among users to build relationships. Such properties are typical of information forums, in which people post information that they deem interesting for other users, or questions and requests, but which do not elicit many interactions or longer conversations.

**Community of practice:** These groups show uneven participation but high reciprocity. This means that, while many posts receive replies from other users, these initial messages are written by a core group of members. In addition the overall network density is low in that people are not well connected among each other. The latter is partly explained by the fact that these groups are the largest on average in our sample. We term these groups ‘Communities of Practice’ (CoP). CoPs are groups of loosely connected members which often congregate around a particular topic and a core group of leaders or experts in the context of organisational learning and knowledge exchange, while a rather large number of group members follow the conversation as an audience and only occasionally participate.

**Project teams:** These groups are by far the smallest in our sample and show significantly higher levels of connection between the group members than groups in the other three clusters. They are also highly interactive and conversational, and show even participation. Such properties are typical of project teams in which all group members are actively involved in performing joint work and all group members interact and converse with each other on a regular basis.

## 5 Discussion

We set out to investigate which set of metrics discriminates best in a sample of ESN groups such that it results in a set of meaningful group types characterised by different activity patterns. Our explorative analysis, utilising activity meta-data from 350 groups from three organisations provided by SWOOP, converged on three metrics that measure 1) evenness of user participation, 2) density in terms of user connectedness in the group, and 3) reciprocity in terms of the proportion of messages eliciting replies. Those metrics in turn distinguish four distinct group types, which we named broadcast streams, information forums, communities of practice and project teams.

We note that these groups correspond to, yet extend in meaningful ways, the group types that Yammer used to provide (for a brief period of time) as a template for their users when creating new groups (see figure 3). Two of our categories, project teams (‘Project’) and broadcast streams (‘My Organisation’) have direct equivalents, while Yammer subsumes all other use cases under a broad category ‘community’, intended for users to “share best practices, learn new skills and connect around shared interests.” Yammer’s recent decision to suspend the group classification feature, after feedback from users, indicates that the typology was not granular enough and thus unhelpful.

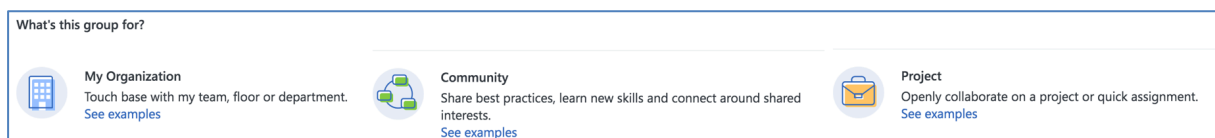

Figure 3: Yammer group template [note: Yammer recently suspended this classification feature]

Our finding suggests that a distinction should be made between communities of practices and information forums to differentiate those groups that are intended to focus on sharing best practices and facilitating learning, from those that revolve around sharing of interests and information. The former, communities of practice, require more interaction and conversations between users (as measured by reciprocity), but at the same time will show a certain un-evenness in participation (as measured by Gini), given that sharing of best practices and learning come with a differentiation in roles between experts/teachers and a broader audience of learners. This distinction is further supported by earlier, content-based studies that classify ESN use cases, where a strong distinction is made between communication genres that generate ‘discussion and conversation’ and those that are mainly one-way for ‘providing input’ for others (Riemer et al. 2011).

Initial feedback from SWOOP and its client base suggests that our typology will be helpful for ESN group leaders and community managers as a diagnostic tool for managing groups within their ESN networks. Specifically, we suggest that measurement of group characteristics will allow group leaders to compare their aspiration for what the group intends to become with actual patterns. For example, a group that intends to support a project team might be classified as a community of practice according to our metrics, which would indicate a lack of density, resulting in unhelpful network fragmentation in the

project team. Similarly, an intended CoP might be measured as a broadcast stream, indicating a lack of engagement (reciprocity) among its members. Finally, an intended information forum that lacks even participation becomes lopsided with a lack of diversity in contributions and perspectives (see figure 4). We suggest that knowledge of such discrepancies will allow group leaders to manage and counteract accordingly, such as by motivating certain users to become involved in ESN activity.

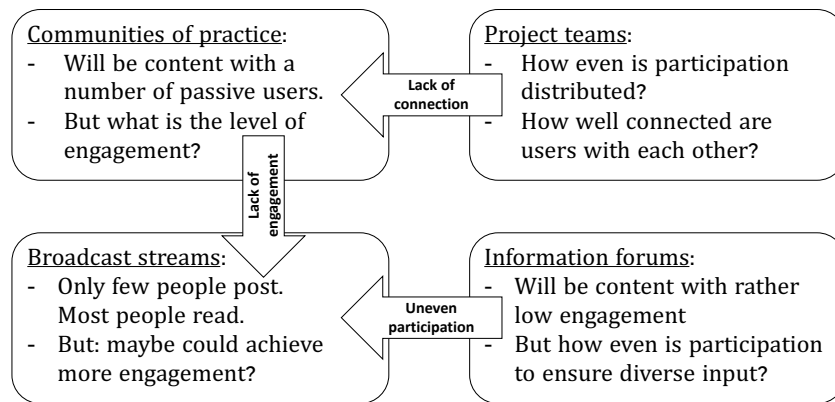

Figure 4: Examples of possible discrepancies between group aspiration and measured types

## 6 Conclusion

Our study contributes to ESN research in general, and the emerging field of ESN analytics more specifically, by extending ESN analytics practice to the group level. Specifically, we contribute a set of initial metrics and a first typology of ESN groups according to activity patterns, as the basis for broader research into understanding the role of groups in ESN networks.

Furthermore, our study contributes to ESN practice metrics for ESN group leaders and network managers to measure group activity in a meaningful way, to visualise discrepancies between group aspiration and actual user activity. Such metrics could form the basis of a diagnostic tool with the aim to improve group communication so that activity patterns associated with the intended group type can be achieved. We envision that our metrics and classification could suitably be implemented in platforms such as that provided by SWOOP.

Without doubt, future research is needed to corroborate the findings presented here, since our study provides merely a first, necessarily limited step in a broader research endeavour to extend analytics to the group level. We envision that future research will apply similar explorative analyses to different ESN networks to replicate our results, unearth additional useful metrics for discriminating group activity and extending our typology. Additionally, it will be worthwhile investigating the link between group-level and individual-level metrics and group types, such as those identified by (Hacker et al. 2017b). For example, will groups of certain types benefit from the presence of certain individual user types?

Moreover, qualitative research utilising interviews with network managers and group leaders might investigate the usefulness of our proposed typology, whether it captures all intended use cases for groups, and how it might be used to support decision-making. It would be particularly interesting to see how implementation of group metrics in platforms such as SWOOP will shape user behaviour.

## References

- Ahuja, M. K., Galletta, D. F., and Carley, K. M. 2003. "Individual Centrality and Performance in Virtual R&D Groups: An Empirical Study," *Management Science* (49:1), pp. 21-38.
- Behrendt, S., Richter, A., and Riemer, K. 2014a. "Conceptualisation of Digital Traces for the Identification of Informal Networks in Enterprise Social Networks," ACIS.
- Behrendt, S., Richter, A., and Trier, M. 2014b. "Mixed Methods Analysis of Enterprise Social Networks," *Computer Networks* (75), pp. 560-577.
- Berger, K., Klier, J., Klier, M., and Richter, A. 2014. "Who Is Key?-Value Adding Users in Enterprise Social Networks," *Proceedings of the 2014 European Conference on Information Systems (ECIS)*.
- Boyd, D. M., and Ellison, N. B. 2007. "Social Network Sites: Definition, History, and Scholarship," *Journal of Computer-Mediated Communication* (13:1), pp. 210-230.

- Bughin, J. 2015. "Taking the Measure of the Networked Enterprise," *McKinsey Quarterly* (51:10), pp. 1-4.
- Dahlander, L., and Gann, D. M. 2010. "How Open Is Innovation?," *Research Policy* (39:6), pp. 699-709.
- Defays, D. 1977. "An Efficient Algorithm for a Complete Link Method," *The Computer Journal* (20:4), pp. 364-366.
- DiMicco, J., Millen, D. R., Geyer, W., Dugan, C., Brownholtz, B., and Muller, M. 2008. "Motivations for Social Networking at Work," *Proceedings of the 2008 ACM conference on Computer supported cooperative work*: ACM, pp. 711-720.
- Dodd, L. 2011. "Study Reveals Huge ROI When Using Yammer," *Strategic Communication Management* (15:6), p. 7.
- Everitt, B. S. 1993. *Cluster Analysis (Third Edition)*. London Melbourne Auckland: Edward Arnold.
- Frank, L., Gimpel, H., Schmidt, M., and Schoch, M. 2017. "Emergent User Roles of a Digital Workplace: A Network Analysis Based on Trace Data," *38th International Conference on Information Systems*, Seoul, South Korea.
- Fulk, J., and Yuan, Y. C. 2013. "Location, Motivation, and Social Capitalization Via Enterprise Social Networking," *Journal of Computer-Mediated Communication* (19:1), pp. 20-37.
- Granovetter, M. 1973. "The Strength of Weak Ties," *American Journal of Sociology* (78:6), pp. 1360-1380.
- Hacker, J. V., Bernsmann, R., and Riemer, K. 2017a. "Dimensions of User Behavior in Enterprise Social Networks," in *Social Knowledge Management in Action: Applications and Challenges*, R. Helms, J. Cranefiels and J. van Reijssen (eds.). Cham, Switzerland: Springer International Publishing, pp. 125-146.
- Hacker, J. V., Bodendorf, F., and Lorenz, P. 2016. "A Framework to Analyze Enterprise Social Network Data," in *Enterprise Big Data Engineering, Analytics, and Management*, M. Atzmueller, S. Oussena and T. Roth-Berghofer (eds.). Hershey: IGI Global, pp. 84-107.
- Hacker, J. V., Bodendorf, F., and Lorenz, P. 2017b. "A Framework to Identify Knowledge Actor Roles in Enterprise Social Networks," *Journal of Knowledge Management* (21:4), pp. 817-838.
- Hartigan, J. A. 1975. *Clustering Algorithms*. New York: John Wiley & Sons.
- Holtzblatt, L., Drury, J., and Weiss, D. 2013. "Evaluating the Uses and Benefits of an Enterprise Social Media Platform," *Journal of Social Media for Organizations* (1:1), pp. 1-21.
- Kane, G. C., Alavi, M., and Labianca, G. J. 2014. "What's Different About Social Media Networks? A Framework and Research Agenda," *Management Information Systems Quarterly* (38:1), pp. 274-304.
- Krackhardt, D. 1992. "The Strength of Strong Ties: The Importance of Philos in Organizations," *Networks and organizations: Structure, form, and action* (216), p. 239.
- Krzmaric, D., and Levkopoulos, C. 1998. "Fast Algorithms for Complete Linkage Clustering," *Discrete & Computational Geometry* (19:1), pp. 131-145.
- Leonardi, P. M. 2015. "Ambient Awareness and Knowledge Acquisition: Using Social Media to Learn "Who Knows What" and "Who Knows Who" " *MIS Quarterly* (39:4), pp. 747-762.
- Leonardi, P. M., Huysman, M., and Steinfield, C. 2013. "Enterprise Social Media: Definition, History, and Prospects for the Study of Social Technologies in Organizations," *Journal of Computer-Mediated Communication* (19:1), pp. 1-19.
- Levy, M. 2009. "Web 2.0 Implications on Knowledge Management," *Journal of Knowledge Management* (13:1), pp. 120-134.
- Majchrzak, A., Faraj, S., Kane, G. C., and Azad, B. 2013. "The Contradictory Influence of Social Media Affordances on Online Communal Knowledge Sharing," *Journal of Computer-Mediated Communication* (19:1), pp. 38-55.
- Mantymaki, M., and Riemer, K. 2016. "Enterprise Social Networking: A Knowledge Management Perspective," *International Journal of Information Management* (36:6), pp. 1042-1052.
- McAfee, A. 2009. *Enterprise 2.0: New Collaborative Tools for Your Organization's Toughest Challenges*. Boston: McGraw-Hill Professional.
- McKinsey. 2012. "The Social Economy: Unlocking Value and Productivity through Social Technologies." from [http://www.mckinsey.com/insights/high\\_tech\\_telecoms\\_internet/the\\_social\\_economy](http://www.mckinsey.com/insights/high_tech_telecoms_internet/the_social_economy)
- Newman, M. E. J., and Girvan, M. 2004. "Finding and Evaluating Community Structure in Networks," *Physical Review* (69:2), pp. 26-113.
- Pandit, S., and al., e. 2011. "A Comparative Study on Distance Measuring Approaches for Clustering," *International Journal of Research in Computer Science* (2:1), pp. 29-31.
- Razmerita, L., Kirchner, K., and Nabeth, T. 2014. "Social Media in Organizations: Leveraging Personal and Collective Knowledge Processes," *Journal of Organizational Computing and Electronic Commerce* (24:1), pp. 74-93.

- Richter, A., and Riemer, K. 2013a. "The Contextual Nature of Enterprise Social Networking: A Multi Case Study Comparison," *21st European Conference on Information Systems ECIS 2013*, Utrecht University, Netherlands.
- Richter, A., and Riemer, K. 2013b. "Malleable End-User Software," *Business & Information Systems Engineering* (5:3), pp. 195-197.
- Richter, D., Riemer, K., and vom Brocke, J. 2011. "Internet Social Networking," *Business & Information Systems Engineering* (53:2), pp. 89-103.
- Riemer, K., Altenhofen, A., and Richter, A. 2011. "What Are You Doing? - Enterprise Microblogging as Context Building," *European Conference on Information Systems (ECIS)*, Helsinki, Finland, pp. 1-13.
- Riemer, K., Finke, J., and Hovorka, D. S. 2015. "Bridging or Bonding: Do Individuals Gain Social Capital from Participation in Enterprise Social Networks?," *International Conference on Information Systems ICIS 2015*, Fort Worth, United States.
- Riemer, K., Richter, A., and Böhringer, M. 2010. "Enterprise Microblogging," *Business & Information Systems Engineering* (2:6), pp. 391-394.
- Riemer, K., and Scifleet, P. 2012. "Enterprise Social Networking in Knowledge-Intensive Work Practices: A Case Study in a Professional Service Firm," *Proceedings of the 23rd Australasian Conference on Information Systems 2012: ACIS*, pp. 1-12.
- Riemer, K., Steinfield, C., and Vogel, D. 2009. "Ecollaboration: On the Nature and Emergence of Communication and Collaboration Technologies," *Electronic Markets* (19:4), pp. 181-188.
- Riemer, K., and Tavakoli, A. 2013. "The Role of Groups as Local Context in Large Enterprise Social Networks: A Case Study of Yammer at Deloitte Australia," The University of Sydney, Sydney.
- Schlagwein, D., and Bjorn-Andersen, N. 2014. "Organizational Learning with Crowdsourcing: The Revelatory Case of Lego," *Journal of the Association for Information Systems* (15:11).
- Schneckenberg, D. 2009. "Web 2.0 and the Empowerment of the Knowledge Worker," *Journal of Knowledge Management* (13:6), pp. 509-520.
- Schwade, F., and Schubert, P. 2017. "Social Collaboration Analytics for Enterprise Collaboration Systems: Providing Business Intelligence on Collaboration Activities," *50th Hawaii International Conference on System Sciences*, Hawaii, pp. 401-410.
- Song, W.-M., Di Matteo, T., and Aste, T. 2012. "Hierarchical Information Clustering by Means of Topologically Embedded Graphs," *PLoS One* (7:3), p. e31929.
- Stieglitz, S., Dang-Xuan, L., Bruns, A., and Neuberger, C. 2014. "Socialmedia Analytics: An Interdisciplinary Approach and Its Implications for Information Systems," *Business & Information Systems Engineering*:2), pp. 89-96.
- Stieglitz, S., Mirbabaie, M., Ross, B., and Neuberger, C. 2018. "Social Media Analytics – Challenges in Topic Discovery, Data Collection, and Data Preparation," *International Journal of Information Management* (39), pp. 156-168.
- Strogatz, S. H. 2001. "Exploring Complex Networks," *nature* (410:6825), p. 268.
- Tavakoli, A., Schlagwein, D., and Schoder, D. 2015. "Open Strategy: Consolidated Definition and Processual Conceptualization," in: *International Conference on Information Systems (ICIS)*. Fort Worth, USA.
- Treem, J. W., and Leonardi, P. M. 2012. "Social Media Use in Organizations: Exploring the Affordances of Visibility, Editability, Persistence, and Association," *Communication yearbook* (36), pp. 143-189.
- Wasserman, S., and Faust, K. 1994. *Social Network Analysis: Methods and Applications*. Cambridge: Cambridge University Press.
- Yakovenko, V. M., and Rosser Jr, J. B. 2009. "Colloquium: Statistical Mechanics of Money, Wealth, and Income," *Reviews of Modern Physics* (81:4), p. 1703.
- Zhang, J., Qu, Y., Cody, J., and Wu, Y. 2010. "A Case Study of Microblogging in the Enterprise: Use, Value, and Related Issues," *28th annual SIGCHI conference on Human factors in computing systems*, Atlanta.
- Zhao, D., and Rosson, M. B. 2009. "How and Why People Twitter: The Role That Micro-Blogging Plays in Informal Communication at Work," *Proceedings of the ACM 2009 international conference on Supporting group work*: ACM, pp. 243-252.

## Appendix 1

### Algorithm for Gini coefficient:

1. Count number of contributions for each active user of the group(Likes, Posts, Replies, Mentions), then sort them from low to high.
2. Calculate Lorentz Curve: Y-Axis: Proportion of total contributions that are made by the bottom x% of the users (see Figure)
3. Calculate size of area between red and blue line of Figure
4. Standardize by multiplying by 2
5. Get Value between 0 (if all users contributed equally) and 1 (if only one user contributed)

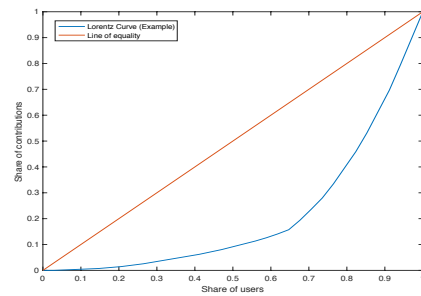

## Copyright

**Copyright:** © 2018 Kai Riemer, Laurence Lock Lee, Cai Kjaer, Annika Haeffner. This is an open-access article distributed under the terms of the [Creative Commons Attribution-NonCommercial 3.0 Australia License](https://creativecommons.org/licenses/by-nc/3.0/australia/), which permits non-commercial use, distribution, and reproduction in any medium, provided the original author and ACIS are credited.

# Exploring the Boundary Conditions of Social Influence for Social Media Research

## **Dharshani Chandrasekara**

Faculty of Information Technology  
Monash University  
Melbourne, Australia  
Email: dharshani.chandrasekara@monash.edu

## **Darshana Sedera**

Faculty of Information Technology  
Monash University  
Melbourne, Australia  
Email: darshanasedera@gmail.com

## **Abstract**

Along with the proliferation of social networking sites (SNS), people around the world have gained the ability to influence each other in terms of many aspects of lives may it be a political interest or a simple purchase decision. However, most of the SNS studies have employed social influence constructs that were established prior to the advent of SNS to understand the nature and impact of social influence. Even though the application of such theories for SNS has generated a wealth of knowledge, it is vital to acknowledge the necessity of a new perspective that is specific to the current context. Therefore, we conducted a review of 65 studies to explore which social influence constructs have been employed by previous SNS studies and introduced five boundary conditions that should be taken into consideration when employing social influence theory for future SNS studies.

**Keywords** Social influence, social impact, social media, boundary conditions, literature review



## 1 Introduction

Along with the advent of SNS, people around the world were able to step into a new level of social interactions (Palekar et al. 2018). According to the latest statistics, in 2018, the global population using SNS reached 3.196 billion, with an annual increase of 13% (Chaffey 2018). The proliferation of SNS like Facebook and Twitter also has been acknowledged in the academic literature for exerting influence on the individual and the society (Kane et al. 2014; Oh et al. 2017; Sedera et al. 2017; Sedera et al. 2016). Sinha and Fung (2018) argue that individuals can be treated as ‘micro-influencers.’ Such commentary further highlights the social influence and social impact<sup>1</sup> generated by people through SNS. On the other hand, the magnitude of the social influence is also gaining traction in SNS. For example, it is estimated that the average Facebook user has 338 friends (Smith 2017), with another 15% of users with more than 500 friends (Smith 2014). The average Twitter user has 707 followers (MacCarthy 2016). Such a large number of ‘micro-influencers’ are interacting on a daily basis on SNS platforms. The volume, voracity and influence of such high levels of influences can push even the established theoretical views on social influence into reconsidering their theoretical boundaries.

Even before the proliferation of SNS, there has been a continuous effort to understand the ‘influence’ of society on the individual (Kelman 1958). For the past several decades, studies have delivered various theories and frameworks to better understand social influence (Bagozzi and Dholakia 2002; Kelman 1958; Kuan et al. 2014; Latané 1981). With the advent and mass proliferation of SNS, researchers agree that social influence is growing and changing (Bagozzi and Dholakia 2002). Researchers of various disciplines have contributed through a wealth of studies to better understand the social influence that occur as a result of people’s interactions in SNS, including information systems (Alarifi et al. 2015; Sedera et al. 2017), marketing (Dholakia et al. 2004; Sedera et al. 2017), organizational environment (Arvidsson and Holmström 2013) and political science (Tufekci and Wilson 2012). Moreover, the impact of SNS has been discussed in various sectors, including automobile (Wang et al. 2015), music (Dewan et al. 2017), and film industry (Oh et al. 2017).

The objective of this research paper is to explore the boundary conditions of these two theoretical foundations of social influence (Kelman 1958) and social impact (Latané 1981), especially in light of the novelty in SNS. Despite the continuing advancements of SNS, these boundary conditions have received very little attention. Without a clear understanding of the boundary conditions in this rapidly changing context, applying existing theoretical conditions could lead to incorrect interpretations (Busse et al. 2017). In an assessment of 65 studies on social influence published in top-tier journals, we found little evidence that such boundary conditions are established, reviewed, or revised. Herein, we propose five boundary conditions necessary for the utilization of the current theories of social influence. The paper proceeds in the following manner. First, it provides an overview of the two streams of social influence studies. Then it investigates the constructs employed in social influence using the literature sample. Next, five boundary conditions are presented and explained in light of the constructs employed in the social influence studies.

## 2 Theoretical Foundations of Social Influence

The SNS research on social influence is mainly based on two theoretical streams (i) social influence theory (Kelman 1958) and (ii) social impact theory (Latané 1981).

### 2.1 Stream 1: Social Influence

One of the key theories in social influence was introduced by Kelman (1958) through his research paper on “Compliance, identification, and internalization: Three processes of attitude change.” According to this particular study (Kelman 1958), social influence can be accepted by three different types of constructs namely, compliance which is also identified as subjective norm, and refers to the influential capabilities of significant others or powerful people in the influencee’s life (Bagozzi and Dholakia 2002), identification, which is the process where a person acts in a certain way to gain acceptance or a feeling of belongingness in a particular group or an individual (Kelman 1958) and internalization, through which, a person would engage in a particular behaviour because the behaviour is agreeable with his/her value system (Kelman 1958). However, based on Kelman’s study, in general, social influence can be defined as the process of attitudinal or behavioural change that occurs within a person due to different types of communications a person engages in. The foundation for the social influence studies in

---

<sup>1</sup> The terms “social influence” and “social impact” have been used interchangeably (Latané 1996) due to the similarity of the effect they generate. Henceforth, these two will be referred to as “social influence” in general to avoid confusion.

Information Systems, particularly on SNS, has been mainly laid with the support of this substantial contribution of Kelman. In fact, a number of studies exploring the social influence in virtual communities have utilized Kelman's theory on social influence as the basis for their research (Bagozzi and Dholakia 2002; Bagozzi et al. 2007; Dholakia et al. 2004; Zhou 2011). However, the social influence research in virtual communities has not been limited to the study of these three processes in the key theory of social influence by Kelman. Kuan et al. (2014) utilize informational social influence and normative social influence to understand how purchase decisions in group buying sites can be affected by social influence. Under this study, informational influence has been applied for situations where people would make decisions based on others actions and judgments thus treating them as sources of information, and normative influence is applied when people take decisions to comply with others, based on others preferences or expectations. Further, Kuan et al. (2014) indicate that both informational and normative influences are contributing to conformity. In addition, another different perspective of social influence studied under SNS is the concept of peer influence. Peer influence can be defined as the process in which peers or friends play an important role when a particular person is making a decision to act in a particular way (Godinho de Matos et al. 2014).

In social psychology, together with some of the above-mentioned aspects of social influence, many other factors have also been incorporated in comprehending social influence (Vaughan and Hogg 2005). Vaughan and Hogg (2005) have further highlighted obedience, persuasion, conformity, normative influence, informational influence, majority influence and minority influence as different processes of social influence through which a person can be directed to act in a certain way. If social influence of SNS is considered in a broader perspective, the researchers in the Information Systems domain have also utilized the Spiral of Silence to explain how people are influenced in the digital spheres to remain as mere passive recipients due to social and organizational factors (Palekar et al. 2018). Thus, it is evident that research in SNS has covered a broad spectrum of theories and concepts related to social influence when understanding the user behaviours in the digital sphere. Overall, social influence studies in information systems employ constructs like, compliance, identification, internalization, peer influence, informational influence and normative influence as the key variables (Bagozzi and Dholakia 2002; Kuan et al. 2014; Sedera et al. 2017; Zhang et al. 2018).

## 2.2 Stream 2: Social Impact

The theory of social impact was first introduced by Latané in 1981. Latané (1981, p. 343) defines social impact as "the great variety of changes in physiological states and subjective feelings, motives and emotions, cognitions and beliefs, values and behaviour, that occur in an individual, human or animal, as a result of the real, implied, or imagined presence or actions of other individuals". In order to have an impact on an individual, he further comes up with three constructs that should be present, namely, strength - "the salience, power, importance, or intensity of a given source to the target", immediacy - "closeness in space or time and absence of intervening barriers or filters" and number - "how many people there are" (Latané 1981, p. 344).

Even though social impact theory was established prior to the advent of SNS, several studies have utilized the theory in explaining the behaviour of individuals in digital spaces (Kwahk and Ge 2012; Miller and Brunner 2008). As a matter of fact, when relating the construct of immediacy which is mainly regarding the physical proximity between the source and the target of impact, a study has defined immediacy in the digital environment in terms of "participant's proximity to the chat room dialogue as evidenced by a participant's number of contributions and their total number of contributed words" (Miller and Brunner 2008, p. 2977). With regard to the construct namely, strength, the same study has used interpersonal factors such as assertiveness and exaggeration as indicators of strength in the person who is making an influence online. Overall, we identify three key constructs that generate social impact, namely, the strength of the network, immediacy, and the number of sources (Latané 1981). It was also noted that some studies of social impact, commonly employ two concepts of the social *influence* theory of Kelman (1958) namely, normative influence and informational social influence (e.g. Kwahk and Ge 2012). On the other hand, the information and the knowledge to which that person would be exposed in SNS would make him/her affected by informational influence. The study has further recognized that SNS lead to a high level of informational influence because of which the SNS users' online activities such as visiting e-commerce platforms and purchasing items online would be influenced (Kwahk and Ge 2012).

## 3 The Overview of the Literature Sample

The objective of the literature analyses was (i) to develop an understanding of the utility of the two streams of studies, (ii) to identify the constructs of social influence and (iii) propose boundary conditions

necessary. Conducting a literature analysis was decided as the most appropriate for the study since the authors identified that even though theories of social influence have been widely utilized in the domain of information systems, (Bagozzi and Dholakia 2002; Kuan et al. 2014; Sedera et al. 2017; Vannoy and Palvia 2010), up to date, a comprehensive literature analysis on this topic has not been conducted. In the meantime, a literature analysis would lay a strong foundation to facilitate future research that would employ social influence constructs to examine social interactions in SNS. The literature sample includes an amalgamation of: (i) basket-of-8 journal papers in the information systems published between 2008 to 2018<sup>2</sup>, (ii) most cited studies on the theories of social influence, and (iii) PlumX<sup>3</sup> highly cited social media research that is not in segment i or ii. We used keywords namely “social influence”, “influence”, “social influence and social media”, social influence and social networks”, “social media”, “social impact”, “social impact and social media”, “impact”, and “social interaction and social media” in the process of identifying the most suitable literature for the sample. First, the seminal papers on social influence and social impact theory were added to the literature sample. Then from the basket-of-8 journals, research papers on social influence and virtual communities were selected based on the keywords. Finally, based on the reference lists of the selected journal papers, which matched our search criteria, snowballing method was followed to identify research papers that are of similar nature. The search resulted in a total of 65 research publications that were suitable for the analysis to address the objectives of the study, representing information systems, management, marketing, political science, and psychology disciplines. The complete sample is available in Table 14.

### 3.1 Analysis

Once the literature sample of the 65 studies was assembled, two co-authors distilled the constructs of measurement. Table 1 includes the study and the corresponding construct employed; denoted through columns ‘A’ to ‘I’. The constructs of social influence included: (A) compliance, (B) identification, (C) internalization, (D) peer influence, (E) informational influence, and (F) normative influence. Social impact stream of research included: (G) immediacy, (H) strength, and the (I) number of sources. The mapping of the constructs was completed by one researcher and then were verified by another. Comparison of the individual classifications revealed an average inter-coder reliability exceeding 80%<sup>5</sup>.

According to the analysed data, the three constructs that were discussed the most in the selected literature were normative influence, compliance, and identification respectively. From the constructs under social impact, strength and the number of sources were the two constructs that were discussed the most. The least discussed constructs of social influence were informational influence and peer influence. Under social impact, immediacy was the least discussed construct.

The analysis highlighted that there is a possible (and perhaps unintentional) overlap between the constructs of social influence and social impact. For instance, Latané (1981, p. 344), defines strength in social impact as “the salience, power, importance, or intensity of a given source to the target.” Kelman (1958) on the other hand, refers to compliance as a process due to which an individual would behave in a particular way in order to receive rewards or approval from a person or a group, or due to the fear of being rejected. Further, he refers to identification as a process due to which a person would be influenced either to generate or to continue a successful relationship with another person or a group. Kelman (1958), further adds that for these two processes to be successful, the determinants of influence, namely “the relative importance of the anticipated effect” and “the relative power of the influencing agent” should be considered. While strength in social impact research has been discussed in the perspective of the source of impact, compliance and identification have been discussed in the perspective of the target. However, the power, salience, intensity, and the importance can be considered as attributes that should be possessed by the influencer under compliance and identification to influence the actions of the target. Such overlaps may influence the boundary conditions discussed later in this paper.

Moreover, we observed an overlap between social influence and impact studies. It was observed that ~23% of the literature sample (15 studies) has employed both theoretical streams of social influence and social impact. In other words, in a study of social influence, constructs of social impact are either

---

<sup>2</sup> The reason for selecting the time range from 2008 to 2018 is to obtain the most up to date research findings relevant for the objectives of the research. Once the most relevant research papers were selected, the authors then used snowballing method to identify other relevant research publications from the reference lists of the selected research papers.

<sup>3</sup> PlumX metrics “gathers and brings together appropriate research metrics for all types of scholarly research output” (PlumX Metrics - Plum Analytics” n.d.)

<sup>4</sup> The reference list of the literature review table can be obtained by visiting the following link: [https://docs.google.com/document/d/1kulVbe2-GdhRTKAsB6gWlxf5WWHUg8TES9k\\_e3WmeQ/edit?usp=sharing](https://docs.google.com/document/d/1kulVbe2-GdhRTKAsB6gWlxf5WWHUg8TES9k_e3WmeQ/edit?usp=sharing)

<sup>5</sup> Krippendorff (1980) recommends inter-coder reliability of at least 70%

implicitly discussed or measured for analysis purposes. In a similar manner, some social impact studies consider the influence of the network post-hoc.

The literature sample in Table 1 is chronologically ordered. While it was expected that the number of studies employing social influence and impact would increase over time (with the advent and proliferation of SNS), in reality, the number of studies is plateauing. Moreover, studies introduced no new constructs for social impact. However, several new constructs were introduced in studies of social influence to capture the social influence generated by people in SNS.

The context of social influence is an important consideration that would affect the study outcomes. For example, the social influence theory was originated in the face-to-face, physical context of human interactions. However, we observed that the theory has been employed by approximately 65% studies that have considered social media or virtual community as the context (denoted with an (\*) for virtual community studies and (\*\*) for social media studies in Table 1). Contrasting with the studies employing other media of social interaction, no study in our sample has specifically observed the theoretical challenges in employing the social influence in SNS.

### 3.1.1 Focus on boundary conditions

The literature sample demonstrates that, while we have made substantial leaps in technology by creating social networking sites arriving at a hyper-connected society, our theoretical foundations employed in information systems studies barely have changed. In particular, no study in our literature sample provides attention to possible boundary conditions when moving a theoretical foundation that was derived on the basis of face-to-face human influence to a context of augmented, inflated and excessive social influence of SNS. Yet, regardless of the context, all studies employ the same constructs (i.e. A to I in Table 1) without any justification. While the consistency in employing the constructs of social influence would lead to a cumulative tradition of research, this lack of acknowledgement of a major shift in the context (e.g. face-to-face to virtual being one of them) not only weakens our observations, it precludes us from making a precise understanding of the nature of social influence in the new context.

## 4 Revisiting the Boundary Conditions

Even though researchers from various disciplines have studied the nature of social influence generated in SNS on an individual (or society), much of the theoretical work underpinning these discussions have placed their foundations on the theories that were developed prior to the advent of SNS. Herein we specifically propose that, when considering social influence, studies must specify and observe *conditions that the constructs are bounded by* Dubin (1969). The boundary conditions are derived through a comparison of the conditions upon which the *traditional* social interactions (e.g. face-to-face) against the conditions upon which the digital interaction happens. These 'limiting values' are particularly potent in the SNS context. Lack of boundary condition specificity in emerging research could lead to either type-I or type-II errors. For example, you may reject the true null hypothesis (type-I) or fail to reject a false null hypothesis (type-II), by inadvertently selecting a particular sample that may not be 'random.'

In order to better illustrate, we identified five (5) salient bounding conditions that would affect the nature of social influence in the SNS era. These five factors can provide what Dubin called the 'boundaries' of the theory. Dubin (1969), states that "in order that a model may represent an empirical system, it has to have the boundaries corresponding to the empirical system. The boundaries are important to the specification of any theoretical model."

The 5 boundaries were recognized that would add meaning to the future SNS social influence studies: (i) the choice, (ii) space and proximity, (iii) the locus of social influence, (iv) the number of people and times, (v) the diversity and the variety of social influence. Exploring social influence using these boundary conditions would allow researchers to provide more profound insights into this emerging and important phenomenon of social media. Panels in Figure 1 provide a graphical illustration of the five boundary conditions specified for the social influence studies.

Table 1. Literature Analysis<sup>6</sup>

Study	A	B	C	D	E	F	G	H	I	Study	A	B	C	D	E	F	G	H	I
(Kelman 1958)	Y	Y	Y	N	Y	Y	N	Y	N	** (Zhou 2011)	Y	Y	Y	N	N	Y	N	Y	N
(Latané 1981)	Y	N	N	N	N	Y	Y	Y	Y	(Datta 2011)	Y	Y	Y	N	N	Y	N	Y	N
(Nowak et al. 1990)	Y	N	N	N	Y	Y	Y	Y	Y	(Shen et al. 2011)	Y	Y	Y	N	N	Y	N	Y	N
(Latané et al. 1995)	Y	N	N	N	N	Y	Y	Y	Y	** (Cheung et al. 2011)	Y	Y	Y	N	Y	Y	N	Y	N
(Latané 1996)	Y	Y	N	N	N	Y	Y	Y	Y	** (Kietzmann et al. 2011)	N	N	N	Y	N	N	N	Y	Y
*(Latané and Bourgeois 1996)	N	N	N	N	N	N	Y	Y	Y	** (Hanna et al. 2011)	N	N	N	Y	Y	N	N	N	N
(Venkatesh and Davis 2000)	Y	Y	Y	N	Y	Y	N	Y	N	** (Fischer and Reuber 2011)	N	N	N	N	N	Y	N	N	N
*(Bagozzi and Dholakia 2002)	Y	Y	Y	N	Y	Y	N	N	Y	** (Mir and Zaheer 2012)	N	N	N	N	Y	N	Y	Y	Y
(Dholakia and Talukdar 2004)	Y	N	N	N	Y	Y	N	Y	N	** (Kwahk and Ge 2012)	Y	Y	N	N	Y	Y	Y	Y	Y
*(Dholakia et al. 2004)	Y	Y	Y	N	Y	Y	N	N	N	** (Tufekci and Wilson 2012)	N	N	N	N	Y	N	N	Y	N
(Algesheimer et al. 2005)	Y	Y	N	N	Y	Y	N	Y	Y	** (Lipsman et al. 2012)	N	N	N	Y	N	N	Y	N	Y
(Lu et al. 2005)	Y	Y	Y	N	Y	Y	N	Y	N	** (Gensler et al. 2013)	N	N	N	Y	Y	N	N	Y	Y
(Gallivan et al. 2005)	Y	N	Y	Y	Y	Y	N	Y	N	(Singh and Phelps 2013)	Y	N	N	Y	Y	Y	Y	Y	N
(Lee et al. 2006)	Y	N	Y	N	N	Y	N	N	N	** (Hildebrand et al. 2013)	Y	Y	Y	N	Y	Y	N	Y	N
*(Song and Kim 2006)	Y	Y	N	Y	Y	Y	N	Y	N	(Wang et al. 2013)	Y	Y	Y	Y	Y	Y	Y	Y	N
(Li et al. 2006)	Y	N	Y	N	N	Y	N	N	N	*(Tsai and Bagozzi 2014)	Y	Y	Y	N	Y	Y	N	Y	Y
*(Bagozzi et al. 2006)	Y	Y	Y	N	N	Y	N	Y	N	*(Kuan et al. 2014)	Y	Y	N	Y	Y	Y	N	Y	Y
*(Bagozzi et al. 2007)	Y	Y	Y	N	N	Y	Y	Y	N	** (Zhang et al. 2014)	N	N	N	Y	N	N	Y	N	Y
*(Miller and Brunner 2008)	Y	N	N	Y	N	Y	Y	Y	Y	(Godinho de Matos et al. 2014)	N	Y	N	Y	N	Y	N	N	Y
** (Walther et al. 2008)	N	N	N	Y	N	N	Y	N	N	** (Hu et al. 2015)	N	N	N	N	N	N	N	N	N
(Eckhardt et al. 2009)	Y	N	N	Y	Y	Y	N	Y	N	** (Wang et al. 2015)	N	N	N	N	N	N	N	N	N
(Yang et al. 2009)	Y	Y	Y	N	Y	Y	Y	Y	Y	** (Matook et al. 2015)	Y	Y	N	Y	N	Y	N	Y	N
** (Mangold and Faulds 2009)	N	N	N	N	Y	N	N	N	N	** (Tussyadiah et al. 2015)	N	Y	Y	Y	Y	Y	N	Y	N
** (Pempek et al. 2009)	N	N	N	Y	N	Y	N	N	N	** (Oh et al. 2017)	N	N	N	N	Y	N	N	N	N
(Kulviwat et al. 2009)	Y	Y	Y	N	Y	Y	N	Y	N	** (Sedera et al. 2017)	Y	Y	Y	Y	Y	Y	N	Y	Y
** (Zeng et al. 2009)	N	Y	Y	N	N	Y	N	N	N	** (Thomaz et al. 2017)	N	N	N	N	N	N	N	N	N
** (Kaplan and Haenlein 2010)	Y	Y	N	N	N	Y	Y	N	N	** (James et al. 2017)	N	N	N	Y	N	N	N	N	N
*(Shen et al. 2010)	Y	Y	Y	Y	N	Y	N	Y	N	*(Liao et al. 2017)	N	N	N	N	N	N	N	N	N
*(Posey et al. 2010)	N	Y	N	N	Y	Y	N	N	N	** (Rueda et al. 2017)	Y	Y	N	Y	N	Y	N	Y	N
*(Huffaker 2010)	Y	N	N	N	Y	Y	Y	Y	Y	** (Brandt et al. 2017)	N	N	N	N	N	N	N	N	N
(Glass and Li 2010)	Y	N	N	Y	N	Y	N	Y	Y	** (Dewan et al. 2017)	N	N	N	Y	N	N	N	N	Y
*(Vannoy and Palvia 2010)	Y	N	N	N	N	Y	N	Y	N	(Zhang et al. 2018)	N	N	N	Y	N	N	N	N	Y
** (Cheung and Lee 2010)	Y	Y	Y	N	N	Y	N	Y	Y										

<sup>6</sup> A – Compliance, B – Identification, C – Internalization, D – Peer Influence, E – Informational Influence, F – Normative Influence, G – Immediacy, H – Strength, I – Number of Sources

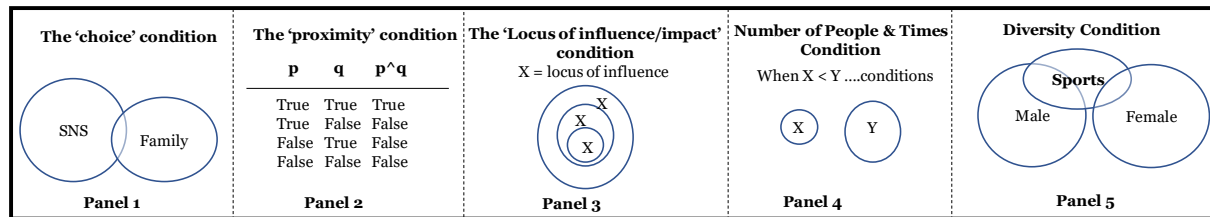

Figure 1. Boundary Conditions for Social Media Research

#### 4.1 The Choice of the Social Circle

Figure 1, panel 1 demonstrates the overlap of the family members and SNS. While in the physical world, a person may not have a choice in selecting the people with whom he/she would need to interact (e.g. family members, colleagues), in SNS, a person receives the ability either to add or remove a person from the SNS, and thereby to decide whether or not to interact with another individual in the digital space or not. Moreover, not all the family members will necessarily be in a social network. For instance, Bagozzi and Dholakia (2002) differentiate virtual communities from traditional communities, stating that members of SNS have a voluntary association with the membership. Therein, the individual could quit the network at any given time without participation. Hall and Fagen (1956) argue such boundary conditions as exterior boundary conditions. It is argued that when either a new unit of measurement must be introduced into a theorem, the unit must be designated affirmatively as must be the theorem (Dubin 1969). Hall and Fagen (1956) further state that in such cases when an exterior boundary condition changes the outcome of a proposed model, such variables should be considered as intervening variables (moderation and mediation assumed). In social influence studies, the *choice* one would exert in determining their *own* social network, therefore, should be taken into account in future studies. Zhang et al. (2018) investigate the ‘direct’ vs. ‘indirect’ peer influence in social media, arguing that “*Peer influence can arise from immediate neighbours in the network and from indirect peers who share common neighbours.* (p. 1)” Their findings, based on an analysis of call logs, demonstrate significant differences between the direct vs. indirect influences. While such differentiations are visible in the traditional context, deriving such differentiations is nearly impossible in SNS. Therefore, for studies on social influence, the ‘choice’ condition should be specified, as the influence would only arise from those whom you have selected to be included in your social networks. For example, when such facets like (A) compliance, (B) identification, (C) internalization or (D) peer influence are considered, the choice that the individual has consciously taken must be taken into account. Similarly, when measuring the social impact through constructs like (G) immediacy and (H) strength, these constructs would be impacted by the choice condition.

#### 4.2 Space and Proximity

Space and proximity are considered as another suitable boundary condition for SNS studies based on our literature analysis. Herein, we refer to two types of proximities, namely the physical proximity and the digital proximity. While in the social impact theory, Latané argues that physical proximity affected the influence a person makes on another, in SNS settings, we argue that both physical and digital proximity would affect whether or not a person would be influenced by another person. Herein, by digital proximity, we mean the proximity between SNS users in terms of belonging to the same online group or being members of the same page, due to which the SNS users would feel a form of connectedness. Figure 1, panel 2 outlines an example of a truth table for the proximity condition. Therein we argue that both ‘p’ and ‘q’ must be understood in social influence studies, where ‘p’ is the ‘digital proximity’ and ‘q’ is ‘physical proximity’ that one has to a network or its subjects. Latané and Bourgeois (1996) in their works of the Dynamic Social Impact theory<sup>7</sup> highlight that the social influence, at least with respect to memorable interactions, seems to decrease with the square of the distance. However, the same study suggests that with the influence of the technology, the social space between people will be affected and thus the effective distance between people would be reduced. For example, for (C) internalization, a commonly used construct in social influence, there is a high likelihood for internationalization to be optimal if both conditions are true. Similarly, the proximity of influence must be considered in (G) immediacy to recognize the physical and digital distances of the influencer. A study that implicitly discusses the proximity condition is Dewan et al., (2018). They acknowledge the

<sup>7</sup>Dynamic social impact theory consists of four constructs namely clustering, correlation, consolidation and continuing diversity. Latané and Bourgeois (1996) have utilized these 4 constructs to analyze the user behaviors in electronic groups and thereby to explore the operation of social impact in social space.

difficulties in assessing the proximity in SNS stating that “*identifying proximity influence using observational data is challenging due to homophily, which may influence both the formation of social ties and music consumption decisions*” (p. 119).

### 4.3 The Locus of Social Influence

Figure 1, panel 3 denotes the locus of social influence. The boundary condition on the ‘the locus of social influence’ recognizes that there are multiple ‘realms’ of networks, not just one layer of social network around an individual. As such, the social influence may arise from any of those realms. However, it is asserted that not all realms would have the same level of social influence. Depending on the nature of the event and the nature of the influencer or the group affiliated, the individual could be receptive to the influencer. For example, ‘#Metoo’ movement against sexual harassment had active participation from 85 countries (Park 2017). Furthermore, the locus of social influence would have an effect on studies employing the (C) internalization as an aspect of social influence. Given the realms of social networks, internalization may be short-term or long lasting, depending on the locus of control. For instance, Tufekci and Wilson (2012) examining a political protest in Egypt indicate how the political content generated by a few groups such as journalists, and activists, escalated to the level of a real-world protest due to the adoption and the acceptance of the political ideology spread through social media by the general public. Hence, while different messages would be communicated in SNS, facts such as the nature of the influencer, and the nature of the event, would affect different people in SNS to either to be influenced or to not to be influenced based on the relationship a person has with the event and the influencer.

### 4.4 The Number of People & Times

Figure 1, panel 4 demonstrates the possible effect that the number of people and times has on social influence constructs. Herein, we claim that, the more number of people you are exposed to in an SNS, and the more number of times a particular message is circulated, the higher the tendency of a person to be influenced in the context of SNS. For instance, Facebook indicates individuals having an average of 338 friends (Smith 2017). While the exact number of the average of friends that an individual has may be debatable, it is clear that social networks allow more friends (Mangold and Faulds 2009). As such, when a condition receives more citations due to the number of people in your network citing it, such conditions are likely to have a high influence. The fundamental premise of ‘repeated message’ (Black 1949) is developed on the premise of the influence of the number and the time premises. As such, constructs like (E) informational influence, and (F) normative influence will be affected by the number of people and times. For instance, Kuan et al. (2014) in their study on online buying behaviours highlight that information on the number of people who have bought a product (informational influence) and the type of people who have ‘liked’ a product (normative influence) in SNS affect the purchase decisions of the consumers.

### 4.5 The Diversity and the Variety of Social Influence

Figure 1, panel 5 recognizes the diversity and the variety of connections maintained in SNS (Walther et al. 2008). As expressed in panel 5 as an example, we demonstrate how *maleness plus sports* has a narrower domain than the either one alone. The diversity and the variety of social influence indicate how people would be susceptible for social influence in SNS based on the diversity of the connections a person is exposed to in SNS, and thereby, the variety of social influence a person would receive in SNS. When comparing the diversity and the variety of social influence in traditional vs social networks, Kwahk and Ge (2012, p. 1816) indicate that in the past the social circles had narrower diversity, but with the proliferation of SNS, the social is influence is getting “broader and stronger” making the presence of SNS an important aspect of peoples’ lives. As such, the researcher has an obligation to specify *which* spectrum of social influence is sought.

## 5 Conclusion

Social influence and impact are two vital streams of research that allow us to understand the interactions and the effects of society on an individual (or society). The popular theoretical foundations that investigate social influence are under increasing pressure due to the advent and proliferation of SNS. While much of the works of social influence have added a wealth of knowledge, studies lack a nuanced view of the ‘boundary conditions’ that are entrenched in SNS. For instance, when utilizing the constructs generated by the social influence theory, the previous studies have identified that not all constructs that generated social influence in the physical world can be applied in the same way to understand the social influence in SNS (Zhou 2011). Identifying this limitation in applying social influence to SNS, this paper

proposed five boundary conditions and demonstrated how recognizing such boundary conditions up-front can provide better insights. The analysis of the 65 past studies provides us with the confidence to suggest that the boundary conditions are applicable to understand social influence in the contemporary setting of SNS. The overlaps between the constructs of social influence, the percentage of studies using both theorems in a single study, the application of the five boundary conditions to constructs of social influence suggest this wider application. With regard to the limitations of the study, the boundary conditions were derived based only on a literature analysis. The future research can further establish these boundary conditions by conducting empirical tests. However, the identification of the five boundary conditions means that researchers can now develop instruments and procedures to measure these conditions. In terms of knowledge generation, we believe the findings of this study will serve as a theoretical lens for the researchers in the domain of information systems to look at social influence generated by SNS in a new perspective. This would also enable future studies to be more specific in using social influence and make their findings more relevant to the context of SNS. With regard to the practical implications, utilizing the insights we provide in this study by establishing boundary conditions, which are applicable specifically to the context of SNS, the practitioners will be able to develop strategies, which can yield better outcomes with regard to their SNS campaigns. Notably, in terms of social media marketing, the boundary conditions would allow the practitioners to identify the most optimal conditions under which the social influence would be higher, and thus, affect the behaviours of the consumers.

## 6 References

- Alarifi, A., Sedera, D., and Recker, J. 2015. "Posters versus Lurkers: Improving Participation in Enterprise Social Networks through Promotional Messages," *International Conference on Information Systems (ICIS 2015)*, The Association for Information Systems (AIS).
- Arvidsson, V., and Holmström, J. 2013. "Social Media Strategy: Understanding Social Media, It Strategy, and Organizational Responsiveness in Times of Crisis," *Cutter IT Journal* (26:12), pp. 18-23.
- Bagozzi, R. P., and Dholakia, U. M. 2002. "Intentional Social Action in Virtual Communities," *Journal of Interactive Marketing* (16:2), pp. 2-21.
- Bagozzi, R. P., Dholakia, U. M., and Pearo, L. R. K. 2007. "Antecedents and Consequences of Online Social Interactions," *Media Psychology* (9:1), pp. 77-114.
- Black, J. W. 1949. "The Relation between Message- Type and Vocal Rate and Intensity," *Speech Monographs* (16:2), pp. 217-220.
- Busse, C., Kach, A. P., and Wagner, S. M. 2017. "Boundary Conditions: What They Are, How to Explore Them, Why We Need Them, and When to Consider Them," *Organizational Research Methods* (20:4), SAGE Publications Sage CA: Los Angeles, CA, pp. 574-609.
- Chaffey, D. 2018. "Global Social Media Summary 2018." Retrieved April 06, 2018, from <https://www.smartinsights.com/social-media-marketing/social-media-strategy/new-global-social-media-research/>
- Dewan, S., Ho, Y.-J., and Ramaprasad, J. 2017. "Popularity or Proximity: Characterizing the Nature of Social Influence in an Online Music Community," *Information Systems Research* (28:1), pp. 117-136.
- Dholakia, U. M., Bagozzi, R. P., and Pearo, L. K. 2004. "A Social Influence Model of Consumer Participation in Network- and Small-Group-Based Virtual Communities," *International Journal of Research in Marketing* (21:3), pp. 241-263.
- Dubin, R. 1969. *Theory Building*. New York: Free Press.
- Godinho de Matos, M., Ferreira, P., and Krackhardt, D. 2014. "Peer Influence in the Diffusion of the Iphone 3g over a Large Social Network," *MIS Quarterly* (38:4), pp.1103-1133.
- Hall, A. D., and Fagen, R. E. 1956. "Definition of System," *General systems* (1:1), pp. 18-28.
- Huffaker, D. 2010. "Dimensions of Leadership and Social Influence in Online Communities," *Human Communication Research* (36:4), pp. 593-617.
- Kane, G. C., Alavi, M., Labianca, G., and Borgatti, S. P. 2014. "What's Different About Social Media Networks? A Framework and Research Agenda.(Report)," *MIS Quarterly* (38:1), pp. 274-304.
- Kelman, H. C. 1958. "Compliance, Identification, and Internalization Three Processes of Attitude Change," *Journal of Conflict Resolution* (2:1), pp. 51-60.
- Knapton, S. 2016. "Facebook Users Have 155 Friends - but Would Trust Just 4 in a Crisis." <https://www.telegraph.co.uk/news/science/science-news/12108412/Facebook-users-have-155-friends-but-would-trust-just-four-in-a-crisis.html> Retrieved April 06, 2018.
- Krippendorff, K. 1980. *Content Analysis: An Introduction to Its Methodology*. Beverly Hills, CA: Sage.



- Kuan, K. K., Zhong, Y., and Chau, P. Y. 2014. "Informational and Normative Social Influence in Group-Buying: Evidence from Self-Reported and Eeg Data," *Journal of Management Information Systems* (30:4), pp. 151-178.
- Kwahk, K.-Y., and Ge, X. 2012. "The Effects of Social Media on E-Commerce: A Perspective of Social Impact Theory," *System Science (HICSS), 2012 45th Hawaii International Conference on: IEEE*, pp. 1814-1823.
- Latané, B. 1981. "The Psychology of Social Impact," *American psychologist* (36:4), pp. 343-356.
- Latané, B., and Bourgeois, M. J. 1996. "Experimental Evidence for Dynamic Social Impact: The Emergence of Subcultures in Electronic Groups," *Journal of Communication* (46:4), pp. 35-47.
- MacCarthy, R. 2016. "The Average Twitter User Now Has 707 Followers." <https://kickfactory.com/blog/average-twitter-followers-updated-2016/> Retrieved April 15, 2018.
- Mangold, W. G., and Faulds, D. J. 2009. "Social Media: The New Hybrid Element of the Promotion Mix," *Business horizons* (52:4), pp. 357-365.
- Miller, M. D., and Brunner, C. C. 2008. "Social Impact in Technologically-Mediated Communication: An Examination of Online Influence," *Computers in Human Behavior* (24:6), pp. 2972-2991.
- Nowak, A., Szamrej, J., and Latané, B. 1990. "From Private Attitude to Public Opinion: A Dynamic Theory of Social Impact," *Psychological Review* (97:3), pp. 362-376.
- Oh, C., Roumani, Y., Nwankpa, J. K., and Hu, H.-F. 2017. "Beyond Likes and Tweets: Consumer Engagement Behavior and Movie Box Office in Social Media," *Information & Management* (54:1), pp. 25-37.
- Palekar, S., Atapattu, M. R., Sedera, D., and Lokuge, S. 2018. "Exploring Spiral of Silence in Digital Social Networking Spaces," *International Conference on Information Systems (ICIS 2015): Exploring the Information Frontier: Association for Information Systems (AIS)*.
- Park, A. 2017. "#Metoo Reaches 85 Countries with 1.7m Tweets." <https://www.cbsnews.com/news/metoo-reaches-85-countries-with-1-7-million-tweets/> Retrieved April 16, 2018.
- "PlumX Metrics - Plum Analytics." (n.d.). <https://plumanalytics.com/learn/about-metrics/> Retrieved August 4, 2018.
- Sedera, D., Lokuge, S., Atapattu, M., and Gretzel, U. 2017. "Likes—the Key to My Happiness: The Moderating Effect of Social Influence on Travel Experience," *Information & Management* (54:6), pp. 825-836.
- Sedera, D., Lokuge, S., Salleh, N. A. M., Moghavvemi, S., and Palekar, S. 2016. "Spoilt for Choice: When User-System Relationship Becomes One-to-Many," *International Conference on Information Systems (ICIS2016): Association for Information Systems (AIS)*.
- Sinha, J. I., and Fung, T. T. 2018. "The Right Way to Market to Millenials." <https://sloanreview.mit.edu/article/the-right-way-to-market-to-millennials/> Retrieved May 01, 2018.
- Smith, A. 2014. "What People Like and Dislike About Facebook." <http://www.pewresearch.org/fact-tank/2014/02/03/what-people-like-dislike-about-facebook/> Retrieved April 25, 2018.
- Smith, K. 2017. "Marketing: 47 Incredible Facebook Statistics." <https://www.brandwatch.com/blog/47-facebook-statistics/> Retrieved April 25, 2018.
- Tufekci, Z., and Wilson, C. 2012. "Social Media and the Decision to Participate in Political Protest: Observations from Tahrir Square," *Journal of communication* (62:2), pp. 363-379.
- Vannoy, S. A., and Palvia, P. 2010. "The Social Influence Model of Technology Adoption," *Communications of the ACM* (53:6), ACM, pp. 149-153.
- Vaughan, G., and Hogg, M. A. 2005. *Introduction to Social Psychology*. Pearson Education Australia.
- Walther, J. B., Van Der Heide, B., Kim, S. Y., Westerman, D., and Tong, S. T. 2008. "The Role of Friends' Appearance and Behavior on Evaluations of Individuals on Facebook: Are We Known by the Company We Keep?," *Human communication research* (34:1), pp. 28-49.
- Wang, Y.-Y., Susarla, A., and Sambamurthy, V. 2015. "The Untold Story of Social Media on Offline Sales: The Impact of Facebook in the Us Automobile Industry," *International Conference on Information Systems, ICIS 2015 Association for Information Systems*.
- Zhang, B., Pavlou, P. A., and Krishnan, R. 2018. "On Direct vs. Indirect Peer Influence in Large Social Networks," *Information Systems Research, INFORMS* (29:2), pp. 292-314.
- Zhou, T. 2011. "Understanding Online Community User Participation: A Social Influence Perspective," *Internet research* (21:1), pp. 67-81.

## Acknowledgements

This research was supported by the Australian Government Research Training Program Scholarship and Monash University.

**Copyright:** © 2018 Chandrasekara and Sedera. This is an open-access article distributed under the terms of the [Creative Commons Attribution-NonCommercial 3.0 Australia License](https://creativecommons.org/licenses/by-nc/3.0/australia/), which permits non-commercial use, distribution, and reproduction in any medium, provided the original author and ACIS are credited.

# Public value creation using social media applications for the local government context: a pilot case study

## **Althaqafi Turki**

School of Information Technology  
Monash University  
Melbourne, Australia  
[Turki.Althaqafi@monash.edu](mailto:Turki.Althaqafi@monash.edu)

## **Susan Foster**

School of Information Technology  
Monash University  
Melbourne, Australia  
[sue.foster@monash.edu](mailto:sue.foster@monash.edu)

## **Md Mahbubur Rahim**

School of Information Technology  
Monash University  
Melbourne, Australia  
[md.mahbubur.rahim@monash.edu](mailto:md.mahbubur.rahim@monash.edu)

## **Abstract**

Social media applications are receiving growing attention from local government agencies as they have the potential to offer public values to those agencies as well as providing benefits to citizens by enhancing public engagement and innovating public services. Despite the growth in the literature on social media, there is still limited understanding on how public value is created through the use of various social media applications in local government context. To address this concern, we have developed a model to investigate public value creation using social media applications. The model is evaluated using a pilot case study at a large Saudi Arabian municipality. The model and empirical evidence together contribute towards establishing a theoretical foundation for research into the impact of social media applications for public value creation. In addition, council managers can learn useful lessons drawing on our findings on how best utilise social media applications for local government matters.

**Keywords:** Social Media, Public Value, Local Government, Case Study, Saudi Arabia

## 1 Introduction

Social media is an important communication tool for use between government agencies and their constituents. It enhances the effective delivery of public services (Merickova, Svidronova, & Nemeč, 2016), supports awareness on public safety, and facilitates establishment of democracy (Mergel, 2013). For the context of the local government, social media is vital to fostering commitment with important stakeholders and promotes innovation in the public service sector. Enhancing public engagement and public services innovation is crucial in achieving public values such as fairness, trust, transparency and integrity. Despite the vast amount of literature on the benefits of social media to government agencies', no studies have systematically focused on the concept of 'public value' involving the application of social media for the context of local government. There exists limited studies on the relationship between social media capability, trust in social media, public engagement, public service innovation and the resulting public values for the local government context. Consequently, scholars are of the opinion that the Information Systems (IS) community should take the initiative of investigating these aspects (Johannessen, Sæbø, & Flak, 2016; Omar, Scheepers, & Stockdale, 2013).

This argument is valid from a local government context for developing countries where the population is known for their wide use and reliance on social media applications to express their concerns and viewpoints towards their government (Dini & Sæbø, 2016). In Saudi Arabia where this study is conducted, social media use is wildly popular. The number of internet users in Saudi Arabia skyrocketed to reach 30 million people by 2018, while 25 million are active social media users (Insight, 2018). However, it is not known yet how local government agencies are using social media to engage with citizens. According to 'Saudi Arabia Vision 2030', the government is undergoing major, dramatic, economic, cultural and social transition plans by creating more open and transparent programs (SaudiVision, 2017). Due to the nature of social media applications (e.g. openness, two-way communications), citizens and government officials alike are encouraged to better utilise these applications to achieve the 2030 vision goals. Being motivated by these, this study seeks to address the following research question: *How does the use of social media applications by local government agencies create public value?*

As part of an ongoing study, we recently presented the development of a conceptual model of how public value is created using social media applications (Althaqafi, Rahim, & Foster, 2018). In this paper, we report an empirical evaluation of a public value creation model based on a pilot case study conducted in one large Saudi Arabian municipality. From this case, we provide a rich description of how social media can be used to create public value for local government context. We find that social media capability and trust in social media can affect the level of public engagement. We also find that social media applications contribute to create public value through providing public services innovation. This paper also presents a methodological contribution to IS research, as we provide a detailed application of a critical realist ontology and methodology for social media research context. The paper is organised as follows: First, the related background literature is reviewed. Next, the model, its theoretical foundation, propositions development, and evaluation are presented, and some conclusions are drawn.

## 2 Background Literature

The notion of public value, although initially emerged in the public administration (PA) literature (Andersen, Jørgensen, Kjeldsen, Pedersen, & Vrangbæk, 2012), IS scholars is beginning to receive attention in recent years to public value created by the use of social media (Aladalah, Cheung, & Lee, 2016). Following the approach of Webster and Watson (2002), a systematic literature review was performed using Monash library databases including EBSCOHOST, PROQUEST and SPRINGER. Various combination of such search terms as social media use, government, local government, municipality, Gov2.o, social network and (among others) were used to identify the relevant academic papers on social media use by public sector agencies. From the review, we identified 71 papers. As a result, several themes related to our research emerged: social media capability, trust in social media (IS perspective), public engagement, public service innovation and public value (PA perspective), these concepts are individually described below.

### 2.1 Social Media Capability

Multiple definitions exist for social media capability in the IS literature (Braojos-Gomez, Benitez-Amado, & Llorens-Montes, 2015; Kane, 2015). Moreover, social media capability is also equated as social media affordance (Dini, Wahid, & Sæbo, 2016). These divergent ideas discussed in the existing literature can cause confusion due to their similar meanings. To avoid such confusion, we have integrated both concepts into a single construct, which we refer to as social media capability. Therefore, we adapted the

definition of social media capability from Braojos-Gomez et al. (2015) to “the ability of local government agencies’ to utilise social media functions, features and characteristics for fostering public engagement to execute government activities”. A set of three main dimensions form the social media capability construct: functions, features and characteristics. Social media functions such as information editability, and private messaging event creation allow the user to perform certain activities that are typically expected and required to complete required tasks. Features represent the aspects of the social media applications systems that, while not necessary, provide enhancements to better complete required tasks such as manage contacts capability, social media analytics capability, Access content capability, Customisable modules capability, and anonymity (Rauniar, Rawski, Yang, & Johnson, 2014). A social media characteristic can be described as the special, distinctive aspects of the social media applications in terms of interactions between two parties such as information sharing, visibility, interactivity, idea storming capability.

## 2.2 Trust in Social Media

IS literature further highlights the importance of trust from a social media context (Mcknight, Carter, Thatcher, & Clay, 2011). Trust has been addressed from two perspectives: a) trust in government behaviour through business processes performed on social media applications (Park, Choi, Kim, & Rho, 2015), and b) trust in people, either government officials or citizens in their use of social media applications (Hong, 2013). However, trust in the technological part of social media has remained largely ignored (Tams, Thatcher, & Craig, 2018). We have however adopted the viewpoint of (Mcknight et al., 2011), who defines trust in technology as the actual relationship between users and the technology in terms of functionality, helpfulness and reliability. Functionality refers to the question of whether or not the technology functions as promised by completing tasks that are required. Helpfulness represents the users’ beliefs that the technology provides sufficient support and represents a thorough help and support function (Mcknight et al., 2011). Reliability means that the technology or IT artefact operates continually (i.e. with little or no downtime) or responds predictably to inputs (Mcknight et al., 2011).

## 2.3 Public Engagement

Public engagement has gone through many developmental stages in different contexts and has been affected by ideological, social, political and methodological meanings (Nabatchi & Amsler, 2014). Due to the emergence of Information Communication Technology (ICT) tools in government agencies, there is now a shift from traditional communication to digital communication. As a result, the concept of public engagement is still taking place but through new means of digital communications like e-government and social media, which are built on web 2.0 technology. Various levels of public engagement have been reported in the literature. For example, in Arnstein (1969), a famous ladder of citizen participation, there are three levels of public engagement which are further broken down into eight levels. In contrast, Men and Tsai (2012) have only two levels of communication. In this paper, we adopt classifying public engagement into three levels: Information Dissemination, Consultation and Co-creation. The Information Dissemination level refers to the posted information on social media applications by citizens and government officials for their own benefit. Consultation is a limited two-way communication channel that allows stakeholders and citizens to contribute their opinions on some issues; the objective of this level is to collect public feedback. Consultation could be initiated by either the government or the citizens, but the change is led by the government. Citizens also expect a high response rate at this level. However, the main objective of this level is not to directly involve citizens in the decision-making process but rather to collect their feedback for future service improvement. Finally, the Co-creation level involves citizens on social media applications in decision-making processes such as planning and designing policy, services and strategies, and allocating budgets, etc. This phase could be led by citizens through citizen-to-government sourcing or citizen-to-citizen interactions where the government plays a supervisory role.

## 2.4 Public Service Innovation

Recently, there has been a great deal of professional and scholarly interest in ‘innovation’ in the public sector (Mark Harrison Moore, 1995; Mulgan & Albury, 2003; OECD, 2005). However, there exists no universal definition of innovation for the public-sector context. In this paper, we have adapted the definitions of (Criado, Sandoval-Almazan, & Gil-Garcia, 2013; Mulgan & Albury, 2003; OECD, 2005) as follows: “The implementation of a new or significantly improved product (good or service), or process which results in significant improvements in and/or a complete transformation of outcomes in the form of efficiency, effectiveness and/or quality”. We have combined multiple definitions to include different components of public service innovation such as type of change, transformation or innovation. This definition is incorporated in the four categories of public service innovation developed by (Brown &

Osborne, 2012). The four categories are 1) developmental change (the significant improvement of existing services delivered to existing users), 2) expansionary innovation (utilising an existing service and delivering it to a new group of users); 3) evolutionary innovation (creating new services for current users); 4) total innovation (supplying new services to new users).

## 2.5 Public Value

Moore (1995) who coined the term public value, identified the basic idea behind public value as being the ‘Strategic Triangle’. The strategic triangle consists of three important factors: creating something substantively valuable, legitimate and politically sustainable, and operationally and administratively feasible with available internal and external capabilities. Drawing on the strategic triangle, public organisations can generate value that could be genuinely considered useful for the citizens in many ways, such as improving the quality of public services through three main sources of public value: outcome, trust and services (Kelly, Mulgan, & Muers, 2002). Public values range from professional and managerial values to encompassing issues such as social and democratic values. Many studies have classified public values based on different dimensions (Andersen et al., 2012; Hood, 1991; Jørgensen & Bozeman, 2007; Kernaghan, 2003). From a thorough review, the taxonomy provided by Kernaghan (2003) is chosen for this research project as the basis for evaluating public value. Kernaghan (2003) has classified public value into four dimensions including ethical values, professional values, democratic values and social values. They have been used to facilitate the interaction between government officials and citizens. The taxonomy of Kernaghan (2003) has been chosen for this study because a) most classifications being proposed lack even the most basic requirements to assess their validity and usefulness, except for Kernaghan (2003) work, which has not yet been criticised (Rutgers, 2008); b) it has been classified based on public services; c) there are many duplications in the value sets of other taxonomies; d) it introduces professional values as a separate dimension, which relates more to internal activities such as effectiveness and efficiency; and e) each dimension in Kernaghan (2003) taxonomy is applicable to social media use in the government context.

## 3 Conceptual Model

This conceptual model presents the five main constructs chosen from the relevant IS and public administration literature sources described above in section 2. This model is a process based model in nature. This is because it explains how an outcome (social media enabled public value) is reached through a sequence of activities like social media enabled public engagement and social media enabled public service innovation (Newman & Robey, 1992).

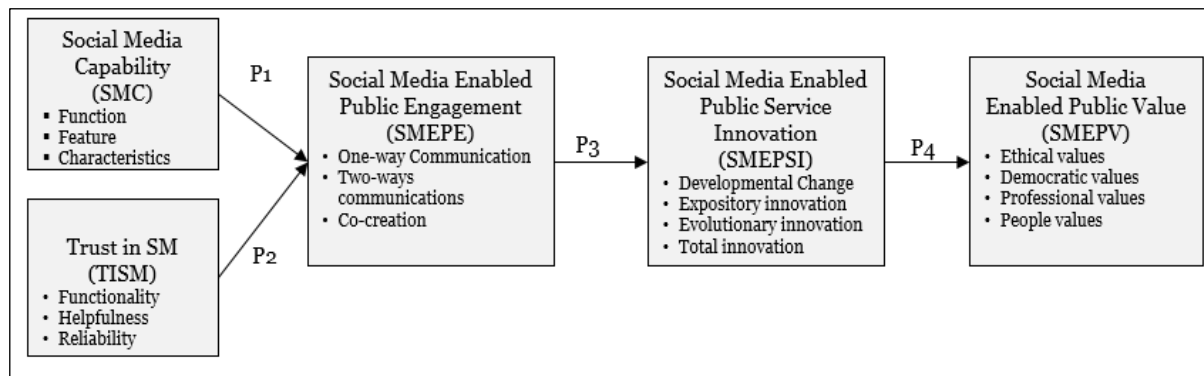

Figure 1: Conceptual Model

As represented, Figure 1 identifies the linkages between the constructs and the propositions that reflect these linkages. These linkages between constructs are discussed:

**Social media capability association to social media enabled public engagement:** The local government agencies’ proficiencies in sharing, co-creating, discussing and modifying user-generated content facilitates information sharing, interaction and connection with citizens (Linders, 2012), thereby improving citizen participation and interrelatedness. For example, citizens might engage in the council’s social media applications and want to stay informed about its activities and future launch of services (Oré & Sieber, 2011), or there could be collective intentions to deliver better and higher quality services. Moreover, providing a useful and easy way to access information through social media influences the public to interact with others and return to the organisations’ social media applications and websites (Kane, 2015; Malsbender, Hoffmann, & Becker, 2014). Social media capability is used to engage with citizens with the aim of developing service innovations. These capabilities (e.g. information sharing,

visibility and editability) can be successfully utilised to support public engagement at various levels. This directly leads us to the following proposition:

*P1: Social media capability is positively related to social media enabled public engagement.*

*Trust in social media associated to social media enabled public engagement:* The public's degree of trust of the government is a measure of the extent to which the government achieves its goals. The relationship between trust in social media applications and public engagement has also been reported in recent studies (Park, Choi, Kim, & Rho, 2015; Warren, Sulaiman, & Jaafar, 2014). Aladallah et al. (2016) argued that using social media applications encourages a feeling of belonging, boosts government legitimacy and increases trust in government and therefore more engagement is to occur. Likewise, Park et al. (2015) have reported a number of factors related to social media use affecting the level of confidence between government and citizens. Warren et al. (2014) noted that trust in using social media applications influences the public's propensity to engage with government officials. Similarly, concluded that the direct involvement of a government's leading officer is increased because the public's trust using social media applications. Therefore, the following proposition is derived:

*P2: Trust in social media applications is positively related to social media enabled public engagement.*

*Social media enabled public engagement associated to social media enabled public service innovation:* Public engagement between citizens and government officials in the development and subsequent implementation of innovations in public services is important in terms of the success of the public service innovation process (Merickova et al., 2016). This requires digital intermediate channels such as social media to produce innovation in public services. In general, ICT in the production of innovation in services for the public sector has received less attention in the broader IS literature. However, several authors have addressed the potential of social media for the innovation of public sector organisations (Criado et al., 2013). It is argued that the engagement between citizens and government officials in the process of public services delivery could bring innovative ideas (Linders, 2012). Mergel (2013) suggested that the innovation in public services is not limited to the use of social media applications, but compared with other ICT applications, public engagement is publicly observable. Therefore, the following proposition is derived:

*P3: Social media enabled public engagement is positively related to social media enabled public service innovation.*

*Social media enabled public service innovation associated to social media enabled public value:* Emerging alternative approaches to public service delivery and changing social expectations make social media use at the local level a prerequisite. Today, public service innovation constitutes a vital part of a countries' administrative reforms as governments question the traditional concept of public service delivery that often care about efficiency and effectiveness of the business processes). Therefore, alternative approaches have been introduced by facilitating innovation in public services and allowing citizens to be part of the process of designing, planning and implementing innovation (Brown & Osborne, 2012). Alongside this, the public value introduced by Moore (1995) could go hand in hand with innovation in public services. Citizens expect public institutions to not only provide public services in an efficient way but also in a participatory and accountable way. In fact, it is believed that the involvement of citizens through social media applications in every stage of public service design and delivery, as an innovative approach, can help improve public services through a better understanding of citizens' changing priorities and through the accumulation of citizens' information and ideas (Linders, 2012). In return, public value can be maximised. Therefore, the following proposition is derived:

*P4: Social media enabled public service innovation is positively related to social media enabled public value.*

## 4 Research Method

In the last decade, there has been a growth of interest in Critical Realism (CR) as an alternative to positivist and interpretive IS research (Volkoff & Strong, 2013). With no existing framework to explain the associations between the various constructs we have identified, our study represents a theory-building endeavour conducted from a critical realist ontological perspective. This study is intended to investigate how and why local governments use social media applications. This study can be described from IS evaluation research (Dwivedi, 2009). A critical realist IS evaluation research searches for mechanisms and conditions to explain why events happen, rather than predicting events, and aims to develop and test theories grounded in practice (Carlsson, 2003; Dobson, Myles, & Jackson, 2007). As an initial step in critical realism studies, our study focuses on possible causal mechanisms (trust in social

media, social media capability, public engagement, public service innovation) which could produce events (public value), rather than descriptions of empirical events themselves (Sayer, 2000).

Determination of the method to be applied in research is fundamental. A CR case technique is appropriate, especially in plainly bound, but composite, occurrences such as organisations, inter organisational relationships or nets of connected organisations (Fletcher, 2017; Tsang, 2014). In determining causality, the researcher may be required to go beyond or narrow the preliminary boundary, because it is clear that the causal mechanisms are more narrowly focused than previously thought. Yin (2017) asserts that questions about 'how' and 'why' are better answered through qualitative methods. In our study, we used a single case approach in capturing mechanisms (social media capability, trust in social media, public engagement and public service innovations that are interlinked to produce events 'public value'. The unit of analysis in this study would be a single local government agency that implemented at least one social media application for its services activities. Data was collected at a large municipality in Saudi Arabia. This municipality was chosen due to its high level of interaction with citizens using social media applications as well as it is one of the largest municipalities in Saudi Arabia. To gain a deeper understanding, semi-structured interviews were undertaken with five key government officials' informants (e.g. Deputy Mayor for regional areas, Deputy Mayor for IT, Public relation manager, Social media coordinator and Bridges construction manager). They have working experience with the council for over 10 years, on an average. The duration of the interviews was approximately 30 minutes. The interviews took place between December 2017 and January 2018.

Data coding analysis through deductive and retroductive reasoning is important in CR qualitative research. A coding scheme was developed based on the interview questions derived from literature. Coding scheme example in Appendix 1. Data coding analysis was done at two cycles following the approach of (Saldaña, 2016). In the First Cycle Coding, we use a primarily provisional coding. It begins by compiling a predetermined "start list of set codes prior to field work" (Miles & Huberman, 1994). These codes can be anticipated categories generated from literature reviews. Codes were created to label a chunk of a 'descriptive paragraph to group empirical data into themes and subthemes reflecting social media capability, trust in social media, public engagement, public service innovation and public value. After that, the Second Cycle Coding methods are performed; In this case, pattern-matching coding is applied. Codes and propositions were evaluated using pattern matching (Yin, 2017), which enabled us to identify an emergent theme, configuration, or explanation about relationships among constructs in our model. This is well suited for the implementation of retroductive reasoning to determine how and why contingent conditioning of causal mechanisms may or may not impact real events (Fletcher, 2017).

## 5 Empirical Findings and Discussion

In this paper, we are not providing evidence covering the influence of all dimensions involved in each construct, only one or two dimensions for each construct is presented. The extent of evidence varied from one dimension to another. For example, the dimension of one-way communication in SMEPE construct received high volume of comments, whereas the co-creation dimension received the least. All five constructs have been evaluated from key government officials' informants' perspectives. Each proposition is discussed below:

**Proposition 1:** Our findings show that there is a positive association between social media capability and public engagement. Information sharing capability can be achieved through the ability of the council to create hashtags on Twitter for engaging with citizens about events, awareness campaigns, and services. The public relations manager supported this view when he stated:

*"Hashtags were created, and many people made positive comments. Such hashtags [information sharing] help to increase engagement, awareness, and support law enforcement" (Code: P1-SMC-PE-P-GO-064-I1).*

The capability of social media (information sharing, for example) is used by municipality government officials to enhance citizen engagement. Hashtags are created on Twitter application. When a hashtag is created, it invites citizens to collaborate with government officials about certain issues, such as current and future services, events, and businesses. Such mass collaboration requires a high level of engagement where users are able to generate content. As such, social media applications have reshaped the nature of discussion by moving it from the real world to the virtual world. One advantage of information sharing capability through creating hashtags is that they help improve service quality. This is because municipality decision-makers can gauge citizens' collective thinking about the municipality's performance. Decision-makers can thereby transform what is being discussed on hashtags into action. Social media-generated data from hashtags, posts, and comments should be analysed using data mining techniques to better understand what users are looking for on various social media platforms (Bekmamedova & Shanks, 2014). Such techniques open up new venues for engagement between organisations and end users. According to Bekmamedova and Shanks (2014), to perform a customer



insight mining task, an organisation needs to allocate two important elements: skills and practices. Skills are embodied in individuals or teams who actively manage or accomplish organisational tasks. Practices serve as a means of accomplishing organisational tasks and as mechanisms for storing and accessing knowledge about the most effective ways to accomplish those tasks. Our results show that the municipality demonstrates little interest in using such techniques because all available data mining software does not support the Arabic language, which is used across the social media applications. Therefore, the second key element for conducting such an activity is missing. However, data monitoring can be done manually by identifying the most active and engaging social media accounts through which relevant issues can be tracked and documented. Data monitoring involves identifying, correcting, and evaluating operational deficiencies to identify opportunities for improvement (Linders, 2012). According to the social media coordinator:

*“Data analysis techniques are not so popular in the government sector. They...do not have the technical resources... [or] the expertise. Also, data analytics software for social media do not support [the] Arabic language, so we in the IT department have just three people responsible for social media data, so we monitor specific accounts to know what [is] exactly going around. These accounts usually are active in reporting problems” (Code: P1-SMC-PE-P- GO-0010-I2).*

Regarding the capability of social media functions, like information editability, the municipality officials spend a good deal of time and effort crafting and recrafting a communicative act before it is viewed by citizens. However, deleting or updating information after being posted on a public account may have negative effects on public engagement. According to the social media coordinator:

*“In Twitter, we cannot edit information after it is officially published, but we can still delete it and tweet again, but by the time to do that, people will take screenshots of it, and that will be really embarrassing.... People will think of us as...being less transparent where we should be more transparent, so we have to make sure that every tweet is revised and good to be published. In Facebook we can do that, but still the same concept [is] applied. We have to make sure that every post is okay to be seen by citizens” (Code: P1-SMC-PE-P- GO-001-I2).*

In line with our findings, Treem and Leonardi (2013) stated that the capability of editability is vital for broadcasting high quality information; however, this is only applicable before posting on social media public accounts.

**Proposition 2:** Trust in social media is not found to be an issue of concern for public engagement. In fact, government officials at the council did not express any trust issues related to social media technology, such as system crashes, loss of data, or insufficient support. This view was supported when the manager of bridge construction manager stated:

*“Social media has great echoes. Now, instead of writing a letter addressing his/her concern, all people can address their concern on social media....Now all government agencies [including councils] are using social media to communicate with citizens...so, in terms of trusting social media as technology, yes, they are trustworthy, and you would not see high authorities using them [social media applications] to engage with citizens” (P2-TISM-PE-P-GO-034-I5).*

Some social media applications are run by third parties. The difference between social media applications and enterprise applications, like ERP or Oracle, is the level of control that the end users have (Omar et al., 2013). On social media applications, users can customise their preferences, security, and privacy settings, to a certain extent, but they have no control over the application, whereas in enterprise systems, users have greater control. This is because social media applications are free and developed by third parties. Despite this, however, those third parties are trusted and supportive and users experience fewer technical and functional problems. This view is supported by the Deputy Mayor for IT when he stated:

*“I think people trust using social media functionalities. The evidence of that [is] the huge number of people using Twitter, Facebook, and WhatsApp. This is because we do not have to worry about the [se] application[s] like...other applications in [the] IT department. We are just end users and we never experience any major outage or anything like that” (P2-TISM-PE-P-GO-028-I6).*

Cultural conflicts may result in less trusting the technology. Srite (1999) asserted that new developed technologies in western culture are more likely to be less trusted and used in eastern cultures. This is due to the culture conflict resulting from trust issues. However, our result indicated an opposite result where social media developed in western cultures used heavily by Saudi citizens and Saudi government agencies as well.

**Proposition 3:** The degrees of different public service innovations require different levels of public engagement. Our finding highlights that, for developmental changes that occur over time, it may be suitable to use one-way communication for public engagement. For example, the social media coordinator mentioned that one-way communication is good for delivering messages to citizens in which a development may occur over time:

*“Social media is a means to share any kind of information about the council’s services, announcements, news, etc.” (Code: P3-PE-PSI-P-GO-065-I2).*

Services are already provided through other alternative channels of communication, such as telephone, email, and face-to-face meetings. The difference in public services innovation being delivered through social media compared to other channels is that government agencies are disseminating information about current services, which are open to the public discussion (Linders, 2012). Therefore, the social media capability of making comments and the information made available to the public affect the public value created through social media applications (Lee-Kelley & Kolsaker, 2004). However, due to the low level of engagement, which shows the reduced enthusiasm of citizens to seek more and better public services, the process of change takes longer (incremental change). Local government agencies can analyse the comments and replies of citizens to general information and news posted by government officials. Generally speaking, local government officials play a supervisory role regarding what is being said and commented on. This ideation process does not require a high level of interaction.

For expansionary innovation, local government has the willingness to provide high quality public services to citizens who have never received such services (Brown & Osborne, 2012). The expected level of engagement in this stage is high, and local governments should make efforts to advertise, engage, and attract citizens (Linders, 2012). New users who might live in rural areas may find it more difficult to communicate directly in real time with local government officials. Social media applications can thus help to convey their messages to appropriate public service providers (Criado et al., 2013). Nonetheless, changes made to public service provisions will take place over a relatively long period of time with minor improvements. This might be because citizens have high demands for public services to be delivered in short periods of time, local government service providers may not be making enough of an effort to meet the needs of citizens, or the government objective at this stage might be to concentrate on existing services, making significant improvements to them, and then distributing them to other users. According to the social media coordinator:

*“If we are looking for specific feedback about any issue, then yes, social media does help the council to do that” (Code: P3-PE-PSI-P-GO-041-I2).*

In the evolutionary innovation, the municipality has the willingness to provide high quality new public services that did not exist before. This could be initiated and led by local governments or initiated by citizens and led by governments. Senior government officials could raise initiatives to innovate new public services by receiving new ideas through social media applications, as such applications allow new ideas to spread among government officials and the public (Criado et al., 2013; Malsbender et al., 2014). The level of public engagement will be noticeably increased, and co-creation in the designing, planning, and policymaking stages of public services will take place. High quality public services delivered through the synergistic effect of government official–citizen collaboration in terms of time/cost savings and innovations is supported by the use of social media applications. Governments and the public can benefit from providing high quality new services. This is most noticeable in the level of engagement during projects/tasks, emergencies, and natural disasters. This view is supported by the public relation manager when he remarked:

*“Food truck for example. Yeah, it...started from a group discussion on WhatsApp among council’s staff, so they decided to do it and be the first council to do it. It was then promoted through Twitter and we made [a] campaign on how to get the licence” (Code: P3-PE-PSI-P-GO-055-I3).*

**Proposition 4:** Mark H Moore (2014) stated that public value consists of both “utilitarian” and “deontological” values. Utilitarian values are concerned with the good at individual and collective levels, and deontological values reflect what is right, fair, and just at individual and collective levels. For utilitarian values (people and democratic values), delivering public services to create value through social media has become an interest of local government agencies. Our results show that this is consistent with our argument in Proposition 4, where various types of public service innovations enabled public value creation. For example, the social media coordinator indicated that social values, such as fairness and caring, can be created through social media when citizens living in rural areas ask for the same services that are offered in urban areas (Merickova et al., 2016). According to the social media coordinator:

*“People now are sharing more information on social media about their society, so if someone saw a broken street or rubbish or anything, he/she will take a picture of it and report it to the council or even post it...to their personal account or other accounts interested in the city. Also, the impact of social media on these values, I guess, is greater than any other types of value. Social media helped the volunteer work... [and] people start[ed] offering help” (Code: P4-PSI-PV-P-GO-050-I2).*

Deontological values (ethics and professional) are more internal within the municipality, where the government official is seeking his/her interest over citizens’ interest (Cordella & Bonina, 2012). However, providing high quality services through improving professional and ethical values will reflect

on the services provided to the citizens themselves. This view is supported when the deputy mayor for regional service stated:

*“If there are any service requests from citizens, we raise this issue on WhatsApp groups, and we consider all comments made by all members, and we then take a decision and send our response to the associated council’s branches. If we do this through emails, it would have taken... [greater] time and effort.... We can take a picture of any memo to perform certain tasks and send it through to all associated departments to act upon immediately. Here is where the productivity and effectiveness are” (Code: P4-PSI-PV-P-GO-061-I4).*

Table 1 presents the outcome of each proposition evaluated in our model.

No	Proposition	Outcome
P1	Social media capability is positively related to social media enabled public engagement.	Supported
P2	Trust in social media applications is positively related to social media enabled public engagement.	Supported
P3	Social media enabled public engagement is positively related to social media enabled public service innovation.	Supported
P4	Social media enabled public service innovation is positively related to social media enabled public value.	Supported

Table 1: Propositions analysis outcomes

## 6 Limitations and Future Studies

Our study suffers from two main limitations. First, this study is cross sectional in nature. A longitudinal study is needed in order to develop a richer understanding of social media public value creation phenomena. However, due to time constraints, such an approach was not adopted. Second, it is difficult to generalise our findings across all city councils located in Saudi Arabia. For future studies, the findings of this research would be a good empirical foundation for conducting quantitative studies to improve generalisability. Third, contextualisation is very important for IS theory development (Davison & Martinsons, 2016). Any theory building models could profit when evaluated in a specific (cultural) context, however, our model has not directly investigated the cultural influences of the Saudi Arabian context and therefore further studies are needed to incorporate cultural influences.

Another round of empirical study involving multiple case study is currently in-progress. In that study, the viewpoint of multiple stakeholders including government officials and citizens representatives are considered.

## 7 Conclusion and Contribution

In this paper, we have reported an initial evaluation of a theory-driven model that links social media capability, trust in social media, public engagement, public service innovation and public value. Results from our pilot case study in a large municipality in Saudi Arabia provide support for the model. This initial validation of the model contributes to theory by enriching the IS and public administration literature and extending the applicability of theories applied in this study in a developing country. The model improved our understanding by creating a foundation for theory development in future social media research. The practical contribution of the evaluated model offers useful guidelines to those who are responsible for making decisions for formulating social media strategy officials at local government agencies. These guidelines identify those mechanisms and conditions that the officials should care about when social media is used in the councils. This in turn will facilitate obtaining the desired events from the use of social media within local government agencies. Our study also presents a methodological contribution to IS research; we have provided insights into the application of critical realism ontology and methodology for assessing public value creation through the use of social media applications.

## 8 References

- Aladalah, M., Cheung, Y., & Lee, V. C. (2016). *Delivering public value: Synergistic integration via Gov 2.0*. Paper presented at the System Sciences (HICSS), 2016 49th Hawaii International Conference on.

- Althaqafi, T., Rahim, M. M., & Foster, S. (2018). *Public value creation using social media applications for the local government context*. Paper presented at the Twenty-Sixth European Conference on Information Systems (ECIS2018), UK.Portssmouth.
- Andersen, L. B., Jørgensen, T. B., Kjeldsen, A. M., Pedersen, L. H., & Vrangbæk, K. (2012). Public value dimensions: Developing and testing a multi-dimensional classification. *International Journal of Public Administration*, 35(11), 715-728.
- Arnstein, S. R. (1969). A ladder of citizen participation. *Journal of the American Institute of planners*, 35(4), 216-224.
- Bekmamedova, N., & Shanks, G. (2014). *Social media analytics and business value: a theoretical framework and case study*. Paper presented at the 2014 47th Hawaii International Conference on System Sciences (HICSS).
- Braojos-Gomez, J., Benitez-Amado, J., & Llorens-Montes, F. J. (2015). How do small firms learn to develop a social media competence? *International Journal of Information Management*, 35(4), 443-458.
- Brown, K., & Osborne, S. P. (2012). *Managing change and innovation in public service organizations*: Routledge.
- Carlsson, S. A. (2003). Advancing information systems evaluation (research): a critical realist approach. *Electronic Journal of Information Systems Evaluation*, 6(2), 11-20.
- Cordella, A., & Bonina, C. M. (2012). A public value perspective for ICT enabled public sector reforms: A theoretical reflection. *Government Information Quarterly*, 29(4), 512-520.
- Criado, J. I., Sandoval-Almazan, R., & Gil-Garcia, J. R. (2013). Government innovation through social media. In: Elsevier.
- Davison, R. M., & Martinsons, M. G. (2016). Context is king! Considering particularism in research design and reporting. *Journal of Information Technology*, 31(3), 241-249.
- Dini, A. A., Wahid, F., & Sæbo, Ø. (2016). Affordances and constraints of social media use in eParticipation: perspectives from Indonesian politicians.
- Dobson, P., Myles, J., & Jackson, P. (2007). Making the case for critical realism: Examining the implementation of automated performance management systems. *Information Resources Management Journal*, 20(2), 138.
- Dwivedi, Y. K. (2009). *Handbook of research on contemporary theoretical models in information systems*: IGI Global.
- Fletcher, A. J. (2017). Applying critical realism in qualitative research: methodology meets method. *International Journal of Social Research Methodology*, 20(2), 181-194.
- Hong, H. (2013). Government websites and social media's influence on government-public relationships. *Public Relations Review*, 39(4), 346-356.
- Hood, C. (1991). A public management for all seasons? *Public administration*, 69(1), 3-19.
- Insight, G. M. (2018). Saudi Arabia Social Media Statistics 2018. Retrieved from <https://www.globalmediainsight.com/blog/saudi-arabia-social-media-statistics/>
- Johannessen, M. R., Sæbø, Ø., & Flak, L. S. (2016). Social media as public sphere: a stakeholder perspective. *Transforming Government: People, Process and Policy*, 10(2), 212-238.
- Jørgensen, T. B., & Bozeman, B. (2007). Public values: An inventory. *Administration & Society*, 39(3), 354-381.
- Kane, G. C. (2015). Enterprise social media: Current capabilities and future possibilities. *MIS Quarterly Executive*, 14(1).
- Kelly, G., Mulgan, G., & Muers, S. (2002). *Creating Public Value: An analytical framework for public service reform*. London: Strategy Unit, Cabinet Office.
- Kernaghan, K. (2003). Integrating values into public service: The values statement as centerpiece. *Public Administration Review*, 63(6), 711-719.
- Lee-Kelley, L., & Kolsaker, A. (2004). E-government: the "fit" between supply assumptions and usage drivers. *Electronic Government, an International Journal*, 1(2), 130-140.
- Linders, D. (2012). From e-government to we-government: Defining a typology for citizen coproduction in the age of social media. *Government Information Quarterly*, 29(4), 446-454.
- Malsbender, A., Hoffmann, S., & Becker, J. (2014). Aligning capabilities and social media affordances for open innovation in governments. *Australasian Journal of Information Systems*, 18(3).
- Mcknight, D. H., Carter, M., Thatcher, J. B., & Clay, P. F. (2011). Trust in a specific technology: An investigation of its components and measures. *ACM Transactions on Management Information Systems (TMIS)*, 2(2), 12.
- Men, L. R., & Tsai, W.-H. S. (2012). How companies cultivate relationships with publics on social network sites: Evidence from China and the United States. *Public Relations Review*, 38(5), 723-730.

- Mergel, I. (2013). A framework for interpreting social media interactions in the public sector. *Government Information Quarterly*, 30(4), 327-334.
- Merickova, B. M., Svidronova, M. M., & Nemecek, J. (2016). Innovation in Public Service Delivery: Civic Participation in Slovakia. *Africa's Public Service Delivery and Performance Review*, 4(2).
- Miles, M. B., & Huberman, A. M. (1994). *Qualitative data analysis: An expanded sourcebook*: sage.
- Moore, M. H. (1995). *Creating public value: Strategic management in government*: Harvard university press.
- Moore, M. H. (2014). Public value accounting: Establishing the philosophical basis. *Public Administration Review*, 74(4), 465-477.
- Mulgan, G., & Albury, D. (2003). Innovation in the public sector. *Strategy Unit, Cabinet Office*, 1, 40.
- Nabatchi, T., & Amsler, L. B. (2014). Direct public engagement in local government. *The American Review of Public Administration*, 44(4\_suppl), 63S-88S.
- Newman, M., & Robey, D. (1992). A social process model of user-analyst relationships. *MIS quarterly*, 249-266.
- OECD. (2005). Guidelines for collecting and interpreting innovation data, Oslo Manual. In: Organisation for Economic Co-operation and Development Paris.
- Omar, K., Scheepers, H., & Stockdale, R. (2013). *The use of social media in government 2.0 assessed through the public value lens*. Paper presented at the 24th Australasian Conference on Information Systems (ACIS).
- Oré, C., & Sieber, S. (2011). Facebook and the World of Social Networks. *IIESE Business School Case Study*.
- Park, M. J., Choi, H., Kim, S. K., & Rho, J. J. (2015). Trust in government's social media service and citizen's patronage behavior. *Telematics and Informatics*, 32(4), 629-641.
- Rauniar, R., Rawski, G., Yang, J., & Johnson, B. (2014). Technology acceptance model (TAM) and social media usage: an empirical study on Facebook. *Journal of Enterprise Information Management*, 27(1), 6-30.
- Saldaña, J. a. (2016). *The coding manual for qualitative researchers* (3E [Third edition]. ed.): Los Angeles, Calif. London SAGE.
- SaudiVision. (2017). Saudi Vision 2030. Retrieved from <http://vision2030.gov.sa/en>
- Sayer, R. A. (2000). *Realism and social science*. London Thousand Oaks, Calif.: London Thousand Oaks, Calif. : Sage.
- Srite, M. (1999). The influence of national culture on the acceptance and use of information technologies: An empirical study. *AMCIS 1999 Proceedings*, 355.
- Tams, S., Thatcher, J. B., & Craig, K. (2018). How and why trust matters in post-adoptive usage: The mediating roles of internal and external self-efficacy. *The Journal of Strategic Information Systems*, 27(2), 170-190.
- Treem, J. W., & Leonardi, P. M. (2013). Social media use in organizations: Exploring the affordances of visibility, editability, persistence, and association. *Annals of the International Communication Association*, 36(1), 143-189.
- Tsang, E. W. (2014). Case studies and generalization in information systems research: A critical realist perspective. *The Journal of Strategic Information Systems*, 23(2), 174-186.
- Volkoff, O., & Strong, D. M. (2013). Critical Realism and Affordances: Theorizing IT-associated Organizational Change Processes. *MIS quarterly*, 37(3).
- Warren, A. M., Sulaiman, A., & Jaafar, N. I. (2014). Social media effects on fostering online civic engagement and building citizen trust and trust in institutions. *Government Information Quarterly*, 31(2), 291-301.
- Webster, J., & Watson, R. T. (2002). Analyzing the past to prepare for the future: Writing a literature review. *MIS quarterly*, xiii-xxiii.
- Yin, R. K. (2017). *Case study research and applications: Design and methods*: Sage publications.

## Appendix 1

Please Note: Please note:

P\*= Positive, NU\*= Neutrality, N\* =Negative, GO\* = Government official, Cxx = Comment number, Ixx = Interviewee number, P1= Proposition 1, P2= Proposition 2, P3= Proposition 3, P4= Proposition 4, SMC-PE= Association between social media capability and public engagement, TISM-PE= Association between trust in social media and public engagement, PE-PSI= Association between public engagement and public service innovation., PSI-PV= Association between public service innovation and public value.

Relationship	P*	NU*	N*	GO*	Code Number
P1- SMC-PE	P			GO	(P1-SMC-PE-P-GO-Cxx-Ixx)
		NU		GO	(P1-SMC-PE-NU-GO-Cxx-Ixx)
			N	GO	(P1-SMC-PE-N-GO-Cxx-Ixx)
P2-TINSM-PE	P			GO	(P2-TINSM-PE-P-GO-Cxx-Ixx)
		NU		GO	(P2-TINSM-PE-NU-GO-Cxx-Ixx)
			N	GO	(P2-TINSM-PE-N-GO-Cxx-Ixx)
P3-PE-PSI	P			GO	(P3-PE-PSI-P-GO-Cxx-Ixx)
		NU		GO	(P3-PE-PSI-NU-GO-Cxx-Ixx)
			N	GO	(P3-PE-PSI-N-GO-Cxx-Ixx)
P4-PSI-PV	P			GO	(P5-KSP-PV-P-CR-Cxx-Ixx)
		NU		GO	(P5-KSP-PV-NU-CR-Cxx-Ixx)
			N	GO	(P5-KSP-PV-N-GO-Cxx-Ixx)

**Copyright:** © 2018 authors. This is an open-access article distributed under the terms of the [Creative Commons Attribution-NonCommercial 3.0 Australia License](#), which permits non-commercial use, distribution, and reproduction in any medium, provided the original author and ACIS are credited.

# The Impact of User Behaviours on the Socialisation Process in Enterprise Social Networks

## Joschka Hüllmann

Department of Information Systems  
University of Münster  
Münster, Germany  
Email: joschka.huellmann@uni-muenster.de

## Tobias Kroll

Department of Computer Science and Applied Cognitive Science  
University of Duisburg-Essen  
Duisburg, Germany  
Email: tobias.kroll@uni-due.de

## Abstract

The success of teams in enterprise social networks (ESN) is of high importance in today's project-based and digitised work environments. In this context, onboarding of new hires or allocated team members means the adoption of group characteristics and behaviours. Studies identified cohesion and trust as part of the socialisation process and found communication behaviours that facilitate socialisation. ESN not only enable efficient communication or relationship building, they also make the socialisation processes visible and analysable. In this paper, we propose to use metrics from social network analysis (e.g. extraversion, openness and proactiveness) to operationalise communication behaviours identified as positive for socialisation. First evaluations with two ESN data sets in OLS, beta regression and multilevel models sparsely support the influence on closeness, which we expect to reflect the level of group integration.

**Keywords** Socialisation, Enterprise social networks, User behaviours

## 1 Introduction

In the contemporary workplace, the formation of successful teams is a crucial challenge for management, as people increasingly change jobs and the rapid composition of dynamic project-based teams becomes the norm (Powell et al. 2004). Part of the challenge is the process of integrating new hires into existing teams, called socialisation or onboarding. Understanding and improving the outcomes of this process is an ongoing issue in practice and research alike (Bauer and Erdogan 2011). An effective onboarding process can increase the likeliness of new employees staying, whereas a poor process leads to a high fluctuation rate and losses for the organisation (Willyerd 2012).

Organisations employ different means of supporting the socialisation process, with enterprise social networks (ESN) being one of them (Gonzalez et al. 2013). ESN do not only provide a platform to support the process, but also make it visible: With increasing prevalence of ESN in organisations, a lot of communication data is generated, which has been used to analyse social relationships, social capital and to identify user behaviours in social networks (Stieglitz, Meske, et al. 2018; Wehner et al. 2017). Companies like Google have tried to identify patterns that distinguish effective from ineffective teams without success, but noticed the influence of individual and group behaviour may be relevant (Duhigg 2016). Bauer and Erdogan (2011) found behaviours of employees as antecedents among others that influence the socialisation process. Research on how the online user behaviours in ESN may elucidate the socialisation process is lacking. Thus, we address the research question *“How do individual user behaviours of new hires in ESN communication affect their integration into different social groups?”* in this paper. The study contributes a significant step to providing actionable insights for management that supports the crucial challenge of effective team formation by the means of social network analysis and prediction of how well new hires’ behaviours fit to their team.

Our contribution builds on top of previous ESN literature. First, we study the literature on socialisation, ESN and user behaviours, with the aim to map the ESN user behaviours to the socialisations process’ antecedents. From a review of 44 network metrics, we build hypotheses about their effect on successful socialisation outcomes. Regression analyses support only some assumptions about the effect, and require more data and in-depth analyses in the future. However, we understand this paper as an innovative approach and basis for further studies on the user behaviours in ESN. So far, this paper presents the underlying idea of the user behaviour’s influence on socialisation from a quantitative social network analysis perspective.

## 2 Background

### 2.1 Teams and Socialisation

Teams are an important unit of organisations and nowadays organisations are quickly forming teams to respond to changes in the environment and to stay competitive (Bergiel et al. 2008; Duhigg 2016). To support teams, technology is essential as it enables communication and collaboration (Bergiel et al. 2008; Powell et al. 2004). Prerequisites of successful team communication and collaboration include the need to build shared norms and form a cohesive team (Maznevski and Chudoba 2000). During the formation of teams, early communication is a necessity to foster interpersonal relationships and to establish team cohesion (Maznevski and Chudoba 2000). When new hires join an existing team, their level of integration into the team is an outcome of the socialisation process (Powell et al. 2004). During the socialisation process, new hires must understand and adopt the behaviours of their team (Leidner et al. 2010). However, not every person fits in every team, hindering the socialisation process or making it impossible (Bergiel et al. 2008).

Organisational socialisation, or onboarding, is the process, in which new hires learn the knowledge, skills and behaviours of the organisation to fill their roles and responsibilities (Bauer and Erdogan 2011; Gonzalez et al. 2013; Saks and Ashforth 1997). A successful socialisation process leads to satisfied and productive employees, while poor socialisation leads to early departure or ineffectiveness of the new hires (Bauer and Erdogan 2011). However, reaching a successful socialisation process and respective outcomes is challenging (Gonzalez et al. 2013). Organisations employ programs, ideas, and other means to help this process, enterprise social network platforms being one of them (Gonzalez et al. 2013).

For the analysis of the socialisation process, Saks and Ashforth (1997) propose a multilevel process model, which has been well received and picked up by Bauer and Erdogan (2011) and Gonzalez et al. (2013). Part of this multilevel process model are the antecedents, which adjust the process and lead to different socialisation outcomes (Saks and Ashforth 1997). Bauer and Erdogan (2011) describe *characteristics* and *behaviours* of new employees as two of these antecedents. The characteristics of new



hires that influence the process are a proactive personality, extraversion and openness. A proactive personality takes charge, asks questions, and controls the environment, both of which result in quick learning of the shared norms of the team and describe an information-seeking behaviour (Major et al. 2016; Bauer and Erdogan 2011). According to Kammeyer-Mueller and Wanberg (2003), people, who are open to new experiences and interpret them as opportunities rather than threats, learn from uncertain situations and appreciate feedback, which is linked to positive socialisation outcomes and feedback-seeking behaviour. Likewise, extraverts enjoy to get to know and socialise with their new colleagues, improving the integration early on by their relationship-building behaviour (Bauer and Erdogan 2011). The outcomes of the socialisation model by Saks and Ashforth (1997) are role conformity on the individual level and strong cohesion on the group level, leading to a stable membership, higher effectiveness and a strong group culture. Especially the group outcomes have also been researched and identified as outcomes of continuous enterprise social network use (Riemer, Finke, et al. 2015), making enterprise social networks a phenomenon linked to the socialisation process and a suitable media to further investigate the socialisation process in modern teams, which make extensive use of such tools (Chui et al. 2012).

## 2.2 Enterprise Social Networks to Support Socialisation

Enterprise social networks (ESN) have been described as a consumerised social network platform deployed within organisational boundaries, offering a previously separated set of communication tools (Ellison et al. 2015). ESN platforms facilitate social processes and activities (Berger et al. 2014). They support collaboration, communication, knowledge sharing and connect people (Riemer, Stieglitz, et al. 2015). Users seek information, find experts, solve problems together, share opinions or discuss work and ideas (Berger et al. 2014; Mäntymäki and Riemer 2016; Richter and Riemer 2013). They further enhance innovation (Kuegler et al. 2015) and productivity (Aboelmaged 2018). Research found that ESN create social capital (Riemer, Finke, et al. 2015), which is described to influence mutual trust, shared norms and values, as well as cohesion (Nahapiet and Ghoshal 1998). It is also associated with a shared culture, language, increased knowledge and effectiveness (Oh et al. 2004).

Gonzalez et al. (2013) try to understand how exactly enterprise social networks support the socialisation process. They analyse how enterprise social media use and patterns of interactions are associated with the outcomes of the socialisation process. They found that ESN usage affects the social acceptance and group-integration of new hires and can speed up the socialisation process. Furthermore, new hires strengthen their social connections with ESN usage and feel connected to others (Leidner et al. 2010), which leads to higher levels of trust (Leon et al. 2017).

ESN are a duality in that they not only mediate socialisation processes, but also make them visible. We can use ESN data to understand the socialisation process in the organisation and how new hires build their relationships. Since the integration of new hires or new project members into teams is challenging (Gonzalez et al. 2013), we explore the use of network data to inform staffing decisions.

## 2.3 User Behaviours

People differ in their communication behaviour, which is characteristic for different types of users (Cetto et al. 2018; Stieglitz, Mirbabaie, et al. 2018). Distinct behaviours can be found in public social networks and enterprise social networks (Leon et al. 2017). Previous research has identified user behaviours with the aim of understanding the user composition of healthy (Angeletou et al. 2011) or effective social networks (Berger et al. 2014). For the identification of user behaviours, there is (1) a qualitative approach with interviews or content analyses, and (2) a quantitative approach by means of cluster or factor analysis of enterprise social network structure.

Following the latter, user behaviours are inferred from a user's distinct position, structural properties and from his activity patterns and contribution frequencies in the network (Angeletou et al. 2011; Gleave et al. 2009), to describe their distinct kinds of meta-communication (Hacker et al. 2017; Smith et al. 2009). We link the user behaviour metrics from ESN analysis to the user behaviours in the socialisation model, mentioned by Bauer and Erdogan (2011) and Saks and Ashforth (1997), to analyse how user behaviours, which can be inferred from ESN data, affect the socialisation process and the team integration. Besides using main contributions of the ESN community at recent IS conferences, we searched SCOPUS and Web of Science with the terms “user (behavio(u)r | role | dimension | metric | measure)”, followed by one round of forward and backward search to identify 44 different user behaviours in the literature. We map the identified ESN user behaviours to the three behaviours and three related personality traits of Bauer and Erdogan (2011) based on the authors' descriptions (Table 1). The descriptions and calculation schemas are similar in the literature and overlap between different studies. Because Smith et al. (2009) provide early calculation schemas, we use them as the base and



**Proactiveness** describes the number of conversations a user has started, compared to his overall number of posts. According to Hacker et al. (2017), Hansen et al. (2010) and Smith et al. (2009), a high number of initiated threads indicates an information-seeking person or a conversation starter. This behaviour is associated to successful socialisation outcomes, because it can lead to faster learning of the new hire (Bauer and Erdogan 2011). **Openness** describes how many posts a user contributes in each conversation on average. A high value indicates an engager, who aims at focused reciprocal interactions (Angeletou et al. 2011; Trier and Richter 2015). Since such interactions strengthen social relationships, they lead to increased social integration. **Information-seeking** describes how many replies a user has received from others in response to his information requests, which indicates how accepted the user is by other team members and how much information he may receive (Gonzalez et al. 2013), which contributes to his learning. **Extraversion** describes how many replies a user has written to others. A high value indicates a user, who engages broadly across the network (Holtzblatt et al. 2013). This behaviour is associated to successful socialisation outcomes, as the user gets to know a other people (Bauer and Erdogan 2011). **Feedback-seeking** describes how many likes and mentions a used receives per post, which shows the feedback a user receives from the contributions to the network (Angeletou et al. 2011; Smith et al. 2009), which indicates his learning behaviour and positively influences his socialisation. **Relationship-building** describes how well a user relates to other people in the network via his neighbours. A high value indicates that the user is part of a cohesive team (Bergiel et al. 2008; Riemer, Finke, et al. 2015), which has a positive influence on socialisation outcomes as it improves the social integration. **Activity** quantifies the regular activity of a user. As maintaining social relationships is essential for successful teams (Kammeyer-Mueller and Wanberg 2003), activity is crucial for successful integration.

We focus on the strong cohesion outcome of the socialisation model (Saks and Ashforth 1997) and operationalise group integration as the average closeness of the user to the other members of the team. It captures the relationships the user formed with other team members and how the user is embedded into the team structure.

### 3.1 Data Collection

To determine how user behaviours influence the socialisation process in ESN, we had access to two data sets on the meta-communication of two financial institutes (4,500 and 32,500 employees) based in Australia, both running an ESN platform. The data sets contain all interactions ever made on the platforms, with each interaction being either a post, reply, like or mention. For each interaction the author, the recipient, the thread, the group (team in formal hierarchy) and the time is stored. All data sets span the period from 2010 until the end of 2016 and vary in size. The first one covers 168,706 interactions from 4,125 accounts and the second one covers 233,444 interactions from 12,017 accounts. A small excerpt of the data is shown in Table 3. From the data, a social network graph is constructed, so that each interaction represents an edge from the author to the recipient – author and recipient being represented by vertices. For each user we calculate the user behaviour metrics using the network graph. Based on the metrics, we fit an OLS regression, a beta regression model and a mixed model to identify what effects the user behaviours have on the socialisation outcomes.

To not distort the analysis results, we cleanse the data set from inactive users and groups. Users and groups with less than 50 interactions per year, roughly 1 per week, are excluded from the analysis. Three (potentially technical) users with very high number of interactions are removed, groups are filtered to have a minimum size of five members and each member must be part of the group for at least three days.

id	source	target	groupid	threadid	datetime	class
124	1775662	1810074	78023	51876215	2010-07-04 09:22:24	Reply
125	1775662	1858829	78023	52045895	2010-07-09 11:25:53	Like
126	1775662	1858829	78023	52349096	2010-07-06 00:49:56	Reply

Table 3. Excerpt of Data Set.

We cross all users and groups and split the network into two subnetworks for each pair. The first subnetwork describes the user's position and focal structure outside of the group, while the second subnetwork describes the user's position and the structure within the group. As the user behaviour is inherent to the user, we calculate the behaviour metrics (independent variables) from the user's interactions and position over the whole network, excluding the paired group. The level of integration (dependent variable) is determined for each pair of user and group, using the within structure of the paired group to measure the integration. The overall structure describes the behaviour inherent to the

user on average, while the within structure describes the user’s particular behaviour and integration in the paired group. The R code of the pre-processing and analysis is available for replication.

### 3.2 Regression Analysis

To identify how the behaviour metrics affect the group integration, we perform a linear regression analysis. From the spearman correlation matrix of the variables (c.f. Table 4), we determine a high correlation between the closeness and the size of a group, as the social network gets sparser with increasing size, as well as between extraversion and activity. As a result, and similar to other studies (e.g. Oh et al. 2004), we control for the size of the group in the regression. Since the number of days a user is a member of a group influences his ability to interact with others and integrate, we add this metric as the second control variable.

Set 1	INT	PRO	OPE	INF	EXT	REL	ACT	FEE	GRO
PRO	0.06***								
OPE	0.02	-0.17***							
INF	-0.01	-0.22***	0.27***						
EXT	-0.06***	-0.11***	0.23***	0.56***					
REL	-0.14***	-0.17***	-0.06***	0.01	0.06***				
ACT	-0.02	0.10***	-0.03**	0.33***	0.64***	-0.04**			
FEE	0.01	0.23***	0.10***	0.35***	0.01	-0.07***	0.05***		
GRO	-0.98***	-0.08***	-0.01	0.02	0.06***	0.14***	0.01	-0.01	
DAY	-0.09***	-0.06***	-0.02	0.07***	0.04	-0.02	-0.06***	-0.01	0.13***
Set 2	INT	PRO	OPE	INF	EXT	REL	ACT	FEE	GRO
PRO	-0.07***								
OPE	-0.06***	0.05**							
INF	-0.05***	-0.25***	0.24***						
EXT	-0.07***	-0.10***	0.03*	0.62***					
REL	-0.1***	-0.24***	-0.04**	0.16***	0.26***				
ACT	0.03	0.01	-0.16***	0.15***	0.39***	-0.01			
FEE	-0.14***	0.43***	0.32***	0.36***	0.05***	-0.06***	-0.14***		
GRO	-0.97***	0.09***	0.07***	0.04**	0.05***	0.07***	-0.04**	0.17***	
DAY	-0.16***	0.01	-0.07***	0.07***	0.08***	-0.02	-0.06***	0.01	0.21***

Note: \*p<0.1; \*\*p<0.05; \*\*\*p<0.01

Table 4. Correlation matrix for both data sets (abbreviations are first three letters of variables).

As social networks tend to be sparse – in particular bigger networks – the distribution of the closeness variable is highly skewed. Most people have a very low closeness value, while there are only a few with a high value (c.f. Table 5). To reduce the skewness, we take the log-transformation for the closeness variable. We have also tested square and square-root transformation, both of which led to consistent results. Even after the log-transformation, the distribution of closeness is skewed. To deal with the skewness, we compare the results of the OLS regression with the results of beta regression (Ferrari and Cribari-Neto 2004), which is suitable for modelling rates and proportions and does not require residuals to be normal distributed, but beta distributed instead. To consider group heterogeneous effects, we also compare the results with a mixed model, computing random intercepts per group. The calculations were performed with lme4 v1.1.17 (Bates et al. 2015) and betareg v3.1.0 (Cribari-Neto and Zeileis 2009).

## 4 Results

After filtering the data, 4,696 observations of user/group pairs (data set 1), or 3,121 observations (data set 2) respectively, are used to fit the model (c.f. Table 5). The signs of the coefficients are consistent, except for the variables connectedness, size and days (c.f. Table 6). For connectedness, the OLS regression of data set 1 shows a positive value, compared to the other three results. For size and days, the beta regression shows the opposite sign. The differences are tolerable due to their small effect. We find varying significance levels in both datasets with the beta regression results supporting the respective OLS regression results, albeit showing higher p-values. Counterintuitively, outgoingness and connectedness are negatively associated with the group integration. Receiving likes and mentions does not lead to a positive effect on the group integration. The results on initiation and verbosity are non-

conclusive. While the OLS regression on data set 1 shows a significant positive effect, the result is not substantiated by the other results. The group size significantly affects the integration into the group. As the values are not significant, no statement can be made about the activity or the number of days a user is a member of the group.

Statistic	Data set 1					Data set 2				
	N	Mean	St. Dev.	Min	Max	N	Mean	St. Dev.	Min	Max
INT	4,696	0.002	0.010	0	0.150	3,121	0.003	0.010	0	0.145
PRO	4,703	0.690	0.177	0.042	1000	3,177	0.770	0.160	0.184	1000
OPE	4,703	0.357	0.128	0.015	0.941	3,177	0.335	0.152	0.000	0.904
INF	4,703	47663	32505	0	229	3,177	64998	44892	3	291
EXT	4,703	61145	32380	1	188	3,177	71977	38846	1	215
REL	4,702	116887	14172	7000	166312	3,177	150996	20921	59750	253333
ACT	4,703	0.130	0.084	0.014	0.909	3,177	0.099	0.087	0.005	2000
FEE	4,703	1013	0.854	0	10667	3,177	2300	1593	0.008	14071
DAY	4,696	213557	178561	3	1,49	3,121	256648	289778	3	1,917
GRO	4,696	234898	204466	6	766	3,121	239576	209458	7	818

Table 5. Descriptive Statistics.

## 4.1 Robustness

Since both the independent and the dependent metrics are calculated from the same data source, the simultaneity bias is relevant. We account for this by partitioning the data as described before, so that the behaviour metrics are calculated over the whole data set, while the integration metrics are calculated from the subnetworks of each group. To test for the simultaneity-bias, we checked the Spearman correlations, which are in the norm. Only the control variables are correlated with the independent variable, but not the independent variables ( $\rho < 0.15$ ). We conducted the Durbin-Watson test, which showed no autocorrelation ( $d=2$ ,  $p < 0.05$ ) and checked for multicollinearity in the dependent variables using condition indices ( $< 0.2$ ) and variance inflation factors ( $< 2$ , except outgoing). The residuals are approximately normal distributed, except for a minor right tail due to the skewed distribution of the closeness values. The Breusch-Pagan showed heteroscedasticity ( $p < 0.01$ ), although it is quite unreliable for not perfectly normal residuals. Therefore, we calculated heteroscedastic robust standard errors, which lead to consistent results. To test the result, we used the beta regression model, which does not assume normality in the residuals. The signs of the coefficients are unchanged. However, the significance in the beta regression results is lower than in the OLS model. We ran both analyses on two different data sets of different size from different organisations, both of which showed similar results. While the results are moderately robust between OLS and beta regression, considering group heterogeneous effects changes the result, indicating that the effects, as measured with the behaviour metrics, may not be simply linear as hypothesised; testing random slopes did not improve the results. Lacking better data on group level and media level, as well as only having meta-communication data and no information on what actual text and content the interactions convey, leads to improvable robustness of the statistical model. Interpretation of how the ESN user behaviours from the literature measure the antecedents of Bauer and Erdogan (2011) and predict the socialisation outcomes should be very cautious. Nevertheless, this check of viability, to work only with meta-information, is one of this study's goals and contributions to our discipline.

## 5 Discussion

Our results are preliminary as we plan to dive deeper into the relationship between user behaviours and group types, i.e. we want to include data on the groups in our analysis, because user behaviours apparently have different effects depending on the group a user is assigned to. Nevertheless, these results provide first insights, if and how ESN user behaviours can be used to determine the socialisation outcomes of new hires.

**Extraversion** is – in contrast to our hypothesis – negatively associated with socialisation outcomes in our models. Holtzblatt et al. (2013) describe an extravert user as active in many groups, who enjoys a broad network of social relationships. However, they state that social relationships are not strengthened which may explain the opposite association. Others argue that such users contribute new knowledge and respond to many others (Cetto et al. 2018; Viégas and Smith 2004). For the group integration, cohesion

and building trust via maintenance of strong relationships are important (Kammeyer-Mueller and Wanberg 2003; Saks and Ashforth 1997), which is not supported by broad (extraverted) communication, but rather focused communication.

	Data set 1			Data set 2		
	<i>OLS</i>	<i>beta</i>	<i>mixed-effects</i>	<i>OLS</i>	<i>beta</i>	<i>mixed-effects</i>
Proactiveness	0.133 (0.107)	0.127 (0.089)	-0.008 (0.011)	0.045 (0.190)	0.007 (0.139)	0.025** (0.013)
Openness	0.720*** (0.143)	0.231* (0.120)	0.035** (0.014)	0.229 (0.171)	0.016 (0.125)	0.011 (0.011)
Information-seeking	0.003*** (0.001)	0.048** (0.024)	-0.0003*** (0.0001)	0.001 (0.001)	0.050 (0.038)	-0.0001 (0.0001)
Extraversion	-0.003*** (0.001)	-0.092** (0.038)	0.0002*** (0.0001)	-0.004*** (0.001)	-0.120*** (0.044)	0.0001 (0.0001)
Relationship-building	0.001 (0.001)	-0.001 (0.001)	0.0002 (0.0001)	-0.005*** (0.001)	-0.002*** (0.001)	0.0001 (0.0001)
Activity	-0.056 (0.264)	0.029 (0.207)	0.044* (0.027)	-0.224 (0.315)	0.111 (0.228)	0.018 (0.020)
Feedback-seeking	-0.045* (0.023)	-0.024 (0.019)	0.003 (0.002)	-0.067*** (0.021)	-0.041*** (0.015)	-0.001 (0.001)
Group size	-0.009*** (0.0001)		-0.016*** (0.001)	-0.008*** (0.0001)		-0.015*** (0.001)
Days	-0.0003*** (0.0001)		0.0001*** (0.00001)	-0.00004 (0.0001)		0.00001** (0.00001)
Constant	-6.938*** (0.193)	-5.627*** (0.184)	-5.323*** (0.092)	-5.693*** (0.254)	-4.995*** (0.220)	-5.384*** (0.117)
Observations	4,696	4,686	4,696	3,121	3,121	3,121
R <sup>2</sup> / R <sup>2</sup> marginal	0.734	0.020	0.84	0.649	0.041	0.84
Adjusted R <sup>2</sup>	0.734			0.648		
Log Likelihood		29,66	2,348		19,44	2,497.491
Residual Std. Error	1.175 (df = 4686)			1.326 (df = 3111)		
F Statistic	1,437*** (df=9;4686)			638*** (df=9; 111)		

(Values are unstandardised coefficients; standard errors are in parentheses; \* $p < 0.1$ ; \*\* $p < 0.05$ ; \*\*\* $p < 0.01$ )

Table 6. Regression Results.

The latter is captured by the **openness** metric. Open users keep the community alive, and engage in prolonged discussions, i.e. they contribute extensively to each thread (Cetto et al. 2018). They are of central importance to the community and their continuous engagement focuses on small groups, where they facilitate reciprocal interactions. This continuity of reciprocity leads to the formation of strong relationships, which are essential for social acceptance into the group (Bauer and Erdogan 2011; Saks and Ashforth 1997). In data set 1, we see a rather strong significant effect of openness, which, though, does not repeat in data set 2. **Proactive users** are the origin of such extended discussions (Angeletou et al. 2011; Hacker et al. 2017; Viégas and Smith 2004). By facilitating new conversations and asking questions, they get to know the roles and responsibilities of the new hire's position (Major et al. 2006) and learn the expected behaviours (Bauer and Erdogan 2011). Their proactive "question asking" is positive for the socialisation outcomes (Bauer and Erdogan 2011). However, proactiveness does not show a significant effect on the socialisation in our analysis. We find no association between **activity** and successful socialisation outcomes either. A reason can be that users with low activity have a low number of posts, which makes data scarce and the analysis difficult.

Similar to extraversion, **relationship-building** is negatively associated with the socialisation outcomes, which seems counterintuitive at first. While a high value indicates users, who are broadly connected over the whole network, for social integration, a focus on small groups and intense relationships is beneficial to build cohesion. Well-connected users are characterized as "key value adding users" (Berger et al. 2014) or very influential (Smith et al. 2009). However, for integration into a social group, this may be hindering, as such a person still needs to adapt to the social norms and shared behaviours to fit his new role (Leidner et al. 2010). Contrary to our hypothesis, **feedback-seeking** is negatively associated with the socialisation outcome in our models. We operationalise feedback-seeking as likes and mentions received. Because a like is not sufficient to form reciprocal relationships, it is important that a user receives written feedback. In contrast to likes, written replies are engaging with the content and would better form the basis for reciprocal interactions, leading to cohesion, trust and

successful socialisation outcomes (Maznevski and Chudoba 2000). **Information-seeking** corresponds to the above-mentioned situation and measures the written replies a user received. Like argued, reciprocal interactions are the basis for formation of social relationships, leading to trust and cohesion in teams (Maznevski and Chudoba 2000). The results for data set 1 show that **information-seeking** is positively associated with successful socialisation outcomes.

Our model does not support the effect of the number of days a user is member in a group. A longitudinal study, which takes into account the dynamics of social interactions, may elucidate this factor in more detail. The group size has a significant negative effect on the social integration of a user. As a group gets bigger, it gets more difficult to foster relationships and be close with everyone in the group.

The differences between the two data sets are not easily explainable. We intended to compare the two data sets and find significant effects that recur. For extraversion, feedback-seeking, and group size, the results are consistent and significant. Other metrics are significant either for data set 1 or data set 2. Besides potential weaknesses in the operationalisation or data biases, the organizations may have different ESN usage policies or work cultures in place, which encourages or hinders certain behaviours. More data about the organizations and the related data sets would definitely allow further in-depth analyses. However, with our approach we originally find first results just from a snapshot of meta-communication data.

## 6 Conclusion

We selected user behaviours from the literature and performed various regression analyses to determine the effects of behaviour metrics on the integration of users into groups in enterprise social networks.

Utilising meta-communication data exclusively enables analyses where content data is unavailable, but provides only a limited lens for the analysis of complex socialisation processes. Several authors mention that a pure social network analysis is insufficient, because it misses the context (Rowe et al. 2013) and the organisational factors (Kuegler et al. 2015), which influence the outcomes of the socialisation process. Operationalisation of social factors is challenging and a different operationalisation may change the results of our analysis. Future research can benefit from a mixed-method approach, combining the social network analysis with qualitative insights, to validate the findings and provide a deeper understanding. Another prospect to validate the findings would be to gather more data on the users' personality traits and compare the results with the user behaviours.

The socialisation process depends not only on the user, but also on the group. Instead of controlling for the group size and using a random intercept on the group level, a more sophisticated approach would yield results that are more precise. For future research, we plan to gather more data on the media and group level to get a clearer picture on how the interdependence of user behaviour, group type and the used communication medium affects the outcomes of the socialisation process. Besides improving understanding of the process, we aim to improve the prediction accuracy and robustness of the model, which is especially helpful for practitioners as they are rather interested in accurate prediction than inference. To cope with the current lack of accuracy, the dynamics of the social network and effects beyond linear relationships, we plan to perform random-forest prediction or use neural networks. We have already performed preliminary unsupervised classification of group types in ESN and are looking to incorporate the results into our research on the socialisation process. Practitioners can use accurate prediction models to take deliberate management actions regarding the socialisation process. In a turbulent multi-project environment, management has to decide where to put new hires, and the insights on the socialisation process can inform staffing decisions. Especially if teams are quickly assembled, having decision support on the user-group integration is valuable to achieve effective team compositions.

## 7 References

- Abuelmaged, M. G. 2018. 'Knowledge Sharing through Enterprise Social Network (ESN) Systems: Motivational Drivers and Their Impact on Employees' Productivity', *Journal of Knowledge Management* (22:2), pp. 362–383.
- Angeletou, S., Rowe, M., and Alani, H. 2011. 'Modelling and Analysis of User Behaviour in Online Communities', in *International Semantic Web Conference (ISWC)* (Vol. 10), pp. 35–50.
- Bates, D., Maechler, M., Bolker, B., Walker, S., Christensen, R. H. B., Singmann, H., Dai, B., and Eigen, C. 2017. 'Lme4: Fitting Linear Mixed-Effects Models Using Lme4', *Journal of Statistical Software* (67:1), pp. 1–113.

- Bauer, T. N., and Erdogan, B. 2011. 'Organizational Socialization: The Effective Onboarding of New Employees.', in *APA Handbook of Industrial and Organizational Psychology, Vol 3: Maintaining, Expanding, and Contracting the Organization.*, S. Zedeck (ed.), Washington: American Psychological Association, pp. 51–64.
- Beck, R., Pahlke, I., and Seebach, C. 2014. 'Knowledge Exchange and Symbolic Action in Social Media-Enabled Electronic Networks of Practice: A Multilevel Perspective on Knowledge Seekers and Contributors', *MIS Quarterly*, pp. 1245–1270.
- Berger, K., Klier, J., Klier, M., and Richter, A. 2014. 'Who Is Key...? Characterizing Value Adding Users in Enterprise Social Networks', in *22nd European Conference on Information Systems (ECIS)* (Vol. Track 21).
- Bergiel, B. J., Bergiel, E. B., and Balsmeier, P. W. 2008. 'Nature of Virtual Teams: A Summary of Their Advantages and Disadvantages', *Management Research News* (31:2), pp. 99–110.
- Cetto, A., Klier, M., Richter, A., and Zolitschka, J. F. 2018. "Thanks for Sharing"—Identifying Users' Roles Based on Knowledge Contribution in Enterprise Social Networks', *Computer Networks* (135), Elsevier B.V., pp. 275–288.
- Chui, M., Manyika, J., Bughin, J., Dobbs, R., Roxburgh, C., Sarrazin, H., Sands, G., and Westergren, M. 2012. 'The Social Economy: Unlocking Value and Productivity through Social Technologies', *McKinsey Global Institute* (July), pp. 1–18.
- Cribari-Neto, F., and Zeileis, A. 2009. 'Beta Regression in R', *Research Report Series / Department of Statistics and Mathematics* (Vol. 98), Vienna.
- Cross, R., and Prusak, L. 2002. 'Organizations Go – or Stop Waiter', *Harvard Business Review* (January).
- Duhigg, C. 2016. 'What Google Learned From Its Quest to Build the Perfect Team', *The New York Times Magazine*. (<https://www.nytimes.com/2016/02/28/magazine/what-google-learned-from-its-quest-to-build-the-perfect-team.html>).
- Ellison, N. B., Gibbs, J. L., and Weber, M. S. 2015. 'The Use of Enterprise Social Network Sites for Knowledge Sharing in Distributed Organizations', *American Behavioral Scientist* (59:1), pp. 103–123.
- Ferrari, S. L. P., and Cribari-Neto, F. 2004. 'Beta Regression for Modelling Rates and Proportions', *Journal of Applied Statistics* (31:7), pp. 799–815.
- Gleave, E., Welser, H. T., Lento, T. M., and Smith, M. A. 2009. 'A Conceptual and Operational Definition of "Social Role" in Online Community', in *42nd Hawaii International Conference on System Sciences (HICSS)*, pp. 1–11.
- Gonzalez, E., Leidner, D., Riemenschneider, C., and Koch, H. 2013. 'The Impact of Internal Social Media Usage on Organization Socialization and Commitment', in *34th International Conference on Information Systems (ICIS)*, pp. 1–18.
- Hacker, J., Riemer, K., and Bernsmann, R. 2017. 'Discovering Knowledge Actor Roles in Enterprise Social Networks - a Case Study in a Professional Services Firm', in *Social Knowledge Management in Action: Applications and Challenges*, R. Helms, F. Darses, R. Dieng, C. Simone, and M. Zackland (eds.), Springer, pp. 125–146.
- Hansen, D. L., Shneiderman, B., and Smith, M. 2010. 'Visualizing Threaded Conversation Networks: Mining Message Boards and Email Lists for Actionable Insights', in *International Conference on Active Media Technology*, pp. 47–62.
- Helms, R., and Buijsrogge, K. 2006. 'Application of Knowledge Network Analysis to Identify Knowledge Sharing Bottlenecks at an Engineering Firm', in *Proceedings of the Fourteenth European Conference on Information Systems*.
- Holtzblatt, L., Drury, Jill, L., Weiss, D., Damianos, L. E., and Cuomo, D. 2013. 'Evaluating the Uses and Benefits of an Enterprise Social Media Platform', *Journal of Social Media for Organizations* (1:1), pp. 1–21.
- Kammeyer-Mueller, J. D., and Wanberg, C. R. 2003. 'Unwrapping the Organizational Entry Process: Disentangling Multiple Antecedents and Their Pathways to Adjustment.', *Journal of Applied Psychology* (88:5), pp. 779–794.
- Kuegler, M., Smolnik, S., and Kane, G. 2015. 'What's in IT for Employees? Understanding the Relationship between Use and Performance in Enterprise Social Software', *The Journal of Strategic Information Systems* (24:2), pp. 90–112.
- Leidner, D., Koch, H., and Gonzalez, E. 2010. 'Assimilating Generation Y IT New Hires into USAA's



- Workforce: The Role Of An Enterprise 2.0 System', *MIS Quarterly Executive* (9:4).
- Leon, R.-D., Rodríguez-Rodríguez, R., Gómez-Gasquet, P., and Mula, J. 2017. 'Social Network Analysis: A Tool for Evaluating and Predicting Future Knowledge Flows from an Insurance Organization', *Technological Forecasting and Social Change* (114), pp. 103–118.
- Major, D. A., Turner, J. E., and Fletcher, T. D. 2006. 'Linking Proactive Personality and the Big Five to Motivation to Learn and Development Activity', *Journal of Applied Psychology* (91:4), pp. 927–935.
- Mäntymäki, M., and Riemer, K. 2016. 'Enterprise Social Networking: A Knowledge Management Perspective', *International Journal of Information Management* (36:6), pp. 1042–1052.
- Maznevski, M. L., and Chudoba, K. M. 2000. 'Bridging Space Over Time: Global Virtual Team Dynamics and Effectiveness', *Organization Science* (11:5), INFORMS, pp. 473–492.
- Nahapiet, J., and Ghoshal, S. 1998. 'Social Capital, Intellectual Capital, and the Organizational Advantage', *The Academy of Management Review* (23:2), pp. 242–266.
- Oh, H., Chung, M., and Labianca, G. 2004. 'Group Social Capital and Group Effectiveness: The Role of Informal Socializing Ties', *Academy of Management Journal* (47:6), pp. 860–875.
- Parise, S., Cross, R., and Davenport, T. H. 2006. 'Strategies for Preventing a Knowledge-Loss Crisis', *MIT Sloan Management Review*.
- Powell, A., Piccoli, G., and Ives, B. 2004. 'Virtual Teams: A Review of Current Literature and Directions for Future Research', *ACM SIGMIS Database* (35:1), pp. 6–36.
- Richter, A., and Riemer, K. 2013. 'Malleable End-User Software', *Business and Information Systems Engineering* (5:3), pp. 195–197.
- Riemer, K., Finke, J., and Hovorka, D. S. 2015. 'Bridging or Bonding : Do Individuals Gain Social Capital from Participation in Enterprise Social Networks?', *36th International Conference on Information Systems (ICIS)*, pp. 1–20.
- Riemer, K., Stieglitz, S., and Meske, C. 2015. 'From Top to Bottom: Investigating the Changing Role of Hierarchy in Enterprise Social Networks', *Business and Information Systems Engineering* (57:3), pp. 197–212.
- Rowe, M., Fernandez, M., Angeletou, S., and Alani, H. 2013. 'Community Analysis through Semantic Rules and Role Composition Derivation', *Journal of Web Semantics* (18), pp. 31–47.
- Saks, A. M., and Ashforth, B. E. 1997. 'Organizational Socialization: Making Sense of the Past and Present as a Prologue for the Future', *Journal of Vocational Behavior* (51:2), pp. 234–279.
- Smith, M., Hansen, D. L., and Gleave, E. 2009. 'Analyzing Enterprise Social Media Networks', in *International Conference on Computational Science and Engineering* (Vol. 4), pp. 705–710.
- Stieglitz, S., Meske, C., Ross, B., and Mirbabaie, M. 2018. 'Going Back in Time to Predict the Future - The Complex Role of the Data Collection Period in Social Media Analytics', *Information Systems Frontiers*.
- Stieglitz, S., Mirbabaie, M., and Milde, M. 2018. 'Social Positions and Collective Sense-Making in Crisis Communication', *International Journal of Human-Computer Interaction*.
- Trier, M., and Richter, A. 2015. 'The Deep Structure of Organizational Online Networking - an Actor-Oriented Case Study', *Information Systems Journal* (25:5), pp. 465–488.
- Viégas, F. B., and Smith, M. 2004. 'Visualizing the Activity of Individuals in Conversational Cyberspaces', in *37th Hawaii International Conference on System Sciences (HICSS)*, pp. 1–10.
- Wehner, B., Ritter, C., and Leist, S. 2017. 'Enterprise Social Networks: A Literature Review and Research Agenda', *Computer Networks* (114), pp. 125–142.
- Willyerd, K. 2012. 'Social Tools Can Improve Employee Onboarding', *Harvard Business Review*. (<https://hbr.org/2012/12/social-tools-can-improve-e>, accessed February 6, 2018).

**Acknowledgement:** Tobias Kroll has received a funded PhD scholarship from the Foundation of German Business.

**Copyright:** © 2018 Joschka Hüllmann and Tobias Kroll. This is an open-access article distributed under the terms of the [Creative Commons Attribution-NonCommercial 3.0 Australia License](https://creativecommons.org/licenses/by-nc/3.0/), which permits non-commercial use, distribution, and reproduction in any medium, provided the original author and ACIS are credited.

# Accommodated Emoji Usage: Influence of Hierarchy on the Adaption of Pictogram Usage in Instant Messaging

## **Tobias Kroll**

Department of Computer Science and Applied Cognitive Science  
University of Duisburg-Essen  
Duisburg, Germany  
Email: tobias.kroll@uni-due.de

## **Lea-Marie Braun**

Department of Computer Science and Applied Cognitive Science  
University of Duisburg-Essen  
Duisburg, Germany  
Email: lea-marie.braun@uni-due.de

## **Stefan Stieglitz**

Department of Computer Science and Applied Cognitive Science  
University of Duisburg-Essen  
Duisburg, Germany  
Email: stefan.stieglitz@uni-due.de

## **Abstract**

Communication Accommodation Theory predicts to what extent individuals accommodate their verbal and nonverbal behaviour by converging it towards their conversation partner or diverging it away from them to gain social approval and to decrease social distance. Especially individuals in lower hierarchy positions accommodate their communication behaviour towards individuals in higher hierarchy positions. Nowadays, computer- and smartphone-mediated communication are common ways to communicate, for example via instant messaging. However, instant messenger lack in transporting nonverbal cues. To fill this gap, emoji are used increasingly. A study was conducted to examine how individuals in lower hierarchy positions converge their emoji usage towards individuals in higher hierarchy position. The results support the assumption that the higher hierarchy is perceived, the more emoji accommodation is shown.

**Keywords** Communication Accommodation Theory, Convergence, Emoji, Social Hierarchy, Mobile Communication

## 1 Introduction

In recent years, smartphones have become disruptive high-tech devices which most people use on a daily basis (Lee et al. 2014). Functions provided in smartphones help to manage everyday tasks and offer ubiquitous communication channels (Park et al. 2014). Besides traditional calls and steady mail access, instant messaging (e.g. iMessage, WhatsApp) has become popular with the rise of Internet-capable devices (Church and de Oliveira 2013; Stieglitz et al. 2014). This new role of instant messaging also in the business communication (Muir et al. 2017) raises questions about its influence in organisations, e.g. by with regard to secure communication channels, technostress, work life balance, but also on the communication culture between employees or on hierarchical structures. Enterprise social networks (sometimes including instant messaging) have already related to less hierarchical communication and reduced social distances (Riemer et al. 2015). New instant messaging services enable a plethora of research areas within the field of information systems and computer-mediated communication, especially when integrating different perspectives.

From prior research, we learned that in face-to-face (FtF) communication, people show the tendency to (unconsciously) adopt their interlocutors' language as phrases and accents as well as the nonverbal behaviour as facial expressions and gestures (Giles and Ogay 2007). This behaviour is called accommodation and has been studied and explained by the Communication Accommodation Theory (CAT) (Giles and Ogay 2007, p. 293). CAT addresses accommodations individuals make either towards their conversation partners or away from them. Usually, accommodation aims to increase the social acceptance and to smooth interaction. In particular, it has been observed that people in a lower hierarchical position adopt the language of interlocutors in higher hierarchical positions (Giles et al. 1991).

While facial expressions cannot be accommodated in instant messaging, phrases and word orders can be equalized (Muir et al. 2017). Due to the lack of possibilities to reveal emotions or gestures, emoji have been developed out of simple smiley representations (Chen et al. 2017). With emoji, it is possible to add a certain expression or emotion to messages and to enrich and potentially improve them in terms of unambiguous comprehension (Li et al. 2018). Emoji usage may support reducing the distance between individuals in a lower hierarchical position and those in a higher hierarchical position which leads to possibly being able to avoid communication problems based on hierarchy (Skovholt et al. 2014). Further, knowledge about emojis and their impact on conversations' effectiveness is especially relevant for organisations as these replace more and more FtF meetings by virtual communication and collaboration (Gilson et al. 2015).

Although emojis are seen as helpful tool to substitute nonverbal cues in computer-mediated communication and instant messaging (Chen et al. 2017; Walther and D'Addario 2001), to the best of our knowledge their usage has not yet been studied in relation to hierarchy and organisational communication. This study's aim is to examine the emoji accommodation behaviour in instant messaging. Our study builds upon the Communication Accommodation Theory (CAT) which has received only little attention in information systems, yet (e.g. Ludwig et al. 2014). The guiding research question is: *What is the connection between the usage of emoji and the perceived hierarchy in instant messaging communication?*

With the focus on instant messaging and hierarchy, we originally use the Communication Accommodation Theory to empirically analyse and explain different emoji usage behaviours. This study contributes to the understanding of today's communication and provides insights about the effect of emoji usage on the perceived hierarchy as well as the effect of perceived hierarchy on emoji accommodation behaviour.

## 2 Background

### 2.1 Computer-mediated Communication in Organisations

The development and prevalence of devices like smartphones in the last decade has constituted the replacement of traditional Face-to-Face (FtF) communication with computer-mediated communication (Waldeck et al. 2012). Older mobile devices with a small and monochrome display as well as limited and expensive Internet access have turned into high-performing allrounder smartphones (Park et al. 2014) which are used by most people daily (Lee et al. 2014). They offer many advantages by means of constantly developing functions helping to manage daily routines – both private and business (Meske et al. 2018). Mobility is an important factor in this context because it gives users the chance to communicate at any time and location (Church and de Oliveira 2013; Stieglitz et al. 2014). Likewise,

instant messaging has been increasingly adopted from organizations (Wang and Gallivan 2009) and has changed the way employees collaborate and communicate (Cheung et al. 2007). Organisations evaluated instant messaging to be quicker and more comfortable than email or phone calls (Muir et al., 2017) because of quasi real-time text messages and ancillary presence signals (Wang and Gallivan 2009) which support collaboration and communication processes (Cheung et al. 2007).

Besides communication in teams or between employees in general, communication between superiors and subordinates is crucial for effective organisational operations (Myers 2016). Many organisations have the structure of formal or social hierarchies meaning the ranking of individuals in a social group; some members are superior while others are subordinate. Ranking is about the positions someone has in a hierarchy based on a valued social dimension; a higher rank often goes hand in hand with higher social power (Koski et al. 2015). The different positions within an organisational hierarchy provide knowledge and clarity about how to act in certain situations and, hence, they support individuals' desire to behave appropriately (Halevy et al. 2011). Clear roles and responsibilities reflected in legitimate hierarchies are helpful for a coordinated and productive working environment.

Research found that superiors' communication style has an influence on the communication quality and on relationship building (Myers 2016). Strong relationships between superiors and subordinates are important since they affect the way subordinates feel connected and integrated in the whole organisation. This, in turn, increases performance and reduces the chance of termination (Bisel et al. 2012). Communication is more effective when superiors communicate with openness, sensitivity to others, good listening skills and persuasiveness (Myers 2016). Further, communication is shaped by nonverbal behaviour. They are able to include nonverbal cues in their message to signal liking or positive feedback for their subordinates (Richmond and McCroskey 2000). Furthermore, superiors that exhibit high nonverbal immediacy are perceived as more credible and more interpersonally attractive than superiors that use nonverbal immediacy rarely (Richmond and McCroskey 2000). Perceived credibility and attractiveness affect subordinates' motivation and job satisfaction. Moreover, superiors that engage in nonverbal behaviour are evaluated more positively and subordinates appreciate this kind of communication. When both superiors and subordinates add nonverbal behaviour to their messages, they have a stronger relationship.

However, the increased usage of instant messaging in organisations has also been suspected to hinder the quality of a superior-subordinate communication and to influence the relationship negatively (Kirkman et al. 2002; Quan-Haase et al. 2005). Especially the instant messaging's lack of nonverbal cues that provides awareness has been criticised (Church and de Oliveira 2013). Still, developers have tried to fill the gap by adding new options like symbols to confirm delivery or reading, but still, nonverbal cues as gestures, facial expressions and body language could hardly be conveyed via instant messaging (Park et al. 2014). Consequently, the lack of nonverbal cues may have a negative impact on both sender and receiver. Senders cannot easily convey emotions with a message nor consider their interlocutor's mood. The receivers' challenge is again to interpret a message's meaning with the absence of nonverbal cues (Mirbabaie et al. 2017).

## 2.2 Emoji as Nonverbal Cues

Due to the missing possibility to textually convey certain information, users started to add characters to text messages that form emoticons – e.g. ;- ) – and aim at conveying information like a sentiment or intended irony (Mirbabaie et al. 2017; Riordan 2017a). However, more complex objects and emotions cannot be represented by emoticons since the typographic symbols are limited (Lu et al. 2016). To address this limitation, a Japanese graphic designer transformed emoticons into Unicode characters named emoji (a combination of the Japanese words for “picture” and “character”) in the year 2009 (Riordan 2017b; Wijeratne et al. 2017). Today, emoji show a big variety of signs and symbols like food, flags, animals and clothing (Chen et al. 2017). The most popular emoji, though, are the face-related ones that express a certain emotion (Chen et al. 2017). Emoji got a lot of attention and became increasingly popular – also indicated by the Oxford Dictionaries Word of the Year 2015, 🤩 “Face with Tears of Joy”. Examining their popularity, a first explanation might be the compactness of emoji. People do not have to explain each of their emotions but can add one emoji to their message to convey a feeling that would be hidden using text only (Lu et al. 2016). For example, “I got my test results 🤩” conveys another message than “I got my test results 😊” (Pohl et al. 2017). Tandyonomanu and Tsuroyya (2018) found that emoji can reduce misunderstandings and give individuals the chance to show their emotions. Further, they can be seen as a way to replace certain nonverbal cues known from FtF communication in a computer-mediated communication (Chen et al. 2017; Walther and D'Addario 2001). In this context, it has been found that not all individuals use emoji the same way nor do they interpret them equally

(Tigwell and Flatla 2016). Older people use less emoji than younger ones (An et al. 2018), females tend to use more emoji than males do (Chen et al. 2017) and also, personality influences emoji usage (Li et al. 2018).

Elder (2018) argues that receiving messages with emoji have a positive influence on how the receiver perceives, interprets and replies. Receivers tend to be more altruistic, honest and generous in case they received a message that includes face emoji. Those emotions, again, have a positive effect on the answer and can support relationship building as well as friendship strengthening (Elder 2018). Perceiving facial expressions leads to interpersonal social mechanisms like emotional contagion and supports relationship building (Lohmann et al. 2017). However, emoji can also have a dark side because they show more the expressions and emotions individuals want their interlocutors to perceive than the emotions they really feel (Tandyonomanu and Tsuroyya 2018). Emoji have the ability to hide real feelings. Furthermore, they have been evaluated as inappropriate and harmful for the sender's credibility in business contexts (Glikson et al. 2017).

### 2.3 Communication Accommodation Theory

The Communication Accommodation Theory (CAT) explains an individual's communicative adjustments towards or away from others to create, maintain or decrease social distance (Giles and Ogay 2007). Such constantly changing communication behaviour is called accommodation. CAT is based on the main assumption that individuals adjust themselves depending on their conversation partner (Dragojevic et al. 2016). This behaviour is pervasive and part of a successful interaction. Accommodations are made immediately and mostly unconsciously. It can be separated in three different strategies: convergence, divergence and maintenance (Dragojevic et al. 2016; Giles and Ogay 2007). Convergence is about adjusting one's communication behaviour in a way to be more like the conversation partner. The goal is to smooth interaction and to decrease social distance. Contrary with divergence, individuals adjust their communication behaviours to be more dissimilar to their conversation partners.

Individuals do not only adjust their verbal expressions but also their nonverbal behaviour. CAT has contributed to the explanation of how and why communication is accommodated and its consequences (Giles and Ogay 2007). Since nonverbal cues cannot be observed in textual computer-mediated communication, researchers investigated whether verbal communication and potentially more dimensions are accommodated. Bunz and Campbell (2004) found that structural politeness phrases are accommodated during email communication. When participants received a friendly written email with structural and verbal politeness phrases (e.g. Dear Mrs. ... Kind regards), they answered with a significantly politer email than without such phrases. In the context of online communities, it has been found that users tend to converge their linguistic style (e.g. the usage of functional words) on a higher degree when they feel stronger connected to their community (Ludwig et al. 2014).

In addition to verbal cues, nonverbal cues like response time and message length are accommodated (Riordan et al. 2013). Scissors et al. (2009) found that individuals also accommodate on three different levels: content (semantic), structural (tenses or syntactic) and stylistic (surface) level. Creating similarity on a content level may be realized by having the same opinion about a topic. At the structural level, similarity can be increased by using the same tense or repeating phrases. To create similarity on the stylistic level, individuals copy certain words (e.g. LOL) or punctuations (e.g. !!!).

### 2.4 Accommodation and Hierarchy

Considering the interplay of two individuals communicating, CAT describes a symmetrical and asymmetrical accommodation (Dragojevic et al. 2016). In particular, hierarchical imbalance facilitates asymmetrical convergence (Giles et al., 1991), i.e. individuals in lower hierarchical position converge their communication behaviour more to individuals in higher hierarchical position than the opposite direction (Jones, Gallois, Callan, & Barker, 1999). CAT explains that individuals in lower hierarchical position are motivated to accommodate their communication behaviour to gain social approval and to minimize social distance (Giles et al. 1991; Muir, Joinson, and Cotterill 2016).

Some studies concluded that the instant messaging between superiors and subordinates can increase social distance and complicate the relationships between them because of missing nonverbal and social cues and reduced richness (Kirkman et al. 2002; Quan-Haase et al. 2005). A harmed relationship can hinder effectiveness and decrease performance (Myers 2016). However, confirming results from FtF communication, Muir et al. (2017) found instant messaging users in lower hierarchical positions to be more likely to accommodate their linguistic style to those in a higher hierarchical positions than the

opposite direction. Furthermore, this upward accommodation leads to positive interpersonal impressions and task attractiveness (Muir et al. 2017).

Summarising and deriving our hypotheses, imbalanced hierarchical situations have been shown to affect the degree of accommodation behaviour (Muir et al., 2017). In particular, people show convergence of e.g. message length, response time, politeness phrases and linguistic style (Bunz and Campbell 2004; Riordan et al. 2013; Scissors et al. 2009). In FtF communication, verbal and nonverbal cues are expected to play a crucial role and were both found to be accommodated. Emoji are a rather new way to substitute nonverbal cues in computer-mediated communication but have not yet been studied in this light before. Also, emoji have been discussed as inappropriate for business communication and imbalanced hierarchical positions (Glikson et al. 2017). However, it is yet to be studied how emoji usage affects the perceived hierarchical position as well as how the perception of hierarchy influences the emoji accommodation behaviour. Considering and synthesizing previous findings, we hypothesize:

*H1: Individuals in low perceived hierarchical positions will accommodate their instant messaging emoji usage more than individuals in high hierarchical positions.*

*H2: The higher individuals perceive their interlocutors' hierarchy position, the more they show emoji accommodation in instant messaging.*

*H3: Instant messaging with emoji leads to a lower perceived hierarchical distance than instant messaging without emoji.*

### 3 Method

The proposed hypotheses were investigated quantitatively in an online experiment. The basic study design was based on Muir et al. (2017) and included four different instant messaging chat records in a usual messenger look. The interlocutor's messages were predefined. Such messages differed in two dimensions: (1) *formal* versus *informal*, and (2) *emoji usage* versus *no emoji usage*. Two variants are shown in figure 1. In each chat record, three placeholders between the interlocutor's messages had to be filled. For each placeholder, a textual answer without any emoji was given. The participants' only task was to decide whether to add emoji to the prepared text or not. Thereby, they could choose none, one or more of the fifteen most used emoji. Referring to Jaeger et al. (2018), the emoji were picked out based on the website Emoji tracker that analyses Twitter posts and depicts emoji frequencies. Only facial and hand emoji were selected (Pohl et al. 2017): 😊, 😍, 😞, 😏, 😬, 😇, 😊, 😬, 😏, 😬, 😏, 😬, 😏, 😬, 😏, 😬, 😏, 😬, 😏, 😬, 😏.

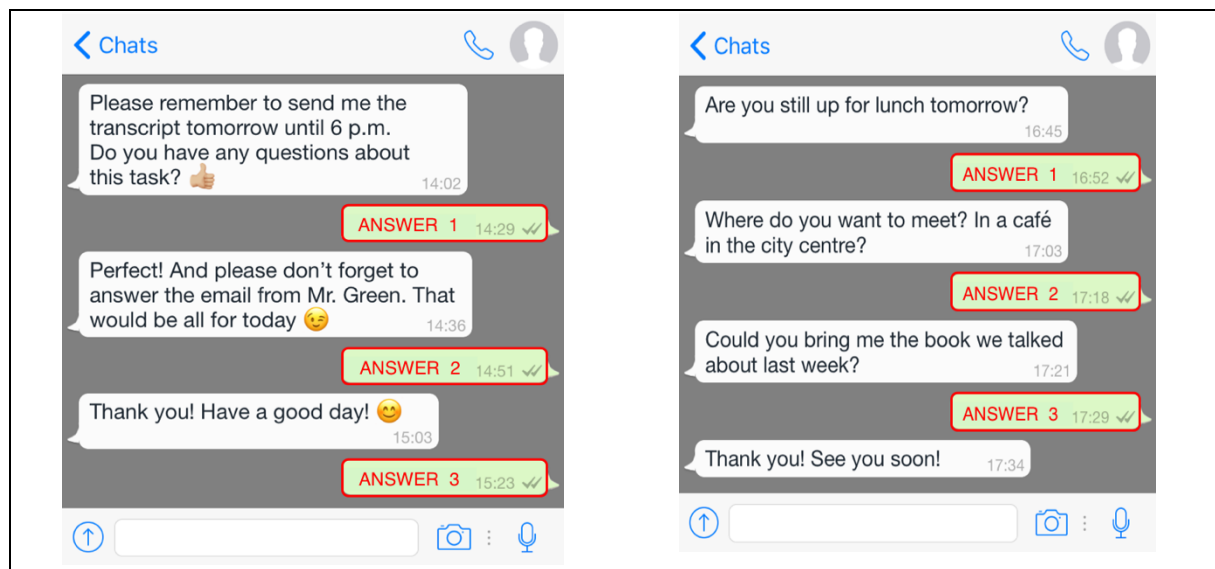

Figure 1: Formal chat with emoji (left), informal chat without emoji (right)

After each chat record, the participants were asked to indicate the interlocutor's perceived hierarchical position based on a 5-point Likert scale from "Lower hierarchical position" to "Higher hierarchical position". By design, we expected the formal chat to be perceived as a higher hierarchical position (e.g. chat with the boss) and the informal chat record as a conversation with an individual in about the same hierarchical position as (e.g. friend). We did not include a conversation with a lower hierarchical position

because we believed that most participants would perceive it as artificial. We have captured the perceived hierarchy to divide the study participants more precisely into groups (i.e. interlocutor in higher position versus interlocutor in equal or lower position). We assumed the perception of a same chat to be perceived hierarchically to varying degrees. Participants also had to fill in a questionnaire about their demographics like age, gender and education. Additionally, they were asked for their emoji preference by answering how often they use emoji in computer-mediated communication with four options (*never to always*) based on Jaeger et al. (2018).

The actual accommodation was measured with the Zelig Quotient developed by Jones et al. (2014). The Zelig Quotient has been used in many studies which examine accommodation (Muir et al. 2017; Muir, Joinson, and Cotterill 2016; Muir, Joinson, Cotterill, et al. 2016). To the best of our knowledge, no one ever examined emoji accommodation which we operationalised as follows: We based the calculations on the general procedure of the Zelig Quotient that measures linguistic style accommodation by counting how often a certain feature is used. A feature is, for example, a pronoun, an article or a conjunction (Muir, Joinson, Cotterill, et al. 2016). In the context of the usual Zelig Quotient, the content of the feature is not important and only the feature's frequency is relevant. Consequently, we also took the number of used emoji as input disregarding the precise emoji and their meaning. The specific calculations are described in the data preparation section.

The participants were shown all four variations in random order to minimize a familiarization effect. Thereby, we could build a baseline of emoji usage meaning the average usage of emoji per message. Furthermore, they had to fill in one of four randomly selected scales of a personality inventory after each chat record to divert their attention slightly to another task. The emoji selection of all four chat protocols served as basis for the assessment of an emoji usage baseline (see next section).

## 4 Results

### 4.1 Sample and Procedure

The participants of the online survey were either recruited via social media or by face to face recruitment. In total, 158 German-speaking participants took part in the online study of which 56 (35.4%) were male and 96 (60.6%) female – six did not specify the gender. The mean age was 29.25 with a range from 18 to 65 and a standard deviation of 11.26. Most of the participants were graduated from school (57.6%). 31 (19.6%) participants had a bachelor's degree, 29 (18.3%) had master's degree, Diploma or Magister, three participants already received a PhD (1.9%). Further, 46.8% were students, 2.5% were trainees, 36.7% were employees, 1.9% were self-employed and 3.8% were civil servants. Like in other studies, a large part of the participants are students. Although they are usually unexperienced as regards business communication and productivity, they are more familiar with emoji and know situations of different hierarchical positions.

### 4.2 Data Preparation

The statistical analyses were carried out by SPSS 25.0. We excluded participants with too short or too long timings as we expected them to have not answered the questions thoroughly. To measure accommodation, the Zelig Quotient was calculated (Jones et al. 2014): The total number of used emoji for each participant was calculated as well as the number of used emoji for each chat record. A baseline was calculated with the average emoji number per answer (total number / 12 answer). Also, the average for each of the four chat records was calculated (number for chat record / 3 answer). The differences between the baseline and the different chat record means were calculated (i.e. Zelig Quotient). An outlier assessment of the quotients led to the exclusion of six further participants. The final data set included 122 participants.

We let the participants select emojis for each of the four records to calculate the emoji baseline. Though people may also accommodate their behaviour e.g. towards peers, we focused on hierarchy and included the hierarchy variants to assess the baseline for different hierarchical positions. For the accommodation analyses, we eventually used only the first randomly selected chat record of each participant and the respective answers for the perceived hierarchy and the selected emoji. Further preparatory work included a test whether the baseline values represent the participants' general tendency to use emoji. The correlation between baseline value and emoji tendency was calculated ( $r = .308, p = .001$ ). The correlation coefficient is appropriate because of the subjective self-selection into one of four groups in comparison to the average of actually picked emojis. A visual inspection of the accommodation value histogram and Q-Q-Plot showed a good fit for normal distribution. To validate whether the participants perceived the four different chat records as expected, we also tested how the chat records differ from

each other in their perceived hierarchy position. Therefore, a Friedman's ANOVA was conducted to compare the four chat records (formal without emoji:  $M = 4.07$ ,  $SD = 1.38$ ; formal with emoji:  $M = 3.89$ ,  $SD = 1.29$ ; informal without emoji:  $M = 2.90$ ,  $SD = 0.63$ ; informal with emoji:  $M = 2.85$ ,  $SD = 0.64$ ). Results revealed a general difference between the four chat records,  $\chi^2(3) = 133.26$ ,  $p < .001$  demonstrating a sufficient experiment design.

### 4.3 Perceived Hierarchy and Emoji

To test hypothesis 1, we conducted a t-test for independent samples with perceived hierarchical position as independent grouping variable and emoji accommodation as dependent variable. When a participant perceived the interlocutor to be of a higher hierarchical position (perceived hierarchy position  $> 3$ ), the participant was in a lower hierarchical position. Equally, when a participant perceived their interlocutor as being in an equal or lower hierarchical position (perceived hierarchy position  $\leq 3$ ), the participant saw himself in an equal or higher hierarchical position. For clarification, we did not use the random stimuli (*informal without emoji* etc.) as separation criterion.

The groups were almost equal: low hierarchical position ( $N = 60$ ) and high hierarchical position ( $N = 62$ ). Homogeneity of variances was tested using Levene's Test which showed that equal variances could be assumed,  $F(120) = 1.92$ ,  $p = .169$ . The results of the t-test showed that on average participants in a low hierarchical position accommodate their emoji usage more often ( $M = .41$ ,  $SE = .27$ ) than participants in a high hierarchical position ( $M = -.01$ ,  $SE = .34$ ). This difference,  $0.42$ , between the accommodation of emoji of participants in a low hierarchical position and in a high hierarchical position was significantly different,  $t(120) = 7.57$ ,  $p < .001$ , with an effect size of  $r = 0.57$ .

A linear regression was conducted for testing hypothesis 2 with perceived hierarchy position as the independent variable ( $M = 3.66$ ,  $SD = 1.23$ ) and emoji accommodation as the dependent variable ( $M = 0.20$ ,  $SD = 0.37$ ). The correlation between perceived hierarchical position and emoji accommodation was checked. The results showed a moderate positive correlation between perceived hierarchy position and emoji accommodation,  $r = .325$ ,  $p < .001$ . Homoscedasticity was tested by checking the standardized and unstandardized residuals. Auto-correlation was tested with Durbin-Watson statistic (1.45). The multiple coefficient of determination  $R^2$  for the overall model was .11 (adjusted  $R^2 = .10$ ). Perceived hierarchy position was able to significantly predict emoji accommodation,  $F(1, 120) = 14.15$ ,  $p < .001$ . An increase of perceived hierarchy position by one unit predicted an increase in emoji accommodation by  $.099$ ,  $B = .099$ ,  $\beta = .33$ ,  $t(120) = 3.76$ ,  $p < .001$ .

To test hypothesis 3, we conducted two t-tests for dependent samples: 1) *formal with emoji* versus *formal without emoji*, 2) *informal with emoji* versus *informal without emoji*. We used the within-subject data we collected by means of the four different chat records that were shown in random order. Hence, we were able to check whether subjects perceived the hierarchical position differently just based on the presence of emoji as everything else remained unchanged. The first t-test of the formal chat records showed no significant difference for the perceived hierarchy with emoji ( $M = 3.89$ ,  $SD = 1.29$ ) and without emoji ( $M = 4.07$ ,  $SD = 1.38$ ),  $t(121) = 1.03$ ,  $p = .31$ . Also, the second t-test showed that perceived hierarchy position of the informal chat record with emoji ( $M = 2.85$ ,  $SD = 0.64$ ) does not differ significantly from the informal chat without emoji ( $M = 2.90$ ,  $SD = 0.63$ ),  $t(121) = 0.63$ ,  $p = .53$ .

## 5 Discussion

Our aim is to investigate the relationship of perceived hierarchy and emoji accommodation behaviour. So far, computer-mediated communication and instant messaging have been related to the Communication Accommodation Theory. However, we originally study whether emoji – which is deemed as a substitute for nonverbal expressions from FtF communication – are also adopted to the interlocutor's usage.

Like hypothesised in H1, we found a significant difference and stronger emoji accommodation behaviour when participants saw the chat record with a superior. Hence, emoji usage can also be subject to an asymmetrical accommodation behaviour (Giles et al. 1991). Confirming CAT that assumes accommodation asymmetry in imbalanced hierarchical situations, we found empirical indications that this applies for emoji usage which is quite different to other communication features like text length, response time or certain words (Riordan et al. 2013; Scissors et al. 2009). Using different phrases than usual might be easier and contextual in anyway – i.e. you simply write an application or motivation letter differently than a cancellation letter. In contrast, emoji can have different meanings to different people which could make an accommodation less likely. Still, our study demonstrates that people who usually



do not use emoji (calculations from the baseline) would use them if the interlocutor is perceived as superior.

Besides the average difference, we also tested a linear effect of perceived hierarchical position. The regression model for hypothesis H2 showed a significance prediction of the accommodation behaviour. The higher participants perceived their interlocutors' hierarchical position, the more converging accommodation has been shown. Convergence means that participants have either positively deviated from their usual emoji baseline or reduced the number of emoji to fit the interlocutor's style. Emoji are presumably seen as an important aspect in the communication that is worth to accommodate.

Continuing on the background, nonverbal cues are of particular importance in FtF conversations. On the one hand, they can enrich the spoken word and underline the meaning and importance of the message (Wharton 2009). On the other hand, nonverbal cues can change messages' meaning and give them a different touch. Emoji can fill the gap in computer-mediated communication and provide a means to convey nonverbal cues that are not less important in such situations. Before the introduction and diffusion of emoji, people may have learned that digital text messages (e.g. e-mails) should be treated carefully as a receiver may read a message differently than the sender meant. In particular, organisations may face such situations as more and more FtF meetings are being replaced by emails. Our findings underline the importance of emojis as nonverbal cue in instant messaging and potentially more computer-mediated communication channels. Emoji can help to underline or clarify a message's meaning (Pohl et al. 2017) which would reduce misunderstandings and ineffective communication.

The assumed positive effect on hierarchy (hypothesis 3) like found for ESN (Riemer et al. 2015) could not be confirmed. Neither the formal chats with and without emoji differed significantly nor the informal ones. However, the means are slightly different and support a general tendency. Future studies that focus on this aspect may yield more information when and why emoji usage influences the perceived hierarchical position of a conversation partner. However, this finding could also be interpreted in that emoticons or emoji do make an conversation partner appear less credible (Glikson et al. 2017). Nevertheless, we cannot answer yet whether it is advisable to appear a bit less credible but also to reduce social distance and, in turn, increase efficient collaboration, or to maintain hierarchical differences.

## 6 Conclusion

In this study, we examined to what extent the Communication Accommodation Theory (CAT) can be applied to instant messaging in situations with hierarchical imbalance. We focused on the convergence aspect of CAT and further, how emoji are accommodated in consideration of hierarchy position. In our analyses, the perceived hierarchy position has an influence on the emoji accommodation. The higher the perceived hierarchical position of an interlocutor, the more emoji usage is converged. Individuals that normally enjoy the usage of many emoji in their text messages stopped using the high amount and started to use less emoji when texting with a person in a higher hierarchical position. Individuals that use almost no emoji started to increase their emoji frequency when texting with an individual in a higher hierarchical position. Hence, this study is able to extend CAT by a further aspect – emoji usage in instant messaging.

Besides such theoretical contributions, our study can help companies and practitioners to understand the effect of hierarchy on conversations and, in particular, on emoji usage. When emoji are suggested as a means to diminish misunderstandings in textual ad-hoc conversations, our study indicates that superiors need to introduce emoji because subordinates accommodate the behaviour. Furthermore, our study showed no significant influence of emoji on the perceived hierarchy which has been assumed in prior works. Since language is alive and constantly changing, using emoji in a business environment can be worth an attempt to improve communication.

However, our study is not without limitations. Participants had to select from a set of emoji to add them to a message. Participants could pick from 15 frequently used emoji only. It could have happened that they did not pick any emoji because their favourites were not available. Furthermore, the emoji were presented next to check boxes which the participants had to click when they wanted to add a certain emoji to a message. They are not used to pick emoji by activating check boxes but by touching them on a virtual keyboard. The given results should, therefore, be validated in a future research setting where participants have the possibility to formulate their answers with a familiar keyboard on their own.

Furthermore, we focused on the converging accommodation towards interlocutors in higher positions. Therefore, we designed the study to only differentiate between higher position and equal position (including the possibility of lower position). Future studies may investigate how diverging behaviour is

influenced by the hierarchical position, potentially calling for the inclusion of a lower hierarchical position. Last, the baseline quotient was calculated based on the four chat records which can only serve as a proxy for their actual emoji usage behaviour. To address the baseline problem, it might be a solution to collect participants' chat records of real conversations with e.g. a superior, a friend or a relative. With the help of the chat records and the used emoji during the conversations, a baseline could be calculated which better reflects the real usage of emoji.

## References

- An, J., Li, T., Teng, Y., and Zhang, P. 2018. "Factors Influencing Emoji Usage in Smartphone Mediated Communications," Springer International Publishing, pp. 423–428 (doi: 10.1007/978-3-319-78105-1).
- Bisel, R. S., Messersmith, A. S., and Kelley, K. M. 2012. "Supervisor-Subordinate Communication: Hierarchical Mum Effect Meets Organizational Learning," *Journal of Business Communication* (49:2), pp. 128–147 (doi: 10.1177/0021943612436972).
- Bunz, U., and Campbell, S. W. 2004. "Politeness Accommodation in Electronic Mail," *Communication Research Reports* (21:1), pp. 11–25 (doi: 10.1080/08824090409359963).
- Chen, Z., Lu, X., Shen, S., Ai, W., Liu, X., and Mei, Q. 2017. "Through a Gender Lens: An Empirical Study of Emoji Usage over Large-Scale Android Users," in *Human-Computer Interaction*, pp. 1–20 (doi: 10.1145/3178876.3186157).
- Cheung, C. M. K., Shen, A. X. L., Lee, M. K. O., and Wang, W. P. 2007. "Let`s Work Together! We-Intention to Use Instant Messaging for E-Collaboration," *European Conference on Information Systems (ECIS) (2007)*, pp. 407–418.
- Church, K., and de Oliveira, R. 2013. "What's up with WhatsApp? Comparing Mobile Instant Messaging Behaviors with Traditional SMS," in *15th International Conference on Human-Computer Interaction with Mobile Devices and Services (MobileHCI'13)*, pp. 352–361 (doi: 10.1145/2493190.2493225).
- Dragojevic, M., Gasiorek, J., and Giles, H. 2016. "Accommodative Strategies as Core of the Theory," in *Communication Accommodation Theory: Negotiating Personal and Social Identities Across Contexts*H. Giles (ed.), University of California, Santa Barbara: Cambridge University Press, pp. 36–59 (doi: 10.1017/CBO9781316226537.003).
- Elder, A. M. 2018. "What Words Can't Say Emoji and Other Non-Verbal Elements of Technologically-Mediated Communication," *Journal of Information, Communication and Ethics in Society* (16:1), pp. 2–15 (doi: 10.1108/JICES-08-2017-0050).
- Giles, H., Coupland, N., and Coupland, J. 1991. "Accommodation Theory: Communication, context, and consequence," *Contexts of Accommodation: Developments in Applied Sociolinguistics*, pp. 1–68 (doi: 10.1017/CBO9780511663673.001).
- Giles, H., and Ogay, T. 2007. "Communication Accommodation Theory," in *Explaining communication: Contemporary theories and exemplars*B. B. Whaley and W. Samter (eds.), Mahwah, NJ: Lawrence Erlbaum, pp. 293–310 (doi: 10.1007/978-1-349-25582-5\_19).
- Gilson, L. L., Maynard, M. T., Jones Young, N. C., Vartiainen, M., and Hakonen, M. 2015. "Virtual Teams Research: 10 Years, 10 Themes, and 10 Opportunities," *Journal of Management* (41:5), pp. 1313–1337 (doi: 10.1177/0149206314559946).
- Glikson, E., Cheshin, A., and van Kleef, G. A. 2017. "The Dark Side of a Smiley: Effects of Smiling Emoticons on Virtual First Impressions," *Social Psychological and Personality Science*, pp. 1–12 (doi: 10.1177/1948550617720269).
- Halevy, N., Y. Chou, E., and D. Galinsky, A. 2011. "A functional model of hierarchy: Why, how, and when Vertical Differentiation Enhances Group Performance," *Organizational Psychology Review* (1:1), pp. 32–52 (doi: 10.1177/2041386610380991).
- Jaeger, S. R., Xia, Y., Lee, P. Y., Hunter, D. C., Beresford, M. K., and Ares, G. 2018. "Emoji Questionnaires Can Be Used with a Range of Population Segments: Findings Relating to Age, Gender and Frequency of Emoji/Emoticon Use," *Food Quality and Preference* (68), Elsevier, pp. 397–410 (doi: 10.1016/j.foodqual.2017.12.011).

- Jones, E., Gallois, C., Callan, V., and Barker, M. 1999. "Strategies of Accommodation: Development of a Coding System for Conversational Interaction," *Journal of Language and Social Psychology* (18:2), pp. 123–151 (doi: 10.1177/0261927X99018002001).
- Jones, S., Cotterill, R., Dewdney, N., Muir, K., and Joinson, A. 2014. "Finding Zelig in Text: A Measure for Normalising Linguistic Accommodation," in *COLING 2014, the 25th International Conference on Computational Linguistics*, pp. 455–465.
- Kirkman, B. L., Rosen, B., Gibson, C. B., Tesluk, P. E., and McPherson, S. O. 2002. "Five challenges to virtual team success: Lessons from Sabre, Inc.," *Academy of Management Executive* (16:3), pp. 67–79 (doi: 10.5465/AME.2002.8540322).
- Koski, J. E., Xie, H., and Olson, I. R. 2015. "Understanding Social Hierarchies: The Neural and Psychological Foundations of Status Perception," *Social Neuroscience* (10:5), pp. 527–550 (doi: 10.1080/17470919.2015.1013223).
- Lee, Y. K., Chang, C. T., Lin, Y., and Cheng, Z. H. 2014. "The Dark Side of Smartphone Usage: Psychological Traits, Compulsive Behavior and Technostress," *Computers in Human Behavior* (31), Elsevier Ltd, pp. 373–383 (doi: 10.1016/j.chb.2013.10.047).
- Li, W., Chen, Y., Hu, T., and Luo, J. 2018. "Mining the Relationship between Emoji Usage Patterns and Personality," in *The International AAAI Conference on Web and Social Media (ICWSM)*.
- Lohmann, K., Pyka, S. S., and Zanger, C. 2017. "The Effects of Smileys on Receivers' Emotions," *Journal of Consumer Marketing* (34:6), pp. 489–495 (doi: 10.1108/JCM-02-2017-2120).
- Lu, X., Ai, W., Liu, X., Li, Q., Wang, N., Huang, G., and Mei, Q. 2016. "Learning from the Ubiquitous Language: an Empirical Analysis of Emoji Usage of Smartphone Users," in *ACM International Joint Conference on Pervasive and Ubiquitous Computing - UbiComp '16*, pp. 770–780 (doi: 10.1145/2971648.2971724).
- Ludwig, S., de Ruyter, K., Mahr, D., Wetzels, M., and Bruggen, E. 2014. "Take Their Word for It: the Symbolic Role of Linguistic Style Matches in User Communities," *MIS Quarterly Quarterly* (38:4), pp. 1201–1217 (doi: 10.25300/MISQ/2014/38.4.12).
- Meske, C., Kissmer, T., and Stieglitz, S. 2018. "Global adoption of unified communication technologies as part of digital transformation in organizations: A cross-cultural perspective," *Multikonferenz Wirtschaftsinformatik (MKWI)*, pp. 133–144 (doi: 10.1021/jp0600817).
- Mirbabaie, M., Stieglitz, S., and Ruiz Eiro, M. 2017. "#IronyOff: Understanding the usage of irony on Twitter during a corporate crisis.," *Pacific Asia Conference on Information Systems (PACIS)*.
- Muir, K., Joinson, A., and Cotterill, R. 2016. "When Communication Accommodation Backfires: Interpersonal Effects of Social Power and Linguistic Style Accommodation in Computer-Mediated-Communication," in *66th International Communication Association Annual Conference*.
- Muir, K., Joinson, A., Cotterill, R., and Dewdney, N. 2016. "Characterizing the Linguistic Chameleon: Personal and Social Correlates of Linguistic Style Accommodation," *Human Communication Research* (42:3), pp. 462–484 (doi: 10.1111/hcre.12083).
- Muir, K., Joinson, A., Cotterill, R., and Dewdney, N. 2017. "Linguistic Style Accommodation Shapes Impression Formation and Rapport in Computer-Mediated Communication," *Journal of Language and Social Psychology* (36:5), pp. 525–548 (doi: 10.1177/0261927X17701327).
- Myers, K. K. 2016. "Supervisor – Subordinate Communication," *The International Encyclopedia of Interpersonal Communication*, pp. 1–9 (doi: 10.1002/9781118540190.wbeic0045).
- Park, S., Cho, K., and Lee, B. G. 2014. "What Makes Smartphone Users Satisfied with the Mobile Instant Messenger?: Social Presence, Flow, and Self-disclosure," *International Journal of Multimedia and Ubiquitous Engineering* (9:11), pp. 315–324 (doi: 10.14257/ijmue.2014.9.11.31).
- Pohl, H., Domin, C., and Rohs, M. 2017. "Beyond Just Text: Semantic Emoji Similarity Modeling to Support Expressive Communication," *ACM Transactions on Computer-Human Interaction* (24:1), pp. 1–42 (doi: 10.1145/3039685).
- Quan-Haase, A., Cothrel, J., and Wellman, B. 2005. "Instant Messaging for Collaboration: A Case Study of a High-Tech Firm," *Journal of Computer-Mediated Communication* (10:4) (doi: 10.1111/j.1083-6101.2005.tb00276.x).

- Richmond, V. P., and McCroskey, J. C. 2000. "The Impact of Supervisor and Subordinate Immediacy on Relational and Organizational Outcomes," *Communication Monographs* (67:1), pp. 85–95 (doi: 10.1080/03637750009376496).
- Riemer, K., Stieglitz, S., and Meske, C. 2015. "From Top to Bottom: Investigating the Changing Role of Hierarchy in Enterprise Social Networks," *Business and Information Systems Engineering* (57:3), pp. 197–212 (doi: 10.1007/s12599-015-0375-3).
- Riordan, M. A. 2017a. "Emojis as Tools for Emotion Work: Communicating Affect in Text Messages," *Journal of Language and Social Psychology* (36:5), pp. 549–567 (doi: 10.1177/0261927X17704238).
- Riordan, M. A. 2017b. "The Communicative Role of Non-Face Emojis: Affect and Disambiguation," *Computers in Human Behavior* (76), Elsevier Ltd, pp. 75–86 (doi: 10.1016/j.chb.2017.07.009).
- Riordan, M. A., Markman, K. M., and Stewart, C. O. 2013. "Communication Accommodation in Instant Messaging: An Examination of Temporal Convergence," *Journal of Language and Social Psychology* (32:1), pp. 84–95 (doi: 10.1177/0261927X12462695).
- Scissors, L. E., Gill, A. J., Geraghty, K., and Gergle, D. 2009. "In CMC We Trust: The Role of Similarity," in *27th International Conference on Human Factors in Computing Systems - CHI 09*, pp. 527–536 (doi: 10.1145/1518701.1518783).
- Skovholt, K., Grønning, A., and Kankaanranta, A. 2014. "The Communicative Functions of Emoticons in Workplace E-Mails: :-)," *Journal of Computer-Mediated Communication* (19:4), pp. 780–797 (doi: 10.1111/jcc4.12063).
- Stieglitz, S., Brockmann, T., and Mirbabaie, M. 2014. "How Context Impacts on Media Choice," *25th Australasian Conference on Information Systems (ACIS)*.
- Tandyonomanu, D., and Tsurroya. 2018. "Emoji: Representations of Nonverbal Symbols in Communication Technology," in *IOP Conference Series: Materials Science and Engineering* (Vol. 288) (doi: 10.1088/1757-899X/288/1/012052).
- Tigwell, G. W., and Flatla, D. R. 2016. "'Oh that's what you meant!': Reducing Emoji Misunderstanding," in *18th International Conference on Human-Computer Interaction with Mobile Devices and Services Adjunct (MobileHCI '16)*, pp. 859–866 (doi: 2957265.2961844).
- Waldeck, J. H., Kearney, P., and Plax, T. G. 2012. *Business and Professional Communication in a Digital Age*, Cengage Learning.
- Walther, J. B., and D'Addario, K. P. 2001. "The Impacts of Emoticons on Message Interpretation in Computer-Mediated Communication," *Social Science Computer Review* (19:3), pp. 324–347.
- Wang, J., and Gallivan, M. 2009. "An Empirical Study on the Adoption of Instant Messages for Work Purposes An Empirical Study on the Adoption of Instant Messengers for Work Purposes," *Information Systems*.
- Wharton, T. 2009. "Natural pragmatics," in *Pragmatics and Non-Verbal Communication*, pp. 1–17 (doi: 10.1017/CBO9780511635649).
- Wijeratne, S., Balasuriya, L., Sheth, A., and Doran, D. 2017. "A Semantics-Based Measure of Emoji Similarity," in *International Conference on Web Intelligence*, pp. 646–653 (doi: 10.1145/3106426.3106490).

**Acknowledgement:** Tobias Kroll has received a funded PhD scholarship from the Foundation of German Business.

**Copyright:** © 2018 Tobias Kroll, Lea-Marie Braun, and Stefan Stieglitz. This is an open-access article distributed under the terms of the [Creative Commons Attribution-NonCommercial 3.0 Australia License](https://creativecommons.org/licenses/by-nc/3.0/australia/), which permits non-commercial use, distribution, and reproduction in any medium, provided the original author and ACIS are credited.

# Do You Understand Our Understanding? Personas as Hermeneutic Tools in Social Technology Projects

## **Natalie Hardwicke**

Discipline of Business Information Systems  
The University of Sydney Business School  
Sydney, New South Wales, Australia

## **Kai Riemer**

Discipline of Business Information Systems  
The University of Sydney Business School  
Sydney, New South Wales, Australia  
Email: kai.riemer@sydney.edu.au

## **Abstract**

Personas, prevalent in information systems design and implementation, are often positioned as aesthetic creations imitating technology “end users”. As such, there is an inherent assumption that end user outcomes can be known prior to technology usage in practice. This assumption, however, becomes problematic in malleable end user software (MEUS) contexts, in which concrete usage is unknowable a priori. Through an auto-ethnographic account of a unique case of a small consultancy, the Ripple Effect Group, attuned to the nature of MEUS, we explore a novel approach to personas in social technology projects. We turn to the work of Gadamer (1975) to outline two distinct views of “mimesis” for contrasting the dominant portrayal of personas in the literature compared to our empirical context. Our paper challenges conventional thinking surrounding personas, and offers a practical approach, and preliminary theorizing, for personas as hermeneutic tools to convey meaning for those involved in MEUS projects.

**Keywords:** personas, hermeneutics, mimesis, malleable technology, enterprise social networking

## 1 Introduction

The use and exploration of “personas” in information systems (IS) has been evident, according to Clarke (2014), for more than two decades. These archetypes, created as either fictitious characters or as representations of real people, are predominately viewed as depicting the potential, or intended, end users of a technological system (Dittmar and Hensch 2015). The premise behind personas is that they help capture the various goals, motivations, and behaviours different end users will have towards a particular product or service (Dotan et. al 2009). In this regard, personas are seen as creative artefacts (Hussain and Skillicorn 2008) that are purposefully crafted to help keep the real or imagined end users “in mind” throughout system design phases. The belief, in doing so, is that personas help designers create a product that will be a technological success with its real-life end users.

Despite, however, the positive intent of wanting to design for a real or imagined person, such an approach towards personas and systems design often presents a clear demarcation between user and technology. This means that an inherent assumption is being made in which a technological outcome can be pre-determined, and user interaction understood, prior to technology use taking place in-practice. In this paper, we explore how personas are portrayed in this manner in an IS context, and then problematize such assumptions with regard to the following.

Firstly, the dominant view of personas as representing end user technology outcomes becomes challenged in contexts involving malleable end user software (MEUS) (Richter and Riemer 2013). Even if MEUS are designed with the end user in mind, the meaning the technology will come to have with end users can arguably not be known until usage takes place. Secondly, we as the two authors of this paper have had, for a number of years, a relationship with the Ripple Effect Group (REG). As social business designers, REG specialise in connecting people with technology inside workplace contexts, working with clients who want their workforce to “use” enterprise social networking (ESN), a type of MEUS. In each client project, REG state that their main deliverable will be the creation of what they call “authentic personas”. However, the REG personas are not intended for a technological usage outcome. Rather, the role of such personas is to aid in sense-making and understanding of the world of the “user”.

In exploring the REG personas, the aim of our paper is to therefore challenge conventional wisdom of persona creation and use in IS (Alvesson and Kärreman 2007). We firstly draw upon Gadamer’s (1975) view of “mimesis” to explore two different interpretations of personas as creative artefacts. In the first view, personas can be seen as imitations of, or substitutes for, real people, whilst in the second view, personas can be seen as a hermeneutic act, creations intended for interpretation and understanding. Through the mimetic lens, we discuss how personas are portrayed in IS and challenge such views in relation to MEUS. In providing an auto-ethnographic account of the REG practice, our paper foregrounds preliminary theorizing for personas as vehicles for understanding, rather than as mechanisms for achieving a technological end. We stipulate that this hermeneutic persona approach can become useful for conveying meaning about end user realities regarding malleable technology.

## 2 Personas as a Mimetic Act

The word “persona” stems from Latin origins relating to the word “mask”, in which actors in Ancient Greece and Rome would perform on a stage and their worn masks would function as a resonance chamber for sound to be amplified through (Hopcke 1995). In modern times, personas have been used across multiple contexts, becoming aesthetic substitutes for real people (e.g. Grudin 2006). This can include online gaming avatars (e.g. Schultze et. al 2007), characters of digital brands (e.g. Herskovitz and Crystal 2010), or as anticipated users, created to aid technology design (e.g. Mulder and Yaar 2006).

In the technology context, personas are created as communicative artefacts, described as illustrations of targeted end users. These created characters are often accompanied with journey maps and story boards to demonstrate how a persona, or a cast of personas, would likely act in relation to a certain scenario or hypothetical narrative involving technology (Long 2009). The overall purpose of personas is that they are said to help disseminate an understanding, to all members of a design team, about end user needs in creating technological solutions for those end users (Pruitt and Grudin 2003).

What is evident, however, throughout such depictions of personas, are conflicting views about what role these created characters actually come to play. To explore different interpretations, we found it useful to turn to Gadamer’s (1975) work on philosophical hermeneutics. In his work, Gadamer explores two conflicting views of “mimesis” in relation to artistic creations, of which personas can be viewed as one example. In the most literal interpretation, mimesis is viewed as an act of imitation. Personas, in this view, would be seen as substitutes, or “stand-ins” for real people, and become blueprints intended to elicit an outcome for the people whom they are said to represent. In such an understanding, implicit

emphasis is placed on the notion that end users of a technology can be known, their factual properties be captured, and technology by made to “fit”. Although it is acknowledged that a difference exists between what is the original and what is a “copy”, the artistic copy is still viewed as capturing knowledge of the original essence. In turn, the created artefacts are seen as portraying an objective view of reality, conveying such a reality to an audience through an aesthetic outlet and an accompanying narrative. As such, personas become a vehicle for communicating in accessible and aesthetically pleasing ways.

In the alternate view, aligned with Gadamer’s own position, mimesis is seen as a phenomenological act in its own right. The created personas would be seen not as imitating an objective reality, but as being a creation to foreground a lived experience. The hermeneutic view of mimesis is the idea that what is created, such as personas, allows for an audience to enter into a disclosed world. For example, actors on a stage performing their roles, much like personas and their narratives, need an audience to bring the world of the characters to life. In this view, the characters have their stories to tell, and the action they take in telling their story is something the audience cannot control, or know the outcome. However, the audience are free to interpret, for themselves, the story’s meaning.

What this hermeneutic approach offers, which the imitative view does not, is the opportunity for a difference in outcome. In Gadamer’s view, it is important for the audience to understand what the story means for themselves, as this meaning is what elicits change in the audience. In the persona context, it would not be about the audience understanding factual realities about “user” and “technology”, but about the questioning of possibility for what the persona narrative discloses. This idea aligns to persona origins in Greek plays, in which the performance of actors wearing masks was not intended to be a portrayal about the actors, but for the disguise as being necessary for audiences to induce meaning about the performance for themselves (Hopcke 1995).

In the following, we use both views of mimesis as a lens for exploring how personas have been depicted in an IS context. Although we do not purport to give a complete analysis of all persona cases evident in the literature, we have sought to explore how and why personas emerged in IS, and the dominant role they are seen as having in relation to technology; specifically software design and its usage.

### **3 Personas in Information Systems (IS)**

In business, personas are said to have originated in marketing with a focus on customers as targeted demographics (e.g. Sissors 1966). Later, these roles were reversed in which consumer insights came first and personas were created to help guide marketing decision-making (Upshaw 1995). For IS specifically, personas have been re-imagined from their marketing origins to serve as a theoretical underpinning to “design thinking” in systems design processes (Cooper 1999). What this persona underpinning achieved was an ability to represent technology end users in a more realistic manner (Mulder and Yaar 2006).

The reason for this was seen as a result of the limitations associated with previous approaches, in which end users were often abstracted or omitted from systems design activities. For example, scenario planning was often used based on a task-fit logic; one which aimed to dictate computer interaction, rather than explore current contexts of targeted end user behaviour (Carroll 1995). Other examples of user profiles (Hackos and Reddish 1998), user roles (Constantine 2006) and user archetypes (Mikkelsen and Lee 2000) followed a similar mode of thinking, as software was often designed based on abstractions made about intended users, whilst technological goals remained front and centre. This persona shift has been noted for making designed products or services more successful, as the design serves the needs of users rather than satisfy the goals of designers (Abrams et al. 2004).

Accordingly, personas have been positioned as tools to help combat issues associated with IS utility and systems failure outcomes (Brickey et al. 2012); based on the premise that personas can be substitutes for real end users. What is also evident, however, are the two beliefs associated with the conflicting views of mimesis; of whether personas are in fact imitations of users, or whether the personas are meaningful interpretations in their own right, with the ability to help designers in their systems design processes.

#### **3.1 Representing End Users or Tools for Designers?**

In contrast to earlier methods, personas were seen as offering a more realistic approach to understanding end users, achieved through the capturing of actual user insights as collated from various data sources. Originally, personas were an ethnographic endeavour comprising of qualitative approaches of participant observation and interviews (Cooper et. al 2007). However, multiple data gathering methods for persona creation have since been articulated. Mulder and Yaar (2006) even argue that both qualitative and quantitative measures should be used, with types ranging from surveys and

market research reports (Pruitt and Grudin 2003), user diaries (Kantola et. al 2007), job profiles (O’Flaherty et al. 2013), or even capturing existing log data from in-use systems (Mesgari et. al 2015).

The emphasis on data collected about end user behaviour, and user activities, can be interpreted as a desire to represent the “object” of the end user. What is indicative in such data approaches is the focus on capturing factual or historical data about what end users do and say. Minimal attention is given to understanding the “lived world” of an end user or what they do or think beyond factors associated with their “role”. Arguably, if personas were in fact intended to represent end users, one could assume that end users would be able to comment, or provide feedback on, the personas made in their image. This, however, does not seem to occur. Instead, personas are positioned as being meaningful for the designers. For example, personas are often used as communication devices during brainstorming sessions (Jansen et. al 2013), as artefacts to help guide or inform decision-making, or as an avenue to help test and evaluate aspects of user and task performance on the designed system (Pruitt and Adlin 2006).

Furthermore, emphasis is firmly on systems design rather than the holistic use context, despite the fact end user challenges exist beyond a technology’s design; such as problems associated with the technology’s introduction and integration with existing work and infrastructure (Chapman and Milham 2006). What this means is that although personas might be created based on the assumption of portraying end users, their use seems to be specific to the work of designers in system creation processes.

Interestingly, one ethnographic study noted that despite the effort put into creating personas, one team’s personas did not play a direct role in the decision-making for the technology being designed (Friess 2012). This does not necessarily indicate anything specific about the personas, the technology in question, or the intended end users, but instead brings to the fore issues concerning the relationship and the differences between personas and real people. In such examples, Turner et. al (2014) implies that the mere presence of personas might simply serve as scenario-planning instigators – allowing designers to pretend or imagine the “what ifs” of the system they are trying to design for “real world” application.

What this establishes is contemplation for whether personas are really about representing end users, or whether they are merely another tool in a designer’s arsenal. However, the view of personas as being imitations of actual end users seems to be the favoured approach. In fact, according to Miaskiewicz and Kozar (2011), personas are seen as suffering from a lack of empirical grounding, as variances in method for their creation and use are evident across examples; implying that these are the reasons why persona theorising is difficult. It therefore seems necessary to explore the different persona types, for which Nielsen (2013) claims there are four as being evident across influential works.

### **3.2 Persona Types and Intended Outcomes**

Although personas can be created with or without end user data, the number of personas created, the content that is included in them, and the narratives that take the persona characters on a journey, are all seen as being to the detriment of the design team (Nielsen 2013). This can include, depending on the lifetime of the project, the need to revise personas to ensure they are still “relevant” based on any end user changes. However, in outlining the four most prominent persona types, it is clear that their focus aligns to capturing the characteristics of both users and technology. In the first goal-oriented type, personas focus on supporting users in achieving their goals on or with a particular technology (e.g. Cooper 1999). For example, one case used personas in designing driver assistance systems, such as cruise control and parking assist, relative to different (persona) driving types (Lindgren et. al 2007).

As a second approach, role-based personas focus on an end user’s position (role) in a social or an organisational context (e.g. Pruitt and Grudin 2003). For example, a predictive analytics cloud service application depicted personas as representing different user roles which were indicative of business goals associated with employee job types (O’Flaherty et. al 2013). In the third approach, personas can be seen as “engaging” creations, ones which emphasise the narrative story that helps designers understand the traits of targeted end users, either via a narrative created by designers, or by data being captured that allows end users to tell their own story. Lastly, there are also fictitious personas, created as imagined or targeted end users, often without any formalised data process involved (Pruitt and Adlin 2006). However, such fictitious characters are still seen as helping to design for “someone” in mind.

What all four examples do is present a dualism between technology and end users; implying that characteristics of end users can be captured and matched with characteristics of technology. In this vein, personas as imitative acts seem to be the dominant stance, as personas are depicting “users” who are intended to “use” technology as it has been designed for them. Where this dominant imitation view comes unstuck, we argue, is in relation to malleable end user software (MEUS).



## 4 Problematizing Personas in relation to MEUS

Compared to more purpose-specific end user software (PEUS), the use and application of MEUS is indicative of social processes, rather than technological features (Richter and Riemer 2013). The malleability of the technology means that usage cannot be known a priori, and any intended usage outcomes will likely deviate given the often social and interactive nature of such technologies (Dourish 2003). Even in PEUS contexts, usage in-practice has still been known to deviate from intended end user interaction (e.g. Arvidsson et. al 2014). Reasons for this are often explored from a social practice perspective, in which end users will still need to find a way to integrate new technology into their existing practices (Visconti 2010). Despite how the technology has been designed and for what purpose, usage becomes context dependent, as not all technological “features” will be relevant to all users.

Discussions concerning the people and technology relationship have been ongoing in IS for many years. Two dominant ontologies are seen to be at play (e.g. Riemer and Johnston 2014); one which supports the dualism between people and technology, and one which supports their inseparability. Although such an exploration is beyond the scope of this paper, the two views of mimesis also align to such distinctions. The imitative form clearly separates persona from technology usage, whilst the hermeneutic stance sees the act of persona creation as something that already constitutes a people-technology inseparability; as already in-use technologies are inseparable from, and form an integral part, of their respective persona.

Where this hermeneutic view makes more sense, in relation to personas and end user outcomes, can be seen with enterprise social networking (ESN) platforms. As a type of MEUS, a platform’s success is seen as being highly context-dependent in its usage with end users. The same ESN, for example, can be introduced in two different organisational settings and yet have very different usage outcomes (Mettler and Winter 2016). End users are seen as having to make sense, for themselves, of what role this technology will play in their work. The voluntary nature of ESN means that its purpose is specific to users, and its success is driven by them (Kumar et. al 2016). Although technological design might play a role with usage, such features like “blog” or “wiki” do not automatically dictate what will be published on the platform, or who will engage with content (Dix 2007). In translation, neither end users nor designers can know what outcomes or purposes social technology will result in until usage takes place.

If anything, the design of social technology is what allows for this unexpected usage to take place, as the malleability means that usage can be reimagined over time and contexts. For example, the notion of secondary design has been discussed in tailorable technology examples (e.g. Germonprez et. al 2011), in which end user participation on a designed system can still result in changes to how the system functions, which in turn influences how content on that system becomes created and perceived by users. These types of observations were not foreseen or pre-empted by designers. What this suggests is that given the dominant portrayal of personas as being tools for achieving a technological outcome, and MEUS cannot have its end user outcome known a priori, the presence of personas in MEUS contexts offers a mystery to be explored (Alvesson and Kärreman 2007). In the following, we outline such a case.

## 5 The Ripple Effect Group (REG)

The Ripple Effect Group (REG) are a Sydney-based consultancy who specialise in connecting people with technology; predominately in digital workplace contexts. In taking a user-centred design approach, REG work with a variety of client organisations predominately on projects concerning MEUS. This can be in relation to technology implementation, designing solutions for community management of such software, or helping to address problems relating to MEUS use and integration within organisations. The REG Managing Director has had a long-standing relationship within our University context, for which the first author has an embedded relationship with their practice. In the following, an auto-ethnographic account is given by the first author in this role.

### 5.1 Auto-ethnography of the REG Practice

I have been “embedded” in the REG practice since March 2016. Originally used in journalistic settings (McGinity and Salokangas 2014), researcher embeddedness is an approach for exploring empirical practices in an ethnographic capacity. This means I play a dual practitioner-researcher role with REG in that I act as a “consultant” when I accompany them on client projects, and then act in the role of “researcher” when in-house. What this dual role has allowed me to do is learn the REG practice through a process of “doing”, as well as learn about the issues and problems REG practitioners face across their client projects (Hardwicke 2017). Since my commencement, I have accompanied REG across several different client projects. Furthermore, as a result of being embedded, I have access to the REG internal

systems. This means that any work conducted by REG during or prior to my engagement with them is stored on their systems, which I am able to access and inquire about at any time.

In each of the client projects I have been involved with, REG have enacted their “Head Start” method. This is a framework that helps guide clients through the intended approach REG will take for engaging with the client’s workforce. In such projects, the clients have come from enabling business functions, such as human resources. Such functions have the benefit of being aligned to senior management and have visibility of their organisation’s breadth. In each project, the client wanted their employees “communicating and collaborating” on ESN, yet in all cases, REG stated that their main contribution would be the creation of “authentic personas”; presented as a cast of six. The justification for this number is based on a soap opera analogy. Clients are encouraged to think of their favourite television show and its main characters – the idea being that the world the show is situated in, and the supplementary characters who comprise that world, are brought to life through the lens of the six as the main cast.

In order to foreground the REG persona approach, generic processes will be discussed in the following sections. This is in terms of how data is collected, interpreted, and transformed into the cast of personas. Of course, in providing an auto-ethnographic account, my own interpretation comes to the fore in how I have arrived at my understanding of the REG persona process and the intent behind their creation and use. However, given my embedded involvement, my understanding of personas has been the result of a longitudinal and ethnographic relationship with the REG practitioners. What this has meant is that my understanding is the result of being involved in these persona projects, and being able to ask, in-house, what is being done and why; including permission and feedback in writing this very paper.

## 5.2 Data Collection Processes

The REG Head Start method comprises two phases. The first phase includes initial project management and scope meetings with the client practice, which is then followed with preliminary engagements with the client’s organisational employees. The initial project meetings help the REG practitioners learn about the client’s problem and what they hope to achieve by engaging the REG practice. The client practice is also responsible for arranging access to organisational employees for the REG practitioners to engage with. REG seek to meet and speak with a range of employees from different departments in order to learn what the organisation looks like from different employee perspectives. As part of phase one, REG conduct interviews, site visits, and workshops with such employees. The questions that are asked in interviews, and the activities conducted in workshops, often relate to aspects of what the client hopes to achieve – to gauge how employees perceive the same organisational problem as the client does.

Insights captured from these first phase activities then aid in helping the REG practitioners come to an emerging understanding about the various points of view that exist across the organisation, and to make sense of the organisational culture. A debrief report about this phase is given to the client practice to disclose emerging themes, as well as to outline phase two. In phase two, more designed-focus activities take place in workshops and webinars. This can include “draw your metaphorical workplace”, card sorting activities in which participants choose, and then discuss, which five words best describe their organisation, as well as participants getting into groups and crafting their own raw persona. These personas are then transformed into medium-fidelity versions by the REG practitioners (Figure 1), which are then presented to the client practice for feedback.

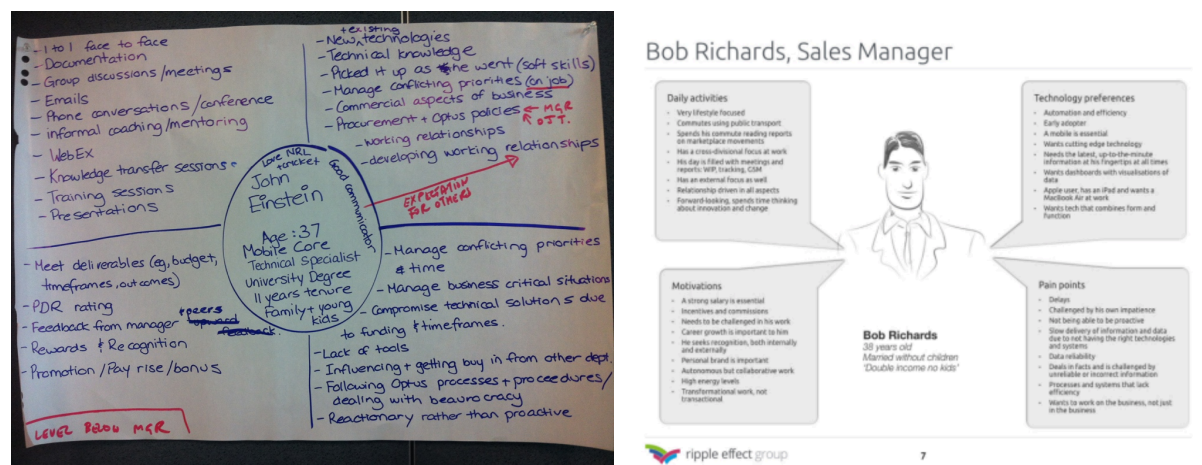

Figure 1: Raw and medium-fidelity persona examples (figure courtesy of The Ripple Effect Group)

### 5.3 The Role of Feedback

The presented draft personas represent how REG have interpreted key characters based on their amalgamated experience with, and their interpretation of, employee insights. The draft personas are presented to the client as a validation process prior to personas being finalised. In these validation workshops, REG say to their client, “This is what we have learnt, does this sound right?” This simple prompt encourages the client practice to interpret the presented personas for themselves and their own working practice. This can also mean that client members ask about any information that might be missing from personas, inquire about insights captured, or make a number of comments and questions relating to what is portrayed about each persona.

This feedback is important for two primary reasons. Firstly, and as previously mentioned, the client practice has the benefit of organisational breadth; meaning they are expected to “know” who the organisation’s employees are, what these employees do, and the tools and systems these employees work with. However, what is often presented to clients via feedback can be new information to them. For example, in one case, the client was shocked to learn that employees were already using shadow IT for their social networking purposes. In another case, the client saw the draft personas as missing a key demographic that needed to be captured. In such contexts, feedback becomes necessary for ensuring certain aspects of the organisation are represented through the cast of six personas.

The second reason for this feedback process is to instigate learning and reflection for the client practice themselves. Although they are positioned as being an enabling business function for their organisation, often what the REG practitioners present can seem new or surprising to the client practice. In this vein, the feedback can prompt them to reflect on their practices in order to better understand the targeted “end users” they are trying to make communicate and collaborate with one another. After this feedback process, the REG practitioners finalise the personas and create their six-character high-fidelity persona deck. User journey stories, or created narratives, are written for each persona (Figure 2).

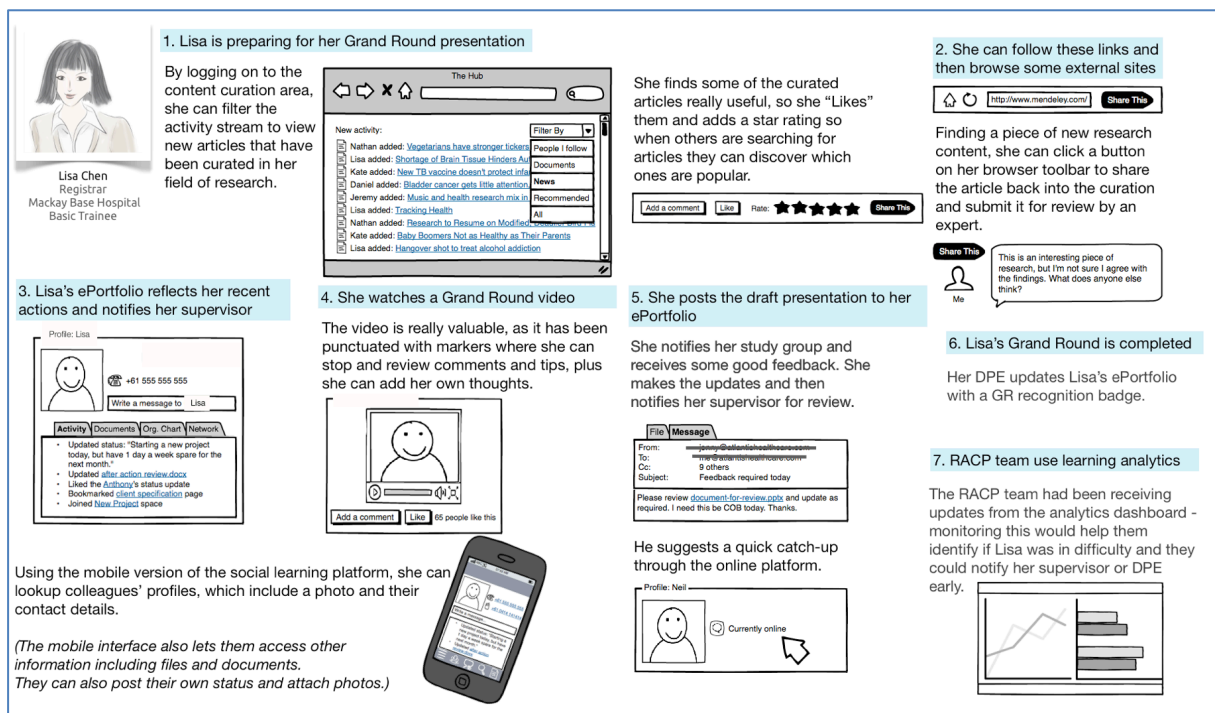

Figure 2: Example of a persona and their story  
(figure courtesy of The Ripple Effect Group)

Personas themselves portray such things as background information regarding personal life, goals and motivations, in-use devices, resources, the people in their broader network, and attitudes towards technology. The stories crafted for each persona are intended to demonstrate how different employees interact and share content; the idea being that by understanding each persona the client practice can gain a sense of empathy for their organisational employees. Technology recommendations then accompany the personas, which are positioned towards the client practice – of how they can better enable employees in the context of what currently is versus what could be in the digital workplace.

## 5.4 Personas and Technology

In addition to the work REG do with the client practice and organisational employees, a technology review also takes place. The REG practitioners will liaise with their client's IT representative, and in turn learn about current tools and systems in place. What this enables REG to do is make IT assumptions, and understand constraints, for what they can recommend to their client. However, such recommendations are not intended to be about implementing or imposing technology onto end user employees. Instead, the personas are used as the justification for REG practitioners outlining what the client practice needs to do to better support employees in their current communication and collaboration activities, for which in-use technologies are already evident, but for which future systems could be possible, or already planned by IT.

In more recent client contexts, future state scenarios have also been created, which have showcased how the cast of personas would likely interact and correspond to initiatives as instigated by the client practice enacting such recommendations. The group stories, presented as future-state scenarios, portray how the personas might act as a result of new technology, such as an ESN platform, being present inside the organisation. However, instead of depicting how personas would "use" such technology, the scenarios focus on potential outcomes, such as how personas might change to incorporate this technology into their working practice, and what the client practice could do to support such change.

The future state narratives are used to convey what "could be" as a result of the client practice changing. In such projects where the introduction of an ESN platform is considered, REG will position it to the client practice as a framework for consideration, outlining how technical aspects need to be considered, but that the platform itself needs to be understood from the stance of how personas (employees) will likely come to network and engage with one another both on and off the platform. Therefore, such recommendations are not about imposing technology onto "end users", but are more often about developing the digital knowledge and capabilities of the client practice; demonstrating how their own changes can empower the employees they work to enable.

## 6 Analysis: What REG's use of personas reveals

What is evident, in the REG personas, is that they share many similarities and characteristics with the personas portrayed in the IS literature. However, there are some fundamental differences, which we will explore in relation to three key deviations.

The first deviation lies in how the personas are created, including the data that is captured and the role of feedback. Unlike traditional persona approaches, as evident in the literature, the REG practitioners conduct certain activities as a way to get client employees to reveal insights about themselves and their organisation. The first phase of the Head Start method helps the REG practitioners make sense of the client and the organisational context they work in. This includes gauging perceptions for how different employees perceive the client's communication and collaboration problem. In this approach, the emphasis is not about "capturing" data or insights about end users, but is about REG learning about their client and the context they work in.

It is then through the more design-focused second phase activities that "data" is captured for personas. However, this again is not about capturing the factual properties or behaviours of employees as end users of technology. Instead, by getting employees to design their own personas, or by having them draw and discuss their metaphorical workplace, what is conveyed reveals current attitudes and perceptions, allowing employees to express their frustrations and desires about their current working lives. Such insights are captured, but are then interpreted, by the REG practitioners. This interpretation is expressed via their creation of medium-fidelity personas, which are presented to the client for their own learning and reflection. What is emphasised here is the focus on understanding and developing shared meaning for organisational perceptions, rather than capturing end user characteristics.

This then foregrounds the second area in which the REG personas deviate from established persona norms, which concerns multiple interpretations being embraced. Although clients initially come to REG with a problem in mind, which they want solved with social technology, the client problem itself becomes problematized as the REG method unfolds. Throughout the various activities and engagements REG undertake, including IT assessments, different employee "worlds" emerge (Riemer and Johnston 2017). What is meant by this is that depending on where employees work, and the work they do, different technologies are seen to be in-use; along with different attitudes and perceptions about the organisation. What this means for social technology specifically, as REG still need to deliver on their contractual obligation, is that the emphasis is not on a specific platform or technology solution. Instead, persona

narratives embrace the organisation at the here-and-now, and technological change is viewed as something integrated into existing employee worlds.

Such an approach arguably aligns with the nature of social technology. The personas are not intended to be positioned to the client practice as a way that tells them how they can get their “end user” employees “using” social technology. Instead, the personas are positioned to the client as a way for them to understand the employee-technology relationship. The idea that is portrayed to the client is that they can become “community managers” for supporting the different ways employees work, rather than imposing a work style or a technology onto employees. This organic approach in enabling the client foregrounds the third persona distinction; which concerns the intent behind the personas.

Unlike traditional personas, which are intended to help systems designers achieve a technological end, the REG personas are firmly positioned towards their client’s learning, and the client themselves as needing to change; not the organisation’s employees. This is achieved by REG creating personas and their narratives, via various processes of interpretation, with the final product presented back to the client. The client must then interpret, for themselves, what REG have interpreted as expressed in their final persona deck and accompanying group story. A double hermeneutic process can thus be observed, for which referral back to Gadamer’s (1975) hermeneutic view of mimesis becomes relevant.

## 7 Discussion: Personas as Hermeneutic Representations

The collective narrative story that a cast of personas tells can be viewed as a performance; one which encourages the client group, as the audience, to reflect on the conceptions behind the performance (Gadamer 1975). As the narrative persona story is being told to the client, the focus shifts away from a people-technology emphasis, and instead moves towards interpretation for the client group. Gadamer discusses this in the context of a story as *moving* its characters, for which any subject-object (user-technology) distinction becomes obsolete, as the entangled world of the story is brought to life as the audience encounter and interpret the story’s holistic unfolding.

In the REG-client context, each persona is their own character, yet it is only because of the relationship personas have with each other, as part of their shared story, that any meaning from the characters (personas) can be interpreted. This shifts away from personas as imitating reality, and instead moves towards personas as enabling hermeneutic reflection; in which the client’s problem, of wanting to have employees “communicate and collaborate”, is transformed as its assumptions are re-evaluated. As Gadamer puts it, the message that is conveyed via the performance of characters is a message not explicitly stated. The personas are not being positioned to the client group as a way that tells them how they can get their employees to “use” social technology, but are instead about conveying meaning to the client through a creative disguise; a meaning concerning a reinterpretation of employee worlds, as the interpretation relates to the client group and their re-examination of their original request.

Therefore, what a hermeneutic view on personas offers is something different from both a practical and theoretical stance. From a practical perspective, the REG authentic personas do not seek to capture employee realities, but instead acknowledge, and seek to understand, the different employee worlds as they are experienced and interpreted. This is necessary in relation to MEUS, as its usage reflects social processes, and the malleability of the technology means it can be reimagined and used in unexpected ways; making the emphasis of positioning the personas to the client as a way for the client to support such flux. From the theoretical perspective, personas and their stories enable interpretation of technology inseparability. Each persona embodies an existing technology relationship, and the shared story the personas tell conveys an enmeshed context. What can be inferred from this are personas as a question of meaning; one that is specific to both time and context. It is a meaning intended to instil learning and reflection about technology, rather than achieve a technological end, by the client group.

## 8 Conclusion

What we have foregrounded in this paper invites the need for different theorizing towards personas in information systems contexts. By using mimesis as a lens, we have discussed how personas can become tools for interpretation and understanding, rather than mere imitations of real or targeted technology end users. In this vein, what a hermeneutic approach of personas offers, compared to conventional persona wisdom, is an emphasis on interpretation and meaningful reflection. This, we argue, is necessary in social technology contexts in order to embrace the different worlds of people who need to find meaning and purpose for the technology for themselves, rather than have a technology solution imposed onto them as mere “users”.

## 9 References

- Abras, C., Maloney-Krichmar, D., and Preece, J. 2004. "User-Centered Design," in *Encyclopedia of Human-Computer Interaction*, pp. 763–767.
- Alvesson, M. and Kärreman, D. 2007. "Constructing mystery: Empirical matters in theory development," *Academy of management review*, 32(4), pp.1265-1281.
- Arvidsson, V., Holmström, J. and Lyytinen, K., 2014. "Information systems use as strategy practice: A multi-dimensional view of strategic information system implementation and use," *The Journal of Strategic Information Systems*, 23(1), pp.45-61.
- Brickey, J., Walczak, S., and Burgess, T. 2012. "Comparing Semi-Automated Clustering Methods for Persona Development," *IEEE Transactions on Software Engineering*, (38:3), pp. 537–546.
- Carroll, J. M. 1995. *Scenario-Based Design: Envisioning Work and Technology in System Development*, Hoboken, NJ, USA: Wiley Publishing.
- Chapman, C. N., and Milham, R. P. 2006. "The Personas' New Clothes: Methodological and Practical Arguments against a Popular Method," in *Proceedings of the Human Factors and Ergonomics Society 50th Annual Meeting*, San Francisco, CA, USA, pp. 634–636.
- Clarke, R. 2014. "Persona missing, feared drowned: the digital persona concept, two decades," *Information Technology & People*, 27 (2), pp.182-207.
- Constantine, L. 2006. "User, Roles, and Personas," in *The Persona Lifecycle: Keeping People in Mind Throughout Product Design*, J. Pruitt and T. Adlin (eds.), San Francisco, CA, USA: Morgan Kaufman Publishers, pp. 498–519.
- Cooper, A. 1999. *The Inmates Are Running the Asylum: Why High-Tech Products Drive Us Crazy and How to Restore the Sanity*, Carmel, IN, USA: Sams Publishing.
- Cooper, A., Reinmann, R., and Cronin, D. 2007. *About Face 3: The Essentials of Interaction Design*, Indianapolis, IN, USA: Wiley Publishing.
- Dittmar, A., and Hensch, M. 2015. "Two-Level Personas for Nested Design Spaces," in *Proceedings of the 33rd ACM Conference on Human Factors in Computing Systems*, pp. 3265–3274.
- Dix, A. 2007. "Designing for appropriation," In *Proceedings of the 21st British HCI Group Annual Conference on People and Computers: HCI*, Volume 2 (pp. 27-30). British Computer Society.
- Dotan, A., Maiden, N., Lichtner, V. and Germanovich, L. 2009. "Designing with only four people in mind. A Case Study of Using Personas to Redesign a Work-Integrated Learning Support System," *Proceedings of the 12th IFIP TC*, 13, pp.24-28.
- Dourish, P. 2003. "The Appropriation of Interactive Technologies: Some Lessons from Placeless Documents," *Computer Supported Cooperative Work (CSCW)*, vol. 12, no. 4, pp. 465-490.
- Friess, E. 2012. "Personas and decision making in the design process: an ethnographic case study," In *Proceedings of the SIGCHI Conference on Human Factors in Computing Systems*, (pp. 1209-1218). ACM.
- Gadamer, H.G. 1975. *Truth and Method*, trans. Garrett Barden and John Cumming. New York: Crossroad.
- Germonprez, M., Hovorka, D. and Gal, U., 2011. "Secondary design: A case of behavioral design science research," *Journal of the Association for Information Systems*, 12(10), p.662.
- Grudin, J. 2006. "Why Personas Work: The Psychological Evidence," in *The Persona Lifecycle: Keeping People in Mind Throughout Product Design*, J. Pruitt and T. Adlin (eds.), San Francisco, CA, USA: Morgan Kaufman Publishers, pp. 642–663.
- Hackos, J. T., and Redish, J. C. 1998. *User and Task Analysis for Interface Design*, Hoboken, NJ, USA: Wiley Publishing.
- Hardwicke, N. 2017. "Practices in Juxtaposition: Tensions in social software appropriation projects", in *Proceedings of the 28th Australasian Conference on Information Systems (ACIS 2017)*, Australasian Association for Information Systems, Hobart.
- Herskovitz, S., and Crystal, M. 2010. "The essential brand persona: storytelling and branding," *Journal of Business Strategy*, (31:3), pp. 21–28.

- Hopcke, R.H. 1995. *Persona: Where sacred meets profane*. Shambhala Publications.
- Hussain, M. and Skillicorn, D.B. 2008. "Persona-based identity management: A novel approach to privacy protection," *In Proceedings of the 13th Nordic Workshop on Secure IT Systems* (pp. 201-212).
- Jansen, A., Sulmon, N., Van Mechelen, M., Zaman, B., Vanattenhoven, J., and De Grooff, D. 2013. "Beyond the Familiar? Exploring Extreme Input in Brainstorms," *in Proceedings of the 31st ACM Conference on Human Factors in Computing Systems*, Paris, France, pp. 1347-1352.
- Kantola, V., Tiitta, S., Mehto, K., and Kankainen, T. 2007. "Using Dramaturgical Methods to Gain More Dynamic User Understanding in User-Centered Design," *in Proceedings of the 6th ACM Conference on Creativity & Cognition*, Washington, DC, USA, pp. 173-181.
- Kumar, V., Loonam, J., Allen, J.P. and Sawyer, S. 2016. "Exploring enterprise social systems and organisational change: implementation in a digital age," *Journal of Information Technology*, vol. 31, no. 2, pp. 97-100.
- Lindgren, A., Chen, F., Amdahl, P. and Chaikiat, P. 2007. "Using personas and scenarios as an interface design tool for advanced driver assistance systems," *In International Conference on Universal Access in Human-Computer Interaction*, (pp. 460-469).
- Long, F. 2009. "Real or imaginary: The effectiveness of using personas in product design," *In Proceedings of the Irish Ergonomics Society Annual Conference*, (Vol. 14). Irish Ergonomics Society.
- McGinity, R. and Salokangas, M. 2014. "Introduction: 'embedded research' as an approach into academia for emerging researchers," *Management in Education*, vol. 28, no. 1, pp. 3-5.
- Mesgari, M., Okoli, C., and Ortiz de Guinea, A. 2015. "Affordance-based User Personas: A mixed-method Approach to Persona Development," *in Proceedings of the 21st Americas Conference on Information Systems*, Fajardo, Puerto Rico, pp. 1-17.
- Mettler, T. and Winter, R. 2016. "Are business users social? A design experiment exploring information sharing in enterprise social systems", *Journal of Information Technology*, vol. 31, no. 2, pp. 101-114.
- Miaskiewicz, T., and Kozar, K. A. 2011. "Personas and user-centered design: How can personas benefit product design processes?," *Design Studies* (32), pp. 417-430.
- Mikkelsen, N., and Lee, W. O. 2000. "Incorporating User Archetypes into Scenario-based Design," *in Proceedings of the 9th Annual Usability Professionals' Association Conference*, Asheville, NC, USA.
- Mulder, S., and Yaar, Z. 2006. *The User Is Always Right: A Practical Guide to Creating and Using Personas for the Web*, Berkeley, CA, USA: New Riders.
- Nielsen, L. 2013. "Personas," *in Encyclopedia of Human-Computer Interaction*, M. Soegaard and R.F. Dam (eds.), pp. 2039-2092.
- O'Flaherty, B., Thornton, C., Pope, A., and Woodworth, S. 2013. "Capturing multi-stakeholder needs in Customer-Centric Cloud Service Design," *in Proceedings of the 34th International Conference on Information Systems*, Milan, Italy, pp. 1-15.
- Pruitt, J., and Adlin, T. 2006. *The Persona Lifecycle: Keeping People in Mind Throughout Product Design*, San Francisco, CA, USA: Morgan Kaufman Publishers.
- Pruitt, J. and Grudin, J. 2003. "Personas: practice and theory," *In Proceedings of the 2003 conference on Designing for user experiences*, (pp. 1-15). ACM.
- Richter, A. and Riemer, K. 2013. "Malleable end-user software," *Business & Information Systems Engineering*, 5(3), pp.195-197.
- Riemer, K. and Johnston, R.B. 2014. "Rethinking the place of the artefact in IS using Heidegger's analysis of equipment", *European Journal of Information Systems*, vol. 23, no. 3, pp. 273-288.
- Riemer, K. and Johnston, R.B. 2017. "Clarifying Ontological Inseparability With Heidegger's Analysis Of Equipment," *MIS Quarterly*, 41(4).

- Schultze, U., Nardi, B., Rennecker, J., Stucky, S., and Hiltz, S. 2007. "Using Massively Multi-Member Online Worlds for Work and Education," in *Proceedings of the 28th International Conference on Information Systems*, paper 156.
- Sissors, J. Z. 1966. "What Is a Market?," *Journal of Marketing*, (30:3), pp. 17–21.
- Turner, P., Turner, S., and Carruthers, L. 2014. "It's Not Interaction, It's Make Believe," in *Proceedings of the 2014 European Conference on Cognitive Ergonomics*, paper 22.
- Upshaw, L. B. 1995. *Building Brand Identity: A Strategy for Success in a Hostile Marketplace*, Hoboken, NJ, USA: Wiley Publishing.
- Visconti, L.M. 2010. "Ethnographic Case Study (ECS): Abductive modeling of ethnography and improving the relevance in business marketing research," *Industrial Marketing Management*, vol. 39, no. 1, pp. 25-39.

## Acknowledgements

Natalie was an exceptional student, thinker and human being. Far too early, suddenly and unexpectedly Natalie passed away while this paper was under review. Natalie leaves a legacy of ideas and research that remains unfinished. This paper marks an important milestone in rethinking the ways in which malleable technologies can be introduced into organisational environments not prepared for such malleability. Hermeneutic personas play an integral part in this process. The Ripple Effect Group, who kindly gave permission for Natalie, as their embedded researcher, to use ethnographic accounts and the provided examples, and myself, as Natalie's supervisor, aim to continue this work. We will miss you, Nat.

## Copyright

© 2018 Natalie Hardwicke & Kai Riemer. This is an open-access article distributed under the terms of the [Creative Commons Attribution-NonCommercial 3.0 Australia License](https://creativecommons.org/licenses/by-nc/3.0/australia/), which permits non-commercial use, distribution, and reproduction in any medium, provided the original author and ACIS are credited.