

# THE MAYA TEMPLE-PALACE OF SANTA ROSA XTAMPAK, MEXICO

DOCUMENTATION AND RECONSTRUCTION OF FORM,  
CONSTRUCTION, AND FUNCTION

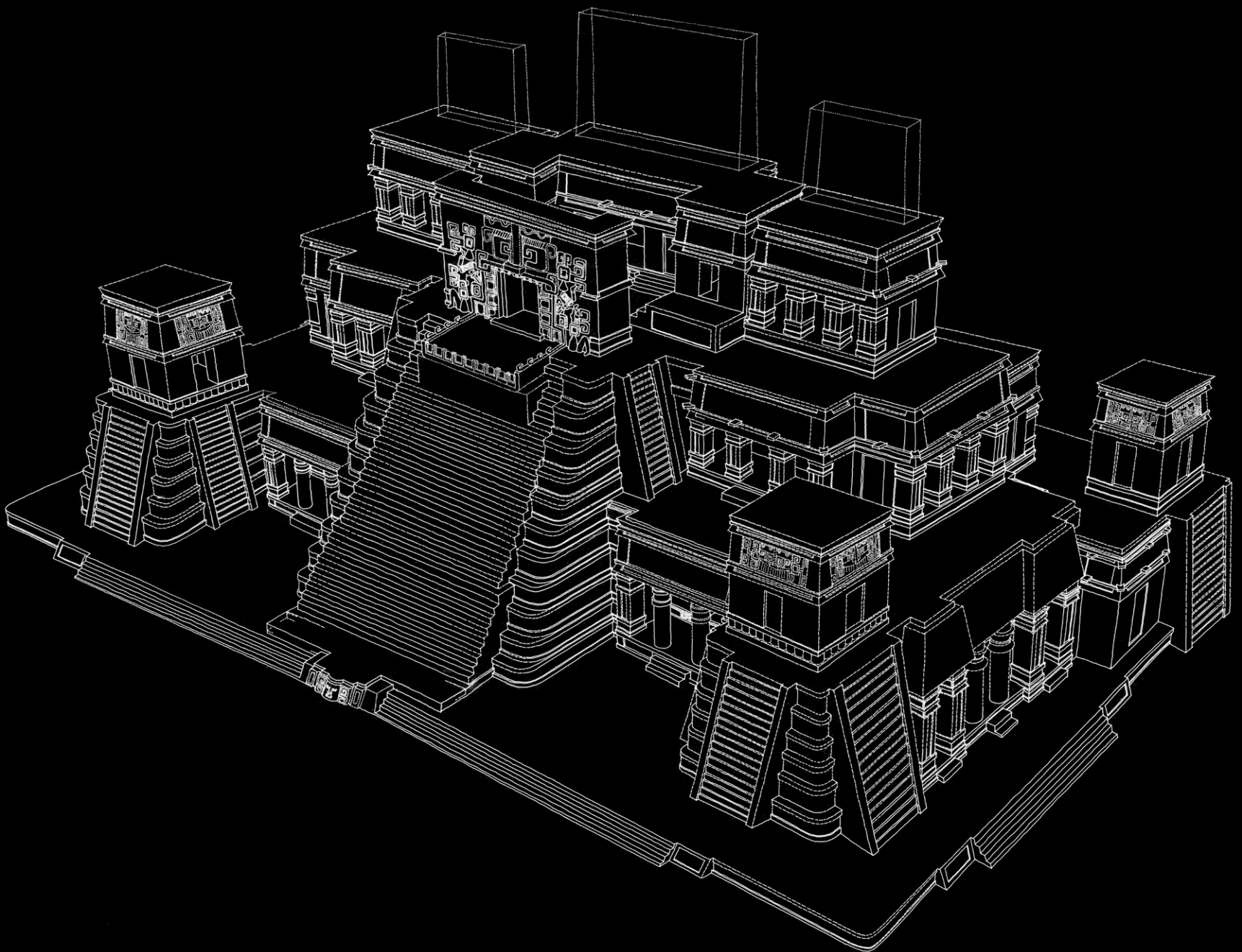

HASSO HOHMANN



# THE MAYA TEMPLE-PALACE OF SANTA ROSA XTAMPAK, MEXICO

DOCUMENTATION AND RECONSTRUCTION OF FORM,  
CONSTRUCTION, AND FUNCTION

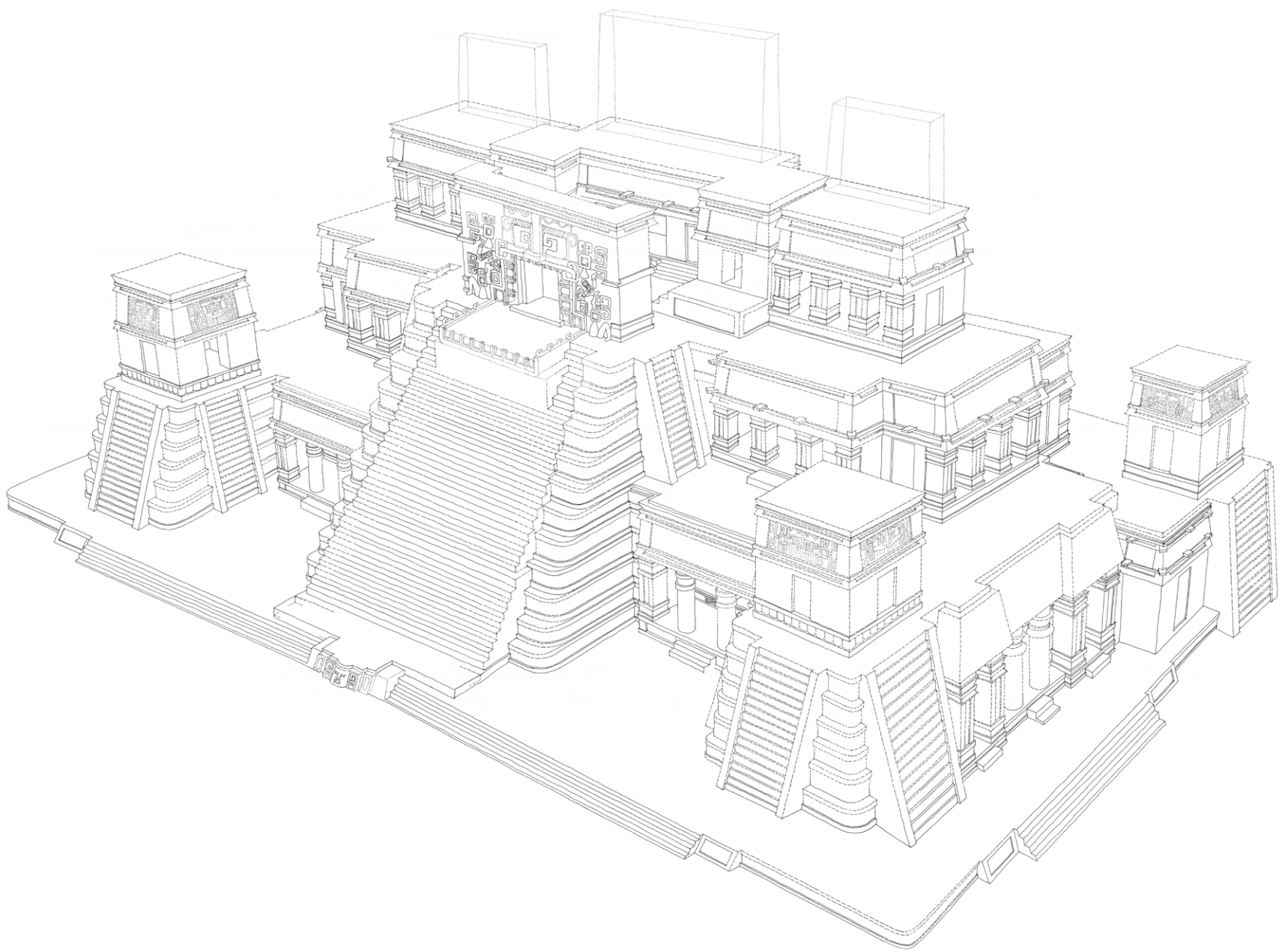

HASSO HOHMANN

Frontispiece:

Bird's-eye view from the Northeast. This perspective is the main view of the Palace, showing three of the four smaller temple pyramids at the corners of the Palace, the central "Pyramid" with Stairway A and the pseudo Stairway B together with the mega steps and the huge monster mouth passageway in front of the small courtyard on the third floor.

Back cover:

Bird's-eye view from the Southwest.

The documentation of the sections of the architecture of the Palace which still exist and are visible was the result of the geodetic survey which was carried out by Erwin Heine and Andreas Reiter. It was drawn and published in the doctoral thesis of Erwin Heine in 1997. This was the basis of the architectural documentation and of the reconstruction in this work.

Open access: Except where otherwise noted, this work is licensed under a Creative Commons Attribution 4.0 Unported License. To view a copy of this license, visit <http://creativecommons.org/licenses/by/4.0/>

Academic Publishers Graz  
Johann-Loserth-Gasse 16, A 8010 Graz  
ISBN 978-3-901519-44-4



© Verlag der Technischen Universität Graz 2017  
[www.ub.tugraz.at/Verlag](http://www.ub.tugraz.at/Verlag)  
ISBN print 978-3-85125-457-0  
ISBN e-book 978-3-85125-458-7  
DOI 10.3217/978-3-85125-457-0



Editor: Hasso Hohmann  
Drawings: Hasso Hohmann 2015, if not otherwise indicated.  
Layout: Martin Grabner in cooperation with Hasso Hohmann  
Proofreading: Sally Janschitz  
Druck: Medienfabrik Graz GmbH, Austria

For their kind support the author has to thank for:  
Fakultät für Architektur der Technischen Universität Graz and  
Austrian Science Fund (FWF): [Projektnummern: PUB 444-G25 and P 8928-GEO/PHY]



**FWF**

Der Wissenschaftsfonds.

DEDICATION

THE DOCUMENTATION, RECONSTRUCTION, AND ANALYSIS OF THIS  
FASCINATING TEMPLE-PALACE IS DEDICATED TO THE DESCENDANTS OF THE  
ANCIENT MAYA WHO PLANNED, DESIGNED, AND BUILT IT.  
ITS RECONSTRUCTION BY DRAWING SHOULD ALSO HELP TO RECONSTRUCT PART  
OF THE HISTORY AND IDENTITY OF THE MAYA

IN MEMORIAM GEORGE F. ANDREWS

# CONTENTS

<b>FOREWORD</b> .....	<b>7</b>	<b>ANALYSIS</b> .....	<b>90</b>	
<b>HISTORY OF RESEARCH</b> .....	<b>8</b>	<b>SPATIAL CONTEXT OF THE PALACE</b> .....	<b>90</b>	
THE AUSTRIAN PROJECT .....	17	<b>GENERAL CONCEPT FOR THE PALACE</b> .....	<b>90</b>	
NOMENCLATURES .....	18	Seven Temple Pyramids .....	90	
ORIENTATION OF THE PALACE .....	22	A Terraced Hill with Houses .....	92	
PRECISION OF THIS DOCUMENTATION .....	23	Function .....	92	
<b>DOCUMENTATION</b> .....	<b>24</b>	First Floor .....	94	
<b>DOCUMENTATION OF THE PALACE BY DRAWINGS</b>	<b>24</b>	Second Floor .....	95	
Maps and Plans .....	24	Third Floor .....	96	
Ground Plans .....	26	The General Form .....	96	
Façades and Sections .....	29	<b>FORM, CONSTRUCTION, AND FUNCTION OF</b>	<b>ARCHITECTURAL ELEMENTS OF THE PALACE</b> .....	<b>97</b>
<b>DESCRIPTION OF THE DIFFERENT ROOMS</b> .....	<b>59</b>	<b>FAÇADES OF THE PALACE</b> .....	<b>97</b>	
First Floor .....	59	Platforms .....	97	
Second Floor .....	71	Base Moldings .....	98	
Third Floor .....	79	Walls, Pillars, and Columns .....	98	
Additional Rooms on the Second Floor .....	82	Entrances and Pseudo Entrances .....	100	
Additional Rooms on the Third Floor .....	83	Façades of the Vault Zones .....	102	
<b>STAIRS OF THE PALACE</b> .....	<b>84</b>	Medial Moldings .....	102	
Comment .....	89	Painted Medial Molding Cornerstones .....	102	
		Façade Corbels .....	102	
		Upper Moldings .....	103	
		Roof Combs on the Palace .....	104	
		Stairways .....	106	
		Pseudo Stairways and Core Walls .....	106	

THE PALACE INSIDE .....	107	<b>COMPENDIUM .....</b>	<b>138</b>
Staircases .....	107	SUMMARY .....	138
Benches .....	107	ZUSAMMENFASSUNG .....	139
Passageways .....	110	RESUMEN .....	141
Over-Doorway Designs .....	110		
Niches .....	111	<b>APPENDIX .....</b>	<b>143</b>
Flat Niches with Reused Reliefs .....	111	ACKNOWLEDGEMENTS .....	143
Other Reused Relief Elements .....	116	GLOSSARY .....	144
Cord Holders .....	118	BIBLIOGRAPHY .....	146
Rod Sockets .....	120	THE AUTHOR .....	150
Lintels .....	121		
Lintels Strengthened by Beams .....	121		
Vaults .....	121		
Lower Vault Beams .....	122		
Pairs of Lower Vault Beams .....	124		
Pairs of Double Vault Beams .....	124		
Hammocks .....	125		
Upper Vault Beams .....	127		
Capstones .....	127		
Paintings .....	130		
Style and Age of the Palace .....	134		
<b>BUILDING MATERIALS .....</b>	<b>136</b>		
Stone .....	136		
Plaster .....	136		
Wood .....	136		

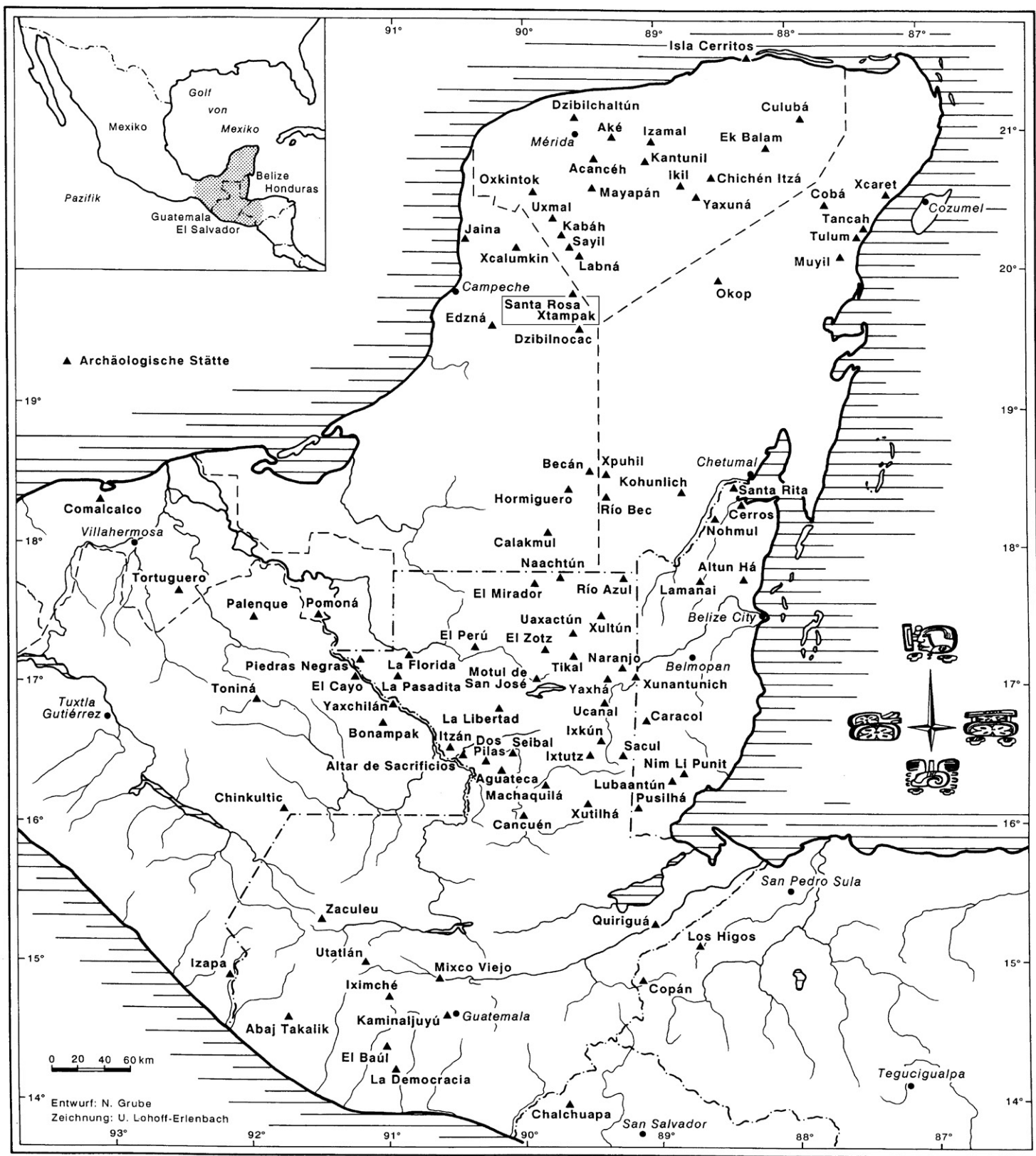

Fig. 1  
Map of Yucatán including the geographical position of Santa Rosa Xtampak in the Mexican State of Campeche near the border to Yucatán (Eggebrecht et al. 1994:42, fig. 33; design: N. Grube, drawing: U. Lohoff-Erlenbach)

Fig. 2  
Map of Santa Rosa Xtampak by Abel Morales López together with George W. Brainerd et al. and George F. Andrews (Morales López and Folan 2005:9, Fig. 4)



# FOREWORD

Santa Rosa Xtampak is an archaeological site of the Maya Classic period in the Northeast of the Mexican state of Campeche. The quite large ancient city is situated on a hill 26 km east of the modern village of Hopelchén and 98 km east of Campeche City. One of the most outstanding structures is a three-story high Palace, also called Structure 1. It is one of the most complex structures of all Maya Classic Period architecture.

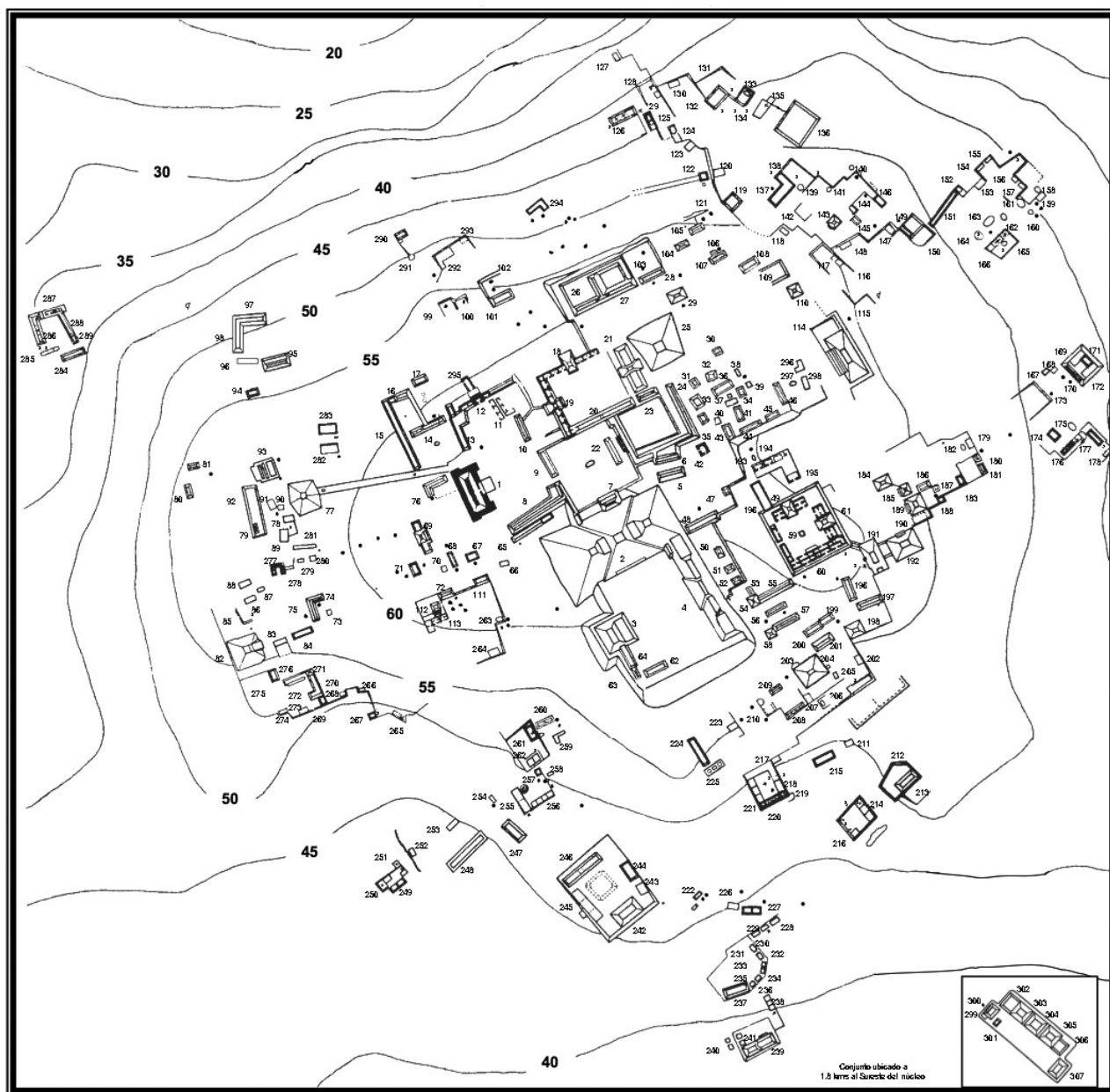

## HISTORY OF RESEARCH

John Lloyd **Stephens** and Frederick **Catherwood** visited the site as early as 1842 (Stephens 1843) and were possibly the first to report in detail on the Palace. Catherwood produced a ground plan of its first floor, a front view of the western façade and drawings of the three base reliefs within the Palace, one in the southern wall of Room 9 in the North and two in the northern wall of Room 1 in the South. At that time it was really difficult to reach and even harder to stay for some days in the forest around Santa Rosa Xtampak as there is no water there.

Teobert **Maler** failed to get to Santa Rosa Xtampak twice in 1887. In 1891 he reached the ruins and spent two and a half days there. The result was the first really good documentation of the architecture of the Palace (Maler 1902:226 and Maler 1997:210-217). His documentation includes plans, photographs and written information about the Palace and several other buildings of Santa Rosa. He mainly investigated the Palace. He gave a detailed description of the structure including wall paintings, produced ground plans of all three floors, a cross section and drawings of several details like the two interior staircases within the structure on its western side. All the plans were very detailed and drawn to scale. He also took several exquisite large scale black and white photographs. He must have worked extremely hard within the very short time.

Fig. 3

Catherwood only produced a ground plan of the first floor. He did not discuss the reconstruction of missing supports in Room 1 and in Room 9.

Drawing: F. Catherwood 1843

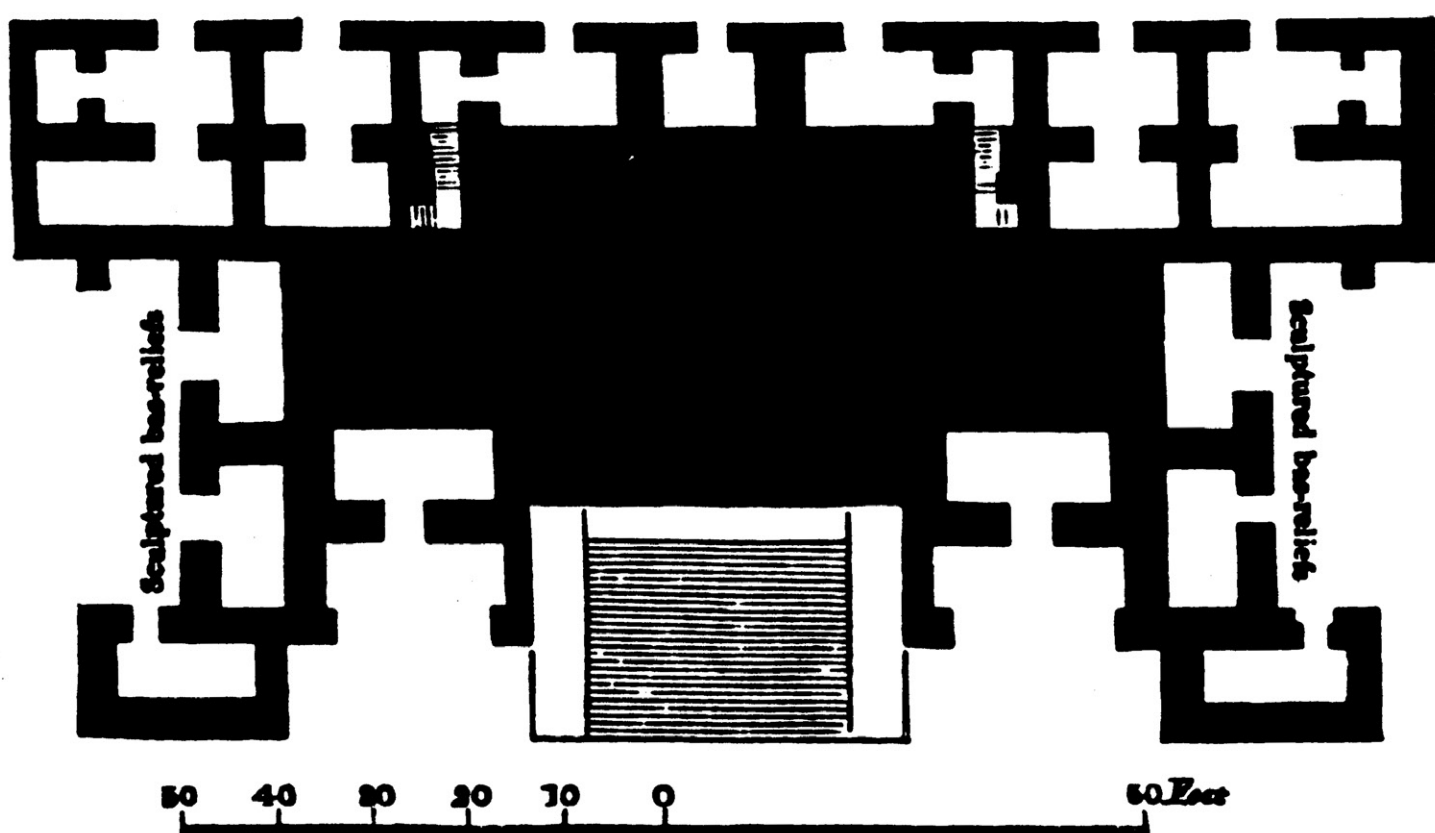

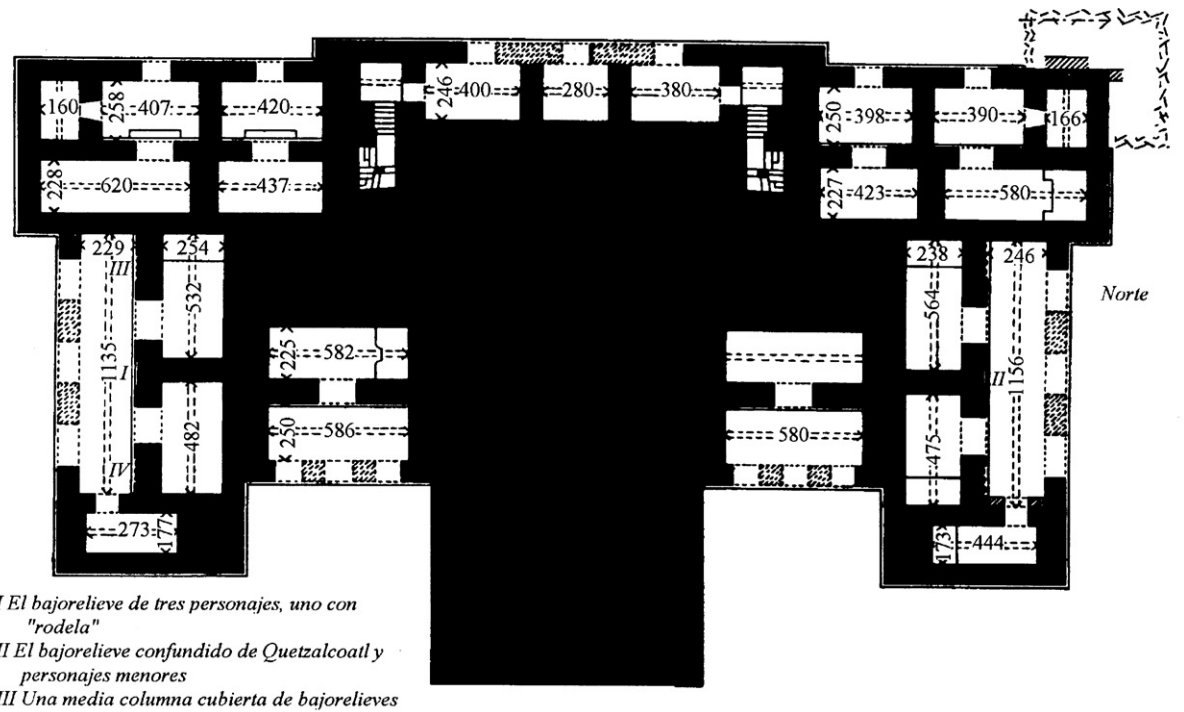

Fig. 4  
 The first floor; Teobert Maler tried to reconstruct missing supports at the Palace. His plans provide measurements and include vaults. The first floor ground plan also shows benches. Along the western façade he introduced a broad central risalit hypothetically, which does not really exist. He was the first to see the extension of the structure at the northwestern corner – the steep pseudo stairways leading up to Room 45, which was excavated by Zapata Peraza more than a hundred years later. Drawing: T. Maler 1891

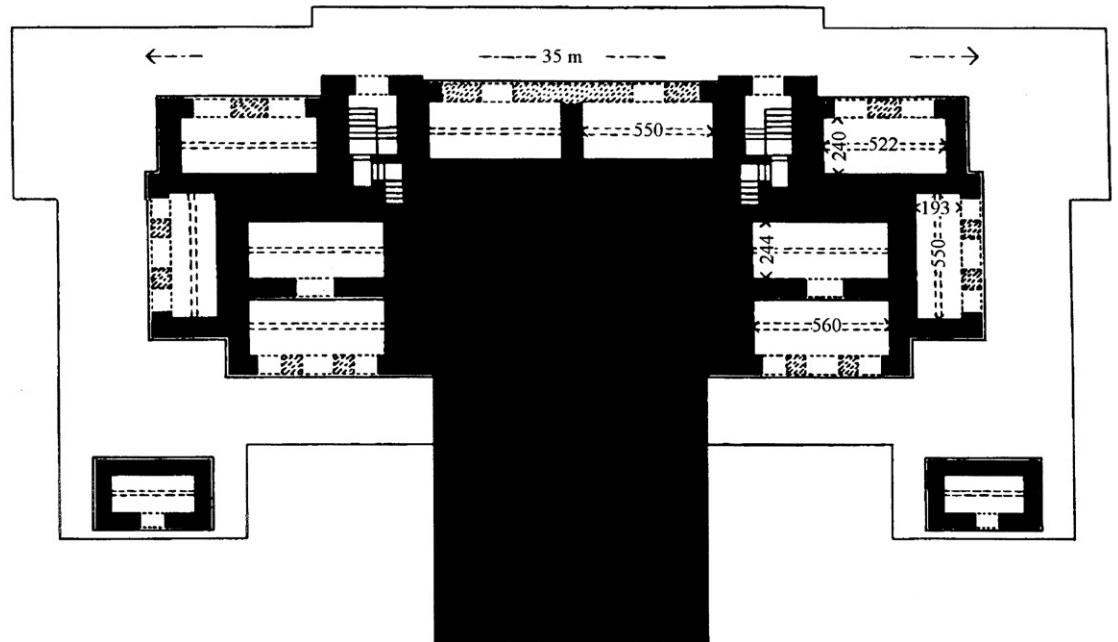

Fig. 5  
 The second floor also shows missing and reconstructed supporting elements. Drawing: T. Maler 1891

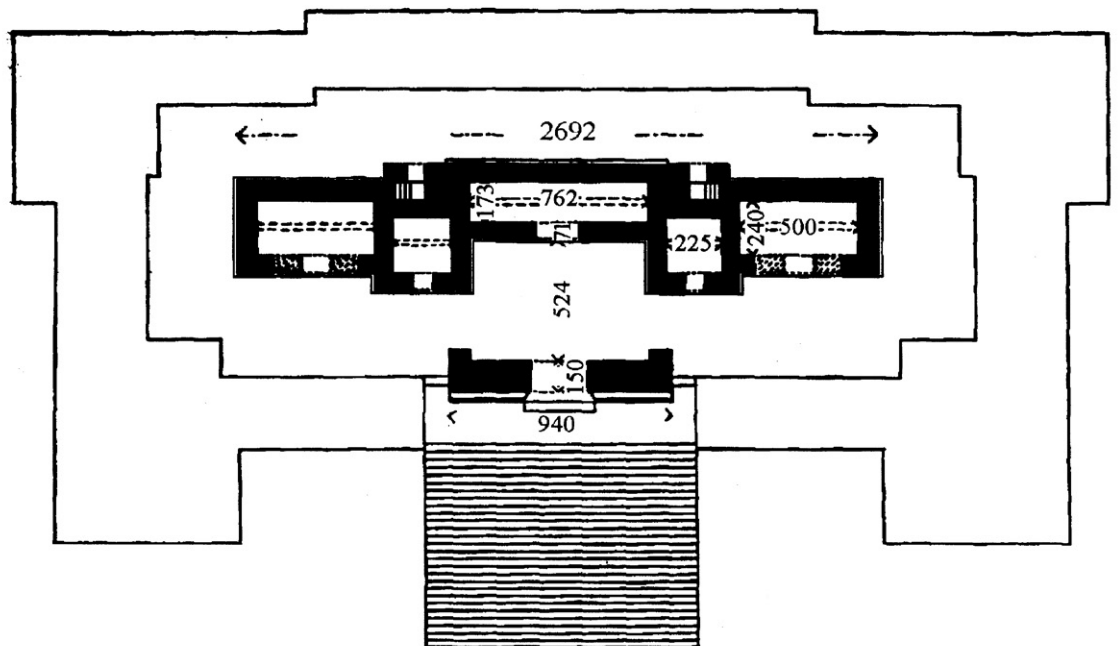

Fig. 6  
 The third floor again shows missing and reconstructed wall sections. Drawing: T. Maler 1891

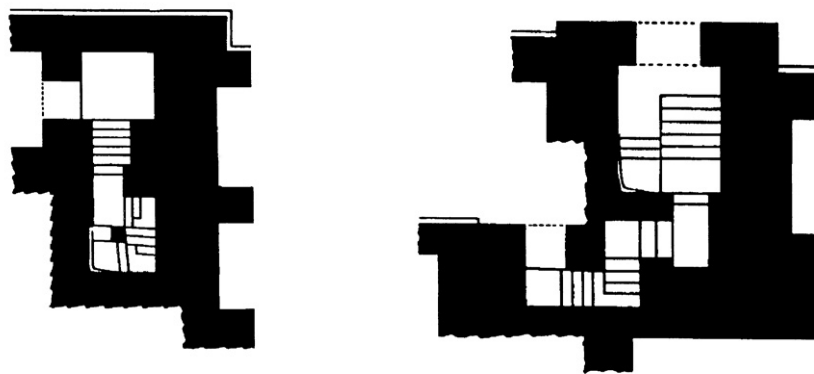

Fig. 7  
Of the two staircases Maler documented the northern one on a larger scale.  
Drawing: T. Maler 1891

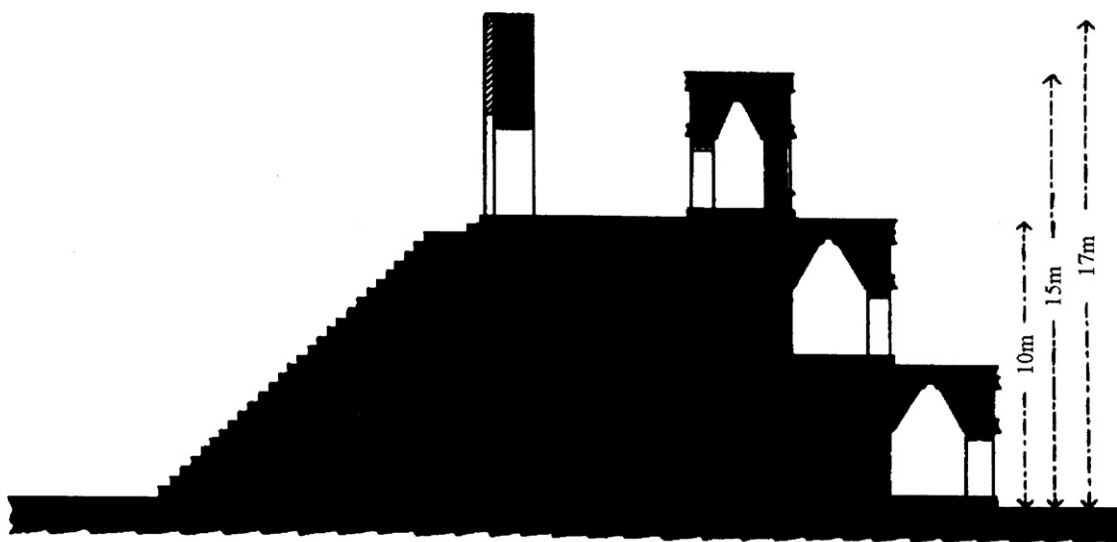

Fig. 8  
Maler even produced a section through the Palace. The reconstructed monster mouth passageway might be too high.  
Drawing: T. Maler 1891

Harry E. D. Pollock and B. Roberts formed a small Carnegie Institution of Washington team and followed in 1936. They explored the archaeological site focusing on its stelae and its architecture (Pollock 1970). The site map is signed by Brainerd, Roys, and Ruppert and is younger than the expedition.

All these early visitors had many logistical problems to solve. The main problem was that there is no water at Santa Rosa Xtampak; it had to be brought from quite far away. The plans of these early visitors contain several errors and also a lot of hypothetical additions which have now turned out to be wrong. Nevertheless Teobert Maler, in particular, documented the architecture of all three floors of the Palace as far as they were visible, relatively precisely, a Herculean task within two and a half days and he also measured and photographed other structures on the site. He even copied graffiti and documented wall paintings within this time.

George W. Brainerd, Ralph Roys, Lawrence Roys and Karl Ruppert were the next to visit Santa Rosa Xtampak in 1949 focusing on pottery. In this year Lawrence Roys carried out a geodetic survey of a great number of mounds and architecture. Later he produced the first map of the archaeological site (DeBloois 1970:11). In 1950 Tatiana Proskouriakoff visited Santa Rosa, too. The ceramic study of Brainerd brought the knowledge that the site was also an important pre-Classic Maya site (Brainerd 1958:89, 92).

Francis S. Murphy visited the site in 1959, 1960, and 1972 (Murphy 1988) and wrote his PhD dissertation on Dragon Mask Temples in Central Yucatán including Santa Rosa Xtampak.

In 1968 Ray T. Matheny of the Brigham Young University and Dee F. Green, Weber State College, carried out a test pit in Santa Rosa Xtampak. Richard B. Stamps and Fred W. Nelson Jr., as graduate students of the Brigham Young University, followed in 1969. Evan I. DeBloois located and measured

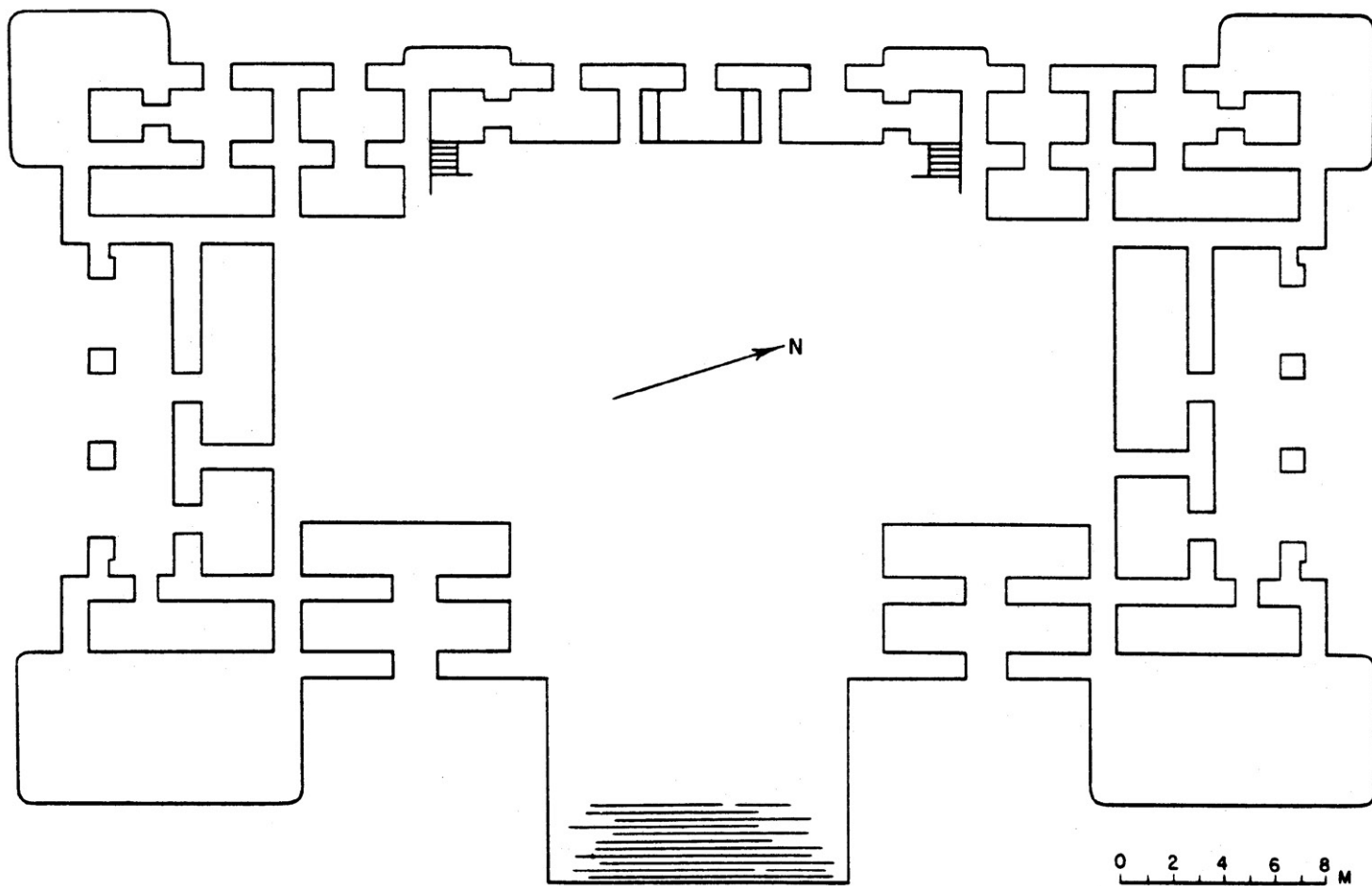

Fig. 9  
 In this first floor ground plan Ruppert reduced Maler's hypothetical wall sections to pillars in the North and in the South. These pillars would not have been sufficient from a static point of view.

Drawing: Karl Ruppert 1969

67 Chultunes at Santa Rosa Xtampak to gain more information about the water management at the site. It seems that the inhabitants of this ancient Maya city got their water only from these man-made underground water tanks in the dry season. He also surveyed the North Group, Northwest Group, the West Group and the Southwest Building. At the end he included all this new information in the map of Roys, Brainerd, and Ruppert.

In 1969 and 1970 Karl Ruppert produced a new ground plan of the first floor (Pollock 1970) and Richard B. Stamps (Stamps 1970) investigated the architecture of Santa Rosa Xtampak in a new documentation focusing on the Palace but also measuring other structures. Stamps paid attention to the documentation of technical details such as sleeping benches, rod sockets, different kinds of cord holders, lintels and vault beams. But he did not distinguish between existing elements and inductively or hypothetically added elements.

A short discussion about the function of rod sockets and cord holders is included in his work. But he did not discuss how cord holders functioned to fix door closings, which is an important indication for the function of rooms. He just documented different types of cord holders but did not record them monographically for an architectural analysis.

Ruppert and Stamps also produced a second and better site map, which is still in use. Only the ground plans of some later excavated structures have been added. In 1970 Stamps wrote his master thesis at the Brigham Young University, an ambitious and useful work, which mainly documents the Palace, but also includes several other structures.

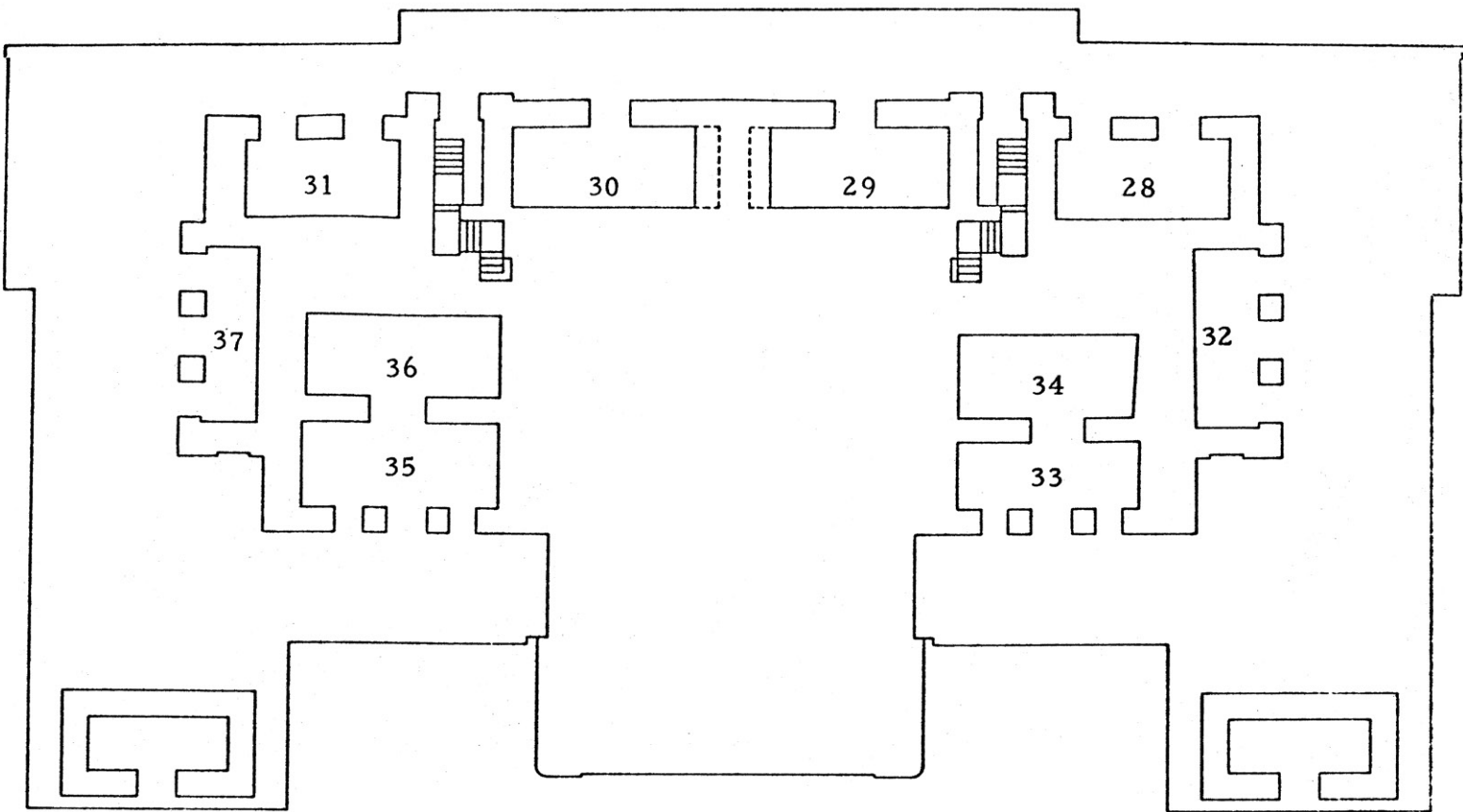
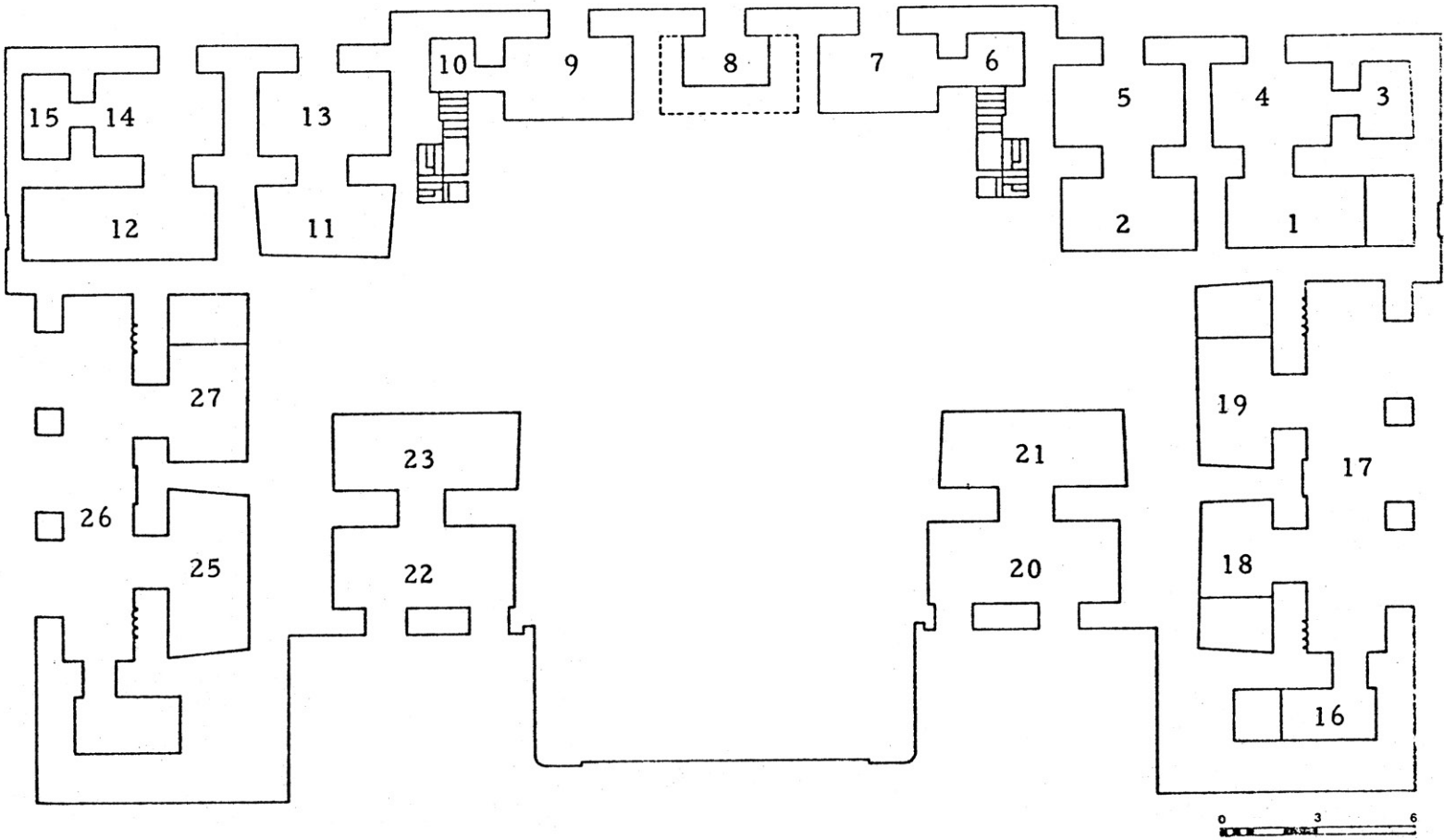

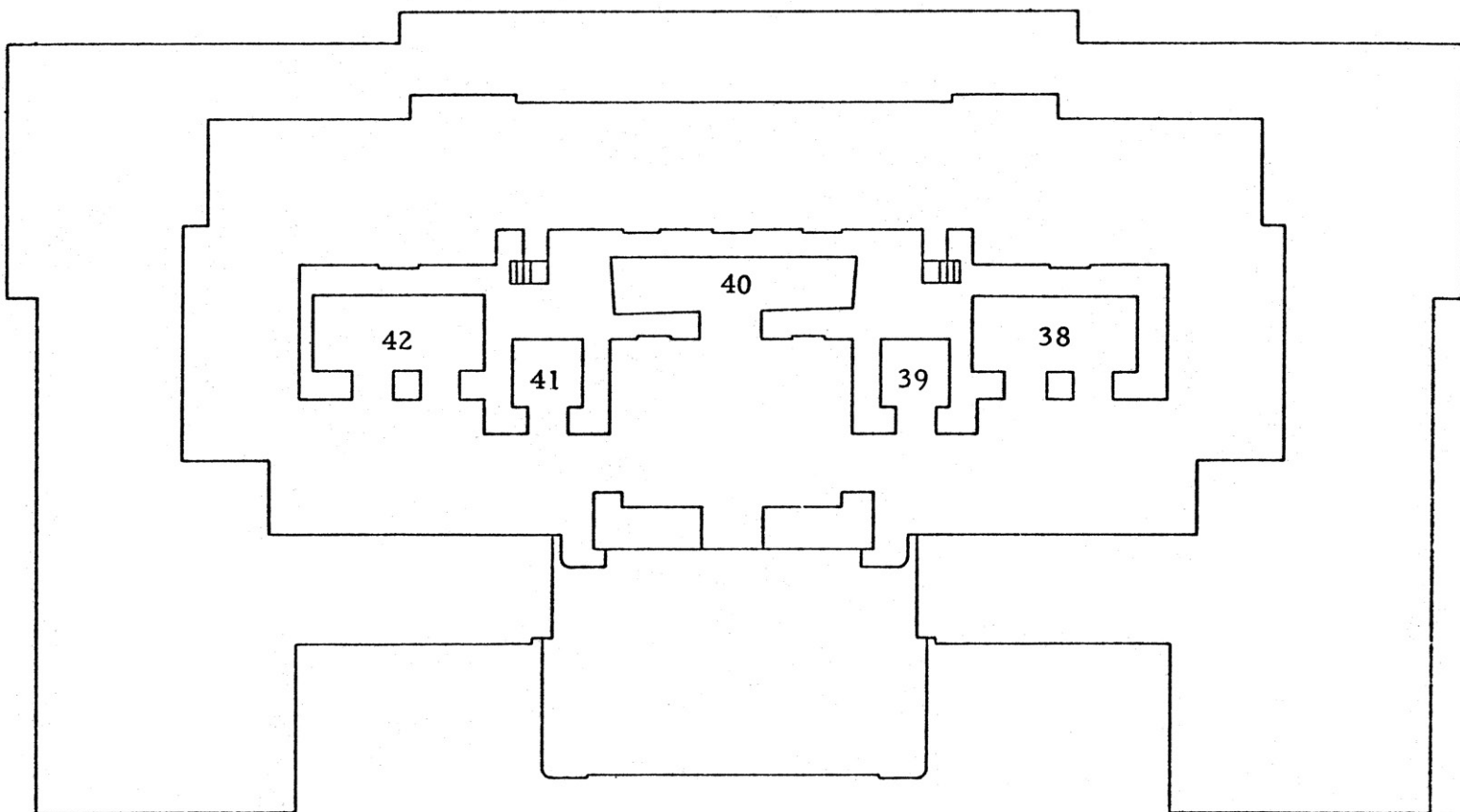

Fig. 10

For the first time Richard Stamps described all the rooms on the three floors using numbers. His first floor ground plan shows walls which deviate from the rectangular wall system of the Palace for the first time. He detected the U-shaped secondary wall in Room 20 (his Room 8). Thus, Stamps then took the non-existing large central risalit from Teobert Maler along the western façade for his ground plan of the first floor and the two pillars for the southern façade and another two for the northern façade from Karl Ruppert. These pillars could never have held the heavy corbelled vaults above.

Fig. 11

The ground plan of the second floor is quite correct. On the western façade the entire row of pillars is missing, but they were not excavated at that time. The thin dividing wall between the Rooms 35 and 36 (his Rooms 29 and 30) never existed. On the eastern side Stairways B and C are missing in his plan.

Fig. 12

Stamp's ground plan of the third floor does not show the pillars along the eastern façade as they were neither visible nor known at that time.

Drawings: R. B. Stamps 1970

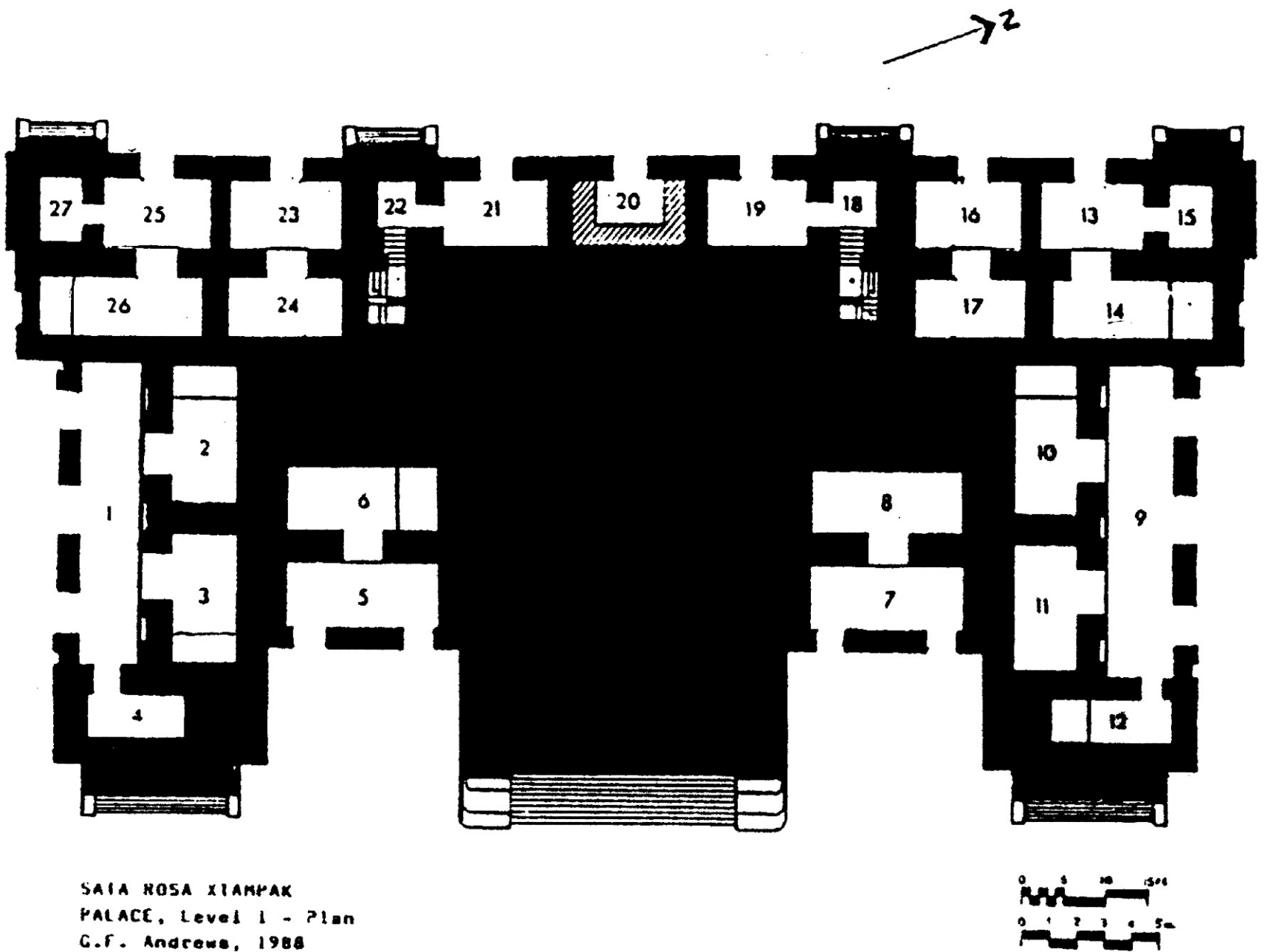

Fig. 13  
 When Andrews realized that the two pillars in Ruppert's and Stamps' reconstruction of the first floor would not have been sufficient, he went back to the two wall sections of Maler for Rooms 1 and 9.  
 Drawing: G. F. Andrews 1988

In the years 1969, 1978, 1986, 1988, and 1987 George F. Andrews visited the site and took a lot of new measurements. His work resulted in new and even better knowledge of the site, a better site map with many additions and a series of new drawings representing and documenting the palace and other structures at Santa Rosa (Andrews 1987).

William J. Folan and Abel Morales López started the new Santa Rosa Xtampak project of the Universidad Autónoma de Campeche in around 1989 to consolidate and reconstruct endangered structures. In cooperation with George F. Andrews they produced a new site map.

Karl Herbert Mayer visited the site in 1982, 1986, 1993, and 2008 to check reliefs, graffiti, mural paintings, decorated capstones and stone sculptures (Mayer 1993MS). Hanns J. Prem was also in Santa Rosa Xtampak several times and initiated measures to save the endangered architecture of the Palace (Prem 1987:121).



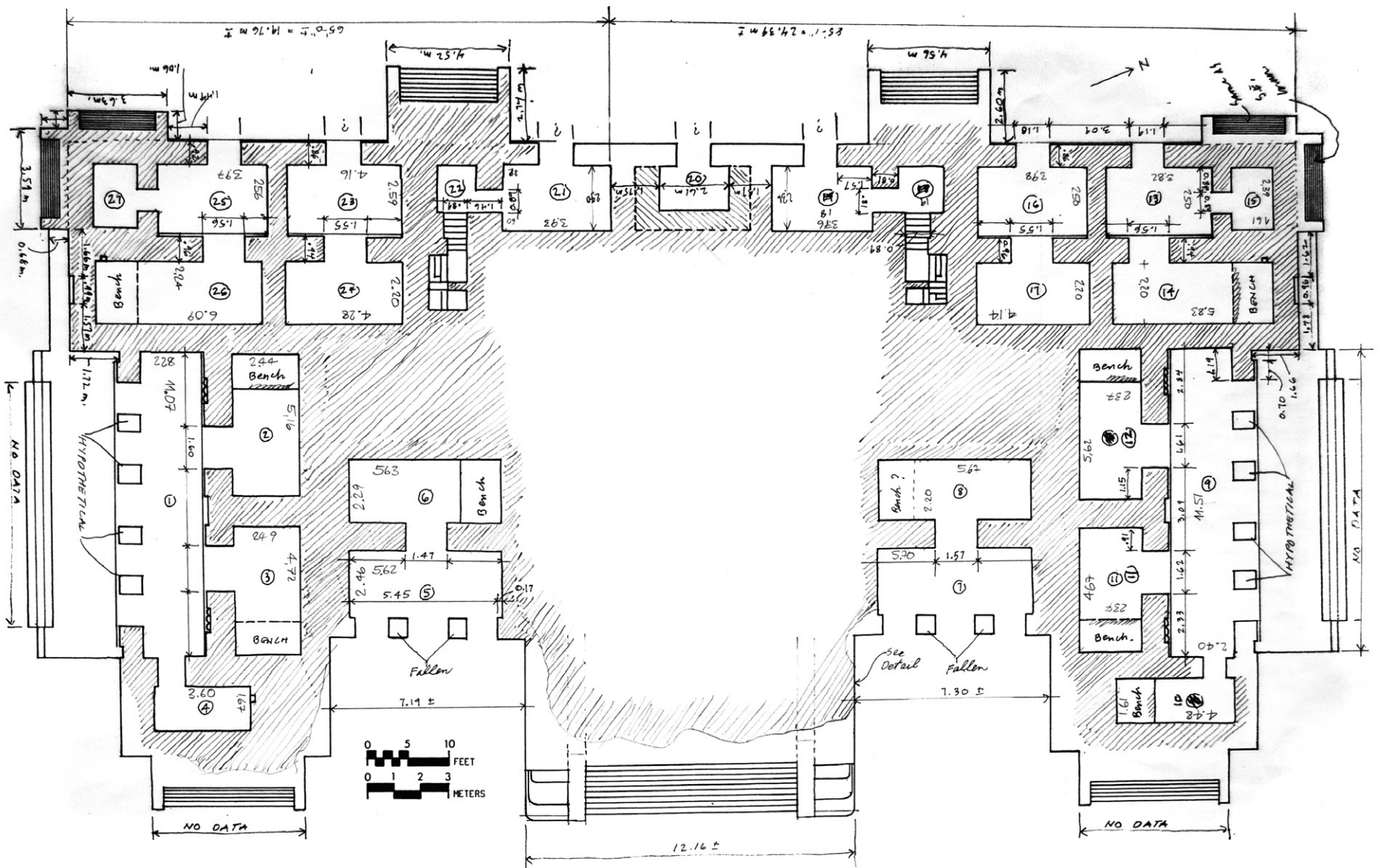

Nicholas M. **Hellmuth** visited the ruins quite often to write about its architecture (Hellmuth 1989). His brother Daniel accompanied him at least once. The two staircases were one of the subjects he focussed on at the Palace.

In 1989 and 1992 Erwin Heine and Andreas Reiter carried out a careful geodetic-photogrammetric survey of the Palace with the aim of producing a three-dimensional "digital architecture model" of a Maya building (For details see chapter: "The Austrian Project Work of the Geodetic Surveyors"). It was probably the first use of this new technique in the history of Maya research.

Jack **Sulak** visited Santa Rosa several times photographing and measuring architectural details and remains of wall paintings as in 1989, 1990, and 2003.

Daniel **Graña Behrens** studied and documented the stelae of Santa Rosa Xtampak in 1998 and wrote his doctoral thesis in Bonn on the stelae of the site including those in the region such as stelae in the near-by village of Hopelchén.

Fig. 14

About ten years later before Rooms 1 and 9 were excavated, Andrews drew a four pillar solution instead of two pillars or wall sections, which was very near to reality.

Drawing: G. F. Andrews approx. 1998 (handdrawn original in the archive of H. Hohmann in Graz)

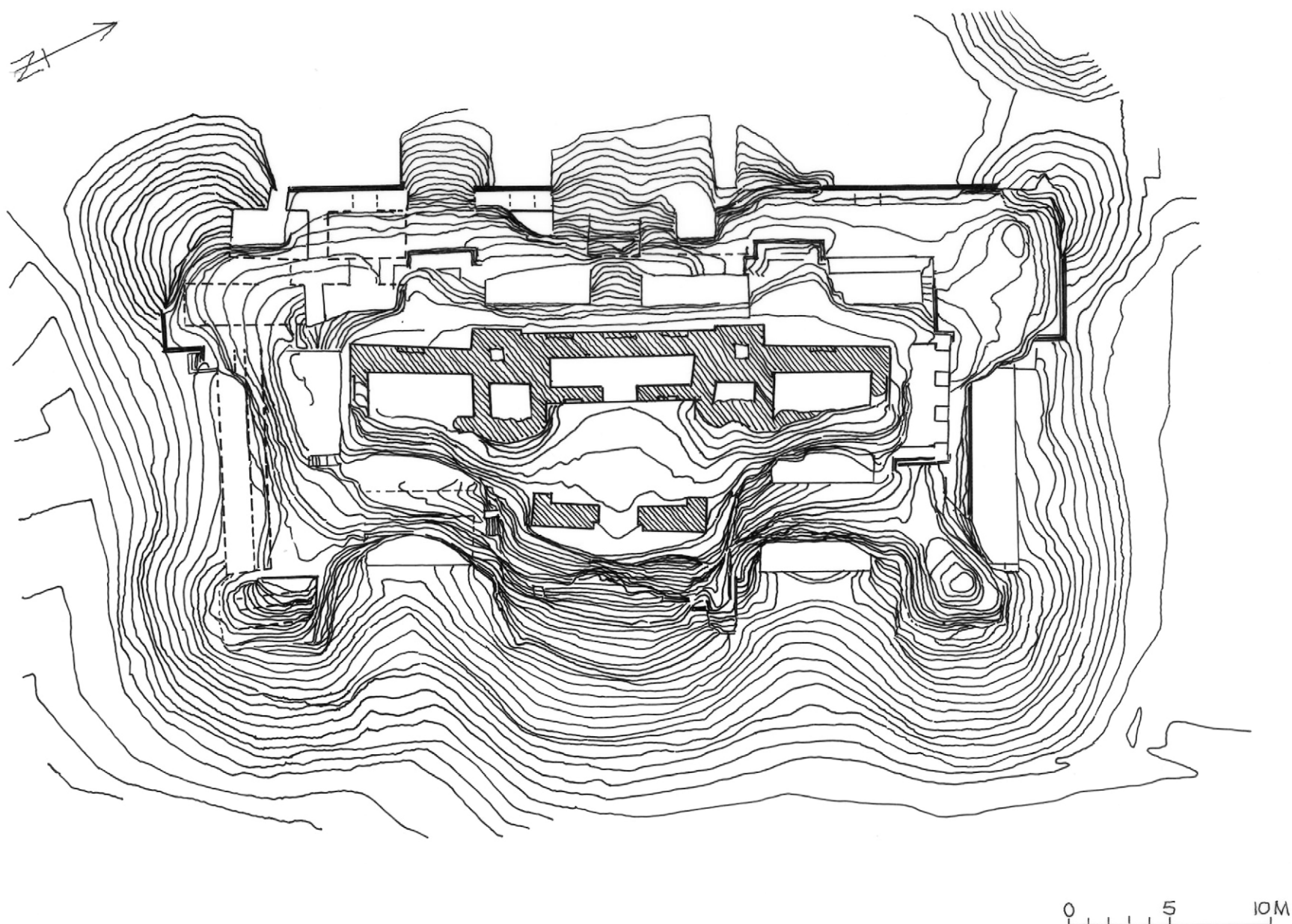

Fig. 15  
 Map with 20 cm equidistant contour lines after Erwin Heine  
 and Andreas Reiter (Heine 1997: Plan 4)  
 Drawing: H. Hohmann 2016

Hasso Hohmann, the author, took some additional measurements of the Palace in 1998, 1999 and 2001. In 2004 he photographed the Palace and some other structures of the site. He checked measurements of former scientists such as George F. Andrews, Erwin Heine, and Andreas Reiter and focused on details such as benches, cord holders, rod sockets, niches, vault beams and lintels.

In the 1990s and at the beginning of the 21st century Antonio Benavides Castillo started to consolidate structures in Santa Rosa Xtampak, when several structures and especially the Palace were seriously in danger of collapsing (Prem 1987:121).

Anthony F. Aveni, Anne S. Dowd, and Benjamin Vining visited the site in 2003 to study relevant architectural orientations.

From about 1999 on Renée Lorelei Zapata Peraza continued the consolidation work and started to excavate and reconstruct the Palace and other structures at Santa Rosa Xtampak.

## THE AUSTRIAN PROJECT

### Work of the Geodetic Surveyors

In 1989, initiated by Nicholas M. **Hellmuth**, Foundation for Latin American Anthropological Research (FLAAR), and promoted by Robert **Kostka**, University of Technology in Graz, the graduate students Erwin **Heine** and **Andreas Reiter** started the geodetic photogrammetric documentation project for the Palace of Santa Rosa Xtampak (Heine, Kostka, Reiter 1990).

In August 1989 they visited the ruins for the first time together with **Manuela Reiter**, **Brigitte Amtmann**, and **Michael Zenz**. Erwin Heine was awarded a research Master's scholarship for Scientific Research in Foreign Countries by the Ministry of Science and Research in Vienna. To carry out the measurements in the field further support was provided by FLAAR as well as by **Linda and William Folan** from the University of Campeche. The "Instituto Nacional de Antropología e Historia" of Mexico issued permission for the geodetic work at the archaeological site of Santa Rosa Xtampak.

"From the 26th of July until the 15th of August the team took their measurements for the 3D documentation of the Palace. One of the main aims was the exact geodetic documentation of the two unique spiraled staircases within the Palace. This task proved extremely difficult because of their narrowness and steepness. Therefore a method combining theodolite and precise laser mapping techniques was selected to chart its geometry. Some facade elements and its almost collapsed sections were recorded by means of stereo pictures. These amorphous surfaces were analyzed applying equidistant contour lines. The 3D capability of computer-aided design (CAD) systems enabled a precise three-dimensional documentation as well as a shaded visualization of the winding internal staircases and the partly collapsed three-story façade of the Palace (Heine & Reiter 1990; Heine 1992; Reiter 1994)"- personal communication with Erwin Heine January 2016.

In 1992 the Austrian Scientific Research Fund (FWF) commissioned a research project applied for by Hasso Hohmann (the author) together with Heine and Reiter to further develop the documentation methodology and apply it to the entire Palace (Project Nr. P8928-GEO/PHY).

From the 8th until the 27th of November 1992 Heine and Reiter revisited the site together with **Angeles Cervantes Alarcón de Heine** and **Erhard Gruber** to complete the precise 3D documentation of the Palace. Based on this geodetic photogrammetric data the digital processing of the 3D-CAD model was carried out by Erwin Heine with support from **Andreas Reiter** at the University of Technology in Graz (Heine, 1995). Later he

continued his research towards a doctoral degree at the same University under the supervision of **Gerhard Brandstätter** and **Annegrete Hohmann-Vogrin** (Heine 1997). Erwin Heine's work is probably the first use of cyberspace technique in the documentation of Maya architecture. The resulting three-dimensional "digital architecture model" allows the scientist (architect, archaeologist) to single out and thoroughly study any interesting part of the structure in the form of sections, axonometric views or even virtual "walk-throughs".

The small ascetic looking ground plans of the three floors and also the following small sections like those of Heine and Reiter have been of great use. Heights and orientations were a very useful corset for the larger plans in this work. The author modified and supplemented the sections with a lot of information for this work.

### Work of the Author in Santa Rosa Xtampak

On 29.10.1998 the author visited Santa Rosa Xtampak for the first time together with **Adele Drexler** and **Daniel Graña Behrens**. The author only had about three hours for a first walk through the ruins.

In 1999 the author measured cord holders, rod sockets, vault beams, lintels and benches by hand in all rooms. There were several grave discrepancies with the measurements of **Andrews** and other earlier visitors and therefore he also wanted to check the data of the Austrian Team. He took measurements of the lengths, breadths, and in most cases also of the heights of all rooms. In Rooms 4 and 10 he also measured the diagonals as these rooms have quite large deviations. He measured profiles of cornices and other architectural details and checked remains of paint. He also checked some quite complex wall paintings in Room 9 and Room 29. This work lasted from the 18th to the 20th of July 1999.

Between the 11th of July and the 14th of July 2001 the author revisited the Palace of Santa Rosa Xtampak and checked a few more missing details and differing measurements. Beside this he photographed all the newly excavated structures or parts of structures at Santa Rosa.

In 2004 he visited the site for the fourth time. He realized that the Palace had now been nearly completely excavated by **Renée Lorelei Zapata Peraza** and a lot of consolidation and reconstruction work was in progress or had already been finished. In this year the Palace was closed and the author photographed only what he could see from outside.

After this visit in 2004 Zapata wrote to him as she was planning to publish a documentation of the architecture of Santa

Rosa Xtampak including the Palace within the next two years. Therefore the author gave his other projects in Graz priority and waited for more than ten years from 2004 to 2015 to finish his work together with the evaluation of the material of Heine, Reiter, and Andrews on the Palace of Santa Rosa Xtampak. He did not want to publish any results of Zapata's excavations before she had published them. Meanwhile several articles by Zapata have been published as the results of her work in Santa Rosa.

### Work of the Author in Graz

After checking all the rooms with hand measurements the author made slight corrections to the maps of Heine and Reiter. He mainly added all the small architectural elements he had additionally measured in the Palace of Santa Rosa monographically.

He reconstructed the newly-excavated architectural sections of the Palace from his photographs to be able to produce a complete documentation of the entire object. Existing sections are drawn by continuing lines. The documentation includes additions of missing architectural portions by inductive solution; they are represented by broken lines. Hypothetical completions by comparisons with similar objects of the region are represented by dotted lines. In some of the sections this system was not followed, for example front views in the background, which are not part of the section.

The analysis of the architecture includes an analysis of cord holders and rod sockets concerning the function of the different rooms, of the lower, longer and of the upper, shorter vault beams and also of the benches.

It also concerns paintings on walls, vaults, and capstones and their reconstruction in the context of the architecture. But this work is not a monographic documentation of these features. It just shows them within the architecture of the Palace.

## NOMENCLATURES OF ROOMS AND STAIRS OF THE PALACE

### Rooms

Catherwood documented only the ground plan of the first floor of the Palace and did not number any rooms specifically (Stephens 1843). Teobert Maler drew ground plans of all three floors of the Palace but he did not number the different rooms of the Palace either (Maler 1902). Ruppert was the next to produce a ground plan of the first floor (Pollock 1970:49, Fig. 58).

Stamps seems to be the first to give figures to all the different known rooms in the Palace (Stamps 1970:Fig. 6). Later Andrews tried to improve the plans of Stamps step by step and published the three ground plans of the Palace – nearly always with different figures for the rooms - several times (refer to diagram).

The author took the last nomenclature of George F. Andrews for his work and extended it. He just gave the two additional towers in the West two figures and another two figures for the two rooms on the second level of the inner staircase. The author is sure that so many different nomenclatures for the same palace make scientific work, cooperation and discussions difficult. Names of sites and nomenclatures such as this one should be continued.

### Stairs

There are 14 very steep pseudo stairways, the one huge, broad but also quite steep Stairway A in the East and the two Staircases D and E within the Palace leading up to the higher stories. Four more "stretched" stairways, each consisting of four steps, lead from the Plaza level to the platform for the first floor in the North, the East and in the South. It will help in the description and discussion to name all of these 21 stairways and staircases.

### Fig. 16

#### Nomenclature of rooms

This diagram shows the differing nomenclatures by Richard Stamps, George F. Andrews and the author.

Hohmann 2015	Stamps 1970	Andrews: cuadernos 1987:71	Andrews, unpublished 1988	Andrews 1997	Andrews, Ausschnitt 1997:293F20
1. Floor					
1	26	16	1	1	
2	27	17	2	2	
3	28	18	3	3	
4	24	19	4	4	
5	22	21	5	5	
6	23	20	6	6	
7	20	22	7	7	
8	21	23	8	8	
9	17	25	9	9	9
10	16	27	12	10	
11	18	26	11	11	
12	19	24	10	12	12
13	4	13	13	13	13
14	1	15	14	14	14
15	3	14	15	15	15
16	5	11	16	16	16
17	2	12	17	17	17
18	6	10	18	18	19
19	7	9	19	19	18
20	8	8	20	20	
21	9	7	21	21	
22	10	6	22	22	
23	13	4	23	23	
24	11	5	24	24	
25	14	2	25	25	
26	12	3	26	26	
27	15	1	27	27	
2. Floor					
28	37	32	28	28	
29	35	34	29	29	
30	36	33	30	30	
31	33	36	31	31	
32	34	35	32	32	
33	32	37	33	33	
34	34	31	34	34	
35	29	30	35	35	
36	30	29	36	36	
37	31	28	37	37	
38		38	38	38	
39		39	39	39	
45	tower N				
46	tower S				
47	staircase N				
48	staircase S				
3. Floor					
40	42	40	40	40	
41	41	41	41	41	
42	40	42	42	42	
43	39	43	43	43	
44	38	44	44	44	
49	staircase N				
50	staircase S				

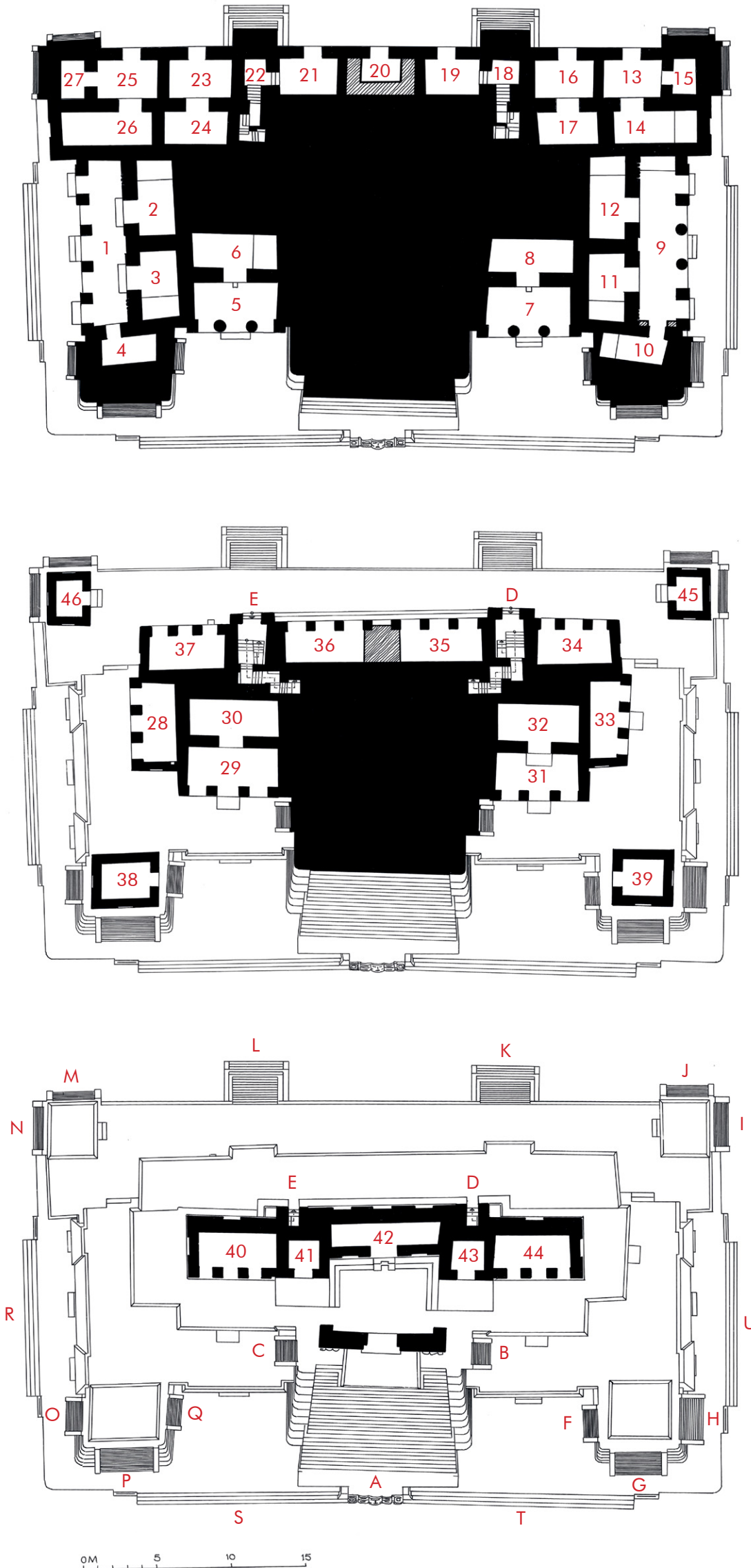

Fig. 17  
 The three ground plans of the three floors of the Palace together with the nomenclature for all rooms and of all stairways and staircases used in this work.  
 Drawings: H. Hohmann 2015

A	Main Stairway + Monster mouth passageway		
B	Northern Pseudo Stairway		Central + Main Temple Pyramid
C	Southern Pseudo Stairway		
D	Northern Staircase		
E	Southern Staircase		
F			
G	3 Pseudo Stairways	Room 39	NE Temple Pyramid
H			
I	2 Pseudo Stairways	Room 45	NW Temple Pyramid
J			
K	1 Pseudo Stairway	Room 47	Northern Temple Pyramid in the West
L	1 Pseudo Stairway	Room 48	Southern Temple Pyramid in the West
M	2 Pseudo Stairways	Room 46	SW Temple Pyramid
N			
O		Room 38	SE Temple Pyramid
P	3 Pseudo Stairways		
Q			
R	Southern Stairway		
S	Eastern Stairway in the South		Platform of the Palace
T	Eastern Stairway in the North		
U	Northern Stairway		

Fig. 18  
Nomenclature of stairs.

## ORIENTATION OF THE PALACE

Several maps of the archaeological site of Santa Rosa Xtampak exist. The first was produced by George W. Brainerd, Karl Ruppert and Lawrence Roys in 1949, published by Pollock in 1970; L. Roys was responsible for the mapping (Stamps 1970:14). In 1969 Evan I. DeBloois documented 67 Chultunes and found further remains of ruins at Santa Rosa Xtampak. He extended and improved the map of Brainerd et al. which was published by Stamps in his Master of Art thesis in 1970.

Later George F. Andrews, in cooperation with Abel Morales López and William J. Folan, added several structures to the map and extended it again. This undated map was new and was published in 2005 (Morales López and Folan 2005:9).

The orientation of these maps varies. The map published by Pollock in 1970 was mainly mapped by Roys, but it is also signed by Brainerd and Ruppert. In the map of Pollock (1970:46a, Fig. 56) the angle of the western façade of the ground floor of the Palace runs approximately **17° east of north**. In the map of DeBloois (1970:25, Fig. 4), which was combined with the map of Brainerd, Ruppert, and Roys, the western façade of the Palace runs approximately **17.5° east of north**. In the map of Andrews and Morales López, which was combined with the old map of DeBloois, Brainerd, Ruppert, and Roys, the western façade of the Palace runs **9.7° east of north** (Morales López and Folan 2005:9, Fig. 4). Abel Morales López informed that Rogerio Couch Muñoz was responsible for the north direction (personal communication with William J. Folan in 2015). In another article (Andrews 1997:278, Fig. 3) the map shows an angle of **17.5°**. In all four cases it is not known if true north or magnetic north was measured.

Erwin Heine and Andreas Reiter did not only measure the geometry of the Palace but also undertook measurements regarding the orientation of the Palace.

"In 1989 a non-georeferenced coordinate reference system, also called local coordinate system (LCS), was established based on survey markers distributed around the palace. The same survey markers also served for the measurement campaign of 1992 as these markers were intended to be permanent (crosses chiseled in stable rock).

In 1989 compass surveying was applied to obtain the magnetic azimuth of their local coordinate system and subsequently the azimuths of the directions of building elements.

The magnetic bearings of connected lines were measured by a prismatic compass fixed on a non-magnetic tripod which was centered over the survey markers. The resulting magnetic azimuth was 46.5 Gon and by adding the magnetic declination of 3°13' east for August 1989 for this region, it delivers a true azimuth of 38.64 degrees for the local coordinate system (Reiter 1994:27-30, 53-55).

In 1992 the "astronomical azimuth determination by the hour angle of Polaris" was applied to orient the local coordinate system. On the 22nd of November 1992 the astrogeodetic measurements were carried out at night on the "roof" of the Palace. The determined astronomical azimuth of 36.0 degrees of the local coordinate system matches the compass survey result from 1989 quite well.

The direction of the western façade on the first floor - which is parallel to the "north-south axis" of the Palace - seems to be suitable as an indicator for the orientation of the Palace. Thus the azimuth of the direction from the entrance of room 23 to the entrance of room 13 is **26°08'** (Heine 2016:93) – this information was provided by Erwin Heine in January 2016.

### Fig. 19

Red marked areas are less precise as they were not measured from the architecture but from photographs of the architecture.



## PRECISION OF THIS DOCUMENTATION

The geodetic survey of Heine and Reiter was the most precise documentation of the Palace and resulted in a three-dimensional digital model of its architecture. The Palace had unfortunately not yet been excavated when they carried out their geodetic survey. The foot of the Palace as well as many floors and lower wall sections with details were not visible at that time. Therefore the work of Heine and Reiter could not document the complete architecture. It had to remain a very useful corset for all later additional measurements of the author, taken on the site and taken from tourist photos of the structure by Karl Herbert Mayer, Annegrete Hohmann-Vogrin, Hermann Hendrich, Adele Drexler, and the author.

Obviously the building ground of the Palace was and still is not only solid rock but also filled and leveled rubble and earth material. This resulted in unequal depressions at the base of this huge heavy structure. The great weight of the massive three-storey Palace and the high pressure stress of the Palace on the ground caused visible deformation. You can see such deformation especially on the first floor, for example, at the base of the wall between Room 7 and Room 8 if you look from Room 7 in a western direction. Here the walls on both sides of the passageway are pressed down approximately 5 to 6 cm. Between Rooms 5 and

6 the depression measures between 4 and 5 cm. In both cases the decorated base moldings underneath the passageways are deformed.

In 1998 and 1999 the author measured nearly all the rooms again by tape and added all the missing details such as plenty of cord holders, rod sockets, vault beams, lintels, several benches, niches and other architectural elements like cornices, base moldings, medial moldings, upper moldings, and colonnettes.

Those architectural portions, which were excavated and reconstructed by Renée Lorelei Zapata Peraza, have not been geodetically measured. They were photographed by different visitors as well as by the author. Measurements within these tourist photographs have resulted in the details of these portions. The documentation therefore cannot be as precise in these areas as in the main part of the palace. The documentation of those architectural portions of the palace, which have been excavated since 1999, should not be used for an analysis of measurements. They should, however, be exact enough for the documentation of the architecture of this fascinating Palace.

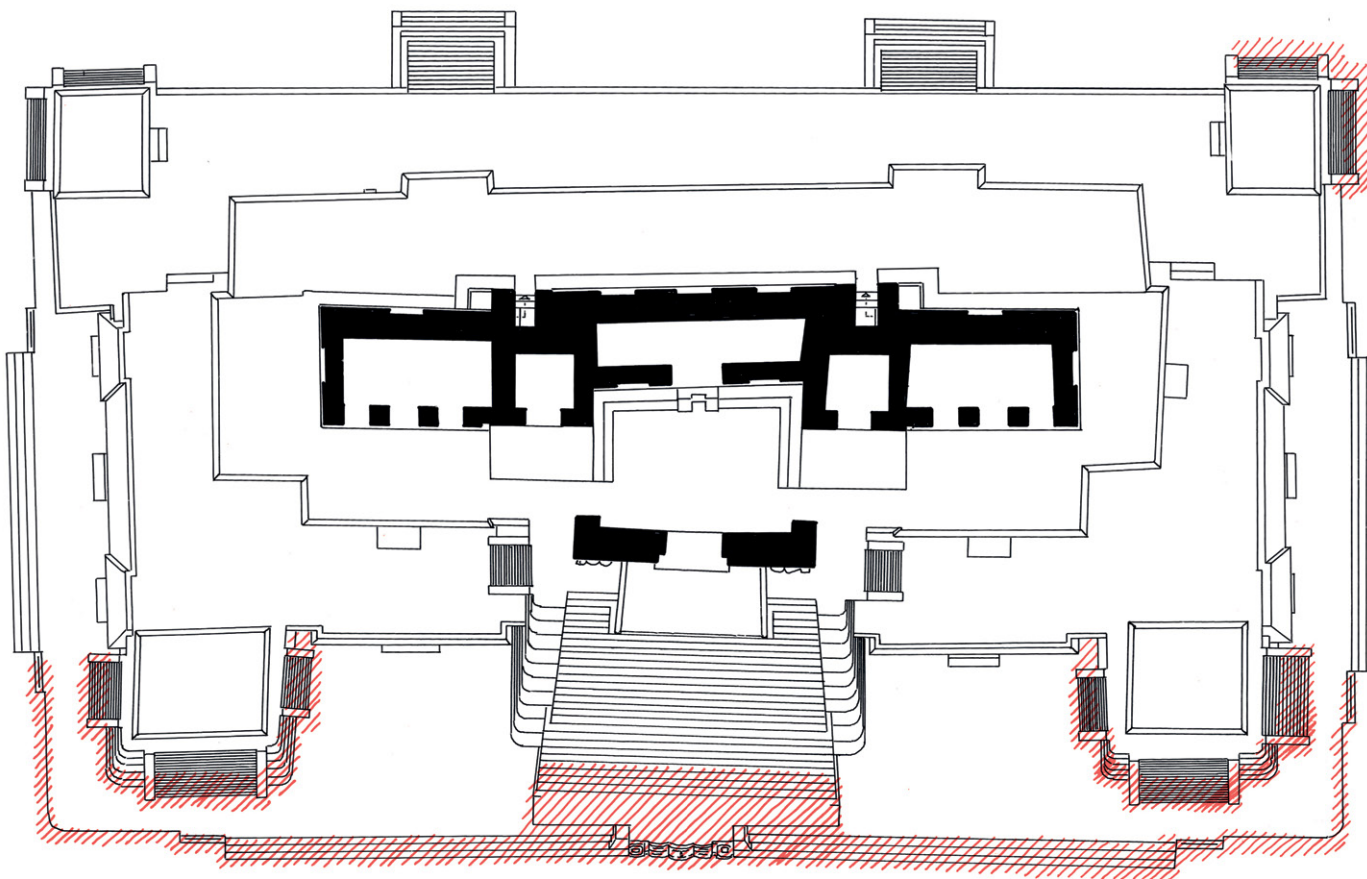

Map Symbols

# DOCUMENTATION

## DOCUMENTATION OF THE PALACE BY DRAWINGS

An architectural documentation of existing structures should define the architectural form and construction in a way, that a present day building company would be able to rebuild the architecture from the plans and sections of the documentation. That means that the general form and also all details have to be documented in ground plans, cross sections, and front views to scale. The following architectural documentation of the Palace of Santa Rosa tries to define its architecture sufficiently. All ground plans, section, front views, and details of the following documentation on the pages 25 up to page 56 have been constructed and drawn by Hasso Hohmann.

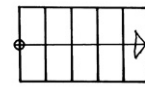

stairway – arrow points upwards

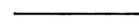

existing contour of the structure

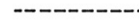

non-visible contour of the structure, contour completed by inductive method



contour of a section of the structure completed hypothetically

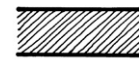

cross section of an existing part of the structure



cross section through a part of the structure that can be completed by inductive method



cross section of a part of the structure completed hypothetically

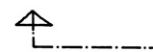

sectional plane projection into the ground plan with arrows indicating the direction

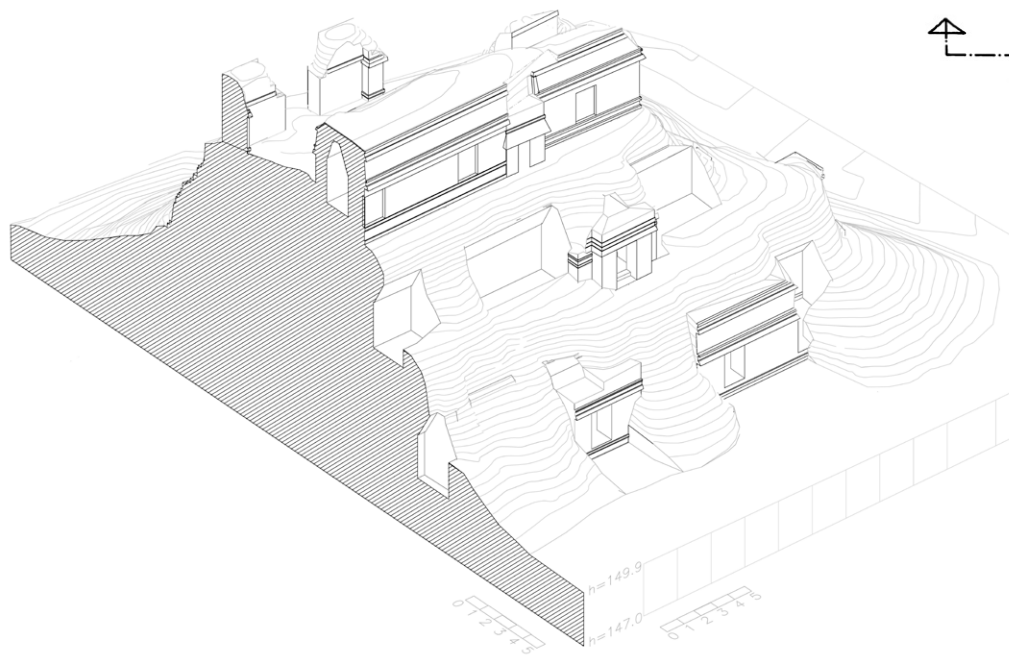

Fig. 20a  
Section through the digital architectural model.  
Drawing: Erwin Heine

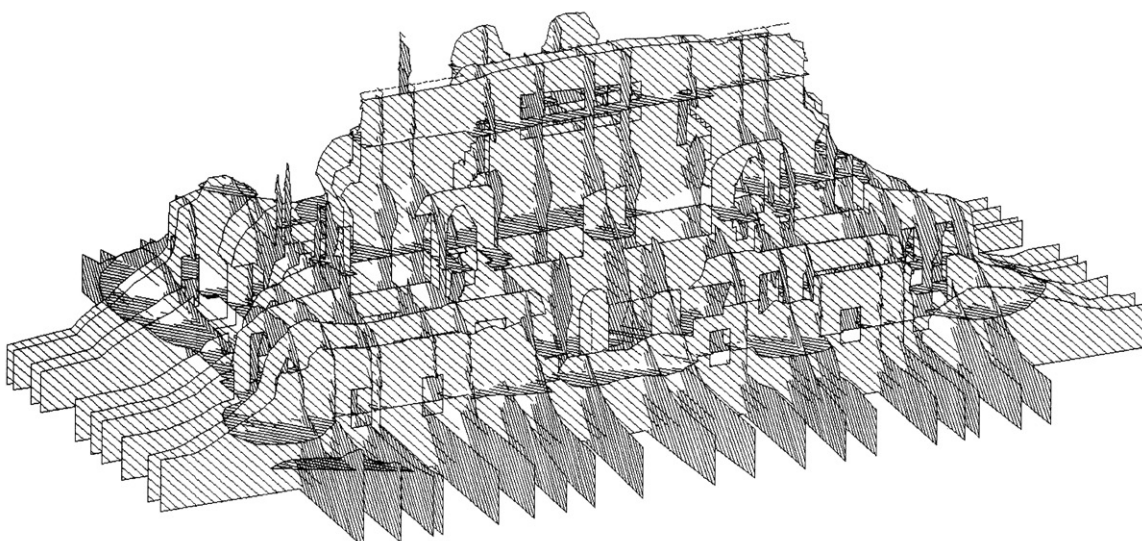

Fig. 20b  
The L and the Q section levels through the Palace  
Drawing: Erwin Heine

Abbreviations

- D=direction
- E=east
- F=floor
- Fa=façade
- GP=ground plan
- L=north-south section
- N=north
- P=perspective
- Q=east-west section
- R=room
- S=south
- S.=section
- St=stairway or staircase
- W=west

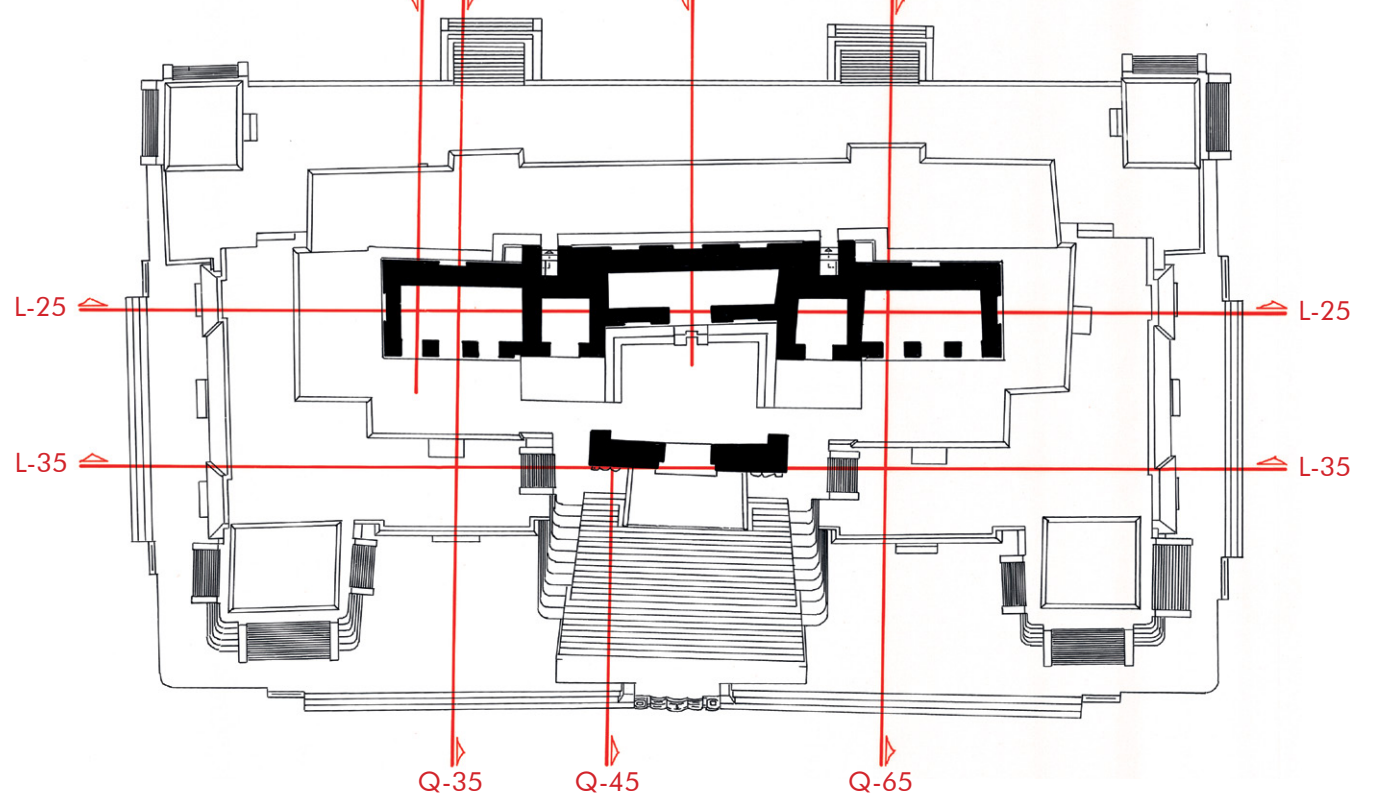
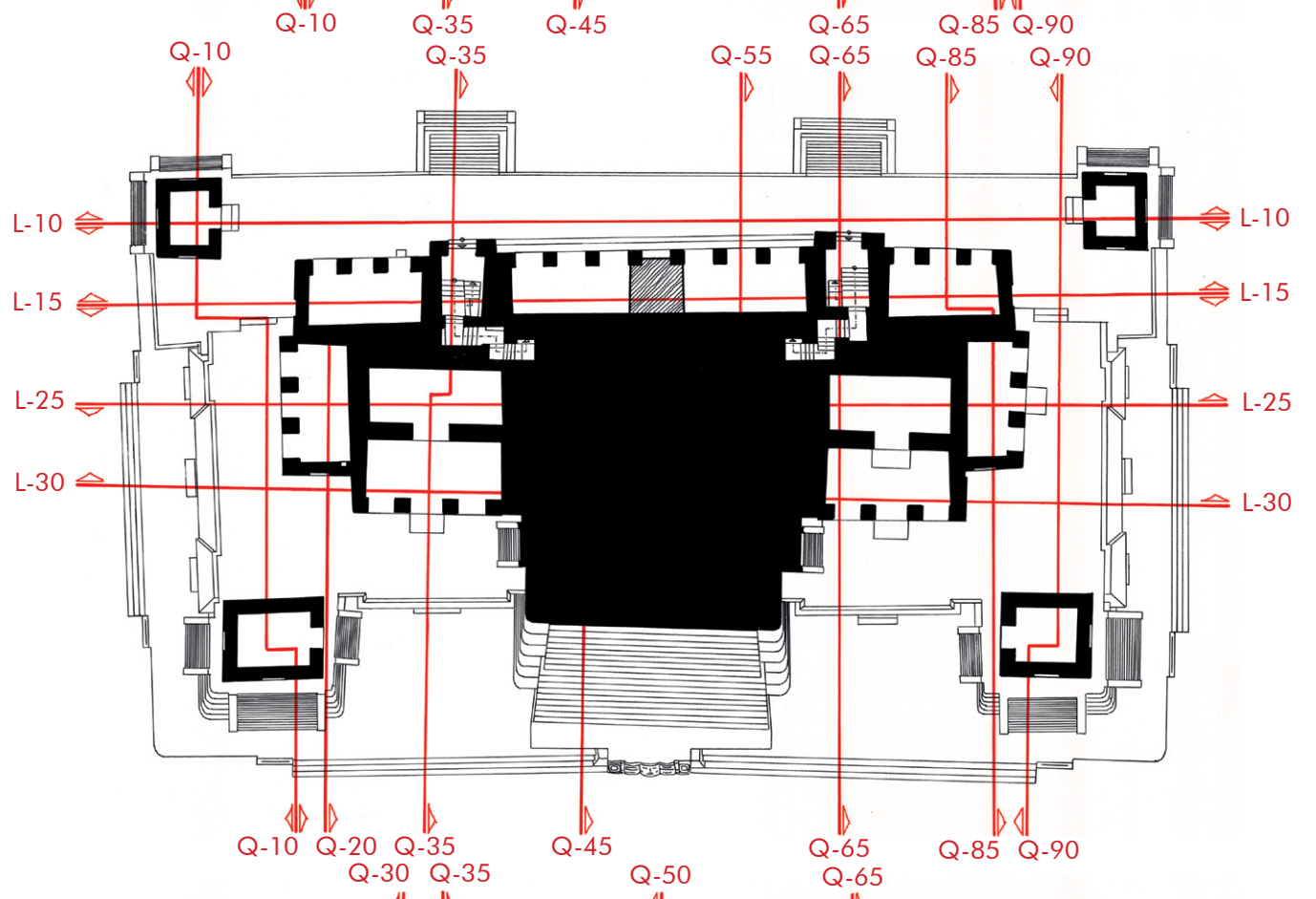
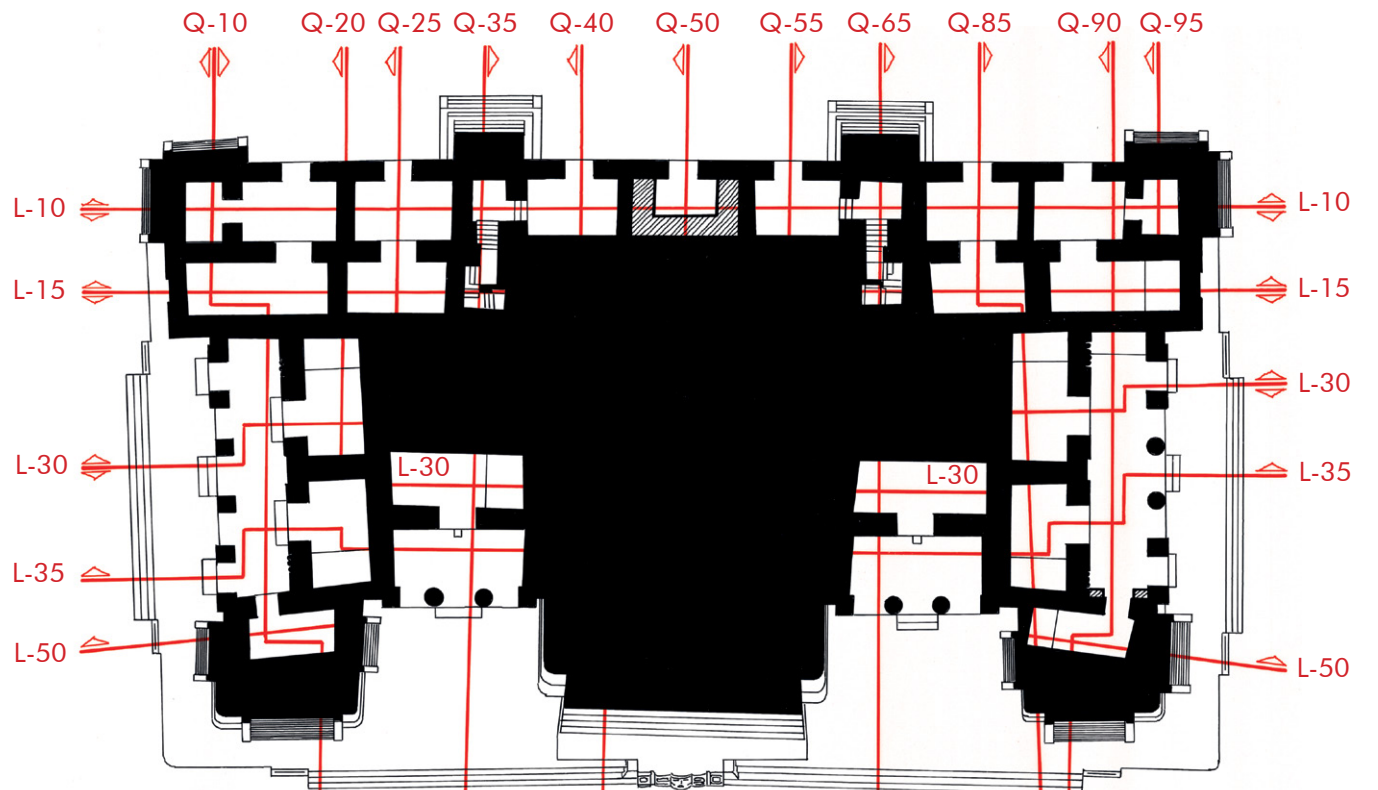

Fig. 21  
The three ground plans of the Palace of Santa Rosa Xtampak with the sections through the structure mentioned below in red.

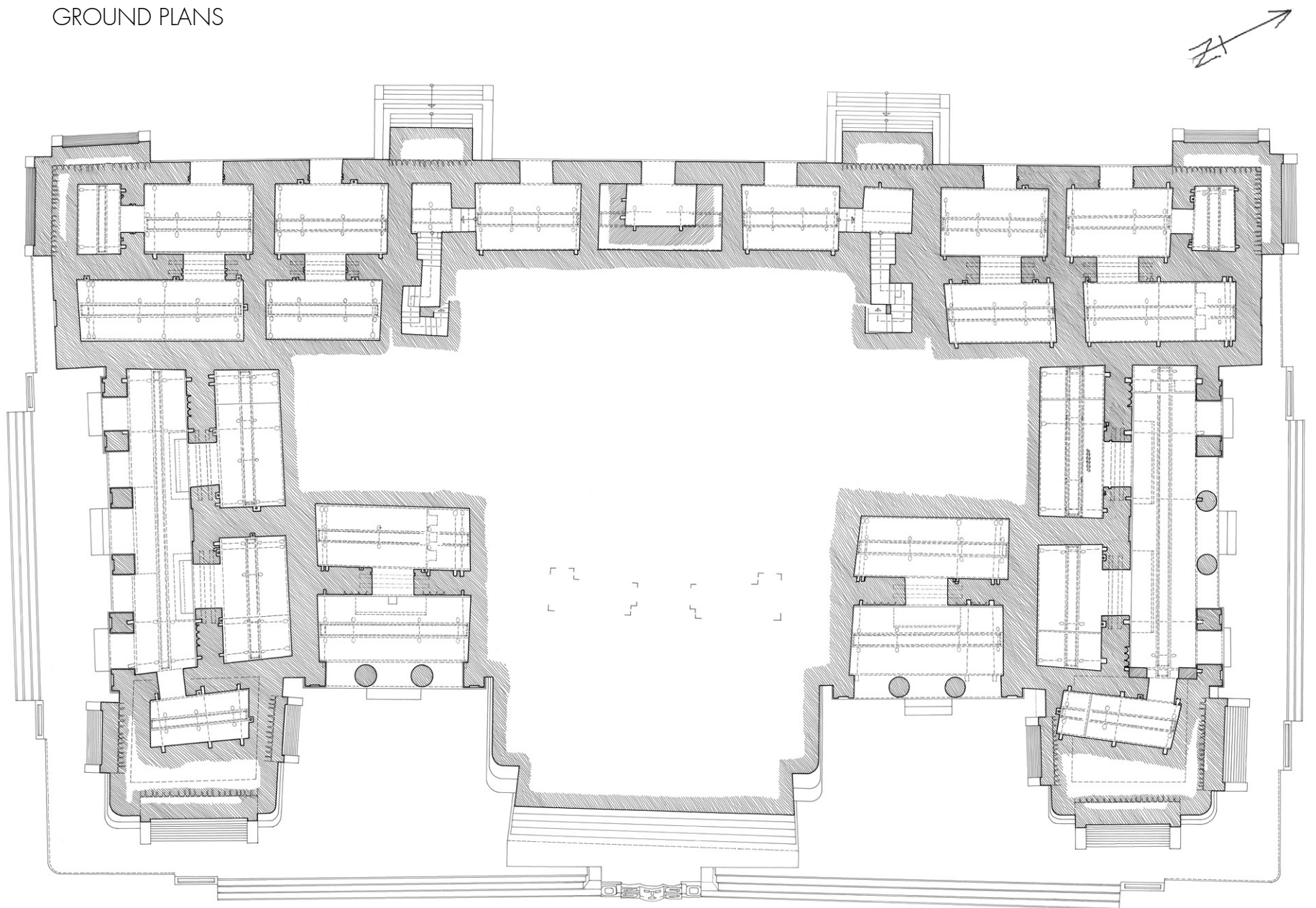
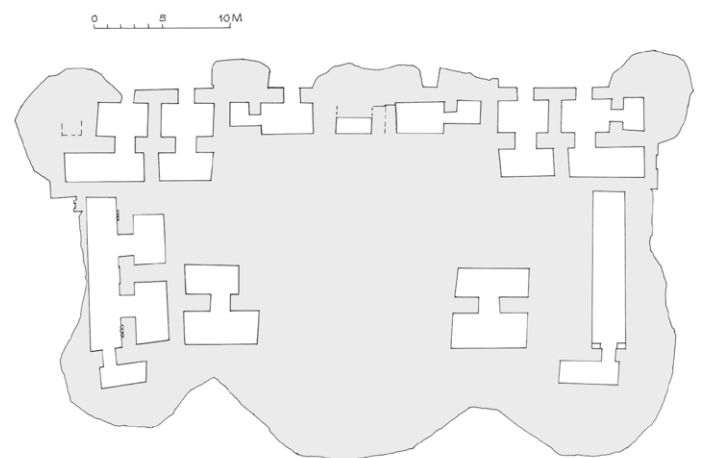

Fig. 22  
GP1.F Ground plan of the first floor

The ground plan of the first floor represents a horizontal section of the Palace approximately 1 m above the main floor level. The plan also shows a projection of the form of the vaults, vault beam holes, the position of the beams, cord holders, rod sockets, and benches. It also shows some of the wooden reinforcements above inner door lintels. Stamps recorded them above the lintels between Rooms 1 and 3 as well as between Rooms 9 and 11. They had a static function and are a reinforcement of the lintel zone. It is quite certain that there are or were more such beams within the core of the massive vault zones above all lintels of the passageways on the first floor and the second floor as well as above all the wide spanned passageways in the Palace. Archaeologists can only check them where lintels have collapsed. Six of them have been drawn from information by Stamps, two from the author's check.

In the case of the two staircases in the Palace the stairs have been continued further on to give a better connection to the ground plan of the second floor. Hatching appears only two times in this ground plan, at the eastern end of Room 9 and in Room 20; in both cases the structure had to be strengthened by supports added at a later date.



The orientations of Room 4 and Room 10 do not fit into the approximately rectangular system of the rest of the Palace. Their axes of symmetry seem to face a certain point under the centre of the lower jaw of the monster mouth passageway on the third floor. The question is the huge space in the core from the first and the second floor. Were there earlier rooms of the first building phase of the Palace here? Were they filled up later? Are there tombs of earlier persons of the Palace, chambers with paintings from an earlier building phase?

The ground plan is based on the geodetic survey of Erwin Heine and Andreas Reiter (Heine 1997:Plan 34; refer to small drawing).

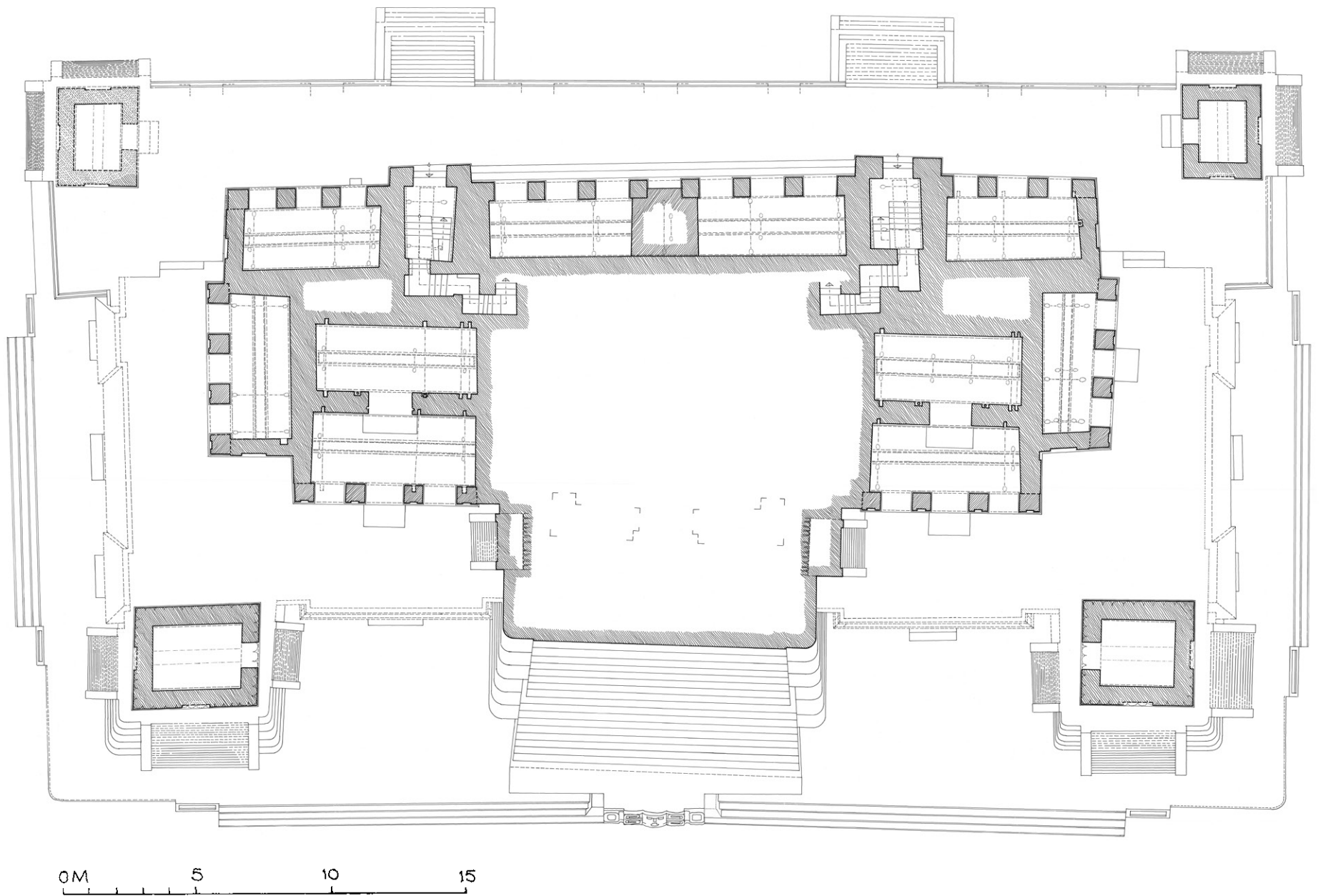
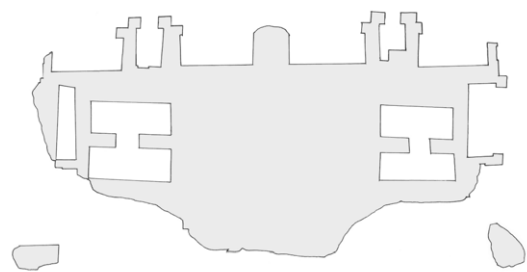

Fig. 23  
GP2.F Ground plan of the second floor

There are 4 stairways leading up to the narrow but large common platform on the first floor. The 15 pseudo stairways around the Palace are not functional. Only the main Stairway A in the center of the eastern façade might sometimes have been functional up to a certain degree. But this stairway is very steep and was presumably only used by specially trained persons for important ceremonies. Therefore the only stairs leading up to the upper floors of the Palace are the two inner staircases. They are quite narrow. They might have been used with a one way system. The former use of the four isolated standing towers or temples on the second level cannot be reconstructed. The entrances of the eastern two temples face each other and are positioned above the steepest of the pseudo stairways. It is a long way around the Palace to get from Temple 38 to Temple 39.



The entrances of the western Temple 45 and Temple 46 also face each other and there is a direct connection from one to the other in front of Rooms 34 to 37. No temple could be reached directly from the first floor.

The ground plan is based on the geodetic survey of Erwin Heine and Andreas Reiter (Heine 1997:Plan 35; refer to small drawing).

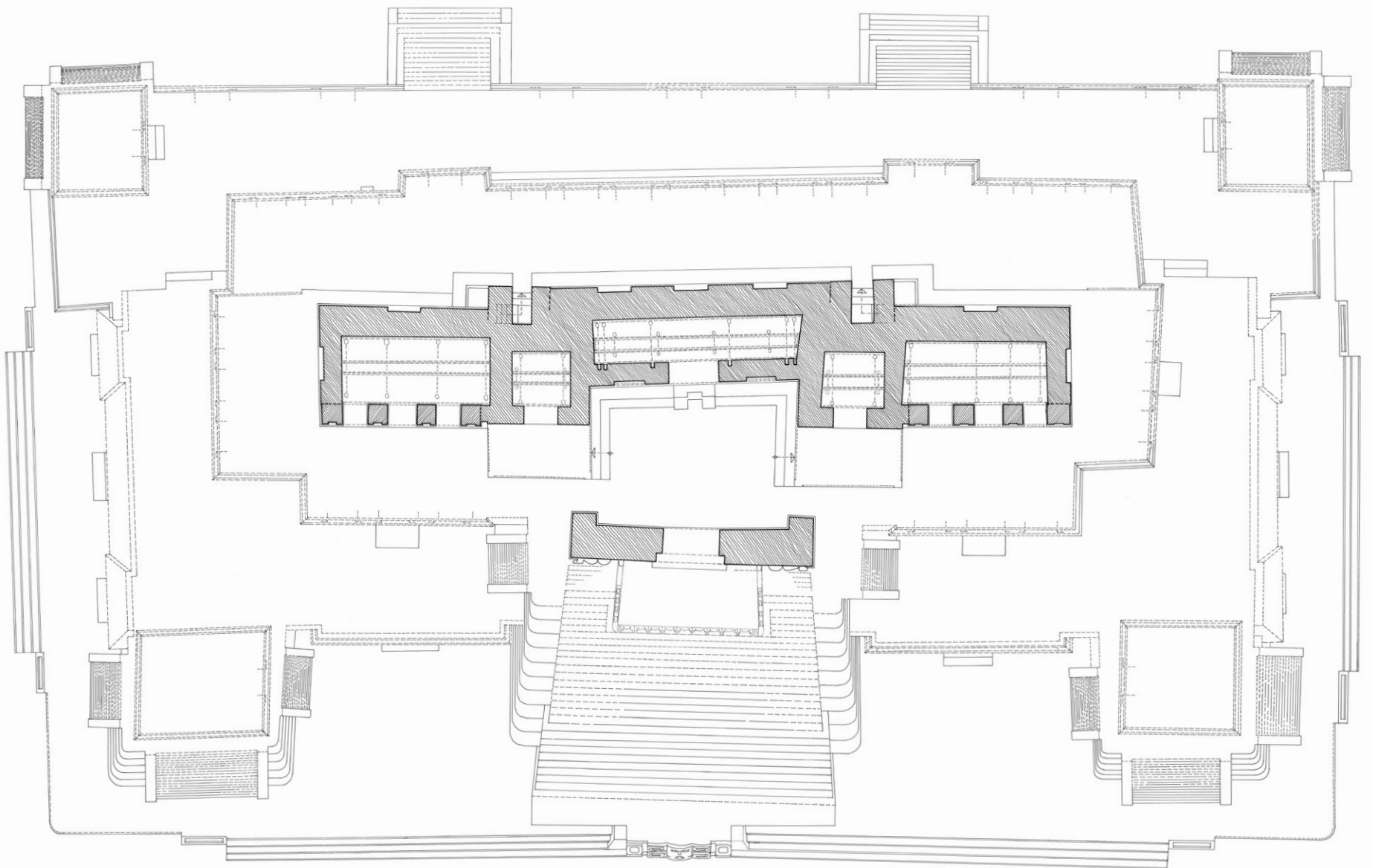

**Fig. 24**  
**GP3.F Ground plan of the third floor**

The five rooms behind the monster mouth doorway stand in the background like a wall. The central room is the only one orientated to the small courtyard, the most central area of the entire Palace. The three central rooms are on a higher level than the two rooms flanking them. Maybe the most important person of the Palace lived or at least resided here.

The western walls of the five rooms are between 115 cm to 120 cm thick and are even thicker than many of the supporting inner walls of the first floor. The inner walls on the first floor measure between 95 cm and 115 cm. The outer walls are often only 86 cm thick. On the third floor the eastern walls measure between 65 and 78 cm. The question arises about the reason for such heavy massive walls along the western façade? The author is sure they are a strong indication of planned roof combs above the western walls on top of the roof of the third story.

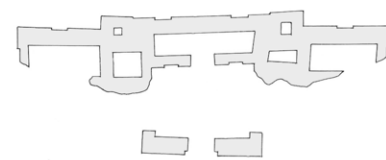

On the first and second floors the western central area needed strong support by additional massive walls in Room 20 as well as in the long Room 35/36, which was divided by a massive supporting block.

The ground plan is based on the geodetic survey of Erwin Heine and Andreas Reiter (Heine 1997:Plan 36; refer to small drawing).

## FAÇADES AND SECTIONS



**Fig. 25**  
**EFa Eastern Façade**

The eastern façade is the face of the Palace oriented to the "Plaza del Palacio". It shows the main Stairway A, which leads from the raised platform up to the monster mouth passageway, which tops the entire Palace on this side. Lorelei Zapata and her team discovered a small mask in the axis of this stairway just at the beginning on the level of the Plaza del Palacio. Long stretched stairways with only four steps flanked by narrow panels follow on both sides of this mask. The mega steps on both sides of the main stairway together with the pseudo Stairways B and C form a central pyramid. The monster mouth passageway looks like the entrance of a temple; it seems to be some kind of a pseudo temple. Possibly there was once a curtain on the rear side of the doorway so that people could not see from outside that the doorway was not a huge building. This pseudo temple together with the Stairways A, B and C and the mega steps form a huge temple pyramid. Both ends of the eastern façade are dominated by the two smaller temple pyramids. The entrances to the small Temples 38 and 39 face each other and the main stairway. Pseudo stairways run up to both platforms from the South, the East and the North.

The author added one pseudo entrance above these pseudo stairs on each façade hypothetically. Everywhere we find pseudo stairways in combination with entrances or with pseudo entrances. Very often they stand on raised platforms. All together they form some kind of a scene for ceremonies in front of the eastern façade of the eastern temple pyramids. Between the three temple pyramids on both sides of the axis of symmetry on all three floors rooms with three entrances can be recognized. The two Rooms 5 and 6 as well as 7 and 8 on the first floor each have three entrances and are accessible via the central entrance between two columns. At both ends of this eastern façade are two pillars, which touch one of the gable walls on one side. On the second and the third floors the three entrances are flanked by four pillars. Only parts of the two flanking small rooms on the third floor next to the most central one are visible behind the huge monster mouth doorway from the Plaza. Three dotted roof combs must have been planned to top the entire ensemble of the Palace but could not be carried out due to serious static problems.



Fig. 26  
The monster mouth passageway and the upper part of Stairway A are visible.  
Photograph: H. Hohmann 2001



Fig. 27  
The restored version shows a cornice which runs along both sides into the remains of the upper ear rings of the monster. There should at least be a distance between the rings and the cornice.  
Photograph: H. Hohmann 2004



Fig. 28  
This is the north-eastern corner of the south-eastern temple pyramid. The asymmetrical pseudo stairway in the North is flanked by three mega steps to the left. If they are continued they do not fit in with the rest. Change is needed.  
Photograph: H. Hohmann 2004



Fig. 29

S.L-50 (R4+10)

Section L-50 facing west shows that the two Rooms 4 and 10 are situated under the two small temples, Rooms 38 and 39. Room 10 had a bench, which was measured and documented by Stamps (1970:53). It had already been destroyed by looters. Plaster lines on the wall plaster in Room 10 indicate quite certainly a bench in this room. In Room 4 a wooden bench might have existed. This must have been at a lower level than in Room 10 as otherwise the cord holder would have been covered. The façades of these two rooms consist of three pseudo stairways leading up to the two temples for each room. The use of the two temple pyramids was quite certainly a ceremonial

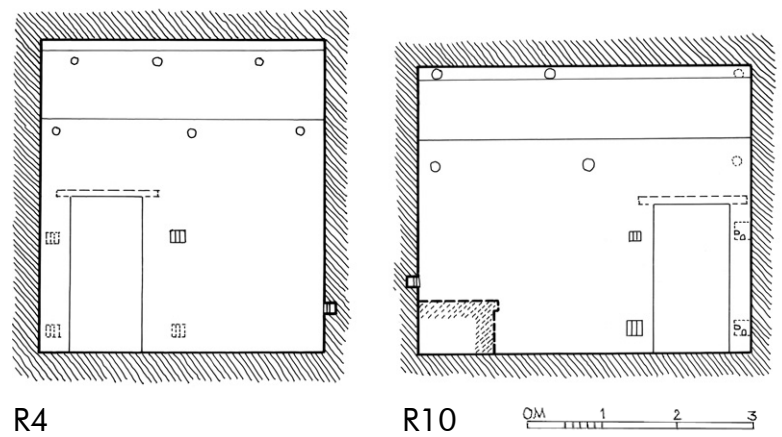

one; the use of the two rooms behind was certainly for a profane living purpose. Each of these belonged to a compound of four rooms forming a larger living space.

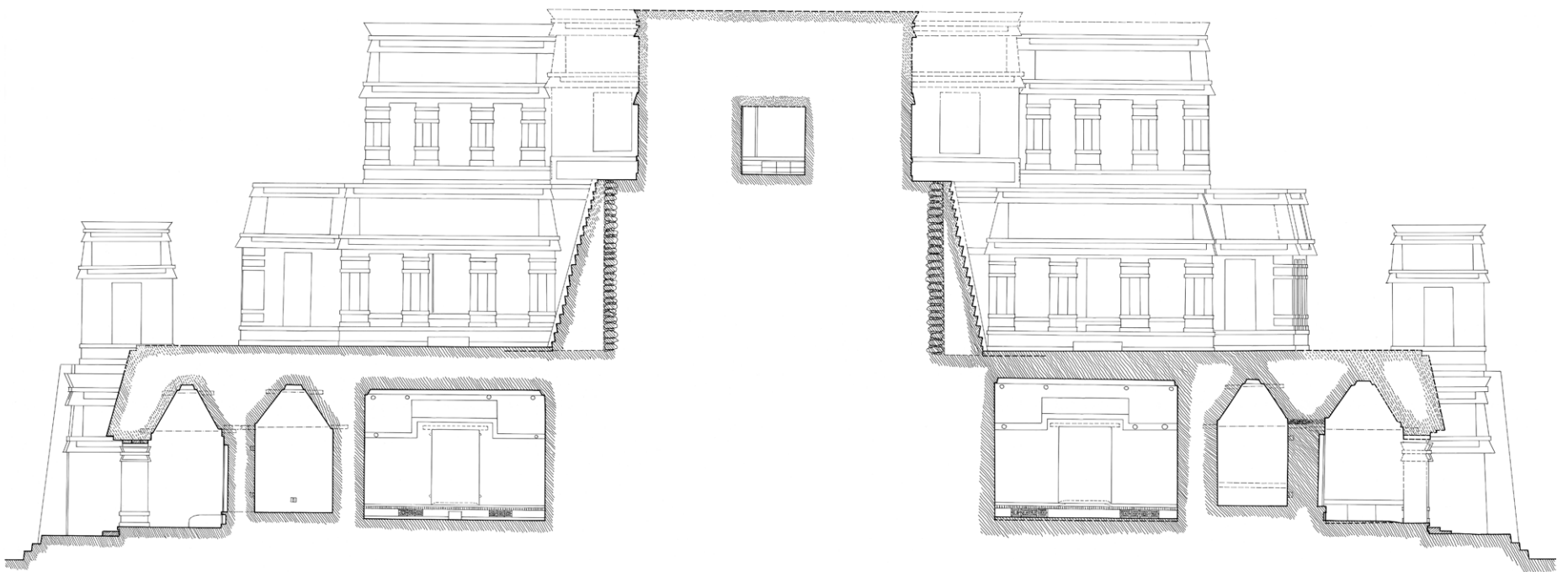
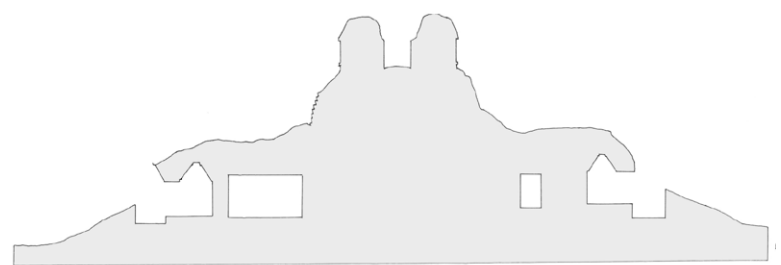

Fig. 30

S.L-35

This Section L-35 facing to the West cuts through the two pseudo Stairways B and C and the huge doorway on top of the main Stairway A. The section also shows the entrance halls Rooms 5 and 7 in front of the living spaces Rooms 6 and 8 near Stairway A. Both halls have basal moldings for the next rooms. Both moldings consist of three members. The frieze on the middle, receding part of this three-member molding shows two groups of three small carved colonnettes in Room 5, the upper cornice of the molding is decorated with a border. The basal molding in Room 7 has two groups of four small carved colonnettes. The upper cornice also has a border.

Above the passageways between Rooms 5 and 6 as well as above the one between Rooms 7 and 8 the vault zone has a special design. It has a similar form to the ones above the passa-



geway in the long Room 1 and to that above the passageway to Room 2 as is shown in the next Section L-30 on the left hand side. This section represents the over-door design above the passageway between Rooms 9 and 12 on the right hand side in profile. This section also shows the deformation of the two basal moldings in Rooms 5 and 7 caused by the high pressure stress of the inner walls.

This section is based on the geodetic survey of Erwin Heine and Andreas Reiter (Heine 1997:Plan 11; refer to small drawing).

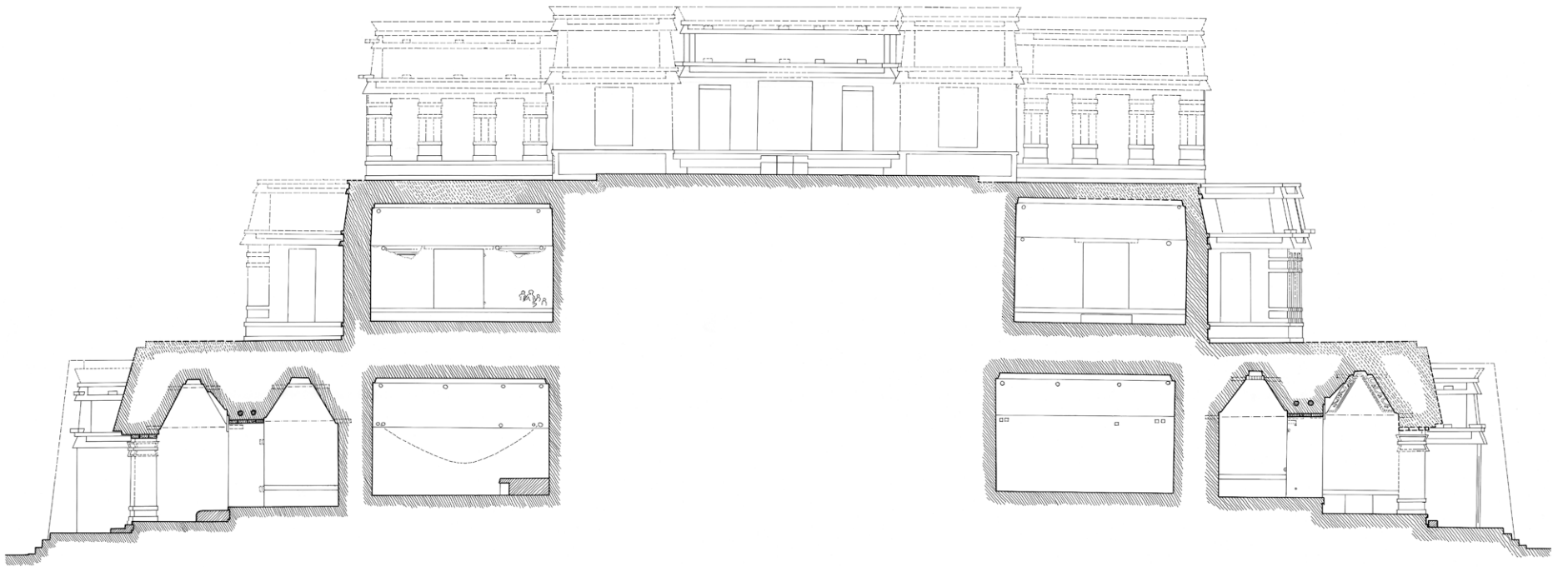

Fig. 31  
S.L-30

This Section L-30 facing to the West shows the vault forms above the passageways between Rooms 1 and 2 to the left as well as between Rooms 9 and 12 to the right. Refer also to the inner perspective of Room 1.

In Room 6 you see the bench and the two pairs of lower vault beams at the end of the room; quite certainly they functioned to hold a hammock. The single lower vault beam is positioned above the edge of the bench; it quite certainly held a curtain in front of the bench to cover and separate sleeping persons from the rest of the room.

Room 8 also shows two pairs of lower vault beams at the ends of the room. The function of the fifth lower vault beam might also have been to hold a curtain. The suggested bench in the North of the room might have been a wooden construction or it was completely pulled out by looters.

Room 29 on the second floor shows remains of paintings. There are two bands underneath the vault spring. The broader band seems to have consisted of a row of hieroglyphs. In 1999 there were also remains of a wall painting on the right wall representing at least four persons. All four faces had been destroyed. Unfortunately these paintings have disappeared completely. In September 1989 Jack Sulak fortunately documented the paintings with several photographs. In 2003 they had disappeared.



Section L-30 also provides the complete eastern façade of the five third floor rooms of the Palace as the section runs behind the huge monster mouth passageway.

This section is based on the geodetic survey of Erwin Heine and Andreas Reiter (Heine 1997:Plan 10; refer to small drawing).

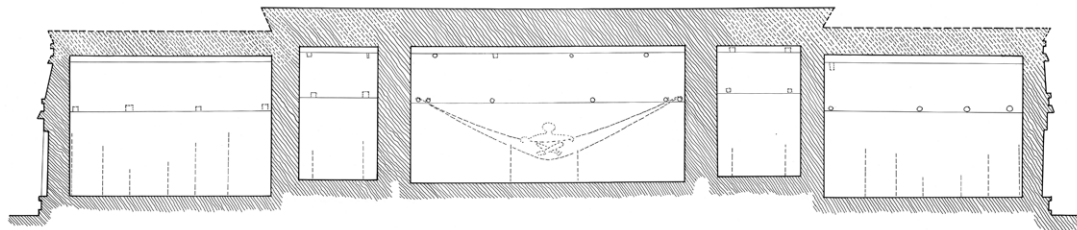

**Fig. 32**  
S.L-25 (Third Floor)

Section L-25 facing west shows only the five third floor Rooms 40 to 44. The upper vault beams cannot be complete as several portions of the five vaults are no longer complete. There are no cord holders, rod sockets or benches on this floor. Beside the two inner Staircases D and E the really steep central Stairway A was the only access to this raised area. Both staircases could be observed easily. It seems that the use of the very steep Stairway A might have been a sacrilege. Therefore this story might have been quite protected. There was possibly no need for cord holders or rod sockets for this reason.

Benches made of stone and mortar might have been a problem of weight in the upper stories. Therefore the Maya here might have used wooden benches in the case of such architectural elements. Room 42, the long central room, which is connected with the courtyard to the South, was certainly used for representational purposes. The two pairs of lower vault beams at the ends of the room were quite certainly used to fasten a hammock. We can imagine the chief of the Palace sitting in the hammock at its central point in the main axis of symmetry, visible through the entrance and the huge monster mouth doorway, receiving visitors or inhabitants of the city of Santa Rosa Xtampak. Each of the two other lower vault beams might have held a curtain. Behind them there could have been two sleeping areas consisting of wooden benches.

Rooms 41 and 43 stand on the highest level of the entire Palace, even higher than Room 42. The main persons possibly lived and slept here. The flanking Rooms 40 and 44 were possibly secondary reception rooms for Room 42.

Section L-25 facing west shows the profile of Room 33 in the North of the Palace on the second floor.

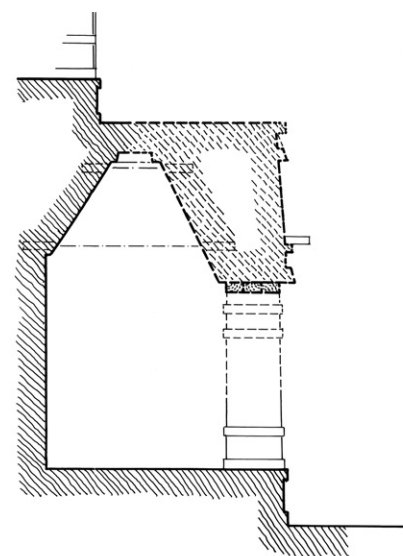

**Fig. 33**  
S.L-25 (R33)

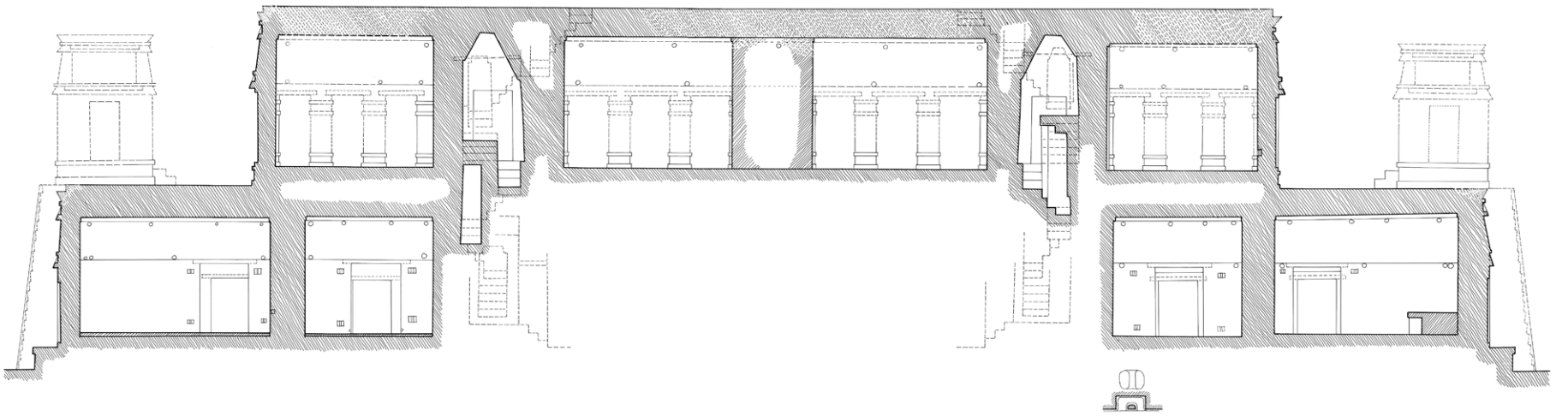
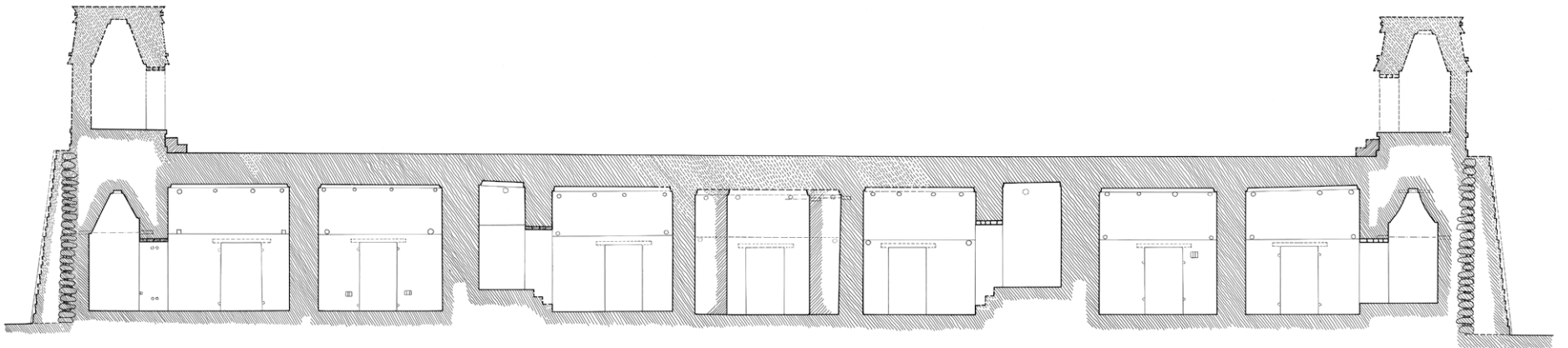
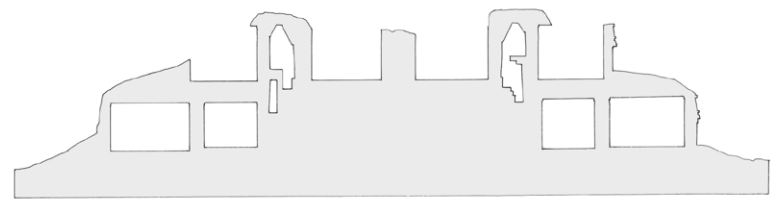
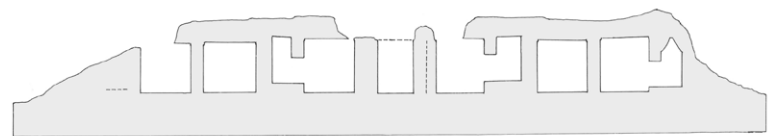

Fig. 34  
S.L-15



0M      5      10      15

Fig. 35  
S.L-10



**Fig. 34**  
**S.L-15**

Section L-15 facing west shows mainly the two staircases. In the background you can also see the entrances to the staircases. The stairs on the first floor which are not visible in this section are shown by broken lines as well as those stairs up to the third floor, which are behind the observer. In this way you can see both entire staircases and stairs as if they were transparent. This should make the complexity of these two nearly mirror image staircases more visible.

In Rooms 34, 35, 36 and 37 the observer can see the pillars from inside and also the vault beams. Within Room 35/36 you see the massive dividing block within the center of the once uninterrupted long room, which supports the central structure of the third floor.

The flanking rooms on the first floor show two inner rooms on each side, the passageways to the four outer rooms and their entrances in the western façade seen from inside. All passageways have or had cord holders to close them from inside. The passageway to Room 24 also has rod sockets near the floor on both sides but no rod sockets near the lintel. There were possibly

wooden cord holders at the edge of the lintel to fix a second door closure. There is only one bench in Room 14. All the other three rooms in this line must also have had at least one bench as the author doubts that people in these rooms slept on the floor. They had possibly already been completely destroyed by looters or they were constructed of wood, which has disappeared. All the cord holders in Room 17 and Room 14 are plastered over, only part of them were visible under the plaster. They were covered by several thin layers of white lime and have therefore a very soft rounded form. They must have been used for a long time; but in the end they were covered and no longer used.

At the sides you see the two Towers 45 and 46. The author gave them hypothetical pseudo entrances on this side, too, as they are visible from the Plaza del Palacio along the northern or along the southern side of the Palace and also from higher positions on the opposite side of the Plaza.

This section is based on the geodetic survey of Erwin Heine and Andreas Reiter (Heine 1997:Plan 7; refer to small drawing).

**Fig. 35**  
**S.L-10**

Section L-10 facing west shows all the first floor Rooms along the western façade seen from inside and the two towers at the two edges in the North and in the South on the second floor. There is only one cord holder in Room 16 and there are two in Room 23. Furthermore there are rod sockets at the entrances of the Rooms 13, 6, 23, and 25 and at the passageway between Rooms 25 and 27. Nearly all the rooms have four upper vault beams and two lower ones. The lower vault beams are always positioned near the end walls and might have held clothes, the upper ones might have held stored objects in the vault space.

The lower vault beams at the southern end of Room 21 and at the northern end of Room 19 might have served to hold a curtain to cover the inner stairways.

This section is based on the geodetic survey of Erwin Heine and Andreas Reiter (Heine 1997:Plan 6; refer to small drawing).



**Fig. 36**  
**SFa Southern Façade**

The southern façade of the Palace shows the two temple pyramids with their pseudo stairways and pseudo entrances at both ends – the eastern one standing on the large platform of the structure to the right, the western one standing directly on the same level as the Plaza del Palacio in the East.

The first floor is dominated by the large entrance hall (Room 1) to Rooms 2, 3 and 4. The massive steep undecorated roof is repeated in front of Room 9 along the northern façade of the Palace. The roof of Room 1 is supported by six pillars in total. Two of them on each side form two side risalits. The middle two carry the recessing section of this façade. There are three entrances into the long hall (Room 1) marked by steps in front of the hall.

The six pillars each consist of a three-member basis, a profiled shaft and a tethered capital. This has the form of a soft box, which looks as if it has been bound together too tightly half way up.

The quite open southern wall of this entrance hall allows the two reliefs, the two sculpted half columns as well as the four undecorated half columns on the back wall to be seen from outside. The base molding, with its groups which always consist of three small half columns, is also visible from outside.

The second floor shows a higher level in the East and a lower one in the West. On this side are two steps, on the northern side three steps leading up from one level to the other. On the edges stand the two Temples 46 and 38 with the hypothetically added pseudo entrances. They were added because all pseudo temple pyramids with very steep stairs follow the same pattern – the stairs lead up to a pseudo temple with a pseudo entrance. The dimensions of the real entrance on the northern side were adopted.

The eastern partly reconstructed temple has a thin cornice about

1 m above its base molding. Photographs from 1989 show clearly that there was nothing left of this wall at this height!. Nearly a hundred and fifty years earlier more might have survived, when Stephens (1843) wrote that there were a lot of remains of broken stucco reliefs in the debris around Room 38.

On the same floor three structures are also visible which are built together. The central one faces south; the other two face west and east. Each has four pillars at its front. Between them and Temple 38 we see the pseudo Stairway C.

Just behind it on the third floor stands the pseudo monster mouth entrance with the hypothetically added teeth of the lower jaw of the monster. Some of these teeth were found near the Palace! The large massive block at the upper end of the central Stairway A could have been the basis of the lower jaw of the monster mouth. In the west of the free standing entrance on the left hand side we see the small southern side of Room 40 and the ensemble of the five rooms on the third floor. The central Room 42 had a four-member upper molding with a projecting uppermost cornice next to the flat roof. The fourth member was reconstructed from two of the old photos by Teobert Maler with the Palace photographed from the western side. They show at least two large stones of this uppermost projecting cornice of Room 42 (Maler 1997:Fig. 171).

In the reconstruction of the third floor this fourth member is missing. It should be added at least on the façades of Room 42, as here part of it existed until the end of the 19th century. The author believes that the fourth member was also used for all the other Rooms 40, 41, 43, and 44 on the third floor and should also be reconstructed in these four rooms.

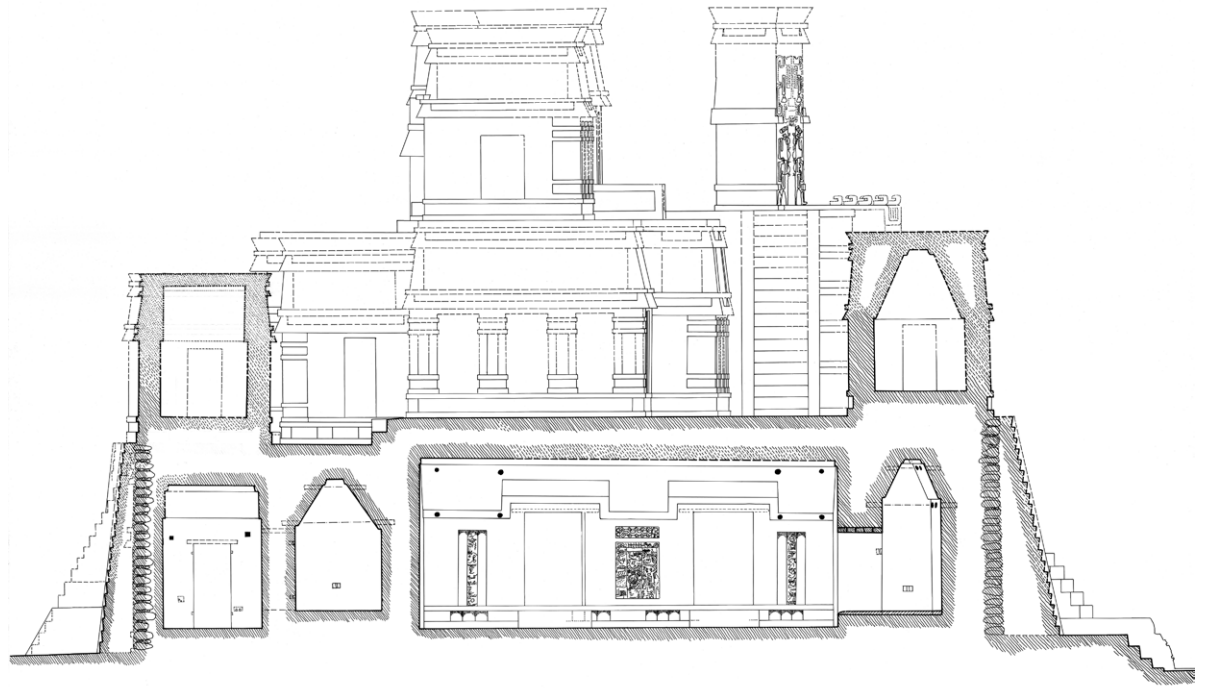

Fig. 37  
SQ-10

This section Q-10 facing north shows the entrance hall in the South (Room 1). The two relief panels in the centre are interesting. They show reused blocks of a larger relief from another earlier building. The relief blocks have obviously been put together in the wrong way. The mistakes must have been intentional. There is another relief in the northern entrance hall, where the blocks are also mixed. It seems to be a special way of showing that such reliefs did not originally belong to the building and its time. On the other hand they shall remind people of their history. It seems to be a special kind of culture of the Maya to remember important structures of the past and their inhabitants.

Another example could be Structure 1 of Chunchimai 3 in the Mexican State of Campeche. In the southern wall of this one-room building we find the so-called "Sonnenstein", the sun stone on the inside, a recycled relief stone possibly originating from an earlier structure. However the relief stone is obviously from an earlier period. It seems to be an object to remember something important from the past (Hohmann 2005:101-111). Other cultures in pre-Columbian time also knew similar ways of remembering the past by reusing older reliefs. The Zapotecs for example reused a great number of old Olmec reliefs in Monte Alban on the façades of their structures. Nearly all of these reliefs were turned head down.

The Rooms 4 and 38 are positioned one above the other. Their directions are different as are their functions.

This section is based on the geodetic survey of Erwin Heine and Andreas Reiter (Heine 1997:Plan 16; refer to small drawing).

The perspective of one of the pillars shows the side, which belongs to the façade, to the right. The pillar has a basis with a

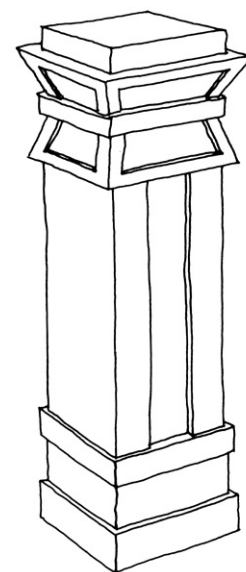
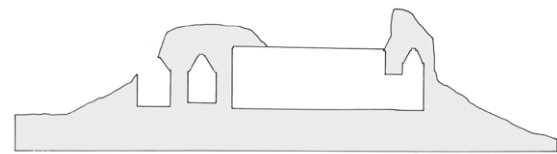

Fig. 38  
P (pillar)  
Perspective of one of the pillars supporting the massive roof of Room 1

three-member molding all around, a shaft with a vertical recess at the side of the façade and a tethered capital on top.

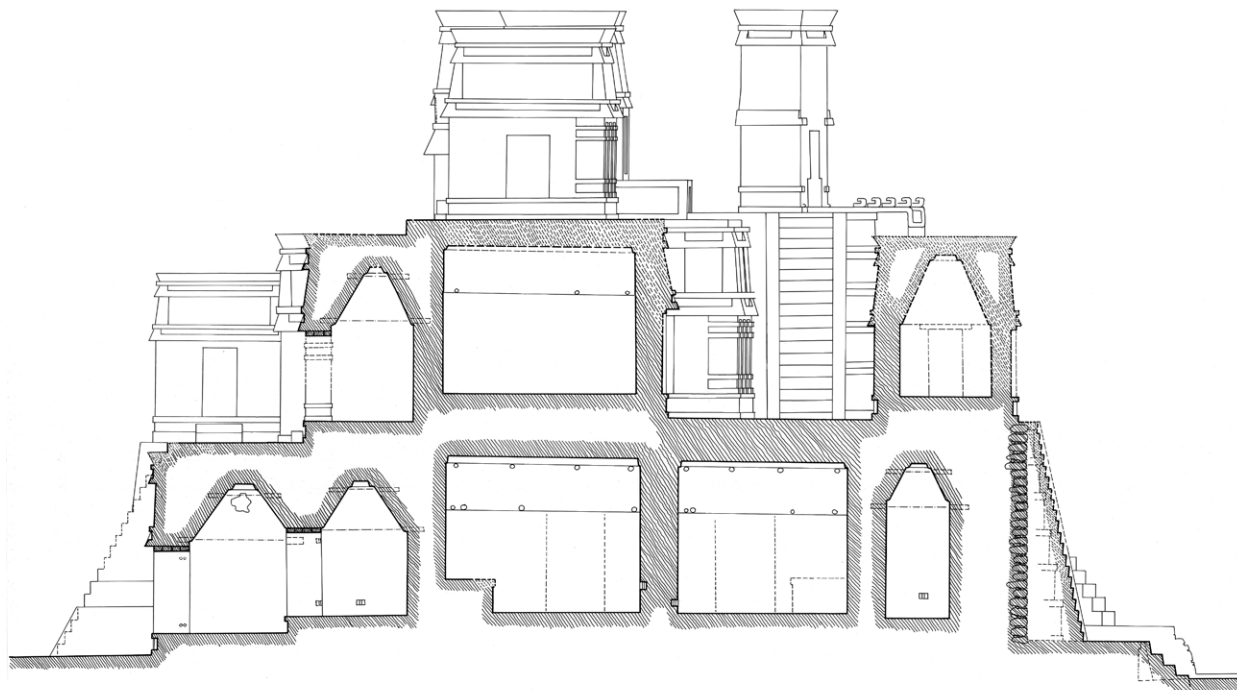

Fig. 39  
SQ-20

This section cuts through Room 25, Room 26, Room 2, Room 3, and Room 4 on the first floor from left to right and through Room 37, Room 28, and Room 38 on the second floor. The plan also shows the southern front views of Room 45 and Room 29 on the second floor and the southern front views of Room 40 as well as of the monster mouth passageway on the third floor. The section through Room 2 shows the bench. The section through Room 3 shows the stucco marks of the former bench on the northern wall, which were recognized by Antonio Benavides Castillo. The bench itself does not exist any longer.



Fig. 40  
This shows the south-eastern temple pyramid, the six mega steps to the right, the asymmetrical pseudo stairway and the southern wall of the temple. The fine horizontal stone line half way up the wall is not understandable, as there was nothing left of this wall. Only the core wall of the structure was still standing.  
Photograph: H. Hohmann 2004



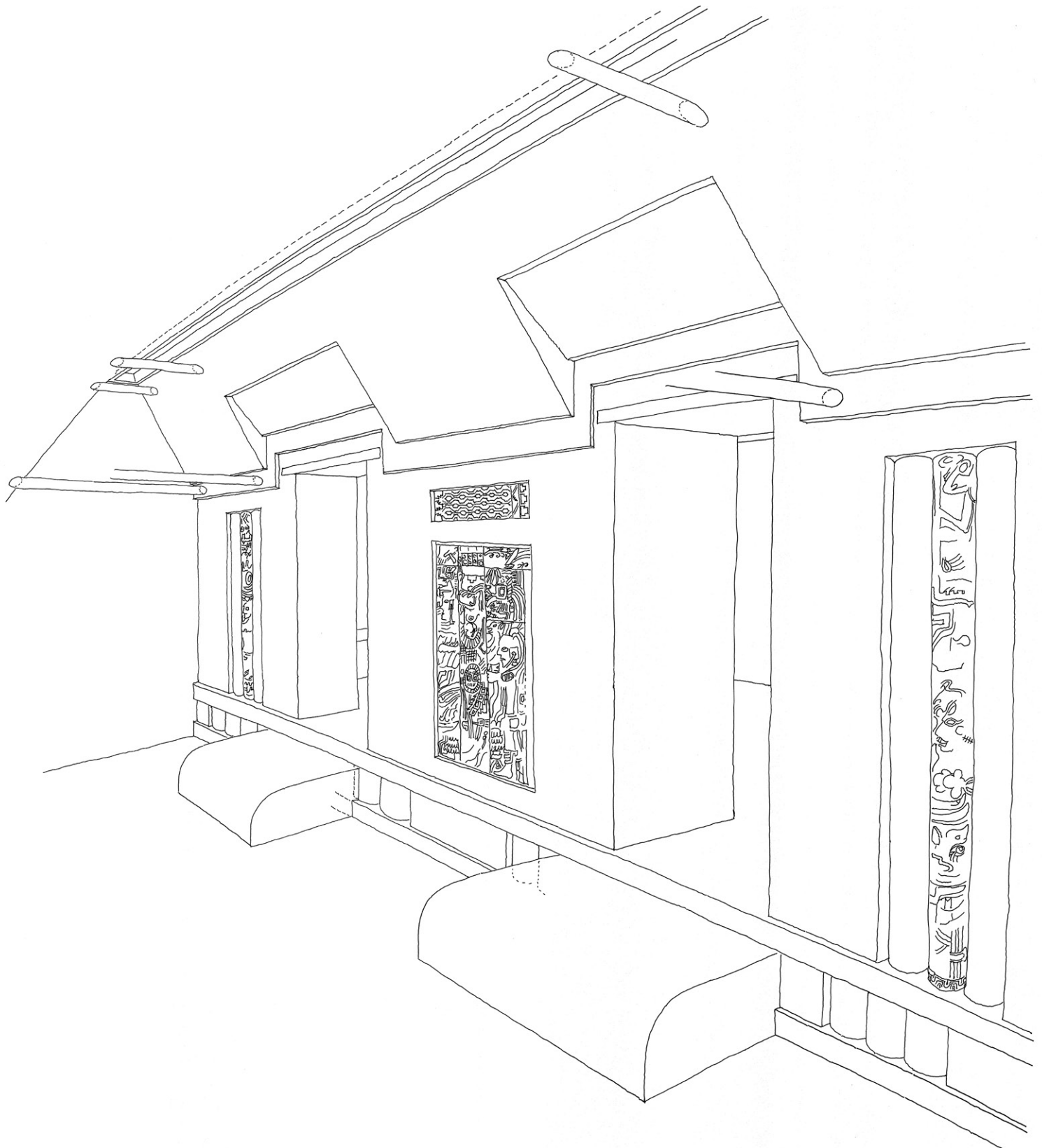

Fig. 41  
 P (R1)  
 Perspective of Room 1 looking from southeast to northwest

This inner perspective shows how creative and architecturally interesting the general form and the very fine elaborated plasterwork of the vault above the passageways was once designed. It also shows the base molding with groups of small half columns, the two central reliefs and the two groups of high half columns containing the two sculpted half columns in the centre. The reliefs consist of reused spoils from earlier buildings, which are intentionally composed in the wrong way. It documents a typical kind of remembrance culture of the Maya.

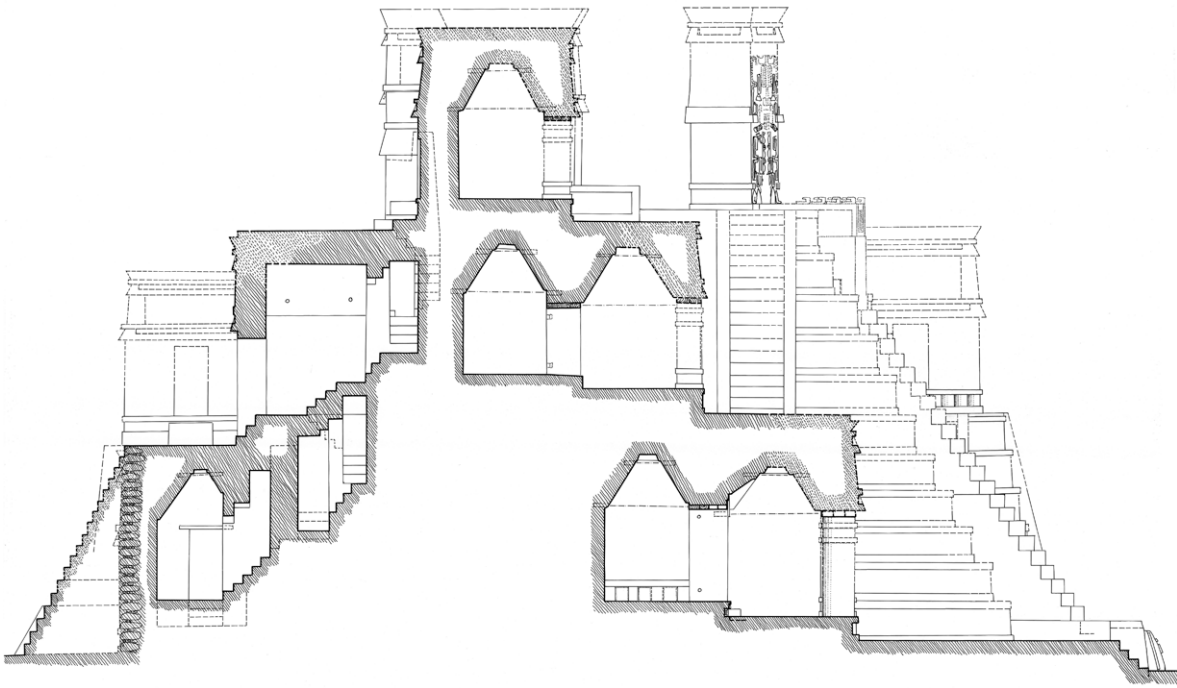
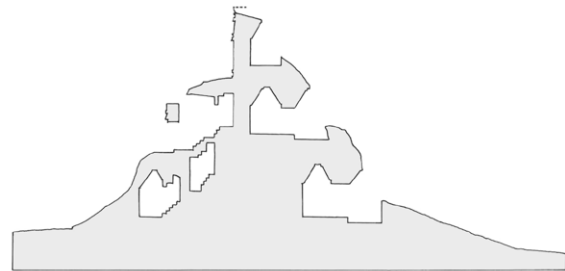

Fig. 42  
S.Q-35



Section 35 facing north shows a different section and projection of the southern staircase and Room 22 as a transit space. Room 48 is also a transit space on the second floor and the entrance from the western terrace; it gives access via this terrace to all the other rooms to the South, the East and the North on this level. All stairs of the southern staircase, even stairs which are not visible and those which are behind the observer are shown in broken lines to produce a complete visualization in combination with the ground plan and the north-south section.

A section of the outer Stairway L is represented on the western façade to the left. The steps were once measured as being approximately 15 cm on 30 cm; the angle of gradient of the stairs measures approximately  $62^\circ$  from the beginning to the top; this seems to be too steep to be really used as a stairway.

The façade of Room 5 has two pillars at its sides and two columns in the centre. The room is the reception hall for the raised Room 6 in the background. Above the passageway the vault of Room 5 shows a recessing special design in profile. Within the passage there were rod sockets used to fasten a closing element. The bench in Room 6 has three niches. The supporting elements are rounded at the front.

Room 29 on the second floor must also have functioned as a reception hall for Room 30, a living and sleeping space. The passageway could be closed with the help of cord holders at the doorway from the inside of Room 30. Room 29 shows two painted red bands under the vault spring. The broader band seems to have carried an inscription. Underneath was an interesting wall painting of which parts had survived at least until 1989; at that time Jack Sulak photographed the still existing portions, representing at least four persons. The mural painting continued around the northwestern corner on the northern wall of Room 29. In 2003 the mural did not exist any longer.

Room 40 on the third level had the remains of four pillars to the East. It is quite certain that it was possible to close the three entrances with curtains and to separate a sleeping and a living space at the northern end of the room. In cases of storms it was almost impossible to stay or sleep in this room.

This section is based on the geodetic survey of Erwin Heine and Andreas Reiter (Heine 1997:Plan 21; refer to small drawing).

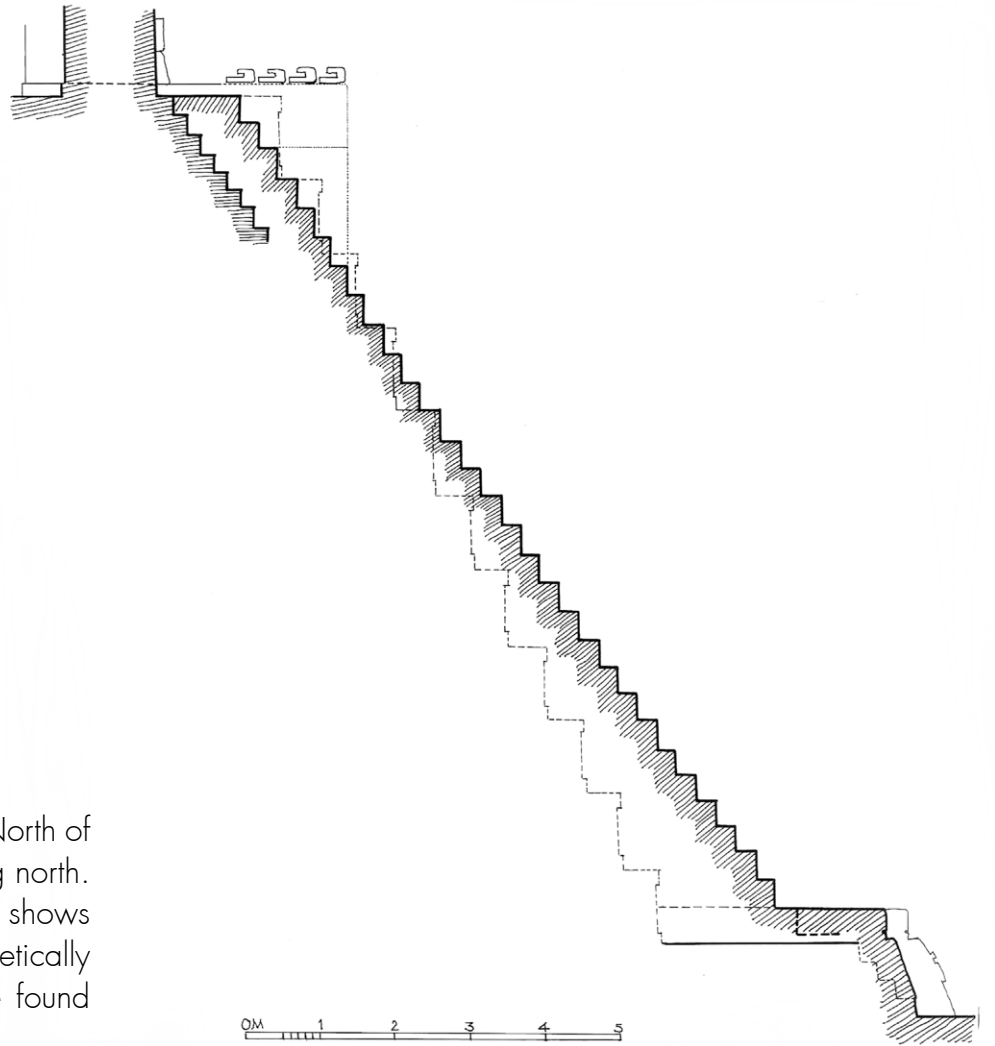

Fig. 43  
S.Q-45 (StA)

Section Q-45\* cuts through the main Stairway A in the North of the lower jaw of the monster mouth passageway looking north. It also provides a section through the earlier stairway, shows the mega steps by thin broken lines and also the hypothetically added lower jaw with some of the teeth, which were found around the Palace.

Fig. 44  
S.Q-55 (R35)

Section Q-55 faces to the North and cuts through Room 35, showing one of the pillars, the cross section through the corbelled vault including the upper and the lower vault beams and the northern wall. It also shows the three steps down to the western terrace.

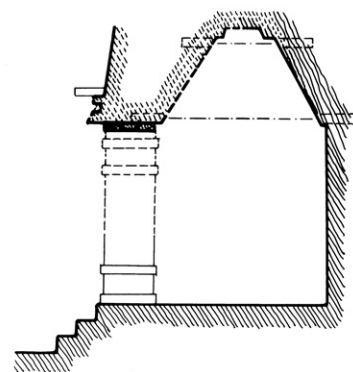
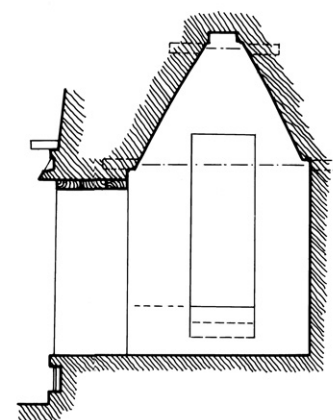
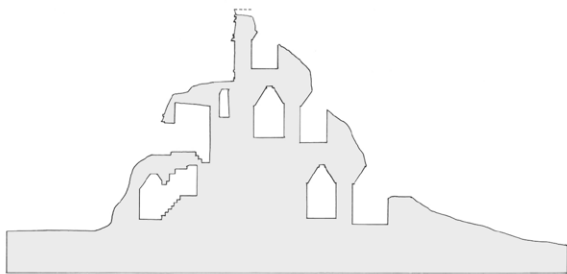

Fig. 45  
S.Q-55 (R19)

Section Q 55 faces to the North and cuts through Room 19, the entrance to the inner Staircase D. The section shows the profile of the room, its base, the corbelled vault and the passageway to Room 18 with the three steps leading up into this room.





**Fig. 46**  
**S.Q-65**

Section Q 65 facing to the North shows a section through the northern Staircase D. Especially Room 47 with the small platform and the three steps down the western terrace of the first floor are visible. It also includes the invisible parts of the stairway by broken lines. Beside this it shows most of the southern façade of Temple 45 and the complete southern façade of Temple 39.

In the East on the right hand side there are the two Rooms 7 and 8 on the first floor. You see one of the columns. On the second floor the section cuts through Rooms 31 and 32. On the third floor the section shows the half open Room 44 with one of the pillars.

The eastern wall of the upper staircase is not vertical. There seems to have been a lot of pressure stress from above – a quite strong indication that the plan for a roof comb on top of Room 42 once existed and had to be abandoned. Static problems were the reason that it was not built.

This section is based on the geodetic survey of Erwin Heine and Andreas Reiter (Heine 1997:Plan 27; refer to small drawing).

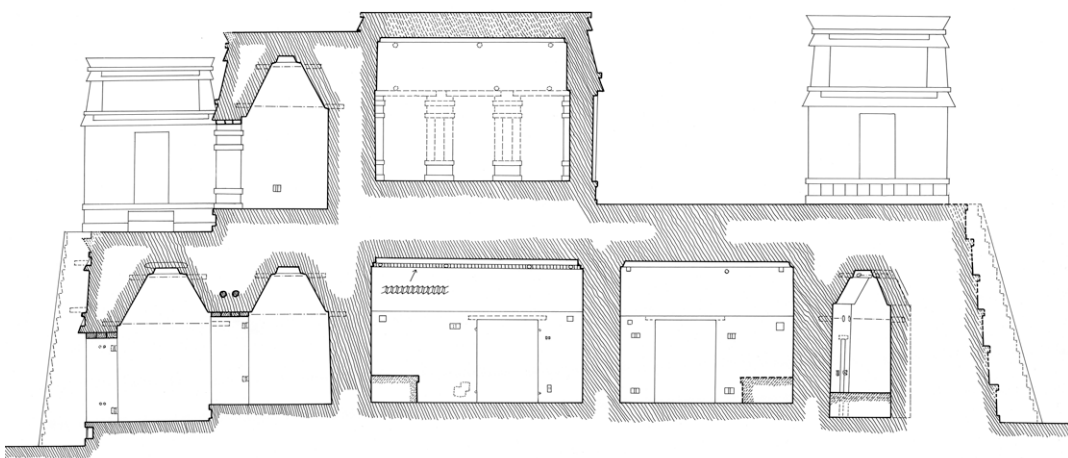

Fig. 47  
S.Q-85

This Section Q-85 facing north cuts through the Rooms 16 and 17, 12, and 11 as well as through Room 10 on the ground floor. On the second level it cuts through Rooms 34 and 33, showing the pillars from inside. The southern façades of the Temples 45 and 39 are nearly complete. The cut through the substructure of Temple 39 just in front of its southern façade shows its six mega steps as well as the sleeping Room 10 underneath in combination.

Between Rooms 16 and 17 the section also shows the two wooden reinforcements above the lintel of the passageway. The upper and lower vault beams as well as the cord holders for both rooms are also visible as are the additional rod sockets at the entrance to this living unit.

We also can see the upper and lower vault beams within the Rooms 12, 11, and 10. The four cord holders to fix the closure at the passageways to Room 9 are complete in Room 11 and one is missing in Room 12. Room 10 has only two such cord holders at the doorway in a position half way up. It is questio-



nable if this was sufficient to fix a closure at this passageway. The three benches in the three Rooms 10, 11, and 12 were all destroyed by looters before 1970, when Richard Stamps could only measure and document the plaster lines of these benches on the wall plaster. Room 12 has a two-member upper molding at the upper end of the vault. Usually there is only one. The lower one of these two members on the level of the upper vault beams is decorated with a tooth line on all four sides. This room has additional rod sockets for a different type of closure at its passageway to Room 9.

This section is based on the geodetic survey of Erwin Heine and Andreas Reiter (Heine 1997:Plan 31; refer to small drawing).

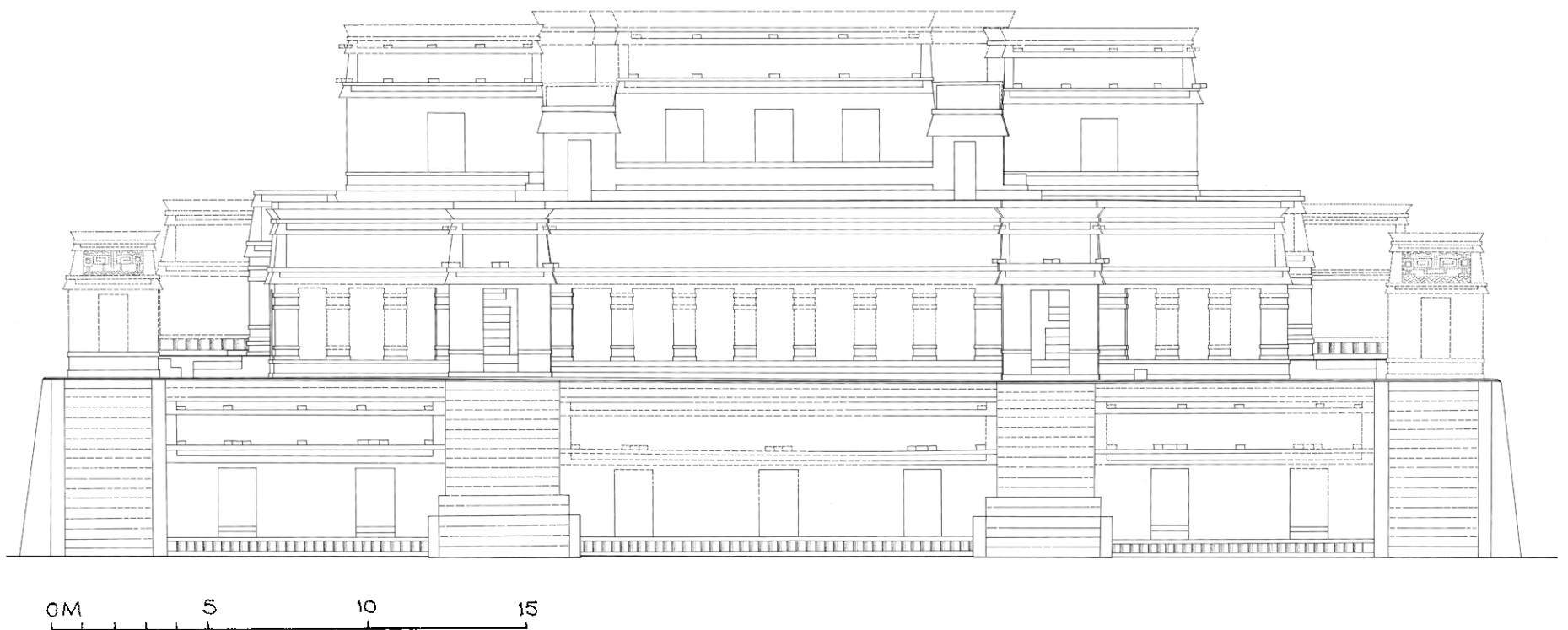

**Fig. 48**  
**WFa Western Façade**

The western façade was the best preserved façade of the Palace. Since Teobert Maler had photographed it only little had changed until Renée Lorelei Zapata Peraza started her excavations and reconstructions.

The temple pyramids at both edges had collapsed. The starting points of the four pseudo stairways were covered by the debris of their collapsed upper sections and the temples. But the two northern domestic compounds with two entrances were nearly completely intact. Even most of the corbels on the façade on the level of the vault zone were still in place. Unfortunately all the sculptures, which once stood on these corbels, had already disappeared completely.

Remains of the two pseudo stairways, framing the central "living unit" on the western façade, had survived and could be reconstructed by drawing. The recently reconstructed version is wrong. The central "living unit" itself, which in reality consisted of the two entrance halls Room 19 and Room 21 for the two inner staircases and the very small central Room 20, were in a quite bad condition. But most parts of the southern entrance of Room 21 had survived.

The northern part of the southern living units had survived but the vault sections of Room 27 and the southern part of Room 25 were destroyed.

All stairs ran down to the surrounding level of the Plaza on the opposite side. The living areas stand on a raised solid base showing a three-member profile on the façade. Two corbelling cornices frame a long row of recessing colonnettes. At the very southern and the very northern end the medial member is flat.

Zapata Peraza discovered remains of the two Temples 45 and 46 on the second floor. The northern one was better preserved and its lower section could be reconstructed. But the upper zone of the walls and the vault zone have to remain hypothetical. At the southern Temple 46 only a very few remains indicate that a similar structure once existed.

The two entrances to the Staircases D and E on the second floor were still quite well preserved. Of the flanking three structures i.e. Rooms 34, 35, 36, and 37 enough details for a solid reconstruction remained.

The structures on the third floor were nearly all in quite good condition. One of Teobert Maler's photos (Prem 1997:Tafel 171) even

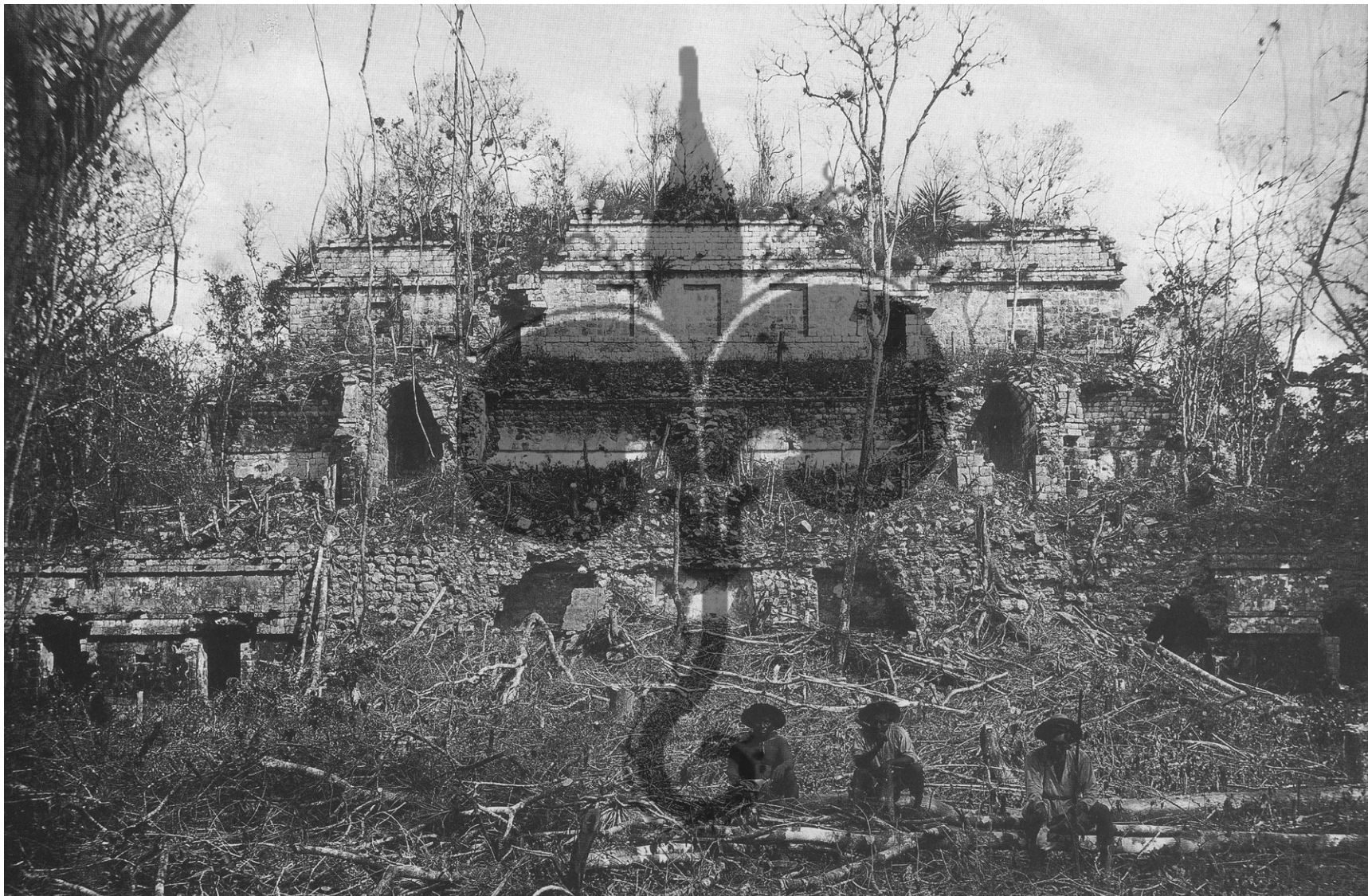

shows at least two stone elements of the uppermost coping member of the four-member upper molding of the central structure.

The two upper ends of the two staircases on the third floor are formed like two small houses with a roof, made of perishable material. But these roofs have no lower profile in most cases. The horizontal band and the very fine frame around the upper part of the roof make this roof very special.

The question about roof combs can be answered. The Maya of Santa Rosa Xtampak did not build a roof comb on top of the Palace. No remains of such a comb on the roofs of the third story could be recognized. The very broad walls underneath indicate the plan for a roof comb. The deformed wall in Staircase D (Fig. Section Q-65) and the supporting constructions in Room 20 and in Room 35/36 added later are proof of serious static problems which prevented the planned roof comb.

Corbelling stones on all three stories and on all four facades at the roof zones prove that plenty of sculptures decorated all façades of this Palace once.

The west façade is based on the geodetic survey of Erwin Heine and Andreas Reiter of 1992.

Fig. 49

This photograph by Teobert Maler shows the western façade of the Palace. On top of Room 42, the uppermost and most central room two large stones above the upper molding representing the fourth, the coping member of this four-member molding can be seen. With kind permission of Lippisches Landesmuseum Detmold.

Photograph: T. Maler 1891



Fig. 50  
S.L-10

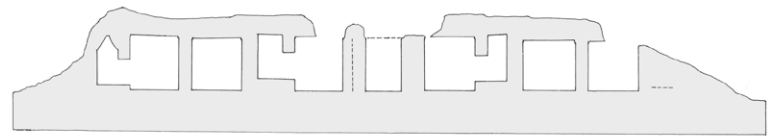

Fig. 51  
S.L-15





**Fig. 50**  
**S.L-10**

Section L-10 focusing to the East cuts the westernmost rooms of the first floor and the two Temples 45 and 46. Room 15 has a raised floor; the floor of Room 14 is also higher than the floor of Room 13. The whole of the very small Room 15 might have functioned as a huge bench. The opposite Room 27 in the South has the same floor level as Room 25. Room 17 is higher than Room 16 and Room 24 is higher than Room 23.

The two nearly symmetrical inner Staircases D and E start from the Rooms 19 and 21. Room 20 in the centre shows the added massive strengthening U-shaped wall; it is cut twice in the North and in the South. All the façades of the second and third floors have already been discussed.

This section is based on the geodetic survey of Erwin Heine and Andreas Reiter (Heine 1997:Plan 6; refer to small drawing).

**Fig. 51**  
**S.L-15**

Section L-15 facing to the East shows both staircases from the ground floor to the top. Even invisible sections of the staircases behind the viewer and also behind structural elements are represented by broken lines. In this way, in combination with the ground plan, the entire two staircases are completely documented. See also Section L-15 facing to the West and Sections Q-35 and Q-55, both facing to the North, the two cross sections in an east-west direction. Rooms 14, 17, 24, and 26 on the first floor and Rooms 34, 35, 36, and 37 on the second floor are documented. In Room 14 we see the bench, in this and in all other rooms we see the upper and lower vault beams. This section is based on the geodetic survey of Erwin Heine and Andreas Reiter (Heine 1997:Plan 7; refer to small drawing).

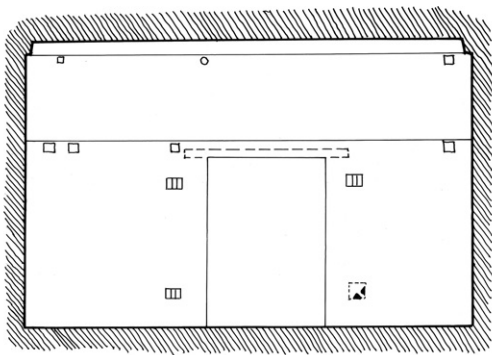

Fig. 52  
S.L-25 (R30)

Section L-25 cuts through Room 30 facing to the East showing four cord holders near the passageway, three upper vault beams and four lower vault beams. A closure could be fastened with the cord holders - the room could be closed. To the North there is a pair of vault beams. Here heavy loads could be hung. Above the northern cord holders is another vault beam. Here a curtain could separate the northern section of the room from the rest. It seems possible that a wooden bench once existed which was used as a sleeping place. The fourth lower vault beam in the very south of the room might have been used to hang up clothes.

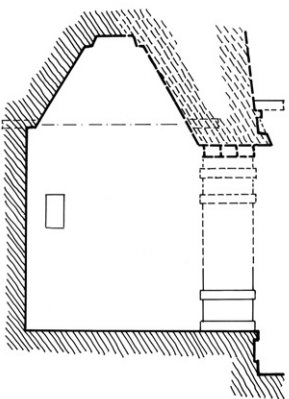

Fig. 53  
S.L-25 (R28)

Section L-25 cuts through Room 28 facing east showing the profile of the room, one of the four pillars to the right and a niche in the eastern wall. The upper vault beams were no longer visible. Only beam holes of the lower vault beams survived in the northern wall.

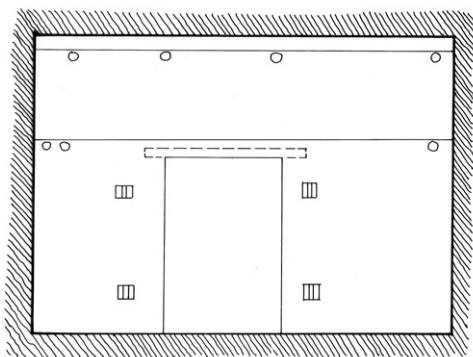

Fig. 54  
S.L-25 (R32)

Section L-25 cuts through Room 32 facing east, showing four cord holders near the passageway to Room 31. Therefore the room could be closed from inside. There are four upper vault beams and three lower ones in the room. Two of the lower vault beams form a pair and could hold heavy loads.

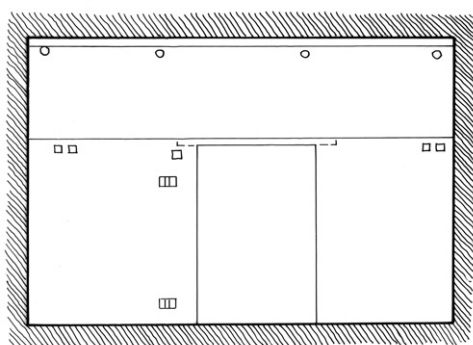

Fig. 55  
S.L-30 (R8)

Section L-30 cuts through Room 8 facing east, showing four upper and five lower vault beams as well as two cord holders north of the passageway to Room 7. Two more cord holders must have once existed south of the passageway to be able to close the room. They possibly disappeared in consolidation work. Otherwise the two northern cord holders would not make sense. The lower vault beams form two pairs of beams – two in the North and two in the South of the room. They might have carried a hammock and the user did not want to risk breaking a beam. We find two more pairs of lower vault beams in Room 6. It seems quite certain that hammocks were used in both cases. Rooms 6 and 8 on the ground floor are symmetrically positioned in the eastern façade of the Palace. The third room with two pairs of lower vault beams is Room 42, the most central room on the third floor. The three rooms form a symmetrical triangle in the façade. It seems that in all three cases important persons of the palace sat and acted in hammocks in the day time.



Section L-30 cuts through the profile of Room 2, showing the eastern wall with a cord holder in its centre. The section also provides the position of the vault beams and the passageway to Room 1, including the lintel and the base molding as well as the rounded step in the southern Room 1. The single cord holder might have been used to hold an animal, possibly a dog, taking care of the person sleeping on a bench at the western end of the room. A lot of important Maya of the Classic period had dogs. Several ceramic vessels are decorated with representations of important persons sitting in hammock litters carried by two porters including a dog walking under the litter (Hohmann 1989:94, Fig. 5 and 6).

Fig. 56  
S.L-30 (R2)

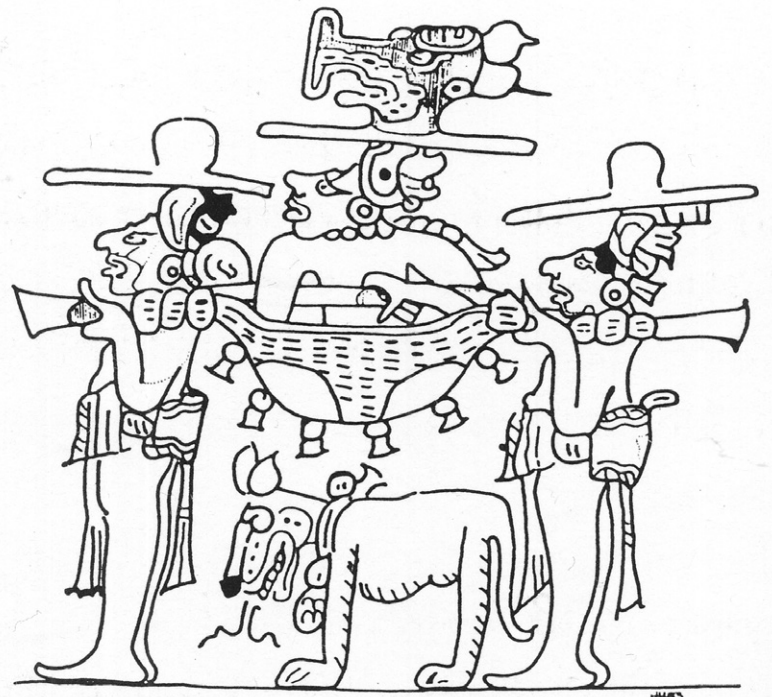
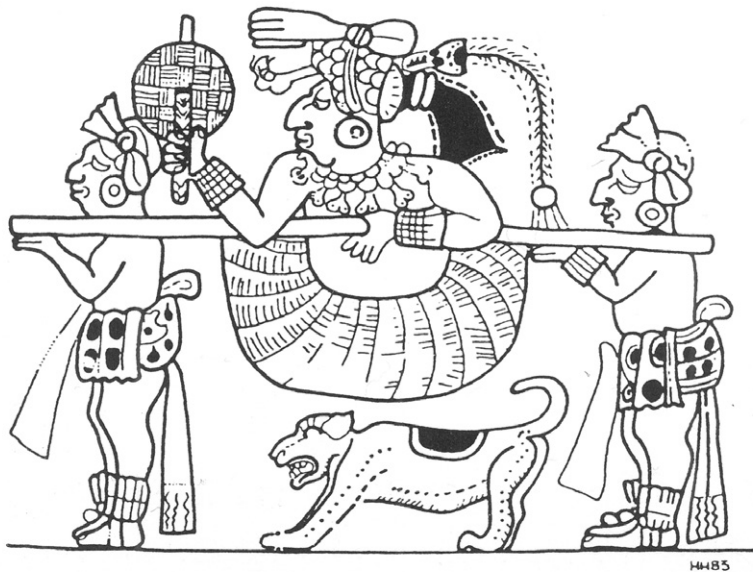
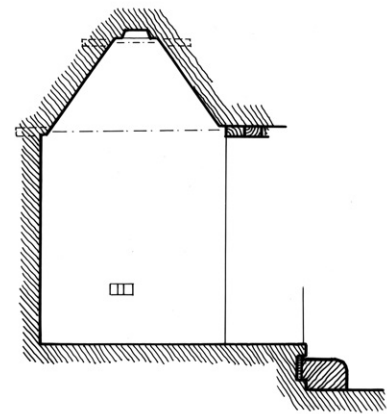

Fig. 57+58  
Litters with important persons together with dogs

**Fig. 59**  
**NFa Northern Façade**



The northern façade of the Palace shows the two temple pyramids with their pseudo stairways and pseudo entrances at both ends – the eastern one standing on the large platform of the Palace to the left, the western one standing directly on the same level as the Plaza in the East.

The first floor is dominated by the large entrance hall (Room 9) of the Rooms 10, 11, and 12. Its massive looking, steep, undecorated roof is not very usual in Maya architecture. Only two of the altogether 29 roofs at this Palace have or had such a roof - Room 1 in the South and Room 9 in the North. The roof is supported by two columns in the center and these are flanked by two side risalits each having two supporting pillars. The two columns carry the recessing section of this façade. There are three entrances into the long hall marked by steps in front of Room 9.

Each of the four pillars consists of a three-member basis, a profiled shaft and a tethered capital. Each of the two columns consists of a round shaft; in comparison with the pillars a round capital was added hypothetically. Such architectural elements can also be found in Channá in the Río Bec Region (Gendrop 1983:148 and 149) and in El Delfin some 60 km north west of Xpuhil (Merk 2015:39-43). They are also quite common in a smaller size as colonnettes in the roof zone of structures of the Puuc and of the Chenes region. Examples might be the western two corners of Structure 1 in Yakalxiú (Andrews 1995:186, Fig. 18a and 18b) and the wall zone of Structure 1 in Labna, Central Section, southern façade (Andrews 1995:73, Fig. 77).

The quite “perforated” northern wall of this reception hall allows the relief just in the center to be seen and at least sections of the seven undecorated half columns, three at the eastern end, four at the western end of this long inner wall to be perceived even from outside. Also the three-member base molding with its

projecting cornice and the rhomboid elements in the upper line and fringes below can be seen from outside.

The second floor shows a higher level in the East and a lower one in the West. On this side there are three steps instead of two as in the South leading up from one level to the other. The two Temples 45 and 39 with the hypothetically added pseudo entrances are located at the edges. A pseudo temple with a pseudo or a real entrance at all pseudo temple pyramids with extremely steep stairs follows. Therefore pseudo entrances have also been added here hypothetically. The dimensions of the real entrances at Structures 45 and 39 gave the size of these pseudo entrances on the northern façade of the two structures.

On the second floor three further structures are visible which are built together. Each has four pillars on its façade. Between them and Temple 39 we see the pseudo Stairway C leading from the second level to the third.

Just behind it on the third floor stands the pseudo monster mouth entrance with the hypothetically added teeth of the lower jaw of the monster. Some of these teeth were found near the Palace on the Plaza level. The huge massive block at the upper end of the central Stairway A possibly formed the basis of the lower jaw of the monster mouth. West of the free standing passageway the short southern side of the ensemble of five rooms on the third floor is visible. The center of the façade of Room 44 is dominated by a huge pseudo entrance.

The projecting uppermost cornice next to the flat roof was reconstructed from two of the old photos by Teobert Maler (Maler 1997:Abb. 171). Maler took both photographs in 1891. They show the Palace from the western side and at least two stones of the uppermost cornice above Room 42 can be seen in situ. On top of the roof no remains of a roof comb are visible.

Fig. 60  
S.Q-95 (R15)

Section Q-95 cuts only through Room 15 showing its southern wall with the passageway to Room 13. There are two upper vault beams and two lower ones. Next to the door are two cord holders to the left and to the right there is only one in the upper position. The lower one is missing. The passageway to the South could once have been closed by a closure. The entire room might be interpreted as a raised sleeping area for a whole family.

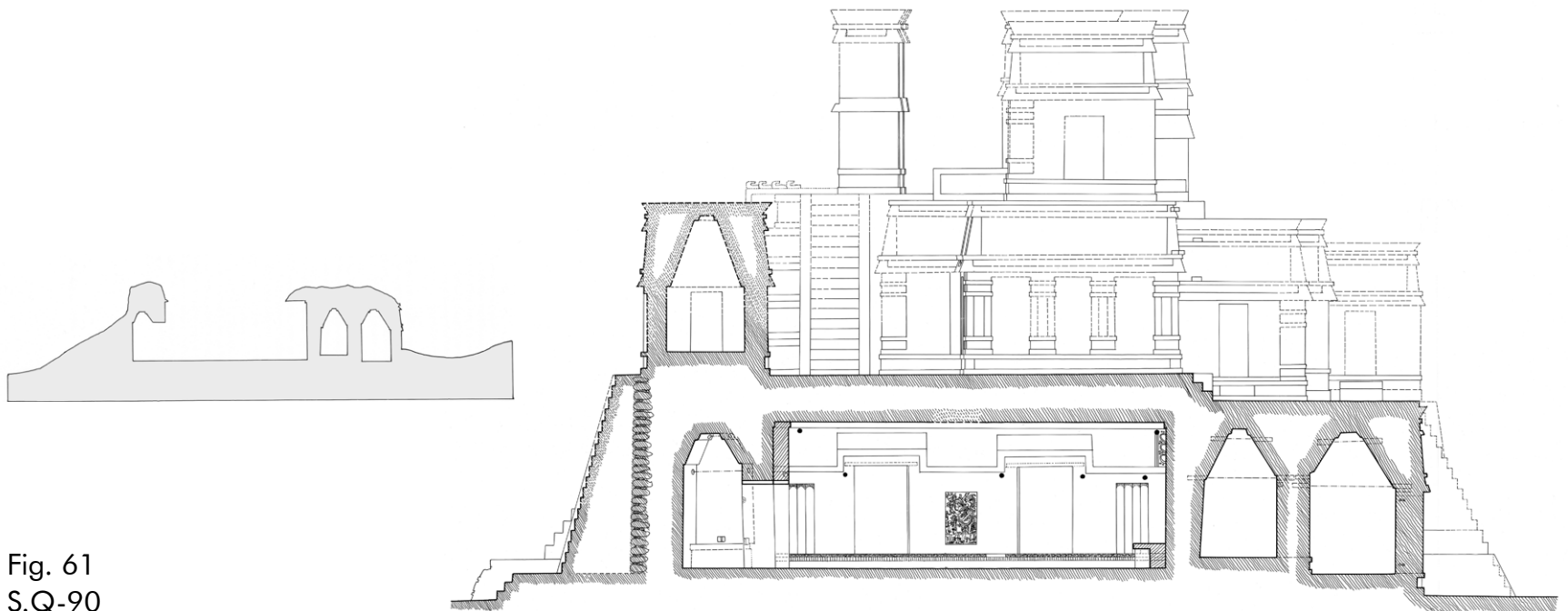
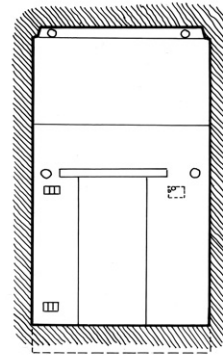

Fig. 61  
S.Q-90

Section Q-90 shows Room 10, Room 9 together with its southern wall and the passageways to Rooms 11 and 12 and also the profiles of the western Rooms 14 and 13. Room 10 under Temple 39 has a completely different direction compared with the rest of the Palace; only Room 4 also has a similar deviation. The directions of their vault axis of both rooms seem to “focus” on a point under the main Stairway A. The bench in Room 10 is reconstructed by drawing following the measurements of Stamps. There are vault beams on both levels and also cord holders.

We also see the relief in the center of the room and the seven half columns at its ends. The profile of the bench shows clearly that it was added later as it covers the lower part of two of the half columns. Above the bench we see a section of the vault painting which could be reconstructed by drawing. The three-member base molding is composed of obviously recycled, often not perfectly fitting relief stones with rhomboid elements and fringes from an earlier building. To the right of the relief in the southern wall of Room 9 a section of the base molding uses a stone with fringes but no rhomboid elements. This interrupts the long frieze.

Once there were at least seven vault beams on two levels in Room 9. One was later covered by the secondary, strengthening wall addition to the left at the eastern end of Room 9.

At the western end of this room we find the quite well preserved remains of a vault and wall painting on the southern half of the vault. Remains show that it once continued around the corner to the western gable wall of the room. The painting was first reported by Teobert Maler (Maler 1997:214) and represents geometrical and possibly astronomical elements and other forms. There might even be the remains of one or two figures within the oval elements.

Rooms 14 and 13 had vault beams on two levels. Room 14 had cord holders, Room 13 rod sockets. The profile of the western façade survived nearly completely.

On the second floor Section Q-90 cuts through Room 39, the temple at the northeastern corner of the Palace, also showing the entrance in the southern side; the roof sections have to remain quite hypothetical as no remains have survived.

The façade of the rest of this drawing has already been described under “Northern Façade”.

This section is based on the geodetic survey of Erwin Heine and Andreas Reiter (Heine 1997:Plan 32; refer to small drawing).

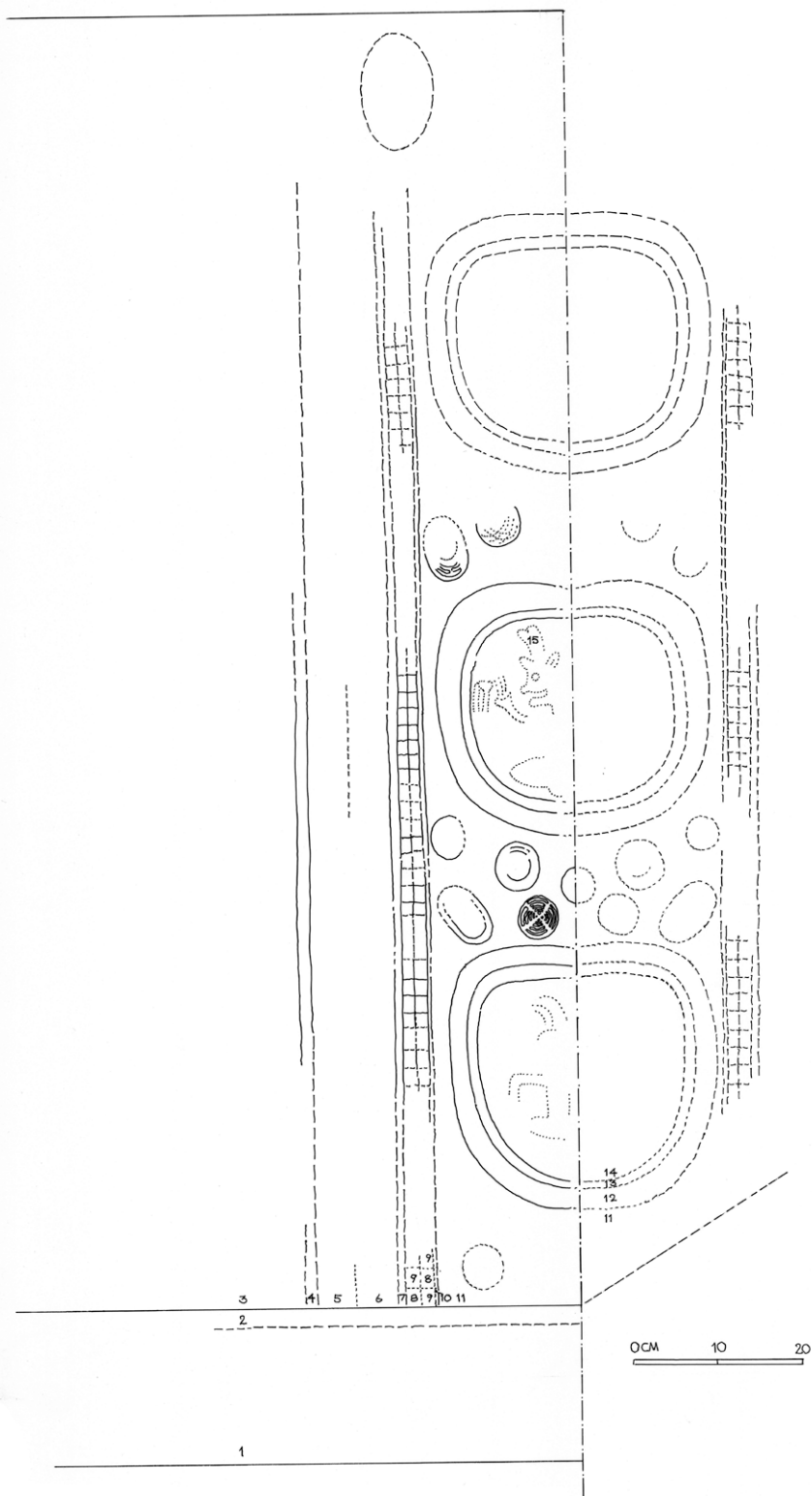

Fig. 62  
Detail S.Q-90\* (R9-Mural Painting)

The remains of the vault painting and wall painting at the western end of Room 9 consist of geometric elements and of other curved oval ones. As already mentioned above, Teobert Maler (1997:214) documented the remains of the painting by drawing and verbal description. Maler already realized that the painting went around the corner from the vault to the western gable wall. The motifs also used to continue down the southern wall. Figures 1 to 15 describe the colors in this new documentation:



Fig. 63  
The mural above the bench in Room 9.  
Photograph: H. Hohmann 2001

- |                          |                  |
|--------------------------|------------------|
| 1. dark lilac            | 9. light yellow  |
| 2. red                   | 10. light yellow |
| 3. white                 | 11. dark lilac   |
| 4. yellow                | 12. green        |
| 5. light yellow          | 13. yellow       |
| 6. yellow                | 14. orange       |
| 7. green on light yellow | 15. light green  |
| 8. dark lilac            |                  |

It seems that figures are represented in the large orange fields; the small round elements could represent stars. The oval objects could not be interpreted. The geometric bands seem to be the frame for the oval elements. They might have been decoration and symbols in one.

Section Q-50 cuts along the axis of symmetry through Room 20 on the first floor at the western side. It shows the strengthening wall added later on the eastern side of Room 20. The addition is not only on the left, eastern side of this room but also in the North and in the South like a huge "U" in the ground plan. Therefore this room is not only very isolated but also one of the smallest in this Palace. The supporting construction takes up more than 50% of the room.

Section Q-50 shows the profile through the most central Room 42 on the third floor with the asymmetrical corbelled vault together with the upper and lower vault beams, the lintel of the central entrance, the two different walls in the East and the West, the hypothetically added roof comb on top of the roof, which was once planned but was never built due to massive static problems, and the three stairs leading down into the courtyard behind the monster mouth pseudo entrance, which might have been used for non-public discussions and conferences.

Section Q-40 cuts through Room 21 on the first floor on the western side, showing its southern wall, the passageway to Room 22 as well as the three steps leading up to this room and the southern staircase and showing the profile of Room 21 and the entrance from outside. The profile also represents the position of the upper and lower vault beams.

Section Q-30 represents the profile of Room 40 on the third floor at the southern end of the Palace. We can see one of the pillars and the position of the upper and lower vault beams. There were no cord holders. It might have been possible to close the room visually by curtains but Room 40 as well as Room 44 could not have been used for living purposes. They might have been used for representational purposes.

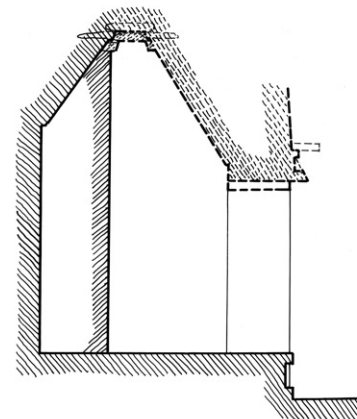

Fig. 64  
S.Q-50 (R20)

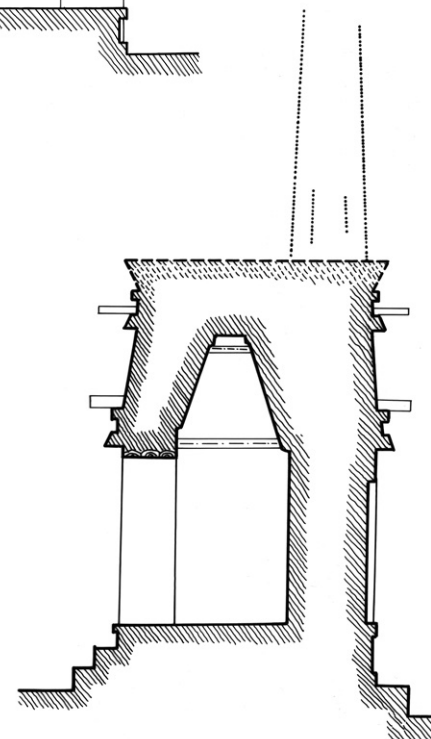

Fig. 65  
S.Q-50 (R42)

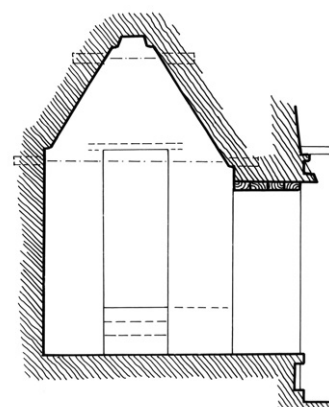

Fig. 66  
S.Q-40 (R21)

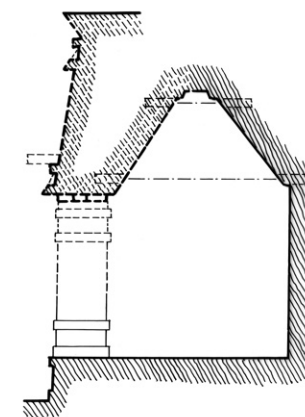

Fig. 67  
S.Q-30 (R40)



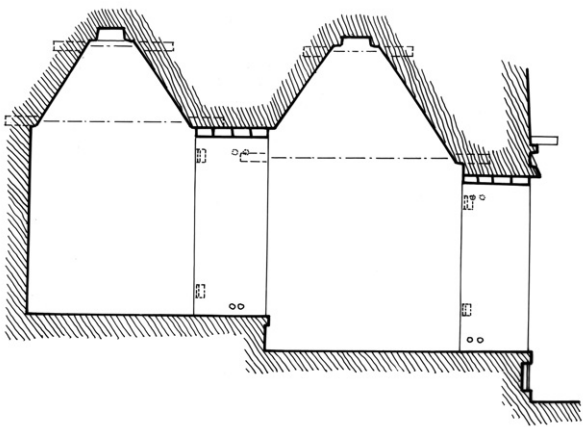

Fig. 68  
S.Q-25 (R23/24)

Section Q-25 shows the profiles of Room 23 and Room 24 including the southern walls of both rooms. Both rooms form a two-room unit. Room 23 is a passage room for Room 24. Both rooms have cord holders and these could be closed from inside; this means that the users of Room 24 had to open both doors to get outside. Only Room 24 provided full privacy. The users of Room 23 always had to be aware that a person from Room 24 wanted to cross their room.

This was possibly the reason for a second closing system at both doors – indicated by rod sockets. It seems quite certain that the closures of these rod sockets could be used from both sides, always to be used from the side from which it was first closed. This means that children could be closed in Room 24 from Room 23 and the users of Room 23 could also close the entrance from inside to have privacy in this room.

Rod sockets could always be installed later! But cord holders usually had to be put into the walls when the Palace was erected if they were to provide maximum security.

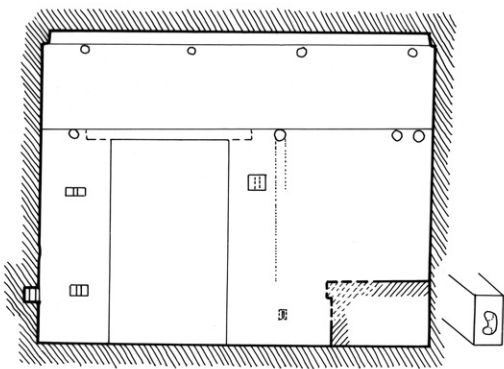

Fig. 69  
S.Q-20 (R2)

Section Q-20 cuts through Room 2 showing its southern wall. The cut shows the four cord holders near the passageway to Room 1 and one more cord holder to the left, possibly to attach a dog. There are four upper and four lower vault beams. The two western lower beams form a pair and could have been used to carry heavy loads. The next one is positioned in front of the sleeping bench and might have held a curtain to hide the person sitting or sleeping on the bench in this room.

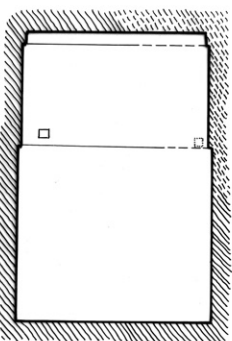
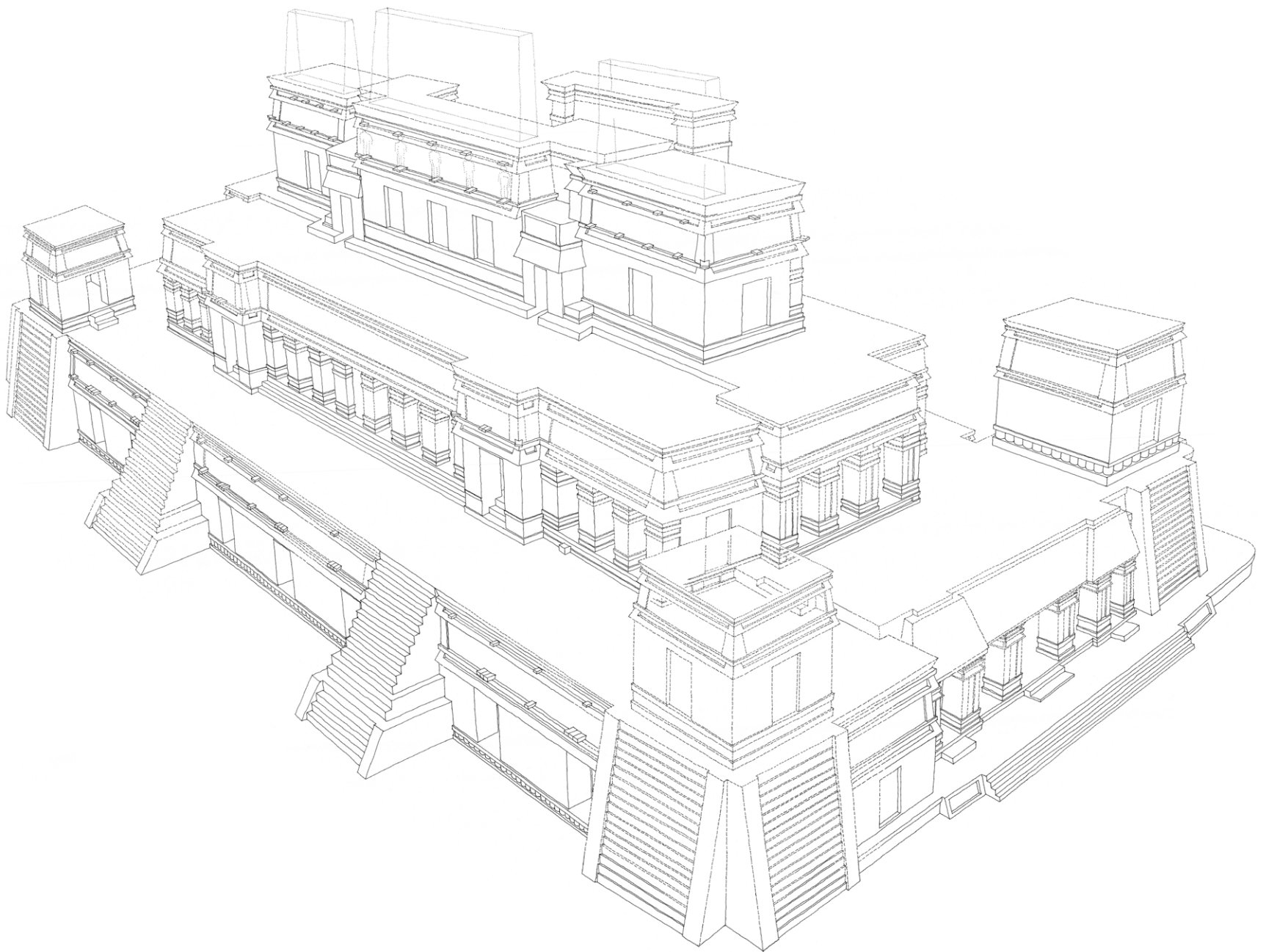

Fig. 70  
S.Q-10 (R27)

Section Q-10 shows the southern wall and vault of Room 27 under the south-western temple. It just gives the information of the position of the two lower vault beams; the upper beams are missing; for reasons of symmetry they quite certainly existed as Room 15 also has upper beams at the other end of the western façade.



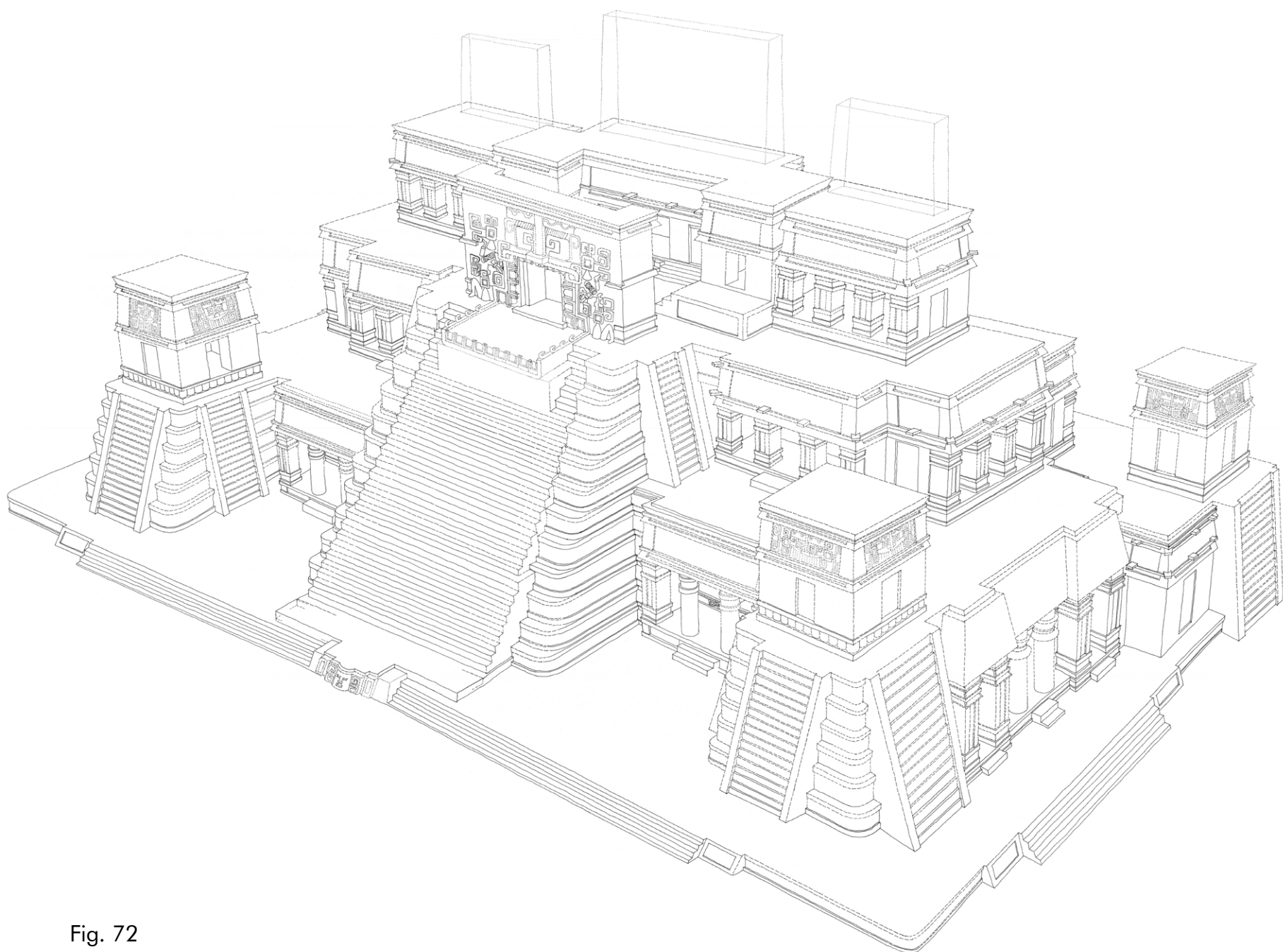



**Fig. 71**  
SWP bird's-eye view from the Southwest

It was possible to use quite a lot of sections of the western and southern façades which still existed to produce this perspective. The drawing shows three of the four small temple pyramids at the edges of the Palace and the two stairways at the western side leading up to the two pseudo temples – Rooms 47 and 48. The Palace itself has a quite massive construction on the first floor along the right, the western side; it is quite open to the South. The second floor is also quite open all around. There are no closed façades. But the third floor is completely closed to the West and the South. There are only two wall openings to the West at the ends of the two Staircases D and E in the West. The entrances to the two staircases on the first floor in the western façade are not marked in any way. All entrances along this side have the same size and distance from each other. It seems that non-locals were not to know how to reach the upper stories. The

entrances to the staircases are the third and the fifth entrance counted from the corners of the Palace in the western façade. Above the uppermost roofs three roof combs have been hypothetically added in dotted lines. The entire construction of the palace and the breadth of walls under the hypothetical roof combs indicate that the plan once existed to build such combs, but static problems prevented their construction. Behind the third floor rooms the upper section of the rear side of the pseudo monster mouth entrance is visible. Its orientation differs slightly from the other visible parts of the Palace. This perspective is based on the geodetic survey of Erwin Heine and Andreas Reiter of 1992. An unpublished perspective of Heine showed mainly contour lines; one third of it was used for this reconstruction drawing by Hasso Hohmann.



**Fig. 72**  
NEP bird's-eye view from the Northeast

This perspective is the main view of the Palace, showing three of the four smaller temple pyramids at the corners of the Palace, the central "Pyramid" with Stairway A and the pseudo Stairway B together with the mega steps and the huge monster mouth passageway in front of the small courtyard on the third floor.

On the first floor the visible part of the Palace represents three "houses" with a mixture of pillars and columns, on the second floor five "houses", each with four pillars and two more open structures on the third level. In the center on the third level we also see the three most central structures Rooms 41, 42, and

43. All three might have been used for domestic purposes for the most important persons of the Palace. On top of the uppermost roofs three roof combs have been added hypothetically. They were only planned but not implemented due to many serious static problems.

The entire eastern part – the much larger part of the Palace complex – stands on a raised platform. Only the rooms of the western side stand directly on the common level of the Plaza del Palacio.

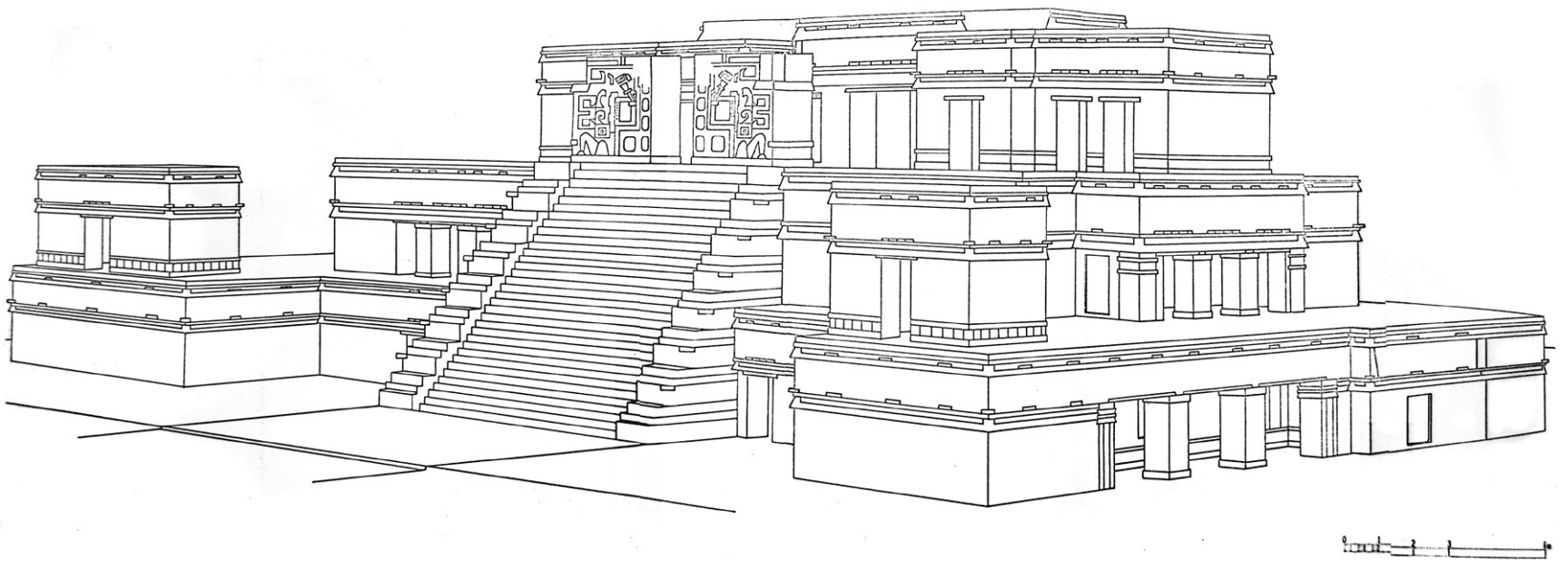

Fig. 73  
Stamps' perspective 1970:39, Fig. 4

At least one of the first or the first perspective of the Palace seen from the Northeast was published in 1970 by Richard Stamps (Stamps 1970:39, Fig. 4). It still shows only two supporting pillars for Room 9 and has no pseudo stairways between the first and the second floor. He did not realize that Stairway C, which was also visible at that time, had a counterpart, here named Stairway B. Nevertheless, with his knowledge – without excavating – the perspective gives a good impression of the Palace.

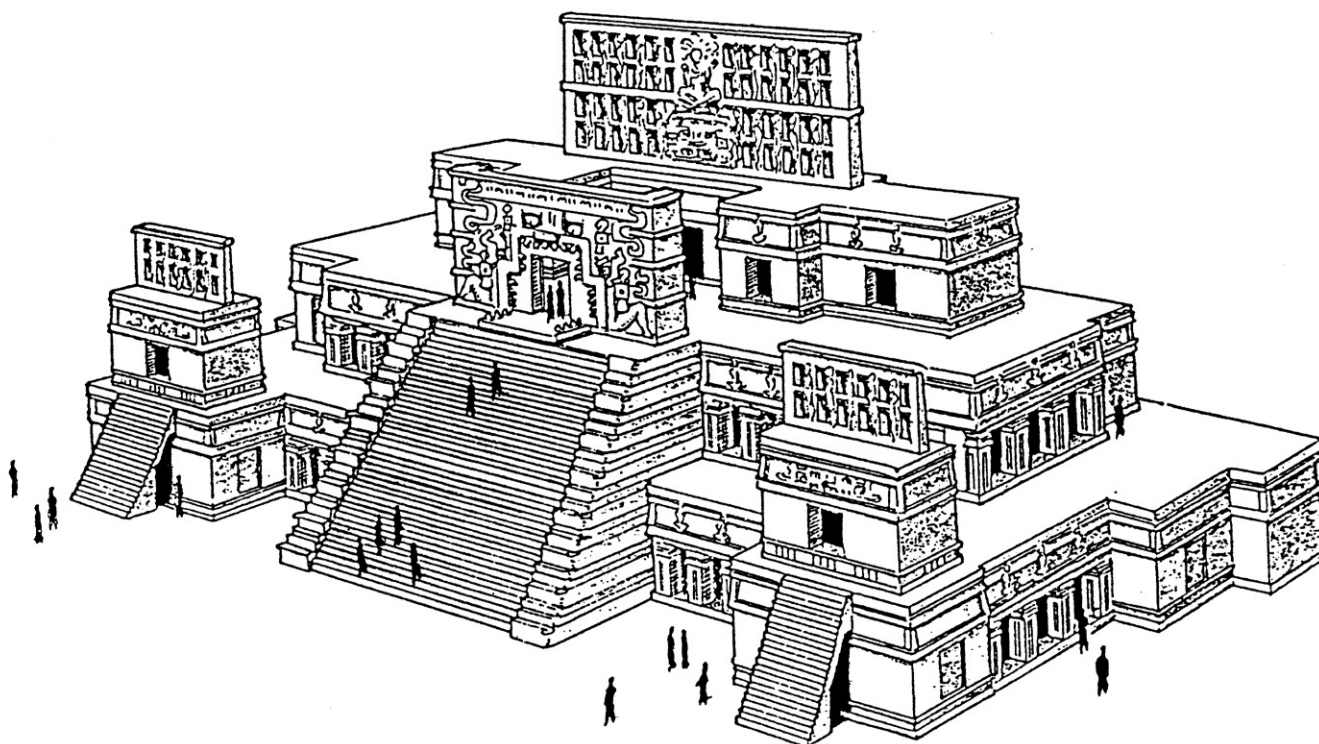

Fig. 74  
Gendrop's perspective 1983:74, Fig. 46a

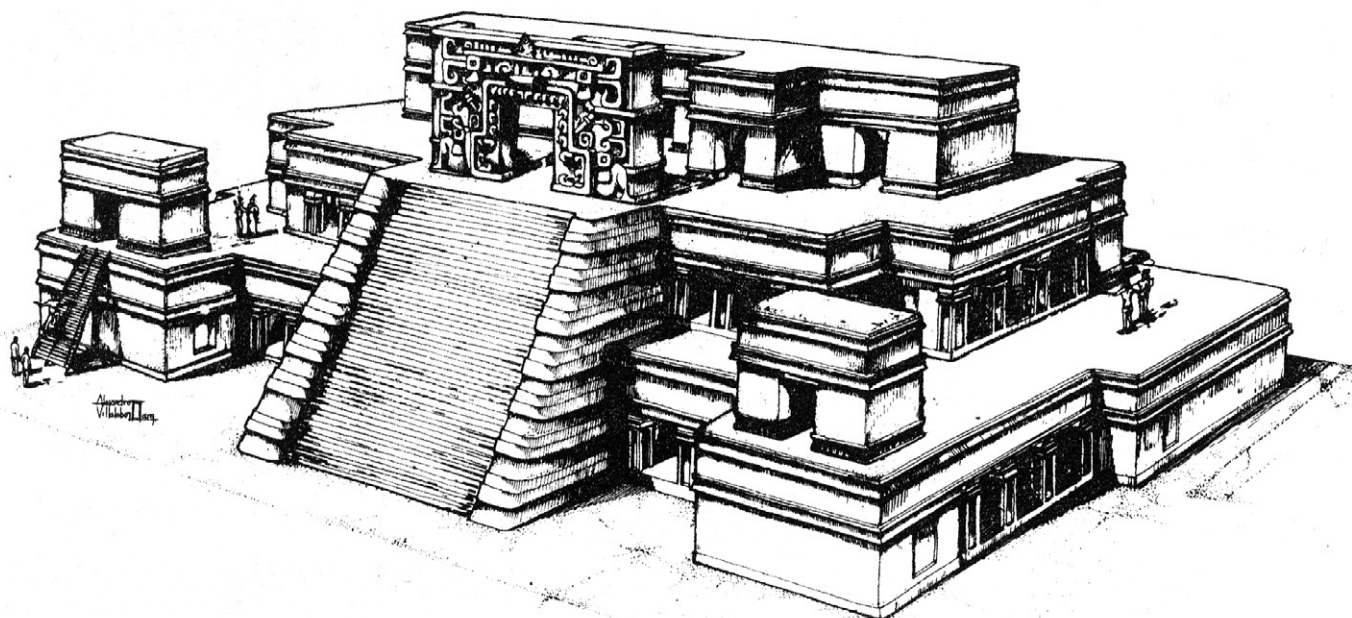

Fig. 75  
Alejandro Villalobos 1986  
Cuadernos No. 10:73, Fig. 48

Paul Gendrop's perspective (Gendrop 1983:74, Fig. 46a) also shows the Palace from the Northeast with a huge roof comb on top of the third floor and stairs leading up to the two eastern temples. They also have roof combs. He uses only two supporting pillars for the northern side of Room 9 and does not show pseudo Stairway B as the counterpart of the pseudo Stairway C, which was also known at that time. His perspective is less ascetic than the one of Stamps, has light and shadow and shows quite a lot of hypothetically added building sculptures.

The perspective of Alejandro Villalobos of 1986 showing the Palace from the Northeast (Andrews 1987:73, Fig. 48) might be based on Gendrop's. Villalobos took the roof combs and even the stairs in front of the eastern temples on the second floor away.

## DESCRIPTION OF THE DIFFERENT ROOMS

### Abbreviations

D=direction  
E=east  
F=floor  
Fa=façade  
GP=ground plan  
L=north-south section  
N=north  
P=perspective  
Q=east-west section  
R=room  
S=south  
S.=section  
St=stairway or staircase  
W=west

### FIRST FLOOR

The description of the architecture of the Palace, of its excavated remains will include a discussion about its architectural consolidation both ancient and recent, and reconstruction. It also includes inductive as well as hypothetical differing additions of the author by drawing. In some cases it discusses the reconstructed version on the site. The abbreviations at the beginning have the following scheme: plan or section-no., view direction. They give the reader the advice to check the other mentioned sections, too.

#### Room 1

Please also refer to: GP1.F; S.L-35DW; PR-1; S.L-30DW; S.L-35DW; S.Q-10DN

Room 1 in the South of the Palace is east-west oriented and its breadth measures 2.26 m and its length is 11.07 m. Along the northern wall are two passageways leading to Room 2 and Room 3. In the East there is a third passageway leading to Room 4. In the South there are five entrances. The large open space between the western pillar and the eastern one in the southern façade of Room 1 measured approximately 10 m in length. Even in 1999 the rubble did not show any remains of supporting elements such as columns, pillars or walls in the right position. Stephens and Catherwood did not discuss how the southern half of the vault of Room 1 was supported in this large open entrance zone. Maler assumed two wall sections as supports of the

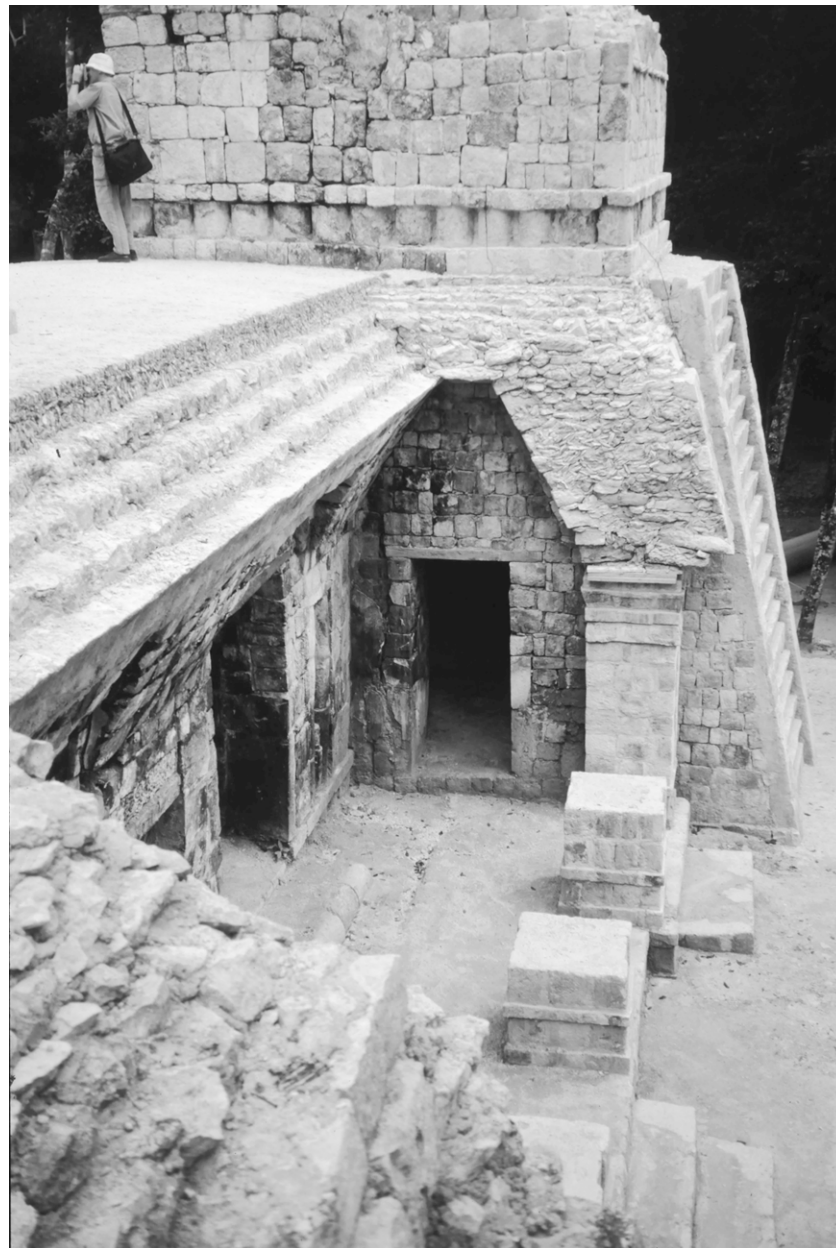

Fig. 76

View from west to east into Room 1. We see the entrances of Room 4 in the centre and Room 3 to the left. The slight risalit along the pillars is visible to the right.

Photograph: A. Drexler 2004

missing half of the vault and added them hypothetically to his ground plan (Maler 1997:213, Fig. 1-2). This would have been possible seen from the view of a structural engineer. Ruppert (Pollock 1970:49, Fig 58) as well as Stamps (Stamps 1970:Fig.6) and also Gendrop (Gendrop 1983:46, Fig.4) suspected two pillars as supports within this opening. In this case the three entrances would have been almost three meters wide, which was technically nearly impossible for the Maya with the great weight of the vault. The lintels would have had to carry the entire massive half of this section of the vault. At the beginning of his research on the Palace of Santa Rosa George F. Andrews

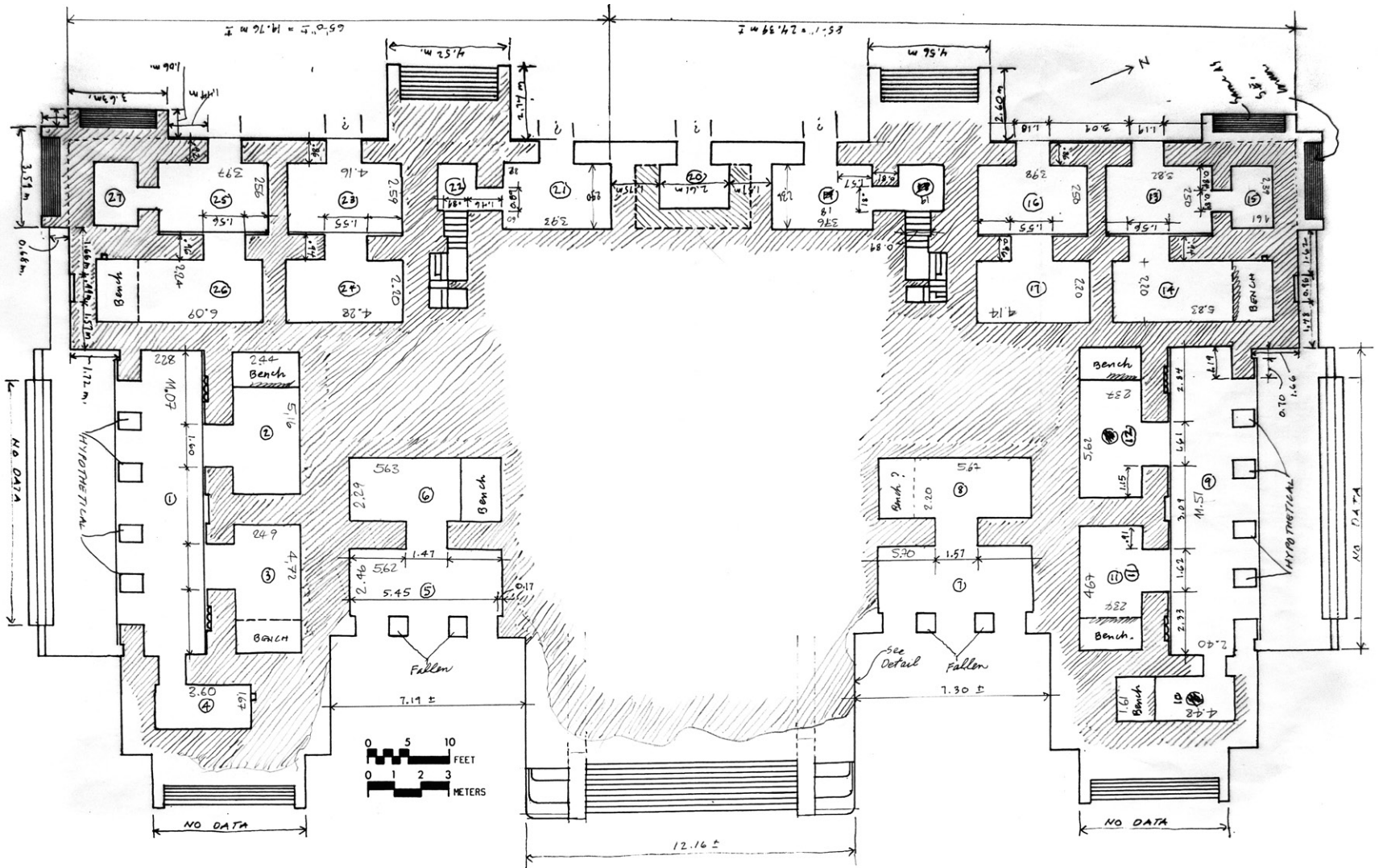

Fig. 77  
 Andrews' plan of the Palace of 1999 with measurements and question marks. The hypothetically added four pillars in Room 1 and in Room 9 are interesting. Andrews was the first to draw a plan with four pillars instead of two wall sections or of just two pillars in Room 1. This plan was very close to reality (Archive of H. Hohmann in Graz). This plan is similar to the plan of 1997 (Andrews 1997:279).

also followed the hypothesis of these three other scientists with only two pillars (Andrews 1987 Fig. 5a). When he realized that this would never have functioned, he followed Maler and his two wall sections instead of pillars (Andrews 1988). Again, at a later date, Andrews preferred to assume four pillars instead of two with one broader entrance in the centre, two flanking smaller side entrances on both sides in the East and in the West of Room 1 in comparison with the nearby Maya site of Macoba. A later hypothetical drawing of Room 1 of George F. Andrews even shows nearly exactly these five entrances with differing breadths as were later excavated. When Renée Lorelei Zapata Peraza's workers excavated Room 1 down to the floor Andrew's latest solution turned out to be the one which the Maya had nearly built. It fits almost exactly. At this time George F. An-

draws already knew so much about Maya architecture that he could easily have planned a Late Classic Maya building himself! But he did not know that the three central entrances were lightly recessed and flanked by two smaller side risalits. The pillar at the western end of the southern side of Room 1 has completely survived. It has a rectangular, nearly square horizontal section and the shaft above the base molding has a vertical receding field at the façade. At the basis it has a simple three-member molding. The capital above is a "tethered capital". This architectural element is very detailed with fine plasterwork covering the stone. Above follows a simple stone base supporting the wooden lintels of the western side entrance. Room 1 stands on the huge common platform, which obviously consists of rubble. The great weight of the Palace has compressed this platform so that the lower member of the three-member base molding is hardly visible any more. At the central entrance between the six pillars two flat stone steps help to step up from the platform south of Room 1 into the raised room level. At the side entrances of the two risalits in the East and in the West there is only one step in front of each entrance. The two wall openings between might not have been used as they have no additional steps. The height difference between Room 1 and Rooms 2 and 3 was bridged in both cases by one massive rounded step.

The three-member base molding at the base of the common wall between the three rooms consists of a projecting broader lower cornice, a smaller upper cornice and a high recessing band between. In this medial recessing band are several flat niches filled with groups of small broad flat colonnettes.

The northern wall of Room 1 above is vertically divided by two high flat niches near the two room ends. Each niche is filled with three 192 cm high half columns. The central column of each group carries a relief. All six half columns combine several monolithic elements. The elements of the decorated half column are spoils, consist of reused half column elements from an earlier

building and were obviously intended to have been put together incorrectly. Some elements were even used in a head down position.

The central wall section between the two passageways in the North has two more flat niches, the lower one is 148 cm high and 116 cm wide, the upper one is 25 cm high and 116 cm wide, one above the other. These areas are also filled with reliefs. These reliefs also consist of several reused relief elements from an earlier building. They even seem to originate from different former reliefs. Obviously these relief stones were also intentionally put together in the wrong way. The earlier building was



Fig. 78

This is the western end of the row of pillars in Room 1 and the south-eastern corner of Room 26 from the outside. The roof zone shows the medial and the upper three-member moldings. Photograph: H. Hohmann 1999



Fig. 79

In 1999 five of the relief elements on the southern central relief still existed in Room 1. Photograph: H. Hohmann 1999



**Fig. 80**

The capital of the most western pillar still shows remains of its very fine elaborated plaster.

Photograph: H. Hohmann 2001

possibly very important and either collapsed or was destroyed by enemies. It seems that the incorrectly combined mosaic of these reliefs is part of a remembrance culture.

Room 1 has, like all other rooms of the Palace, a ceiling in the form of a corbelled vault. The northern half of this vault has a special design above the two passageways for the two northern Rooms 2 and 3. Both wall openings have wooden lintels. The southern half of the corbelled vault has collapsed together with five of the six pillars. Above the two lintels and the two passageways Stamps found relicts of two wooden beams functioning as a reinforcement of the lintels.

In 1989 and even in 1999 the vaulted Room 1 showed three upper vault beam holes near the capstones and four lower ones near the vault spring in the northern half of the vault. These holes form a pattern of altogether 8 holes - four in the western section of the vault and three in the eastern section and one missing. The larger central section of the vault is free from such holes. In the eastern section of the corbelled vault in the position of the missing fourth eastern hole the vault was incomplete. After restoration this part of the vault is now complete and the lower hole under the missing one is covered with plaster and therefore no longer visible either. These holes certainly served to hold vault beams, spanning from the northern to the southern half of the vault.

The southern façade of Room 1 consisted of six pillars, which do not stand in a straight line, and five entrances, which have different widths and positions. The first two and the last two

pillars together with the first and the last entrance form a projecting part of the façade of Room 1. The two middle pillars and the three flanking entrances are receding. The central entrance is the broadest, the entrances to the left and to the right are narrower.

Remains of the very steep hipped stone roof survived at both ends of Room 1. The façade and roof of Room 1 look like a completely separated roofed building. The two pillars at each end of this complex stand on a slightly projecting basis and their position is some centimeters in front of the two pillars in the center. In this way the central entrance is flanked by two slightly projecting side risalits. The same is hypothetically repeated in the form of the roof.

The function of Room 1 can only have been as an entrance hall serving representational purposes.

## **Room 2**

Please also refer to: GP1F; S.L-35DW; S.L-30DW; S.Q-20DW; S.Q-20DS; S.L-30DE

Room 2 can only be entered through Room 1. It is situated on a higher floor level and is much smaller. Its length measures 5.16 m, its breadth 2.44 m. It has a stone and stucco bench at its northern end. There is a cord holder situated near the center of the eastern wall. This could have been used to tie up a dog. The lower vault beam near the door might have held a curtain to cover the person sleeping or sitting on the bench. All the other



lower and upper vault beams could have been used to hold clothes or other objects of daily life; the pair of lower vault beams could have held heavy objects.

A family lived and slept in Room 2.

In the center of the corbelled vault we find the remains of a painting once representing God K'awiil (Mayer 1983:40). It had a rectangular frame and represented a painted capstone but it was not a painted capstone.

### Room 3

Please also refer to: GP1.F; S.L-35DW; S.Q-20DN

Room 3 can also only be entered through Room 1. The room once had a bench at its eastern end. Presently there is no bench at all in this room; fortunately Antonio Benavides Castillo searched the room carefully and saw a "faint double cover of stucco on the wall, just where there should be the line or edge of a bench". This is a strong indication for a bench in this room, too. There is no doubt the stucco lines on the walls originate from a stone, rubble and plaster bench, which was completely removed by looters in recent times. It could also have been taken away in ancient times by the Maya of the Classic Period, as the bench might have disturbed a new functional concept of using the room. The double cover of stucco on the wall could also go back to a wooden sub-construction which was plastered over and was later taken away or was disturbed by termites.

In any case there was once a bench at the eastern end of the

room. The vault beam positioned near the western end of the bench could have held a curtain to cover a person sleeping or sitting on the bench.

There are four lower vault beams and four upper ones. Most of them might have been used to hang clothes and other objects of daily life on. The entrance could be closed from inside by cord holders and a closure. Therefore Room 3 was certainly once a space for living and sleeping purposes.

### Room 4

Please also refer to: GP1.F; S.L-50DW; S.Q-10DN, S.Q-20DN; S.L-50DW

Room 4 could also only be entered through Room 1. The counterpart Room 10 on the northern side of the main axis of symmetry once had a bench. Therefore this room might also have once had such a bench; but, there is no evidence for it at all. If there had been a bench this must have been quite low; otherwise the cord holder in the northern back wall would have been covered. There is also one cord holder near the passageway to Room 1 and it looks like there were once three more to fix a closure from inside. The three upper and the three lower vault beams had practical functions. The room seems to have served as a domestic area.

## Room 5

Please also refer to: GP1.F; S.L-35DW; S.Q-35DN

Room 5 is the entrance space for Room 6. The two-room unit has its own separate roof. The eastern façade of Room 5 ends at the corners in the North and the South with two pillars. The three entrances are divided by two columns. In the other stories two more pillars divide the open side into three entrances. The columns are composed of rounded stones which are small on the surface. Therefore the capitals could not survive. They are hypothetically added in comparison with the capitals of the pillars.

Such architectural elements might have existed once. Unfortunately the capitals of such columns which are not monolithic but

built like walls consisting of lots of single stone elements seldom survived.

In Room 5 we find a basal molding under the common wall of the two rooms. There is a three-member molding visible. The third projecting lower member was added at the bottom. In Room 1 we also have a three-member molding and the lowest member of the molding might be covered with plaster from the plaster floor which was added later. The recessing member of the molding has flat niches near both sides of the passageway. Both niches contain groups of three three-dimensionally sculpted colonnettes. In the center in front of the molding a simple rectangular stone helps to climb up to the back Room 6.



Fig. 81

Base molding of the common wall between Rooms 5 and 6. The molding is pressed into the ground under the wall caused by the great weight of the upper story.

Photograph: H. Hohmann 2004



Fig. 82

The three-member base molding in Room 5 has two groups of three profiled and ornamented colonnettes in flat niches on its recessing medial member. The upper member of the three-member base molding shows fringes.

Photograph: H. Hohmann 2004

Fig. 83

The three-member base molding under the wall between Room 7 and Room 8 is pressed into the floor under the walls on both sides. The base molding has two groups of four ornamented colonnettes. Above the passageway to the back room a recessing field in the corbelled vault can be seen.

Photograph: H. Hohmann 2004

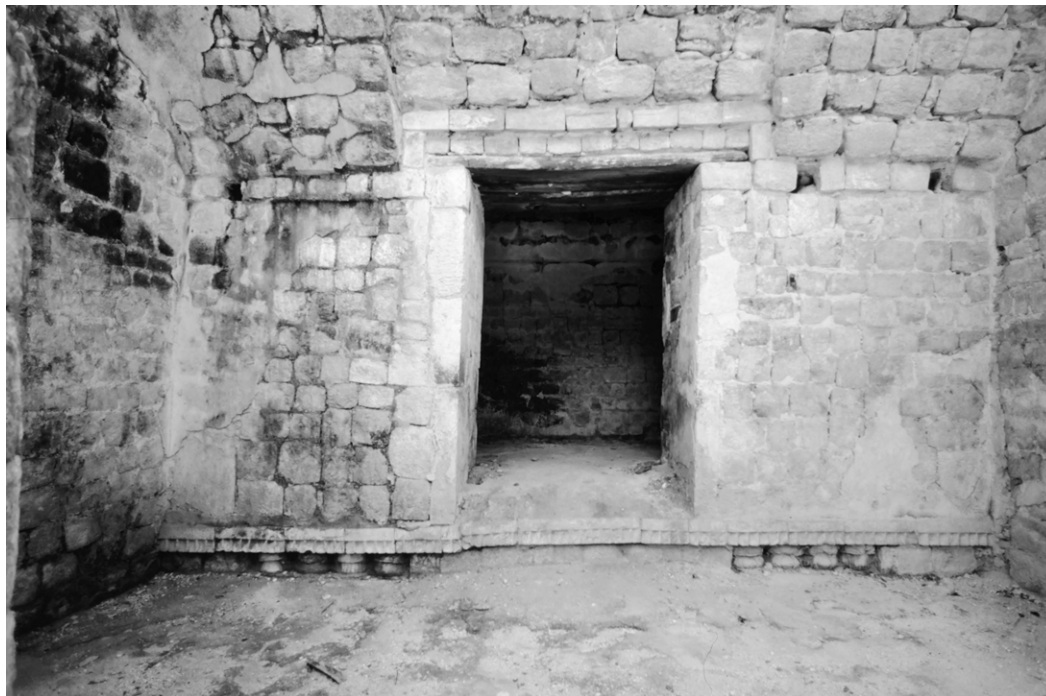

Above the passageway a special roof design – similar to the two in Room 1 and 9 – guides into Room 6. Lower vault beams are only at the ends of the room; such beams would have disturbed the room. Four upper vault beams are spread over the length of the room.

### Room 6

Please also refer to: GP1.F; S.L-30DW; S.Q-35DN

Room 6 is one of the few in this Palace with a bench which still exists at the northern end. The bench is damaged but the form with three deep niches under the surface and the rounded supports could still be measured. A vault beam just above the edge of the bench might have held a curtain to cover a sleeping or sitting person on the bench. On both sides of the room are pairs of lower vault beams which might have held a hammock. Hammocks exert great horizontal tension stress on both sides on the moorings and this stress could possibly break single vault beams. This seems to be the reason for the beam pairs in this room. There are four more upper vault beams spread over the length of the vault.

In the Tabasco State Museum in Villa Hermosa we find a very naturalistic and detailed representation of a person sitting in a hammock on fragments of a polychrome vessel – the “vase of Tabasco” (Hohmann 1984:2, Fig.1). The vase was produced in the late Maya Classic Period. Two representatives are also shown in the Mixtec Codex Nuttall (1987:20 new pagina) facing each other and discussing, visible through the entrance. In the Palace of Santa Rosa Xtampak one or two persons might also have been sitting in Room 6 in the hammock speaking to

a person in the entrance room. Please also refer to the drawing and read the text under “pairs of double vault beams”.

Cord holders on both sides of the passageway indicate that the room could be closed from the inside and rod sockets show that in some cases curtains were hung down to cover the passageway. The first room might have served as a representative entrance hall and the second room of this unit had domestic and representative purposes.

### Room 7

Please also refer to: GP1.F; S.L-35DW; S.Q-65DN

Room 7 is the entrance hall for Room 8. From outside the two-room unit looks like a separate house with three entrances and its own roof. At the edges the eastern façade ends with two pillars. The three entrances are divided by two columns. The columns are composed of plenty of small rounded stones. As they were quite fragile only the lowest section of them survived and the capitals do not exist anymore. They have been added hypothetically in comparison with the capitals of the pillars. The central entrance is broader than the two side entrances.

In Room 7 we find a three-member basal molding under the common wall with Room 8. Only a two-member molding is visible. The third member is quite certainly covered by plaster from the renewed plaster floor and is partly pressed into the ground by the great weight from above. The recessing member of the molding has flat niches near both sides of the passageway. Both niches contain groups of four three-dimensionally sculpted colonnettes.

The deformation of the foundation of the Palace can be demonstrated here. Obviously the platform underneath was not solid rock but rubble and earth. This was compressed by the great weight of the upper stories. Therefore the basal molding is not straight and horizontal but pressed several centimeters further into the ground under the wall sections of the middle wall than under the passageway.

The author added a third projecting member at the base molding along the floor hypothetically. In Room 1 and in so many other rooms in the Palace we also find a three-member molding. Above the passageway a special roof design guides into Room 8 – similar to the two such designs in Room 1 and in Room 5. There are three lower vault beams in Room 7, two at the ends of the room and one north of the northern column. Four upper vault beams are spread at regular intervals over the length of the vault.

### Room 8

Please also refer to: GP1.F; S.L-30DW; S.L-30DE; S.Q-65DN

Room 8 has no indications of a bench; but, there is a lower vault beam in a position north of the passageway that could have held a curtain in front of a bench on the northern side of the room. There is no plaster left on the walls any more. There was possibly once a bench which was removed later. The two pairs of lower vault beams at the two ends of the room again indicate the use of a hammock. It also seems possible that the users used the hammock instead of a bench? There is more space for a family on a bench than in a hammock. Rooms 6 and 8 are symmetrically positioned in the Palace. Room 8 is the second room with a hammock. The four upper vault beams are at regular intervals.

### Room 9

Please also refer to: GP1.F; S.L-35DW; S.L-30DW; S.L-35DW; S.Q-90DS

Room 9 on the northern side of the Palace is the counterpart of Room 1 in the South. It is the entrance hall for the three other Rooms 10, 11, and 12. These four rooms together form a domestic compound. The base molding of the southern wall of Room 9 shows only two members, a projecting cornice and a broad recessing band underneath. Quite certainly there also used to be a lower projecting member on the floor. The upper cornice is constructed of reused relief stones which do not really fit together very well. The upper half of the cornice shows rhomboid relief elements, the lower half shows hanging fringes. The wall above has a flat niche, 90 cm broad, 152 cm high, in the central wall section with one large relief field. As in Room 1, the relief elements have also been reused here and do not fit together. The mixture must be intentional. Please also refer to the paragraph about “Flat niches with reused reliefs”.

At each end of the room, the eastern and also at the western end of the southern wall, we find a flat high niche. The eastern one contains three approximately 2 m high half columns, the western one contains four such half columns.

Renée Lorelei Zapata Peraza’s excavations brought five entrances along the northern side of Room 9 to light. The central one is broader than the others. It is flanked by two round supports. They might have carried a capital in the form of a round version of the capitals of the pillars on both sides. We find such capitals in Channá in the Río Bec Region some 145 km southeast of Santa Rosa Xtampak (Ruppert and Denison 1943:Plate 24b;

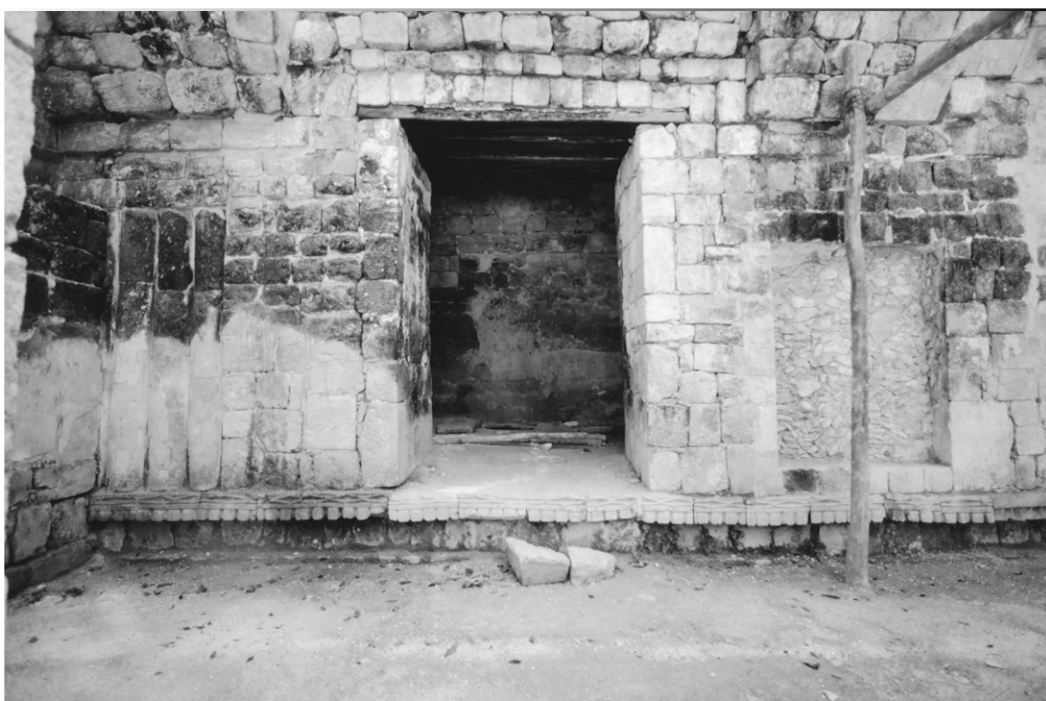

Fig. 84

This photograph shows the eastern part of Room 9 with the three-member base molding, the passageway to Room 11, a group of three half columns to the left, a recessing relief field in the corbelled vault above the passageway and the empty field of the looted central relief to the right.

Photograph: H. Hohmann 2004



Fig. 85  
 Perspective of Structure 1 at El Delfin with some hypothetical additions. The archaeological site was discovered in 2015 by Stephan Merk.  
 Drawing: H. Hohmann

Gendrop 1983:148 and 149) and in El Delfin in Campeche some 60 km northwest of Xpuhil (Merk 2015:39-43). They are also quite common in a smaller size as colonnettes in roof zones of structures in the entire Puuc region but also in the Chenes region. The western two corners of Structure 1 in Yakalxiú (Andrews 1995:186, Fig. 18a and 18b) or wall zones as façade elements for example in Labna, Structure 1, Central Section, southern façade (Andrews 1995:73, Fig. 77) might serve as examples.

Each of the two side entrances is flanked by two pillars. The side entrances both project slightly from two side risalits of this part of the structure. The three entrances are marked by two steps for the central entrance and one step for the two side ones.

A bench could be excavated at the western end of the room. It has one central niche and covers the lowest part of two of the altogether four half columns. A vault beam between the second pillar and the southern wall could have helped to separate this western end with the bench from the rest of the entrance hall. For this, a second closure at the western entrance would also have been necessary. The bench does not belong to the first building phase of the Palace; otherwise it would not cover part of the half columns.

Above the bench we find the most colorful and one of the very differentiated wall and vault paintings still visible in situ. The drawings S.L-35DW and S.Q-90DS provide the paintings with some degree of reconstruction. Paintings quite certainly once decorated the entire entrance hall. At the eastern end of the room we find a 38 cm broad wall built at a later date in front of the original eastern wall of Room 9. It is obvious that the weight of the temple above with Room 39 produced static problems for Rooms 9 and 10 and the additional wall was intended to stabilize the structure.

The ceiling of Room 9 is a corbelled vault. Only the southern half of it has survived. This side shows a special design in front of the two passageways. There were five lower vault beams and at least two upper ones. Unfortunately restoration work has closed several of the upper beam holes and one of the lower ones. One at the eastern end of the room was covered by the additional wall by the Maya.

The roof above the vault zone and the façade of the roof zone is a mirror image of the one above Room 1 in the South of the Palace. It is a very steep sloping flat stone roof. The step at the upper end was added hypothetically in comparison with the lower step of the roof.

### Room 10

Please also refer to: GP1.F; S.L-50DW; S.Q-85DN; S.Q-90DS

Room 10 is surrounded on three sides, the southern, eastern, and the northern ones by pseudo stairways and mega steps for the temple above. The room can only be entered through Room 9. The orientation of the main axis of the room faces a point under Stairway A along the axis of symmetry. The orientation must be intentional as Room 4, as the counterpart of Room 10, also faces this point. The eastern walls of Rooms 3 and 11 also have this direction. The two rooms are the only ones in the entire Palace which have a completely different orientation, compared with all the other rooms.

The room once had a bench at its southern end. In around 1969 Stamps found only plaster lines of the former bench on the wall plaster in the room. He carefully measured these bench lines. The bench itself was completely destroyed by looters. Above the former bench a cord holder is positioned which might have functioned to hold a dog or a child?

Some more cord holders around the passageway indicate that the room could be closed from inside and was used as a domestic space. The lower vault beams at the ends of the room might have functioned to hold clothes and other objects of daily life. The middle beam might have held a curtain to cover a person sleeping or sitting on the bench. There are also three upper vault beams.

### Room 11

Please also refer to: GP1.F; S.L-35DW; S.Q-85DN

Room 11 could only be entered through Room 9. At its eastern end Stamps measured the contour of a bench by plaster lines on the wall plaster and documented it (Stamps 1970:53 and 49, Fig. 13). But at present there is no longer any indication for a bench. Looters must have destroyed the bench completely before 1969 by searching for treasure in the body of the bench.

Cord holders at the passageway indicate that Room 11 could be closed from inside. Two lower and three upper vault beams do not help to reconstruct the former use of this room in more detail. The indications for the bench make it certain that the room served domestic purposes.

### Room 12

Please also refer to: GP1.F; S.L-35DW; S.L-30DW; S.Q-85DN

Room 12 could also only be entered through Room 9. Once it had a bench and fortunately Stamps measured and documented the indications following the plaster lines of the bench on the wall plaster (Stamps 1970: 53 and 49, Fig. 13). Antonio Benavides Castillo also found some of the stucco marks on the walls in 2013. These marks and Stamps' report make a reconstruction possible. The room was completely cleared before 1969 by looters.

The lower vault beam might have held a curtain to cover a person sleeping or sitting on the bench. All together there are three lower and four upper vault beams in this room. Near the upper beams is a decorative profile running around the vault on all four sides (refer to S.Q-85DN).

There are cord holders and rod sockets at the passageway. Therefore the room could be closed from inside and be covered by a curtain or another type of closure. The room was used for domestic purposes.

### Room 13

Please also refer to: GP1.F; S.L-10DW; S.Q-90DS; S.L-10DE

Room 13 is the entrance room for Rooms 14 and 15. All three rooms form a domestic three-room unit. Room 13 has no bench and no cord holders. Rod sockets could have been used to hold a curtain or a closure which could have been handled from the inside and from the outside. The vault is slightly asymmetrically formed, as the back room, Room 14, has a raised floor level. Two lower and three upper vault beams were used to hang objects of daily life on.

### Room 14

Please also refer to: GP1.F; S.L-15DW; S.L-15DE; S.Q-90DS

Room 14 has a bench with two niches. A pair of lower vault beams above the bench might have been used to hang heavy objects on. A middle beam could have been used to hold a curtain. Cord holders near the passageway show that the room could be closed from the inside. There were also three upper vault beams.

### Room 15

Please also refer to: GP1.F; S.L-10DW; S.Q-95DS; S.L-10DE

Room 15 under the temple at the north western corner of the Palace is quite small, has a raised floor and the whole room might have been used as a bench. It could be closed from inside by

cord holders near the passageway. Two lower and two upper vault beams were used to hang clothes and other objects of daily life on.

### Room 16

Please also refer to: GP1.F; S.L-10DW; S.Q-85DN; S.L-10DE

Room 16 is the entrance and passage room of the two-room unit. It has cord holders on one side of its entrance. Therefore it might once have been possible to close the room by these features from inside. Two pairs of rod sockets at the entrance show that, in any case, the room could be closed with a different kind of closure from both sides. Curtains could also cover the entrance. There is no bench in the room. The vault is asymmetrically formed, as the back room, Room 17, has a raised floor level. Lower vault beams exist only at the room ends. Four upper vault beams could also be used to hang things on.

### Room 17

Please also refer to: GP1.F; S.L-15DW; S.L-15DE; S.Q-85DN

Room 17 is positioned on a higher level than Room 16. There are only lower vault beams near the gable walls but no lower beams within the room to hold a curtain in front of a bench; nor are there any other indications for a bench. The entire room might have functioned as a huge sleeping space. The four upper and the two lower vault beams were used to hang clothes and bedding on.

### Room 18

Please also refer to: GP1.F; S.L-10DW; S.Q-65DN; S.L-10DE

Room 18 belongs to the northern inner Staircase D as a passage room. The entrance hall for this entire staircase is Room 19. There are three steps leading up to the higher floor level of Room 18. The corbelled vault is asymmetrical. There is only one vault beam hole on the western side.

Richard Stamps (1970:50) writes that the end walls of the Rooms 18 and 19 do not interlock with the side walls. The author already observed a very similar phenomenon in Copan at several structures (Hohmann and Vogrin 1982:74, Fig. 31) but also at other Maya sites and tried to interpret the reason for it by a construction principle. In Santa Rosa this could be an indication for a very similar construction principle at least for the Palace of Santa Rosa Xtampak.

### Room 19

Please also refer to: GP1.F; S.L-10DW; S.Q-55DN; S.L-10DE

Room 19 looks like a normal domestic room. The door is the same size as all the other doors on the first floor at the western façade. The corbelled vault has two lower and four upper vault beams. But there are no cord holders or rod sockets at the entrance, it was not possible to close the door from inside or outside. Anyone could enter the room at any time.

The room might have been used by a person responsible for Staircase D and who had to guaranty, that the room looked like a domestic space. The two lower vault beams possibly even held curtains, the one on the northern side covering the first three steps of Staircase D. It seems that non-locals were not to know how to reach the upper floors.

### Room 20

Please also refer to: GP1.F; S.L-10DW; S.Q-50DS; S.L-10DE

Room 20 is the most central room on the first floor. Like Room 19, the room has no cord holders or rod sockets. The remains of the vault show upper and lower vault beams.

In a secondary building phase its space was very much reduced to about one third by a secondary U-shaped wall construction, supporting the upper floors. There must have been some serious static problems with the weight of the upper constructions in this part of the Palace (refer to Rooms 35 and 36 on the second floor). In the last phase the small room might have functioned as a porter's lodge for the two entrances to the two staircases next to it.

### Room 21

Please also refer to: GP1.F; S.L-10DW; S.Q-40DS; S.L-10DE

Room 21 is the southern entrance room for the southern Staircase E. Room 21 looks like a normal domestic space. The door is the same size as all the other doors in the western façade on the first floor. The corbelled vault has two lower and four upper vault beams. But there are no cord holders or rod sockets at the entrance, therefore it was not possible to close the door from inside or outside. Anyone could enter the room at any time from both sides.

It seems the room should look like a domestic space and therefore the two lower vault beams might have held curtains, the one on the southern side covering the first three steps of Staircase E. It seems that non-locals were not to know how to reach the upper floors. It seems that the architectural concept tried to make the upper two floors quite inaccessible to persons who were not accepted or welcome.

The room was possibly used by a person responsible for Staircase E and who had to guaranty, that the room looked like a domestic space. The two lower vault beams quite certainly held curtains, the one on the southern side covering the first three steps of Staircase E. It is certain that non-locals were not to know how to reach the upper floors.

### Room 22

Please also refer to: GP1.F; S.L-10DW; S.Q-35DN; S.L-10DE

Room 22 is a passage room for the southern inner Staircase E. The entrance hall for the entire staircase is Room 21. From there three steps lead up to the higher floor level of Room 22. The corbelled vault is asymmetrically formed. There was only one upper vault beam.

Richard Stamps (1970:50) writes that the end walls of the Rooms 22 and 21 do not interlock with the side walls. This could be an indication for a construction principle of at least part of the Palace of Santa Rosa Xtampak, a principle the author already observed and discussed at several structures in Copan and also at other Maya sites (Hohmann and Vogrin 1982:74, Fig. 31; please also refer to the paragraph on "Walls, Pillars, and Columns").

### Room 23

Please also refer to: GP1.F; S.L-10DW; S.Q-25DS; S.L-10DE

Room 23 is the western entrance or passage room of a two-room unit. It has cord holders and two pairs of rod sockets at the entrance and at the passageway to Room 24. Therefore both rooms could be closed at the entrance from inside by the cord holders and by the rod sockets from inside and outside. The room has an asymmetrical corbelled vault, as the back room, Room 24, has a raised floor level. There are two lower and four upper vault beams.

### Room 24

Please also refer to: GP1.F; S.L-15DW; S.L-15DE; S.Q-25DS

Room 24 could only be entered through Room 23. There are no indications for a bench in Room 24. Possibly the entire room was once used as a huge bench. Lower vault beams are only at the room ends where clothes and other objects of daily life could be hung without disturbing persons acting in the room. This room could also be closed by cord holders as well as by rod sockets. Small children could be kept in Room 24, if the passageway was closed from Room 23 by a closure for the rod sockets. The upper vault beams are – as usual – spread over the length of the room. There is no question that this unit functioned for domestic purposes.

### Room 25

Please also refer to: GP1.F; S.L-10DW; S.Q-20DN; S.L-10DE

Room 25 is the entrance room of a three-room unit. It could only be closed by a closure for rod sockets. The vault is asymmetrical, as Room 26 has a raised floor level. It has two lower vault beams at the room ends and four upper beams.

### Room 26

Please also refer to: GP1.F; S.L-15DW; S.Q-10DN; S.Q-20DN; S.L-15DE

Room 26 is the back room of Room 25. The room shows no indications for a bench at all. The entire room was possibly used as a very large bench. There are cord holders around the passageway; that means that the room could be closed from inside. A pair of rod sockets at the passageway shows that the room could also be closed with a different closure from both sides. There are two more cord holders, one in the northern wall, one in the very south of the western wall. Both might have been used to tether a dog.

The corbelled vault has four lower and four upper beams. A pair of such beams along the southern wall might have functioned to hold heavy loads. Just in the middle is a single beam, which might have functioned to hold a curtain to divide the room into two halves.

### Room 27

Please also refer to: GP1.F; S.L-10DW; S.Q-10DN; S.Q-10DS; S.L-10DE

Room 27 just under the south-western Temple with Room 46 at the south-western corner of the Palace is quite small. It has cord holders at the passageway. Therefore it could be closed from inside. Pairs of rod sockets indicate that this small room could also be closed by a different closure from inside and from outside. There is no bench and the room is not raised. It seems that some people lived and slept in this room just on the level of the entrance room. There are only indications for two lower vault beams at the ends of this small room. A platform hanging from the vault beams might have provided space to sleep. This kind of sleeping platform was quite common further south in recent times.



## SECOND FLOOR

### Room 28

Please also refer to: GP2.F; S.L-35DW; S.Q-20DW; S.L-25DE

Room 28 is an open space with three entrances in the South. These are divided by four profiled pillars. There is a hole in the eastern wall which might be interpreted as a niche. Vault beams and most of their holes did not survive. Only the beam holes of three lower vault beams are visible. If the middle beam carried a curtain and the adjoining door was closed with a closure, it might have been possible to have a small protected space in this room. Otherwise it was a single representational room.

### Fig. 86

We see Room 28 with four pillars to the right. The southern façade of Room 37 shows the most southern pillar and a pseudo side entrance. We can also recognize the flat niches forming the medial member of the three-member base molding. The foreground shows the two steps leading up

to the higher level of the second floor in the East. We can also look down into Room 1 on the first floor and up to the southern façade of Room 40 on the third floor.

Photograph: H. Hohmann 2004





### Room 29

Please also refer to: GP2.F; S.L-30DW; S.Q-35DN

Room 29 was once a vaulted open space in front of Room 30 with a row of four profiled pillars supporting the eastern half of the roof. The room has three entrances. The broader one is the central entrance marked with a flat step in front of the room. In the South, the West, and the North the room has walls which reach into the two triangular fields at the ends of the vault. A narrow flat step in front of the passageway to Room 30 helps to step up into the room.

The western wall shows the raised base of the rear room with a simple projecting cornice. In 1989 and 1990 Jack Sulak detected and photographed a mural with the remains of representations of persons above this line on the northern half of this wall. The fragments of the wall painting showed at least four persons in action. Unfortunately their four faces had already been destroyed when Sulak found them. The upper frame of this wall painting was formed by two red bands underneath the vault spring. The upper one ran halfway between the vault beam holes and was approximately 12 cm wide, the thinner one ran at a distance of only 3 cm parallel underneath and itself measured about 3 cm in breadth. Between and above the two bands the wall was painted green. Some remains indicate that the color changed again to red at the vault spring.

### Fig. 87

This shows Room 29 with four pillars in the centre and the eastern façade of Room 28 to the left. To the right we see the southern pseudo Stairway C leading up to the huge monster mouth passageway on the third floor.

Photograph: H. Hohmann 2004

The author photographed the bands in 1998. In 2004 these bands were still visible in light red on light green on both sides of the passageway to Room 30. The colors of both bands varied from orange to red and dark purple red. When Sulak contrasted the colors of the upper broader band at least one Maya glyph became visible. It seems that the band once had an inscription. Even Teobert Maler saw glyphs painted in black on this band in 1891 (Pollock 1970:57). The color had possibly changed within the last hundred years. It is sad that the rest of the mural with the four persons disappeared completely between 1989 and July 2003, when Sulak tried to photograph it again. Within the vault space we find three lower vault beams and only two upper beams. The middle lower beam could have held a curtain. It might have been possible to close the northern entrance. In this case the northern section of the room might have functioned as a separated private space sometimes. Otherwise Room 29 was just a representational entrance room with wall paintings partly visible even from the Plaza.

### Room 30

Please also refer to: GP2.F; S.Q-35DN; S.L-25DE

The raised Room 30 west of Room 29 has cord holders and rod sockets and therefore once functioned as a private area with the domestic functions of the two room compound. A pair of lower vault beams at the northern end could have held heavy loads; the next beam might have held a curtain to separate the northern section of the room. The users might have had a wooden bench here instead of a heavy stone and mortar bench. The other possibility was that the entire raised Room 30 was seen as a huge bench. A second lower vault beam might also have once existed in the South. In this case the two possible pairs of vault beams could have held a hammock.

The inner face of the passageway from Room 29 to Room 30 showed black and dark blue horizontal bands and brown, white and orange paint. The bands might once have shown some more inscriptions.

### Room 31

Please also refer to: GP2.F; S.L-30DW; S.Q-65DN

Room 31 is an open roofed space with four pillars and three entrances in the eastern façade. A narrow flat step in front of the façade marks the broader main entrance. In the room we find two lower and two upper vault beams, located at the ends of the vault. A narrow flat step leads from here through the passageway to Room 32.

### Room 32

Please also refer to: GP2.F; S.Q-65DN; S.L-25DE

Room 32 has cord holders at the entrance and could therefore be closed from inside. It was a domestic space. There is a pair of lower vault beams along the northern side and one in the South. Another four upper beams are spread over the length of the vault. The entire raised room was possibly used as a huge sleeping area. If a second lower vault beam used to exist in the South of Room 32 a hammock might once have been used.



Fig. 88

Room 31 shows the passageway to Room 32 to the left. The northern pillar of Room 31 in the centre, the northern façade of Room 31 and the eastern façade of Room 33 are visible to the right.

Photograph: H. Hohmann 2001





Fig. 89

The eastern façade of Room 33 still shows remains of the three-member base molding, the medial molding and of the upper molding. The large flat niche represents a pseudo side entrance. The eastern pillar to the right shows that it is not a pilaster, as it is separated from the wall.

Photograph: H. Hohmann 2001

Fig. 90

Three steps lead up the higher eastern level of the second floor. Room 33 with four pillars can be recognized to the left, the northern façade of Room 34 to the right.

Photograph: H. Hohmann 2004

Fig. 91

The northern façade of Room 31 can be seen to the left. The eastern façade of Room 33 is visible to the right.

Photograph: H. Hohmann 1999

### Room 33

Please also refer to: GP2.F; S.L-35DW; S.L-25DW; S.Q-85DN

Room 33 is a fairly open space facing to the North. It is a one room structure with four pillars and three entrances on its northern façade. A small platform in front of the central entrance helps to step up into the room. There are three lower and three upper beam holes in the vault. The lower middle beam is positioned opposite the second eastern pillar. A curtain from this beam might have separated this space from the rest and a second curtain closed the eastern third along the façade of this room.

### Room 34

Please also refer to: GP2.F; S.L-15DW; S.L-15DE; S.Q-85DN

Room 34 is another single room with one open side, four pillars and three entrances, here facing west. There are three lower and three upper vault beams. A cord holder in the centre of the northern wall might have tethered a dog. Possibly all three entrances could be closed so that the room became a domestic space.



Fig. 92

The two pseudo Temples 48 and 47, the two entrances to the two Staircases E and D, and the Rooms 36 and 35 between, form the centre of the western façade on the second floor. In the background is Temple 45.

Photograph: A. Drexler 2004

### Rooms 35 and 36

Please also refer to: GP2.F; S.L-15DW; S.L-15DE; S.Q-55DN

Rooms 35 and 36 belong together and were once one very long room. Later static problems with the third floor made a massive supporting block in the center of the room necessary and divided the room into two rooms of approximately the same size as the other four pillar rooms.

The original room had eight pillars and seven entrances. The corbelled vault shows two lower and two upper vault beams in both rooms. Behind the supporting block one more upper vault beam is presently visible. The lower one had to be hypothetically added following the scheme of beam holes.

How Room 35/36 was once used is a really difficult question. Between the two second floor entrances to the Staircases D and E this room is quite isolated from the others. It was possibly used for discussions walking in a roofed open space. It also seems possible that the seven entrances could be closed with closures at night and were open during the day. Then the room could possibly have also been used for domestic purposes.

It is amazing that the first floor looks very massive, the third floor is even more closed than the first on this side. It has only two small wall openings for the two staircases. But the western side of the second floor looks very light with its 15 entrances and 16 profiled pillars in total.

### Room 37

Please also refer to: GP2.F; S.L-15DW; S.Q-20DN; S.L-15DE

Room 37 is positioned at the southwestern corner of the second floor of the Palace. Its western façade shows four pillars and three entrances. There is a step in front of the room which guides into it. There are three lower and three upper vault beams. The middle lower vault beam could have held a curtain separating the northern end of the room from the rest. If the northern entrance was also closed it could have created a small sleeping space.

### Room 38

Please also refer to: GP2.F; S.Q-20DN; S.Q-10DN

Room 38 is the south-eastern temple on the second floor. It is one of the four isolated standing structures at the four corners of the Palace. These four structures were temples and have to be seen together with the pseudo stairways and pseudo mega steps underneath as temple pyramids. Room 38 and the surrounding area was excavated by Renée Lorelei Zapata Peraza.

The base of the temple with Room 38 above has a three-member molding. This consists of a 17 cm high lower member and a 13

Fig. 93

This is the north-western corner of the south-eastern temple, Room 38. Very little of the architecture has survived. Photograph: H. Hohmann 2001



Fig. 94

The western wall only had eight colonnettes and showed the lower member of the three-member medial molding. Photograph: H. Hohmann 1999

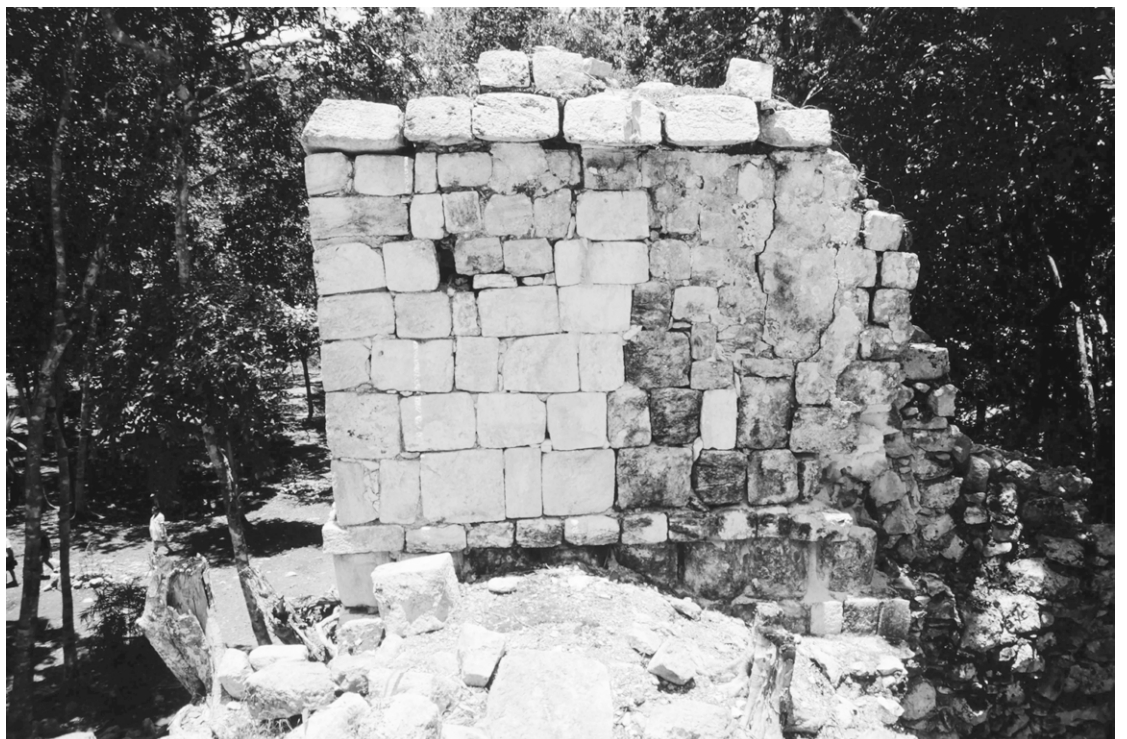

cm high upper one and recessing 35 cm high colonnettes in the middle member. In 1989 Heine and Reiter measured 8 of these large colonnettes at the western façade and 4 along the northern one. Including the corner colonnettes the reconstruction shows 12 colonnettes to the South, 13 to the West, 11 to the North, and an unknown number of colonnettes to the East. The northern half of the eastern row shows 7 colonnettes, in the southern part of this side are 3 more colonnettes. The space between seems to be quite straight and without the missing 3 or 4 colonnettes. The southern colonnettes have very different widths. The eastern façade of Room 38 is part of the main façade of

the Palace and has the broadest pseudo stairway of this temple pyramid. The missing 3 colonnettes had to be reconstructed by drawing, as the façade of the temple pyramid must be symmetrical. The reconstruction of the author shows 13 colonnettes to the East. Even the southern, the rear side – relating to the temple entrance – has a full row of colonnettes.

The vault of Room 38 was already destroyed and therefore there is no information about the vault and its beams. Only the dimensions of the room, the entrance, the spring of the vault, and the lower and middle member of the three-member medial molding of the façade could be located and measured.



Fig. 95  
 Room 39 and the southern pseudo Stairway F form the north-eastern temple pyramid. The asymmetry of the position of the stairway is visible.  
 Photograph: A. Drexler 2004

Stephens writes: "On the platform of the second terrace, at each end, stood a high square building like a tower, with the remains of rich ornaments in stucco" (Stephens 1843:162). This means that in 1842 remains of decoration on at least one of the two single towers still existed – Room 38 and Room 39. In 1989 Heine and Reiter photographed and measured only portions of the western and northern walls together with colonnettes at the base of the south-eastern tower; nothing more was visible. At present the entire structure is excavated and large portions have been reconstructed. Only a thin line of projecting thin stones is visible at the southern wall, which might show corbelling supports of the lost stucco decoration?

All the early explorers as well as archaeologists and architects thought – following the concepts of the Río Bec area – that there should be a pseudo stairway and an entrance to the tower on its eastern side facing the Plaza of the Palace. Zapata's excavations revealed that the entrance is on the northern side of Room 38 facing the main Stairway A and that there are pseudo stairways on all three sides of the tower, in the North, the East and the South. As such pseudo stairways are usually combined with pseudo entrances or with real ones the author also added hypothetically pseudo entrances here above the eastern and the southern pseudo stairway.

#### Room 39

Please also refer to: GP2.F; S.Q-65DN; S.Q-85DN; S.Q-90DS

The north-eastern temple with Room 39 was just a mound on top of the terrace in 1989 and also in 1999. Excavations here discovered Room 39 to be facing south and this structure had not just one pseudo stairway at its southern side but two more in the East and in the North and pseudo mega steps. The author also added pseudo entrances hypothetically here on the exterior walls of Room 39 in the East and in the North.

The missing 11 colonnettes of the three-member base molding along the northern side, the northern sections of the western and of the eastern base moldings have also been added hypothetically by drawing. The reconstruction of the western side shows 6 or 7 colonnettes instead of 11; the northern side is presently plain – the author gave it another 11 hypothetical colonnettes; the eastern side was given 12 instead of 7 colonnettes.





**Fig. 96**

In 2001, the patio behind the monster mouth was still filled with rubble.

Photograph: H. Hohmann 2001

### THIRD FLOOR

#### **Room 40**

Please also refer to: GP3.F; S.L-30DW; S.Q-35DN; S.Q-30DS; S.L-25DW

On the third floor Room 40 is the most southern one. The western, southern, and northern façades are intact nearly up to the roof. But the eastern façade was however not sustainable enough to resist attacks of vegetation and rain. This side consisted of four pillars and three entrances. Four lower beams existed in the vault zone. Unfortunately the upper beam holes did not survive. It is difficult to provide an answer to the use of this quite open room.

#### **Room 41**

Please also refer to: GP3.F; S.L-30DW; S.L-25 \*DW

Room 41 is the continuation of Room 40 to the North. It is one of two very small projecting rooms near the most central Room 42. The floor level of these two small rooms is even higher than the floor in Room 42. Therefore Room 41 and Room 43 must have been quite important. The height of a room level is a strong indication for the importance of a room in Old World and New World cultures.

In the vault zone Room 41 once had two lower and two upper vault beams. The room is 2.14 m long and about the same width. If the whole room was used as a huge raised bench there was plenty of space and it might have been used as one of the sleeping rooms by persons of Room 42.



### Room 42

Please also refer to: GP3.F; S.L-30DW; S.L-25\*DW

Room 42 is the most central room of the Place on the third floor. From the small courtyard west of the monster mouth passageway three steps lead up into this room which is more than seven meters long. There are two pairs of vault beams at its ends which once might have held a hammock for one or two persons sitting in the central section. All together there are 6 lower and 4 upper beams in this room. It might have been the most representational room of the Palace.

The patio in front of Room 42 is surrounded by steps, which once might also have been used to sit down for conferences. The author is not sure if there was an awning spanned over the patio to protect it from sun and rain. Cord holders at the coping fourth member of the four-member upper molding along the roof should have been found. No report about this is available.

The Rooms 41, 42, and 43 face the East. In the morning the sunrise can be watched from here. The direction to the rising sun might have had a meaning for the inhabitants of this Classic Period Palace.

### Fig. 97

The patio between Room 42 and the monster mouth passageway.

Photograph: A. Drexler 2004

### Room 43

Please also refer to: GP3.F; S.L-30DW; S.L-25\*DW

Room 43 is the northern room of the two very small projecting rooms near the most central Room 42. The floor level of these two small rooms is even one step higher than in Room 42. Therefore Room 43 and also Room 41 must have been quite important spaces. In the roof zone they once had two lower and two upper vault beams. The room is 2.11 m long at the back wall and about the same width. If the whole room was used as a huge raised bench there was plenty of space and it might have been used as one of two sleeping rooms by persons of Room 42.

Fig. 98  
The eastern façade of Room 42, the quite large, representative and most central room of the Palace on the third floor was quite well preserved. It shows the entrance and two pseudo side entrances.  
Photograph: H. Hohmann 2001



Fig. 99  
Archaeological activities revealed the space to the East of Room 42 to be a patio with three stairs or seats on three sides. The eastern side of this patio is formed by the huge monster mouth passageway. Possibly fabric was once stretched over the patio to protect from sun and rain.  
Photograph: A. Drexler 2004



#### Room 44

Please also refer to: GP3.F; S.L-30DW; S.Q-65DN; S.L-25\*DW

Room 44 is the most northern room on the third floor. The western and northern façades are nearly intact up to the roof. The southern wall is also nearly complete. The eastern façade was not sustainable enough to resist nearly 1300 years of periodical rain and heavy attacks of vegetation. This side consisted of three entrances between four pillars, which collapsed including the eastern half of the vault.

Four lower vault beams existed in the vault zone. Unfortunately the upper beam holes did not survive except for one in the South. The room might have been used as a representational space for Room 42.

#### ADDITIONAL ROOMS ON THE SECOND FLOOR

#### Room 45

Please also refer to: GP2.F; S.L-10DW; S.L-35DW; S.Q-85DN; S.L-10DE

Excavations by Renée Lorelei Zapata Peraza revealed that there were also two more towers along the western façade at the corners of the second floor. Room 45 is the northern one of them. These two towers are smaller than the towers at the eastern side of the Palace.

The entrance to Room 45 is on the southern side facing the entrance to Room 46. Three steps guided up into the single room, which forms a temple pyramid together with the adjoining two pseudo stairways. The room and the walls could be defined. The walls did not reach the height of the vault spring anywhere. Therefore the entire roof zone of both towers must remain hypothetically reconstructed.

#### Room 46

Please also refer: GP2.F; S.L-10DW; S.L-35DW; S.L10DE

If you did not know that the northern tower of Room 45 existed, no-one would have even mentioned the very poor remains of Room 46, the south-western tower of the Palace. There are very few remains as the supporting vault of Room 27 below on the first floor had collapsed. With this knowledge about Room 45, it is clear that the remains are the few remains of the fourth tower. There is no doubt about the existence of the tower, but its exact measurements have to remain partly hypothetical. They were taken from the northern tower.

#### Room 47

Please also refer to: GP2.F; S.L-15DW; S.Q-65DN; S.L-15DE

Room 47 belongs to the northern Staircase D on the second floor. Its portal forms one of the seven temple pyramids together with Stairway K to the West.



Fig. 100  
Room 45 is the north-western temple on the second floor.  
Photograph: A. Drexler 2004

In Room 47 the steps from below and above join on an inside platform; this floor level can be reached from outside by three steps within the inner face of the entrance. This also keeps rain water away from the staircase. There are two vault beams in the asymmetrical vault. The first beam might have held a curtain to prevent non-locals from watching the staircase.

#### Room 48

Please also refer to: GP2.F; S.L-15DW; S.Q-35DN; S.L-15DE

Room 48 belongs to the southern Staircase E on the second floor. Its portal forms another one of the seven temple pyramids together with Stairway L in the West.

In Room 48 the steps from below and above join on an inside platform; this floor level can be reached from outside by three steps within the inner face of the entrance. This also keeps rain water away from the staircase. There are two vault beams in the asymmetrical vault. The first beam might have held a curtain to prevent non-locals from watching the staircase.

#### ADDITIONAL ROOMS ON THE THIRD FLOOR

##### "Room" 49

Structure 49 has the form of a small house, faces to the West, and divides the western façades of Rooms 42 and 43. It is part of the row of five house façades on the third floor. Room 49 is the upper end of the northern Staircase D. There is no room for anything apart from the stairs. But the upper end of the staircase is formed like a small house. Its roof reminds us of the capitals of the first floor pillars of Room 1. A curtain must have existed in the entrance to prevent rain water from getting into the staircase.

##### "Room" 50

Structure 50 is the counterpart of Room 49. This also looks like a small house. Its roof reminds us of the capitals of the first floor pillars of Room 1. It is part of the row of three long houses with pseudo entrances and two small house façades on the third floor. Room 50 is the upper end of the southern Staircase E facing to the West. There is no room for anything apart from the stairs. A curtain must have existed in the entrance to prevent rain water from getting into the staircase.

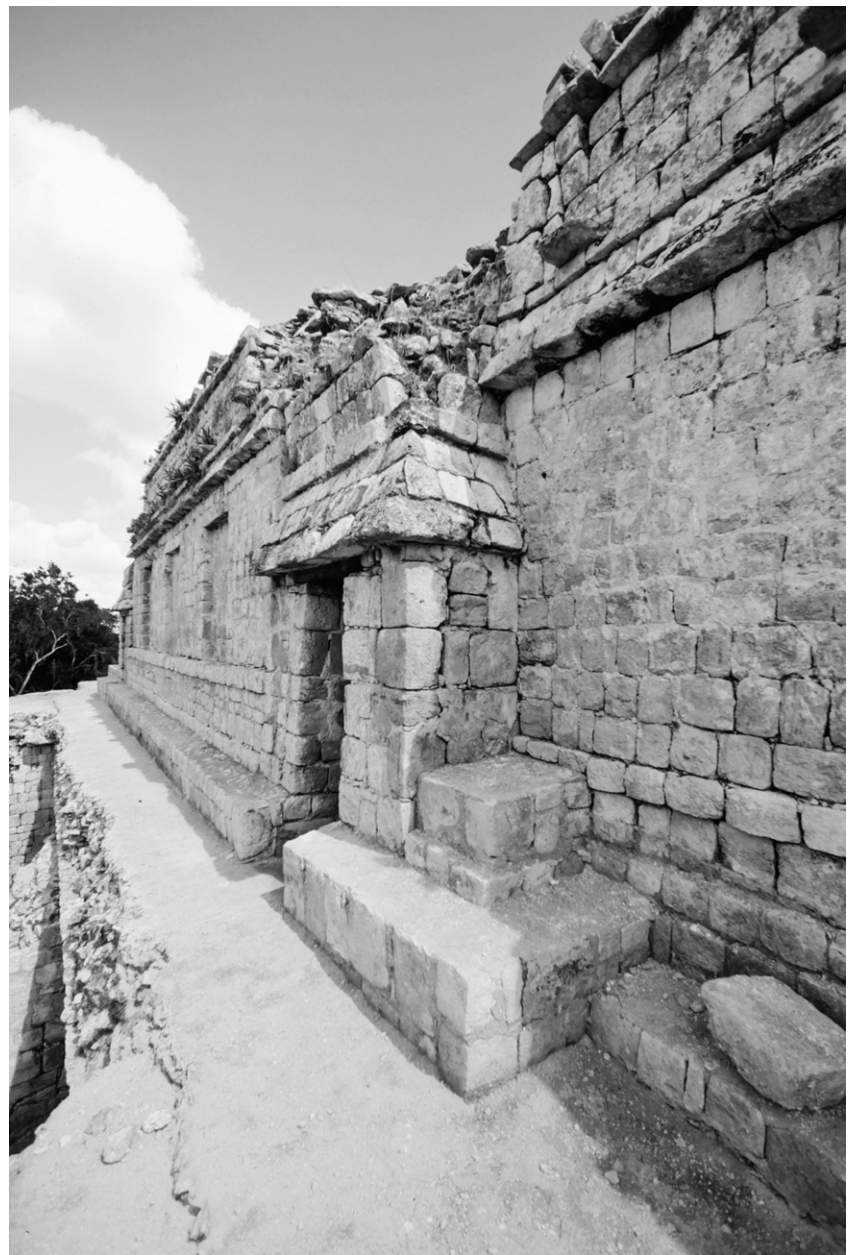

Fig. 101

The third floor entrance of Staircase E also called Room 50 is formed like a small house. The western façade of Room 40 can be seen to the right and the western façade of Room 42 to the left. Both structures show main parts of the three-member base, medial, and upper molding. The coping fourth member of the upper molding is completely missing now.

Photograph: H. Hohmann 2001

## STAIRS OF THE PALACE

### Stairway A

Please also refer to: GP3.F; EFa; S.Q-45DN

Stairway A has to be seen together with the two Stairways S and T, each having only four stretched steps leading from the level of the Plaza del Palacio in the East up to the low platform of the Palace. Just in the center of these two short stairways in the axis of symmetry of the huge Stairway A and where they change their direction a little, is a narrow mask dividing them. The Stairway A starts from the platform and has a quite high first step, which also forms a simple base molding on the sides of the stairway. Above follow 29 steps up to the third floor to the suspected lower jaw of the free standing monster mouth doorway which tops the entire Palace. There were at least two different stairways – one above the other, which were built in different building phases.

The earlier stairway has smaller steps. They are about 27 cm high and 18 cm wide. This stair ends immediately in front of the huge monster mouth passageway, the later one gives space of about one meter east of it. The last few steps of the later stairway as well as of the earlier one were blocked by a massive broad terrace which possibly supported the lower jaw of the monster mouth. This block provided only little space for the steps on both sides to reach the third floor level. The author remembers a quite similar construction on the northern side of Temple 11 in Copan. Around the block in Copan lay the remains of a monster mouth

### Fig. 102

Some teeth near the Palace might originate from the lower jaw of the monster mouth passageway.

Photograph: Erwin Heine

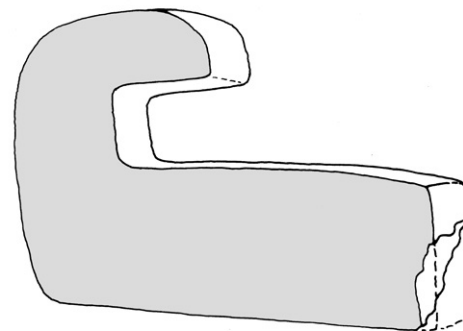

### Fig. 103

One of the teeth around the Palace. The stone element measures approximately 40 cm in length.

Drawing: H. Hohmann

entrance in the debris on the northern stairs. This was the reason for Tatiana Proskouriakoff reconstructing a monster mouth entrance in her perspective of the acropolis of Copan Temple 11. This makes the situation of the Palace at Santa Rosa Xtampak and Temple 11 at Copan comparable. Unfortunately no details of the massive block in Santa Rosa Xtampak have survived. Therefore the reconstruction of the lower jaw has to remain hypothetical and is therefore drawn by dotted lines.

The 30 steps of the later stairway continually became narrower from East to West. There is only one interruption after the bottom 10 steps. At this point the tenth step continues around the corner at its ends and runs back to the mega steps in the South and in the North.

In the reconstructed version in Santa Rosa this step only runs around the corner in the South. In the North the step is not continued. Here the reconstructed version of the stairway starts to reduce the breadth of the steps a little more in the North than in the South, so that the angle of the conically formed stairway changes. Here Stairway A becomes asymmetrical.

The author does not know of any stairway of comparable importance in Maya architecture being planned asymmetrically in such a way. Therefore the reconstruction by drawing shows the stairway as being symmetrical by introducing a mirror image solution of the tenth step in the North, as well.

If someone checks older photos of the stairway it is clear, that the older Stairway A-Sub was broader than the more recent Stairway A. The earlier one focused on the corners of the monster mouth passageway; but Stairway A was narrower. The question is how the distance was bridged.

Old photos of Stairway A suggest that there was a deeper slit about 70 cm wide between the end of the later steps and the mega steps. This slit was possibly formed like a recessing steep ramp or drain with a steep sloping floor. Unfortunately no more data seem to be available.

Fig. 104

The main Stairway A leads up to the monster mouth passageway. Here we can see how broad the different stairways were in relation to the breadth of the monster mouth.

Photograph: H. Hohmann 2001



Fig. 105

The reconstructed version shows that the breadth of the earlier and the last Stairway A are now wider. To the left the ninth step also runs back to the mega steps, to the right it does not. Therefore this version of Stairway A is asymmetrical.

Photograph: H. Hohmann 2004



The flanking mega steps form a nearly vertical wall to the North and to the South here. Therefore there was and still is no possibility of getting from Stairway A directly to the second level. Stairway A does not seem to be functional to climb up to the monster

mouth passageway. It might have been used for ritual purposes by specially trained persons but not for practical uses. The steps are on average 25 cm broad and 37 cm high. This is extremely steep; it seems too steep to be used by normal persons.



**Fig. 106**  
 Here, too we see the ninth step running around the corner back to the mega steps.  
 Photograph: A. Hohmann-Vogrin 2003



**Fig. 107**  
 The situation in 2001 before reconstruction shows that the mega steps do not reach the breadth of the earlier stairway. There must have been something in-between – possibly a recessing ramp.  
 Photograph: H. Hohmann 2001

### Stairway B and C

Please also refer to: GP3.F, S.L-35DW, NF, SF

Extremely steep stairways were constructed in the North and in the South of the monster mouth doorway; the small terrace in front of it joins the second floor with the third optically. The steps are even hanging from the nearly vertical "wall". Stairway B in the North together with Stairway C in the South of the doorway and landing, together with the mega steps and the main Stairway A in the East form a large central pyramid with three stairways on the three visible sides.

### Stairway D and E

Please also refer to: GP1.F, GP2.F, GP3.F, S.Q-65DN, S.Q-35DN, S.L-15DOS.L-15DW, S.L-10DW

Staircase D is the northern of the two staircases inside on the western side of the Palace. Staircase E is the southern one. Both stairs join the first, second and third floors. Both staircases are completely housed-in. The ground plan of the northern Staircase D is nearly a mirror image of the southern one. There are only a very few very small differences between the two staircases. In the entire known Maya architecture these two spiral staircases are completely unique.



From outside you do not know which two of the altogether seven western façade entrances on the first floor lead to the staircases. It seems that it was intended to hide the only two real connecting staircases leading up into the upper two stories. Even Room 19 with the beginning of the northern staircase as well as Room 21 with the beginning of Staircase E in the South have lower vault beams in front of the first three steps of the two staircases. These beams quite certainly had curtains to hide the steps behind.

Behind the entrance of Room 47 on the second floor with the northern staircase and Room 48 with the southern one, there are vault beams near the entrances which also quite certainly had curtains. In this way the entrances of Rooms 47 and 48 looked like the entrances of temples from outside – again the two staircases were not visible.

Although the two staircases are not perfectly formed in a mirror image they have exactly the same number of steps. The northern staircase has 23 steps from the room level of Room 19 to that of Room 47 and another 20 steps from there to the upper end in Room 49. The southern staircase also has 23 steps from the room level of Room 21 to the main level of Room 48 and another 20 steps from here to the upper end in Room 50.

### Stairways F, G, and H

Please also refer to: GP2.F, S.Q-65DN, S.Q-90DS, EF, NF

Stairways F, G and H are too steep to be functional. Together with the six mega steps the three pseudo stairways form the northern, eastern, and southern facades of Room 10 on the first floor. At the same time they form the pyramidal sub-structure, the base of Room 39 at the north eastern corner of the Palace. Pyramid and Structure 39 together form one of the temple pyramids.

### Stairways I and J

Please also refer to: GP2.F, S.L-10DE, S.Q-90DS, NF, WF

The Stairways I and J form the northwestern corner of the Palace and two façades of Room 15. They also form the pyramid, the base of the temple pyramid. The temple is Room 45. Both stairways are too steep to be functional. They are typical architectural elements of the Río-Bec Region. Therefore pseudo entrances were hypothetically reconstructed on the northern and western facades of the temple – Room 45. Otherwise the pseudo stairs would run up to a wall!

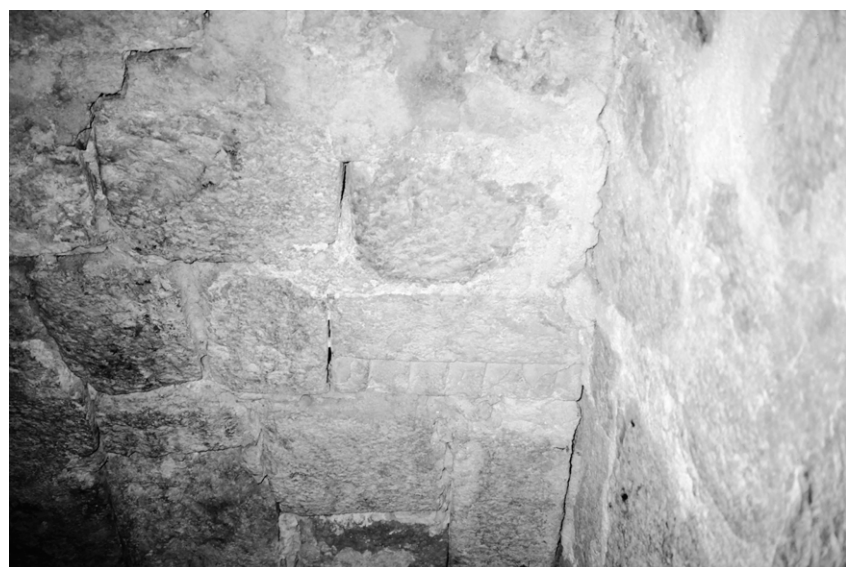

Fig. 108

This spoil in the southern Staircase E was used as a recycled wall stone and plastered over. It is formed like the upper member of the three-member base molding in Room 9.

Photograph: H. Hohmann 1999

Fig. 109

A quite simple spoil in the southern Staircase E was used as a wall stone and plastered over at one time.

Photograph: H. Hohmann 1999



**Fig. 110**

The photo shows the northern side of the mega steps of the northern Stairway K. Above the mega steps the rough construction wall of Stairway K follows.

Photograph: A. Hohmann-Vogrin 2003

### **Stairway K**

Please also refer to: GP2.F, S.Q-65DN, WF

Stairway K leads to the northern entrance of the northern Staircase D on the second floor. The room behind is Room 47. Façade and entrance look like a small projecting temple. Together with Stairway K it forms another virtual temple pyramid.

The stairway was flanked by mega steps (refer to Andrews 1997: 286, Fig. 15) like Stairway L and had a ramp at least in the lowest section. The reconstruction ignores the archaeological result.

### **Stairway L**

Please also refer to: GP2.F, S.Q-35DN, WF

Stairway L leads to the southern entrance of the southern Staircase E on the second floor through Room 48. The entrance looks like a small projecting temple from outside. Together with Stairway L it forms another virtual temple pyramid. Both stairways (K and L) once had a different form and were less steep. The two photographs of Andrews should explain the original form.

### **Stair M and N**

Please also refer to: GP2.F, S.Q-10DN, S.L-10DO, WF, SF

Stairways M and N form the southwestern corner of the Palace and the façades of Room 27. They also form two sides of the pseudo pyramid, the base for the "Temple" – Room 46 of the temple pyramid. The stairways are steep as in the Río Bec Region. Therefore pseudo entrances were hypothetically reconstructed on the western and southern façades of the temple.

### **Stairs O, P, and Q**

Please also refer to: GP2.F, S.Q-20DN, EF, SF

Together with the six mega steps the Stairways O, P, and Q form the southeastern corner of the Palace, the three façades of Room 4 and are part of the pyramid which forms the southeastern temple pyramid together with Room 38.

Generally it is possible to state that the very steep pseudo stairways F, G, H, I, J, M, N, O, P, and Q run up to the four small temples at the four corners of the Palace. Most stairways do not focus on the axis of symmetry of these small temples and their entrances. This is especially amazing for the stairways leading up to the two real entrances to the two temples Room 38 and Room 39. Nevertheless in the Río Bec Region, where these pseudo temple pyramids come from, we also find examples of imperfectly coordinated stairways and entrances as at the main stairway of Structure IV in the South (Hohmann 1998:103, Fig. 178).

### **Stairs R, S, T, and U**

Please also refer to: GR1.F

The huge common platform of the Palace excludes only its western rooms. All the rest of the Palace stands on it. There are four similar stairways leading up to this platform – one on the southern, two on the eastern and again one on the northern side. The two Stairways S and T in the East are divided by a mask and form a very flat angle. In the North and in the South this combination is flanked by rectangular sloping fields. Each of the southern Stairway R and the northern Stairway U are also flanked by such fields. All these four stairs have four steps.

Fig. 111

The photo shows the northern side of southern Stairway L with the flanking ramp, the two mega steps and the end of the façade, marking the third mega step.

Photograph: George F. Andrews  
(Andrews 1997:295, Fig.21a)



Fig. 112

This shows the western façade of the Palace. On the ground floor in the foreground we see the remains of pseudo Stairway L with remains of the two mega steps in the South.

Photograph: H. Hohmann 2001



## COMMENT

The Palace has 19 outside stairways and two inner staircases altogether. There are the four low stretched functional stairways for the common platform (R, S, T, and U). They were used by the inhabitants of the Rooms 1 to 12 and their visitors. They were also used by actors at ceremonies on the U-shaped platform. Then there are the extremely steep 12 pseudo stairways – 10 for the four temple pyramids at the four corners of the Palace (F, G, H, I, J, M, N, O, P, and Q) and the two flanking pseudo

stairways next to the monster mouth doorway (B and C). These 12 pseudo stairways are all flanked by ramps. The two stairways leading up to the two pseudo temples in the western façade (K and L) and the main Stairway A in the eastern façade are less steep but so steep that the author doubts whether they were functional for normal users. Stairways K and L had only ramps in the lower section. Old photos suggest that Stairway A once had a deep recessing ramp between the steps and the mega steps.

## ANALYSIS

The analysis of the architecture of the Palace of Santa Rosa Xtampak – its form, construction, and function.

### SPATIAL CONTEXT OF THE PALACE

The Palace of Santa Rosa Xtampak can also be called Structure 1 (Morales López and Folan 2005:9, Fig. 4) and forms most of the western side of the Plaza del Palacio. All other structures (Structures 8, 9, 10, 11, 12, and 13) around this Plaza are much smaller. The Central Plaza and the East Plaza are east of this Plaza. In the Northeast of this Plaza stands the quite high pyramidal Structure 26. Structure 7 is south of the Central Plaza in the foreground as well as the rear side of the highest and most central pyramidal Structure 2. Structure 2 forms the top of the entire archaeological site of Santa Rosa and is oriented to the South to the elevated Plaza del Sur which, together with the flanking structures, creates the Acropolis of Santa Rosa Xtampak.

From the third floor of the Palace it is possible to see all three mentioned Plazas of the center. The pyramidal Structure 26 in the East, the massive Structure 2 in the South and the Palace surround and define the most central area of Santa Rosa Xtampak on a higher level than the smaller structures surrounding and defining the smaller central Plazas.

### GENERAL CONCEPT FOR THE PALACE

We have to separate the general design of the façades of the Palace into two different architectural categories. The façades consist of seven temple pyramids within the Palace and 21 domestic units, which were built on an artificial mountain with platforms, generally on three different levels. The 21 domestic structures contain 25 apartments of different sizes and include representational spaces in several cases. Seen from outside seven quarters are visible on the first floor, seven on the second floor and seven on the third floor – including the structures with the numbers 49 and 50 in the western façade, which are the entrances to the staircases on the third floor. There are four temple pyramids at the four corners of the Palace and two pseudo temples, in reality the entrances to the two Staircases D and E on the second floor together with the two Stairways K and L in the West, and the huge monster mouth passageway as the third pseudo temple on the third floor together with the Stairways A, B, and C and the joining mega steps.

The long room in the center of the western façade (Rooms 35 and 36) is counted here as one room, which was blocked at a

later date and divided into two rooms by a massive supporting element in the center.

The Palace stands in the South, East, and the North on a platform. A broad stairway leads up to the platform from the South, one from the North and two from the East.

### Seven Temple Pyramids

A temple pyramid stands at each of the four corners of the Palace. All four temples have only one room with one entrance. The entrances to the two eastern temples as well as the two western temples face each other and are orientated to the main east-west axis of symmetry of the Palace. That means the southern temples are oriented to the North, the northern ones to the South. The two eastern temple pyramids each have three pseudo stairways and six mega steps forming the body of the two pyramidal platforms for the two temples.

On both sides of the western façade two more pseudo stairways at each substructure lead from the corners up to Rooms 45 and 46, the two temples on the second floor. The two entrances face each other and the axis of symmetry here as well. The 10 very steep pseudo stairways of the four temple pyramids are typical of Río Bec style architecture. In the Río Bec region all pseudo stairways lead to structures with entrances or pseudo entrances. Therefore here in Santa Rosa the author added pseudo entrances in eight cases, too. The present day reconstruction in Santa Rosa does not show such pseudo entrances above the pseudo stairways. The combination of pseudo stairways and buildings on top with an entrance or with a pseudo entrance is very common and you will find this combination everywhere. Here they form four temple pyramid complexes at all four corners of the Palace.

The western façade is divided into three sections by two more stairways leading from the first floor to the second. The real reconstruction of the two stairways within the western façade cannot be correct. George F. Andrews took photographs and measurements of the remains of these two stairways and the author measured them, too. He documented two less steep and far more differentiated stairways which looked different. Therefore the documented version of these pseudo stairways differs completely from the reconstructed one of the two stairways. The reconstruction should be removed or should be changed following this documentation.

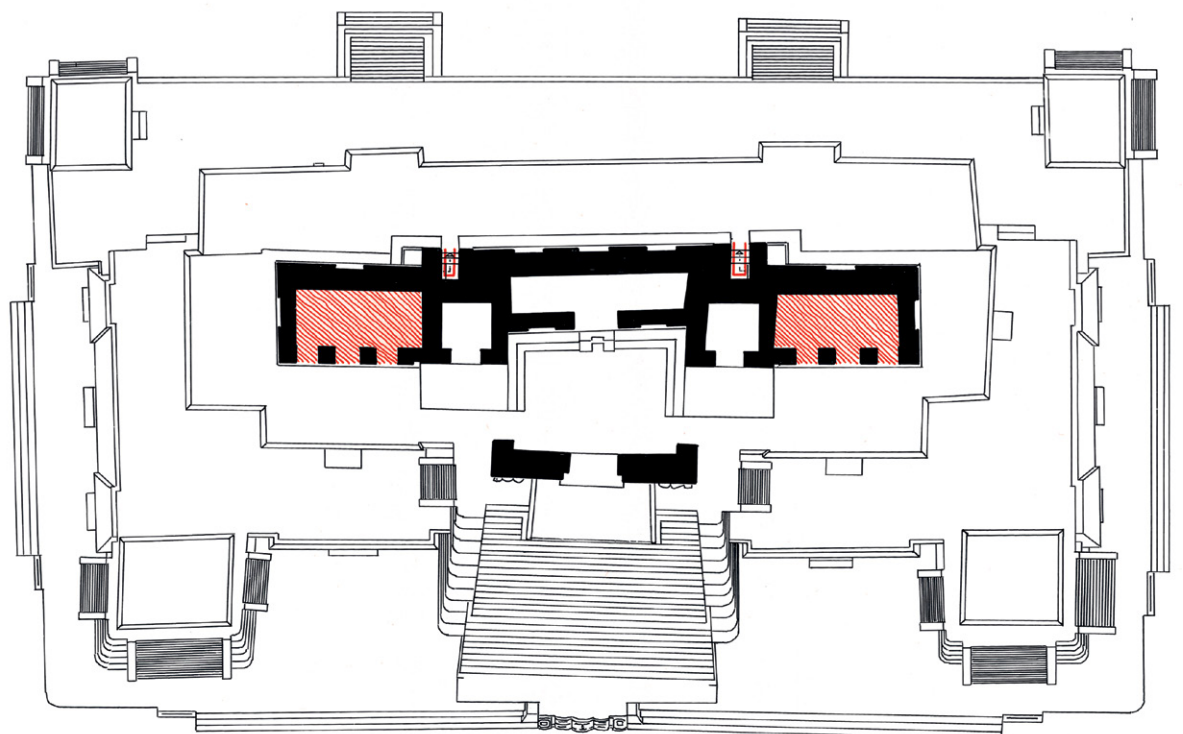
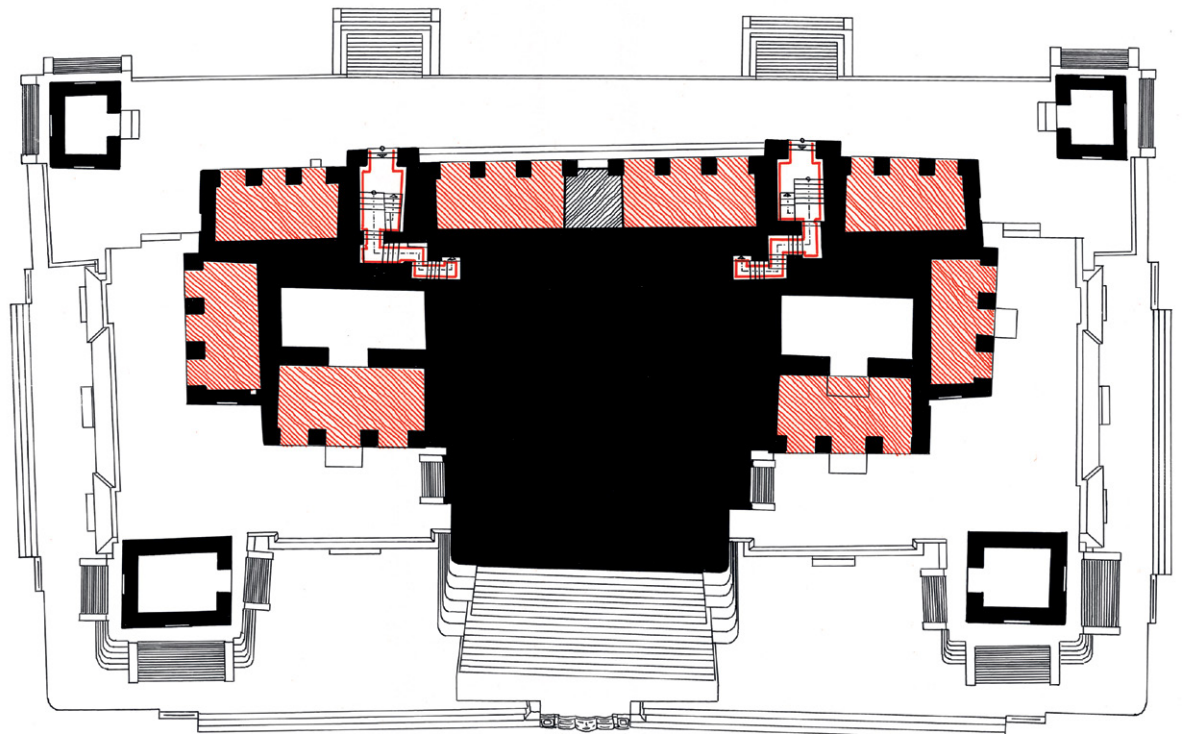
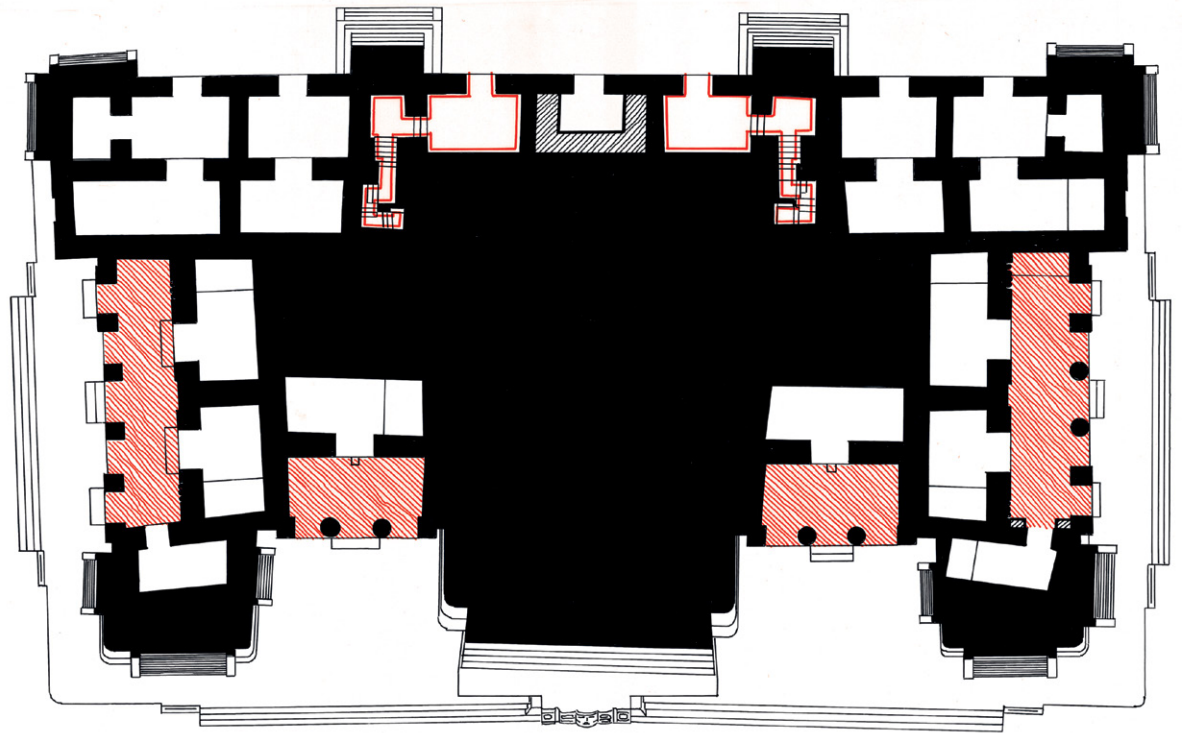





Fig. 113  
Roofed spaces

-  Open or half-open room
-  Room, which can be closed
-  Staircase

0M 5 10 15

The reconstructed very steep version on the site as well as the less steep one by drawing represents two pseudo stairways which are too steep to be functional for normal users. They are just good to cover and hide the real Staircases D and E within the Palace which connect the first floor with the second and third floors. It seems that non-locals coming from the West were not to know how to get to the upper stories of the structure.

The seven entrances on the first floor to both sides of the two pseudo stairways K and L all have the same size and seem to lead to similar domestic spaces. But there is a living space in the North and one in the South, each with three rooms. The flanking rooms lead into two living spaces, each with two rooms. The central entrance on this side guides into the smallest room of the Palace, Room 20. This room is reduced by a U-shaped supporting and strengthening wall built at a later date along the northern, eastern, and southern side of the room. The great weight of the upper stories above must have caused static problems. Therefore the space of Room 20 was reduced to nearly one third of the original space. The two flanking rooms lead into transit spaces for the two interior staircases, which are covered from the outside by the two stairways. These are too steep to be used as normal stairs.

The two entrances on the second floor leading into the Staircases D and E are positioned in the axis of the two pseudo Stairways K and L and form projecting risalits of the western façade which have the form of two temple façades. Therefore these two architectural elements can be interpreted as pseudo temples with only a little more than one façade. Together with the two pseudo stairways they form two more temple pyramids. In this case they are pseudo temple pyramids. Here only three mega steps on both sides of the two stairways are visible.

In the center of the eastern side of the Palace the huge main Stairway A runs up to the top of a structure which can be interpreted as a central pyramid with eleven flanking mega steps, the two pseudo stairways B and C, and a huge free-standing monster mouth doorway on top. This interpretation is supported by the two pseudo stairways which run from the second to the third floor in the North and in the South of the huge doorway. The entire complex of this central pyramid is turned about 2° in a clockwise direction in comparison with the general orientation of the Palace.

All the other facade elements are formed by a number of different types of stone houses standing on all three levels of the terraced artificial small "mountain" of this Palace.

## A Terraced Hill with Houses

The façades of the Palace between the seven temple pyramids represent seven single building complexes on the first floor, seven buildings on the second floor and also seven on the third floor. This count also includes the two small house façades at the upper end of the two staircases in the western façade.

If we study the inner plan of the Palace on the first floor we have only one flat with one room (R20); four flats have two rooms (R5/6, R7/8, R16/17, R23/24), two flats have three rooms (R13/14/15, R25/26/27) and two even have four rooms (R1/2/3/4, R9/10/11/12). On the second floor are 5 flats with only one room (R28, 33, 34, 35/36, 37) and two with two rooms (R29/30, 31/32), if we count Rooms 35 and 36 as originally being one long room and if we exclude the four single temple rooms. On the third floor there are only five single flats with only one room (R40, R41, R42, R43, R44). Possibly one may count the three central rooms together as one flat with three rooms and a joining open courtyard. The two small houses in the western façade contain only the upper stairs of the two staircases and have no other spaces at all.

## Function

As far as the domestic spaces are concerned we have to distinguish between roofed open spaces and closable spaces. At the Palace we find plenty of single roofed but open spaces. It seems it was quite complicated to close them or part of them (R28, 33, 34, 35/36, 37, 40, 44). In some cases these open roofed rooms might have been partly closed. For better concealment Rooms 19 and 21 were certainly also used as domestic one-room spaces. Rooms 38, 39, 45, 46 are the temples at the four corners of the Palace and were quite certainly used as sacral spaces. The three Rooms 41, 42, and 43 might be seen as belonging together – Rooms 41 and 43 as sleeping rooms and Room 42 as a living and representational space.

There are two two-room units on the first floor and two more on the second floor with an open space as the first room. Here only one room is closable. The first room might have been used as a representational space (R5+6, 7+8, 29+30, 31+32). The Rooms 16 and 17 as well as Rooms 23 and 24 are real two-room units. The room compounds Rooms 13+14+15 and Rooms 25, 26, 27 are real three-room units. The two four-room compounds Rooms 1+2+3+4 and Rooms 9+10+11+12 are three-room units with an entrance hall.

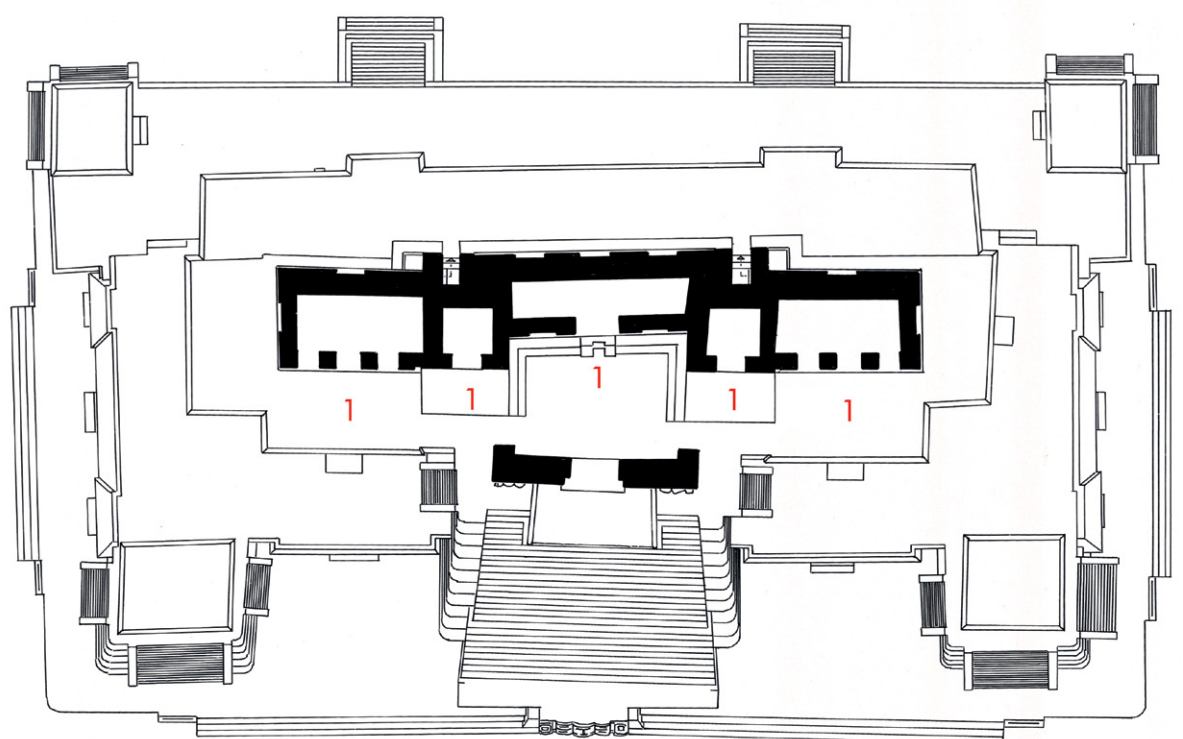
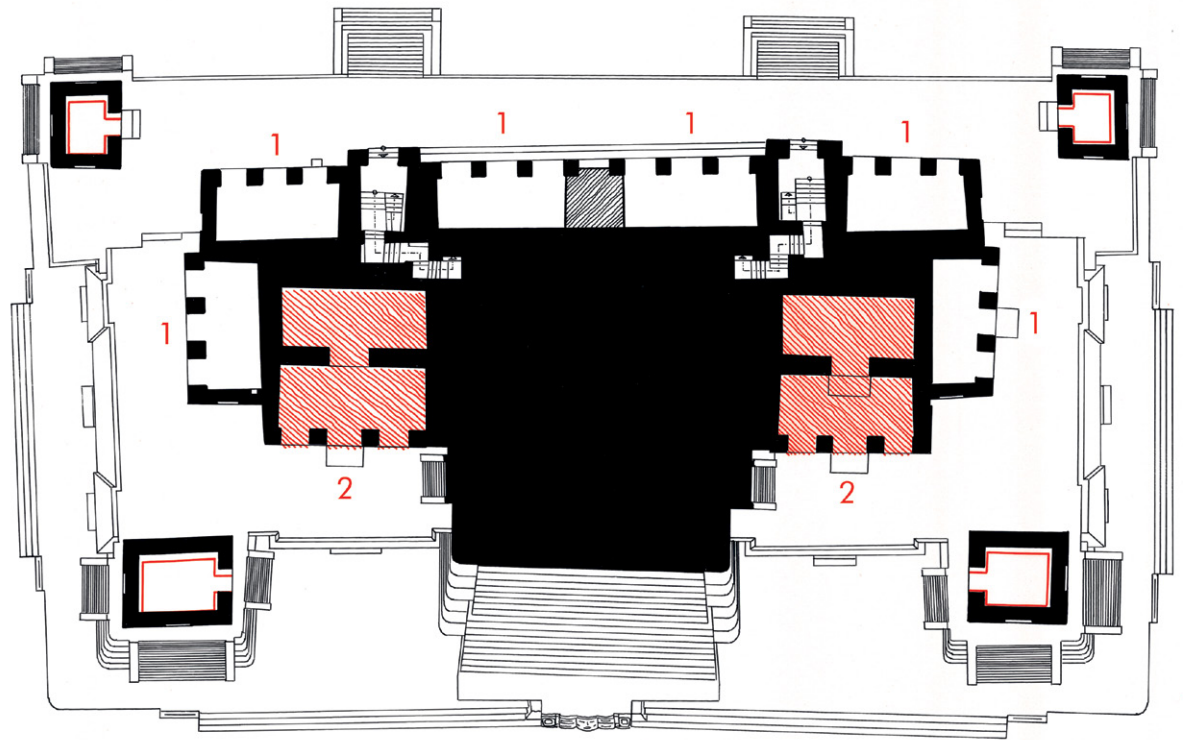
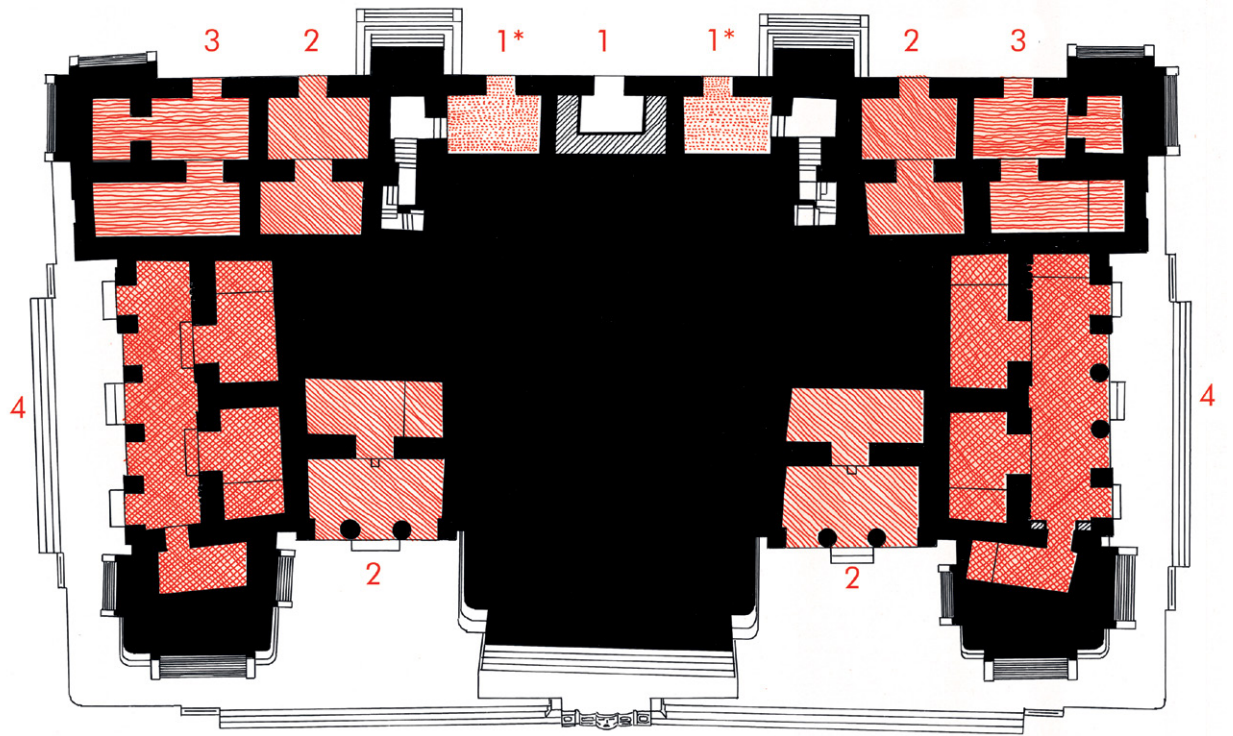
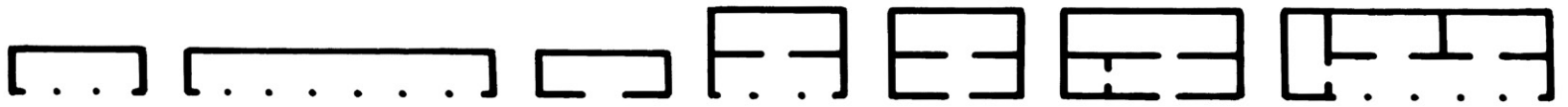

Fig. 114  
Temples and domestic units

- Sacral room
- Domestic room
- ▨ Pseudo room
- ▧ 2 room unit
- ▩ 3 room unit
- 4 room unit

0M 5 10 15



1. Floor			20 19x, 21x	5+6 7+8	16+17 23+24	13+14+15 25+26+27	1+2+3+4 9+10+11+12
2. Floor	33, 34, 37, 28	35/36	38, 39, 45, 46	29+30 31+32			
3. Floor	40, 44		41, 42, 43				
Σ	6	1	10	4	2	2	2

Fig. 115

Diagram showing plan types of domestic units in the horizontal line, floor levels in the vertical line and relevant room numbers in the fields.

### First Floor

On the eastern platform of the first floor there is one two-room structure in the North of the main Stairway A and one in the South. Both structures have two columns flanking the central entrance and two pillars at the sides. In all other cases this type of structure has four pillars along the main façades. The façade of the vault zone represents a roof of perishable material showing a lower three-member and an upper four-member molding. The stone profiles represent the wooden frame which had to press the palm leaves down at the dripping and at the ridge.

Between the two temple pyramids of the southern side we find a quite broad façade of a building complex with four rooms. It stands on a narrow platform with a broad stairway consisting of four very long steps. The complex has its own three-member bases on the platform. The four long steps lead up to three of the five entrances between six pillars of the first room. This Room 1 in the South of the complex is a representational entrance hall for the other three rooms. The hall has two risalits at each side and a roof without any decoration. It seems to be a pure stone roof getting its specific form only from the two side risalits.

Between the two temple pyramids at the edges of the western façade and the two pseudo stairways within this façade are three houses, a central one with three entrances and two more houses, each of them with two entrances on both sides. All three houses stand in a line, have the same base molding, height and roof profile and the entrances all have the same simple format. The base molding consists of two cornices framing a great number of flattened pseudo columns which are also known as colonnettes. Such columns have the form of sections of stone cylinders. The façade of the vault zone represents a roof of perishable material showing

a lower three-member molding and an upper four-member. The stone profiles show the wooden frame which had to press the palm leaves down at the dripping and at the ridge.

The southern house consists of two different living compounds. The southern one has one entrance which leads into a three-room living space. The northern entrance leads into a two-room living space. The façade of both structures looks like the façade of one house.

The central structure has three entrances. The most central entrance belongs to one of the smallest rooms in this Palace. Room 20 and also Room 35/36 above on the second floor had to be used to strengthen the Palace. Serious static problems made this necessary. Therefore a U-shaped additional wall construction was built in Room 20, reducing its floor space from 11.15 m<sup>2</sup> to 3.95 m<sup>2</sup>.

The other two entrances lead to the two Staircases D and E. From the outside you cannot see that you go up to the two upper floors behind these entrances. They both possibly also functioned as domestic spaces to mask the entrances even better. In any case these two passage rooms had to hide the access to the only real two staircases connecting the first floor with the second and third floors of the Palace perfectly. Both rooms, Room 19 and Room 21 have lower vault beams near the starting point of the staircases. Quite certainly each of them had a long curtain to make the illusion perfect. Only insiders of Santa Rosa Xtampak or even only of this Palace knew how to get to the two staircases and by them to the upper floors.

The structure in the North has again two similar entrances and also similar roofs with similar profiles at their vault zones. Here one entrance leads into a two-room living space, the second northern one into a three-room living space.



The structure on the northern façade between the two temple pyramids again has four rooms like the southern façade. This façade also has two side risalits, one in the West and one in the East. Along the northern façade of Room 9 we find five entrances leading into the long representational hall of this four-room living unit. In this case the central entrance is flanked by two columns instead of the two pillars in Room 1. The other supporting architectural elements are four pillars formed as in Room 1. This structure also has a simple flat stone roof, which looks very different compared with all the other roofs of the Palace except the roof of Rooms 1, 49, and 50. Its design is also only differentiated and formed by the two side risalits.

All the other roofs of the other 17 "houses" and also those of the 6 temples on the second floor have roofs with three-member moldings. Their details represent thatched roofs of perishable huts. The stone profiles represent wooden sticks, pressing the palm leaves of a thatched roof down at the ridges and at the drippings.

All 25 buildings, 19 living spaces and 6 temples seem to be standing on different terraces of an artificially formed mountain. Together with the central stairway in the East and the 14 pseudo stairways they form the Palace from outside. Therefore, the outside does not fit with the inner concept everywhere - with its rooms and its functions like the two inner staircases.

Along the eastern façade of the Palace for example, the core of each of the two eastern substructures of temple pyramids on the ground floor is a sleeping room, belonging to the two four-room complexes. Behind the three pseudo stairways O, P, and Q, leading to Temple 38, and also behind the three pseudo stairways F, G, and H, leading to Temple 39, are Rooms 4 and 10.

The sleeping Room 15 is positioned behind the two pseudo Stairways I and J leading up to Temple 45 and the sleeping Room 27 is behind the two pseudo Stairways M and N leading to the Temple 46. The two inner Staircases D and E are hidden behind the two pseudo Stairways K and L within the western façade leading up to the two "pseudo Temples" 47 and 48. The axes of symmetry of the façades of Room 1 and of Room 9 do not fit with their inner short axes of symmetry. This all demonstrates that in many cases the façades cover a different kind of reality. One of the intentions seems to be that other people should not become oriented by watching the façades of the Palace. The lack of locks in Maya civilization was quite certainly a problem for the elite living in the Palace. The purpose of the façades was to disorient other people. This was possibly to raise its security.

A second reason might have existed for the 14 pseudo stairways on all sides of the Palace. Pseudo stairways together with pseudo temples are typical of Río Bec architecture and seem to

create a background stage for ceremonies which took place in front of them on their raised platforms. Mainly the platform on the east side of the Palace – oriented to the joining "Plaza del Palacio" in the East - must be seen as the basis for such ceremonies.

On each side of the eastern façade three pseudo stairways on each substructure lead up to Rooms 38 and 39. The entrances of the two rooms face each other, the axis of symmetry of the Palace, and the beginning of the large central stairway.

The façades of the Palace between the seven temple pyramids represent seven single building complexes on the first floor, seven buildings on the second floor, and seven on the third floor. The two five-entrance complexes on the ground floor in the North and in the South each have four rooms, the open entrance hall and three connected living rooms. Each of the two complexes to the East has only two rooms, an open entrance room in front and a living and sleeping room in the back. Seven seems to be an important number at this Palace.

## Second Floor

First of all there are the four single free standing one-room structures, the temples of the "temple pyramids" on the second floor. Another four half open one-room structures, Rooms 28, 33, 34, and 37 stand on the second level and each has four pillars on the open side. One very long one-room structure to the West with eight pillars forms the centre of the western façade of the second floor. This Room 35/36 had to be divided into Rooms 35 and 36 by a huge supporting block. The weight of the third story must have been too great. Therefore this dividing block, as well as the U-shaped construction in Room 20 on the first floor, was necessary for static purposes.

The two small one-room structures 47 and 48 form the joints between the three "houses" along the western façade on the second level. They look like small temples and have to be seen together with the concentric pseudo stairways K and L as two more temple pyramids within the western side of the Palace – as already stated above.

Structures 47 and 48 are neither real temples nor living spaces. They form the entrances on the second floor to the two inner Staircases D and E. Both are rooms with stairs leading up to the third floor and leading down to the first floor. Both rooms include a landing on the western side to be able to enter the terraces on the roof of the first floor through the entrance. All the rooms on the second floor are only accessible from this roof system on different levels. Rooms 47 and 48 are part of a real housed in staircase, which is very rare in Maya architecture.

On the eastern side of the second floor stand two two-room units

facing east. Each has a roofed open space, an entrance hall with four pillars at the eastern façade. These two "houses" have cord holders at the passageway into the inner rooms indicating a living function. The remains of a wall painting in Room 29 with the representation of four persons and a frieze with indications of an inscription in Maya hieroglyphs show the high rank of the unit. The other half open rooms on this floor might have been used for persons from the ground floor for representational purposes.

### Third Floor

The third floor was principally connected with the Plaza del Palacio via the large central Stairway A on the east side of the Palace. But this stairway might have been used by specially trained persons for ritual purposes only. At an angle of approx.  $54^\circ$  this stairway is very steep, nearly a pseudo stairway. The huge monster mouth doorway at the upper end of the central Stairway A is flanked by two pseudo stairways between the second and third floors. They are both too steep to be functional.

The only real stairways are the two inner Staircases D and E. They provide the only effective access to the different floors. But they are quite narrow and therefore possibly one staircase was used for the way up and the other one for the way down.

There is one large one-room building just in the center of the third floor. On both sides are two small flanking one-room structures, each also with only one entrance. In the North and in the South of the row of rooms are two more one-room buildings. These are quite open having four pillars forming one long open side with three entrances. All the entrances of these rooms are open to the East.

Within the western façade of the third floor are two more very small houses opening to the West. They form the entrances into the two Staircases D and E on this floor. The roofs of these two small structures show no profile at their drippings, have a very fine frame around the upper part of the roof, and are formed as if they were bound by a horizontal band in the center. Both remind a little of the capitals of the pillars of Room 1 and Room 9 on the first floor.

The free standing monster mouth doorway on the third floor leads into a courtyard in front of the uppermost and most central long room of the Palace, Room 42. There are no cord holders or rod sockets. But there are lower double vault beams at both ends of this 7m long room. The room might have been used as a representational space. In relation to the double vault beams it might have functioned as a ceremonial room for a priest or a ruler who could sit and hold his audience in a hammock. This person and his family might have slept in Rooms 41 and 43.

### The General Form

Teobert Maler called the Palace the "Tempelpalast Xtampak" (Maler 1997:213), the Temple Palace Xtampak. He already realized in 1891 that the complex was more than a palace. The result of the analysis of the reconstructed form of the complex summarizes that it is composed of known architectural elements such as temple pyramids and more or less large houses. Some of them are more closed massive structures with small entrances; other houses have quite open entrance halls with pillars or columns as supports for the stone roofs. At the very long Room 35/36 we find seven entrances between eight pillars. All entrances have the same breadth and produce a quite open structure. At other rooms such as Room 1 and Room 9, we find a ranking of entrances; the five entrances between these supports have two different breadths. In several other rooms like Room 5 we also find two different breadths.

In several cases the ground plan of a domestic unit does not fit with the façades outside. The façade of Room 1, the long entrance hall of the four-room unit, is even shorter than the inside of Room 1 itself. Room 4 as well as Room 10 is hidden in the center of the substructure of Room 38 respectively Room 39, as described above. The façade does not always correspond with the inside!

The Palace is not really rectangular. There are a lot of slight deviations from the general orientation. We find the longest straight line on the first floor along the western façade between Room 14 and Room 25. The greatest deviation of  $8^\circ$  can be found at Room 10 in relation to the long straight line in the West. The second largest deviation of  $6.5^\circ$  can be measured at Room 4. Room 4 and Room 10 focus on a point under the Stairway A. The two long entrance halls Room 1 and Room 9 are not parallel to each other either. They are deformed by the Rooms 4 and 10 and have an angle of  $3.3^\circ$  to each other.

There are three rooms with lower pairs of vault beams at both ends of the room. These are Room 42 in the center on the third floor and Rooms 6 and 8 on the first floor. They are symmetrically positioned to the left and to the right of the huge eastern Stairway A and the axis of symmetry of the Palace. In these three rooms hammocks might have been used for ceremonial purposes and possibly also for sleeping.

The entire complex is a mixture of sacral and profane architecture. Teobert Maler already realized this in 1891 when he visited the site for just two and a half days. He was a very fast worker documenting the architecture of the Palace quite carefully including several reliefs, graffiti and paintings. He also produced large glass negatives of the architecture and of the reliefs for wonderful photographs during this time.

## FORM, CONSTRUCTION, AND FUNCTION OF ARCHITECTURAL ELEMENTS OF THE PALACE

### FAÇADES OF THE PALACE

The façades of the Palace are pieced together like a puzzle of different architectural elements. There is the basal platform in the East of the Plaza del Palacio, there are the base moldings, the walls, the medial moldings, the roof zones with corbels and the upper moldings. The pseudo stairways which can also be called nearly vertical reliefs and less steep but not really usable stair reliefs also have to be counted as part of the façades. Wall openings are simple rectangular entrances as along the western façade on the first floor or open walls between groups of pillars or columns as in the North and in the East. We find several pseudo entrances mainly in the western façade on the third floor. The eastern façade is dominated by a single huge monster mouth passageway. A comment about the use of roof combs is included in the paragraph on roof combs.

Inside the Palace we find rooms with floors on different levels, walls, corbelled vaults, passageways and two staircases. Under the walls between the front and the back rooms are usually also three-member base moldings. In the rooms we find benches, niches, cord holders and lower and upper vault beams. Near passageways and entrances we find cord holders at the inner side of the walls, we find lintels and rod sockets at the inner face of wall openings.

All these elements will be discussed in the following list of architectural elements. The discussion will not be structured by architectural elements of different levels as the documentation concerns only one large structure.

#### Platforms

##### ◦ Form

Platforms are usually the basis of buildings. They generally lift the building out of the surrounding area and help to keep it dry. A building on a raised platform is the prototype of the temple pyramid of Mesoamerican sacral architecture in general. The difference is that in sacral architecture everything becomes larger and higher than in profane architecture.

The Palace of Santa Rosa Xtampak stands on a platform in the North, the East, and the South. The western side stands directly on the floor of the Plaza del Palacio. Beside this all rooms have their own base on all sides, which are visible from outside by a base molding consisting of three members, a lower and an upper projecting cornice and a recessing middle member.

The common platform has a surrounding wall which itself stands on a simple narrow projecting base and has a simple projecting cornice at the upper end. Four low stairways each consisting of four long stretched steps lead up to the platform level. We find these stairways in the North, in the South, and two of them in the East of the Palace. The two stairways in the East are separated from each other by a mask just in the axis of symmetry of the Palace. In the North and in the South they are each flanked by a tablero element. We find most tableros as typical architectural elements in Teotihuacan but they were also used at several buildings in Maya architecture as for example in Copan at Structure 20A or at Kaminaljuyu. Tableros are vertical or at least extremely steep rectangular standing fields with a surrounding simple rectangular projecting frame. Usually they are built of stone. The stairways to the Palace in the North, in the East, and in the South are also each flanked by two such similar tableros.

##### ◦ Construction

It seems that the natural rock was not plane under the Palace and had to be flattened artificially. This would explain deformations at some locations of the Palace on the first floor such as under the walls between Rooms 5 and 6 as well as between Rooms 7 and 8. The base molding of the southern side of Room 1 and other parts of the Palace are also sunken into the general platform.

In all these cases the base was not strong enough. Presently the Palace shows no major cracks. The Austrian Team did not dig and therefore the substructure, the construction of the platform could not be studied. Nor were there any locations where destruction by erosion or archaeological activities made the inside of this substructure visible.

Usually these platforms consist of a mixture of compressed rubble and earth forming the body of the platform flanked at its sides by walls built up of well-cut stones, which are rectangular on the surface and quite roughly cut on the back side. At some sites the Maya constructed quite massive and broad stone sub-walls under supporting walls down to the natural ground to be sure that there would be no problems with the foundation under a structure. This for example was well documented by Jack Eaton for Chicanna, Structure II (Eaton 1972:49).

##### ◦ Function

First of all the platform was used by the inhabitants of the Rooms 1 to 12. They had to use one of the Stairways R to U and had to cross the platform. They might also have used the platform for part of daily life, as in smaller courtyard groups. The four relevant domestic units were well separated from each other by the

three eastern temple pyramids.

The pseudo stairways and pseudo entrances to the sacral components of the Palace indicate that it was also used as a scene - that the pseudo architecture was the background of ceremonies in front on the platform system. Such ceremonies were better visible for people on the Plaza del Palacio, if the actors were positioned on a raised platform. Therefore the platform also had the function of a stage.

### Base Moldings

#### ◦ Form

All single structures of the Palace, all buildings on this artificially constructed and terraced mound have their own base and base moldings. Nearly all of these base moldings have three members, a simple projecting lower member, a recessing middle one, and a projecting upper member.

There are also base moldings on the façades and within the structures for back rooms under the dividing common walls.

Base moldings of some structures play with different levels of the recessing middle member. Near the edges it recesses less than the fields between, as for example on the eastern façade of Room 5. The base molding of Room 6 has flat niches with groups of three ornamented colonnettes at both sides of the passageway. We also find similar flat niches on the base molding of Room 8, visible in Room 7. Here the niches each have four ornamented colonnettes.

Some base moldings seem to have only two members but they might have a third member presently not visible and which is covered as in some sections of Room 7 or 9.

Here the upper base molding is ornamented with rhombi and fringes. All the molding elements are spoils, reused stone elements from earlier structures. In Room 1 the three-member base molding has groups of three simple colonnettes in the central recessing member.

The western façade of the Palace has no platform, but all rooms have a three-member base molding with a long row of colonnettes nearly from one end of this façade to the other. In the South and in the North of this very long base molding a less recessing plain short field forms the beginning or the end of the central member of this base molding.

#### ◦ Construction

The construction of the base moldings and the raised platforms behind is very similar to the construction of platforms.

#### ◦ Function

Air with higher humidity in the back rooms can flow more easily to the outside if the floor levels are stepped up from the first room to the second. We find similar stepped floor levels everywhere in Maya architecture. In the Palace of Becan we even find three rooms one behind the other with three different floor levels.

### Walls, Pillars, and Columns

#### ◦ Form

Walls, pillars, and columns as well as wall openings form the sides of the 50 rooms of the Palace. The walls have geometrical stone faces, which were covered with a fine plaster material. Remains of paint have been detected on this plaster in several rooms. That shows that at least several rooms, possibly all rooms of the Palace, were once painted. It was possible to prove for some rooms that their walls were decorated with polychrome wall paintings and inscriptions.

Several pillars with two different kinds of bodies and two different forms of capitals have survived in the Palace. Different combinations of these elements form three different pillars in the Palace. The term "pilaster" should not be used for pillars at corners, as they are nearly free standing. Pilasters are like a vertical high relief coming out of a wall half way or even less. In most cases pilasters do not even have a carrying function and are more a part of the design of a wall. In most cases they show only 10 to 40 percent of a full pillar.

a. There are 10 pillars on the first floor with a three-member base molding, a profiled shaft at the façade and the tethered capital.

b. There are 24 pillars with a three-member base molding, a profiled shaft at the façade and a capital which looks like the three-member base molding. We find them on the second floor on the southern, eastern, and the northern façades and on the third floor on the eastern façade.

c. There are 16 pillars of the third type used on the western façade on the second floor. They have a three-member base molding, a plain rectangular shaft and a three-member capital like the second type.

Some of the pillars show remains of plaster covering the stone and all of the surviving pillars are not really free standing and situated at the building corners. They are bound into the side walls and therefore survived. But, as already stated, the term "pilaster" should not be used for them.

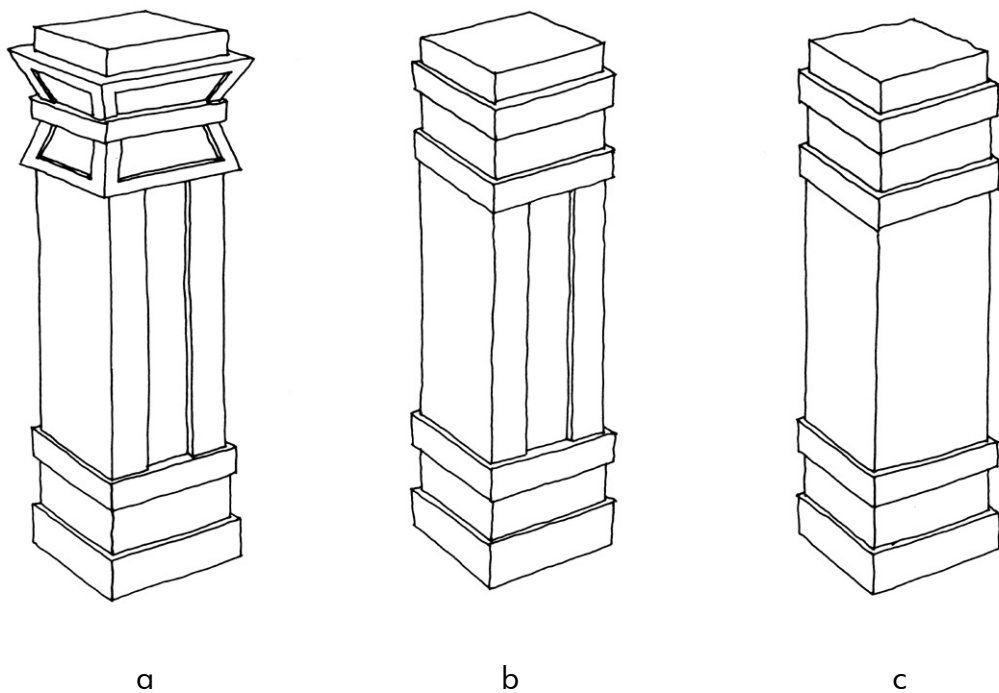

Fig. 116  
Three types of pillars.

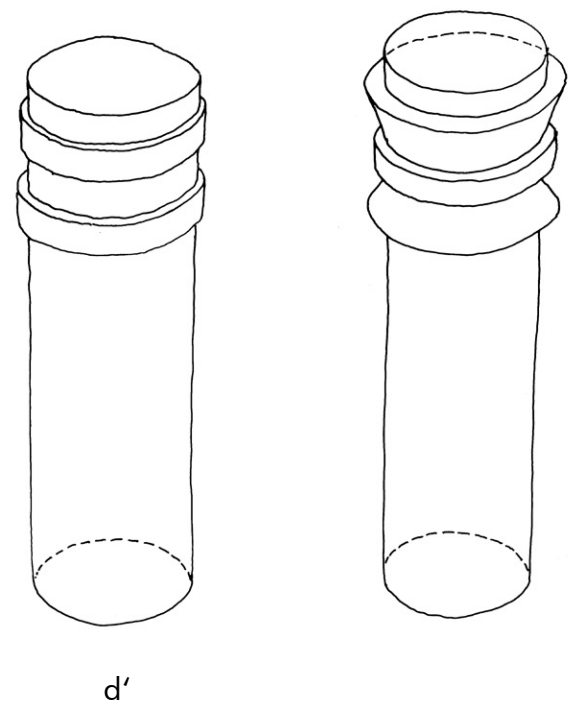

Fig. 117  
Two types of columns.

d. The main entrance of the reception hall for an important room compound is marked and flanked by two free-standing round supports for three rooms on the first floor (Rooms 5, 7, and 9). Neither of them has survived up to the capital - if there was one. Therefore, in this documentation, the capitals of these round supports have to remain hypothetical. The form of the capitals in this reconstruction was taken from the pillars next to them and also compared with other sites. The round supports can only be called columns if they once had capitals.

Capitals, as at Room 9, are documented in Channá in the Río Bec Region (Gendrop 1983:148 and 149) and in El Delfin in Campeche some 60 km north-west of Xpuhil (Merk 2015:39-43). They are also quite common in a smaller size as colonnettes in roof zones of the entire Puuc and of the Chenes region. It seems quite certain that the round supports at the Palace of Santa Rosa Xtampak once had capitals as the pillars have them.

Usually the main entrances are flanked by more elaborated supports than the pillars with capitals at the corners of the building. Therefore the capitals of the columns should have a form like the pillars at the corners.

At other structures, the builders of Santa Rosa Xtampak used monolithic round supports as at the Southwest Building (Hellmuth 1989:94a+b, Fig 17+18).

#### ◦ Construction

The front of each stone of the walls was plane and near to rectangular in format. The core of the walls consists of layers of a mixture of quarried broken stone material and lime mortar. The veneer stones consist of a quite soft limestone. The wall stones were laid in mortar and touch each other. This is important for the horizontal joints of walls to be able to take high pressure stress.

There are two different categories of masonry workmanship, exterior and interior as Potter (1977:38) already stated for Becan, Structure IV. The interior wall stones show less careful workmanship than the exterior. Generally this is also true for the Palace of Santa Rosa Xtampak. We also have to distinguish between the corners and the centre of large long façade walls. The corners often show stones of larger sizes and for the central portions of walls smaller stones of rectangular shape were used.

The reason for these three different types of masonry on the exterior and the interior walls is quite certainly of static nature. Corners of exterior walls are more exposed to the weather than the central section of walls. The bigger the stone elements are, the fewer joints with softer mortar are needed and the stronger the corners and surfaces are. There is no eroding water in the rooms and the edge stress of the walls is not as high as for façade walls.

Exterior walls are exposed to the weather. Therefore the plaster coating is destroyed faster. The better the stones of an

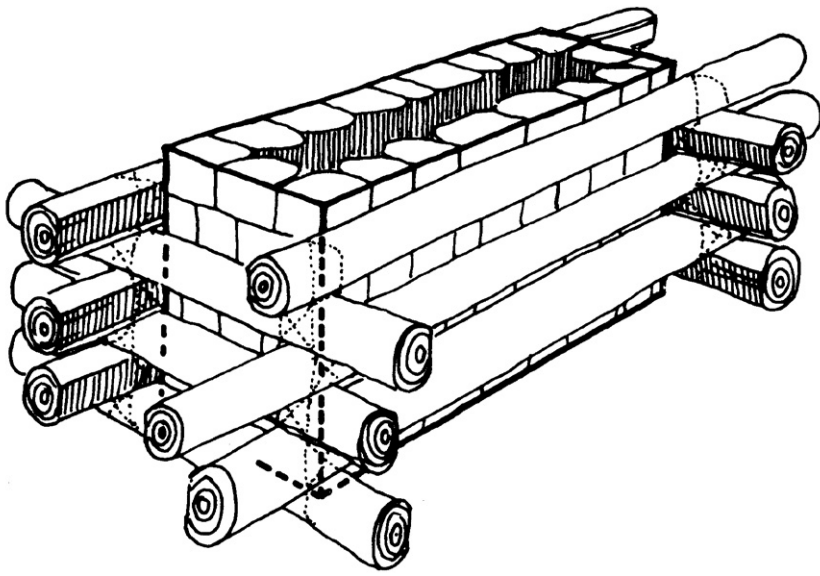

Fig. 118

Veneer stones for the mortar and rubble core of a wall section are held together by intermittent timber paneling (Hohmann 1978:112). The next constructed joining wall element will not interlock with this wall section.

exposed wall are formed and the better they are put together in such cases the better the wall will resist the eroding power of the weather.

In some cases the size and quality of wall stones changes without any recognizable reason even within the same wall. It seems that the builders were recycling stone material obtained haphazardly from useless, earlier structures, or collapsed ones, to be made use of at a later convenience.

In no instance have masonry corners in the Palace been observed to be bonded. This is a fact one can find throughout the Maya area. For Copan, the author tried to find the reason for this kind of strange construction principle (Hohmann 1978:112). At the Palace of Becan, Structure IV, it was the same (Hohmann 1998:122). Possibly each portion of a straight wall was built in a very specific way so that the Maya could not use such bonded masonry at the corners. It is quite certain that at least in some cases the Maya used an intermittent casing mold to hold the veneer stones in position until the fill, the mixture of mortar and rubble, had hardened. This mold could have been produced by straight beams on all four sides which were tied together with ropes at the ends. In addition, the great weight of the heavy vaults above the walls contributed to keeping them in place.

The other supporting architectural elements such as pillars and columns were put together out of rectangular or rounded stone elements which were bound together by a good lime mortar. At the Palace of Santa Rosa Xtampak we do not find monolithic supporting elements. This is certainly the reason why all these quite fragile architectural elements, which had to carry more weight than the walls at the opposite side of the rooms, collapsed to-

gether with one half of the vaults above. The Maya used long vertical stone elements for the shafts of pillars which reduced the number of plaster joints and raised their stability.

#### ◦ Function

Solid stone walls make the façades of the complex quite massive. Pillars or columns make the structure look lighter. The façades of the entire second floor and the eastern side of the third floor as well as the southern, eastern and northern façades of the first floor show plenty of pillars and columns and therefore look very light and transparent. Most of these half open spaces might have had representational functions. In some cases they revealed indications for a domestic purpose.

#### Entrances and Pseudo Entrances

#### ◦ Form

The breadth of entrances at the Palace measures from 92 cm at Room 38 at the south-eastern corner and Room 45 at the north western corner, two of the four temples on the second floor, to 124 cm at Room 43 and 178 cm at Room 42 on the third floor. It seems that the breadth of entrances at the small sacral buildings was constant and at profane structures was a measure of the importance of a room behind.

The seven entrances on the western façade of the first floor are all around 120 cm wide. This is nearly the same breadth as between the pillars of Room 35 and Room 36 on the same side on the second floor. This was the western, the outer and

back façade of the Palace and it seems that entrances should all have the same breadth here. The form of entrances on the first floor on the western side should not be differentiated at all and should not show which two are the entrances to the two staircases.

The breadth of pseudo entrances measures between 90 cm at the eastern façade of Room 28 on the second floor and 140 cm at the eastern façade of Room 42 in the center on the third floor. This shows that the broadest entrance and also the broadest pseudo entrance are related to the most central room on the third floor just behind the monster mouth passageway. This room must therefore also have been the most important room of the Palace.

The main heights of entrances vary at the eastern façade between 250 cm on the first floor to 230 cm on the second and to 210 cm on the third floor. It is amazing that the entrance of Room 42 is only 200 cm high.

Pseudo entrances are large flat niches in façades, going down to the floor level of the room behind. The heights of pseudo entrances measure between 210 cm on the first floor, 230 cm on the second floor on the eastern side and 180 cm at Room 42 on the third floor of the western façade. In several cases these pseudo entrances have a step of about 13 cm between the inner floor level and the beginning of the flat niche in the façade.

#### ◦ Construction

Entrances have lintels made of very hard wood. The lintels are flattened on the underside and show a round natural form above. In some cases the sides seem to have been straightened,

so that the lintels could be added more easily. In length they are mainly straight, in some cases conically formed. The lintels extend their length into the walls on each side for about 20 to 30 cm.

Pseudo entrances are large flat niches. They have stone corbels above the upper end instead of lintels.

#### ◦ Function

All entrances have to give access to the rooms of the Palace. Optically the Palace opens to the Plaza del Palacio in the East. On the first floor all entrances were accessible. But for the upper stories people needed the knowledge of the two inner staircases to be able to get to the upper floors. Only accepted people with this knowledge could reach them.

The main, the eastern façade of the Palace has entrances on the first floor with a height of 250 cm; on the second floor the height measures 230 cm and on the third floor the entrances are only 200 to 210 cm high. It seems the optical height of the Palace should be increased by the reduction of door formats in upper stories. In many cases the use of smaller wall openings in upper stories was also used in the Old World to produce an increasing perspective effect. It must have served the same function at the Palace of Santa Rosa Xtampak.

The use of so many pillars on the eastern side and massive walls in the western façade gave the Palace a more defensive character to the West, to the East a more open and a lighter one.

The purpose of pseudo entrances is mainly to structure the façades of large walls optically.

## Façades of the Vault Zones

The exterior façades of roof zones of stone structures with corbelled vaults behind usually represent the roof of a hut built of perishable material. They include the medial molding and also the upper molding.

The form of the three-member medial molding represents the dripping of a Maya hut with the wooden frame made of sticks surrounding the entire roof, holding the lowest row of palm leaves down. The upper molding usually represents the wooden frame of a Maya hut pressing the uppermost palm leaves on both sides of the ridge down.

### Medial Moldings

#### ◦ Form

In most cases the façades of the Palace have a medial molding immediately above the lintels of entrances or pseudo entrances. The vault spring inside is usually a little higher. The vertical distance usually measures between 5 and 17 cm.

The medial molding usually has three members. There is a projecting and sloping lower cornice, a recessing medial member and a vertical projecting upper cornice. At its two ends the lower cornice is turned up and also covers a small part of the recessing medial member like a three-sided frame. Immediately above the three-member medial molding we find plenty of corbels resting on the molding. They once carried sculptures.

#### ◦ Construction

The stone elements of the lower member of the medial molding are quite long and well-fastened in the stone and mortar core behind. The medial member consists of short stones and the upper member again has long corbelling stone elements. The corbels for sculptures rest immediately above the upper member which takes their vertical pressure stress at the joint.

#### ◦ Function

The form is taken from Maya huts of perishable material. There is often a wooden frame made of sticks along the dripping and surrounding the entire roof, holding the lowest row of palm leaves down. This is represented in the medial molding.

## Painted Medial Molding Cornerstones

#### ◦ Form

Painted molding cornerstones belong to the lower member of a three-member medial molding of a façade of a Maya stone building. They form part of the corner of the vault zone. In the few cases of a painted cornerstone, it is painted on the underside. In several cases part of the painting is visible under the projecting cornerstone and continues in the horizontal joint between wall and molding.

In Maya architecture such cornerstones are very rare. In the Palace we find one at the northeastern corner of Room 14. It was already described by Stamps (1970:57 and 112, Fig. 29c). However, he did not realize that it is a special type of decorated molding cornerstone. A second medial molding cornerstone might be suspected at the southeastern corner of Room 26.

#### ◦ Construction and Function

Painted molding cornerstones were usually painted before they were used for the building. They were possibly set into the construction in a special building ceremony to give the structure a successful future.

## Façade Corbels

#### ◦ Form

The vault zone at the Palace between the two moldings is usually flat, undecorated and slightly sloping – approximately 10% from vertical. The decoration must have been the sculptures standing on the lower row of corbels above the medial molding and held by the upper corbels of the upper molding in this part of the façades.

#### ◦ Construction and Function

At many of the Maya sites we find core walls used for the vault zone. Core walls provisionally closed the cast vault to the outside until the final façade was finished. In cases of a quite simple vault zone as at the Palace this was not necessary. For this reason we do not find core walls at the Palace of Santa Rosa Xtampak. Here the decoration was produced together with the corbels of the façade.

For the flat vault facades only spaced wooden paneling was used. In this technique it was possible to use the façade stones as veneer stones instead of a mold. Very detailed façades with



a lot of reliefs on different levels could not be constructed in this way. Therefore in such cases a core wall façade was used with quite rough stones. This was necessary to bind the later relief with mortar to the core wall.

In the façades of the upper wall zone, the vault zones of the Palace, we find corbels on two different levels. The lower level corbels rest – as already described – immediately above the three-member medial molding. The second row of corbels is included in the upper three or four-member moldings, resting on the lowest member. There are even corbelling stones at building corners with a 45° angle. The stones of the lower row of corbels usually have a higher, stronger profile than the upper ones. This indicates that the lower row had to hold sculptures with a great weight and the upper had just to hold the sculptures in position.

We might imagine the rich sculpture décor at the façade of Ek Balam in the Mexican State of Yucatán. Here there are mainly two rows of corbels holding three dimensional sculptures. There are even several standing angels between the lower and the upper corbels. The upper corbels only had to prevent the sculptures from falling during storms.

In 1999 the fantastically well preserved monster mouth entrance of Ek Balam was discovered. It was great luck that this entrance was completely covered and protected by a later building phase. Otherwise all the sculptures would have been exposed to the weather for nearly 1300 years and only naked corbelling stones as in the façades of the Palace of Santa Rosa Xtampak would have survived. The façades of this Palace were possibly as richly decorated as those of Structure 1 at Ek Balam.

### Upper Moldings

The upper molding is a three-member molding with a projecting, sloping lower member, a recessing medium member and a small projecting upper member with a vertical face. In most cases a fourth additional coping member follows above.

A photograph by Teobert Maler (Maler 1989:Fig. 171; see Fig. 49, page 45) shows the western façade of the Palace and the two large stone elements of a fourth member of the upper molding on the roof of Room 42 on the third floor. Therefore it is possible to reconstruct a four-member upper molding here. Certainly Rooms 40, 41, and also 43 and 44 on the third floor also had such a four-member molding. The fourth member of the upper molding was also reconstructed for the monster mouth passageway on this floor by inductive solution.

The four free-standing temples (38, 39, 45, 46) on the second floor quite certainly also had such a fourth member which was reconstructed by inductive solution at their upper moldings.



Fig. 119

No one knows what this painting on a molding cornerstone represents.

Photograph: R. Stamps 1969

For the upper moldings of Rooms 34, 35, 36, and 37 a hypothetical fourth coping member was reconstructed in the documentation, as there is a similar height distance to the floor level of the third floor.

There is also a similar height distance between the three-member upper molding of Rooms 13, 16, 19, 20, 21, 23, 25, and 26 and the floor level of the second floor. This is the reason for the hypothetically added fourth member above the upper three-member moldings. At Room 14 a step was added hypothetically for the same reason. A fourth member of the molding could also have been possible instead of the step. The solution above Room 14 and 26 was quite certainly similar. Unfortunately we have no indication which one was used. A corbelling solution is not a problem on a roof; such a corbelling solution could overturn at a terrace if you step on the edge.

In Rooms 5 and 7 a fourth member was added for the same

reason. On the roofs of Rooms 1 and 9 a recessing step was added hypothetically in relation to the step at the lower end of the roof. This also fits better than continuing the roof up to the second floor level.

### Roof Combs on the Palace

#### ◦ Form

Richard Stamps (1970:39a; Fig. 4) does not show a roof comb in his "ascetic" perspective of the Palace. The perspective of Alejandro Villalobos (Andrews et al. 1987:73) does not show a roof comb either. Paul Gendrop added roof combs on the two eastern pyramids and on top of the three central third floor structures 41, 42, and 43 in his perspective (Gendrop 1983:75, Fig. 46a).

Nicholas M. Hellmuth wrote that he could not find any indication for a roof comb on top of the third story roofs (Hellmuth 1989:68). They were just flat. Therefore he is sure there were never any roof combs on top of these, the highest structures of the Palace.

He suspects that roof combs might once have existed on the two eastern towers (Hellmuth 1989:69). The western towers are also quite similar to Río Bec temple pyramids. Therefore these two towers, which were not known when Hellmuth wrote his publication in 1989, could once have had roof combs, too, as they are typical of Río Bec architecture. Unfortunately no indication of these suspected combs has survived and the rear walls of all four towers are not broader than the other three walls of each of them. A broader wall would have been a good indication for a roof comb above.

The very thick western walls of Rooms 40, 42 and 44 are a strong indication for at least three planned roof combs on top of these three third floor structures.

The walls of the three levels of the Palace do not always stand perfectly on top of one another (refer to Section Q-35 and Q-65). But the massive construction was and still is strong enough to support this nearly 1300 year-old structure.

The author is sure that originally roof combs had been planned for the Palace along its western third floor walls. But when the Palace had serious static problems, especially along the western façade (refer to next chapter), they gave up this plan.

#### ◦ Construction

Roof combs usually look heavier than they are. In many cases they stand on the rear wall of the building and are decorated with huge masks. Inside they are nearly always hollow. Some-

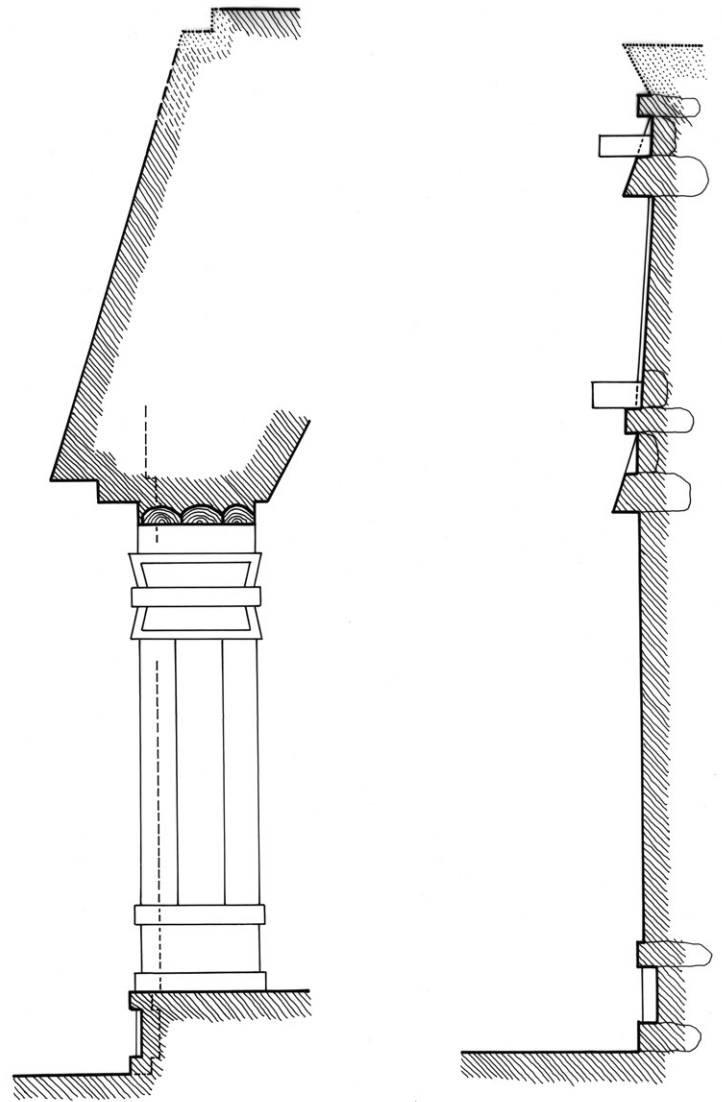

**Fig. 120**  
Profile of the southern façade of Room 1 on the first floor facing west. Such a profile of a roof is quite rare in Maya architecture. It is a little similar to some structures at Naachtun, for example Structure V in Group C (Ruppert and Denison 1943:Fig. 61). The upper step of the roof was added hypothetically in relation to the lower stepped end of the profile.

**Fig. 121**  
Profile of the western façade at Room 23 on the first floor facing north. This is a typical profile also showing two of the corbels for façade sculptures in the roof zone. The lower corbel consists of a thicker stone. The three-member base molding contains a long row of colonnettes which are 29 cm high and 30 cm wide.

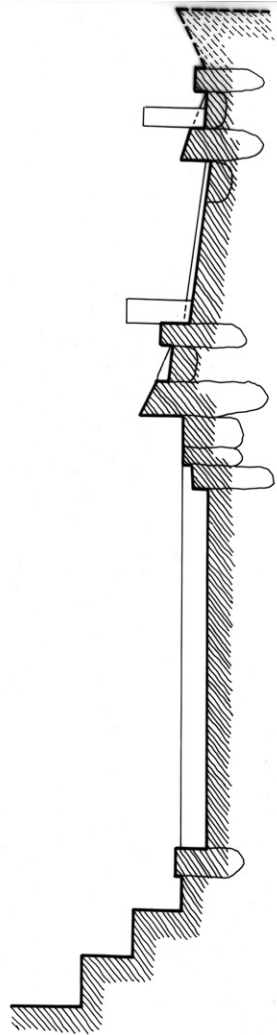
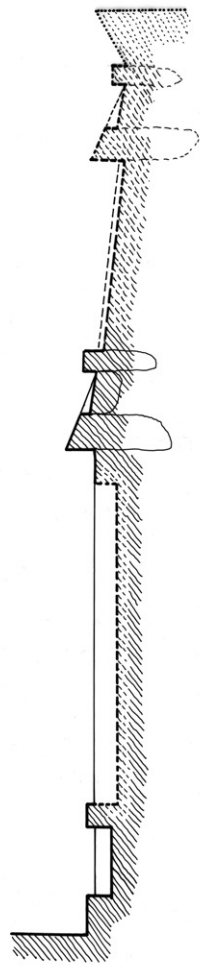
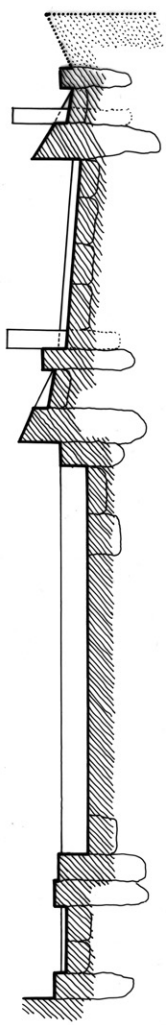

Fig. 122

Profile of the northern façade of Room 34 on the second floor facing east. It cuts through a flat niche representing a pseudo entrance into a building with a higher floor level than the floor in Room 34. The small base above the three-member base molding of Room 34 runs into the lower member of the three-member molding of the pillar at the northwestern corner of the structure.

The same design can be found on the southern façade of Room 37. It seems that the planners of the Palace were playing with façade levels here. We find two different levels in the middle member of the three-member base molding below both rooms on both sides of the axis of symmetry

Fig. 123

Profile of the southern façade of Room 38 on the second floor, the temple of the south-eastern temple pyramid of the Palace. The three-member base molding includes a row of quite large colonnettes in its center. Above there is a pseudo entrance which is the same height as the entrance on the northern side. The three-member medial molding is known from the eastern side. The upper four-member molding had to be completed in relation to the western façades of the Palace.

Fig. 124

Profile of the eastern façade of Room 42 on the third floor, the most central and isolated room in the Palace. The section shows the three stairs of the small atrium behind and west of the monster mouth pseudo entrance. The stairs run along three sides of the atrium and might have functioned as seats for conferences with the most important person of the Palace. The flat niches on both sides of the main entrance represent closed side entrances next to the central entrance of Room 42. The three-member medial molding and three of the four-member upper molding including the two rows of corbels for carrying façade sculptures are still in situ. Only the uppermost additional coping member of the upper molding had to be added with reference to the photograph by Teobert Maler (1997:Fig.171) showing this fourth member on the opposite, western façade of the third floor.

Drawings: Hasso Hohmann, 2014

times they are even open at the sides and in some cases the entire walls of the comb are open like a grid. Some show corbels with reduced statues in one or two lines. In most cases they show a huge mask in the center.

◦ Function

Roof combs make sacral and profane architecture look higher, better visible from far away, and more impressive. The Palace of Santa Rosa Xtampak stands almost on the peak of the hill together with the most important structures. The hill is approximately 50 m higher than the surrounding area. The Palace itself is a little more than 17 m high - measured from the Plaza level to the uppermost roof level. A roof comb would have extended this height to about 22 m, the peak of the Palace would be more than 70 m higher than the surrounding area and would have been visible from very far away. Even the western wall of the existing Palace is very visible. In 1891 when the guide of Teobert Maler did not find the right way to Santa Rosa Xtampak he climbed up a tree and could see the huge nearly white wall from far away. "X-tampák" means "wall in sight" in the language of the Maya who once lived near the ruins (Maler 1997:213).

◦ Static Problems of the Palace and its Roof Combs

There is strong proof that the western façade of the third floor of the Palace was too heavy for the floors below. Later the builders had to add a massive U-shaped support in Room 20 on the first floor, covering more than half of the room and had to divide the long central room on the second floor into the two Rooms 35 and 36 by introducing a massive block of 2.19 m x 2.56 m and the full room height in its center. Originally these two rooms were one long room.

The static problems must have been the reason for no roof combs being built on top of the third floor roofs of the Palace.

Tower 39 also seems to have been too heavy for the substructure at its western side. Therefore a supporting wall was erected at the eastern end of Room 9. Some scientists suspected a roof comb on this structure. There was possibly once a roof comb above the northern wall of Room 39 and a second one above the southern wall of Room 38. The author doubts such roof combs, as in both cases one pseudo stairway would have run into the rear side of a small temple with a roof comb (Stairways O and H).

## Stairways

The four stretched four-step stairways, leading up to the huge platform system of the main part of the Palace in the North, the East, and the South, are functional.

All 15 other stairways of the Palace are too steep to be used to step up and down by persons without special training. They are some kind of three dimensional façades representing stairs. The ten very steep stairways up to the four small temples at the corners of the Palace and even the two less steep Stairways K and L on the western façade have core walls and therefore these stairs were all finished after the main body of the Palace was constructed. Until this time the core wall consisting of very rough stones formed the surface. The core walls are construction walls.

## Pseudo Stairways and Core Walls

Pseudo stairways are typical for Río Bec architecture. In some cases they are nearly vertical and show just a relief of a stairway – the steps go forward and back. In most cases pseudo stairways are just extremely steep and can therefore only have functioned as a background for ceremonies.

George F. Andrews recognized that there are often core walls behind pseudo stairways in the Río Bec region and also at the Palace of Santa Rosa Xtampak. A lot of such core walls were visible, especially at the Palace. Nicholas M. Hellmuth (1989:34) was using this information when he found core walls on all three open sides of the two eastern towers. Therefore he suggested that three pseudo stairways probably once existed covering the core walls on all three sides of the two towers and that they could have been two Río Bec style towers. The result of Zapata's excavations revealed that Hellmuth was right and both towers have remains of three pseudo stairways.

The core walls are built of very rough stones so that the mortar could join the body better to the pseudo stairs later. They are provisional walls and in all cases at the Palace they recess some centimeters into the façade as the flanking façades of the stairways should form a perfect edge.

## THE PALACE INSIDE

### Staircases

The two spiral staircases of the Palace are accessible from the western side. This kind of staircase is unique in Maya architecture. The concept of the northern and the southern staircase led to a mirror image form. They are the only access to the second and third floors and their entrances are quite well hidden. Obviously non-locals were not to know the way up.

Both staircases are very narrow. This might also have been for safety reasons. Possibly the inhabitants introduced a one way system so that one staircase was used for the way up and one for the way down.

### Benches

#### ◦ Form

Several rooms of the Palace on the first floor had benches and some still do. Unfortunately the earliest scientific visitor, Frederic Catherwood, did not give any information about benches in his ground plan of the first floor (Stephens 1943). Teobert Maler was the first to document six benches in Rooms 2, 6, 10, 11, 12, and 14 in 1891. Harry Pollock describes only one bench with two colonnettes together with a sketch drawing (Pollock 1970:52, Fig. 66). It must be the bench in Room 6, as there is only one bench with two such rounded supports in the Palace. The ground plan of Brainerd, Ruppert, and Roys of the first floor in this publication does not provide any information about benches.

Richard B. Stamps again drew six benches in the same Rooms 2, 6, 10, 11, 12, and 14 in his ground plan and he published the exact measurements in his text. The benches in Rooms 10, 11, and 12 are also represented to scale in his cross section (Stamps 1970:Fig. 13). Stamps writes as early as in 1970 that all the benches had been more or less destroyed and he had to take his "measurements from the outlines along the walls". George F. Andrews documented benches in Rooms 2, 6, 10, 11, 12, and 14 and suspected more in Rooms 3, 8, and 26. Erwin Heine mentions only the two benches in Rooms 2 and 6. In 2014 Antonio Benavides Castillo again checked the benches in the Palace for an article on benches and documented benches in Rooms 2, 6, and 9. As nearly always, Room 14 was not accessible even for Benavides. Therefore he could not take measurements of the bench in this room. He did not find evidence for benches in rooms 10, 11, and 26. He also found secondary plaster lines along the walls marking form and di-

mensions of lost benches in Rooms 3 and 12. Room 3 was new information (personal communication with Benavides in January 2014)!

The author measured benches in Rooms 2 and 6. He used the information of Andrews for Room 14, which was always closed, and used the documentation of Stamps concerning Rooms 10, 11, and 12 (Stamps 1970:52, 53). Recently Renée Lorelei Zapata Peraza excavated another badly destroyed bench at the western end of Room 9 in the North of the Palace, which was measured by the author from two photos to complete this documentation.

Most of these benches were removed and destroyed by looters, as they expected treasures in caches within the body of these benches. No-one knows what the looters found in the benches of the Palace.

The bench in Room 2 was a simple sleeping bench. The room has cord holders and could be closed from inside, another strong indication for a private living purpose. In front of the bench and above at the vault spring is a lower vault beam, which might have held a curtain to cover a person sleeping or sitting on the bench.

Room 3 shows only a secondary plaster line along the wall, marking the form and dimension of the bench. As there is no rubble of a bench like in other rooms there might have been a wooden sub-construction which completely disappeared. It might possibly have been destroyed by termites. The other possibility is the destruction by looters who took all the material out of the Palace. The Maya of the Classic Period could also have changed the function of Room 3 and already removed the entire bench in ancient times. This bench was also originally used for sleeping purposes.

In Room 6 there is a sleeping bench with two rectangular and two rounded supports dividing three niches within the body of the bench. It has a simple corbelling cornice along the front of the platform. This room also has cord holders and could be closed from inside.

George F. Andrews suspected a bench in Room 8. All the other scientists did not see any substantial indication for a bench in this room. But a bench would make sense, as the person in this living unit must have used a bench to sleep. The entire back room might once have been used as a huge sleeping area.

Presently there is no indication for a bench in Room 10. But Richard B. Stamps also measured the outlines of a bench in this room. It had a small simple cornice. Stamps writes about the rubble of the bench, "The back dirt from a treasure hunter's pot hole in this room (under a bench) revealed many human bone fragments and several pieces of broken pottery" (Stamps 1970:52, 53).

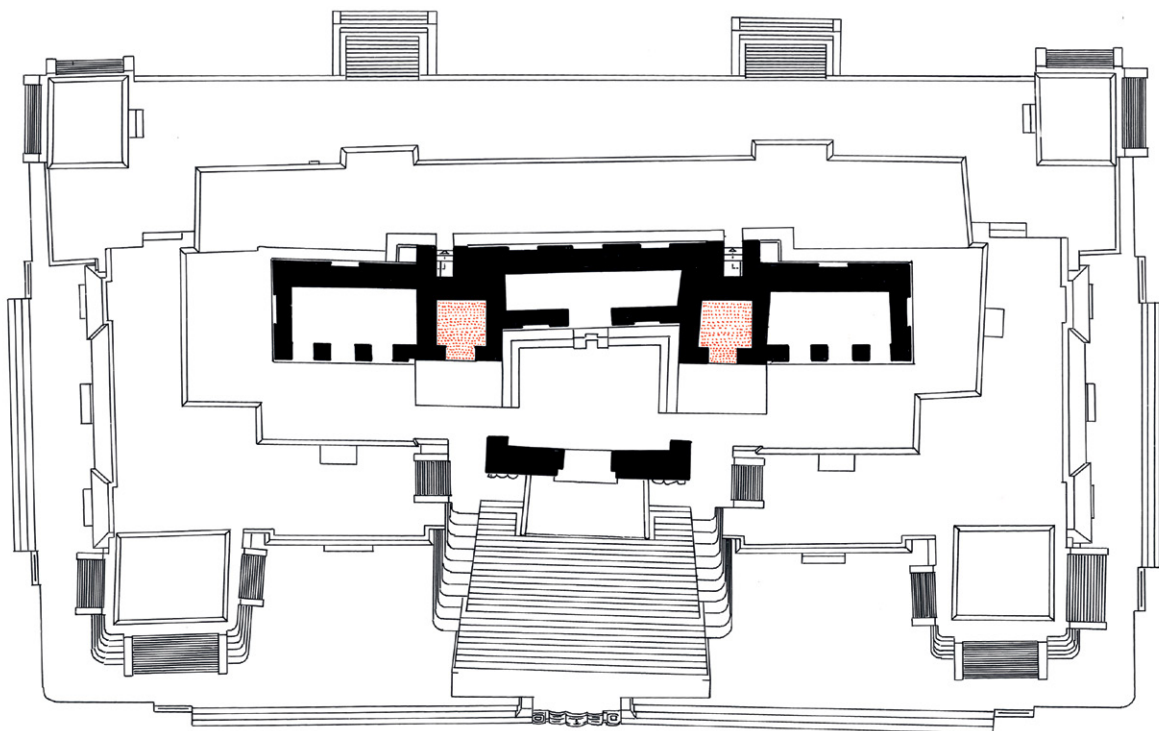
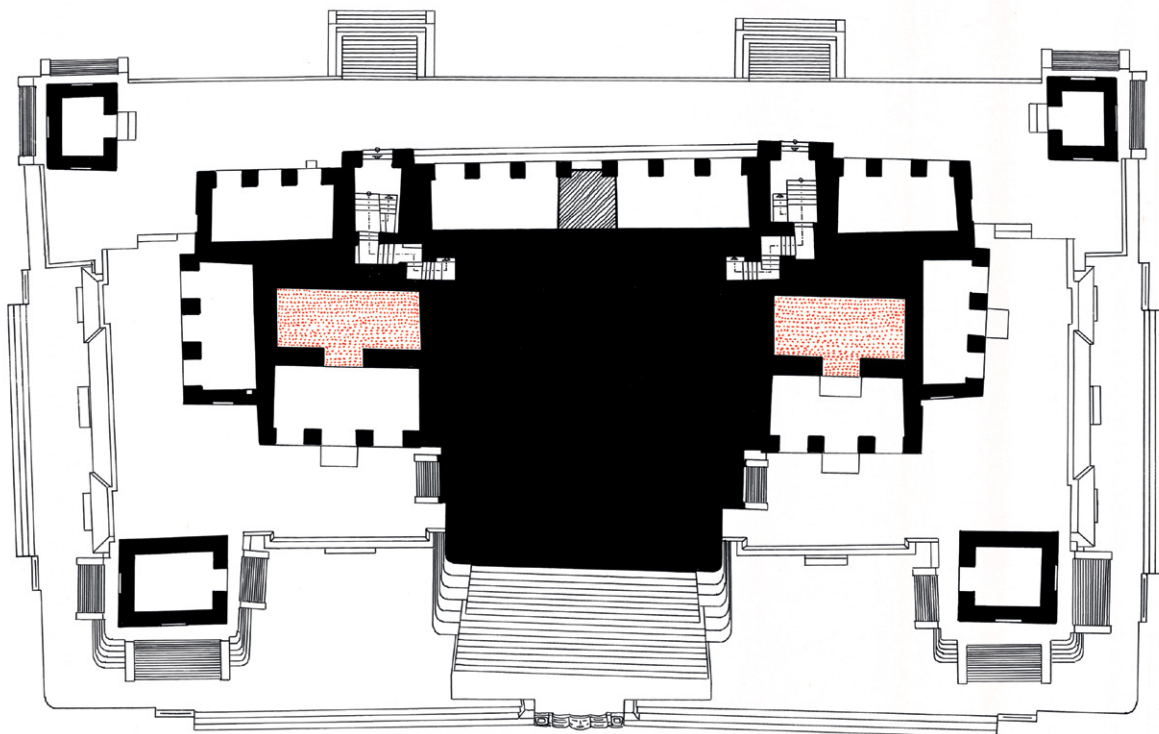
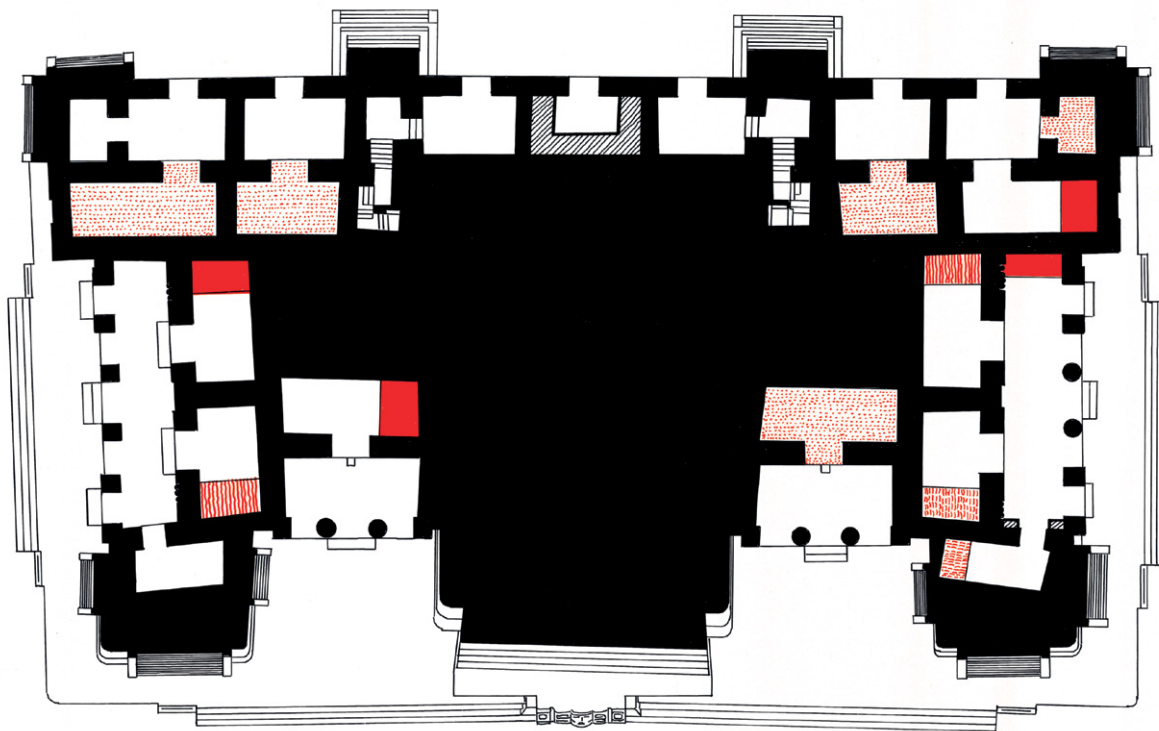

Fig. 125  
Benches

- Existing benches
- ▨ Indications for benches recorded by Antonio Benavides Castillo
- ▩ Indications for benches recorded by Richard B. Stamps
- ▧ Complete room might have been used as a bench

0M 5 10 15

The same is true for the benches in Room 11 and Room 12. Room 14 has a bench with a flat broad niche under the cornice. There might have once been a central support under the cornice holding the platform in the centre.

Andrews suspected a further bench at the southern end of Room 26 as a counterpart of the bench in Room 14. But none of the scientists saw any substantial indication for a bench. Nevertheless a bench would make sense, as the persons in this three-room living unit needed a place to sleep. The author is quite sure that there must have been a bench or something similar. There might once have been a wooden bench or the entire large raised back room was used as one large bench.

Summarizing we can state that there were at least 8 benches in rooms of the first floor of the Palace.

#### ◦ Construction

For the Palace of Santa Rosa Xtampak we know that all the benches which were found were or still are in rooms on the ground floor. We also know that all the benches were constructed in the different rooms after the room walls had already been plastered over. It seems that the Palace had no benches in the first building phase and all persons slept on the floors of raised back rooms or on wooden benches. Now we find massive benches on the ground floor in Rooms 2, 6, 9, and 14. In these and also in all other cases it has already been proved that they were built later.

In 1969/70 Richard Stamps found good visible indications for benches in Rooms 10, 11, and 12, too. Fortunately Stamps measured them. They were between 65 and 75 cm high. There are clear indications for at least one more bench in Room 3 on the ground floor. In 2014 Antonio Benavides Castillo found stucco marks on the walls of this room marking the sides of a bench in the East of this room. Some more stucco marks which were measured by Benavides in Room 12 fit the measurements of Richard Stamps.

In the rooms of the upper floors of the Palace there are no more benches or indications for them. Benches might have been too heavy for the upper floors of a multistory complex like this. The inhabitants might have used wooden benches on these floors which can still be found in use in recent Maya huts.

Most benches had or have a very simple design. They are rectangular massive blocks with a cornice facing the room. The front of such a bench shows rectangular masonry which was originally plastered over. On the bench was a thick layer of perfectly flattened stucco material. The body of the bench was filled with a mixture of rubble and mortar. In several cases these platforms contain or contained small caches with much decora-

ted objects like decorated ceramic vessels and sometimes bones of persons who had passed away.

#### ◦ Functions

Archaeologists often call these benches "sleeping benches". This names the main function of most of the benches. But not all of them were exclusively used for sleeping purposes, as we have proof at Becan in Campeche for example of a patolli, an engraving of a common game on the central bench in the most central Room R4-6 in the Palace STR.IV (Hohmann 1998:79, Fig. 130). If benches are positioned in the main axis of symmetry of their rooms, if they are ornamented, and if they are visible from outside they might also have functioned as representational sitting accommodation. In many cases benches in combination with lower vault beams provide quite clear indications for the former function of a room in Maya architecture, as in most cases they were used as sleeping places, covered by a curtain hanging from a beam positioned in front of the bench.

Often they are not visible from outside. In many of these cases the ancient Maya positioned a lower vault beam in front of the bench so that a curtain could cover a sleeping or sitting person on the bench as well. At the Palace of Santa Rosa Xtampak we find lower vault beams, which could be used for such curtains in front of all benches except for Room 11. In this room the lower beam hole above the southern side of the bench is not clear and the vault had to be partly reconstructed above the passageway. Here therefore no beam hole could survive. An asymmetrical vault beam quite certainly existed here, too.

If benches are visible through the door from the outside they might also have been used as benches with a representational function - to meet colleagues from other Maya cities or to meet friends and sit around. This was only the case in Room 9 in this Palace. But even here a lower vault beam might have been used to close the western end of this room in the last building phase and in this case the bench also functioned as a sleeping place.

It seems that in cases of two-room or more-room units an entire back room might have been used as a huge bench or sleeping area. This could have been the case on the first floor in Rooms 8, 15, 17, 24, and 26. On the second floor this could have been the case for Rooms 30 and 32 and on the third floor for the small Rooms 41 and 43. All these rooms have a raised floor level and those on the second floor have a second room in front. If we make an exception for Rooms 41 and 43 on the third floor, which are quite well protected, as bench rooms, we find all together 8 rooms with benches and 9 rooms which might have functioned as a whole as a huge sleeping area, as a bench room.

## Passageways

### ◦ Form

Passageways usually lead from one room to another one. Usually there is a step from the lower front to the upper back room in the Palace. There is no step between Room 25 and Room 27, alone. In most cases the step is part of the base molding of the back room. Most of the lintels of passageways in the Palace have survived for more than 1200 years with rain periods every year. None of them are decorated.

At the beginning of the inner face of the doorway we usually have to step up from the lower level of the entrance room to the higher level of the back room. The face of this step is the three-member base molding of the back room.

### ◦ Construction and Function

In nearly all cases the lintels are constructed of extremely hard and amazingly thin wooden beams. It seems that the wood of the lintels was open down to the inner face of the wall opening and consisted of "sapodilla" wood (Stamps 1970:52). Hellmuth writes about "zapote" wood in Xtampak (Hellmuth 1989:32). The thickness of the beams varies from 4 to 10 cm and is 6.28 cm on average (Stamps 1970:52).

In a few cases the span of the doorways was short enough to use two small corbels from the sides and a stone lintel. This construction was used in the two inner staircases.

The decision for wood or stone lintels is also a decision for the safety and sustainability of the lintel. Wood can be attacked by termites and therefore break. Stone lintels in the structure will not erode, rot, and cannot be attacked by termites or fire. The problem with stone lintels is that they are not flexible and will break if the pressure stress from irregular settlement caused by bad building of the foundation is too high or if an earthquake affects them too much.

## Over-Doorway Designs

### ◦ Form

Passageways are wall openings between two rooms. Usually they are not specially decorated. However, in some rare cases as for example in the Palace of Dzibiltun near Hopelchén a recessing design which is a little similar to the one in Santa Rosa (Pollock 1970: 24, Fig. 26 a, b) or in the main Structure I of Culucbalom 10 km in the Northwest of Xpuhil, a vault design on both sides of the doorway (Ruppert and Denson 1943:Fig. 115b), or in the Palace of Tzikin Tzakan, Peten, Guatemala a specially decorated over-doorway vault design, a huge stepped recessing field in the vault, forms the passageway from one room to the other. Unfortunately the room of the Palace in Tzikin Tzakan had already collapsed before 2004. Nicholas M. Hellmuth had photographed the design several years before (Hellmuth 1989a, Vol. I, 47ff, Fig. 5 and 6).

In the Palace at Santa Rosa Xtampak we find two over-doorway designs in Room 1, one in Room 5 and one in Room 7, and another two in Room 9 (please refer to the perspective of Room 1). These have a different design compared with the above-mentioned ones. The design here opens the inner vault side to the passageway and guides into the next room.

### ◦ Construction

The corbels with the less steep angles of the vault for the over-door design formed the general supporting architecture. These stones were carefully plastered over. The fine plaster design is much finer than the form of the vault stones. Unfortunately only rare portions of the plaster design have survived.

### ◦ Function

It seems that these designs had no other function than to mark the passageway for a visitor standing in the entrance hall guiding him into one of the next rooms. The wall openings are nearly 250 cm high. Even if the Maya leaders might have sometimes been a little taller than the average height of the population of about 150 cm, there was in any case sufficient space and no need to create this design for a functional reason.



## Niches

### ◦ Form

There is only one wall niche in the Palace in Room 28. This niche is not complete; its back wall is missing and the stone lintel above consists of two corbels, which is quite uncommon. The other niches are those under benches. We find this type of niche in Rooms 6, 9, and 14. More niches might have existed in other benches but these are not described.

### ◦ Construction

The niche in the eastern wall of Room 28 has two corbels, one from each side instead of a one stone lintel.

### ◦ Function

There is no indication for a function of the niche in the quite open Room 28. All the bench niches must have been used in combination with the sleeping function of the bench. Pots might have been positioned to provide drinking water at night or pots for other purposes? Clothes and other textiles were certainly hung from lower vault beams. Mats or blankets were also deposited in the roof zone.

## Flat Niches with Reused Reliefs

### ◦ Form

The two reliefs and the two carved half columns in Room 1 of the Palace as well as the one large relief in Room 9 and the long decorated upper member of the three-member base molding under the northern walls of Rooms 11 and 12, all originate from one or more structures destroyed earlier. In all cases it is certain that the plane or rounded relief elements are not mixed together accidentally but intentionally. The mixture should show that the reliefs were not made for this Palace and that they remind of an important earlier structure and its inhabitants.

The reused central relief in the northern entrance hall of the Palace once consisted of several more rectangular relief elements which had to be fitted together in the right way once to form a huge relief of unknown size for an earlier structure. Teobert Maler already tried to put them together in the correct way (Maler 1997:215). Hanns J. Prem also realized that the upper portion of five relief elements of the relief in Room 9 fit together and he tried to find out how the other relief elements could be fitted together in the right way, following Maler. The relief in the Palace, as it was photographed by Teobert Maler and as it was published in 1902 was the basis for Prem's unpublished study. The result of Prem's puzzle and a drawing on how to change the relief fields show that the original relief was larger.

The upper member of the three-member base molding with the reused relief elements in Room 9 still exists. The central relief in this room consisting of several relief elements, which were fitted together incorrectly, is completely gone.

The smaller upper relief in Room 1 is still in situ. Four blocks of the large relief below are still in the recessing field. But they are not in their original position. If someone numbers them 1 to 4 from left to right block 1 should be exchanged with block 3.

The western sculpted half column of those in Room 1 has been completely looted. It was stolen between 1960 and 1986. A short article by Francis Murphy (1961:7) shows the western half column up to the uppermost colonnette in place; a photo by Karl Herbert Mayer taken in 1986 shows the destruction of the looters. This proves the time span of the looting.

A photo by Erwin Heine, taken in 1992, shows only the lowest section of the eastern sculpted half column in situ. It represents a foot with a sandal and the lower part of the dress of a person – all upside down. This element was even still in situ in 2004.



Fig. 126  
The western sculpted half column of Room 1 consisting of different sections (Pollock 1970:55, Fig. 73a). It has been completely looted. One section was later confiscated and is now in the Museo Nacional de Antropología in Mexico DF. With permission of the Peabody Museum, Harvard University by Karl Herbert Mayer; Photographer unknown

The following section above this half column was stolen and presently is part of the Theodore P. van Dyck Collection in Tilburg in the Netherlands. Its measurements are given as 48.5 cm high and 21 cm wide. All the rest is also looted but no one knows where the other pieces and those of the western half column are.



Fig. 127  
The situation after the looting of the western sculpted half column of Room 1 was a serious static problem for the Palace.  
Photograph: K. H. Mayer 1986

◦ Construction

It seems that the Maya first produced a much deeper flat niche with some kind of a rough core wall in the back and later put the relief stones into this niche fixing them with lime mortar. In all cases when the format of the relief stones did not fit the format of the wall opening, the builders used other smaller pieces to fill the

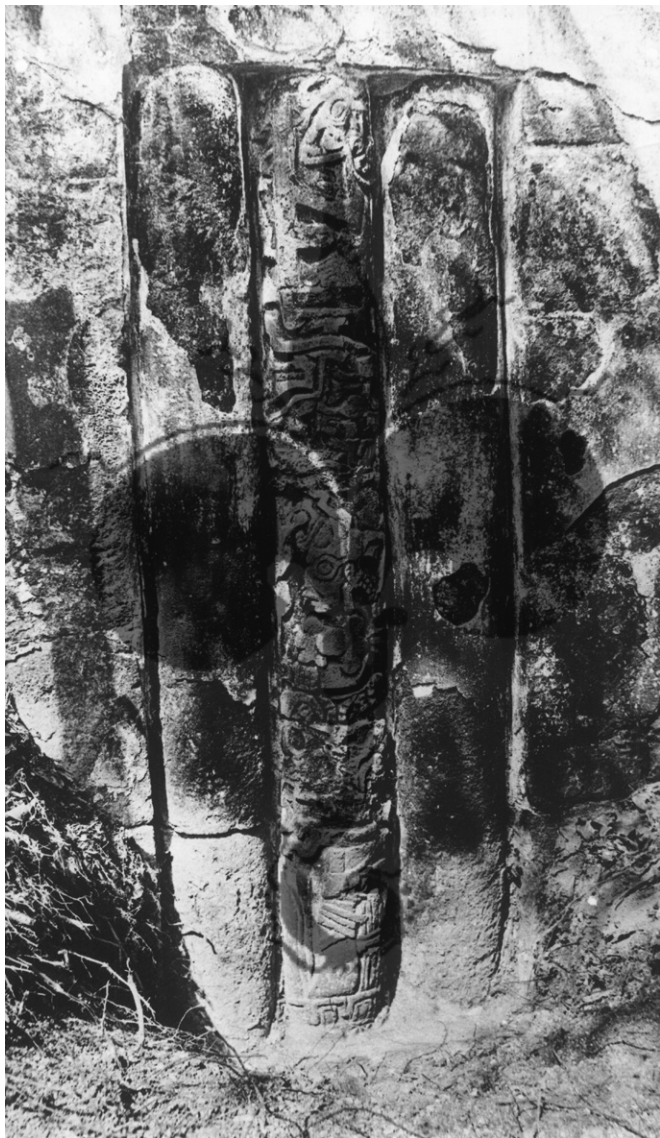

Fig. 128

The eastern sculpted half column in Room 1 consisted of different half cylindrical sculptured stone elements, which do not belong to each other. In 2004 the lowest stone element was still in situ. It represents the leg, foot, and part of the dress of a person and is positioned upside down. In 1985 the next upper element was in Holland. No one knows where the other two looted elements are.

With permission of the Peabody Museum, Harvard University by Karl Herbert Mayer. Photograph: Teobert Maler 1891

empty space. They did not change the original size of the relief fields. They just put some stones and mortar into the slits as are visible on both relief panels in the photos by Teobert Maler.

But the plane and the sculpted half columns must have been used as veneer stones. This is the reason why some of the looters had problems getting the western column out of the wall. The result was the destruction of the surrounding wall causing static



Fig. 129, 130

At the beginning of 1985 this section of the eastern half column belonged to the Theodor P. van Dyck Collection in Tilburg, Holland. Its measurements are: height 48.5 cm, width 21cm.

Photographs: courtesy of T.P. van Dyck 1985

problems which had to be solved by archaeologists.

◦ Function

We also find such reused elements in structures of other Maya sites as in Chunhuaymil (Hohmann 2001: 136-138). It seems that this is a specific way of the Maya to remember the past.



Fig. 131

The two reliefs in the centre of the northern wall of Room 1 in the South of the Palace in 1891 (Maler 1902). Francis S. Murphy also took two photographs of the two reliefs, one in 1960 and one in 1972 (Murphy 1988:26, Plate 28 and 28A). The first photograph shows that the upper relief elements of the lower relief field are still there. The later photograph shows that the upper elements of the lower relief field are missing. This means that they were looted the twelve years between 1960 and 1972. With permission of the Peabody Museum, Harvard University by Karl Herbert Mayer. Photograph: T. Maler before 1891



Fig. 132

In 2004 five of the relief elements of the lower relief were still in Room 1. At this time the upper relief was still complete. Photograph: H. Hohmann 2004



Fig. 133

In 2008 four of the relief elements of the lower relief were still in place in Room 1. At this time the upper relief was still complete.

Photograph: K. H. Mayer 2008

Fig. 134

The upper relief with a geometrical motive in the centre of Room 1 is still in situ.

Photograph: K. H. Mayer 1993





Fig. 135  
The relief in the southern wall of Room 9 in the North of the Palace of Santa Rosa Xtampak (Maler 1902). This relief is also fitted together incorrectly. Only the upper five relief elements form a section which belongs together. Please also refer to the paragraph on: Flat Niches with Reused Reliefs and Other Objects.  
With permission of the Peabody Museum, Harvard University by Karl Herbert Mayer. Photograph: T. Maler 1891



Fig. 136  
Hanns J. Prem's and Teobert Maler's solution of the puzzle.

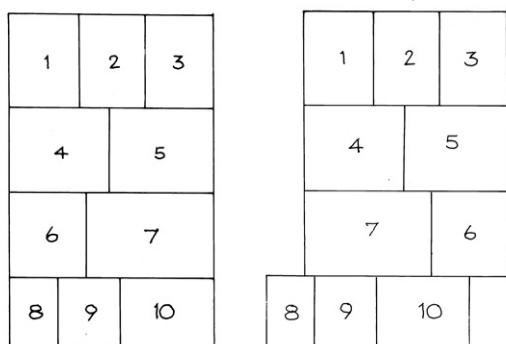

Fig. 137  
Drawing on how to change the fields of the relief in Room 9.  
Drawing: H. Hohmann 2004

#### Other Reused Relief Elements

In several rooms, mainly in the walls of the two staircases, we find several reused relief stones from an older structure. There is, for example, a part of a cornice with rhomboid elements and fringes that has also been reused for the cornice of the base molding in Room 9. A more simple relief just with fringes is not far away. Both spoils are visible in walls of the southern staircase. At least one section of a well cut relief representing a standing person, unfortunately without his head, in the format 42 cm x 52 cm (Maler 1997:214) has been lost. Stamps already reported that he could not find this reported relief in 1969 (Stamps 1970:45).

Fig. 138  
The reused cornice elements of the upper member of the three-member base molding in Room 9 under the southern wall.  
Photograph: H. Hohmann 2004



Fig. 139  
A spoil in the southern staircase. It looks like the row of spoils in Room 9 on the upper member of the three-member base molding.  
Photograph: H. Hohmann 1999



Fig. 140  
A spoil with fringes in the southern staircase.  
Photograph: H. Hohmann 1999



## Cord Holders

### ◦ Form and Construction

There were different types of cord holders in use at the Palace.

1. One type consists of a small rectangular niche with flat cylindrical recesses in its floor and ceiling, holding a stone cylinder as in Room 16. The user could tie the cord around the single "colonnette". The cylinder and the surrounding elements could only be fitted together when the wall was built.

2. The second type consists of a wall stone with a half-torus-shaped space, which opens with two small openings to the room as in Room 27. It also had to be built together with the wall.

3. The third type is a wall stone with a small corbel in the form of a handle as we find in Room 2.

4. The fourth type consists of a wall stone with just one quarter of a half-torus at its edge; it opens with two holes into the room similar to that in Room 10.

5. The fifth type shows two triangular openings with a connecting hole, which can be used to tie a cord through it. We find this type quite often in the Palace as in Room 15.

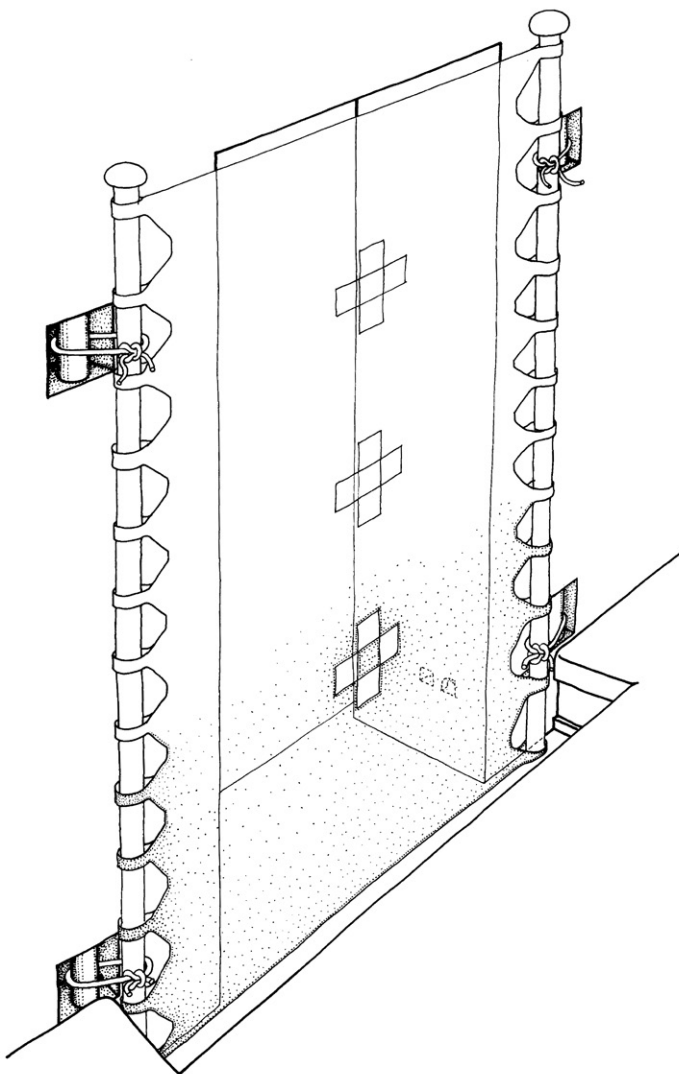

### ◦ Function

In all cases the above-described architectural elements held a cord.

Cord holders usually give a quite strong indication of the function of a room.

1. If they are inside a room on both sides of the wall opening near the vault spring and near the floor and there are altogether four cord holders in the same distance from the doorway, they were used to fix a closure. The closure had to be spanned over the wall opening and could only be fixed from inside the room. This means that the closure could only be closed or opened from inside and the room must have functioned as a room for a person or a family who did not want to be disturbed while the closure was closed.

2. If the cord holders are positioned around the wall opening on the outside, the closure could only be spanned over the doorway from outside. The function of such a room could have been a prison, a cage for animals, or a storage room which should be closed to children, animals etc.

3. Single cord holders in rooms might have been used to tie up a dog or another animal and can be seen as a further indication for a domestic purpose. The author could not find any reason for the use of one or the other type of cord holders as described above. The different types might have been created at different times. The use of so many different types in the Palace could also be the reuse of cord holders from older structures.

Fig. 141

Reconstructed closures with cord holders (Hohmann 1998:129, Fig. 205).

Recent closures at entrances of present day Maya huts with traditional accommodation consist of a strong woven fabric with vertical hard sticks on the inner faces of the entrance to the left and to the right which are bound to two or more wooden cord holders at each side.

Drawing: H. Hohmann



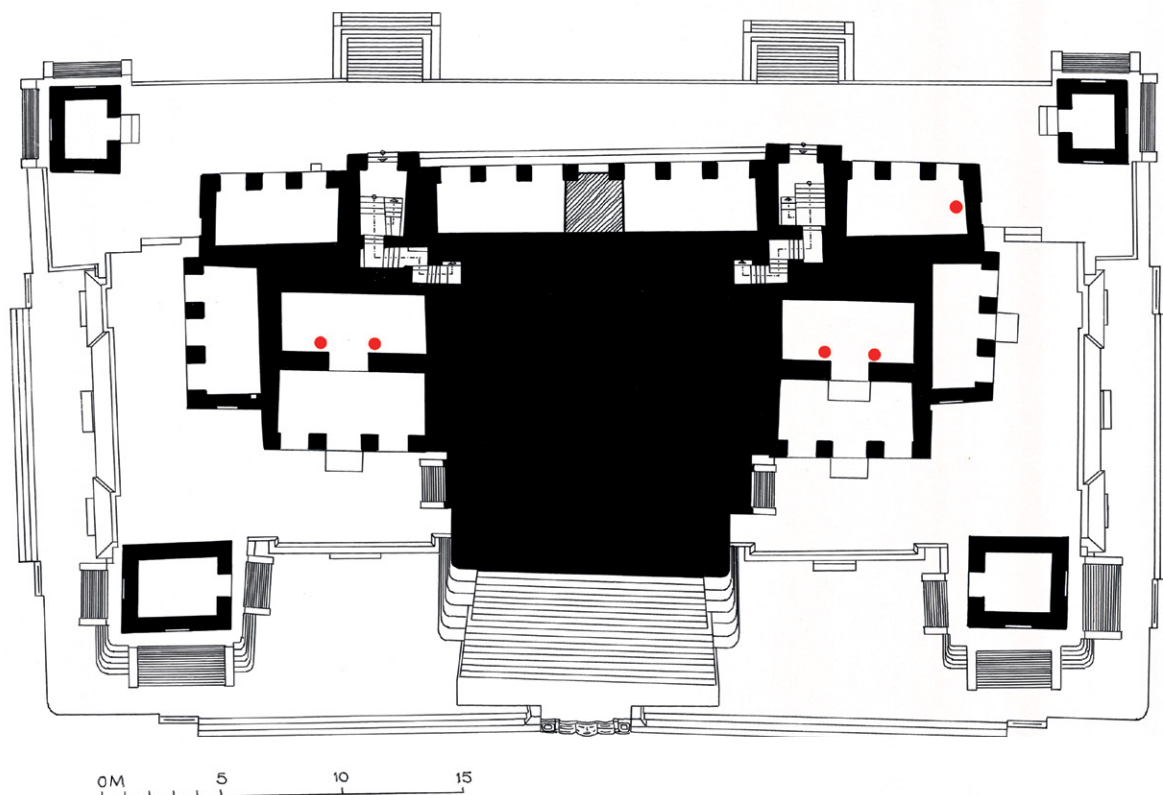
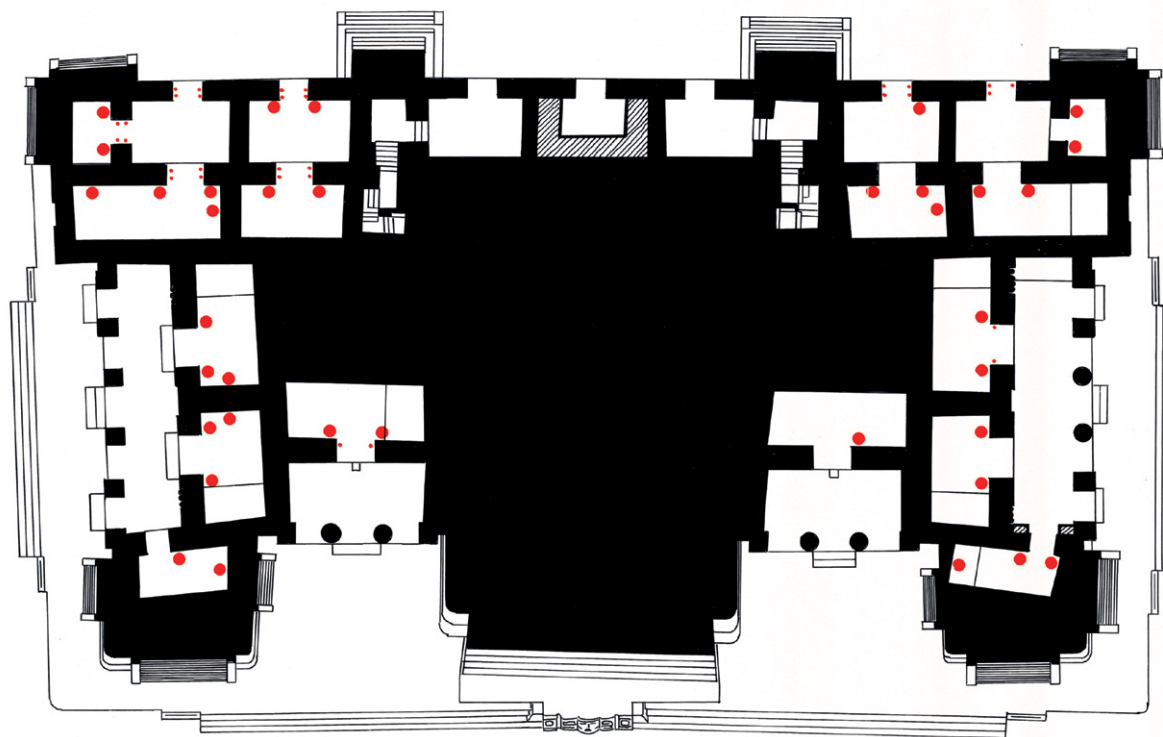
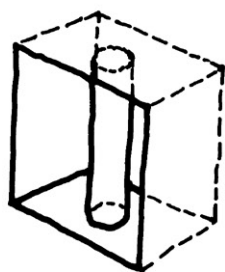

Fig. 142  
Indications for closures

- Cord holders
- Rod sockets

Fig. 143  
The five different types of cord holders used  
in the Palace.  
Drawing: H. Hohmann



1  
R 16/26

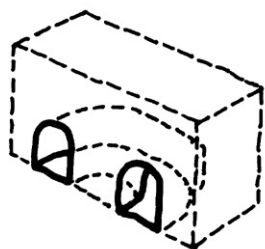

2  
R 27

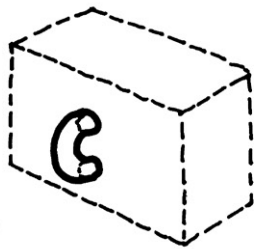

3  
R 2

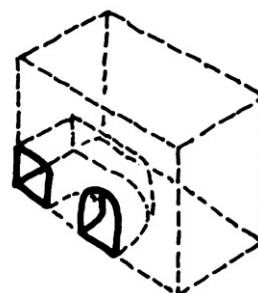

4  
R 10

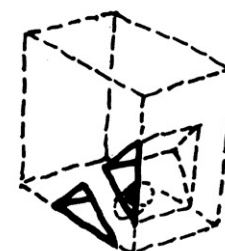

5  
R 15

## Rod Sockets

Very small flat circular recesses at the inner face of wall openings are called "rod sockets". We find them near door lintels and near the floor, always on both sides in opposite position on the inner face of doorways. Often there are pairs of them. Therefore there are usually four or eight rod sockets within one door opening.

These rod sockets have been used to hold flexible wooden rods or some kind of bamboo sticks, which have to be flexed to reduce their length to get them into the rod sockets on both sides of a doorway. Some of these sticks must have held a curtain. Others might have functioned to hold a real door closure to block the entrance or passageway (Hohmann 1998:130-132).

In cases of pairs of rod sockets, the outer one must have carried the more effective door closure and the inner one was used to carry a lighter wind permeable closure. It must have been a construction with a frame, which also needs the lower rod sockets. The author is quite sure that it was some kind of mosquito net protecting the entire opening. A curtain would only need an upper rod. As the rod sockets are very flat they are often just visible in the wall plaster of the doorway, but not in the skin of the dismantled stone. Therefore some of these rod sockets might have disappeared by losing the plaster. In this documentation only existing rod sockets have been documented. No distinction has been made between dismantled walls and flat paved walls within wall openings, where we can be sure that there were never any rod sockets.

Rod sockets can only be found at entrances and passageways of rooms on the first floor of the Palace. Remains of single rod sockets could be identified at Rooms 6, 12, 13, and 16. Remains of pairs of rod sockets were documented at the passageways of all rooms between Room 23 and Room 27.

Fig. 144

Rod sockets in the Palace and how to use rods (Hohmann 1998:Fig. 211) to fix them in place. The inner rods might have been used to hold a curtain (Hohmann 1998:Fig. 209).

Fig. 145

The outer rods might have been used to hold a solid closure, which could be used from both sides. A closure which was closed could only be opened from the same side.

Fig. 146

Hypothetically reconstructed closures at rod sockets.

Drawings: H. Hohmann

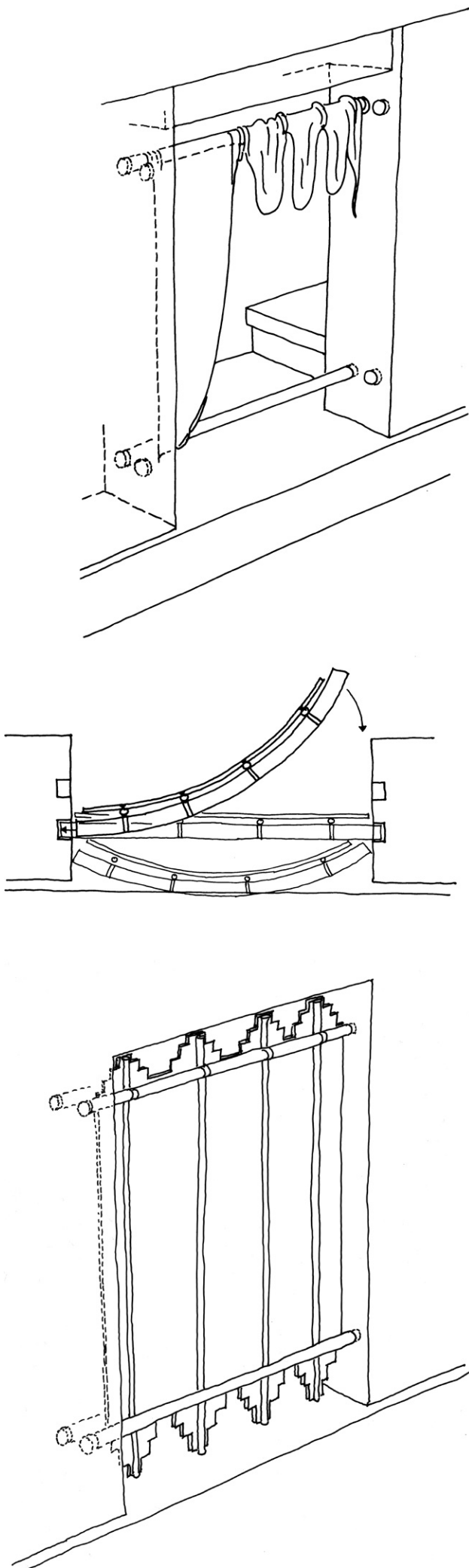

## Lintels

### ◦ Form

Nearly all doorways had or still have wooden lintels. Stone lintels were only in use in very narrow passageways. These stone lintels had corbels underneath at both ends in nearly all such cases.

In all other cases the still existing lintels in the Palace consist of very hard wood. They are always flattened on the undersurface and in some cases also at the sides. The upper side is naturally round. The general form of the underside is in most cases straight or conical. All the lintels together formed a rectangular wooden lintel field, surrounded by lime mortar. The underside of these lintels was once quite certainly whitened with a thin film of lime. No remains of this survived.

### ◦ Construction

A high percentage of lintels within the Palace above walls between two rooms have survived. They were better protected against rain water than lintels along the facades of the terraced Palace. Nearly all the lintels on the façades have collapsed within the last almost 1300 years. There was more wetness from the terraces above and rain water from the sides. Beside this a lot of trees grew on the terraces on the second and third floors, and on the roofs of the third floor. When these huge heavy trees fell down they usually caused a lot of destruction pulling architectural material out of the structure with their roots and by falling down on other parts of the construction.

Nicholas M. Hellmuth studied the intact lintels of the Palace. He found out that fresh cut zapote wood was formed into quite thin lintel beams, flattened on the underside (Hellmuth 1989c:32). The wood of these lintels later shrank while drying. Therefore there is presently a thin space between the original lintels and the surrounding lime mortar.

## Lintels Strengthened by Beams

### ◦ Form

Above some lintels above passageways between Rooms 1 and 3 as well as between Rooms 9 and 11 wooden beams or horizontal beam holes could be recognized after lintels broke and part of the vault profile was visible (Stamps 1970:51). The reinforcement consists of two round wooden beams with a diameter of 10 to 12 cm, positioned approximately 50 to 70 cm above and parallel to the lintels of these passageways. They

strengthen the vault zone above the lintels. On both sides the poles extended at least 50 cm beyond the length of the lintels (Hellmuth 1989:26). Hellmuth writes about these reinforcements that they were no more than a foot above the lintels, which does not fit with Stamps' information (see above).

After reconstructing all the collapsed lintels it is hard to prove what is correct. One photograph by Pollock shows both holes of the two strengthening beams in the vault between Rooms 1 and 3 (Pollock 1970:53, Fig. 67b). The author tried to measure the height between lintel and beam hole by using known measurements within the photo. This measurement cannot be very precise but results in a height of approximately 45 to 50 cm which would support the correctness of Stamps' measurement.

### ◦ Construction and Function

The wooden beams above lintels strengthen the construction and take weight from the lintels below. This could only be studied in the Palace in some rare cases such as in the passageways between Rooms 1 and 3 (Stamps 1970:48, Fig. 12 and Pollock 1970:53, Fig. 67b) and Rooms 9 and 11 (Stamps 1970:48, Fig. 12).

It seems that the strengthening beams were used above the lintels of wall openings of the middle walls between rooms on the first floor. These lintels had to carry a maximum load in the case of structural cracks and it was important for the stability of the entire Palace that they did not break. This is the reason why the author suspects that they were also used between Rooms 1 and 2, Rooms 5 and 6, Rooms 7 and 8, Rooms 9 and 12, Rooms 13 and 14, Rooms 16 and 17, Rooms 23 and 24, and Rooms 25 and 26. There might also have been such beams above the lintels of Rooms 29 and 30 as well as Rooms 31 and 32 on the second floor. In all these cases the static situation is similar.

## Vaults

### ◦ Form

All the ceilings of the 48 Rooms of the Palace look like typical corbelled stone vaults. The visible surface of vault stones shows horizontal and vertical joints. On the surface of the horizontal joints the Maya used small stones to strengthen them in cases of high pressure stress.

The vault spring usually starts with a first slide step which leads into the sloping vault. Only in some cases as in Rooms 1, 5, 7, and 9 did we find an additional band and a second slide step at the vault spring. Under the upper end of the vault underneath the row of capstones follows another flat step with a projecting

horizontal band. In the case of Room 12 we find two steps and two bands. The upper two bands run around all four sides of the room and the lower of the two bands is profiled.

In most cases the vault profiles show straight sloping sides on both sides of the vault. In some cases the wall on one side ends higher than on the other side as in Room 23. In most of these cases the angle between the wall and the vault is the same on both sides and the row of capstones is asymmetrically positioned. In Room 17 the vault spring of the eastern wall was pressed by the horizontal components of the pressure stress of the upper floors in a western direction; this caused the deformation of Room 17 and a quite asymmetrical profile of this room.

#### ◦ Construction

The real corbelled vault consists of horizontal layers of long vault stones, corbeling from the two long opposite walls of a room step by step up to the long axis of symmetry and to a point, where a capstone can bridge the rest of the distance between the two halves of the vault. Usually all corbels are held by other stones within the core of the vault construction preventing its collapse.

At the Palace of Santa Rosa Xtampak we find a mixture of rubble and mortar in the core of the vaults, which hardened to a huge vault block also holding the corbels of the vault in position like veneer stones and preventing their collapse. Single corbels in the vaults have conically reducing profiles on the rear side to be better bound into the mortar block. They form the skin of the massive stone, rubble, and mortar vault, which can also be called a "cast vault" (Hohmann 1979:36).

Therefore we have to state that the vaults of the Palace are not really corbelled vaults. In Copan we find plenty of real corbelled vaults with very long vault corbels as they did not have sufficient lime to produce enough burned lime and stucco material for cast vaults. Therefore most Maya vaults are some kind of cast vaults, looking like corbelled vaults but following a different static principle.

The mortar is usually softer than the stone. As far as pressure stress was concerned the joints between the veneer stones of the vaults needed to be as strong as the stones themselves. Therefore the Maya used small stones in the joints to strengthen the joints. With these small stones the joints can take up much more pressure stress.

#### ◦ Function

Corbelled vaults and cast vaults are more sustainable than beam

and mortar ceilings. In a climate with a long rain period every year the wooden beams would rot and the ceilings would collapse. This kind of roofing is only possible in the semiarid climate of northern Yucatán along and near the coast. But termites are also a great problem for beam and mortar ceilings.

#### Lower Vault Beams

Vault beams in Maya architecture are beams crossing rooms with a corbelled vault from one long side to the other. They are positioned immediately under or within the vaulted zone. Generally we find vault beams on two or three levels. The lower beams are positioned under, at or slightly above the vault spring. In cases of two offsets at the vault spring with an additional horizontal band they often penetrate this. The upper vault beams are very often under the upper offset or on a level directly under the capstones. In very high vaults we find a third series of beams half way up which quite certainly were also used to hang objects from.

The more interesting beams are the lower ones, as objects from them hung into the room, which was used. In some cases curtains hung from the lower beams dividing the room. Especially asymmetrically positioned lower beams are indications of the former use of the room – it seems curtains often hung from them in front of benches. In other cases they divided the room. Pairs of double beams might have been used for hammocks or other heavy objects. Rooms with only beams along the side walls were used intensively. These beams near gable walls might have held clothes at night or other objects of daily life in the day time, too. The upper beams are short and might have functioned to hold goods which were not needed every day. These objects did not hang into the room but in the vault space and did not disturb the space between the vertical walls. Therefore the upper beams are usually symmetrically spread over the length of the vault.

There was a long discussion about vault beams being necessary for static reasons or being for the daily use of persons. There is no doubt that they had practical rather than static functions (Hohmann 1979:33-36)! The Maya of the Classic Period knew that the beams of their stone vaults had no static function. Therefore they did not use them in passageways and usually did not spread them but positioned them where they needed them. In some cases they used corbelling stone hooks (Hohmann and Vogrin 1982:37, Fig. 13) or even stone feet within their vaults instead of vault beams (Hohmann 2013:37-44).

In many cases the Maya used a core wall between the inner face of a vault and the relating façade outside. In these cases the vault was separately constructed and the decorated façade

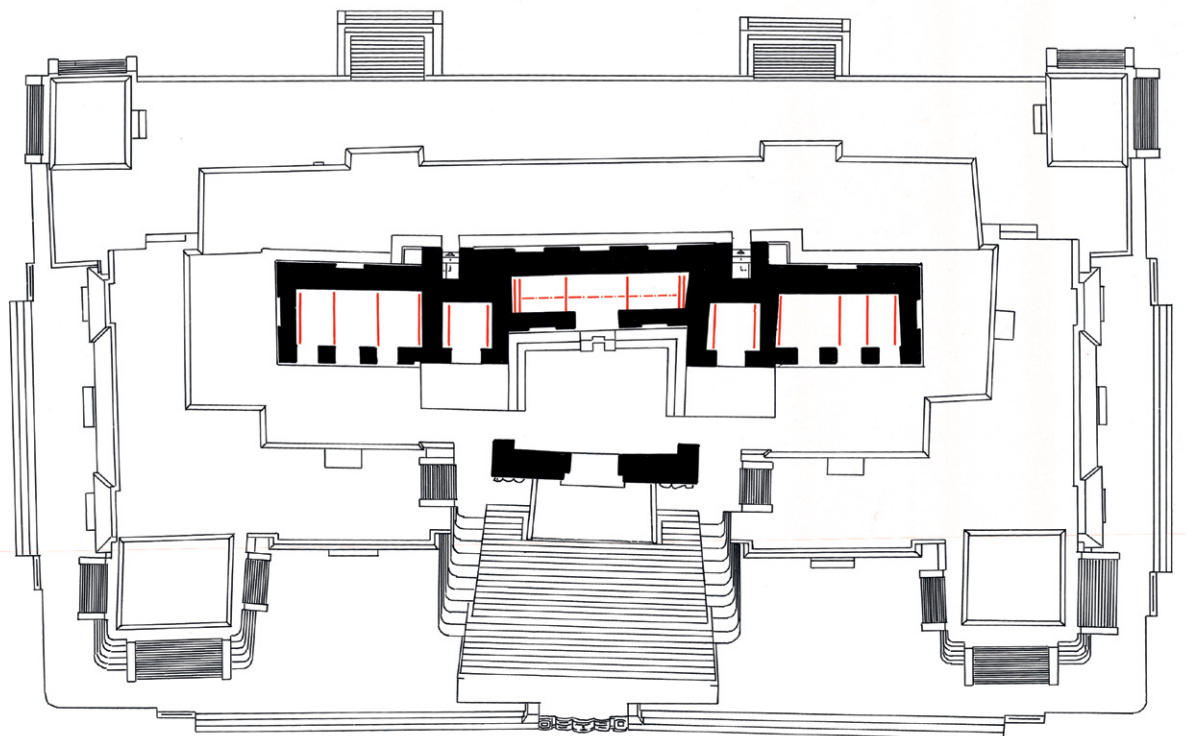
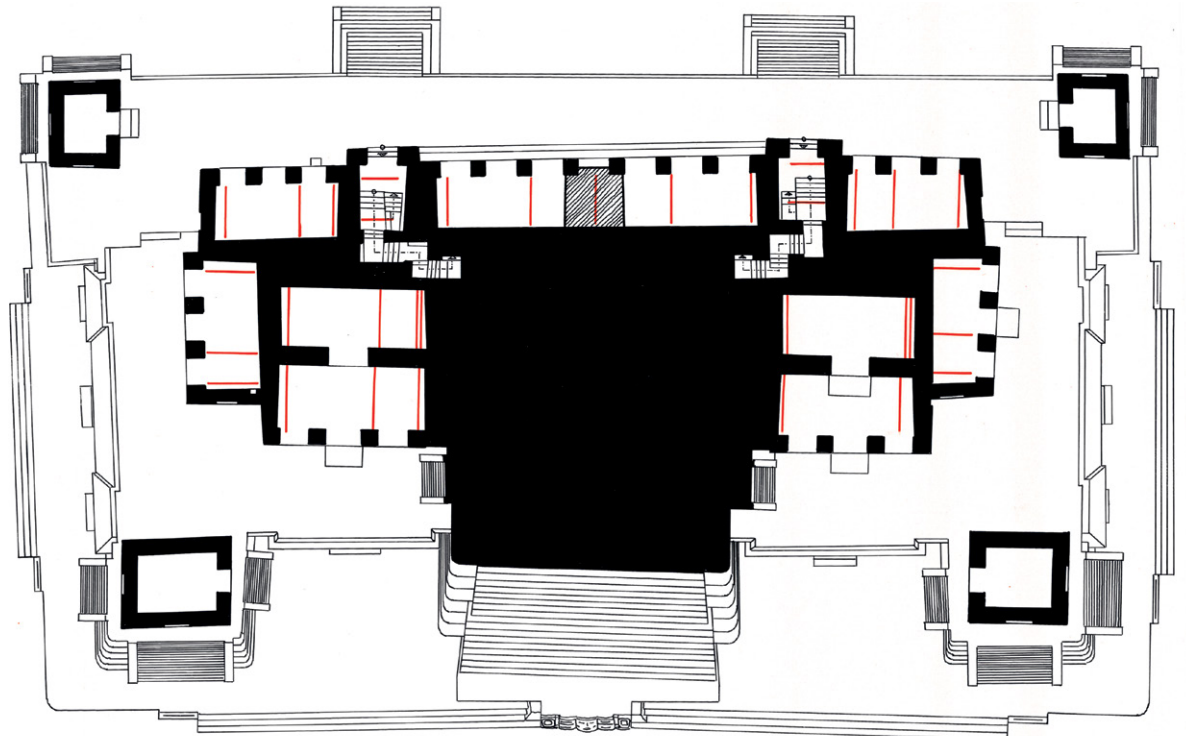
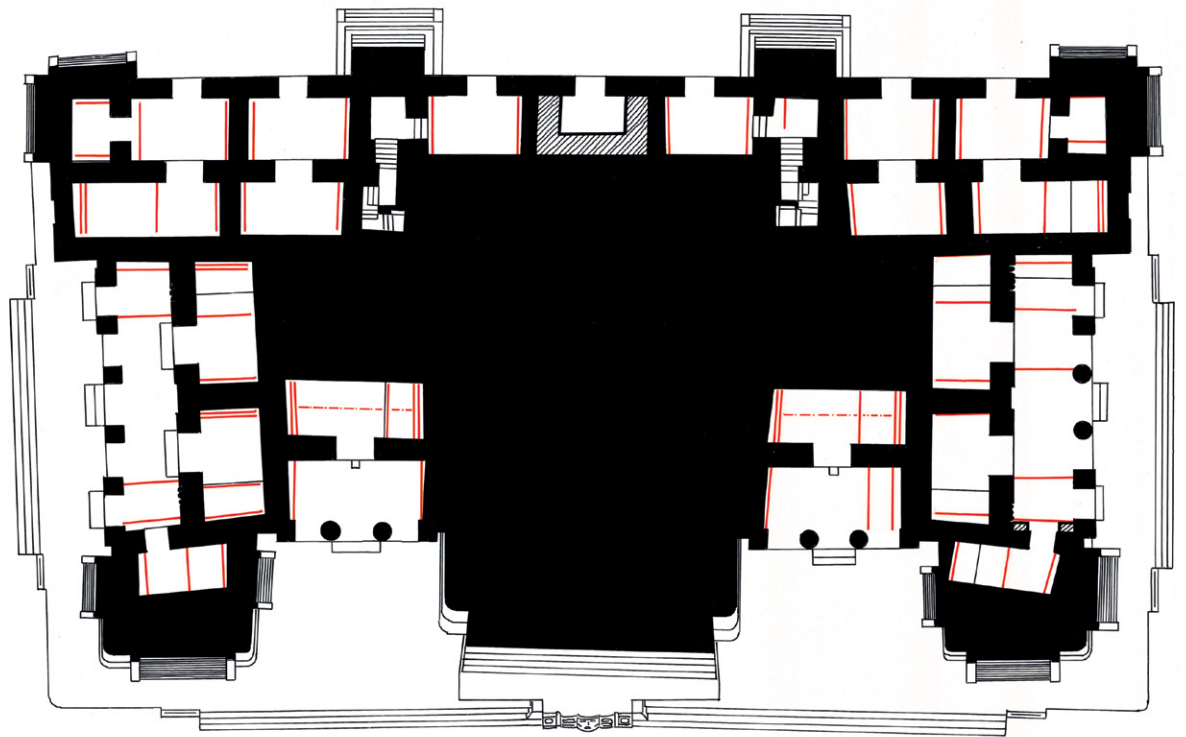

Fig. 147  
 Base maps with the lower vault beams  
 Asymmetrically positioned lower beams are indications of the former use of the room.

- Lower vault beams
- - - Suggested use of hammock

0M 5 10 15

of the vault zone was built later. The section between the core wall and the façade was usually a counterweight of the vault. In all these cases - as far as the author's knowledge of Maya vaults permits - it is a cast vault and consists of two massive stable blocks of the two halves of the vault. The horizontal pressure stress at the capstones could be taken over by these capstones after the material of both sides had hardened. When the vault was finished up to the vault façade it was often even balanced by the counterweight. Vault beams did not have a static function! The Palace of Santa Rosa Xtampak is a good example to study vault beams and their function. The three ground plans with the lower vault beams show that most of them have a position near the ends of the rooms. There they could not have any static effect on the vault. The other lower beams are not spread symmetrically over the room either. The Maya did not want the space underneath to be disturbed by objects hanging into the room between the vertical walls. They are often asymmetrically positioned just where they were used to hold, for example, a curtain in front of a bench.

Vault beams had very practical reasons. In Maya huts of perishable material the visitor will always find two different spaces inside - the space between the walls and the space under the roof. Both are used by the inhabitants. The lower level is used for daily life and for sleeping phases. Hammocks are bound to the lower members of the roof construction at a large distance so that they do not hang too steeply. Clothes usually hang from beams near the walls. Within the roof you find many goods hanging from nearly all the different free roof beams using the space in the roof space.

The space under a vaulted Maya stone house looks very similar compared with a Maya house of perishable material. The sloping sides of the corbelled vault and the two or three levels of vault beams are very similar. The author is sure the roof space and the vault space were used in a very similar manner.

In the Palace of Santa Rosa Xtampak there are a lot of vault beams. They were all measured for this documentation and drawn into the ground plan and are also in at least two of the cross sections. Most of these beams have disappeared due to rot or were used by hunters or *chicleros* to make fire. But in some rooms a few of them have still survived in situ as in Room 8 on the first floor (Hellmuth 1989c:Fig.2 and 3).

### **Pairs of Lower Vault Beams**

Double vault beams are two beams next to each other. Usually they are on the lower level within corbelled vaults or just beneath the vault spring. Pairs of lower vault beams are all positioned at the ends of a room. If they had no counterpart at the other

end of the room they served to hold heavy loads. Pairs of vault beams reduce the risk of breaking if termites or rotting have attacked a beam.

Two pairs of vault beams on the short opposite sides of a room are, for the author, a very strong indication of the use of a hammock. The user of a hammock wants to be sure he will not fall down if one of the vault beams breaks - therefore the inhabitants of the Palace used two of them on both sides for reasons of safety. There are some rooms in the Palace with double vault beams at only one end of the room but only one on the opposite side. In some of these cases one of the beams at the other side of the room once broke and since then has not been replaced and the beams were no longer used for hammocks. Two of these rooms are Rooms 30 and 32 on the second floor. They are symmetrically positioned to the main axis of symmetry - just above Room 6 and Room 8 with two pairs of beams - visible from the Plaza del Palacio. The other three rooms with only one double vault beam are Rooms 2, 3 and 26 on the first floor. These are all back rooms of living quarters with more than one room. Here the single pairs of beams had to hold heavy loads near the walls.

### **Pairs of Double Vault Beams**

In three of the 48 rooms of the Palace of Santa Rosa Xtampak we find two pairs of vault beams at opposite room ends, on the two gable walls. These pairs of double vault beams are all in rooms on the eastern side of the Palace. The rooms are Room 42 on the third floor in the most central room on the axis of symmetry and in the two Rooms 6 and 8 on the first floor. These rooms are symmetrically positioned on both sides of the axis of symmetry and the main Stairway A. People on the Plaza del Palacio could watch persons sitting in a hammock in the two Rooms 6 and 8. A person who wanted to watch the person sitting in the hammock in Room 42 had to be in the patio in front of this room and behind the monster mouth passageway.

The two rooms 6 and 8 together with Room 42 form a pattern of three symmetrically positioned rooms within the eastern façade. Possibly at one time the Rooms 30 and 32 also belonged to this pattern. There is one pair of beams in both rooms; perhaps one beam on the opposite side broke in each of these rooms. The author is convinced that at least in these three rooms the two pairs of vault beams were used to span hammocks from.

Fig. 148

The Maya Classic Period vase of Tabasco, also called "Pellicer Vase of Tabasco" in the Tabasco State Museum in Villa Hermosa is unfortunately incomplete but shows enough to enable us to reconstruct the entire polychrome market scene with a guard sitting in a hammock spanned between two posts (Hohmann 1984:1-5).

Drawing: H. Hohmann 1984

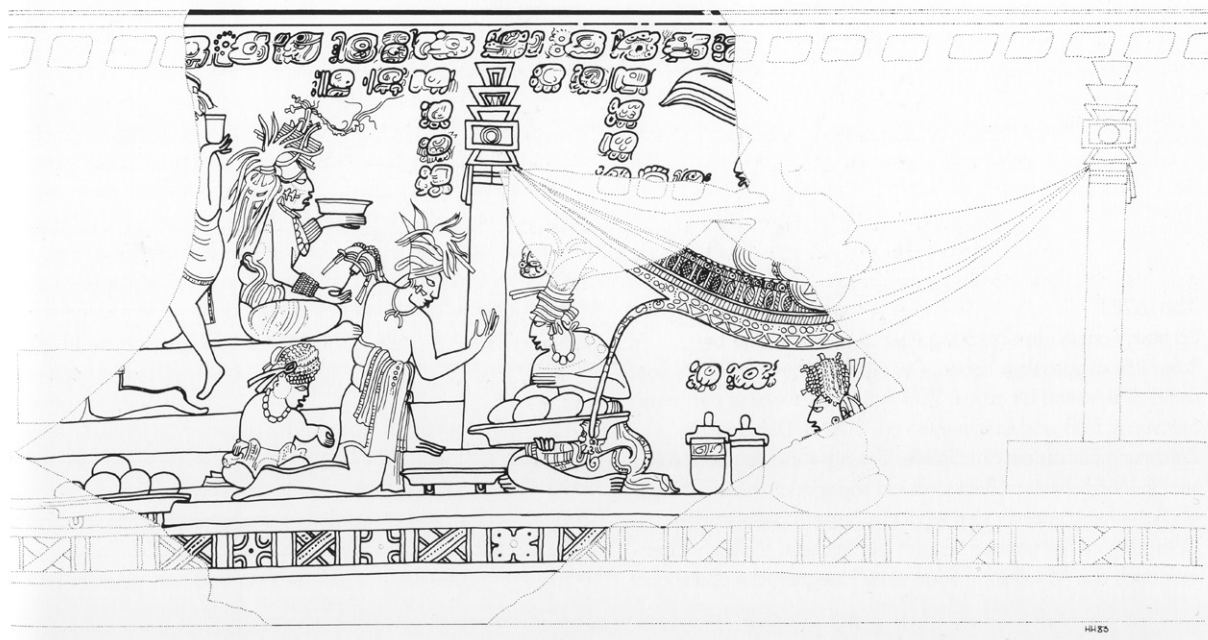
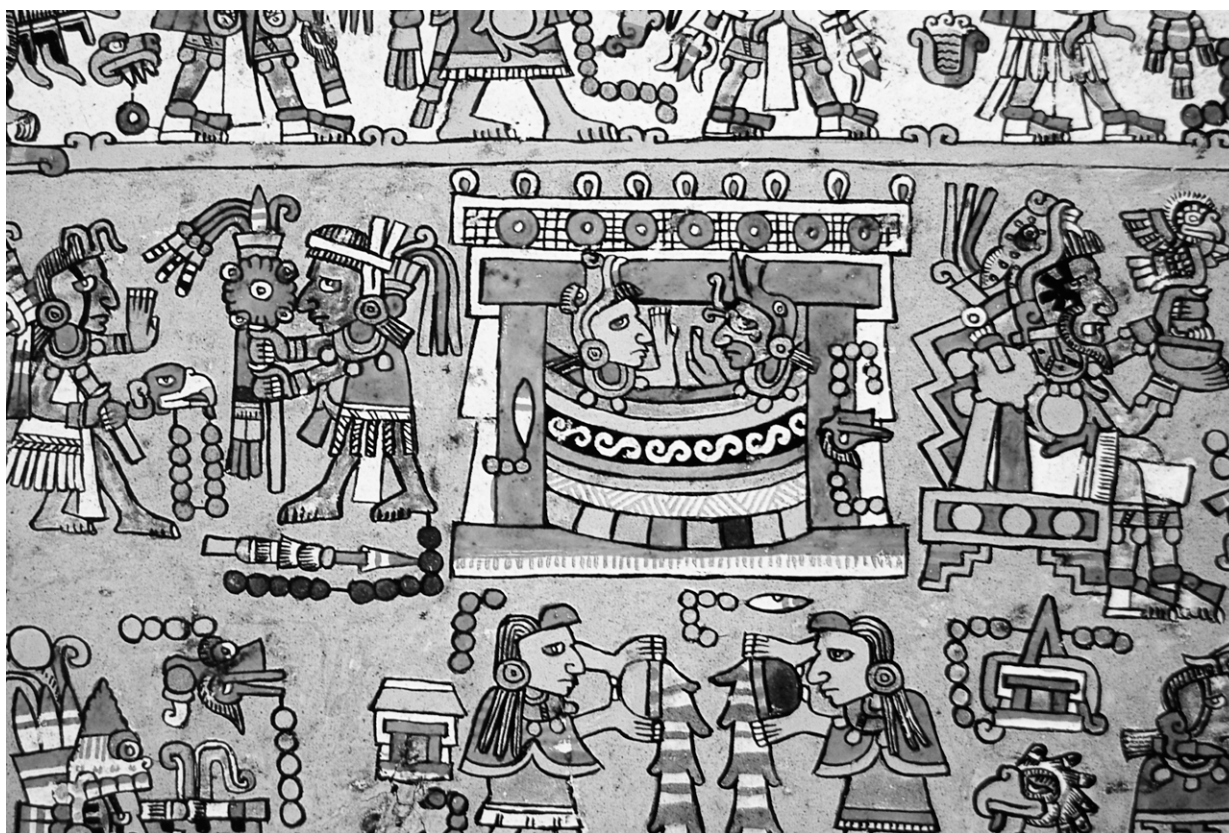

Fig. 149

On page 19 the Mixtec Codex Zouche-Nuttall shows (Codex Zouche-Nuttall 1987:19) the representation of a representative temple or palace with two persons sitting in a hammock in the centre of the room visible through the entrance from outside. It is a different culture and a later century. Thus, it shows the use of hammocks in Pre-Columbian Mesoamerica on the continent.



## Hammocks

Morley and Brainerd (1956:177) and many other Maya scientists doubt the use of hammocks in the Maya Classic Period. They even suspect that "the hammock was probably imported by the Spaniards from the Caribbean region" (Morley and Brainerd 1956:178). There are the fragments of a Maya Classic vase in Tabasco in the Tabasco State Museum in Villa Hermosa, which clearly represents a hammock hanging from two poles with a person sitting in it, watching a market scene (Hohmann 1984:1-5; Gendrop 1997:104). This shows that the Maya of the Classic Period knew hammocks and used them in some phases more, in others less often. Around the time of the Conquista

and later they possibly did not use them so often. They might have gone out of fashion.

We should realize that there is a whole complex of objects, which all follow the same principle of tension-stressed constructions; we might even speak about thinking in tension-stressed constructions in Mesoamerica. There are not only, for example, hammocks but also the typical indigenous suspension bridges, the hammock bridges, the hammock litters but also the way they transport heavy loads on their backs using a band tied over the forehead, the storage of food in nets hanging down from the roof construction, and the shawls women transport their young children in (Hohmann 1984:1-5).

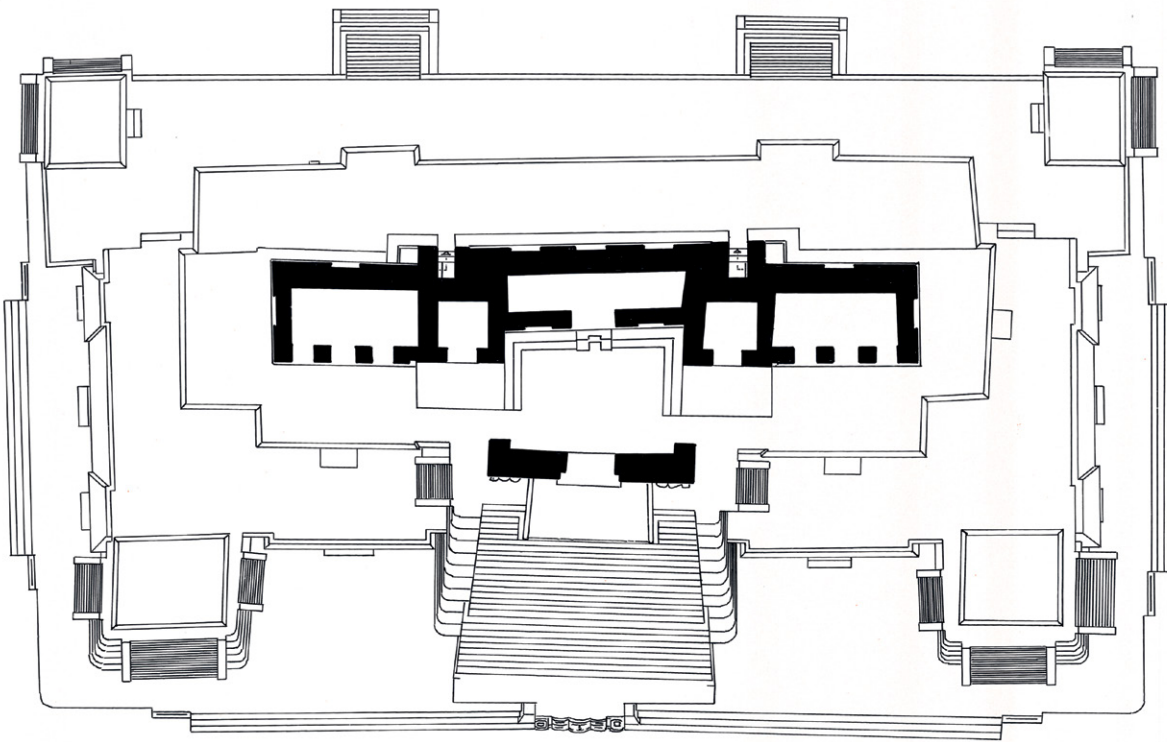
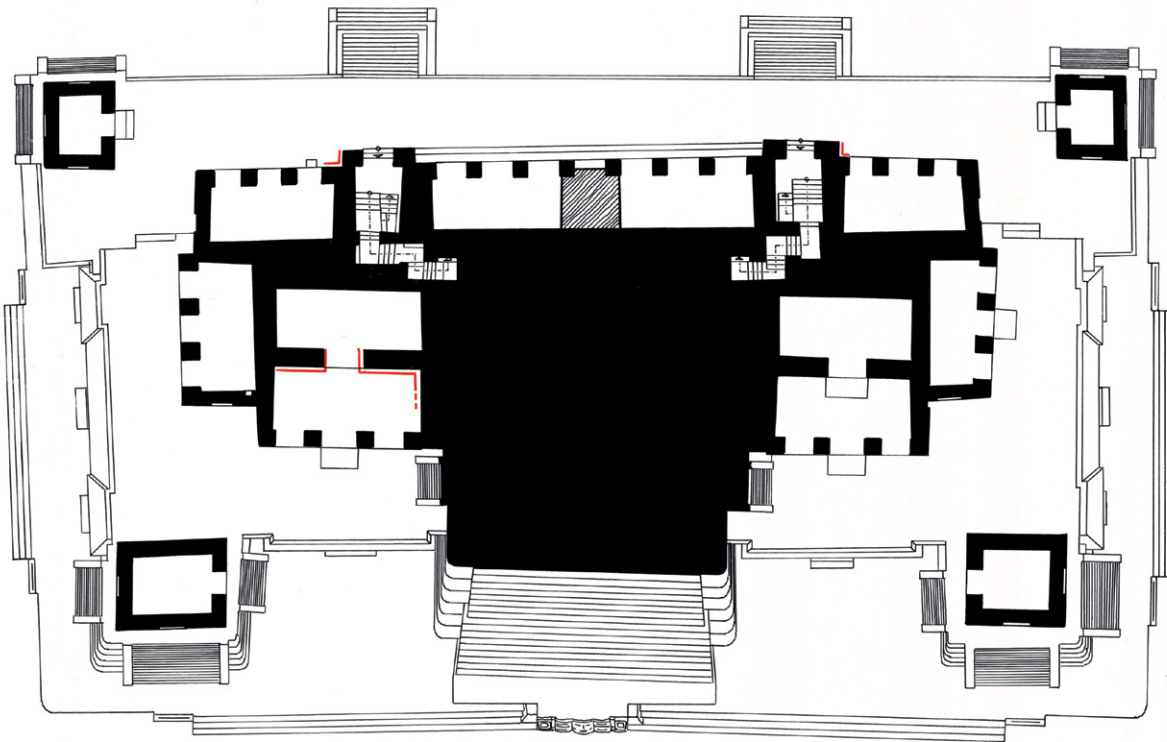
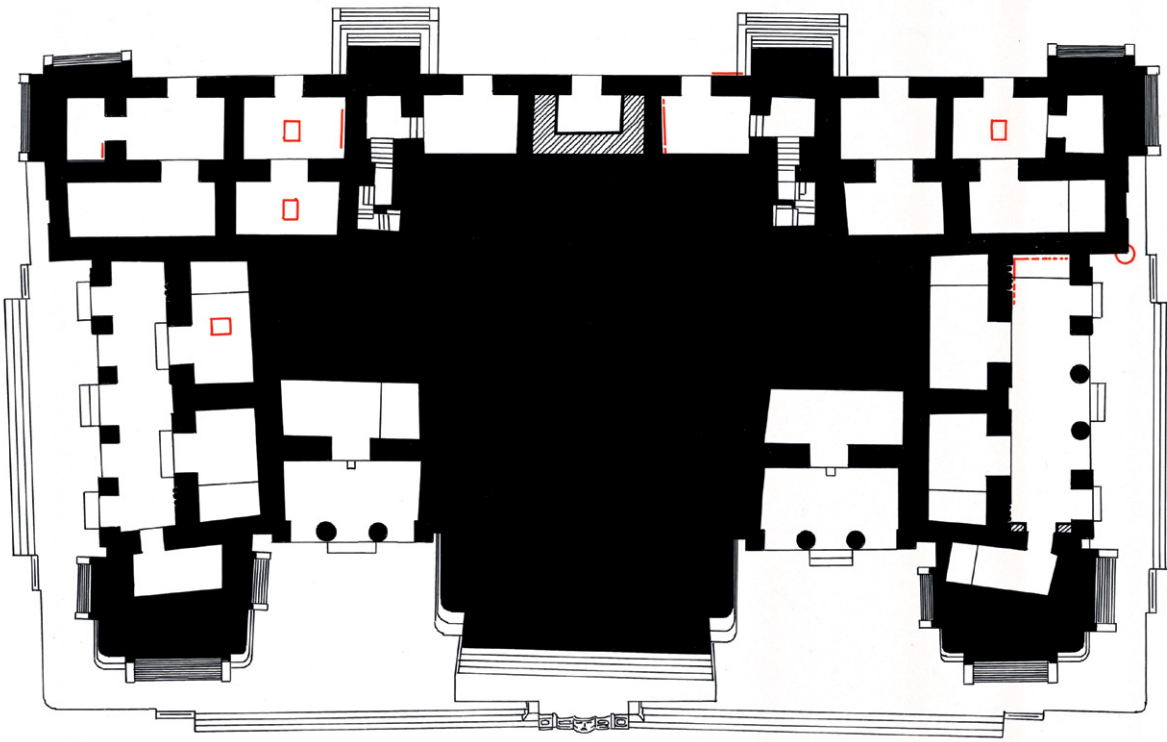

0M 5 10 15

Fig. 150  
Painted decoration

- Painted capstones
- Painted cornerstone
- Wall paintings/murals



## Upper Vault Beams

In contrast to lower vault beams upper vault beams are usually spread over the length of the room. Objects hanging down from them did not disturb the use of the room underneath, as they hung in the space of the vault. They functioned to store food and objects of daily life in, to keep them dry and inaccessible to children and animals (please refer to the previous chapter about lower vault beams).

## Capstones

### ◦ Form

Capstones are long flat rectangular stones bridging from one half to the other half of a corbelled vault. In quite a lot of important Maya buildings the most central of the long row of capstones is painted or sculpted (Mayer 1983:1-62).

In quite a lot of the rooms of the Palace of Santa Rosa Xtampak the most central capstone of the vault was or still is decorated. Most of the paintings are just in red color on a white ground; the decoration often includes the representation of a god and a short inscription. In several cases only a colored frame of the

painting survived, the rest has disappeared. Others are already in private collections. In such cases usually the provenience is unknown or very general.

In his article Sylvanus G. Morley (1948:49-50) describes seven rooms at the Palace with decorated capstones. He does not designate the rooms as he fears otherwise looters would use his article to find and loot the capstones. Unfortunately his system did not prevent looting in the Palace.

Stamps noted painted capstones in the Rooms 2, 13, 23, and 24 (Stamps 1970:60). In his article about painted capstones (Mayer 1983:1-62), Karl Herbert Mayer lists eight capstones of the Palace of Santa Rosa Xtampak. Two of them have or had decoration on two different levels. They were later painted on a second level for a second time.

It is not known if there were also painted capstones in rooms on the upper two floors of the Palace. Karl Herbert Mayer told the author that the responsible archaeologist for the Palace found several more capstones while excavating the Palace within the last several years. Unfortunately these capstones have not yet been published.

In many cases the paintings on capstones were destroyed by wetness. Sections of the paintings were falling down. Often only small remains of the paintings survived, in some cases only part

Fig. 151

Capstone Cst. 1 and Cst. 2 in Room 24. This shows two layers of plaster with paintings in red lines on a white background, one above the other.

Peabody Museum, Harvard University (Photo No. A-36-85, with permission of the Peabody Museum, Harvard University by Karl Herbert Mayer)

Photograph: H.E.D. Pollock 1936

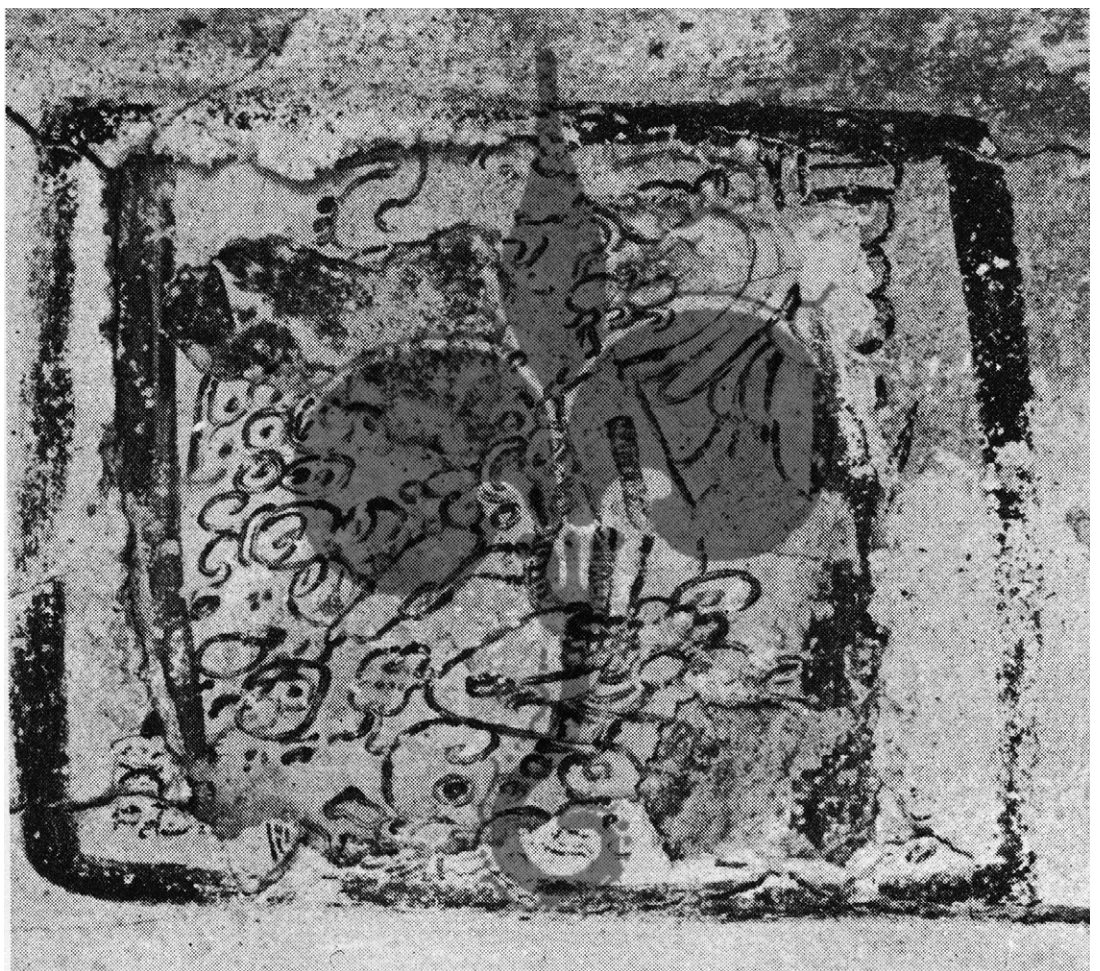



Fig. 152

This capstone was positioned in the South of Room 21 on the floor near the steps up to Room 22. It was called Cst. 8 by Karl-Herbert Mayer (Mayer 1983:40). It still shows some remains of a painting in light and dark red on white plaster. Photograph: H. Hohmann 1999



Fig. 153

This shows a section of the corbelled vault in Room 2 with the two most central capstones. Here the capstones were not pre-painted. The plaster covering the capstones was painted at the end of the construction phase. The painting is a mural looking like a painted capstone which was added later. The frame of the painting covered only part of the two capstones behind. Karl-Herbert Mayer called it CST. 5 (Mayer 1983:40).

Photograph: H. Hohmann 1999

of the rectangular frame of the painting or just a small portion of the motive shows that there was once a painting on the capstone. Most of the destruction was caused by looters, when they broke the painted capstone out of the vault.

The fragment of the painting between the two central capstones in Room 2 is very small and held by the plaster material of the joint between the two capstones. It represents a seat with a jaguar skin directly above the lower frame of the painting (Mayer 1983:40). We also see the feet of God K'awiil, an anthropomorphic figure with one normal foot to the right and one leg ending in a twisted serpent to the left standing on the jaguar seat.

◦ Construction

Decorated capstones were usually painted or sculpted before they were put into the vault within the building phase. In some cases this system caused problems with the size of the motive if the real space was smaller than expected later. Therefore in some cases the motif is not completely visible. It seems the painted capstones belonged to a building ceremony and therefore it was more important to have them and less important that the entire motive could be recognized.



Fig. 154

Capstone Cst. 3 and Cst. 4 in Room 23. They show two layers of plaster with paintings in red lines on a white background, one above the other.

Peabody Museum, Harvard University (Photo No. A-36-84, with permission of the Peabody Museum, Harvard University by Karl Herbert Mayer)

Photograph: H.E.D. Pollock 1936

◦ Function

Eduard Seler (1916) speculated about the function of these capstones in relation to rooms with such painted capstones in Dzibilnocac. He speculated that they might have been used as prisons for captives for human sacrifice. Karl Herbert Mayer interprets the most central position in the highest zone of a vaulted living room of the Maya elite as the representation of the sky. This is supported by several representations of sky gods, super-terrestrial beings and rich religious symbols (Mayer 1983:19).

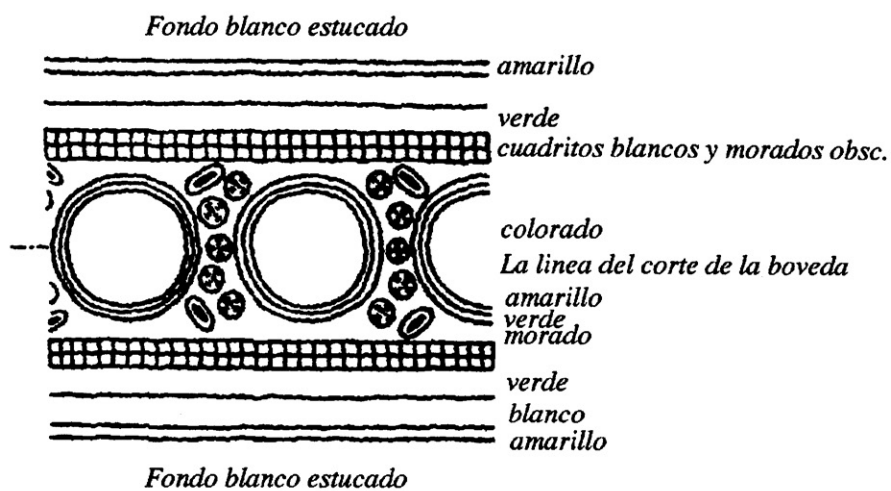

## Paintings

The entire Palace seems to have been painted inside and outside at one time. At several locations on and in the Palace earlier scientists and the Austrian Team found remains of plaster with a fine white lime film and colors on top.

In Room 9 we still find larger remains of a polychrome wall painting in the southwestern edge of the room in the vault zone, at the vault spring and a few remains on the wall underneath, which were already documented by Teobert Maler in 1891 (1997:214, Fig. 1-6). The vault painting still shows three quite large oval fields with remains of motives which might be interpreted as sacral figures. The motives are surrounded by star motives. The mural is painted in white, red, orange, dark violet, and green. The frame system and some of the small round elements in this painting are similar to the huge painting in the "Building with Paintings" in Ichmac, Campeche (Pollock 1980:477, Fig. 798).

Stamps reports on red rings around the lower vault beams in Room 26 and around the upper vault beams in Room 2. He also reports on green, blue, and orange paint on the southern face of the doorway from Room 29 to Room 30. The northern face had remains of blue paint (Stamps 1970:60).

We can still see fragments of two colored bands on the back wall under the vault spring of Room 29. In the same room an interesting mural representing at least four persons in different colors was visible on the northern half of the same wall further below at least until 1990 – when Jack Sulak photographed it for the last time. The four faces of the persons were already destroyed. Since 2003 the entire mural has been completely destroyed. The two red bands near the vault spring have lost a lot of color and detail.

Fig. 155

The mural of Room 9, south-western edge above the bench, documented by Teobert Maler

Drawing: T. Maler 1891

Fig. 156

Two of the altogether three oval colored fields to the right and the chequered band to the left of the mural on the vault on the south-western edge of Room 9.

Photograph: H. Hohmann 1999

Fig. 157  
The northern half of the western wall of Room 29 with the mural representing a group of at least four persons.  
Photograph: J. Sulak 1989



Fig. 158  
Jack Sulak outlined three figures of the mural in Room 29 and the former inscription block above.  
Photograph: J. Sulak 1989



Fig. 159  
This small section of the mural on the western wall of Room 29 north of the passage-way shows three of the four persons. Their heads were destroyed recently.  
Photograph: J. Sulak 1989



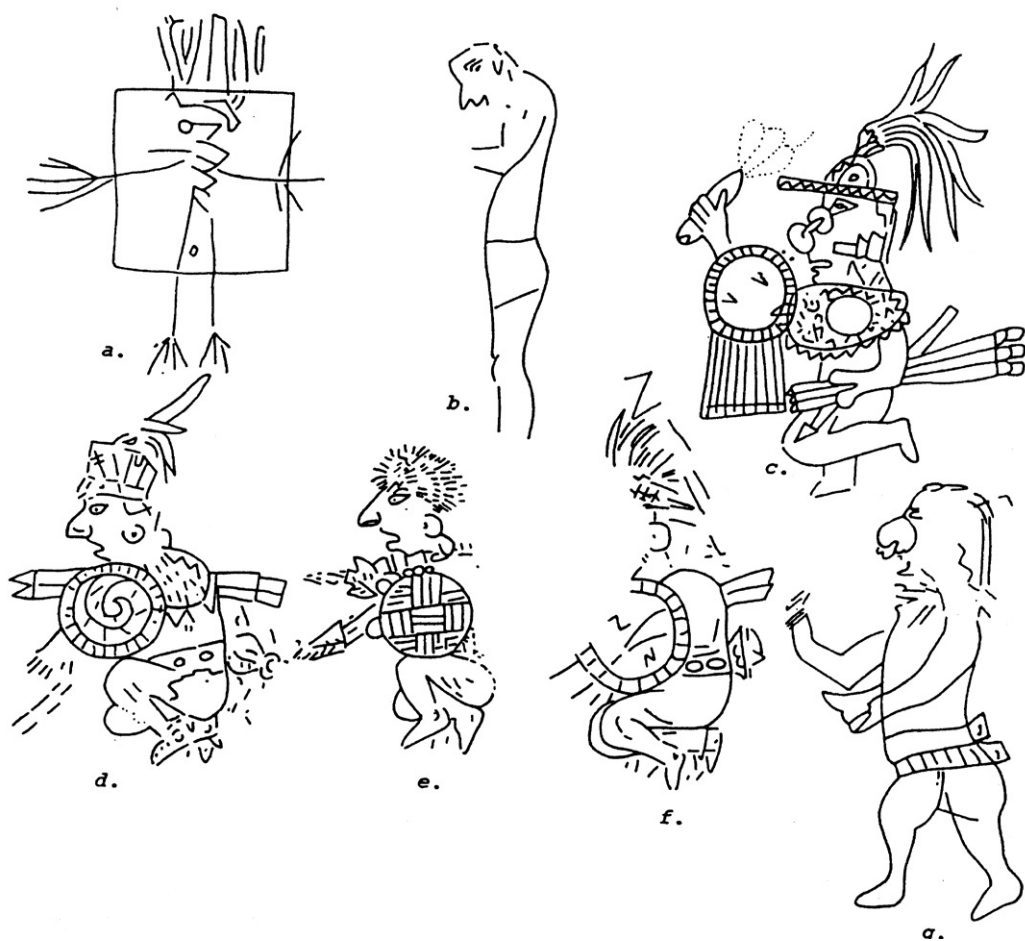

Fig. 160  
 This graffito in the wall plaster of the jamb  
 of the passageway from Room 13 to Room  
 14 represents mainly warriors.  
 Drawing: T. Maler 1891



Fig. 161  
 Here we see the last remains of the two  
 bands on the western rear wall under the  
 vault spring of Room 29. The broader  
 band once showed Maya hieroglyphs, as  
 Maler recognized back in 1891 (Pollock  
 1970:57). The color between and above  
 the two bands was green.  
 Photograph: J. Sulak 1989

Fig. 162  
Detail of the upper broader band which still shows remains of Maya glyphs. The wall between and above the two bands was painted in green.  
Photograph: H. Hohmann 1999



Fig. 163  
The wall north of the passageway shows two bands under the vault spring with remains of Maya hieroglyphs and remains of a mural representing at least four persons above the rubble. Colors: brown, green, and orange.  
Photograph: J. Sulak 1989





Fig. 164

The southern door jamb shows dark blue, white, yellow, and brown horizontal lines and a light blue vertical line on the right side; a similar painting was on the northern door jamb (Potter 1970:57).

Photograph: J. Sulak 1989

There are some more painted elements at the Palace. In several rooms painted capstones were or still are always positioned in the centre of their vaults (read the paragraph about capstones). Eight of the painted capstones could be coordinated with six rooms. Most of them were painted before they were used to close the center of the corbelled vault. There must have been an architectural ceremony, when they were used to close the vaults of the different living units. At least two of them in Rooms 23 and 24 had even been painted twice – the second time on a stucco layer within the vault. Unfortunately the best of the eight capstones have been stolen and the capstones which have been found in the last years have not yet been published.

The second painted item is at least one painted medial molding cornerstone at the northeastern corner of Room 14. This stone was also painted on its underside before it was positioned in the corner of the molding. This cornerstone must also have been positioned in the Palace in an architectural ceremony after it had been painted. At the end only a section of the painting is visible. There might be a second such painted cornerstone at the southeastern corner of Room 26.

### Style and Age of the Palace

There are plenty of colonnettes in the central member of the three-member base molding of the rooms on the first floor along the 50 m long western façade of the Palace. Plenty more colonnettes form the medial member of the three-member base moldings of the four temples on the second floor. Some more colonnettes are in the central member of the three-member base molding of Room 1. Colonnettes are a typical element of late Classic **Puuc** architecture. There is the dominating huge monster mouth passageway at the eastern façade on the third floor. This is a typical element of late Classic **Chenes** architecture. And the temple pyramids with pseudo stairways and suspected pseudo entrances, which are typical for late Classic **Río Bec** architecture.

Therefore we may state that the style of the Palace is a good mixture of the three major Maya architectural styles of this region within the Late Classic Period – Puuc, Chenes, and Río Bec. The architectural style of the Palace also indicates that it was erected in the late Classic Period.



Fig. 165  
The painting on the cornerstone of Room 14.  
Photograph: R. Stamps 1969



Some of the capstones in the Palace not only show representations of gods but also dates. As already stated above under "capstones" it seems to be quite certain that the closing of a corbelled vault with a decorated capstone was celebrated in a special architectural ceremony. It seems quite obvious that a Maya date in a decorated capstone could relate to the date of the celebration. In such cases it should be possible to search for the building date of this section of the building.

Such dates are provided by Daniel Graña-Behrens (2002: 34-38). The capstone of Room 24 carried the date 869 AD in the first decoration, the second decoration has the date 948 AD. Even the earlier date cannot be the building date but must be a secondary one. The capstone of Room 23 carries the date 791 AD on the second later decoration. This means the first decoration must be earlier than 791 AD. If we take the time span of the two levels of the capstone of the back room as being nearly 80 years, this would mean this part of the Palace with Room 23 was erected at the beginning, at least in the first half of the eighth century AD.

## BUILDING MATERIALS

### Stone

The stone used for the Palace of Santa Rosa Xtampak is a quite soft limestone.

### Plaster

In 2002 the "Institute for Technology, Strength and Testing of Materials" and the "Institute of Engineering Geology and Applied Mineralogy" at the University of Technology in Graz analyzed the mortar from the debris of the Palace of Santa Rosa Xtampak. Dietmar Klammer (Institut für Angewandte Geowissenschaften der Technischen Universität Graz) checked the sample of stucco material, which was taken from the debris around the palace in 2001.

1. At the beginning the author did not inform Dietmar Klammer about the origin of the sample which he gave him and where it came from. Klammer's result was that the sample is a piece of a carbonate rock (calcit). It must be of maritime origin. There are maritime fossil remains visible under the microscope. Also the content of strontium and magnesium seems to be high. Both, the microscopic research and the research about the components were carried out by an assisting colleague at the institute.

2. After an intensive discussion the author told Klammer that the sample came from Santa Rosa Xtampak, an archaeological site of the Classic Maya period in Campeche, and that it is a stucco sample from a wall of the Palace. After giving Klammer this information he modified his result:

The sample is completely carbonized. With the help of X-ray research only calcite  $\text{CaCO}_3$  as mineral phases could be identified. Further adhesive burned calcite as cement could not be analyzed.

This result forced the author to ask if it could be possible that the water soluble calcite had been dissolved through periodic rain periods over nearly 1300 years, percolated some millimeters and petrified into sinter? Klammer agreed that this could be possible.

The calcite material need not move down or to the side much in this process. The material would get its hardness in this process from the petrification of the sinter material – not from burning and slaking the calcite. This material could possibly take even more tension stress than the original mortar. After this process no hydraulic cement could be proved. Some more laboratory tests should back this theory.

Tatiana Proskouriakoff already had faced a similar problem. In the case of Mayapan, Tatiana Proskouriakoff wrote "It is difficult to judge how much lime was used in this mortar, for most of it has leached out with time, and it now has the consistency of earth" (Proskouriakoff 1962:92).

David Potter (1977:38) states for Structure IV at Becan that there was undoubtedly the use of "lime mortar of a quality difficult to determine".

At Becan the fill of the walls must presently be harder than in Mayapan and some of the structures at Xkipché (Hohmann 2000). There are many single high walls still standing with corbelled vault halves on both sides and some strong material must still bind the huge vault blocks together.

### Wood

Nearly all lintels and all lower and upper vault beams as well as the strengthening beams within the core of the cast vaults were made of wood. Several of these wooden elements have survived until now – resisting termites, rotting or fire. Nicholas M. Hellmuth writes about the wood material that the builders of the Palace used fresh cut "zapote" wood (Hellmuth 1989c:32), chico zapote wood. Stamps writes about "sapidilla" wood (Stamps 1970:52), in Latin *Manilkara zapota*. Both mean the same. For the lintels it was formed into quite thin beams, flattened on the underside and straightened along the sides. The vault beams and the reinforcing beams within the vaults above the lintels are all just round beams.



# COMPENDIUM

## SUMMARY

“The Palace of Santa Rosa Xtampak”

The Palace of Santa Rosa Xtampak in the Mexican state of Campeche is one of the most impressive and outstanding building complexes of Maya architecture. The composition of its architectural elements and the design are impressive and make the Palace a piece of architectural art.

In 1989 and again in 1992 Erwin Heine and Andreas Reiter, at the beginning students of the Faculty of Geodesy at the University of Technology in Graz, worked with stereo-photogrammetrical equipment on a new geodetic documentation of this Palace. The result was a map with 20 cm contour lines, new ground plans of all three floors, a large series of cross sections in both directions, and a digital three dimensional model of the entire structure including the two staircases. In 1997 Heine was awarded his PhD. His work includes a 3D documentation, the first to be used for cyberspace in ancient Maya architecture.

Additional measurements of the author in 1998 and 1999 of all cord holders, rod sockets, lintels, vault beams, capstones, benches and niches together with the plans by Heine and Reiter resulted in a very detailed documentation. The plans show the differing levels on each of the three general floors. Based on the Heine and Reiter geodetic survey including measurements by George F. Andrews and measurements from photographs of the excavated, restored, and reconstructed sections, excavated by Renée Lorelei Zapata Peraza, a new documentation and reconstruction of the Palace by drawing was carried out. The more than 70 plans – most of them to scale - include the three large scale ground plans and the four front views each followed by a series of cross sections so that the Palace becomes transparent. Perspectives complete this part of the work. It would be possible to rebuild the Palace from these plans.

There are plenty of results of the analysis. The architecture is a combination of Río Bec, Chenes, and Puuc elements. The Palace combines temple pyramids and an artificial mound with domestic structures of different sizes on terraces, a mixture of sacral and profane architecture. This is not unique in Maya architecture but makes the complex quite interesting. The combination of the two architectural categories in a very profane way is amazing. The author did not expect a pyramid with pseudo stairways and mega steps to contain a normal domestic room with a sleeping bench in its core. It turned out that the façades of the structure need not fit in with its inner substance and function.

The Palace has seven temple pyramids, 4 with real temples and three with pseudo temples. It shows 21 profane structures, seven on the first floor, seven on the second, and seven on the third floor. Behind their façades there are 2 four-room units, 2 three-room units, 6 two-room units and 11 one-room quarters, together 21 apartments of different sizes. In this count Rooms 35 and 36 are one as originally planned. The static problems and the strengthening of the structure are also discussed.

The two inner staircases are the only real connection for the three floors of the Palace. They are perfectly hidden behind domestic-looking rooms, pseudo stairs and pseudo temples.

The ground floor of the Palace contains spoils, reused stones from one or more older, destroyed buildings. Some have been reused as spoils in the staircases. Most of them are in the two entrance halls Room 1 and Room 9 as part of a culture of remembrance. In Room 1 there are two receding relief fields in the center of the north wall. At both ends of this wall we find two sculpted half columns containing reused relief elements.

In Room 9 the projecting upper member of the base molding consists of reused relief elements with rhomboids in the upper half and fringes in the lower half. In the same room we find a huge rectangular receding relief field in the centre of the southern wall. All relief elements are intentionally fitted together incorrectly. This work provides a solution as to how to fit one of them together in the correct way. The incorrectly assembled reused reliefs show a culture of remembrance of former structures and persons.

Unfortunately some questions remain. Of what material is the mound in the center formed? Why have Rooms 4 and 10 deviating directions and what are they focusing on underneath Stairway A? Are there remains of a former structure there?

The form and construction of the Palace are nearly completely known from surviving remains and additions by inductive solutions. Even the question about the existence of a roof comb above the third floor structures could be answered. Only a few questions concerning the small temples at the four corners must remain uncertain. Rod socket, cord holders and lower vault beams give strong indications of the function of rooms.

The builders of the Palace needed to have a general plan for the structure. They might have had a model consisting of several pieces which had to be fitted together. It seems the Palace was not built by one single “owner”. Different important families of the former Santa Rosa might have built it together following a general concept but varying its architecture in detail. This might explain so many differences in detail between domestic units on the two sides of the axis of symmetry. The main entrance of Room 9 for example is flanked by columns, the main entrance of Room 1 has pillars.

The publication provides a concordance list of the different existing nomenclatures for the 48 rooms and a new one for the 21 stairways to identify rooms and stairways more definitely. It also contains a plan with open and closable spaces, with the different domestic units, a plan documenting benches, the positions of lower vault beams, with pairs of vault beams, with court holders, rod sockets, with wall and vault paintings, and with the known positions of painted capstones. There is discussion about the form, construction, and function of each room of the Palace. The Palace covers most of the west side of the Plaza del Palacio. In a larger context the Palace together with the Structures 2 and 26, the three highest structures near the top of the Santa Rosa Xtampak hill, frame a larger four plaza area - the Plaza del Palacio, the Plaza Central, the Plaza del Cuartel, and the Plaza Oriental.

## ZUSAMMENFASSUNG

“Der Palast von Santa Rosa Xtampak”

Der Palast von Santa Rosa Xtampak im mexikanischen Bundesstaat Campeche ist einer der eindrucksvollsten und herausragendsten Gebäudekomplexe der Maya-Architektur. Seine Gestaltung und die Komposition seiner Architekturelemente sind eindrucksvoll und weisen den Palast als ein Objekt hoher Baukunst aus.

1989 und nochmals 1992 arbeiteten Erwin Heine und Andreas Reiter, zunächst noch als Studenten der Fakultät für Geodäsie der Technischen Universität Graz, an einer neuen geodätischen Dokumentation des Palastes. Das Resultat waren Pläne der drei Stockwerke mit 20-cm-Höhenschichtenlinien samt Grundrissen, Ansichten, eine große Zahl an Schnitten in zwei Richtungen und ein dreidimensionales digitales Modell des gesamten Bauwerks. Diese schlossen die zwei einzigartigen Treppenhäuser detailliert ein. 1997 erhielt Heine für seine fortführende Arbeit den Dr.-Titel. Seine Arbeit ist wohl die erste digitale 3-D Dokumentation, bei welcher Cyberspace in der Maya-Architektur eingesetzt wurde.

Ergänzende Messungen des Autors 1998 und 1999 von Architekturelementen wie Seilhaltern, Stabhaltern, Türstürzen, Gewölbebalken, Gewölbedecksteinen, Schlafbänken und Nischen ergaben zusammen mit den Plänen von Heine und Reiter eine sehr detaillierte Architekturdokumentation. Die Grundrisse geben detailliert Auskunft über die drei generellen Ebenen des Palastes. Basierend auf der geodätischen Vermessung von Heine und Reiter unter Einbeziehung von Messungen von George F. Andrews und solchen aus Fotos durch den Autor, welche die neu von Renée Lorelei Zapata Peraza freigelegten, konsolidierten und rekonstruierten Architekturteile zeigen, entstand eine neue Dokumentation des Palastes und Diskussion aller Details. Diese Dokumentation umfasst mehr als 70 meist maßstäbliche Zeichnungen, die drei Grundrisse, vier Ansichten, jeweils gefolgt von zahlreichen Schnitten, welche den Palast transparent machen. Perspektiven ergänzen diesen Teil der Arbeit. Nach diesen Plänen könnte der Palast nachgebaut werden.

Die Analyse ergab u.a. folgende Resultate. Die Architektur ist eine Kombination von Río Bec-, Chenes- und Puuc-Elementen. Die Tempelpyramiden wurden mit Wohneinheiten unterschiedlicher Größe auf einem künstlich terrassierten Hügel kombiniert; so ergibt sich eine Mischung von sakraler und profaner Architektur. Dies ist nicht einzigartig in der Maya-Architektur, macht aber den Komplex interessant. Die Art der Kombination der zwei Architekturkategorien in einer sehr pragmatischen Art ist oft erstaunlich. Gewöhnlich erwartet man nicht, dass im Kern einer Río Bec

Pyramide mit sehr steilen Pseudotreppen und Großstufen bzw. unter dem zugehörigen Tempel ein gewöhnlicher Profanraum mit Schlafbank angeordnet ist. Grundsätzlich kann man feststellen, dass die Fassaden des Palastes vielfach nicht mit der inneren Funktion übereinstimmen.

Der Palast hat sieben Tempelpyramiden, vier mit echten Tempeln, drei mit Pseudotempeln. Er zeigt nach außen 21 Profanbauten, sieben im Erdgeschoss, sieben im zweiten und sieben im dritten Geschoss. Hinter diesen Fassaden finden sich 2 Vierraumeinheiten, 2 Dreiraumeinheiten, 6 Zweiraumeinheiten und 11 Einraumquartiere, zusammen wieder 21 Wohneinheiten unterschiedlicher Größenordnung. Hierbei wurden die Räume 35 und 36 als ein Raum gezählt. Die statischen Probleme und die stabilisierenden Maßnahmen der Maya werden diskutiert.

Die zwei Treppenhäuser sind die einzige wirkliche Verbindung zwischen den drei Ebenen des Palastes. Diese wurden wohl aus Sicherheitsgründen perfekt hinter Pseudotreppen, Pseudotempeln und Pseudowohnräumen versteckt.

Das Erdgeschoss enthält zahlreiche Spolien, wiederverwendete Steine eines älteren zerstörten Gebäudes. Einige wurden wie in den Treppenhäusern einfach recycelt. Andere finden sich in den Räumen 1 und 9 in sichtbarer Position als Teile einer Erinnerungskultur. In Raum 1 sind es zwei zurückweichende Relieffelder im Zentrum der Nordwand. An beiden Enden dieses Raumes findet sich je eine fast raumhohe reliefierte „Halbsäule“.

In Raum 9 besteht das obere Gesims des Basisprofils aus einer Reihe reliefierter Steinelemente mit Rhomben oben und Fransen unten. Im selben Raum findet sich im Zentrum der Südwand ein aus Reliefelementen zusammengesetztes Relief. Alle Reliefs in beiden Räumen sind offenbar intendiert falsch zusammengesetzt. Diese Arbeit bietet für das Relief in Raum 9 eine Anleitung für das richtige Zusammenfügen der Reliefblöcke. Die falsch zusammengesetzten Reliefs gehören offenbar zu einer speziellen Art der Erinnerungskultur bei den Maya - Erinnerung an wichtige Bauten und an deren Bewohner.

Leider bleiben einige Fragen unbeantwortet. Wie sieht das Innere des künstlichen Hügels aus? Warum weichen die Räume 4 und 10 mit ihren Längsachsen deutlich vom Gefüge der anderen Räume ab und worauf unter der Haupttreppe A zielen sie? Gibt es noch Reste eines früheren Gebäudes an dieser Stelle?

Form und Konstruktion des Palastes sind durch den Bestand und durch induktive Schlussfolgerungen nahezu komplett bekannt. Selbst die Frage nach einem Dachkamm konnte geklärt werden. Nur wenige Fragen hinsichtlich der vier kleinen Tempel an den Ecken bleiben unbeantwortet. Stabhalter, Seilhalter und die unteren Gewölbepfeiler ergeben meist klare Indizien zur ehemaligen Funktion der Räume.

Für den Bau des Palastes muss es einen Generalplan gegeben haben. Möglicherweise gab es ein Modell, das aus den unterschiedlichen Teilen, vielleicht aus den Wohnraumeinheiten, bestand, welche zusammengesetzt den Palast ergeben. Es scheint, dass der Palast nicht von einem einzelnen Bauherrn errichtet wurde, sondern von mehreren einflussreichen Familien der einstigen Maya-Stadt. Während alle dem generellen Architekturkonzept in der Großform folgten, kam es immer wieder zu Abweichungen im Detail. Das könnte die vielen Variationen im Palast rechts und links der Symmetrieachse erklären. Das auffälligste Beispiel hierfür sind die Haupteingänge in die Räume 1 und 9 – einmal von Pfeilern, einmal von Säulen flankiert.

Es gibt Listen der unterschiedlichen Nomenklaturen der Räume. Neu wurden Bezeichnungen für die 21 Treppen des Palastes eingeführt. Die Arbeit enthält einen Plan mit den überdachten, aber offenen und den verschließbaren Räumen; es werden die unterschiedlichen Wohneinheiten dargestellt; in einem Plan werden die Schlafbänke und vermuteten Schlafräume dargestellt. Weitere Pläne gewähren eine Übersicht über die Positionen der unteren Gewölbepfeiler, die Stabhalter und die Seilhalter, aber auch über die bekannten Positionen bemalter Gewölbedecksteine und Reste von Wand- und Gewölbemalereien im und am Palast. Die Arbeit diskutiert die Relationen zwischen Form, Funktion und Konstruktion der unterschiedlichen Architekturelemente. Städtebaulich definiert der Palast den Großteil der Westseite der Plaza del Palacio. In einem größeren Kontext rahmen der Palast und die Bauten 2 und 26, die drei höchsten Bauwerke auf der Spitze des Hügels von Santa Rosa Xtampak, eine größere Vier-Plaza Zone – die Plaza del Palacio, die Plaza Central, die Plaza del Cuartel und die Plaza Oriental.

## RESUMEN

“Palacio de Santa Rosa Xtampak”

El Palacio de Santa Rosa Xtampak en el estado mexicano de Campeche es uno de los complejos de edificios más impresionantes y extraordinarios de la arquitectura maya. Su distribución y la composición de sus componentes arquitectónicos son impresionantes y convierten al palacio en una obra maestra de la arquitectura.

Erwin Heine y Andreas Reiter trabajaron en 1989 y otra vez en 1992 en una nueva documentación geodésica del palacio siendo al principio estudiantes de la Facultad de Geodesia de la Universidad Técnica de Graz. Como resultado obtuvieron planos de los tres pisos con curvas de nivel de 20 cm, planos de proyección, un gran número de secciones transversales en ambas direcciones y un modelo digital tridimensional de toda la construcción incluyendo las dos singulares cajas de escalera. Heine obtuvo en 1997 el título de doctor por su trabajo que es la primera documentación digital 3D en utilizar el ciberespacio en la arquitectura maya.

Los planos de Heine y Reiter junto con las mediciones complementarias de elementos arquitectónicos como cortineros, soportes para palos, dinteles, morillos, tapas de bóveda, banquetas y nichos hechas por el autor en 1998 y 1999 han servido para hacer una documentación arquitectónica muy detallada. Los planos contienen informaciones pormenorizadas sobre los tres niveles generales del palacio. Se ha logrado una nueva documentación del palacio basándose en el levantamiento geodésico de Heine y Reiter y considerando tanto las mediciones de George F. Andrews como las de las fotos hechas por el autor —que muestran los nuevos elementos de arquitectura excavados, consolidados y reconstruidos por Reneé Lorelei Zapata Perazando lugar a una discusión sobre todos los detalles. Dicha documentación comprende más de 70 dibujos —en su mayor parte a escala—, los planos de las tres plantas y cuatro planos de proyección seguidos respectivamente de numerosas secciones que hacen que el palacio sea transparente. Esta parte del trabajo se complementa con perspectivas. El palacio podría reconstruirse con esos planos.

El análisis arroja, entre otros, los siguientes resultados: la arquitectura es una combinación de elementos de Río Bec, Chenes y Puuc. Los templos-pirámide se combinan con viviendas de diferente tamaño sobre una colina artificial con terrazas dando lugar a una mezcla de arquitectura sacra y profana. No es algo único en la arquitectura maya pero hace interesante al complejo. Las dos categorías arquitectónicas se combinan de forma muy práctica pero, frecuentemente, sorprendente. Nor-

malmente no se espera un habitáculo profano convencional con banco para dormir en el núcleo de una pirámide Río Bec con pseudoescaleras muy pronunciadas y grandes escalones (mega steps) o debajo del templo correspondiente. Básicamente puede constatarse que, a menudo, las fachadas del palacio no concuerdan con el objetivo y la función interior.

El palacio tiene siete templos-pirámide: cuatro con templos auténticos y tres con pseudotemplos (pseudo temples). Además cuenta con 21 edificios profanos exteriores: siete en la planta baja, siete en la segunda planta y siete en la tercera. Tras dichas fachadas hay 2 unidades de cuatro cuartos, 2 unidades de tres cuartos, 6 unidades de dos cuartos y 11 alojamientos de un cuarto que juntas vuelven a ser 21 unidades habitacionales de diferentes tamaños. En este caso se han contado los cuartos 35 y 36 como un cuarto. Se discuten los problemas de estática y las medidas de estabilización utilizadas por los mayas.

Las dos cajas de escalera son la única conexión real entre los tres niveles del palacio. Se encuentran perfectamente ocultas, seguramente por motivos de seguridad, detrás de pseudoescaleras, pseudotemplos y pseudohabitaciones.

La planta baja contiene numerosas piezas de spolia (botín), o sea, piezas reutilizadas procedentes de otro edificio más antiguo destruido. Algunas se han reciclado sencillamente como en las cajas de escalera. Otras se encuentran en las habitaciones 1 y 9 en posición visible como partes de una cultura de recuerdos. En la habitación 1 hay dos campos de relieves descendentes en el centro de la pared norte. En cada uno de los dos extremos de esa habitación hay una semicolumna esculpida con relieves casi de la altura de la habitación.

El cornisamento superior del perfil de la base en la habitación 9 consta de una serie de elementos de piedra en relieve con rombos arriba y franjas abajo. En el centro de la pared sur de la misma habitación hay un relieve compuesto por elementos esculpidos en relieve. Evidentemente, todos los relieves de ambas habitaciones están ensamblados mal intencionadamente. Este trabajo contiene instrucciones para el ensamblaje correcto de los bloques de relieve en la habitación 9. Los relieves mal ensamblados forman evidentemente parte de un tipo especial de cultura de recuerdos de los mayas que evoca a edificios importantes y a sus habitantes.

Lamentablemente permanecen algunas cuestiones sin respuesta. ¿Cómo es el interior de la colina artificial? ¿Por qué difieren los ejes longitudinales de las habitaciones 4 y 10 claramente de la estructura de las otras habitaciones y cuál es su objetivo debajo de la escalera principal A? ¿Hay algún resto más de un edificio anterior en ese lugar?

La forma y la construcción del palacio se conocen prácticamente por completo gracias a los hallazgos y a las conclusio-

nes inductivas. Incluso ha podido aclararse la cuestión sobre la crestería. Sólo quedan sin respuesta algunas pocas preguntas referentes a los cuatro pequeños templos en las esquinas. Las cortineros, los soportes para palos y los morillos de bóveda inferiores dan en la mayor parte de los casos claros indicios sobre la antigua función de los habitáculos.

Tiene que haber habido un plano general para la construcción del palacio. Posiblemente haya habido un modelo formado por partes diferentes que quizá habría estado formado por unidades habitacionales que en su conjunto forman el palacio. Parece ser que el palacio no lo ha construido una persona individual sino que lo han hecho varias familias influyentes de la antigua ciudad maya. Mientras que todos seguían el concepto arquitectónico general en su forma global se generaban frecuentemente divergencias en los detalles. Ello podría explicar las muchas variaciones a izquierda y derecha del eje de simetría del palacio. El ejemplo más llamativo de ello son las entradas principales a las habitaciones 1 y 9, flanqueadas en una ocasión por pilares y en la otra por columnas.

Hay listas con las diferentes nomenclaturas de las habitaciones. Ahora se han introducido denominaciones para las 21 escaleras del palacio. El trabajo contiene un plano de las habitaciones techadas pero abiertas y de las cerradas; se representan las diferentes unidades habitacionales; en un plano se representan los banquetas y los presuntos dormitorios. Otros planos más contienen una sinopsis de las posiciones de los morillos de bóveda inferiores, de los soportes para palos y de las cortineros así como también de las posiciones conocidas de las piedras de bóveda pintadas y de los restos de pinturas en paredes y bóvedas en el palacio. En el trabajo se discuten las relaciones entre forma, función y construcción de los diferentes elementos arquitectónicos.

El palacio define urbanísticamente la mayor parte del lado occidental de la Plaza del Palacio. En un contexto más grande, el palacio y los edificios 2 y 26, que son las tres estructuras más altas en la cima de la colina de Santa Rosa Xtampak, enmarcan una zona mayor de cuatro plazas: la Plaza del Palacio, la Plaza Central, la Plaza del Cuartel y la Plaza Oriental.

Traducción: Bernhard Höfele



# APPENDIX

## ACKNOWLEDGEMENTS

For his cooperation and assistance at the beginning of my work on the Palace of Santa Rosa Xtampak I wish to thank first of all George F. **Andrews**, who knew so much about Santa Rosa, especially about the Palace and who gave me nearly all his information in 1999. When he was facing his end in the year 2000 his greatest wish still seemed to be to answer all his never answered questions concerning the Palace – but all actions for an archaeological campaign at the Palace of Santa Rosa came too late for him.

I also have to thank Erwin **Heine** for providing large scale copies (1:50 and 1:100) of his ground plans, cross sections, front views, axonometries and perspectives of the Palace, most of which were already published in his doctoral thesis.

Many thanks as well to Dietmar **Klammer**, the “Institute for Technology, Strength, and Testing of Materials” as well as to the “Institute of Engineering Geology and Applied Mineralogy” at the “University of Technology” in Graz. They have checked and tested the mortar sample of the Palace.

Many thanks must also be expressed to Antonio **Benavides Castillo**; he was of great help concerning the benches of the Palace. The information of the different visitors and researchers of the Palace about its benches show a lot of discrepancies. Benavides checked them again and even found indications for a new additional bench in Room 3, as mentioned in the text.

For his committed assistance in collecting relevant publications and finding photographs of the Palace of Santa Rosa Xtampak I have to thank Karl Herbert **Mayer**. For their great help in writing the English text I thank Sally **Janschitz**, and again K. H. **Mayer**.

For their participation, cooperation, and assistance in producing this volume on the Palace of Santa Rosa Xtampak I express my gratitude to the following:

George F. **ANDREWS**(†), Eugene, Oregon, USA.,  
Antonio **BENAVIDES CASTILLO**, Campeche ciudad, México,  
Gerhard **BRANDTSTÄTTER**, Graz, Austria,  
Angeles **CERVANTES ALARCÓN de HEINE**, Vienna, Austria,  
Adele **DREXLER**, Vienna,  
Linda and William J. **FOLAN**, Campeche ciudad,  
Martin **GRABNER**, Graz,  
Daniel **GRAÑA BEHRENS**, Bonn, Germany,  
Erwin **HEINE**, Vienna,  
Nicholas M. **HELLMUTH**, Guatemala ciudad, Guatemala,  
Hermann **HENDRICH**, Vienna,  
Bernhard **HÖFELE**, Graz  
Bernhard **HOHMANN**, Graz,  
Annegrete **HOHMANN-VOGRIN**(†), Graz,  
Sally **JANSCHITZ**, Vienna,  
Sergio C. **PALACIOS CASTRO**, Campeche ciudad,  
Dietmar **KLAMMER**, Graz,  
Robert **KOSTKA**, Graz,  
Karl Herbert **MAYER**, Graz,  
Sara **NOVELO**, Campeche ciudad,  
Andreas **REITER**, Graz,  
Manuela **REITER**(†), Graz,  
Jack **SULAK**, Denver, Colorado, USA.

## GLOSSARY

### capstone

Capstones are the highest stones of corbelled vaults. They are flat and bridge the remaining distance of the two halves of a corbelled vault horizontally. They complete the stone ceiling. In some cases the most central of these capstones are painted or have a relief.

### capital

Capitals usually top round or rectangular supports of ceilings and have the function of creating a broader bearing for the ceiling.

### cast vault

Cast vaults in Maya architecture are very common and they consist of veneer stones and a core of rubble and mortar. The veneer stones have horizontal joints and make the vault look like a corbelled vault. Therefore it is not easy to distinguish between cast vaults and corbelled vaults from outside. In reality the entire vault is a huge hardened monolithic block.

### Chultun

Chultunes are water tanks which are cut into the natural limestone under courtyards and plazas. They are in most cases bottle shaped. Through the rainy period they have to collect the water from the roofs of surrounding buildings and from open spaces to be used in the dry period. Usually the openings of Chultunes were protected by stone covers with inlets. Such Chultunes are very important in areas without rivers or lakes such as at Santa Rosa Xtampak.

### colonnette

Colonnettes are small half columns without a capital. They are mainly used for the roof façades of zones of corbelled vaults. They can be plain or ornamented. In Santa Rosa Xtampak we find them only in the middle member of three-member base moldings.

### column

Large columns consist at least of a shaft and a capital. The horizontal section of the shaft must be round or polygonal, almost round. A column cannot have a square section! In such a case it would be a pillar.

### corbelled vault

Corbelled vaults consist of two halves of a vault. The stone elements corbel step by step from the two long sides of a room to the central axis of the room until they reach a distance from each

other which can be bridged by a row of flat horizontal "capstones". All corbels have horizontal joints and are well dovetailed in the core of the vault.

### core wall

Core walls are non-visible construction walls. They are provisional and are later covered by a final façade. George F. Andrews called these provisional facades "construction joints" (Andrews 1987). They are built of very rough stone material so that the additional material can be better connected with the core wall. We find them behind pseudo stairways and often in roof zones between the vault stones and the final façades.

### painted cornerstone of a medial molding

The corbelling cornerstone of a lower cornice of a three-member medial molding of a typical Maya structure is usually larger than the other stone elements of such a molding. In very rare cases these corner stones are painted on the underside (Mayer 2015MS and Stamps 1970:113, Fig.29c). The painting might represent a god and contain an inscription. They were always pre-painted and later put into the structure. For this reason part of the painting is often not visible and continues in the joint behind the façade.

### gable wall

Gable walls in Maya architecture are the two triangular wall fields above the short walls of a vaulted Maya stone room with a span vault (Hohmann 1979:36).

### half column

"Half column" is a term for stretched half cylinders on walls or in wall niches. Most of them have no capital and should therefore not be called "half column". However the term is so often used by Mayanists that it is also used in this work (see column!).

### lintel

Lintels form the upper inner face of a doorway or another wall opening. They have to carry the weight of the wall and the ceiling above or of the vault of a stone house. They are usually made of hard wood like chico zapote or palo tinto. In other cases at narrow entrances lintels can also consist of stone. In several such cases small stone corbels reduce the span and support the lintel.

### magnetic north

Magnetic north is the orientation measured by a compass. It varies with time. The difference can be several degrees within one year. Therefore someone should know the deviation for a certain location and the relevant time.

**pilaster**

Pilasters look like the relief of a pillar. In most cases pilasters have no carrying function and are more a part of the design of a wall. In most cases pilasters show 10 to 40 percent of a full pillar. In some cases the distances between true pillars was later closed leaving part of the pillars visible. In such cases the pilasters have a static function as supports.

**pillar**

Pillars are free standing supports of a ceiling, usually have a square horizontal section and often carry a capital.

**pseudo entrances**

Pseudo entrances are large flat niches in façades, usually going down to the floor level of the room behind.

**risalit**

Risalits are projecting parts of façades. Usually we find them in symmetrically composed façades symmetrically positioned as median risalits and as two corner risalits.

**roof comb**

Roof combs, "cresterías", are a very specific architectural element in Maya architecture. They are high structures on top of the roof of a building. The construction is usually hollow or in some cases even a perforated three dimensional grid. Roof combs often carry huge masks or sculptures of warriors for example. Usually their function is the visual effect, but no more. In some cases they also have a static function, as for example in Becan at the Temple-palace IV for several vaults on the fourth floor (Hohmann 1998:133 and 138).

**roof zone**

Roof zones of Maya stone houses are the façades of vault zones including medial and upper molding if there are any moldings.

**graffito**

Graffiti are drawings, which are carved with a hard sharp material into the softer wall plaster of a building.

**spoil**

Spoils are reused stone elements like reliefs or columns taken from older buildings which have been abandoned and are used as quarries.

**staircase**

Staircases are housed-in stairs.

**stairway**

Stairways are used for open air stairs.

**tablero**

Tableros are vertical or at least extremely steep rectangular standing fields with a simple rectangular projecting frame surrounding them. Usually they are built of stone. In the case of Kaminaljuyu they are made of soil. The stairways to the platform of the Palace in the North, the East, and in the South of Santa Rosa Xtampak are flanked by tableros.

**tethered capital**

There are two different types of tethered capitals. The first looks like a soft cylindrical box bound tightly half way up. This usually forms a capital as part of a column. The second looks like a soft rectangular box bound tightly half way up and forms the capital of a pillar.

**true north**

True north is the direction to the centre of the rotation axis of our globe in the North.

This can be measured at night by focusing the Pole Star. This star does not exactly define true north. Therefore you also need to measure the exact time and the exact position of the measurement. The other possibility is to measure the sun at noon and also to record time and location. In both cases you can then calculate the precise direction of true north.

**true vault**

True vaults or "key stone vaults" use the principle that all the stones of an arc with concentrically positioned wedge-shaped stones elements want to fall at the same time. Therefore they hold each other in position.

In regions with plenty of earthquakes the vault stones are often not only wedge-shaped; each stone has a special form, in most cases a double hook, which prevents the vault stones from leaving their position in case of broad cracks during an earthquake.

## BIBLIOGRAPHY

- ANDREWS, George F.  
1987 Chenes and Puuc Architecture at Santa Rosa Xtampak, Campeche, Mexico. MS., University of Oregon. Eugene, Oregon.
- 1988 Architectural Survey: Santa Rosa Xtampak. University of Oregon. Eugene, Oregon..
- 1997a Chenes and Chenes-Puuc Architecture at Santa Rosa Xtampak. *Pyramids and Palaces, Monsters and Masks, The Golden Age of Maya Architecture*, Vol. II:243-271; Labyrinthos. Lancaster. California.
- 1997b The Palace at Santa Rosa Xtampak. *Pyramids and Palaces, Monsters and Masks, The Golden Age of Maya Architecture*, Vol. II:273-320; Labyrinthos. Lancaster. California.
- 1999 Architecture of the Rio Bec Region and Miscellaneous Subjects. *Pyramids and Palaces, Monsters and Masks, Maya Architecture Vol. III*, Labyrinthos. Lancaster, California.
- ANDREWS, George F., Paul GENDROP, Víctor RIVERA, Juan Antonio SILLER, and Alejandro VILLALOBOS  
1987 Reconocimiento Arquitectónico en la Región de los Chenes, Campeche, Marzo 1986. *Consideraciones Generales*. Cuadernos de Arquitectura Mesoamericana No. 10:51-84; Paul Gendrop editor, Division de Estudios de Posgrado - Facultad de Arquitectura, Universidad Nacional Autónoma de México. México D.F..
- AVENI, Anthony F., Anne S. DOWD and Benjamin VINING  
2003 Maya Calendar Reform? Evidence from Orientations of Specialized Architectural Assemblages. *Latin American Antiquity* 14 (2):159-178.
- BENAVIDES CASTILLO, Antonio  
1992 Proyecto Santa Rosa Xtampak. *Boletín del Consejo Nacional de Arqueología*:16-18. INAH. México.
- BRAINERD, George  
1958 The Architectural Ceramics of Yucatan. *University of California Anthropological Records*, Vol. 19; University of California Press. Berkeley and Los Angeles.
- CENTENO LARA, Roberto  
2002 Diagnóstico Estructural del Palacio de Santa Rosa Xtampak, Campeche. MS.:6pp. Facultad de Ingeniería de la Universidad Autónoma de Yucatán. Mérida.
- CODEX ZOUICHE-NUTTALL  
1987 *Codices Selecti*, Vol. LXXXIV, Akademische Druck- u. Verlagsanstalt Graz-Austria. Graz.
- DE BLOOIS, Evan I.  
1970 Archaeological Researches in Northern Campeche, Mexico. Department of Sociology and Anthropology, Weber State College. Ogden, Utah, USA.
- EATON, Jack D.  
1972 A Report on Excavations at Chicanná, Campeche, Mexico. *Cerámica de Cultura Maya et al.*, No. 8. Philadelphia.
- EGGEBRECHT, Eva and Arne; Nikolai GRUBE  
1994 *Die Welt der Maya, Archäologische Schätze aus Drei Jahrtausenden*. Verlag Philipp von Zabern, Mainz am Rhein.
- FOLAN, William J.  
1989a Santa Rosa Xtampak, Campeche, Mexico; a Proposal for Investigation. MS.: 5 pp.; Centro de Investigaciones Historicas y Sociales, Universidad Autónoma del Sureste, Campeche, México. Campeche.
- 1989b Proyecto Santa Rosa Xtampak. *Boletín del Consejo Nacional de Arqueología*:44-46. INAH. México.
- 1992 Santa Rosa Xtampak; A major central palace in the Peninsula of Yucatan. *Newsletter* 21 (3):3-5. Institute of Maya Studies. Miami.
- GENDROP, Paul  
1983 Los Estilos Río Bec, Chenes y Puuc en la Arquitectura Maya. Universidad Nacional Autónoma de México, División de Estudios de Posgrado Facultad de Arquitectura, Dirección General de Publicaciones. México D.F..
- 1987 Nuevas Consideraciones en Torno a los Estilos Río Bec y Chenes. *Cuadernos de arquitectura mesoamericana* No. 10:39-49; Paul Gendrop editor, Division de Estudios de Posgrado, Facultad de Arquitectura, Universidad Nacional Autónoma de México. México D.F..

- 1997 Diccionario de Arquitectura Mesoamericana. Editorial Trillas. México D.F.
- GRAÑA-BEHRENS, Daniel
- 2002 Fechas en dos Tapas de Bóveda de Santa Rosa Xtampak, Campeche. Buletin La Pintura Mural Prehispánica en México No 17:34-38; Universidad Nacional Autónoma de México, Instituto de Investigaciones Estéticas. México D.F.
- 2004 Santa Rosa Xtampak, Campeche, y sus Inscripciones. MS.:10 pp.; Universidad de Bonn, Alemania. Bonn.
- HEINE, Erwin
- 1992 Der Einsatz der Computergraphik zur Darstellung verfallender Bauwerke am Beispiel des Mayazentrums Santa Rosa Xtampak. Diplomarbeit, Technische Universität Graz, Abteilung für Fernerkundung, Bildverarbeitung und Kartographie. Graz.
- 1993 Digital-3D-Modelling and Visualization of Ancient Maya Architecture. Institute for Applied Geodesy and Photogrammetry. University of Technology-Graz. Graz.
- 1995a Documentación y Presentación de Arquitectura en Forma Digital Tridimensional de Santa Rosa Xtampak, Campeche. Los Investigadores de la Cultura Maya 3, Tomo I:27-44. Universidad Autónoma de Campeche. Campeche.
- 1995b Digital-3D-modeling and visualization of ancient Maya architecture. In: Sion, I.G. (Ed.): Architectural and Archaeological Photogrammetry. Proceedings of the International Committee for Architectural Photogrammetry, Vol. XV, 314 p. IGFCOT Bucharest. Presented at the XV International Symposium of Architectural Photogrammetry, Sept. 22-25 1993, Bucharest.
- 1997 Die Strukturierte Datenerfassung und das Visualisierungspotential des Digitalen Bauwerkmodells; Der Palast von Santa Rosa Xtampak. Dissertation an der University of Technology at Graz. Graz.
- 2016 Die Strukturierte Datenerfassung und das Visualisierungspotential des Digitalen Bauwerkmodells; Der Palast von Santa Rosa Xtampak. Dissertation an der University of Technology at Graz. 2. überarbeitete Fassung. Graz.
- HEINE, Erwin, Robert KOSTKA, and Andreas REITER
- 1990 Main Palace of Santa Rosa Xtampak; A geodetic-photogrammetric documentation. Close range photogrammetry meets machine vision; A. Gruen, E. Baltsavias, editors; International Archives of Photogrammetry and Remote Sensing, Vol.28, Nr. 1, Com.V: 67-76. Zürich.
- HEINE, Erwin und Andreas REITER
- 1990 Santa Rosa Xtampak: A Maya city recorded by geodetic-photogrammetric means. In: Mexican Vol.XII, Nr.6, p.104-105.
- HELLMUTH, Nicholas M.
- 1989a First Season Photography and Analysis of Standing Architecture at Santa Rosa Xtampak, Campeche, Mexico. Vol. I, Foundation for Latin American Anthropological Research. Winter Park, Florida.
- 1989b An Introduction to Chenes, Puuc and Rio Bec Palaces: the Example of Three Palaces at Santa Rosa Xtampak, Campeche. Mexico. Vol. II, Foundation for Latin American Anthropological Research. Winter Park, Florida.
- 1989c Wood that has Lasted one Thousand Years: Lintels and Vault Beams in Maya Temples and Palaces, the Example of the Main Palace, Santa Rosa Xtampak, Campeche. Vol. III, Foundation for Latin American Anthropological Research. Winter Park, Florida.
- 1989d Advances in Knowledge of the Monumental Architecture of Santa Rosa Xtampak; Based on Photography and Mapping of June-July 1989. Vol. IV, Foundation for Latin American Anthropological Research. Winter Park, Florida.
- HOHMANN, Hasso
- 1978 Die Bauwerke von Copán. Dr.-Dissertation, Technische Universität Graz. Graz.
- 1979 Gewölbekonstruktionen in der Maya-Architektur. Mexican. Vol. I. Nr. 3: 33-36. Berlin.
- 1984 Hängematten und Hängebrücken im Präkolumbischen Mesoamerika? Archiv für Völkerkunde. Nr. 38:1-5. Wien.
- 1989 Representations of Litters which are Copies of Buildings or of Seating Accomodations. Archiv für Völkerkunde 43:89-100, Museum für Völkerkunde, Wien.

- 1991 "Türen" im Präkolumbischen Amerika. *Archiv für Völkerkunde* 45:61-67, Museum für Völkerkunde. Wien.
- 1998 A Maya Palace in Mexico – Structure IV at Becan, Campeche; Documentation and Reconstruction of Planned Architecture – Analysis of Form, Construction, and Function. Academic Publishers Graz. Graz.
- 2000 Statik eines Maya-Steingebäudes; Xkipché, Bauwerk A4, Raum 1A. *Votis XX Solutis – Jubiläumsschrift der Archäologischen Gesellschaft Steiermark*; editor: Manfred Hainzmann, *AGST-Nachrichtenblatt* 1-2/1999:93-113; Academic Publishers Graz/Austria. Graz.
- 2001 Documentation of a Maya Building in Chunchimai. *Mexicon* Vol. XXIII, Nr. 6:136-138. Markt Schwaben.
- 2003 Documentación de un Edificio Maya en Chunchimai. *Investigadores de Mesoamerica* Nr. 3:75-81, Universidad Autónoma de Campeche, INAH. Campeche, Cam., México.
- 2005 Culture of Memory and Maya Architecture: Architectural Documentation and Interpretation of Structure 1 of Chunchimai 3. *Anthropological Notebooks*, year XI:101-111; *Contributions to Maya Archaeology*, Ivan Šprajc, guest editor; Društvo Antropologov Slovenije. Ljubljana.
- 2006 El Palacio de Santa Rosa Xtampak, Campeche: documentación y reconstrucción. *Los mayas de ayer y hoy, Memorias del Primer Congreso Internacional de Cultura Maya*; Alfredo Barrera Rubio y Ruth Gubler: editors, Tomo I:341-353. Mérida, Yucatán, México.
- 2013 Kleiner Palast von Kansah. *Nachrichtenblatt 2013 der Archäologischen Gesellschaft Steiermark*:37-44. Graz.
- HOHMANN, Hasso and Annegrete VOGRIN  
1982 Die Architektur von Copan (Honduras); Vermessungs-Plandarstellung-Untersuchung der baulichen Elemente und des räumlichen Konzepts. Akademische Druck- u. Verlagsanstalt Graz/Austria. Graz.
- LEYSINGER, Claudine  
2008 Collecting Images of Mexico: A Polychromatic View Through the Lens of Teobert Maler, 1860-1910. Ph.D.-dissertation, Columbia University. New York.
- MALER, Teobert  
1902 Yukatekische Forschungen. *Globus*, Vol. 82, No.13, pp. 197-230. Braunschweig.
- 1997 Península Yucatán. Aus dem Nachlass herausgegeben von Hanns J. Prem. Gebr. Mann Verlag; Monumenta Americana, Berlin.
- MAYER, Karl Herbert  
1983 Gewölbedecksteine mit Dekor der Maya-Kultur. *Archiv für Völkerkunde*, Vol. 37:1-62, Museum für Völkerkunde. Wien.
- 1984 Major Maya Art in a Mérida Collection. *Cuadernos de Arquitectura Mesoamericana*, No. 1, pp. 40-47, UNAM. México D.F..
- 1987 Two Maya Painted Stones from Campeche, Mexico. *Mexicon*, Vol. IX, No. 5: 99-100, Verlag Anton Saurwein. Möckmühl.
- 1989 An Unpublished Maya Inscription at Santa Rosa Xtampak, Campeche. *Cuadernos de Arquitectura Mesoamericana* 11:25-28, UNAM. México D.F..
- 1993 Mural Paintings at Santa Rosa Xtampak, Campeche, Mexico. MS.:6pp. Graz.
- 1994a Maya Inscriptions from Hobomo, Campeche, Mexico. *Mexicon Occasional Publications*, No. 2. Verlag Anton Saurwein. Möckmühl.
- 1994b Two Unpublished Paintings from Santa Rosa Xtampak, Campeche. *Mexicon* Vol. XVI, No.4:68-70. Verlag Anton Saurwein. Möckmühl.
- 2015 Painted Cornerstones of Medial Molding. MS. Graz.
- MERK, Stephan  
2015 El Delfin, a Newly Discovered Maya Site in the Area between the Chenes and Rio Bec Region. *Mexicon* Vol. XXXVII, No.2:39-43. Verlag Anton Saurwein. München.
- MORALES LÓPEZ, Abel and William J. FOLAN  
2005 Santa Rosa Xtampak, Campeche: su patrón de asentamiento del Preclásico al Clásico. *Mayab* 18:5-16, Sociedad Española de Estudios Mayas. Madrid.

- MORLEY, Sylvanus Griswold  
1948 Check List of the Corpus Inscriptionum Mayarum and Check List of All Known Initial and Supplementary Series. Division of Historical Research, Carnegie Institution of Washington. Cambridge, Massachusetts.
- MORLEY, Sylvanus Griswold and George W. BRAINERD  
1956 The Ancient Maya. 1st edition 1946, Stanford University Press. Stanford, California.
- MURPHY, Francis S.  
1961 Behind The Mike. The Oregonian Jan. 11, 1961. Portland, Oregon.  
1988 Dragon Mask Temples in Central Yucatán (1952-1972). Scribe Ltd., Hong Kong.
- POLLOCK, Harry E. D.  
1970 Architectural Notes on Some Chenes Ruins. Monographs and Papers in Maya Archaeology, William R. Bullard Jr., Editor. Papers of the Peabody Museum of Archaeology and Ethnology, Harvard University, Vol. 61:1-87. Cambridge, Massachusetts.
- PREM, Hanns J.  
1987 Santa Rosa Xtampak: Salvage Work on the Palace. Mexican Vol. IX, Nr. 6:121. Verlag Anton Saurwein. Möckmühl.
- PROSKOURIAKOFF, Tatiana  
1946 An Album of Maya Architecture. Carnegie Institution of Washington, Publication 558. Washington, D.C..  
1962 Civic and Religious Structures of Mayapan. Mayapan Yucatan, Mexico, Pollock et al. Editors; Carnegie Institution of Washington, Publication 619 (pt. 2):87-163. Washington, D.C..
- REITER, Andreas  
1994 Der Einsatz Geodätisch-Photogrammetrischer Methoden zur Dokumentation Verfallender Bauwerke am Beispiel des Maya-Zentrums Santa Rosa Xtampak. Diplomarbeit, Technische Universität Graz, Abteilung für Fernerkundung, Bildverarbeitung und Kartographie. Graz.
- RUPPERT, Karl and John H. DENISON, Jun.  
1943 Archaeological Reconnaissance in Campeche, Quintana Roo and Peten. Carnegie Institution of Washington; Publication 543. Washington D.C..
- STAMPS, Richard B.  
1970 A Study of Late Classic Maya Architecture at Santa Rosa Xtampak: an Archaeological Site in the Chenes Region of the Yucatan Peninsula. A thesis presented to the Department of Anthropology and Archaeology, Brigham Young University. Provo, Utah, USA.
- STEPHENS, John L.  
1843 Incidents of Travel in Yucatan. Vol. 2, Harper and Brothers. New York.
- SULAK, Jack  
1993 Notes on "Room-#5-Suite" of the South-East Quadrangle of the ruins at "Santa Rosa Xtampak", Campeche, Mexico. MS.: 38 pp..
- WAUCHOPE, Robert  
1938 Modern Maya Houses; a Study of their Archaeological Significance. Carnegie Institution of Washington; Publication 502. Washington, D.C.
- ZAPATA PERAZA, Renée Lorelei  
1994 Santa Rosa Xtampak: Inicio de su Restauración Arquitectónica. Los Investigadores de la Cultura Maya, 2:161-173; Universidad Autónoma de Campeche. Campeche.  
2005 Santa Rosa Xtampak, Capital en la Región de los Chenes. Arqueología Mexicana 75:54-57. México D.F..  
2007 Nuevas Tapas de Bóvedas Pintadas en Santa Rosa Xtampak, Campeche, México. Mexican Vol. XXIX, No.1:1-3. Verlag Anton Saurwein. Markt Schwaben, Germany.

## THE AUTHOR

The author was born in Ettlingen, Germany in 1943. He studied Architecture at the University of Technology (TU) in Graz and Ethnology at the University of Graz. He is an expert on historic ensembles. Since 1978 he has worked as an architect and urban designer for the Municipality of Graz and for a number of smaller towns in Styria. In addition he taught settlement patterns and urban planning at the University between 1993 and 1997; since then he has also taught History of Architecture at the TU Graz.



Since 1968 the author has investigated the pre-Columbian cultures of the Americas in general and specialized in Maya architecture. In 1978 he wrote his doctoral thesis on the structures of the centre of Copan, Honduras. In 1997 he qualified as a university lecturer and in 1998 he was invited to the Universidad Nacional Autónoma de México as a guest professor.

The author has published numerous peer-reviewed articles and several book publications concerning the history of architecture - pre-Columbian, Islamic or European history of architecture.





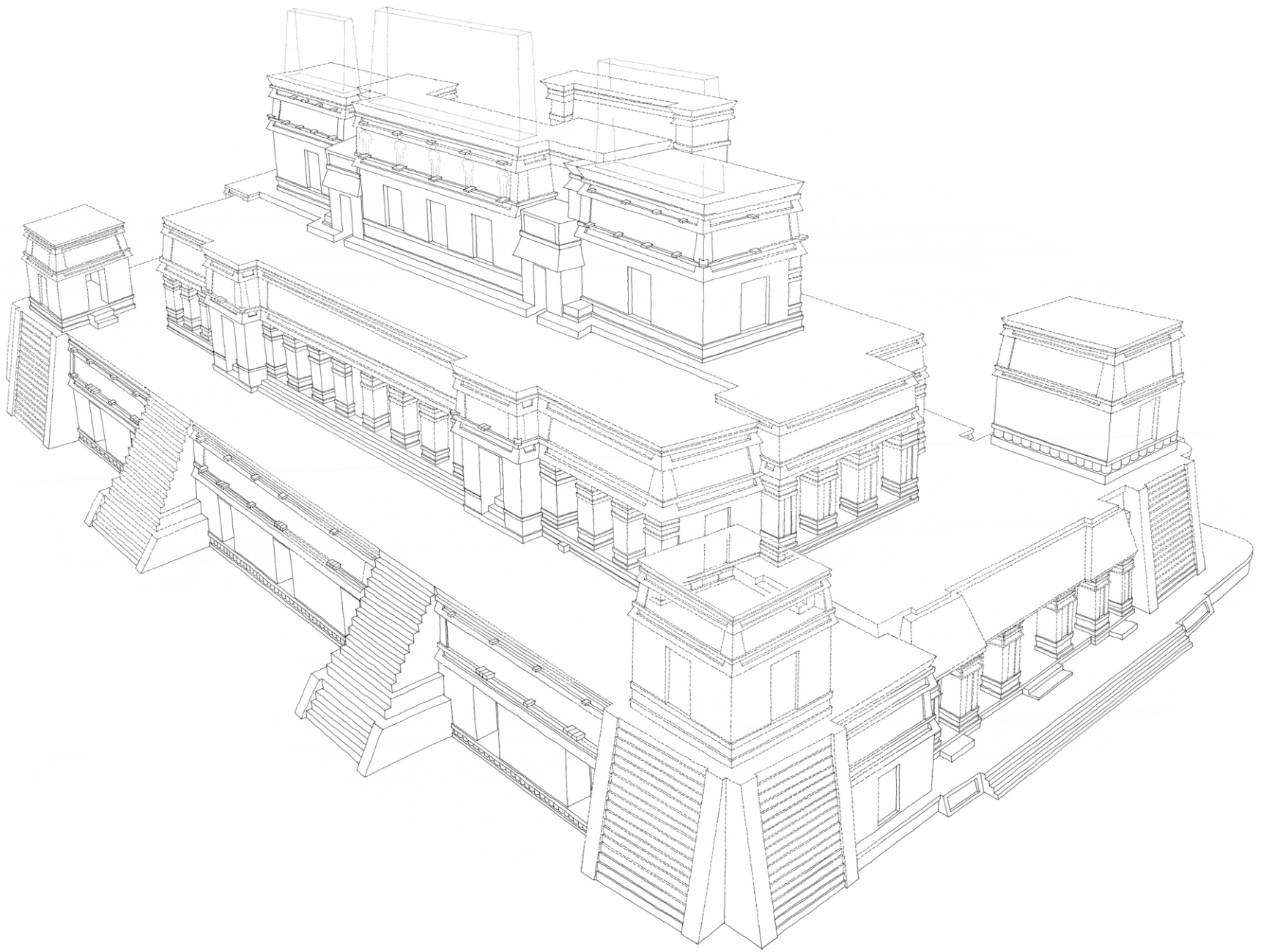



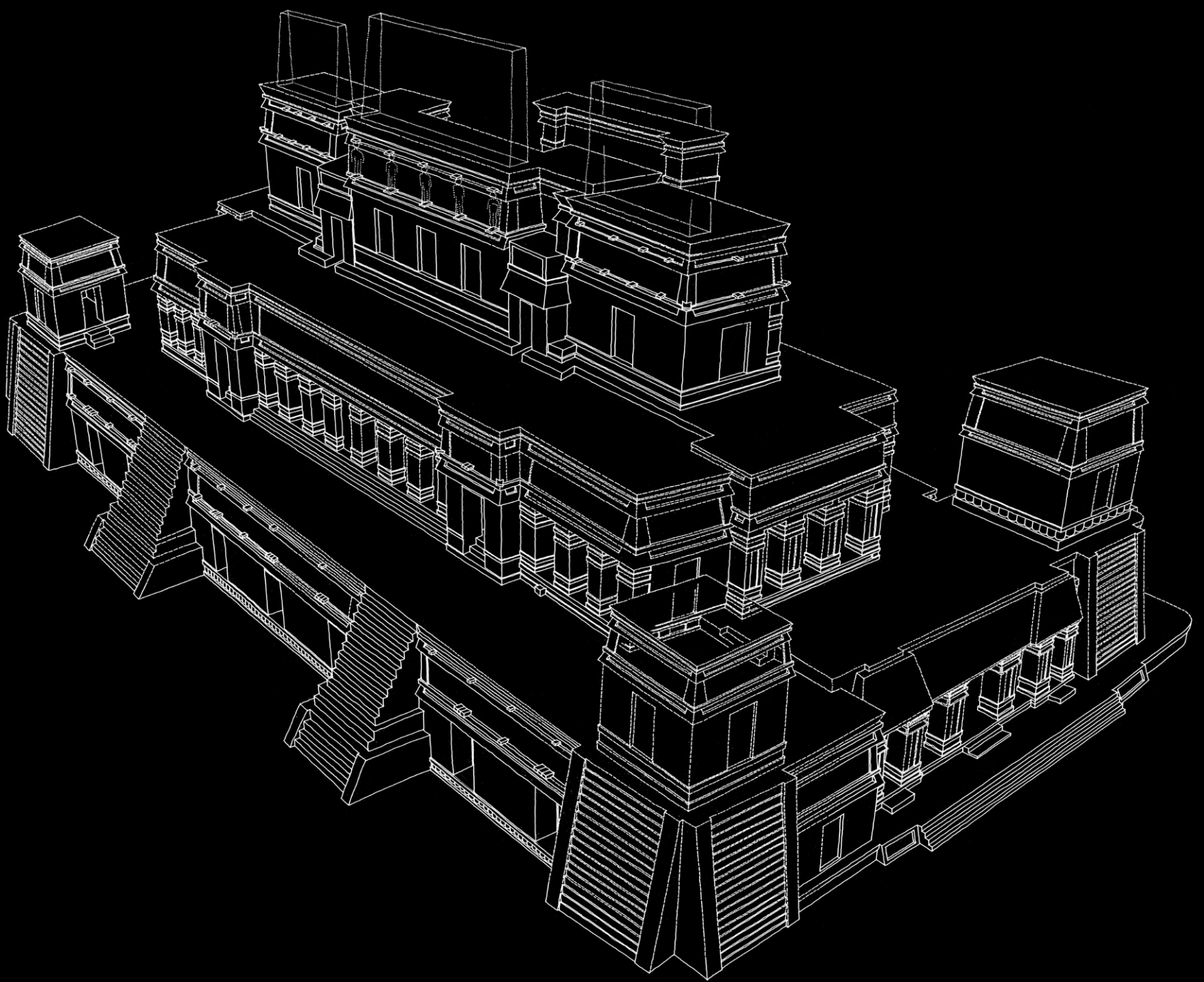

ISBN 978-3-901519-44-4  
ISBN 978-3-85125-457-0