

The Sa'dan-Toraja

*A Study of Their Social Life and
Religion. I: Organization, Symbol
and Beliefs*

Hetty Nooy-Palm

BRILL

THE SA'DAN-TORAJA

In Remembrance of Dr. Henk van der Veen

VERHANDELINGEN
VAN HET KONINKLIJK INSTITUUT
VOOR TAAL-, LAND- EN VOLKENKUNDE

87

HETTY NOOY-PALM

THE SA'DAN-TORAJA

A STUDY OF THEIR SOCIAL LIFE AND RELIGION

I

ORGANIZATION, SYMBOLS AND BELIEFS



THE HAGUE - MARTINUS NIJHOFF 1979

© Copyright 1979 by
*Koninklijk Instituut voor Taal-, Land- en Volkenkunde,
Leiden, the Netherlands.*

*All rights reserved, including the right to translate
or to reproduce this book or parts thereof in any form.*

Printed in the Netherlands.

ISBN 90.247.2274.8

PREFACE

The original incentive for this monograph derives from a brief period of research in 1949-1950. At the time I made a series of notes primarily concerning the material culture of the Sa'dan-Toraja, a people inhabiting part of the region which is now designated as Sulawesi Selatan (South-Celebes). Political unrest during the fifties disrupted my fieldwork, and I left the region.

In 1965 I returned to my early notes. Assisted by Dr. H. van der Veen, I traced supplementary and more detailed information in available literature. Dr. Van der Veen, an expert not only in the language but also in the ethnography of the Sa'dan-Toraja, was once himself engaged in writing an ethnographic study of this people. He had already amassed an extraordinary quantity of material when war broke out; during the subsequent era of the Japanese occupation of Indonesia most of his data were lost. Some articles and papers, however, survived. Thanks to Dr. Van der Veen's incredible memory, it proved possible with the passage of time to flesh out his data and my early field-notes to a greater and greater extent. Nevertheless gaps remained. Dr. Van der Veen then proposed the possibility of my returning to the scene itself; his suggestion appeared realizable, for, by now, the political climate for fieldwork had improved considerably. I had the opportunity to continue my investigations in Tana Toraja during four successive visits of a few months' duration: September-November 1966, September-December 1969, September-December 1970 and November-January 1972-1973.

Now that this first volume is ready for publication I wish first of all to express my gratitude to the late Dr. H. van der Veen, to whose memory this volume is dedicated. He died on the 19th of October 1977 at the age of 89. He was not only a fine scholar; he also was a man of profoundly humane feelings and great kindness. His enduring friendship over the years of our cooperation provided more than mere encouragement. It was an honour.

To the institutions which, by their financial and moral support, enabled me to carry out the necessary fieldwork and to publish the

results in the form now presented to the reader I am deeply indebted: first, the Royal Tropical Institute at Amsterdam which paid my salary during my fieldtrips, and kindly gave me the opportunity for working out my notes, providing me continually with indispensable secretarial and technical aid; second, WOTRO, the Netherlands Foundation for the Advancement of Tropical Research, which subsidized my fieldtrip of 1969, and later met the costs of translating the present volume into English; third, the Royal Institute of Linguistics and Anthropology at Leiden (the *Koninklijk Instituut voor Taal-, Land- en Volkenkunde*) which accepted this volume for publication in its *Verhandelingen* (Transactions); fourth the *Treub Maatschappij* (the Society for Scientific Research in the Tropics) at Utrecht which subsidized my fieldtrips of 1966 and 1970; and fifth, the Wenner Gren Foundation for Anthropological Research which provided a grant-in-aid for my final trip in 1972-1973.

For moral support, I wish to thank first of all LIPI (*Lembaga Ilmu Pengetahuan Indonesia*), the Indonesian Institute for the Advancement of Science at Jakarta. In this context I wish to extend personal thanks for their friendly cooperation and helpfulness to Prof. Dr. R. M. Koentjaraningrat, Ms. Sjamsiah Achmad, Mr. Teuku Mohammad M. Radhie, Mr. Suhartono Sudargo, and Mr. Napitupulu.

Among the Toraja who offered me significant support during my research, I wish to mention first of all the late Allo Rante, also called Ne' Sangga, (he died December 16, 1974) and his nephew Bua' Sarungallo, both from Kesu'. Valuable assistance also came from Misters F. K. Sarungallo, Roson Panimba, J. Tammu, L. Pakan and the families Palete and Pasaka, also from Kesu'; from Mr. Lebang (Ne' Muda), his son Thana Lebang and Enoch Palo'lean Amba Titedok, one-time *to minaa* of Nonongan; from Danduru Sampe Litak, Izak Sorreng Palajukan of Buntao'; from Puang W. P. Sombolinggi' and Puang Paliwan Tandilangi' of Sangalla'; from Misters J. Somba, S. S. Mangende', L. T. Tangdilintin, J. Lobo and Drs. C. Salombe, all of Ujung Pandang.

The help of Mr. Tampubolon, then *bupati* of Tana Toraja, was of particular importance. I also like to thank the families De Heer, Van Heest, Kobong and Palamba. Mrs. J. M. Eggink and the family Ch. B. Tan-Karundeng kindly offered me accommodations and thereby spared me considerable daily cares. I also like to thank W. Meyer, physician in Ujung Pandang.

While I was occupied with making my material presentable,

Dr. Van der Veen lent comfort and aid. He made available with disinterested generosity, vast quantities of the information at his disposal. Upon his instigation many litanies and songs are included in the text; the translations come from his hand. Various annotations and clarifications in the following pages can also be attributed to him. For his kindness I am deeply appreciative.

The especially vivid photographs rendering landscapes and depicting the Toraja at various activities were taken by Mr. F. van der Kooi in 1937 and presented to Dr. H. van der Veen at the time for scientific use. Drawings and diagrams in this article are the work of Mr. Subokastowo, Ms. Suzanne Taub, Mr. S. Pronk, Mr. Kees van Dam, Mrs. A. Ruygrok-Haakma Wagenaar and Mr. Rob Berkel.

To Dr. Donald Bloch who translated the text into English, and to Prof. J. van Baal who assumed the burden of editorship, I owe many thanks.

For their contributions to what follows I would also like to thank Mss. L. van den Bovenkamp-Rodrigues Nunes, R. de Graaf, F. G. C. Rincker and U. Veenstra.

The present volume is the first of two. It consists of two parts, Part I dealing with the natural surroundings and the social and territorial organization of the Sa'dan-Toraja, Part II with religious notions, natural and material symbols, and priestly organization. Volume II, which will hopefully appear in due time, will contain a description of Sa'dan-Toraja rituals, those associated with the East in Part III, and those with the West in Part IV.

One of the difficulties with which I had to cope in my research, was the variegation of Toraja society. These Toraja number some 310,000 people, who occupy an area of 3,242 square km. Although their ethnic unity is beyond doubt, local variations of customs and rites are numerous. I confined my fieldwork to the districts of Buntao', Kesu' (with Nonongan), Tikala and Riu, Tondon, and Sangalla' (Sangalla' is one of the three districts formerly ruled by a prince).^{*} Most of the data here presented come from these six districts.

In my fieldwork I relied heavily on the use of unstructured interviews. In conversations I readily could profit from the clear insight which many Toraja have into their own culture. They quickly understood

^{*} Throughout this book the term district is used in the sense of an *adat*-unit, a community incorporating several thousand people who live in a varying number of villages which belong together traditionally.

the gist of my inquiries. Many drawings, slides, photographs, films and tape recordings enabled me to re-examine various experiences at leisure once back in The Netherlands; these constituted a great and welcome aid to my memory.

One of my problems was (and is) how to discover the principal configurations which dominate the patterns of Sa'dan-Toraja cultural life. I sincerely hope that this book will lead to a discussion of what, in fact, the main themes are which give structure to the rather confusing wealth of their ritual and ceremonial forms. On my part, I have tried to make a contribution to further studies by giving special attention to rituals and symbols and how these manifest themselves within the material culture. One thing I quickly learned: a structural interpretation of the materials which I accumulated does not merely reflect the predisposition of the ethnographer. Many Toraja informants seemed 'born structuralists' in the sense that they were conscious of oppositions within their culture. This made it of special interest to try to determine how a Toraja perceives this structure and, since he lives as it were together with his ancestors, how he conceives of the relation between the world of the living and the world of the dead.

Finally, I must add a note on spelling. Throughout this work we adhere to modern Indonesian spelling which differs in certain regards from the spelling formerly introduced by the Dutch: j stands for the old dj; c for tj; y for j. This spelling is also applied to Toraja words. There is no j (dj) or c (tj) in their language, so that they speak of themselves as Toraya.

CONTENTS

Preface		V
 PART I. SOCIAL AND POLITICAL STRUCTURE		
I.	<i>The Sa'dan-Toraja and their environment</i>	1
I.1	Introduction	1
I.2	The land	2
I.3	Present-day administration	3
I.4	The name Sa'dan-Toraja; differentiation from neighbouring ethnicities	6
I.5	Toraja history, a résumé	8
I.6	Economics	12
I.7	A critical appraisal of available literature about the Sa'dan-Toraja	13
	Annex Ia: Population of Tana Toraja in 1930	20
	Annex Ib: Population of Tana Toraja in 1975	20
 II. <i>Kinship structure</i>		
II.1	Descent groups	22
II.1.1	Ancestor-focus	24
II.1.2	Status ramagees	26
II.2	Ego-focus: the kindred	27
II.3	Affinal kin (<i>rampean</i>)	27
II.4	Kinship terminology	28
II.4.1	Consanguines	28
II.4.2	Affines	30
II.5	Marriage	30
II.5.1	Forms of marriage; marriage prescriptions and restrictions	30
II.5.2	The <i>kapa'</i>	34
II.5.3	Children in the <i>adat</i> -system	37
II.6	Summary	41
	Annex IIa: Kinship terminology	41
 III. <i>The classes</i>		
III.1	Class division in Kesu'	43
III.1.1	Kesu'	43
III.1.2	Nonongan	52
III.1.3	Titles and duties	53
III.2	Classes in Sangalla'	54
III.3	Summary	57
 IV. <i>Traditional socio-political organization</i>		
IV.1	Traditional political units	58
IV.1.1	<i>Adat</i> -communities	59
IV.1.2	The <i>bua'</i> - or <i>penanian</i> -communities	60

IV.1.3	<i>Patang penanian</i> ; other <i>penanian</i> -leagues	61
IV.1.4	The <i>lembang</i>	62
IV.1.5	Buntao', an autonomous <i>patang penanian</i>	69
IV.1.6	The federation of Kesu'	72
IV.1.7	The principedom of Sangalla', one of the Tallulembangna	79
IV.1.8	Ma'kale and Mengkendek	91
IV.2	The village: functions	92
IV.2.1	Introduction	92
IV.2.2	Kinship in the settlement	94
IV.2.3	Local divisions in connection with the offices which village residents hold	94
IV.2.4	Summary	104
PART II. RELIGIOUS NOTIONS, SYMBOLS AND FUNCTIONARIES		
V.	<i>Prominent characteristics of Sa'dan-Toraja religion</i>	107
V.1	Introduction	107
V.2	Principles of classification in Sa'dan-Toraja cosmology	109
V.3	The gods	115
V.4	Souls, ancestors and spirits	121
V.4.1	Souls (<i>bombo</i>)	121
V.4.2	Ancestors	124
V.4.3	Spirits (localized)	126
V.4.4	Dangerous spirits and dangerous people	126
V.5	The concepts of spirit and soul; conclusion	128
	Annex Va: Schematic representation of Sa'dan-Toraja cosmology	129
	Annex Vb: The family tree of the gods (Kesu')	132
VI.	<i>Mythology</i>	133
VI.1	Myths about the creation of the universe and the institution of rituals	134
VI.1.1	Kesu': <i>Passomba Tedong</i> , the consecration of the buffalo	134
VI.1.2a	The creation myth as handed down in Riu	139
VI.1.2b	The creation myth from Tikala	144
VI.2	Myths telling about the arrival of the ancestors on earth and the adventures of their descendants	145
VI.2.1	The <i>to manurun</i> in the <i>puang</i> -regions: Tamborolangi' Lakipadada	145
VI.2.1a	Tamborolangi'	145
VI.2.1b	The adventures of Lakipadada	148
VI.2.2	The <i>to manurun</i> in Kesu'	153
VI.2.2a	Manaek and Polopadang	153
VI.2.2b	Polopadang and Deatanna	154
VI.2.3	The <i>to manurun</i> in Riu	156

VI.2.4	The arrival of the ancestors from the island of Pongko'	159
VI.3	Myths concerning the consequences of incest . . .	159
VI.4	Miscellaneous myths	161
VI.4.1	<i>Ulelean</i> ; introduction	161
VI.4.2	Tales of thievery and the underworld	163
VI.4.2a	The tale of Pong Sumbung Sare Pio	163
VI.4.2b	The myth of Marampio Padang	163
VI.4.3	Tulangdidi and Bulu Pala'	166
VI.4.3a	Tulangdidi'	166
VI.4.3b	Bulu Pala'	168
VI.4.4	Till Eulenspiegel tales	171
VI.4.5a	The myth of Pano Bulaan	173
VI.4.5b	Rangga Bulaan	175
VII.	<i>Animals and plants in ritual and myth</i>	184
VII.1	White and pied buffaloes	184
VII.1.1	Colour, markings and other characteristics	184
VII.1.2	The family tree of the <i>kerbau</i>	192
VII.1.3	The <i>kerbau</i> in art and in ritual	193
VII.1.4	The buffalo as a symbol of the ramage's power and wealth	200
VII.1.5	The division of the meat	202
VII.1.6	<i>Pemanala</i> ; the parts of the <i>pesung</i>	206
VII.2	The pig	207
VII.2.1	Division of the meat after the sacrifice of a pig in Kesu'	208
VII.3	The chicken	209
VII.4	Other birds	213
VII.5	The dog	214
VII.6	The cat	215
VII.6.1	Beliefs and categories	215
VII.6.2	Prohibitions and customs	217
VII.7	The snake and the eel	218
VII.8	The tree of life	219
VII.9	The <i>bate manurun</i> , the 'flag' which came down from heaven	221
VII.10	Rice	222
VII.11	Millet	224
VII.12	Maize	224
VII.13	The <i>tabang</i> (<i>Cordyline terminalis</i>): bloodwort	225
VII.14	<i>Langsat</i> (<i>langsa'</i> , <i>Lansium domesticum</i>)	226
VII.15	<i>Induk</i> (sugar palm, <i>Arenga saccharifera</i>)	226
VII.16	The banana	226
VII.17	<i>Ipo</i>	227
VII.18	<i>Bilante</i> (<i>Homolanthus populneus</i>)	228
VII.19	<i>Suke bombo</i>	228
VII.20	Cotton and other plants	228

VIII.	<i>Material symbols</i>	231
VIII.1	The <i>tongkonan</i>	231
VIII.1.1	General description of the <i>tongkonan</i> ; function	231
VIII.1.2	The internal layout of a <i>tongkonan</i>	237
VIII.1.3	Woodcarving; special motifs	238
VIII.1.4	The <i>a'riri posi'</i>	240
VIII.1.5	The <i>ampak bilik</i> or <i>ruma-ruma</i>	241
VIII.1.6	The <i>tongkonan</i> as a cosmic symbol	244
VIII.1.7	The house in history and myth; and the ritual of its construction	245
VIII.2	The ricebarn	252
VIII.3	Other symbols: <i>kandaure</i> , swords, krisses, sacral textiles and drums	255
VIII.3.1	<i>Kandaure</i>	255
VIII.3.2	Swords	256
VIII.3.3	Krisses and other weapons	256
VIII.3.4	Sacral cloths	257
VIII.3.5	Drums	259
VIII.4	The grave, 'the house from which no smoke rises'	259
VIII.5	The <i>tau-tau</i> (effigies)	261
VIII.5.1	Manufacture of a <i>tau-tau</i>	261
VIII.5.2	Function of the <i>tau-tau</i>	262
VIII.6	Megaliths	263
VIII.6.1	Description	263
VIII.6.2	The raising of a monolith	265
VIII.6.2a	<i>Mangriu' batu</i> , the hauling of a monolith in Kesu'	265
VIII.6.2b	In Sangalla'	266
VIII.6.3	Other stones	268
VIII.7	Sacrificial shrines	269
VIII.7.1	Substitutes for the celestial ladder	269
VIII.7.2	Other shrines and receptacles	271
IX.	<i>Priests</i>	274
IX.1	The <i>to minaa</i>	275
IX.2	The <i>to menani</i>	279
IX.3	The <i>to indo' padang</i>	279
IX.4	The <i>to mebalun</i>	280
IX.5	The <i>to burake</i> : the <i>to burake tattiku'</i> and the <i>to burake tambolang</i>	282
IX.6	The <i>to ma'dampi</i>	289
IX.7	The <i>burake</i> and the priests of neighbouring peoples; Summary	292
Notes	294
Glossary and Index	306
Bibliography	327
Photographs		
Appendix		

PART I

SOCIAL AND POLITICAL STRUCTURE

CHAPTER I

THE SA'DAN-TORAJA AND THEIR ENVIRONMENT¹

I.1 Introduction

It is market day. Women and men hurry along at a brisk jogtrot to the market, following on each other's heels, a single file. It is their heavy loads, the Toraja say, which force the pace. Women are clothed more or less alike with a *sarong* around the waist or higher up under the arms, worn together with a modern blouse or a more traditionally cut jacket, sometimes with very tight short sleeves. The large sunhat, so characteristic of Sa'dan-Toraja women (with the exception of women from the district of Mengkendek who wear a piece of folded black cloth on their heads) shades their heads. A basket rides each woman's back, so heavily laden that the bearer must bend under the weight. To displace part of the burden onto the head, a strap is fastened to the basket and looped about the forehead. One woman, without anything to carry, proceeds upright; without doubt she is from a good family. Men on their way to the market are less uniform in their attire. Some wear short trousers, some long — these have replaced the traditional loin cloth — and on their heads they have modern hats, some with a brim, some not. One or two individuals still have bound their hair with a band of bamboo. The *kain* remains in evidence, mostly worn over the shoulder or knotted around the waist. Men, too, bear heavy loads, a pig, perhaps, or a cluster of bananas which dangle from a stick over the shoulder.

However fond people are of talk at other times, and laughter, few sounds now pass their lips. The only thing that interests them at the moment is prices. "*Pira?* How much?" those who pass by on their way back from the market are asked. What is the trade like in commodities bought at the *pasar*? — commodities which those who pose the question may perhaps intend to buy or sell themselves. No one has an eye for the scenery. Neither for the green rice fields — only when the rice is almost ripe will the market-goer cast a curious eye over the crop — nor for the *sawahs* submerged under water where white herons wade.

Small dark green islands dot the watery plane composed of irrigated farmland. These are woods, mostly clumps of bamboo, their topmost leaves etched like ostrich feathers against the sky. They mark the boundaries of compounds. Not only bamboo but varieties of palms and fruit trees surround the dwellings which, somewhat scattered, stand hidden from the eye on the 'green' islands. Opposite every house there is at least one storage barn for rice. Houses and barns are of the same form. Both have saddle roofs with the extremities of the ridge turned upwards. Their appearance is reminiscent of proas with the rising curve of their prows. They recall the myth which tells how the ancestors of the Toraja reached their present homeland in ships.

Steep limestone formations tower up out of the flat *sawahs*. The rippled summits of these rocks stand out in silhouette. Wind and water have gouged out their irregular contours. Men have applied hands even to the stone. In walls which are often perpendicular, there are square niches hollowed out, sometimes as much as a hundred meters above ground. A small wooden door decorated with a stylized water buffalo head seals each limestone chamber. The dead repose behind these doors, far above the living. Lifelike wooden puppets, almost the size of a man or woman, images of the dead, preserve memory of those who have perished; they either stand on separate shelves hewn from the rock or else preside at the entrance to the graves themselves. With outstretched hands, palms skywards, they plead for a gift from the living, their descendants.

1.2 The land

Tana Toraja — the land of the Toraja — is at present the name given to the region inhabited by the Sa'dan-Toraja. It is situated in the northern part of the southwestern 'arm', the southwestern peninsula, of the irregularly shaped island of Sulawesi, the former Celebes, one

of Indonesia's big islands. The description of the landscape sketched above could apply to a vast portion of Tana Toraja with minor alterations; there are also, however, places such as Rembon, Nanggala and Mengkendek, without limestone outcrops. Some of the area is composed of calcareous formations and tuffs; the mountain Sesean (2,176 m), however, is built of basalt. The terrain is mountainous, a plateau, in fact, girdled with mountain ridges through which the upper reaches of the Sa'dan River courses at an altitude of approximately 800 meters. These waters flow down through two valleys: in the southern one lies the town of Makale, in the northern one that of Rantepao. Lesser branches of this river descend through smaller valleys. The mountain ranges, which are in part comprised of limestone ridges, attain heights of between 1,300-1,600 meters. Some summits, however, like that of Sesean, jut abruptly higher.

Given the rugged relief of the area, it is difficult to speak with any generality about climate in Tana Toraja; temperature fluctuates radically with altitude. Rains commence in November and last through January; a short, less intense rainy season spans the months of March and April. From May until the end of October it is dry. Yet, on occasion the rains may be early or late.

I.3 Present-day administration

Tana Toraja (sometimes shortened to 'Tator') is part of the Republic of Indonesia. As an administrative unit it is designated as a *kabupaten* (regency). The area lies between 2°40' and 3°25' south latitude and 119°30' and 120°25' east longitude. Its total area, roughly one tenth the size of The Netherlands, is 3,178 sq. km. The regency is subdivided into nine *kecamatan* (see Map 1). Each *kecamatan* is composed of still smaller administrative units, *desa*, villages or clusters of villages. Matters are further complicated by combining villages into territorial units which — again — are called *lembang*. These new *lembang* do not coincide with those of the Dutch colonial administration which had only about half as many of them; today's administration includes 65 *lembang*.

During most of the period of Dutch rule Tana Toraja was a section of the subdivision of Luwu,² a former kingdom. It became an administrative entity in its own right, Tana Toraja, for the first time shortly after World War II and has retained its name until today. When The Netherlands held power, there were 32 districts, or *lembang*, in Tana Toraja (see Map 2). The name *lembang* is

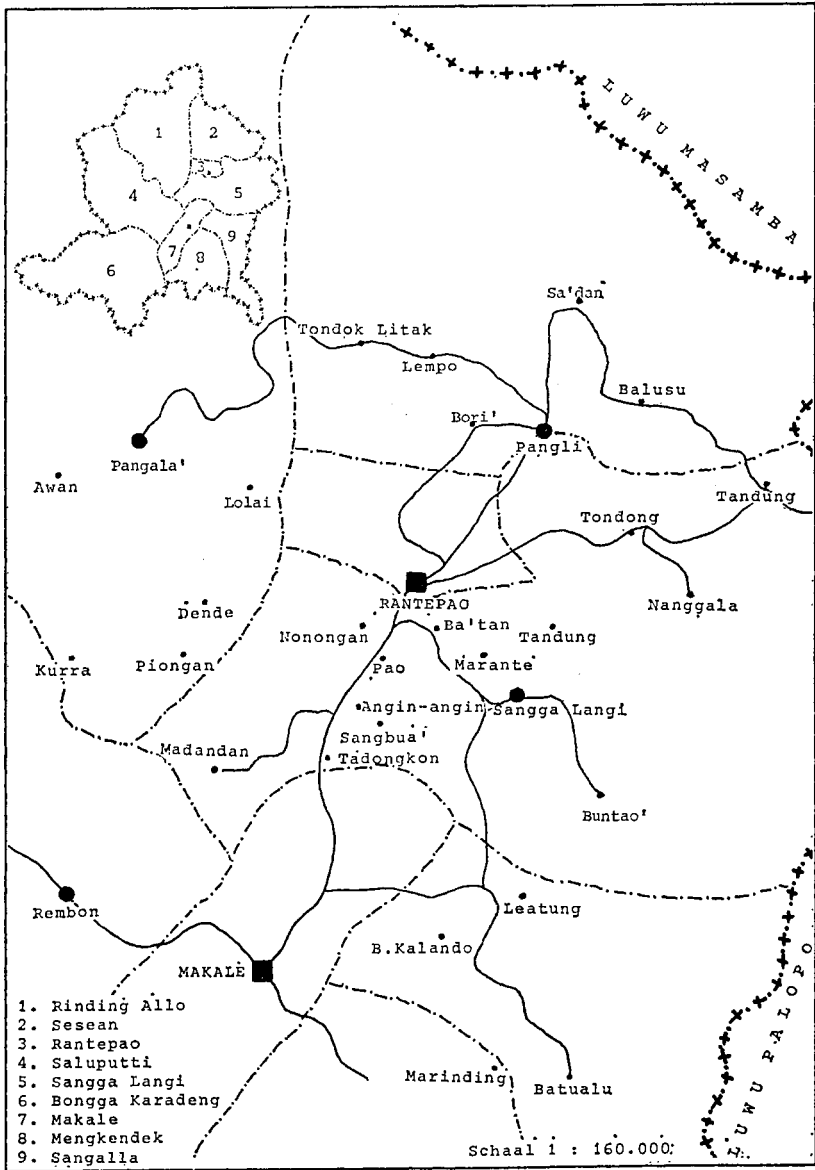

Map 1 Makale-Rantepao and surroundings. Left on top: Tana Toraja, the new division in *kecamatan* (numbered).

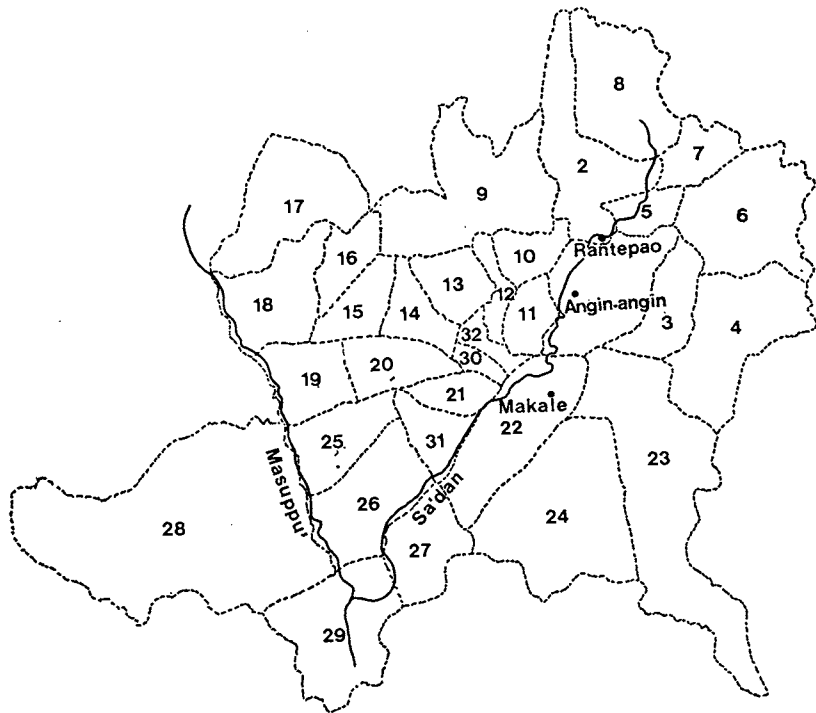

Map 2 The division of Tana Toraja in districts coinciding with *adat*-communities (as introduced during the colonial period):

1. Kesu'	12. Piongan	22. Ma'kale	} Tallu- lembangna
2. Tikala	13. Kurra'	23. Sangalla'	
3. Buntao'	14. Ulusalu	24. Mengkendek	
4. Rantebua'	15. Seseng	25. Mappa'	
5. Tondon	16. Bittuang	26. Buakayu	
6. Nanggala	17. Pali	27. Rano	
7. Balusu	18. Ratte	28. Simbuang	
8. Sa'dan	19. Balepe'	29. Bau	
9. Pangala'	20. Malimbong	30. Banga	
10. Dende'	21. Talion	31. Palesan	
11. Madandan		32. Tapparan	

Source: Seinstra 1940.

derived from the indigenous Toraja term for the territory of an *adat*-community; today the term is used also for an administrative unit, part of a district (*kecamatan*). The number of administrative districts remained constant after Indonesian independence. It was not until sometime in 1965 that they were fused together into a smaller number of *kecamatan*. Because the administrative districts introduced by the

Dutch coincided with the boundaries of traditional *lembang* (*adat*-communities), we shall adhere to the usage, common in all early ethnographic publications, and refer to these *adat*-communities as districts or territories (*landschappen*).

I.4. The name Sa'dan-Toraja; differentiation from neighbouring ethnicities

Toraja is a collective name for all people who inhabit the mountains of Southwest- and Central-Sulawesi. These mountain dwellers, however, exhibit differences among themselves in language and culture which formerly prompted sorting them into West-, South- and East- or Central-Toraja. The name Toraja (without any prefix) is used by the Buginese and the Makassarese, and above all by the inhabitants of Luwu', to denote the Sa'dan-Toraja. According to Adriani (see N. Adriani and A. C. Kruyt, *De Bare'e sprekende Toradja*, III, 1914: 1-2; see also Adriani 1930), the name comes from the Buginese *To-ri-aja*, The People of the Interior, The People of the Highlands (*to* means man or people; it is a contraction of *tau* which has the same denotation).

In recent times several Toraja have chosen for the following interpretation: Toraja derives from Buginese *Torajang*, The People from the West (*rajang* denotes west in Buginese, not, however, in the language of the Toraja). The People of the West are seen in opposition to The People of the East, the residents of Luwu' (Tangdilintin 1975: 2). The Toraja themselves consider explication of their name in terms of their coming from the interior or the highlands as denigrating. Yet another clarification of their name has been advanced by the Toraja instead: *to*, or people; *raja*, or grand, magnificent. A more or less free translation of Toraja would thus yield: People of high status, people whom others esteem, whom others deem worthy. In a similar vein it has been suggested that Toraja signifies a people of *raja*, a princely people. Linguists also employ the word South- (a geographic distinction) or Tae'-Toraja (after the word for negation in the language). Such terminology actually embraces a larger group than merely the Sa'dan-Toraja; it includes, for example, also the Mamasa-Toraja and the Duri who live, respectively, to the west and south of the Sa'dan-Toraja. Thus, by a linguistic route, we have arrived at the knotty problem of differentiating the Sa'dan-Toraja from their neighbours.

For a first point of reference we shall cling (at least temporarily)

to the name Sa'dan-Toraja, derived from the Sa'dan River. These people live, principally, in present-day Tana Toraja. A considerable number of Toraja have settled in Ujung Pandang, capital of the province of South-Sulawesi, and in the bordering *kabupaten* of Luwu' and Bone. These migrants, the total estimated at between sixty and a hundred thousand, make up a sizable fraction of the total number of Toraja, the population of Tana Toraja amounting to 310,000 in 1975 (see Annex Ib at the end of this chapter). Since taking up new homes they have practically all converted to Christianity and consequently do not figure further in this narrative. Similarly beyond consideration fall the old settlements of the Sa'dan-Toraja in Luwu', and the communities of the Jenemaeja River, a group closely related to the Sa'dan, in the territory of Pantilang, along the upper waters of the Bajo River which traverses this former kingdom. Because these communities (Pantilang among others) fell under the administration of the *sanggaria* of Bajo, one of the 'governors' of the Prince of Luwu' (cf. Pronk 1938), their culture acquired a somewhat different structure. My research, moreover, did not take me to their home area; they receive, consequently, relatively minor attention in this study.

The Mamasa, a tributary of the Sa'dan, has bestowed its name on the Mamasa-Toraja, a people so closely related to the Sa'dan-Toraja that one can almost always consider them as a single group.³ Yet, the Mamasa-Toraja have not been drawn into this study, nor have the Duri, also near relations, who live to the south of the Sa'dan-Toraja and who are regarded as Islamized Toraja. Despite the fact that the Duri reside also on the lower part of the upper course of the Sa'dan River, I only allude to them in passing.

This monograph is confined thus to the group which lives within the present boundaries of Tana Toraja. The Sa'dan River, which flows through a major portion of this area, has given its name to these Toraja which distinguishes them from other ethnic groups also called Toraja.⁴

Tracing dividing lines is always a matter of controversy. Thus the inhabitants of what was formerly Simbuang district in the south-west of Tana Toraja are residents of this *kabupaten*, but their language and customs ally them more closely to the Mamasa-Toraja and to the Toraja who live in the territory of Tandalangan on the right bank of the Masuppu' River, a side stream of the Sa'dan (see Van der Veen 1965: 56, note 259). The claim that the Sa'dan-Toraja are a separate ethnicity can be disputed, as far as the inhabitants of the

former Simbuang district are concerned; they certainly straddle the border. Yet elsewhere, too, myths, language and customs exhibit local differences. Three territories situated to the south of Tana Toraja, Ma'kale, Mengkendek and Sangalla', are small realms presided over by a prince (*puang*). Their political structure is remarkably similar to the forms of administration existing among the Duri. The resemblance of these regions, moreover, to the former principedom of Luwu' is striking, just as it is to the realms which lie within the cultural domain of the Buginese and Makassarese. As for their oral literature and their genealogies, the three Toraja principedoms display many points of congruence, not only with those of the Luwu' principedom but with those of the Makassarese realm of Goa and the Buginese principedoms as well.

After setting so many Toraja groups asunder, I find myself wondering if unity among them ever existed. Today, unity is merely a matter of language and cultural practices (not forgetting, however, that local variations exist). Yet, Toraja mythic history has one tale which tells of closing ranks to face an invading enemy.

1.5 Toraja history, a résumé

Although Toraja myths record many details about the coming into being of the Toraja 'world', they incorporate an outlook upon the past far different from that of modern historiography. Historical facts do crop up, but they are incorporated into subjective vision. The invasion of Toraja territory in the seventeenth century by the Bonese Prince Arung Palaka (Aru Palakka) is recorded, for example, but the Toraja view of events is distinct from the Buginese view. The Toraja maintain they defeated the warring prince; according to Buginese accounts the latter succeeded in the 17th century in appropriating a large share of what today is Tana Toraja.⁵ 'Facts and fancies' so intertwine that it is impossible to verify objective truth. A fact of signal importance is that according to their tradition, the Toraja joined forces in the 17th century to resist, as one, the Buginese onslaught. They entered into alliance called *Basse Lepongan Bulan*, 'Agreement (concerning the region) Round as the Moon'. The region so designated took in almost all of what is at present Tana Toraja. The Toraja look back upon their resistance against the Buginese as an exceptionally significant historical event.

Practically all information concerning the Toraja which precedes in date the arrival of Europeans in the area is contained in Buginese

chronicles. Unfortunately these sources have only been partially published and studied.⁶ The earliest European information about the Toraja was provided by the Jesuit Father Gervaise. His data, however, are not based on first hand observations, but on records of communications made by two Makassarese princes who were receiving tuition at the Jesuit College in Paris (see Gervaise, *Description historique du royaume de Macassar* 1688: 12-13). In his book Father Gervaise makes mention of "le royaume de Toraja", a territory where gold was found and where bamboo grew in abundance, and whose inhabitants had fought against Karaeng Bizet, a Makassarese prince who succeeded in subjugating them after he had set fire to their forests. The Toraja did not, however, convert to Islam which induced Father Gervaise to surmise that Christianity would later make headway among them.

At the end of the 19th century, the Dutchman Van Rijn became the first European to traverse the region of the Toraja. He has left an on-the-spot description of what he saw, dating from a time shortly before establishment of Dutch authority, and before all that we subsume under the heading of 'western influence' had penetrated into the region. He praised the orderly layout of the rice fields and made a drawing which depicts a rather elaborately decorated rice barn. The region, he noted, was thickly populated (see Van Rijn 1902: 328). This remark he based upon heavily-visited markets. Apparently there was little unrest in the areas which Van Rijn visited, although at the time Toraja leaders were fighting each other frequently, just as shortly thereafter some of them would battle against the Dutch. This final war, fought by Pong Tiku and the brothers Bombing and Ua Saruran against Dutch encroachment, was of no avail. In 1908 The Netherlands began their rule of what is now called Tana Toraja. In 1913 the *Gereformeerde Zendingsbond* of the Dutch Reformed Church inaugurated missionary work. Although in 1950 less than 10 % of the population had become Christians, the influence of the mission, because of its leading role in education and health services, was far in excess of what this statistic might suggest.

By 1975 almost 60 % of the population had joined the Christian faith. Protestantism had the most followers, for the Roman Catholic Church was only permitted to begin missionary activities after the Second World War. In 1947, the Protestant community became autonomous and its members united in the *Gereja Toraja* (Toraja Church).

Despite the fact that some 30 % of the population still adhere to

traditional religion (*Aluk To Dolo* = The Belief — literally: ritual — of the Forefathers), the prospects for indigenous religion are even dimmer than the number of worshippers might seem to indicate. Adherents belong, overwhelmingly, to older age groups. The young may perhaps value certain aspects of former Toraja religion but they regard it as 'ethnocentric', turned inwards, whereas Christianity throws wide a window on the outside world. In Tana Toraja there are many young people in training who aspire to a function in the *Gereja Toraja*, but there are no young *to minaa* (a category of priests who lead certain rites of the *Aluk To Dolo*). In addition, only one solitary *burake tambolang* remained, the most important priest in the autochthonic religious system: he ceased to perform in his old capacity a long while ago, dying in the spring of 1976.

There are, however, some reasons for optimism concerning the survival of autochthonic belief and traditional cultural values. The end of President Sukarno's regime ushered in a period of calm. Tana Toraja had previously been in a state of uproar; actual clashes took place there between the Toraja and Islamic battle units allied with Kahar Muzakkar. Now certain practices were permitted which had for a time been forbidden. The holding of cock fights, for example, became legal once again. Interest in the Sa'dan-Toraja language and in traditional forms of cultural expression increased. Although not the cause of this increase, something of a tourist boom in the area since 1970 has spurred its development on. About 1970 the *Aluk To Dolo* which had not previously been recognized, attained official status by being classified under the Hindu faith. Such recognition implied that, when applying for a job, would-be civil servants for the first time could register *Aluk To Dolo* as their religious denomination.

Elections in 1970 resulted in a victory for the Golkar (more than 80 % of those entitled to a vote in Tana Toraja cast their votes for this party). The Christian parties lost not only supporters, but face as well. Yet, this has not prevented the *Aluk To Dolo* from 'turning grey'. In many areas mass conversion to Protestantism has meant that traditional rituals barely survive. Together with Christianity, other 'Western influences', other phenomena of 'the modern era', are undermining the old world view of the Toraja. The Indonesian state is striving to realize the integration of her component population groups to a large extent. On the other hand the Sa'dan-Toraja continue to maintain their own ethnicity. The premises of Christianity, however, have exerted their influence. Christianity, brought from

the Low Countries, has assumed a guise here which differs from familiar European forms.⁷ Into the Toraja practice of Christian religion, autochthonic notions, such as their belief in evil spirits, are incorporated. Despite certain demonstrable similarities, a Christian interment among the Sa'dan-Toraja proceeds differently from a burial celebrated in a Dutch rural community. Christian burials, too, are often accompanied by the slaughtering of many water buffalo, and the bringing along of old symbols (for mortuary rituals see Vol. II).

Tana Toraja today thus exhibits a blend of the old and new. Emphasis in this work falls on the old. Effort will be made to portray traditional political structure and social organization in connection with traditional religion. Since the autochthonic political system is no longer intact and old Toraja religion has lost much ground, this work repeatedly bears the marks of an exercise in reconstruction.

How then might an ethnographer render concisely Sa'dan-Toraja culture as it was at the turn of the century? It was — and continues to be — a peasant society. Rice was the leading agricultural product, but coffee was the pre-eminent cashcrop. Trade in coffee; together with trafficking in slaves, were among the few activities to bring the Sa'dan-Toraja in contact with the outside world. Arab and Buginese merchants called for coffee beans and slaves from the country of the Toraja, and imported Dutch coins, krisses (a kris is a dagger with a wavy blade), old Indian textiles, salt, and, later on, weapons.

In addition to rice, people ate maize, and, in the territory of Ma'kale, millet as well. Diet was further supplemented with a small quantity of vegetables and with snails, fish, eggs, chicken, pork or water buffalo meat to provide protein. Meat was served, however, only on special occasions, principally when an animal was slaughtered during a ritual. In several territories dogs, too, were consumed, primarily by serfs (today canine dishes are an item appearing also on the menus of more prestigious families). Women prepared daily meals; men cooked during feasts. People drank *tuak*, palm wine, made from the sap of the spadix of the sugar palm which was allowed to ferment. Eating- and drinking habits have not appreciably changed. Men performed the heavy farm work, women helped during the harvest. This pattern persists today. Women braided baskets and mats; they fired pots and wove clothing from cotton and pineapple fibers. Men, too, worked at certain kinds of plaiting. Men knotted the characteristic Toraja bead ornament, the *kandaure*. They forged weapons and jewelry, carved wood and served as carpenters. They

fashioned mortars, dishes and spoons from wood and decorated bamboo tubes. Despite the languishing of certain handicrafts in recent times, men perform similar feats of artisanship even today.

At the beginning of the twentieth century, Toraja settlement patterns did not present the same appearance which they do now. Houses stood closer to one another, often perched on the summit of a rock for security reasons. Some villages were actual fortresses. Warfare and headhunting were integral parts of the culture which could at the time have been classified as megalithic. Massive stones were erected in commemoration of the dead; the sacrifice of water buffaloes was central to the elaborate Toraja burial feasts. Although headhunting now belongs to the past, water buffaloes are still killed in the course of funeral rituals and the Toraja continue to set up huge stones in honour of their deceased — albeit on occasion with the assistance of motorized traction. In spite of changes, the essence of their principal rituals remains unmodified.⁸

1.6 Economics

Since the turn of the century little change has taken place in how the Sa'dan-Toraja support themselves. Today approximately 90 % of the economically active population is still engaged in agriculture. An estimated 9 % holds employment as civil servants, church officials or school teachers, occupations formerly unheard of. Trade is the vocation of less than 1 %.

Industrialization has scarcely begun: what manufacturing takes place is the work of artisans. Tourism is burgeoning. It remains to be studied how many people, and which ones, are realizing profit from foreign visitors. As demand rises, the number of hotels keeps pace. Yet, poor means of access to Tana Toraja and the lack of an airstrip account for the rather low volume of tourism compared, for example, to Bali.

The table below presents a summary of land area planted in various crops:

Table 1: Agricultural Use of Land in Tana Toraja

Rice: <i>sawahs</i> (irrigated land)	17,686 ha
(dry fields) and <i>ladang</i> (swiddens)	52,322 ha
Coffee	1,690 ha
Cloves	99 ha
Compound gardens	1,024 ha

Source: Yan Yacobs 1971: 10; statistics for 1970.

Woodland and wasteland encompass 291,627 ha; the soil of most of this land is infertile, or otherwise poorly suited for cultivation. A glimpse at population density in Tana Toraja suggests a favourable agricultural situation, for only about 100 people inhabit a sq. km. Yet, if we take into account the extent of inarable wasteland, there is little reason for optimism. Almost 300 people in fact depend upon the produce of one sq. km., whereas few opportunities exist for opening up new land. (The population increased from 186,269 in 1930 to 309,404 in 1975; see Annex Ia and Annex Ib.)

Although most arable land is used for cultivation of rice, the annual yield, 40,000 tons (1970), is only sufficient for the internal consumption needs of the regency (*kabupaten*). No rice, therefore, is allowed to be exported from the *kabupaten*. In certain areas such as the district of Simbuang the composition of the soil precludes the cultivation of rice. This land is planted with groundnuts instead. In addition, maize (3,000 tons/yr.), manioc,⁹ yams and, in the district of Makale, millet are raised in modest quantities.

Coffee is the exclusive cashcrop in Tana Toraja. The yield of about 500 tons/yr. is of excellent quality. Further exports include pigs (8,000 per yr.), and buffalo hides (2,500 per yr.) (see Yan Yacobs 1971: 18). Coffee prices fluctuate with notations on the world market. In a good coffee year the Toraja spend a large share of their coffee profits on major rituals.

1.7 A critical appraisal of available literature about the Sa'dan-Toraja

Until the arrival of the Dutch, the Sa'dan-Toraja were unfamiliar with writing. Only a few Toraja had mastered Buginese, in speech and in writing. Stories, litanies and myths were transmitted orally. It was above all the *to minaa* (a class of priests) and *adat*-chiefs who passed such material on to the following generations, a tradition which in recent years has been discontinued. These functionaries were also masters in the recitation of genealogies. So far little of the vast fund of Toraja heritage, the tales and songs, has been recorded in print. One exception is the text of the litanies which are chanted during the *merok*-feast; these have been set down by J. Tammu and L. Pakan, the language assistants of Dr. Van der Veen. The latter has translated these texts into Dutch; his version has in turn been converted into English by Ms. Jeune Scott-Kemball. So' Sere, *to minaa* of the village of Angin-Angin in Kesu', was the man who originally

recited the litanies and prayers (see H. van der Veen, *The Merok Feast of the Sa'dan Toradja* 1965).

The Dutch had practically no knowledge whatsoever of the Toraja until the close of the 19th century. The Buginese, who were indeed literate, have put down some information about the Toraja in writing, primarily historical 'facts'. As of yet, Buginese literature on the subject of the Toraja has not been systematically examined; published works containing Buginese and Makassarese chronicles and sagas include only minimal allusions to their (Toraja) neighbours. The *Kroniek van Wadjo*' (1955), translated by Dr. Noorduyin, is an exception.

The review of sources about the Toraja which follows confines itself to more important works which have appeared after 1900. Since I have discussed the literature concerning the Sa'dan-Toraja in detail elsewhere (see Nooy-Palm 1978), I only mention those works here which were consulted with some frequency while preparing this book. The dictionary of Dr. Van der Veen (1940),¹⁰ was kept constantly at hand: for every Toraja word and concept it provides a complete explanation, frequently followed by commentary. It will be referred to as: *Woordenboek* (1940). Most of the works which will, in chronological order, be commented upon are either in Indonesian or in Dutch which makes them inaccessible to students who do not command either language. Compounding difficulties, some volumes known as *Memories van Overgave* written by administrative civil servants are hard to come by.¹¹

The accounts of their journeys by Van Rijn (1902) and the cousins De Sarasin (1905) are here passed by; their factual content is sparse (see Nooy-Palm 1978). The first travel book of significance is that written by A. C. Kruyt together with his son, J. Kruyt. Information is imparted about certain aspects of the Toraja material culture. Several myths are told. No theoretical reflections are offered.

Similarly, Grubauer's book (1913; second edition 1923), replete with reportage about material culture, is without any theoretical dimension. Many illustrations enrich Grubauer's book and help to clarify his text. The travel book of the Kruyt's presents few visual aids to the narrative.

The first ethnographic contribution about the Sa'dan-Toraja of real importance dates from 1923/24: 'De Toradja's van de Sa'dan, Masoepoe, en Mamasa-rivieren'. This article, by A. C. Kruyt, almost book length (\pm 240 pages), appeared in the *Tijdschrift voor Indische Taal-, Land- en Volkenkunde* edited by the *Bataviaasch Genootschap*

van Kunsten en Wetenschappen (to be quoted as *Tijdschrift* of the Batavian Society). At the time when he wrote about the inhabitants of the Sa'dan, Masuppu' and Mamasa River areas, Kruyt had not yet become embroiled in all manner of historical theories and so the information he provides is reliable as source material. The article is valuable in addition for many comments adduced by Dr. H. van der Veen, whom Kruyt consulted (see below for Van der Veen's share in the publication). Priests, too, offered data. A disadvantage of Kruyt's substantial work is the absence of an index which impedes looking for passages relevant to a particular topic. The sequence of topics, moreover, is somewhat capricious and there is not much coherence to the whole. The findings presented, nonetheless, are significant. Contents include rites of passage, the cult of the dead, headhunting, a number of myths, especially those in which animals play a part, and data concerning religion, kinship terms and marriage procedures. No clear portrayal of the social structure, however, is to be found.

In his article from 1921, 'De Boea' en eenige andere feesten der Toradja's van Rantepao en Makale' [The Bua' and other feasts of the Toraja of Rantepao and Makale] which likewise appeared in the *Tijdschrift* of the Batavian Society, J. Kruyt, A. C. Kruyt's son, provided an exposition of the major rituals of 'the east side' or, in other words, concerning the realm of the living (see Vol. II); other rituals he described were those celebrated by a large territorial or family group. The younger Kruyt's treatment of the vast *bua'*-feast in Pangala' is detailed and extremely valuable.

Such praise cannot, alas, be bestowed on his father's publication of 1935, *Het stamfeest op Midden-Celebes* [The tribal feast in Central Celebes]. Comparison of diverse tribal celebrations among the peoples of Sulawesi known by the collective name Toraja could have been intriguing, had Kruyt not interposed all sorts of theories in his material. Because he interpreted miscellaneous symbols according to his own personal predisposition, detecting sun symbology in practically every object that hit his eye, his article suffers from a certain 'sun blindness'.

As early as 1924 H. van der Veen had appended an important supplement to the ethnographic report of A. C. Kruyt. Its subject was the priests of the Sa'dan-Toraja: *De Priesters en Priesteressen bij de Sa'dan Toradja's* (see Van der Veen 1924). The linguist Van der Veen's intense interest in the Sa'danese and their way of life culminated in further publications: *Een wichel-litanie der Sa'dan-Toradja's*

(1929a) [An augurer's litany from the Sa'dan-Toraja] which presented commentary along with recorded texts; *De Samenspraak der beide priesters, de woordvoerders van bruid en bruidegom bij de huwelijksplechtigheid der Sa'dan-Toradja's* (1950) [Dialogue between two priests, the spokesmen for bride and groom at the wedding rites of the Sa'dan-Toraja] which also included necessary background information. In addition to these articles which primarily concerned litanies sung by the *to minaa*, Van der Veen also transcribed a number of folk tales both in 1916, with the cooperation of Dr. Adriani, and in 1924. In 1965 the 'Merok Feast' appeared, providing a wealth of information about autochthonic religion in Tana Toraja, particularly in Kesu'. It will be referred to as: Merok. Van der Veen's publication of the Sa'dan-Toraja's impressive songs for the dead followed in 1966: 'The Sa'dan-Toradja Chant for the Deceased'. Hereafter I will refer to this work as The Chant. The Chant presents not only the *badong*, the song for the dead, but also *retteng*, occasional or topical poetry. The songs for the dead convey much information about the mythical past of these Toraja and contain imaginative descriptions of Puya, the land of souls.

Of a completely different nature are the *Memories van Overgave*, documents written by diverse civil servants without narrative or exposition but dense with facts. Certain *Memories* deserve separate mention: A. Dirks (1938) gives much information about the cultivation of rice; F. G. Groeneveld (1938) is instructive about the land and people, about *adat*-communities and rituals for the dead; L. Pronk (1935) noted down data of interest about the Pantilang-Toraja, a group which now lives in Luwu'. G. Seinstra's *Memorie van Overgave* covered a wide range of subjects, from geography, population density, religion and rituals, priests and rites of passage (with special notice given to mortuary ceremonies) to the caste structure and *adat*-communities.¹² Seinstra, as was invariably true of the reports left by civil servants, invoked no theories. One *Memorie* has actually been printed, that by Nobele (1926): it is of special interest for its author's account of the rituals for the dead, and of rice cultivation — including the rice ritual — in Ma'kale, one of the *puang*-areas. It is regrettable that Nobele is not more precise with his spelling of Toraja words.

Van Lijf's *Memorie* (1947) eventually provided him with the constituent ingredients of two articles in the periodical *Indonesië*: 'Kentrekken en Problemen van de Geschiedenis der Sa'dan-Toradja-landen' [Themes and problems in the history of Sa'dan-Toraja lands]

(*Indonesië* I 1947/48: 518-536) and 'Tana Toradja 1905-1950' (*Indonesië* V 1951/52: 352-375; 12).¹³ I combine comment on these articles for they generate the impression that they are both groundwork for a book which Van Lijf's demise in 1957 prevented him from completing. Van Lijf's treatment of Sa'dan-Toraja history should be read in combination with the brochures of A. A. van de Loosdrecht *Onder de Toradja's van Rante Pao* [Among the Toraja of Rante Pao] (1921), H. Pol *Geschiedenis van Loewoe* [History of Luwu'] (1947) and H. van der Veen *Voorheen en thans* [Then and now] (1938). Van Lijf dwells at length on the Toraja church and also reports on the condition at the time of the economy of Tana Toraja. He gives extensive material about adoption. Caution becomes necessary as soon as Van Lijf indulges in theoretical speculation. His remark about *puang*-ramages (or the *puang*-family) is a case in point: there is no evidence to support his contention that these *puang* are the most recent immigrants to arrive in Tana Toraja. Van Lijf's reflections on religion are likewise dubious: there is no reason to accept his division of religion into a 'low cult' presided over by the *to minaa*, and a 'high cult' under the ultimate authority of the *to burake*, a distinct category of priests and priestesses (see below IX.5; Van Lijf 1947/48: 1-2). The *to minaa* also performs office during the great *bua'*-feast which falls into Van Lijf's 'high cult' category. Besides, these *to minaa* are especially priests who are very well informed concerning customary law, religion and myths. Van Lijf's division into high and low cults makes all the less sense because it is not a distinction which the Toraja themselves make. On the other hand it should be mentioned that Van Lijf was one of the first to discern structure in Toraja religion where the realm of the East, of the living, stands in opposition to that of the West, of the dead.

Muhamad Radjab in *Toradja Sa'dan* (1952) also recognizes this fundamental dichotomy. It is too bad that his book, which together with A. C. Kruyt's article from 1923/24 is one of the most complete ethnographic treatments of the Sa'dan-Toraja, has never been translated into English. Radjab has ordered his material into a number of readily comprehensible sections; geographical description of the land, origin of the Sa'dan-Toraja, their settlement pattern and houses, agriculture and industry, social organization, marriage and family life, inheritance and adoption, rituals, autochthonic religion, mortuary rituals, Christianity and Islam. Although some data, those concerning education, for example, are out of date, Radjab's work remains

especially useful. In addition to studies completed by A. C. Kruyt (1923/24), J. Kruyt (1921) and Nobeles (1926), his sources include *Memories van Overgave* which he could consult at that time in Tana Toraja and which made information available to him — facts about inheritance and adoption, to cite an example — that he might otherwise have encountered trouble in obtaining. Unfortunately, when Radjab turns to describing the Toraja character, he draws his inspiration from the stereotypes perpetrated by Nobeles (1926).

Parada Harahap has also written in Indonesian a convenient short ethnography of the Sa'dan-Toraja (1952). He has eked out his major source, Nobeles, with much information of his own, such as his description of the *saroan*, a Toraja mutual aid organization.

Tandilangi's contributions are also in Indonesian. A descendant of the *puang*-ramage of Sangalla', his writing concentrates on rituals in the *puang*-area, particularly in Sangalla'. These rituals were introduced long ago by Puang Tamboro Langi', an ancestor of semi-divine status (a *to manurun*) who descended from heaven to live on earth. Two of his articles deserve special mention: 'Puang Tamboro Langi' Membawa Sukaran Aluk Sanda Saratu' [Puang Tamborolangi' brings the complete 100 rituals (to earth)] (1967) and 'Pembahagian Sukaran Aluk' [The order of the rituals] (1968). The two articles are strictly factual and refrain from theories and speculation.

In 1967 Tandilangi's 'Memperkenalkan Tongkonan' (later published in French in *Archipel* no. 10, 1975) appeared explaining the significance of *tongkonan*, important houses, family centers. In 1968 yet another article was published, 'Tananan Basse', about the reaching of certain agreements — between a ruler and his subjects, for example. Ruefully, Tandilangi's contributions in the original are all but impossible to secure; they were reproduced in the periodical *Bingkisan*, a stenciled bulletin circulated in a limited edition at Ujung Pandang.

Toraja dan Kebudayaanannya [The Toraja and their culture] by L. T. Tangdilintin was published in 1975. It is in actuality a collection of a series of essays dealing with subjects which include: the name Toraja; Toraja autochthonic beliefs; the *tongkonan*, or house; the *liang*, or cliff grave; the rice barn; class divisions; fines at the dissolution of marriage; inheritance. The volume also contains explanations about Toraja assemblies, about their markets, dances, wood-carving, about mandatory procedures at cock fights, etc. Tangdilintin makes a solid, scholarly impression. It is interesting, moreover, to become familiar with the vision which a Toraja has of his own

culture. Tangdilintin has his own opinion about the origin of the term Toraja. He also has a personal theory about the oldest name of the land of the Toraja, which was, according to him, "Lepongan Bulan", or, synonymously "Matarik Allo", which mean, respectively, "Round as the Moon" and "Shaped like the Sun". To my mind these names apply to that more limited region whose inhabitants once formed an alliance against the invading Bonese prince Arung Palaka (see above, I.5).

Two authors have occupied themselves with topics which are not exclusively related — in the sense of their being an ethnographic description — to Toraja tradition. Raymond Kennedy's presentation of fieldwork notes (1953) only partially concern the Sa'dan-Toraja. He pays serious attention as well to the Makassarese and Buginese. One subject which he does broach is the Toraja world view in about the year 1950. He reaches the conclusion that entrenched ethnocentrism still was dominant. Interested in social change, Kennedy provides ample information about social stratification and alterations therein, about marriages between different social classes, and about political consciousness. A comparison of Kennedy's work with Eric Crystal's article 'Cooking pot politics' (1974) suggests that in the twenty five year period since Kennedy carried out his research the Sa'dan-Toraja have become progressively interested in politics. Crystal makes it clear how the Toraja use traditional social structures to acquire political prestige. He explains how one member of a *puang*-family acquired a political following by expending every effort to see that the ritual for a deceased family member was carried out to perfection; the man's reward was appointment to a post in the modern administrative system.

Although Harry Wilcox's book *White Stranger* (1949) is not strictly speaking ethnographic, it is a mine of information about how the Toraja raise their children, the process of socialization, character formation, daily life, rituals, etc. The book contains the author's impression dating from a period of residence in Tana Toraja shortly before 1950.

ANNEX Ia**POPULATION OF TANA TORAJA ACCORDING TO THE CENSUS OF 1930 ***

<i>District</i>	<i>Number</i>	<i>District</i>	<i>Number</i>
Balepe	1,268	Nanggala	4,656
Balla	1,226	Palesan	1,591
Balusu	6,813	Pali	2,311
Banga	2,135	Pangala'	15,234
Bau	789	Piongan	1,047
Bittuang	1,456	Rano	3,585
Buakayu	1,196	Rantebua'	5,530
Buntao'	4,730	Sa'dan	6,649
Dende'	2,153	Sangalla'	16,644
Kesu'	16,834	Sesseng	542
Kurra'	854	Simbuang	5,560
Madandan	3,020	Taleon	2,753
Ma'kale	18,467	Tapparan	2,511
Malimbong	2,436	Tikala	30,051
Mappa'	730	Tondon	4,246
Mengkendek	17,756	Ulusalu	1,496
		Total	186,269

* Source: *Volkstelling 1930*, dl. V, *Inheemse bevolking van Borneo, Celebes, de Kleine Soenda-eilanden en de Molukken*, p. 132.

ANNEX Ib**THE POPULATION OF TANA TORAJA IN 1975**

	<i>Adults</i>	<i>Children *</i>	<i>Total</i>
Male	76,323	80,925	157,248
Female	79,167	76,989	156,156
Total	155,490	157,914	313,404 **

* Unmarried children: younger than 15 years.

** The sum totals of the two tables do not tally, for reasons which the author is unable to explain.

POPULATION DISTRIBUTION BY *KECAMATAN*, 1975

<i>Kecamatan</i>	<i>Area in sq. km.</i>	<i>Population</i>
Makale	105.50	36,495
Rante Pao	72.50	22,706
Bonggakaradeng	977.—	21,862
Sanggalla'	215.80	21,570
Mengkendek	360.—	32,537
Sesean	336.37	40,267
Rinding Allo	461.40	41,463
Saluputti	252.21	40,693
Sanggalangi'	461.08	51,811
Total	3241.86	309,404 **

** The sum totals of the two tables do not tally, for reasons which the author is unable to explain.

Source: Biro Pusat Statistik, Propinsi Sulawesi Selatan, Kantor Sensus dan Statistik, Dati II, Tana Toraja, Makale.

CHAPTER II

KINSHIP STRUCTURE

“Hail! hail! hail!!!
Hail to this soil, rich with blessings,
Extolled exultantly as bearing good fortune,
by the divine ancestors of the ones
who are descendants of the clan-house,
numerous as bamboo culms,
who built the house.”

(Merok: 19)

II.1 Descent groups

The kinship structure of the Sa'dan-Toraja is dominated by the *marapuan*, a cognatic descent group or ramage (Fox 1967: 146-147); see also R. Firth 1957 and C. Schmitz 1965: 51ff. under “Ambilineaire Blutverwandschaftsgruppe”). The distinguishing character of the *marapuan* is its orientation towards a first ancestor. In the past, this ancestor founded a house, a *tongkonan*, which is looked upon as the social and religious center of the ramage. The primeval building itself can be designated as the mother-*tongkonan*. As the result of growth, in the long run the family-group branched out into several *marapuan* (which in turn consisted of a number of *rapu*; see below). This segmentation process was marked by the establishment of a new *tongkonan* which, like the mother-*tongkonan*, bore a name of its own.

In the context of the ramification process sketched above, one might call the *rapu* a subramage. Such a *rapu* embraced three or four, or, according to some, even five generations — *ampo salemberan* (‘the grandchild in whom it stops’) is an expression used for a descendant of the fifth generation. The term *rapu*, moreover, is also used now and then in the sense of *marapuan*. Here a warning is apposite: the people are inclined to associate the term *marapuan* with those *tongkonan* which enjoy considerable prestige, and the term *rapu* with those which are less respected. The *marapuan*, then, is a vast, inclusive structure which enters the limelight during extremely large rituals such as the *bua' kasalle*-feast. When the *merok*-feast is held, the

marapuan also has a function, although one may also consider this feast as a celebration at the level of the *rapu* (for the rituals cited here, see Vol. II).

The smallest unit is always the family (*siruran*, *kasisuran* or *dapo'* which means hearth; this last word is more frequently used metaphorically).

The *rapu* is thus, just as the *marapuan*, a ramage. It is highly reminiscent of ramage in Polynesia, in part because the head of the ramage is a descendant belonging to the most eminent subramage. Just as in Polynesia, family trees and generations are important: even slaves have a genealogy. (And so do important animals.) For the enumeration of one's ancestors in due order, the recitation of the family tree from generation to generation, there exists a special term: *tingga'*.¹

The family tree of a person from an eminent family can fill a sheet of paper two meters wide and three meters long, a format which hardly lends itself to incorporation in book form. Nevertheless, an effort to reproduce such a family tree has been made in an Appendix added at the end of the book. For descendants of the *puang*-ramage, their family tree stretches back to Tamborolangi', for descendants of leading families elsewhere their first ancestor is some other figure who came down from heaven (*to manurun*). In myths and legends the glorious deeds of such important forefathers are amply celebrated. Just as their offspring they bear illustrious, elaborate names.² Depth in genealogy is of consequence. Differences of generation are important. Terms are in use which extend back to the generation of FaFaFaFa and MoMoMoMo etc. (see Annex IIa appended to this chapter).

Those who in 1970 were some thirty years old still had been trained to perform recitation of their genealogies, but the youth of today have discontinued the practice. Among older Toraja some remain who know the mutual relations of the *tongkonan* (see II.1.2 and VIII.1) and the kinship ties obtaining for the entire *marapuan* by heart and can recite them aloud; Ne' Sangga from Ba'tan, for example, was expert at such a performance. It is true that he used a mnemonic device: a bundle of little sticks about two decimeters long each, fashioned from the veins of the sugar palmleaf. He began by placing one stick in a slanting position with the far end pointing

towards the northeast; this was ancestor A. On top, criss-crossing ancestor A, another stick represented A's marriage partner, B. Below A and B three sticks were set in vertical position, their children C, D and E. Diagonally across C, a stick was put down, again with the upper end pointing northeast, signifying F, married to C. Directly beneath once more three vertical sticks were set in a row standing for C's children G, H and I etc.³ The word for family tree is *pesalu* (*salu* means river).

In contracting marriages attention is often paid to assuring equivalent lines of descent for man and wife, especially when the union involves persons of high status. To describe such precautions the expression is used, *mettamben lako barana' tang sirrinan* ('to set foot diagonally on a banyan tree at a place where there are no ants'), i.e. to marry with a woman of pure (noble) blood. *Mettamben solo* (literally: crossing foot in downward direction; see *Woordenboek v. tamben*) means to marry a woman of inferior station. Another expression for such a match is *sule rokko* ('to return downwards').

II.1.1 Ancestor-focus

The genealogical depth of the *marapuan* can be appreciable: the family tree of the cognatic descent group in Kesu' as rendered by Ne' Sangga (Allo Rante) contained some twenty four generations; the family tree of the rulers in the Tallulembangna descending from Tamborolangi' included even a lengthier procession of ancestors, some thirty generations.⁴ Sketched on paper, a *marapuan* assumes the shape, roughly, of a triangle.

It is not only possible to divide the ramage (*marapuan*) internally in the fashion described above (into *rapu*) but it is also possible to do so by distinguishing one status ramage from other subramages, the former with a mother-*tongkonan* to which an important title is connected, the latter with *tongkonan* of lesser significance. In Tana Toraja three pre-eminent ramage can be differentiated:

- A. that of Londong diLangi';
- B. idem of Manurun diLangi';
- C. idem of Tamborolangi' (Tamboro Langi').

The suffix *Langi'* ('Heaven') is an indication that supermundane beings who descended to earth are involved. In Chapter VI: Mythology, the adventures of the most important of these supernal ancestors and the exploits of several of their descendants are re-

counted. It is from these three celestial ancestors that the leading families in the Tallulembangna (the three *puang*-regions) and in the districts of Kesu', Buntao' and elsewhere originate. It should be added that the progeny of these three celestial beings often intermarried. Mr. Tangdilintin has prepared a genealogical table in which the most important descendants belonging to the three families have been included. (Allo Rante has drafted a similar genealogical table for Kesu'.) These family trees are reproduced in the Appendix. A short sketch of each ramage which appears in the Annex follows below.

A. The ramage of Londong diLangi' originates, as indeed those of Manurun diLangi' and Tamborolangi' do as well, in heaven. Londong diLangi' ('The Cock from Heaven') was the son of Pong Mulatau, the 'First Man' (who was born on earth). Pong Mulatau's parents had come down from heaven to earth. The first man born on earth married Sandabilik ('the Dam in the River'). She bore him two sons, Londong diRura and Londong diLangi'. The former drowned, a punishment for allowing his children to marry each other. Londong diLangi' married Tumba' Gantanan ('She who lept onto the dry land'). Six generations later Tang diLino' (Tangdilino' = Not from the Earthquake) was born in this family. He was the founder of a distinguished *tongkonan*, Banua Puan, in the village of Marinding which is situated in the territory of Mengkendek, one of the *puang*-regions. It should be asserted emphatically, however, that Tang diLino' is not considered to be the ancestor of the *puang*-families though a number of his descendants have married into these families. Tang diLino' had various sons all of whom parted for elsewhere with the exception of Patabang who remained in residence in *tongkonan* Banua Puan ('the House of the Lord'). Patabang's brother Telebuë set out for Duri, the region which borders Tana Toraja to the south. Brother Kila' ('Lightning') made his way to the territory of Buakayu and became the ancestor of the most important ramage there. Brother Parange' settled in Buntao' where he emerged as the forefather of most significance. Brother Pata'ba⁵ went to the territory of Pantilang and he, too, became an important ancestor. Brother Lanna' chose the area of Mankarangga as his destination. Brother Pabane' made his home in Kesu' where he married 'the Morning Mist of Kesu'', a descendant of the most distinguished ramage there. And thus we arrive at:

B. The lineage of Manurun diLangi' ('Come down from Heaven') alias Puang riKesu', the most important ancestor in Kesu'. He married

Batari Uai ('the Water Goddess') and founded *tongkonan* Kesu'. His daughter, the previously mentioned Lai' Ambun diKesu' (or Puang Ambun diKesu' = 'Lady Morning Mist of Kesu') thus wedded with Pabane'. Their son Polopadang established *tongkonan* Gantan in Kesu'; their daughter Manaek built *tongkonan* Nonongan in Nonongan.⁶ Polopadang lost his title to his sister so that she is regarded as the most outstanding personage in the Kesu' ramage (how Polopadang lost his title is narrated in VI.2.2). Nevertheless Polopadang is also esteemed as an important ancestor. Six generations after him, two consequential (sub)ramages in Kesu' originated, each boasting a genealogy of some fifteen generations.

Pabane's daughter Manaek married a grandson of Tamborolangi'; the first ancestor of the *puang*-lineages. She did not go to the *puang*-kingdoms, however, but continued living in Nonongan.

C. The third of the pre-eminent ramage, that of Tamborolangi', grew into three, a separate ramage in each of the *puang*-realms. The three are interrelated by marriage. Members of Tamborolangi's lineage have also married into leading ramage in other regions, not only with those of Kesu' and elsewhere within Tana Toraja, but indeed also with noble families in Luwu', Goa, and places beyond.

II.1.2 *Status ramage*

Although in principle every Toraja is a descendant not only of his father's *tongkonan*, but of his mother's as well, in celebrating a mortuary ritual for a deceased family member one is obliged to adhere to the form of celebration customary in the dead person's maternal *tongkonan*. This restriction is known as *aluk susu*, an *adat*-regulation (or the observance of a ritual) that is customary in the family of the mother (the term *aluk susu* is only used for rituals for the dead). This orientation is connected to the fact that regardless how high the rank may be which the father occupies, his children always are classified by their mother's station: the offspring of a woman who is one of the *kaunan* ('unfree') are themselves *kaunan*. Here the laws of inheritance play an important role. A death ritual of a lesser order entails that fewer buffaloes may be slaughtered so that proportionately few *sawahs*, or none at all, can be inherited (see i.a. II.5.3 sub f).

The internal structure of the *marapuan*, with its differentiation between status ramage and subramage, has already been discussed. Although women are eligible for a title, titles tend to follow the male

line (the house of Banua Sura', holder of the title *sokkong bayu*, had a succession of fifteen titleholders among whom the sex ratio was three men to one woman). Status ramagees thus exhibit a patrilinear trend. In some families, however, certain positions are the legacy of women, for example, those of *burake tattiku'* and *to ma'gandang* (two categories of priests). These titles, however, are not connected to any special *tongkonan*. The *tongkonan* not only function in the religious sphere but also in that of administrative law.

II.2 Ego-focus: the kindred ⁷

Although it is possible to characterize specific rituals as *tongkonan* celebrations (e.g. the *merok* and *mangrara banua* rituals to be described in Vol. II) such festival occasions are always attended by the kindred of the feast-giver. Attendance by kinsmen and -women from other ramagees is particularly intense during rituals for the dead: when ego's father has died, from first to last his mother's family will be involved in observing this demise. Reciprocal relations among the kindred indeed play an important role. After the death of ego's father, his mother's family attends the mortuary feast bringing presents which will later be reciprocated at the time of ego's mother's obsequies.

II.3 Affinal kin (rampean)

The *marapuan* and the *rapu* find their most important functions in the celebration of the major rituals performed for the well-being of the titleholder. The *tongkonan* is the center of the celebration. Ego, who organizes the proceedings, is the titleholder of his father's *tongkonan* (and possibly also the titleholder of his mother's *tongkonan*). He does not merely invite those who belong to the *tongkonan*, but also his matrilineal relatives. And because he usually has reached an age where he has become a father, he also asks his wife's family to join the feast. All those invited bring (if need be on a modest scale) a contribution to the feast, a gift which, on some subsequent occasion, will be reciprocated. The bulk of costs, however, falls to the host and his fellow *tongkonan* members.

When a mortuary ritual is celebrated, these procedures are slightly different: as usual, in addition to the deceased's cognates, affinal kin are also invited, but then the latter's contributions are more considerable than on the occasion of the *merok*-feast, at least in Kesu' (for the *merok*-feast which is given by the ramage, see Vol. II).

While attending a *merok*-ritual in the Sa'dan area in 1972, I had the impression that there a *potlatch* element was inherent in the proceedings, just as it is customary elsewhere during rituals for the dead. This means that, on such occasions, the in-laws, too, must exert themselves to present gifts to the organizer of the *merok*. Gifts received during a mortuary ritual will be reciprocated by the children of the deceased when, on a later occasion, an important member of their allies by marriage happens to die.

In daily life a male ego's contacts with his SiHuSi are subject to restrictions (see II.5.1). As far as ordinary relations with the first ascending generation are concerned, it should be noted that no taboos obtain vis-à-vis parents-in-law. A male can talk at ease with his mother-in-law, a female ego with her father-in-law.

II.4 Kinship terminology

II.4.1 *Consanguines*

The kinship system of the Toraja resembles that of Polynesian peoples rather closely. Even the nomenclature in use calls the Polynesian system to mind. Terminology among the Toraja is a variation of the Hawaiian type; the emphasis on generation displays a similarity with Polynesia. (For the actual terms, see Annex IIa.) Just as with Hawaiian kinship terminology, the symmetry of the Torajan system is striking.

a. *Siblings and cousins*

Terms for siblings are the same as for cousins. The word for sister (and for a cross- or parallel-cousin of the female sex) is *anak dara*, a phrase which signifies a virgin; the word for brother and for male cousins is *anak muane*, or, literally, male children. Further specification among siblings and cousins is possible. The general term for cousins (cross- or parallel-), regardless of their sex, is *sampu*. *Sampu pissan* are first cousins, *sampu penduan*: second cousins, *sampu pentallun*: third cousins.

There exist a few other words to designate siblings, *api'*, for example, a term which occurs in death chants to denote a brother or a sister, irrespective of whether the singer is male or female. In Sangalla' people use the term *le'to* for those who are each other's brother or sister (siblings). *Sile'to loloku*: my full brother or sister (same Fa and Mo) is a poetic expression (*Woordenboek*: 306). *Loloku*

is derived from *lolo*, the umbilical cord. In Bittuang and Sesseng the word used for brother or sister is *ulu'* regardless of the sex of the speaker or of the person referred to. The dialectal variant in Madandan and Ma'kale is *unu'*, elsewhere people also say *siulu'*. There are also words for half-brothers and half-sisters. *Siulu' dio indo'* is the phrase for a half-brother or half-sister with whom one has the mother in common but not the father. *Siulu' dio ambe'* is a speaker's half-sibling because of being born of the same father. *Siulu' lanmai tambuk*: a full brother or sister, progeny of one's own mother and father. Just as in Hawaiian kinship terminology, the Toraja distinguish between older brother, or sister (*kaka*) and younger brother, or sister (*adi*). These terms are also used for older, or younger cousins.

b. Aunts, uncles, nephews and nieces

Mo, MoSi and FaSi are respectively *indo'*, *pa'indoran* and *pa'indoran*. These aunts terms, given the fact that *pa'an* means 'like' or 'just as', can be categorized as of the generation-type. At times aunt (MoSi, FaSi) is also referred to as *indo' ure*; FaBr and MoBr is either *pa'amberan* or *ambe ure*.

The term employed for son is *anak muane* and for daughter, *anak baine* (male child and female child, respectively); nephews and nieces, regardless of their sex, are called *pa'anakan* (literally: the same as a child). The word *anak ure* is also in current usage.

c. Grandparents; grandchildren

In the second ascending generation only one term is used for grandfather and grandmother (*nene'*) and this term is extended to all relatives of the same generation. Among grandchildren (*ampo*) no differentiation is made according to sex. The grandchildren of ego's brother or sister are *pa'ampoan*.

A special term exists for great-grandfather and great-grandmother: *nene' guntu'*; great-grandchildren are called *ampo guntu'*. Once again no distinction is made on the grounds of sex.

Greatgreat-grandparents are referred to as *nene' salemberan*, ancestors still another generation further removed as *nene' todoan*.

Terminological distinctions are thus maintained for five generations, ascending and descending.

All of the above terms are referential. In practice, when a person is talking about someone the word *ne'* is frequently used as a prefix followed by the name of the subject of conversation's oldest grand-

child. *Ne'* or *nene'*, *indo'* and *ambe'* are also terms of address. Members of descending generations are addressed by their own personal name. These names are also employed when discussing a person.

II.4.2 *Affines*

For details concerning affinal terminology a reader should consult Annex IIa. Ego's parents, and the parents of his wife refer to each other as *baisen*.

II.5 **Marriage**

Marriage (*dapo'*, *rampanan kapa'*)⁸ as a rite of passage will be discussed in a chapter of that title in Vol. II. Indeed, it is an indication of the significance of marriage that it is considered a ritual (*aluk*) in its own right.

II.5.1 *Forms of marriage; marriage prescriptions and restrictions*

Until about a generation ago, marriage used to be arranged by the parents of the prospective bride and groom. Since in every society with such rules there are young people eager to avoid them, elopement also occurred in Tana Toraja. Marriage upon elopement is never called *rampanan kapa'* because it entails no claims for any indemnity (*kapa'*) to be paid should the parents divorce. Should in the long run, the parents of a boy and girl who have married on their own volition agree to the match and become reconciled with the pair, then a *kapa'* will be settled upon afterwards.

In some districts monogamy occurred, as, for example, in the former district of Rantepao. In Ma'kale, Mengkendek, Sangalla' and Kesu' polygyny was customary among the upper class (Kruyt 1923/24: 120). "Should a woman oppose the intention of her husband to take a second wife, then he must induce her to give her consent by the payment of a fine, *kapa'*, which usually amounted to from two to four buffaloes. For a reigning *puang*, the indemnity payment might be as high as twenty-four such animals." (Kruyt 1923/24: 121). Nothing has been reported concerning the incidence of monogamy or polygyny in other districts.

Payment of a brideprice is unusual in Tana Toraja with the exception of the district of Bittuang; in Buakayu, Rano, Bau and Palesang a brideprice is rendered when a girl marries contrary to the wishes of her parents. Here a brideprice is called *ba'ba* ('door') and consists of one to twelve buffaloes (A. C. Kruyt, *ibid.*). In the

Masuppu' and Mamasa river basins the payment of brideprice is in general practice and is known as *somba* (this term is also current in the districts of Ranteballa, Bolu' and Kanna which lie beyond Tana Toraja in Luwu').

Today a young man is at liberty to choose a wife outside as well as within his *rapu* just as long as he respects incest taboos (in the sense of marriage restrictions within the family group) and social taboos. The marriage prescriptions which obtain for various classes are rather rigid (see Chapter III, Classes). A free man or someone of noble blood may decide to marry a woman from a lower class, but a noble woman or a woman who belongs to the class of the free is not allowed to marry a man who is of a lower rank than she is. This prohibition is at present losing force. A similar weakening can be observed of the rule that first cousins may not marry, although in places, such as Mamasa, for example, the old interdiction retains its absolute validity.

Marriage between brother and sister, regarded as an incestuous match, is punishable by death: in the past guilty parties were drowned or burned. The same sanction was applied should brother and sister have sexual intercourse with each other (Kruyt 1923/24: 94). According to Kruyt the death penalty by water or fire was enacted only in the districts of Ma'kale, Rantepao and Kesu'. The Toraja dreaded the consequences of incest: crops would bear no fruit, contagious diseases would run rampant among men and beasts alike. In the event that incest was detected, an expiatory sacrifice was made, *ma'rambu langi'* ('to cover the heaven with smoke'). A buffalo was consumed by fire (= destroyed). None of the sacrifice was allowed to be eaten. In Sangalla' the death sentence for those committing incest was never invoked. Burning a buffalo was considered ample atonement. When I inquired in Kesu', I was told that the severe rule mentioned above would also be enacted today. Anxiety for the aftermath of incest persists undiminished. (For a case of incest in Toraja myths, see VI.3 wherein the drama is related which tradition says took place in Rura when the children of Londong diRura intermarried.)

Shortly before Dutch authority was established in the part of South Sulawesi where the Toraja live, a case of incest happened in Ma'kale. The son of the *puang* of Ma'kale married his half-sister (Kruyt 1923/24: 98-99). The couple was saved by the *puang's* repudiation of them both as his children. Here I feel obliged to remark that I

remain unaware of any instance of the death penalty actually being applied for such incestuous attachments.

In many parts of Tana Toraja, Kesu' to mention one, marriages between first cousins (whether cross- or parallel-cousins) are, in theory, forbidden. Yet, a considerable degree of social stratification is known in Kesu' and thus, as in many stratified societies, there is an inclination to tolerate violation of such marriage restrictions in order to facilitate the contracting of marriages within one's own (*in casu* within one's own family). An examination of the family tree of Puang riKesu', the *to manurun* of Kesu', reveals that Tonglolangi', a descendant of the sixth generation of the *to manurun*, was married to his FaBrDa, Bayu. The son of Tonglolangi's sister (Ne' Langi'), Tang-diGau by name, married Indo' Pselin, the daughter of a brother of Ne' Langi' and Tonglolangi'. A granddaughter of the latter, a certain Lai' Pirade', married Ne' Langi's son, Pong Dakka. According to customary law such a match should be as impermissible as one between cousins. There is a difference thus, as there is everywhere, between rule and reality. The same holds true for the restriction precluding marriage with a second cousin (regardless of whether a cross- or parallel-cousin). This prohibition is also in effect in Kesu'. For the mythical origins of this stipulation and of the taboo against unions of first cousins, the reader should consult the incest myth of Rura (6.3) mentioned above. Not only contractual marriage, but all sexual intercourse between individuals belonging to the categories specified above counts as incest (siblings, first and second cousins, even third cousins in certain locations). In the districts of Ma'kale and Mengkendek a union between first cousins (whether cross- or parallel-cousins is immaterial) is permitted if the partners belong to the *puang*-ramage, provided that four buffaloes are slaughtered. Should both aspirant partners belong to the class of *anak disese*, e.g. a child from the marriage of a *puang* and a *to makaka* ('a free farmer'), then first cousins may not marry. For second cousins (*sampu penduan*) of such parentage, marriage is not out of the question but its celebration is to be accompanied with certain offerings. Among *to makaka* ('free people') and *kaunan* ('unfree people') marriage between cousins is allowed as long as the relation is still one degree further removed, thus between *sampu pentallun*; such an alliance, however, must always be accompanied by the sacrifice of one to three pigs. In the remaining areas of the Sa'dan River class differences are not relevant to trespasses of marriage prohibitions among relatives. In Sangalla'

it does happen that first cousins (*sampu pissan*) who are member of the *puang*-lineage marry but in that case a pig is slaughtered 'to ward off evil'. There is on the whole no objection in this region to the marriage of two second cousins. In the former districts of Kesu', Sa'dan, Balusu and in the cluster of villages Tondok Litak, a sacrifice is sufficient to gain acceptance for the union of *sampu pissan* (according to information received such a marriage was also one forbidden in Kesu' with the exception of descendants from *tongkonan* Sullukan in La'bo'). The law is far stricter in Baruppu', Pangala' and Bittuang where marriage between first cousins, *sampu pissan*, is unconditionally banned. In the Sa'dan region when discussing marriage between cousins, no one ever asks whether they are cross- or parallel-cousins; the distinction is considered immaterial here.

According to Kruyt, for two brothers to marry with two sisters is not merely permitted, but favoured. A person may not marry the sister of his brother-in-law (= SiHu), however. Such a coupling is referred to as *sisura'* or *sisula' sirrín* ('pell-mell'), a term also used, for example, to describe the criss-cross scurrying of ants when they have been thrown into confusion. The consequence of disregarding the prohibition would be the dieing out of the entire family. Some maintain that such a marriage exercises influence over crops and livestock which would not thrive. If one sleeps with the sister of his brother-in-law and this comes to light, usually no expiatory offering is made, *ma'rambu langi'*, but when a child is born as a result of such intercourse it can never be acknowledged by the father as one of his own. Only in Balusu is such a union allowed, if no attempt at concealment is made and the pair do not meet in secrecy. If the affair has been conducted clandestinely, atonement is necessary, *ma'rambu langi'*, and even afterwards there is no chance for the lovers to marry. In Ma'kale such a marriage is an option for members of the *puang*-ramage only (Kruyt 1923/24: 107).

According to information dating from 1970, *sisura'* in the sense of a marriage still occurs today, although not frequently. Despite the absence of sanctions, public opinion leaves no room for doubting that such marriages are best avoided.

Finally mention must be made of prescripts against marriages between persons of different generations. Kruyt remarks that in certain districts where marriage rules are rigorous (such as, for example, in Baruppu' and Pangala') no union is allowed between related persons

of different generations. In other districts such a marriage is only forbidden when the partners are too closely related by blood, uncle and niece for instance, or aunt and nephew — whether on mother's or father's side of the family. The relation of an uncle and aunt to their nephews and nieces is experienced as equivalent to that of a parent towards his or her children.

The marriage of a man to the granddaughter of his brother or sister is also forbidden and in areas with strict rules in this respect (Baruppu' and Pangala') no marriage may take place between relatives, however distant and however small the age difference between them, if they are not of the same generation.

The marriage prescriptions cited above, derived from A. C. Kruyt 1923/24: 92-108 (who received his information from Dr. H. van der Veen and Toraja informants) do not deviate from what present-day Toraja say on the subject. It does happen, however, that certain rules are evaded. For further information on marriage prohibitions operative in Tana Toraja, the reader should consult Kruyt's article.

II.5.2 *The kapa'*

Kapa' is the penalty to be paid by the marriage partner who is responsible for dissolving the marriage bond (*Woordenboek v. kapa'*). The *kapa'* is fixed at the time that the partners enter into marriage (= *rampanan kapa'*: 'the laying down of the *kapa'*'). Some explanation is not out of place. What does the word *kapa'* ('cotton') mean in this context? Recently, two Toraja chose *kapa'* as the subject of their masters theses, Mr. Bulu' and Mr. Matandung.⁹

Their explanations of the word *kapa'* in its metaphorical significance are at variance. According to Bulu', *kapa'* alludes to cotton from which thread is spun. *Rampanan kapa'* ('the laying down of the *kapa'*') refers to the binding element — the thread — of the marriage agreement (Bulu' 1970: 42). Matandung's interpretation runs roughly as follows: cotton (*kapa'*) is seen in Toraja culture as the symbol of purity; *rampanan kapa'* ('the laying down of the cotton') points to the conditions of indemnification which are to guard the sanctity of a marriage against disturbance (= pollution).¹⁰ Disruption of marriage is not always the result of adultery, although often this is the leading cause. In the context of the preceding, people sometimes use the phrase *pasanduk salu rampanan kapa'* ('to put marriage to the test the way one sounds the depth of a river'). This expression, Matandung reports, is an allusion to the mythical incest in Rura which tells how

practically the entire Toraja community drowned because a prominent individual entered into matrimony with his sister (see VI.3). The conclusion implied is that the *kapa'* serves above all to prevent partners who are too closely related to each other from marrying. Yet, for all the restrictions which are relevant, marriages between first and second cousins fairly frequently are contracted with *kapa'* stipulations. Unions of this nature, of course, function to keep inherited wealth intact. The *kapa'* makes divorce difficult so that the inheritance remains whole.

The amount of the *kapa'* increases in proportion to the elevation of the class to which the aspirant marriage partners belong. For every class the terms of the fine have been determined (see III.1.2 and III.2). In connection with the fine, a special name is used for every class, a name that always begins with the word *tana'*. *Tana'* means boundary-post and, metaphorically, has the significance of "real, acknowledged as valid, so that it has become a fast rule" (*Woordenboek*: 674, *tana'*). Not for all unions is there a *kapa'* fixed. Marriage which does involve *kapa'* is called *unrampanan kapa'*, one without *kapa'* is known as *si bo'bo' bannang* (= boiled rice, used to starch thread). *Si bo'bo' bannang* is a simple form of marriage; the Toraja name for it, starched thread, is not, in its metaphorical implications, entirely clear. Often marriage partners only proceed to the *unrampanan kapa'* form of wedlock after children have been born from their union.

Spouses are liable for paying the fine if:

a) He or she commits adultery. The amount of indemnification which must then be paid varies with the class of the married couple. This form of adultery is called *unsongka dapo'* ('the destruction of the household hearth' = the family). The exact amount of the fine is set either by a great *adat*-community or, if the marriage partners are of the highest rank, by a gathering convened by it. Such a gathering is called *kombongan kalua'* ('great meeting').¹¹

b) *Sipula'* ('to conquer each other mutually') is also a reason for requiring payment of the *kapa'*. This refers to a situation in which the head of family A, married, enter into a relation (and such a relation is likely to be without any *kapa'* arrangements) with the wife of the head of family B, without having provided for his first wife. Then the head of family B — whether to save face or for other reasons — marries the ex-wife of A. Both A and B are obliged to pay fines of the amount set by the *kombongan (kalua')*. (The above does

not reveal unambiguously whether A has embarked on a permanent relation with the wife of B or whether their liaison was of a temporary nature.)

c) Another trespass calling for payment of *kapa'* is *unbolloan pa'to'* ('to drop rice which has already been boiled'). This entails the following: preparations for marriage are finalized for all intents and purposes when suddenly one of the partners does not live up to the agreement so that the union does not take place. The party who balks must then pay the other half of the customary sum of the *kapa'* for persons of their class, the precise amount here, too, being determined by the *kombongan* (*kalua'*).

d) *Kapa'* is also required when a man divorces his wife for no valid reason. He must then pay her the fine which the village council will decree.

e) *Kapa'* must also be paid in case of *untengkai susuk* ('going beyond the boundary poles'; *susuk* = pole). A woman (or man) mentions the names of certain men (or women) with whom the man (or woman) who is divorcing her (him), for no reason other than to begin a new marriage, may not marry. The names are cited in the *kombongan*, the meeting of notables and elders in the village. The aggrieved party suspects that the accused has been carrying on an affair with one of those mentioned. The man (or woman) then pays a *kapa'* determined by the *kombongan* to the accused partner. Actually, *untengkai susuk* is a variation of the form described sub d.

These are several instances calling for the payment of a fine for violation of marriage (see II.5.1 for the case of polygamy). One question obtrudes if the village council must declare a verdict and settle the exact amount of the *kapa'*, what is the relation of their pronouncement to the *kapa'* settled upon at the time the marriage agreement was concluded? Unfortunately, this question cannot be answered.

The following remains to be added: in the past, a marriage partner who was wronged was entitled to take the law into his own hands should he discover his mate in the act of adultery. He might then mete out death to the culprits (it is not reported whether the right extended to injured wives).

There is also an instance concerning the *kapa'* about which Toraja authors fail to agree: Matandung asserts that no fine need be paid when a widow remarries before she has completed certain purification rites, but Tangdilintin is of the opposite opinion. (See Matandung

1973: 57; Tangdilintin 1975: 164.) Neither writer makes clear whether or not the same circumstances oblige a widower to pay *kapa'*.

Kapa' is not customary everywhere in Tana Toraja. Indemnification regulations were non-existent in the following areas: Bittuang, Bua-kayu, Bau, Palesang, Rano; Ranteballa, Bolu' and Kanna in Luwu'; and also in Balusu. With the exception of Balusu, these are districts where paying *somba* (brideprice) is the rule. It would be mistaken, however, to regard *kapa'* as a sort of veiled brideprice. Yet: in the districts of Kesu', Balusu and Sa'dan marriages between first cousins are permitted subject to payment of *kapa'*.

II.5.3 *Children in the adat-system*

The law of inheritance differentiates the following categories of offspring:

- a. legitimate children
- b. foster children
- c. *Anak sangtepo* ('quarter children')
- d. *Anak ba'gi*
- e. adopted children
- f. *Anak pangngan* ('betel' children').

a. These are children who, as the name suggests, are born in wedlock. They inherit a share in the estate in proportion to the number of buffaloes which they sacrifice during the mortuary rites.

b. Foster children: these can be the sons and daughters of a brother or sister adopted as members of one's own family. A person of high standing, moreover, can place a child with one of his serfs as his foster child; the reverse is unheard of. (According to my informant such a child is not entitled to share in the inheritance of its foster parents, although from another source I heard that this right was indeed conferred.)

c. *Anak sangtepo* are of various kinds:

1. When a woman is in the first stage of pregnancy (e.g. two months pregnant) and she divorces her husband and remarries before she has given birth to the child in her womb, this child upon delivery will be acknowledged by two fathers: his natural father and his step-father. From both fathers he inherits one fourth (*sangtepo*) of the share he could have claimed as an 'ordinary' child. Because of his birth he is legally 'a half child'.

2. When a married woman has remained barren, she may commit

adultery with the intention of conceiving. She conceals the identity of her lover. Should a child be born from their congress and its delivery proceed with some difficulty, then the woman calls out the name of her husband. If despite this delivery remains arduous, she finally divulges the name of her lover. All present now know the latter's name, but even with the woman's lawful husband this raises no objections. It certainly provides no grounds for divorce, for the *adat* sanctions adultery if designed to enable a woman to bear children. Again, the child will be regarded as having two fathers.

3. An unmarried woman can have more than a single lover. Should she bear a child, this can lead to complications. She will try to induce one of her lovers to acknowledge his paternity. In earlier times the inability or refusal to name the father of her child was particularly hazardous for a girl. If, before the Dutch established their rule, she failed to do so, she could be put to death or exiled (*diali*).

d. Sometimes adults are promised a share (*ba'gi*) in the legacy because they are particularly brave or capable men, and the legator apparently needs their protection. Primarily rich individuals, concerned about the acquisitive instincts of relatives or others, designate an *anak ba'gi*.

e. Adopted children: adoption of children, especially small children, is common practice. An incentive for adoption can be childlessness, but this need not always be the case. Usually one adopts children of more or less close relatives. A request to adopt a child is hardly ever denied. One motivation for the custom is that adoption reinforces family ties. Adoption is accompanied by a ceremony. A pig is slaughtered. The blood of the sacrificial animal is collected by the *to minaa* ('priest') into a bamboo cylinder. With this blood the palm of the right hand of the child concerned is smeared, and its forehead is daubed. My informant added the following commentary: "Bloodying the right hand takes place because this is the hand used in work, the staining of the forehead because the brains must be employed to think".

Adopted children are treated like one's own legitimate children. The adopted daughter of a *to parengnge'* (see III.1) couple was married to a Muslim in Ujung Pandang who mistreated her: he beat his wife. Her parents by adoption heard of it. With the help of Toraja who belonged to the army they had their child with her children removed from her husband's home and brought back to them in Toraja land. "There is always food for her and her children in our house", the old couple remarked.

There are various sorts of adopted children. Some are *disanga anak*: persons not necessarily adopted when still children but, more commonly, as adults because they have done a great deal for their new father, supported him, for example, in a lawsuit. *Anak disarak*, on the other hand, are foster children adopted at an early age; usually these are the progeny of relatives, even distant ones. Such *anak disarak*, also known as *passarak*, are often weanlings, babies taken from the breast of their mother.

f. It can happen that a man, whether married or not, lives together with another woman without formalizing the relation in marriage. Their child, an *anak panggan* ('a 'betel' child') enjoys the same rights of inheritance on his father's side as an *anak sangtepo*. The child can inherit more, however, should its father choose to recognize it officially. Yet, in any event it never inherits as much as any half-brothers and half-sisters born from the father's legal marriage.

Here let us return momentarily to the Torajan laws of inheritance, in particular to the concept of *ba'gi*. *Ba'gi* signifies a share in the estate of one's parents. As our exposition will have made explicit, next to children others too can be eligible to receive *ba'gi*. Three categories of 'outsiders' who can be recipients of *ba'gi* are distinguished:

- a. the giving of *ba'gi* to illegitimate children;
- b. the giving of *ba'gi* to a courageous and/or capable person;
- c. the giving of *ba'gi* to someone who is of noble blood.

a. Above, we argued that one's 'own' children, the offspring of a legal marriage, have precedence in matters of inheritance. Even in apportioning shares to these legal heirs the law is complex: every child, whether son or daughter, inherits from father and mother in proportion to the number of buffaloes and pigs which he or she provides on the occasion of his or her parent's death ritual; the majority of the animals contributed are slaughtered. The inheritance consists as a rule of fields. Other categories of children, however, are not excluded from inheritance: collectively, legitimate children share $\frac{3}{4}$ of their parents' estate, and all 'illegitimate' children divide up the remaining quarter.

b. and c. As far as these categories are concerned, the search for protection entails providing one's protector with a share in the inheritance. He, too, is obliged to slaughter buffaloes and pigs at the death ritual. Similar responsibility devolves upon the shoulders of the

nobleman who is accorded *ba'gi*. The entire procedure of inheriting thus acquires something of the nature of a transaction. Legates are not obliged to provide animals for slaughter should later a close relative of the legator die, although they may continue to give support to the family of their benefactor. My informant (B. Sarungallo, Kesu') saw fit to complement this résumé of Toraja inheritance laws with the following: there exists a custom known as *mangrinding* ('the raising of the wall'). People put buffaloes to death at a mortuary ritual with the aim in mind of receiving *sawahs*. Only a member of the deceased's family can make such an offering, but not before negotiations have taken place with the children of the deceased (or with his siblings if he died childless). Besides, qualification by kinship is restricted: only first cousins of the deceased, male or female, can 'raise a wall'. And no more than one buffalo and one pig may be killed towards this end. In addition the *sawah* bestowed must be returned at the death of the recipient, reverting to the original legator's legal heirs. 'Raising a wall' involves only a solitary *sawah*, or a portion of the harvest from a ricefield. Whoever slaughters the requisite beasts is given back a part of the offering: a foreleg from the buffalo and a section from the hindpart of the pig (*pa'longkona*). The custom is observed throughout all of Tana Toraja.

Suspension of obligations that usually follow upon the presentation of gifts is called *unrampanan doke biang* ('the releasing of a spear that resembles the *biang*-reed'). It is conceivable — although my informant did not put it this way — that *unrampanan doke biang* aims at preventing wealthy relatives from taking advantage of the opportunity to slaughter beasts at a mortuary ritual principally for the express purpose of being rewarded with land, ricefields in particular. To that end limits must be set to the number of animals contributed for sacrifice.

Finally it remains to be recorded that when a married couple is childless, their heirs are those children of their brothers and sisters (and not these siblings themselves) who have been formally adopted. Any adopted child originating from a union outside the family of the childless pair numbers among the *anak sangtepo* when the time arrives for distributing the inheritance.

The preceding account reveals that the sacrificing of buffaloes and pigs has a significant impact on the distribution of inheritance. Rules for slaughtering animals are not merely confined to 'ties of blood' or related to considerations of class. Persons who, biologically speaking,

are no kin of the deceased can nevertheless participate in his legacy. (For further information concerning adoption and related matters, see A. C. Kruyt 1923/24: 126 and Nobele 1926: 33-34.)

II.6 Summary

Chapter II presents evidence that as the kinship ties which relate a person to the first ancestor or founder of an eminent *tongkonan* grow more tenuous, the position of that person in Toraja society becomes slighter. In former times it was possible to improve that position by acts of valour in war, or by amassing wealth. At present accumulation of riches still assists efforts at social betterment. During the modern era, moreover, new opportunities for rising in the social scale have emerged which have to do with the profession one pursues. Nevertheless it remains difficult for those of low social class to gain access to significant, well-paying job opportunities.

The Toraja kinship structure must be viewed in connection with social stratification and ritual practice. This point, however, remains to be pursued towards the end of Vol. II.

ANNEX IIa

KINSHIP TERMINOLOGY

ambe'	Fa
indo'	Mo
pa'amberan } ambe ure }	MoBr, FaBr
pa'indoran } indo' ure }	MoSi, FaSi
nene' (nene' mammi)	grandparents (extended to relatives of their generation)
nene' guntu' (nene' uttu')	greatgrandparents
nene' salemberan	greatgreatgrandparents
nene' todoan	greatgreatgreatgrandparents
anak muane	son
anak baine	daughter
bongsu	youngest child

pa'anakan } anak ure }	nephew, niece
ampo	grandchild
pa'ampoan	Br's or Si's grandchildren
ampo guntu'	greatgrandchildren
ampo salemberan	greatgreatgrandchildren
ampo todoan	greatgreatgreatgrandchildren
sang (anak) muane	Br, FaBrSo, FaSiSo, MoBrSo
anak dara	Si, FaBrDa, FaSiDa, MoBrDa, MoSiDa
kaka	elder sibling, elder cousin (as term of address: kaka')
adi	younger sibling, younger cousin (as term of address: adi')
sampu	cousin (first, second, third)
sampu pissan	first cousin
sampu penduan	second cousin
sampu pentallun	third cousin
sile' to loloku } siulu' lanmai tambuk }	full siblings
siulu' dio indo'	half siblings (same mother)
siulu' dio ambe'	half siblings (same father)
muane (ku)	husband
baine (ku)	wife
mamintungku muane	son-in-law
mamintungku baine	daughter-in-law
matusa	WiFa, WiMo, HuFa, HuMo
ipa'	BrWi, SiHu, HuBr, HuSi, WiBr, WiSi
sanglalan	HuBrWi, WiSiHu
baisen	parents of child's spouse
rampean	cognates (whatever the relation)

CHAPTER III

THE CLASSES

“Then Datu Bakka’ and Pong Maleleong,
completely exhausted, bowed their bodies,
thereon they were treated like buffaloes
used for work on the ricefields,
they were handled like *kerbau*
used for labour on the *sawahs*.”

(Merok: 137)

III.1 Class division in Kesu’

III.1.1 *Kesu’*

In the district of Kesu’ the society of the Sa’dan-Toraja displayed rather sharp class divisions. The myth which relates how separation between the free and the unfree originated, is told in the *Passomba Tedong*, the chant recited at the consecration of the buffalo sacrificed at the *merok*-feast (Merok: 110). Pande Nunu (‘the skilful observer’) ¹ married Kandaibubun of Illin. This woman, also called Tumba Bollan, ² wore a bracelet made of clay, and an anklet fashioned of an alloy, probably not including gold, silver or brass; ³ these ornaments betray that she was a slave. Female slaves were not permitted to wear ornaments of such precious metals. Pande Nunu consumed the left-overs from his brothers’ meal, an act further associated with the class of the unfree. Two children were born to this pair, two sons, Datu Bakka’ and Pong Malaleong (though *datu* means ‘lord’, the title *datu* is not associated with nobility). When the ‘House of Iron’ in the upperworld had been completed (Merok: 132-133) and the buffalo for the primeval *merok*-celebration was about to be sacrificed, firewood had to be chopped, and branches which would cast dense shadows needed to be inserted in the earth. These tasks were assigned to Datu Bakka’ and his brother, ⁴ but they refused. What is more, they wanted to marry with women from the group which they considered as their equals; because, they replied to their brothers: weren’t they

all one big family, Datu Bakka' and Pong Malaleong and the rest who took part in the feast? Hadn't all their fathers originated from the cinders of Puang Matua's forge? The others conceded this point, but confronted the pair with the fact that their father had taken a wife from Illin who wore a bracelet of clay (in traditional Toraja society the children of the marriage between a free man and a slave, usually belonged to the class of their mother).

The two objectors did not want to be treated like buffaloes that had to work on the *sawah*. Then, from the center of the firmament, it was solemnly declared that they should give in; nevertheless, they remained headstrong, even after divine judgement was delivered through means of a cock-fight. Only after they were beaten in a fight did they yield. There were no women, however, who were willing to become their wives. Puang Matua then sculpted a doll from clay, calling it Potto Kalembang. The Prince of the Wind blew life into the image, however, only after he had been trapped in a net and persuaded by Puang Matua. Since Datu Bakka' and Pong Malaleong laboured in the *sawah* just like a buffalo; they bent under the yoke, even as animals. And in this way the division into classes became established almost immediately after the creation.

Since the nomenclature of the classes in Sa'dan-Toraja entails certain difficulties, translations of terms in common use are offered with reservations. One might classify the most important group of the *to makaka*, the *anak patalo*, as nobility, or else call the entire group *to makaka* ('free farmers'); my informant Bua' Sarungallo, however, speaks of the latter as 'noblemen', thus contradicting Van der Veen who has chosen for the less inflated term above. The lowest class seldom owns any land, yet someone who belongs to this class can have possessions of some other nature.⁵ The ownership (and use) of certain objects, however, was the privilege of the members of the higher classes. That this in general remains true today will become evident shortly.

The designation *slave* is perhaps more appropriate than *serf*. Many years ago, Fahrenfort contended that, in a certain sense, it mattered very little whether one spoke of slaves or serfs: the overriding criterium was that work was performed in bondage (Fahrenfort 1943: 31). Those in the Toraja society who belong (or belonged) to the lowest order did render labour under compulsion in the past. Accordingly, we refer to them as slaves; the Toraja term (which is still in use, although not openly) is *to kaunan*.⁶ In Buntao' the name *potto kalembang*

bang was also current (see the name of the clay doll in the summary of the *Passomba Tedong* already presented).

Different kinds of slaves existed:

1. slaves who were born as slaves;
2. those who were enslaved by being taken prisoner during war;
3. those who, either from anxiety or because adversely had plunged them into destitution, sought protection by allying themselves to a rich and/or powerful master; these slaves were called *kaunan mengkaranduk*. They had the right to buy back their freedom (see chapter V);
4. condemned thieves;
5. those who incurred debts which they were unable to pay off (*kaunan sandang, kaunan indan*). By meeting their debt they could reclaim their freedom without having to pay the one hundred head of livestock, etc. which an ordinary slave had to pay to gain his emancipation (see III.7).

(Note: no account was given whether slaves of category 4 could regain their freedom like other slaves.)

The status which a *kaunan* enjoyed varied. Household slaves, *kaunan garonto'* or *kaunan bulaan*, could never be sold.⁷ Many of the masters of these *kaunan*, moreover, worked on the land themselves excessive efforts were not demanded of their slaves. Industry and obedience, however, were expected of the *kaunan*:

“Hail to the dutiful slaves,⁸
abundant be the blessing
upon the obedient members
of the house.”

(Merok: 22-23, verse 21)

Prior to the arrival of the Dutch, coffee and slaves were the leading 'export products' of the Toraja lands. To threaten a *kaunan* to sell him into Buginese territory sufficed to induce him to work hard. Such a sale would land the unfortunate slave in alien surroundings. Slaves were exported to Luwu' (Palopo) and Parepare. In 1969 people of Tana Toraja still enjoyed telling the story of Ne' Pakunde, already a very old man at that time, who once had sold himself into slavery:

his friend delivered him to his owner, but then the very night of the transaction, Ne' Pakunde fled. Later he divided the profits of his sale with his friend.

The treatment of a slave depended on the nature of his master; there were good and bad slave-owners, and their conduct will explain why descendants of *kaunan* remain embittered or thankful even today. In gratitude for past benevolence, the descendants of former slaves are disposed to lend assistance during certain rituals, carrying out tasks considered as slaves' work.

In theory slavery passed into desuetude in 1906. Although the establishment of Dutch authority precluded further commerce in slaves, class divisions persisted without immediate disruption. Slowly, however, the formal abolition of slavery bore fruit. Children of slaves were afforded the opportunity of attending school and ascending the social ladder. Nevertheless, in certain cases dependency persisted in the form of patronage.

All restrictive regulations which previously obtained for members of the slave class have been abandoned today. Slaves were forbidden to wear ornaments of precious metal or brass; female slaves, moreover, were not allowed to adorn themselves with armlets made of shell. Nor might a *kaunan* eat from the dishes of his owner. They should never sit on the front part of the floor of the rice barn. The hairstyle of female slaves and their children differed from that of women and children of rank. Slaves had to forgo batiked headcloths and certain kinds of bamboo fillets. Those of the unfree class were not permitted to inhabit a house decorated with wood carving; nor might they use an oblong wooden rice pounder, or own one hewn from stone. Such limitations are a thing of the past, but although in principle all Toraja today may wear and use whatever cloths and objects they please, still, especially during rituals, descending of *kaunan* behave with caution. Heirlooms and regalia are only put on by those who belong to traditionally pre-eminent families in Toraja society.

It has become apparent, I hope, that all slaves were not equal. Some differences were of consequence. Household or compound slaves, the *kaunan garonto*, occupied a privileged position. Upon their death they were entombed in the cliff grave of their master, in the same cavern, although in a separate section. A master had not only rights over his slaves, he had responsibilities to them. He had to feed and clothe them. For his work in the fields, a *kaunan* received

every morning a coconut-shell full of boiled rice; for his family he was given every day a coconut-shell filled with uncooked rice (no mention is made how family size might affect this ration). Should a slave die and his family have no means to provide for his burial, his master came to their assistance. Such funerals never followed the procedures of the high orders of burial, but were restricted to, maximally, the *tallung bongi*, the mortuary ritual which lasts three nights (see Vol. II).

That slaves were cherished is amply demonstrated by the praise that is lavished on them during the *bua' kasalle*, a ritual of the highest order. The eulogy was recited by the *to minaa* (a category of priests) in a poem of set contents. This *singgi' kaunan sola pia* ('laudation of the unfree and the children') has been translated and annotated by Van der Veen (Van der Veen 1979: 276-296).

Many of those once classed as slaves have since worked their way up to prosperity. Even formerly, however, despite restrictions, a slave could manage to climb the social ladder. Though unfree he was permitted his own possessions; if he tried he could purchase his freedom, particularly if he had many children who also had property of their own. To become free he had to deliver a hundred items of everything to his master, a hundred buffaloes, a hundred agricultural tools, a hundred household effects, etc. The number *one hundred* should, however, be interpreted symbolically. The price of freedom could involve handing over as few as three buffaloes. Emancipation by purchase was marked with a feast, possibly even with a *merok*-feast (see Vol. II and *Merok*: 2). Buying one's freedom was called *talla'*.

A slave could never marry a woman of any class above him. Should he do so (and presumably sexual intercourse was included in the prohibition) the couple would be found guilty and sentenced to be burned to death. It is uncertain whether this penalty was ever actually carried out. Anyhow, today this taboo no longer retains its former force.

Kennedy (1953: 154) presents the following information about marriages between partners of different classes and the consequences for their children; he acquired his data from Mr. W. Papajungan:

- “1. Father noble — mother commoner: child commoner.
2. Father noble — mother slave: child slave.
3. Father commoner — mother slave: child slave.
4. Mother noble — father commoner: formerly taboo, now may be possible (I have one case): child noble.

5. Mother noble — father slave: formerly very taboo, now may be possible (I have no case of this): child slave. Formerly, partners in such a marriage were killed by drowning or burning.
6. Mother commoner — father slave: may be possible today, formerly taboo. Child slave.”

It is not altogether clear to what part of Tana Toraja Kennedy's scheme pertains, to Tikala or Kesu' (as far as his *tongkonan* is concerned, W. Papajungan belongs to both areas). In any event, the information does not make mention of any resultant intermediate classes, and its emphasis falls on the matrilinear character of descent. Yet, we will soon find occasion to note that they sometimes deviated from the rule a mother's class defines that of her children.

A man of high rank might indeed marry a slave; according to a woman of the highest class, now living in Buntao' but native to Ranteballa, the children from their union would then belong to their mother's class. This informant told me that her half-brothers and -sisters, born from the marriage of her father with a *kaunan* woman, were not supposed to remain in the same place that she did during feasts: for example, they might never sit on the floor beneath the rice barn. An informant from Kesu', however, revealed that the descendants of a *to parengnge'* man and a *kaunan* woman were known as *to makaka direngnge'* and constituted an intermediate class (see below). This report contradicts the views proposed by Kennedy's source, W. Papajungan. The explanation for the clash of information lies in the fact that the children of a wealthy *to makaka* and a slave belong to the intermediate class while those of a poor, free farmer and a *kaunan* woman will be classified according to the class of their mother. Surely, the prosperous *to makaka* would not have found it to his liking should his offspring be classed with the slaves. Wealth often means influence; prosperity commands a certain respect.

As far as the free are concerned: the *anak pare pare nangka* (alternatively, *anak passasaran tuyu*)⁹ constitute an important group in the class of the *to makaka*. The group includes the *anak patalo* and the *to parengnge'*. The former are descendants of leading *tongkonan*. They have authority in such matters as: the maintenance of security in their settlement, the promotion of its progress and general well-being, the settling of disputes and the specification of the *kapa'* (see II.5.2 above). In time of war, they are commanders.

The name *to parengnge'* derives from *rengnge'*, the manner in which

women carry a load.¹⁰ The load is borne on the back by a rope which is looped around the woman's forehead so that part of the weight is effectively displaced onto her head. Metaphorically this stands for: bearing the responsibility for the ceremonies celebrated by the *tongkonan* (*Woordenboek v. rengnge'*). The *to parengnge'* are the ritual leaders of the rites of a *tongkonan* which has a title. According to Mangesu' Matandung (1973: 26-34) the term *parengnge'* refers to a class; according to Tangdilintin (oral information) the word alludes to a title, just as *puang* does. Although today members of the *puang's* ramage often are addressed or referred to as *puang*, Tangdilintin maintains that in former times only the ruler was called Puang. The point is that the *parengnge'*-ship always involves specific functions and thus is an office with diverse content. The occupancy of the office, however, is usually the prerogative of a certain class. The association with class is particularly striking among the *to makaka direngnge'* who can be regarded as an intermediate class between the *to makaka* and the *kaunan*.¹¹ Should something important be on hand in their family, they are obliged to bring news of it to the *anak patalo* and the *to parengnge'*. As mentioned above, the *to makaka direngnge'* sprung from marriages between *anak pare pare nangka'* men and *to kaunan* women. Their children did not belong to their father's class, yet they were not slaves either. It is true that upon their deaths the mortuary ritual observed is that which is customary for members of their mother's class. Nevertheless, should the deceased's father be an *anak patalo*, it is possible that he has his child buried in keeping with a more elevated ritual.

The *anak patalo* (and also the *to parengnge'*) wear special clothing on certain occasions. Also in daily life they wear distinctive ornaments, e.g. the *tali pakkaridi'*, a hair ribbon (*Woordenboek v. tali*). Their wives wear bracelets made of gold, silver or brass or crafted from shells. The small children of *anak patalo*, *anak pare pare nangka'* and other distinguished members of society have their heads shaved smooth except for a square tuft on their foreheads. With children of low station the hair around the top of the head was left unshaven.

The *anak patalo* have other privileges as well: only members of this class and *to parengnge'* are entitled to sit upon the floor under the rice barn. During the laudation (*ma'singgi'*) the *anak patalo* are the first to be praised, followed by their wives and children. Should a commoner be eulogized, this means that he had previously asked permission. On other occasions than a *bua' kasalle*-celebration it is

a rare exception for a slave to be lauded; if it happens it is upon his master's proposal. Women of high rank (*anak pare pare nangka'* or *anak passasaran tuyu*) were during *ma'singgi'* addressed by a special title: *simbolong manik* ('hairknot, shining like beads'), or, synonymously, *lokkon loë rara'* ('coil of hair, dangling like a golden neck ornament'). The same designations are used to refer to these women during large-scale gatherings.

With respect to rituals, class divisions have profound significance in Kesu' and elsewhere. The *to parengnge'* function during special feasts, serving the offerings and performing appointed tasks in the rituals of the feast, the rituals of the *deata* (see Vol. II). For this reason they are called the *to parengnge' aluk rampe matallo*. In most districts the death priests, however, come from the lowest class, the *to kaunan*. They are also known (in Kesu' and Buntao') as the *to parengnge' aluk rampe matampu'*, the *to parengnge'* of the ritual of the West. They perform their functions in that part of the mortuary rites which is looked upon as impure (in the sense of not yet having been purified).

In this context mention must be made of information contending that the terms *anak patalo*, *anak pare pare nangka'*, etc. originated after the war with Bone and that even the title of *sokkong bayu* dates from this period (information by Ne' Sangga, Ba'tan, Kesu'). This would imply that the *to parengnge' cum suis* are the descendants of those who, in this war, distinguished themselves meritoriously. The same informants added that, before that time, all authority (secular as well as sacral) was vested in the *to indo'*.¹² *To indo' padang* is the present term for rice priest. *Indo'* or *to indo'* is also used in the sense of a person bearing authority: see *indo' tondok* ('village head'), *indo' bua'* ('leader of a *bua'*-community'). *Pekaindoran* is the title of the chief of an *adat*-community.

The honorific designation *pekaindoran* is still in use today along with that of *pek(a)amberan*; the former title is, perhaps, the somewhat more exalted of the two. The terms are derived from *indo'* ('mother'), and *ambe'* ('father'). The persons of authority mentioned above are practically always males, and therefore *indo'* alludes not to his sex, but to the motherly care, which a leader is supposed to devote to the community. The title *indo'* has possibly been displaced by the titles *to parengnge'* and *anak patalo*; and has remained in vogue in the appellation *to indo' padang* ('the leader of the rice ritual'). Rice rituals belong to the *aluk rampe matallo*, whereas the

to mebalun ('the death priest') performs in the *aluk rampe matampu'*. The hypothesis suggests itself that, before the war with Bone, the Sa'dan had much simpler hierarchy, confined to the distinction of functionaries of the East from functionaries of the West. Informants are equally emphatic, however, that class divisions already existed in the upperworld, a point of view which clearly contradicts the hypothesis that social stratification is of rather recent origin! Equally inconsistent with this hypothesis is other information, confining that *to burake*, *to minaa* and *kaunan* were already extant before the *untulak Buntunna* Bone ('the war with Bone'). In death chants the *to burake* is invariably described as the one who preceded the *to manurun* in their way down to earth by rainbow (The Chant: 24-25).

Finally, for the identification of the classes with particular kinds of buffalo, the reader is referred to VII.1 and to Merok: 128-129.

In his discussion of class divisions, Kennedy prints the following absolute numbers and percentages for the different wards of the village of Marante in Kesu' (Kennedy 1953: 159, 160).

Marante:

<i>wards</i>	<i>Tondok</i>	<i>Bone'</i>	<i>Balatana</i>	<i>Linda</i>
<i>former slaves</i> (total)	86	82	119	207
men	(35)	(45)	(55)	(104)
women	(51)	(37)	(64)	(103)
<i>commoners</i> (total)	76	217	129	551
men	(36)	(109)	(66)	(279)
women	(40)	(108)	(63)	(272)
<i>nobility</i> (total)	97	80	10	30
men	(50)	(38)	(7)	(15)
women	(47)	(42)	(3)	(15)
<hr/>				
% slaves				
(= former <i>kaunan</i>)	33	22	46	26
% commoners	29	57	50	70
% nobility	38	21	4	4

All in all 29 % of this village belonged to the previous slave class, 58 % to the class of commoners and 13 % to the nobility. While the former *kaunan* class had a surplus of women, there were more men

than women, by a small amount, among both commoners and nobility. The sexual imbalance suggests that males from the higher classes are impelled to find a marriage partner from women in the lowest class.

III.1.2 *Nonongan*

In *Nonongan*, part of the federation of *Kesu'* (see IV.1.6) and yet separate as far as social organization is concerned, the following classes are found:

- a. the *gora tongkon*, a category analogous to that of the *anak patalo* (in *Nonongan*, the latter term is used for young people of the noble class). A *gora tongkon* ('sitting crier') has expert knowledge of *adat*-regulations and sacrificial ritual; although he does not preside over offerings, he gives instructions. In meetings, whenever *adat*-affairs are discussed, he is one of the speakers;
- b. the *anak pare pare nangka'*, see *Kesu'*;
- c. the *to makaka*;
- d. the *to makaka direngnge'*;
- e. the *kaunan*;
- f. the *kaunan tai manuk*, the slaves of slaves.

Among the *kaunan* are those who fulfil specific functions in rituals for the dead. Besides there are the *to indo'*, the *to minaa*, the *to mebalun* and other functionaries. In this society a person of vast knowledge who occupies an important position is called a *manete patimmi'* (*manete* = ridge pole; *patimmi'* = ?).

Another significant division which slightly deviates from the class structure as sketched above is of particular importance in connection with the *kapa'*, the fine to be paid in the event of divorce (see II.5.2). The relevant terms refer to the number of buffaloes included in the *kapa'*:

- a. *tana' bulaan*, 24 buffaloes;
- b. *tana' bassi*, 6 buffaloes;
- c. *tana' karurung*, 2 buffaloes;
- d. *tana' kua-kua*, 1 pig.

Tana' denotes: 'to drive in a peg or stake'. Metaphorically this means, acknowledging a case as a precedent, a rule for future decisions. *Tana' bulaan* ('the golden stakes') are the rules applicable when a man of high nobility violates marriage regulations; *tana' bassi* ('the iron stakes') obtain when a member of the *to makaka* class breaks

the marriage laws. The *tana' karurung* ('stakes from the hard core of the sugar palm') determine the *kapa'* for persons of low rank (probably the *to makaka direngnge'*); the *tana' kua-kua* ('the stakes of reed') are in force for people of the slave class (see also *Woordenboek*: 674). Contradicting of the marriage is the right moment for fixing the number of buffaloes, i.e. for determining the level of the *kapa'*.

In this context mention must be made of the *tombang*, the sacrifice brought upon the occasion of a divorce which is accepted as legal. The abandoned party makes the sacrifice after having received the fine (*kapa'*) paid by the partner who sundered the relation; a basket filled with pieces of pork and boiled rice is sent by the recipient of the *kapa'* to his or her ex-mate (*Woordenboek*: 754 *tombang*).

A person of *tana' bulaan* standing who breaks his marriage bond thus pays 24 buffaloes to his wronged wife; or, if she is the guilty one, she indemnifies her husband with the same number of animals. When, later, the recipient of the *kapa'* dies, his or her family must send the head of a buffalo to the party who paid the fine (*baleatang*).

Kapa' is not the only indication of a person's class. Dining accessories are, too. An important *to parengnge'* has his own *dulang* (a dish on a high pedestal). No slave may eat from such a *dulang*. He may never, indeed, use any of the dining accessories of the upper classes. *To makaka kandeian* are *to makaka* who have their own dishes.

The subdivision of the *to makaka* class in Nonongan shows that, as in Kesu', it is not a homogenous group.

III.1.3 Titles and duties

The following information pertains primarily to Kesu'. Some of the titles about to be cited will be discussed more elaborately in IV.1.4 and IV.2.2. An important *tongkonan* has a specific function with a title attached to it. Should the titleholder die, then a new *to parengnge'* is proposed to fill the *to parengnge'*-ship. This can be the oldest son of the deceased *to parengnge'* but he is not necessarily the preferred candidate. He must be well informed on matters of *adat* and ritual, and be known as a man who displays the requisite character traits. Installation of the nominee takes place during a great feast, such as, for example, the *merok*. A village meeting (*kombongan*, *kombongan kalua'*: large, important village meeting) makes the final decision about who is to succeed to the post. The *sokkong bayu* runs the meeting, or, if this function is vacant, then the *datu baine* presides.

For the rest the *kombongan* is composed of the other *to parengnge'*, the *anak patalo*, the *to indo'* and the heads of wards and *saroan*.

The *sokkong bayu* is the highest titleholder in a particular area. The area can be a *patang penanian* (see IV.1.3) as in Buntao', for example, or of a village, or a stretch of territory which encompasses half a village, as, for example, is the case in Angin-angin, Kesu'. The term *sokkong bayu* is not used in Buntao'. Here the person who occupies the office bearing the title of *sokkong bayu* in Kesu', is called *issong kalua'* ('the great rice mortar'), just as in Pantilang.

In Tikala and in the *lembang* Sa'dan, the titles *sokkong bayu*, *issong kalua'*, etc., and other important titles, do not exist. At major feasts in Tikala e.g. *merok*, the buffalo is consecrated by the head of a *tongkonan* to which tradition entrusted this role.

The *sokkong bayu* (respectively, *issong kalua'*) is the head of the foremost ramage in the *adat*-region, the *bua'*-circle (*penanian*). He is the spiritual as well as the worldly leader of his cognatic descent group. He has an important function in rituals and a decisive vote in the settling of disputes. He often is a man of strong personality. Allo Rante (Ne' Sangga), the late *sokkong bayu* of Ba'tan in Kesu', was praised for his patience, his tolerance and his wisdom. He was thoroughly steeped in *adat*-regulations. The knowledge of a *sokkong bayu* can exceed that of a *to minaa* ('priest'). Then he is called '*sule to gandang*' or '*solonna tandilo rante*' (respectively: 'the substitute for the drum', or 'the companion of the *tandilo*').¹³ The function of *sokkong bayu* (or of *datu baine*, see below) often coincides with that of village head. For the *to parengnge'*, see also IV.2.

It is of importance that every *to parengnge'* has a particular task, a function described in detail in some of the more important rituals. In the *puang*-regions (the *Tallulembangna*) *puang* is the highest title (today used also to address the immediate male and female kin of the ruler, i.e. his siblings and children).

III.2 Classes in Sangalla'

For class divisions in Ma'kale, the reader should consult Nobele (1926: 15-35). About slaves he writes: "Although officially they no longer exist, the *to kaunan* (slaves) still retain their name and place in Toraja society and most of them have remained voluntarily with their former masters because, gradually, they have come to think of themselves as members of his family and, as a rule, have not fared so poorly in their dependent state" (Nobele 1926: 17).

For Mengkendek no relevant information is provided; yet the class divisions there are likely to agree with the pattern outlined below for Sangalla' which, in turn, closely resembles that obtaining in Ma'kale.

In Sangalla' the following classes are distinguished (informant Puang W. P. Sombolinggi):

- a. *Puang Massang* (*puang Ma'mimi*); (*Massang* = *Ma'mimi* = pure; *puang*: of pure blood). This is the highest class. Its members are said to have white blood (a way of speaking comparable to the western phrase 'blue blood');
- b. *anak disese* (*anak posese*) sprouted from marriages between members of the *puang massang* and *to makaka*;
- c. *to makaka*, free people;
- d. *to kaunan*, slaves, with the *kaunan tai manuk* as a separate category. There were various kinds of slaves:
 - slaves who had been purchased;
 - slaves who had sought a master for protection (*kaunan mengkaranduk* or *to umbang kalena*);
 - *kaunan bulaan*, whose position can be compared to some extent to that of the *kaunan garonto*' (see III.4 above).

The slaves came down from heaven together with the *puang*. The *kaunan tai manuk* ('chickenshit-slaves') were the slaves of slaves (according to information which I received in Nonongan, these lowest of the low existed also there). In the *puang*-regions (as elsewhere) it is impossible to ignore distinctions among the unfree. *Kaunan* who filled a particular function in the palace, the *tongkonan layuk* of the *puang*, held privileged positions. Their posts were hereditary.¹⁴ The *kaunan bulaan* are more reminiscent of court dignitaries than of slaves in the sense currently attached to that word. For further illustration, the reader may refer to the section in the following chapter dealing with the structure of the Sangalla' principedom.

The class division summarized above is, to an extent, affected by a person's wealth, a connection allowing for a certain kind of social mobility. One might possibly distinguish an intermediate class between the *to makaka* and the *to kaunan*. In Sangalla' *anak patalo* are found, too. They are either *anak disese* or *to makaka* and are socially influential. Just as in Kesu', Sangalla' also has its *to parengnge*' whose election follows the same procedure. The *anak disese* may be elevated to the rank of *puang* should no true *puang* exist. The people must

grant their approval for such promotion (the term 'the people' probably refers to a meeting of the *To A'pa'*, etc.; see IV.1.4 under Pantilang). In keeping with the *ma'talla'*, the process of buying oneself out of slavery, a slave could graduate to the class of the *to makaka*.

As far as *kapa'* is concerned:

1. the *puang massang* fell under the *tana' bulaan*;
2. the *anak disese* might abide by either the *tana' bulaan* or the *tana' bassi*;
3. the *to makaka* fell under the *tana' bassi*;
4. the *kaunan* fell under the *tana' karurung*;
5. the *kaunan tai manuk* also fell under the *tana' karurung*.

The *puang massang* are indeed the most important members of this society. The ruler, the *puang*, was highly respected. The same held true for other descendants from his ramage, who also were addressed with the term *puang*. Today, they continue to enjoy special prestige. The ruler was a charismatic figure. In the old days people believed that the *puang's* bathwater had healing properties. Although a *puang* was treated with veneration, he was nevertheless not untouchable like Polynesian princes. Ordinarily, he went about dressed simply, except on certain festival occasions. Since the Republic of Indonesia installed its authority in Tana Toraja, an end has come to the *puang's* official function as ruler. The way in which individuals belonging to this ramage nevertheless continued to exert their influence, can be gleaned from the article by Eric Crystal entitled 'Cooking pot politics' (Crystal 1974).

It goes without saying that changes have come about as a consequence both of the advent of effective Dutch authority and of Indonesia's achieving independence. Yet, many of the ways of the past have remained intact. The Toraja do not feel altogether at ease when they are questioned about former class divisions. Although these classes are officially a thing of yesteryear, at present it is still the members of the *to parengnge'*, *anak patalo-* or *puang-*classes who monopolize important positions in government employ (and in the army). To what extent lower administrative positions or army appointments present an opportunity for vertical social mobility, fell beyond the scope of my research (see Crystal 1974). Village heads currently in office are for the most part descended from the *to parengnge'*-class which made up part of the old *adat*-system.

III.3 Summary

The complexity of the situation is illustrated by the fact that siblings (in the sense of half-sisters and half-brothers) can belong to different classes. A *to parengnge'*, as far as inheritance and succession are concerned, has no rivalry to fear from his half-brothers and -sisters who belong to the slave class; he need compete only with those siblings who are of his own rank.

Classes originated, according to myth, in the upperworld. Yet, members of the lowest class, despite the fact that their ancestors, just like those of other classes, came from heaven, can never ascend to the upperworld to become a deified ancestor who keeps watch over mankind, over the animals and the plants (the rice crop).¹⁵

As a spirit of the dead person he will fulfil in the other world all the tasks which he fulfilled on earth, such as herding the buffaloes and doing chores which are regarded as humble or unclean.

The leading functionary during mortuary rites is the death priest, 'the lord of the West', he who attends to the rites of the still impure dead. In many districts the death priest belongs to the lowest class and in these territories he is considered as impure. He is diametrically opposed to the lords of the East, the *to parengnge' matallo*.

Yet there is still another boundary line within Toraja society, one dividing the rich and poor. Usually the wealthy belong to the uppermost class and it is they, the *to sugi'*, who are entitled, and financially able, to meet the costs of the major rituals. Only those who are members of the elite and are rich, who own *sawahs* and buffaloes, who are associated with the *sendana sugi'* ('the tree of heaven laden with riches'), who are permitted to wear jewelry of gold, silver, brass or shell, who enjoy sorts of prerogatives, are allowed to give great feasts. Just as in a play, those of high position, the feastgivers and titleholders, have their roles predetermined for them; among the numerous functionaries, however, there are also representatives of the lowest and intermediate classes. As the most prominent rituals in which the subramage plays the leading part, I have mentioned the *merok*-feast and the *bua' kasalle*; one might add as well the rituals for the dead and those feasts which have the *tongkonan* as their center. A description of feasts, to which relatives come from far and wide, will be given in chapter VIII.1 and in Vol. II.

CHAPTER IV

TRADITIONAL SOCIO-POLITICAL ORGANIZATION

“So that the clan members, numerous as bamboo culms, may always increase in wealth, in quantity like the leaves, in order that the branching of the precious things of the ones whose group always increases like a bamboo stool, may continue to swell still more.”

(Merok: 173)

IV.1 Traditional political units

Contemporary Tana Toraja is a *kabupaten* or regency, a part of the administrative structure of Indonesia. It, like all *kabupaten*, has its own bureaucratic apparatus. The boundaries of Tana Toraja are identical to those of the administrative unit bearing that name which existed during Dutch colonial rule; internally, structural changes have been wrought since that era so that at present more of a hierarchic division has been brought about.

The Dutch administrative division of Tana Toraja into thirty-two districts, or *lembang*, adhered to a large extent to territorial divisions as they existed at about the turn of the century. The colonial rulers, though at times they resituated the borders of some of these districts, usually contented themselves with imbuing the original forms of government there with a more modern appearance. What situation prevailed before the actual establishment of Dutch authority?

It appears that the Tana Toraja of today was once subdivided into a vast number of areas of various size which sometimes unified under external pressure — the threat of war — but usually led largely independent existences. They were discrete organizational entities, which often fought among themselves. These various areas are usually called *adat*-communities in literature (see, among others, Merok: 79) without any further comment on what this term really means. Early European travellers like Van Rijn (1902) who journeyed through these areas accumulated fairly little illuminating information about

them. A more satisfactory picture of the *adat*-communities emerged much later, after the papers and publications of, successively, Lanting (1926), Nobeke (1926), Pronk (1935), Seinstra (1940) and Tandilangi' (1967, 1968 and 1969). These studies are of particular importance for reconstructing socio-political aspects of the autochthonic culture of the Sa'dan-Toraja.

IV.1.1 *Adat-communities*

In the discussion which follows, I will try to render the concept of *adat*-community more meaningful, making use in this attempt of literary sources and data from my own research. First and foremost an *adat*-community denotes an autonomous political unit which inhabits a territory of its own and has its own *adat*, or system of customs. Furthermore one or more rituals are celebrated collectively by all members of a given *adat*-community. These rituals resemble to a considerable degree the rituals celebrated in other similar communities in what is known today as Tana Toraja. Yet, there are many local variants which, on occasion, deviate from more common patterns of observance.

Every community has its own sacral artefacts. These fulfil a function in ritual and are symbols of the unity of the group (see VIII.3; a description of rituals will appear in Vol. II). The sacral artefacts are preserved in *adat*-houses (*tongkonan*), several of which exist in any *adat*-community. These houses can be considered as symbols in their own right. Every *tongkonan* is the center of a specific ramage or subramage. The *tongkonan* was founded in the past by a leading ancestor of this *marapuan* or *rapu* and has since remained its social and religious center. A *tongkonan* can improve its status if members of the *rapu* distinguish themselves in battle.

As a ramage expands it eventually undergoes segmentation. The separating subramage then builds itself a new *tongkonan* which, being of later origin, is of lower status. It remains, however, the *tongkonan* of the leading ramage (or ramage) which lends distinction to the territory as a whole. The history of the leading (sub)ramage is closely intertwined with the history of the *adat*-community as such. A number of important subramages can reside in an *adat*-community in addition to the leading one itself. More often than not these are blood relatives of the leading subramage. Furthermore, within the territorial bounds of the community families from the lower classes will also make their homes here.

Not only eminent ramage, but also other families as well, often have a title. The leading family has the most significant title. Titleholders each have a specific area of competence and a concomitant role to perform in ritual. Functionaries also come together on the occasion of meetings, for councils concerning war and peace. One of the titleholders (a man belonging to the most important family) is *primus inter pares*. His voice is usually decisive in settling legal disputes.

The Toraja language has no word for denoting the concept of *adat*-community in general: instead they differentiate a certain rank list of communities according to size and rank. In order of ascending magnitude, *adat*-communities are considered to belong to one of the following four categories:

bua' — or *penanian* (the *bua'*-areas, see IV.1.2);
patang penanian (see IV.1.3);
lembang (see IV.1.4);
tallulembangna (see IV.1.7).

The village as a unit will be discussed in a separate section of the text (IV.2). Although it encompasses a territory in the traditional sense of the word, it differs in some ways from the *bua'*-, *patang penanian*- or *lembang*-communities. The village, moreover, often coincides with a *bua'*-community (it can also include two *bua'*-groups; on the other hand several villages together may constitute a single *bua'*-community).

In the past, the largest territorial unit was the *Basse Lepongan Bulan* ('the League of the Circle, Round as the Moon'), the community which contained all Toraja who waged war against the Bonese prince, Arung Palaka (called Aru Palakka by the Dutch). The region included most of what today is Tana Toraja with the exception of a single territory, Karunanga, which was unwilling to participate. It turned out that the independence of the territories belonging to the confederation was rather substantial so that internal strife was a frequent phenomenon. The *Basse Lepongan Bulan* is an example of an attempt to forge unity under external pressure; as a political institution it had no further identity, or existence.

IV.1.2 *The bua'- or penanian-communities*

A single *bua'*-community includes a territorial area within which the inhabitants celebrate the *bua' padang*-ritual together (*bua'* = to

work; *padang* = land). This ritual is a kind of agricultural New Year celebration with the aim of imploring the higher powers to smile on man, beast and the produce of the fields (in this instance, rice). The word *penanian* originally had a different meaning, for it is derived from *nani* ('to sing'); it signified the performance of choral song during the above-mentioned *bua'*-ritual. The term *penanian* is synonymous with *bua'*-circle; it merely depends on what area or village a person lives in which of the two terms he will happen to use.¹

Here, since the *bua'*-feast will be described at length elsewhere (see Vol. II), I will limit my remarks about the celebration. It should be indicated, however, that the small *bua'*-ritual (*bua' padang*) must not be confused with the great *bua'*-feast, the *bua'*- or *la'pa' kasalle*.

We noted that a *bua'*-unit can encompass half of a village, a whole one or several villages together. As opposed to the *lembang*, a *bua'* seldom has a proper name, although people sometimes refer to it by the name of the relevant village (especially where *bua'* and village coincide).

Although I described the *bua'*-ritual above as a kind of agricultural New Year celebration, this does not mean that the *bua' padang* was ever held annually (or still is; in several regions where large elements of the population have converted to Christianity, this ritual has practically ceased to be part of the present). Rather, celebration was performed on a rotation basis: village A, constituting a *bua'*-circle, observed the *bua' padang* one year, village B (another *bua'*-circle) followed suit the next, village C (with *bua'*-circle C thus) enacted the ritual the third year, etc. In this manner, in the territory of Bungin that made up part of the principedom of Ma'kale, six *bua'*-circles (inhabiting in all three villages) celebrated in turn their *bua' padang* and the cycle was then brought to a close in the seventh year when the *tongkonan* of the prince became the locus of the feast. The following year, the cycle resumed from the beginning.

IV.1.3 *Patang penanian; other penanian-leagues*

A *patang penanian* is a federation composed of four *penanian* or *bua'*-units (*patang* = four) which, apparently, celebrate the *bua' padang*-feast in keeping with a cyclical arrangement like that described immediately above. Members of such a federation make up a larger administrative whole, larger than their own *bua'*-group. The whole is also more than the sum of its parts, for there is an *adat*-chief for the *patang penanian* as an entity (he is supported in his office by a

number of *adat*-chiefs of somewhat lesser status; for additional information, see the description of Buntao',² IV.1.5).

The members of a *patang penanian* observe an important ritual together, such as, for example, a *merok*-feast or a great *bua'*-feast, the *bua'*- or *la'pa' kasalle*.

A *patang penanian* can itself be in turn part of a larger federal union, or even of a state. Thus La'bo', a *patang penanian* consisting of four villages (= four *penanian*), Mengke'pe, Marante, Tandung and Karatuan, is itself a member of the federation of Kesu'.

There are also *penanian*-federations in the princedoms of Sangalla' and Ma'kale. In the former the bond has the form of a *patang penanian*; in the latter, two forms of union are found, the *karua penanian* ('the eight *penanian*') and *sangpulo dua penanian* ('the twenty-two *penanian*'). The eight members of the *karua penanian* are all situated in or near the village of Lemo; the twenty-two members of the other league are all clustered in the vicinity of Awa. It is not apparent to me how these smaller federations function in the context of larger socio-political units.

IV.1.4 *The lembang*

Lembang means proa or ship. The term is also used to denote a territory of varying compass. In its widest sense it is used in the context of the myth of origin: in the dim past the Toraja crossed from the island of Pongko' to arrive at the mainland of Sulawesi; presumably they then followed the course of the Sa'dan River in their proas. In the long run the area where they settled stretched to the borders of the present-day Tana Toraja, here called a *lembang* bearing the exalted name of *Tondok Lepongan Bulan, Tana matarik Allo* ('Land forming one whole round as the Moon, Land that has the shape of the Sun'). According to Tangdilintin (oral information), the place where the To Rongkong and the Mamasa Toraja live also falls within this region. Van der Veen disagrees, arguing that *Tondok Lepongan Bulan* etc. is the name of the league that the Toraja formed in order to fight against Aru Palakka (see I.5) and that this league contained all of contemporary Tana Toraja except for Karunungan. At present the term *lembang* is more often used in the sense of an administrative unit, one part of a district in the modern sense of a *kecamatan*. In these pages I will only use the word to denote an *adat*-community governed by a single set of laws, a group of people inhabiting a certain territory of larger dimensions than a *bua'* or

penanian. Such usage is well-founded on Toraja tradition which refers to the three *puang*-states of Tana Toraja as the *Tallulembangna* ('the three *lembang*').

During Dutch rule, such a traditional territory was usually made into an administrative district. As a rule such a *lembang* can be described as a federation of different *bua*'-circles or of various *tondok* ('villages'). Three to nine *bua*' usually constitute a *lembang* but the number can rise. Every *lembang* has a leader, an *indo*' *lembang* or *ma'dika lembang*. Some *lembang* are princedoms under a *puang*. Such mini-states will be discussed separately to the extent that they belong to the Tallulembangna communities (see IV.1.7). The same applies to the federation of Kesu' which will also be examined in a separate subsection (IV.1.6).

We shall now survey the *lembang* in Tana Toraja. Their locations are indicated on the map of the administrative districts in Tana Toraja created during the period of Dutch rule (Map 2). Although these administrative units do not always coincide exactly with the autochthonic *lembang*, their outlines so frequently coincide that Map 2 can be accepted as adequate to our purpose here. Excluded from the survey are the *lembang* formed by the three *puang*-realms of Ma'kale, Mengkendek and Sangalla' and the *lembang* of Kesu' and of Buntao', all of which will be discussed apart (see IV.1.7, IV.1.6 and IV.1.5). Also excluded is Ratte. The district of Ratte is not cited among those incorporated in the 1930 Census, and it seems probable that it might have been confused with Rano (see above Annex Ia). Seinstra did report the district in the map annexed to his *Memorie van Overgave* (1940), but he makes no mention of Ratte in his text. I was unable to find out any specific information about Ratte district, which was incorporated in the district of Pali during the Dutch colonial government.

Banga is a *lembang* consisting of 4 *bua*'-communities, each of which coincides with a settlement: Surakan, Buri, Tagari and Karondeng (Lanting 1926, Nobeles 1926: 142-143). The chief of *Banga* is called *indo*' *lembang* or *parengnge*'; the chiefs of the constituent *bua*'-communities are known as *indo*' *bua*'.

Tapparan is a *lembang* with 7 *bua*'-circles. Each of the seven coincides with a settlement: Ratte, Lappangan, Uka, Pangleon, Kalem-bang, Tambang and Padangiring. The titles given to functionaries are, as above, *indo*' *lembang* for the larger body, *indo*' *bua*' for the smaller

ones (Seinstra 1940: 111). According to Lanting (1926) and to Tandilangi' (1968), the two *lembang*, Banga and Tapparan, were once united in a federation of eleven member *bua'* under the leadership of *tongkonan* Se'ke. The federation was designated as *to sangtakanan la'bo' sia sangtekkenan doke, sangpulo misa bua' Se'ke* ('people united like the belt of a sword or the shaft of a lance, Se'ke embraces eleven *bua'*'). The name alludes to the alliance of members in the event of war (see *Woordenboek*: 657, v. *takin*). Later, however, *Banga* split off from this federation to place itself under the protection of *tongkonan* Mebali, a house originally established by the descendants of *Tamborolangi'*, the important ancestor of the *puang*-ramages.

Taleon, *Palesan* and *Malimbong* are each referred to as a *lembang*. The status ramage of these three territories have one ancestor in common: *Gonggang diSado'ko* (Lanting 1926 and Tandilangi' 1968; Mount Sado'ko is in the west of Ma'kale, one of the *Tallulembangna*). The 6 *bua'*-circles belonging to *Taleon* each consist of one village: Leppang, Koleang, Tarrung, Kalimbang, Sarong and Kandeapi. Lombok, the leading *tongkonan* of these three *lembang*, is situated in *Taleon*. *Malimbong* has 7 *bua'*-members (seven villages); its leading *tongkonan* is *Passangdan*. *Palesan* has but 4 *bua'*-circles (4 villages); its principal *tongkonan* is *Batupapan*. The chief of each of these *lembang* has the title *indo' lembang*; the heads of the constituent *bua'*-communities are called *indo' bua'*.

Rano, *Buakayu* and *Mappa* are called by the same name as the three *puang*-states: *Tallulembangna*. *Rano* numbers 9 *bua'*, *Buakayu* 6, and *Mappa'* 3. Each of these *bua'*-communities is coterminous with a settlement (village). The chief of each *lembang* is called a *ma'dika lembang*, the head of every *bua'*, a *ma'dika bua'*.

Bau, a *lembang* with three *bua'* (3 settlements), stands in a certain relation to the above-mentioned *Tallulembangna*. Although the exact nature of this relation and what it entails is not clear, the existence of a relation is unmistakable in the honorific name of *lembang* *Bau*: *Lentong Bulaan Tallulembangna* ('The Golden Post, The Pole of the *Tallulembangna*'). The chief of the *lembang* is entitled the *ma'dika lembang*; the chiefs of member *bua'*, similarly *ma'dika bua'*.

Simbuang is a region with a different pattern of organization. Here there are 6 *lembang* (*Simbuang*, *Mappak*, *Sima*, *Lindangan*, *Makodo* and *Panangan*) each of which is a single *bua'*-community (and village!). The most prominent of these villages is *Simbuang* where the principal chief of the six *lembang*, the *ma'dika*, resides.

The chief's title was institutionalized by Parisi, a man who came from Manipi (Mamasa). For further details, see Lanting (1926) and Tandilangi' (1968).

Balepe' is a *lembang* with 7 *bua'*-circles (= settlements).

Balusu is a *lembang* which deviates somewhat from the usual pattern. It consists, according to Seinstra, of two parts. One of these, an area in which 4 villages are located, was appropriated from Tikala (Seinstra 1940: 110). Tandilangi' (1968) does not mention this. Instead, he states that Balusu is divided into 5 *saroan* (see IV.2.2) one of which is identical to a *bua'* or *penanian*. The foremost chief of Balusu bears the title of *puang*. The first *puang* was Puang Gading who lived in a house that hung between heaven and earth; the name of the house was the same as that of the house of Tamborolangi': *Banua diToke* ('The Suspended House'). The first *puang* married a lady of high rank from *tongkonan* Rante Aa; she was an inhabitant of Kesu'. Puang Gading and his spouse then founded *tongkonan* Lingka Saile, the principal house of *lembang* Balusu. Other titles of importance in Balusu include *Tulak Bala* ('The Support of the Dike') and *Baliara* (translation unknown). Indeed, there are two *Baliara* who together with the *Tulak Bala* constitute a council; those who sit on the council are called *Anak Tallu* ('The Three Children'). Because Balusu and Luwu' are contiguous, much intermarriage takes place between the leading ramage of Balusu and the nobles of Luwu'.

Sa'dan is a *lembang* made up of 4 large villages each of which is subdivided into several *saroan*. The chief of a village is called *anak to makaka*; the head of a *saroan* is called *to parengnge'*. Seinstra (1940: 190) reports that this district has a dual organization, divided into West- and East-Sa'dan, each part with its own *puang* ('chief'). In Sa'dan, *bua'*-communities are unknown; the most significant feast here is the *merok*. The *lembang* as a whole includes 7 *merok*-circles.

Tondon, a *lembang* which at the same time is a *bua'*-community, is subdivided into 4 *tepona padang* (see IV.4.2). Each *tepona padang* consists of 3 *karopi*. The head of a *karopi* is a *to parengnge'* (the latter term denotes his rank and is not a title). He administers law within the *karopi*'s boundaries (as do the *bua'* in other *lembang* = 'districts'). A *to parengnge'* ('the head') presides over the *karopi*-council which for the rest is made up of *anak to makaka* and *to matua tondok* ('village elders'). Should the *karopi*-council be unable to arrive at a decision to settle a given law case, the matter is set before the *tepona padang*. The chief of a *tepona padang* is called *sokkong bayu*

(Seinstra, *Memorie*). The leading *tongkonan* in this *lembang*, in order of precedence, are Ne' Malo, Ne' Pabara, and To Payungi.

Madandan is the *lembang* whose people claim Pangadoran, descendant of Tamborolangi', as their most important ancestor. Pangadoran and his wife, also a descendant of Tamborolangi', founded Sibune, the most eminent *tongkonan* in this district. The *lembang* is made up of several villages (Madandan, Marante, Pangeda, Kanuruan, Dulang, Poton, and, perhaps, Tonglo'); the villages are subdivided into *saroan*. The *saroan* in Madandan functions as the most efficient mutual aid organization in Tana Toraja (for such societies, see IV.2). According to Van der Veen (oral information), Madandan, too, has its *bua'*-circles. Two of them, Madandan and Tonglo', form a federation called *sangtakinan la'bo'*, *sangtekkeran doke* ('a group united like the belt of a sword and the shaft of a lance'; cf. Banga and Tapparana above).

The *lembang Nanggala* is famous for its magnificent rice barns. There are several villages in the *lembang*, the largest of which is also named Nanggala. The *lembang* contains 6 *bua'*: Alo, Rante, Nanna, Bosokan, Kawasik and Barana'. According to Lanting and Seinstra the two leading functionaries in the district are called *to parengnge' kapua* ('great *parengnge'*').

The *lembang Pangala'* consists of four regions: Awan, Baruppu', Pangala' and Lolai. Lolai contains 7 villages, the *kepala pitu* ('the 7 heads'); *kepala* is not Sa'dan-Toraja, but the Indonesian word for head (or chief). Originally Lolai was connected with the *puang*-region of Mengkendek. Every year its inhabitants paid homage to the *puang* there. Prior to the arrival of the Dutch, however, Lolai was annexed by Pong Tiku, the hero of local resistance; and it has since formed part of the *lembang Pangala'*. Awan is a *bua'*-community. Baruppu' numbers 4 *bua'*. It is not clear, however, whether Baruppu' can be described as a *patang penanian*. The population in its entirety has been converted to Christianity so that autochthonic rice rituals are no longer observed. The leading families of Baruppu' and of Awan trace their genealogy back to *tongkonan* Napo, an illustrious house in the *lembang* of Dende. About the region of Pangala', nothing appears known.

Ulu Salu consists of 11 *bua'*-communities each under an *indo' bua'*. The chief of the *lembang*, whose *tongkonan* is in Patatan in Bilalang, is called *ma'dika*. The most important ancestor of the leading families of this *lembang* was a descendant of the famous Tamborolangi' and came from the village of Ratte.

Piongan and *Dende* are *lembang* which have joined to form the federation known as *sanggungdangan rambu, sangtekkenan bembe na sangtekkenan doke* ('one in following the same ritual, one in having the same plume of goat's hair, a group united as the shaft of the spear'; cf. the names of federations such as Madandan and Tapparan with Banga cited above). The name denotes a group of people who have a set of rites (or ritual) in common, whose members are united against any invader. Altogether there are 11 *penanian* within the federation, each of which is led by a *to makaka*. Prominent families in these *lembang* consider themselves to be descendants of the founder of *tongkonan* Napo in Dende (Lanting 1926: 32 and Tandilangi' 1968). For further historical material concerning Piongan and Dende, see Lanting 1926: 32-33.

Kurra' is a *lembang* with four *penanian*: Bambaru, Marosing, Kurra' and Tabang; together they constitute a *patang penanian*. Bangga To Napo was the first ancestor of Kurra'. Although Bangga To Napo descended from *tongkonan* Napo, *tongkonan* Lipangan is at present in ascendancy in Kurra'.

Sesseng, a *lembang* which has another descendant from *tongkonan* Napo as its most celebrated ancestor, consists of 7 *bua'*-communities. The people of these communities, however, are dispersed among only 4 villages.

Balla, *Bittuang* (*Bettuang*) and *Pali* are three separate *lembang*, each of rather recent vintage. The family tree of their leading families stretch no further back than some ten generations (Lanting 1926 and Tandilangi' 1968). The head of each of these three *lembang* is known as *ma'dika*. During the period of Dutch Colonial Administration Rante was incorporated in Pali (for the Rante district, see above, p. 63).

Tikala is a *lembang* composed of several *adat*-communities. One of the larger is Sangulu Bai ('Forming One Swine's Head'). The territory of this community, which includes the settlement Akung, is the region known as Bori'. Here no *bua'*-feast is held; they only have the *merok*. In Tikala proper, however, the *bua'*-feast is known. This part of the *lembang* is a federation called *Sangpalin Bangunan* ('To Rise Up Together', viz. in the face of attack). It contains four *bua'*-circles: Tikala, Sangbua', Mangannan and Lempo. The boundaries of the federation were altered somewhat during the period of Dutch rule. The most famous ancestor of the leading families in the *lembang* is Suloara', who instituted the *sukaran aluk* in this region (*aluk* =

adat or ritual; *sukaran aluk* = prescriptions for the rituals). In addition to Tamborolangi', Tangdilino' and other *to manurun*, Suloara' is a famous ancestor who provided Tikala with a mythical history of its own.

Rantebua' is a *lembang* of 11 *bua'*-communities; the head of each of these *bua'*-circles is a *to parengnge'*. The chief of the *lembang* itself, according to Seinstra (p. 107), is called *to marandan* ('the unsurpassed'). In a footnote added to Seinstra's *Memorie van Overgave*, however, a Toraja reader reports that the title *puang* is also used. Quarrels within the *bua'* were brought for settlement to the *bua'*-council. Members of the council, beside the *to parengnge'* who presided over it, were *anak to makaka* and *to sumombo* (= *petulak*; village elders, according to Seinstra). Clashes of such importance that they fell beyond the jurisdiction of the *bua'* or which the *bua'*-council proved incapable of resolving, were submitted to the *lembang*-council. The chairman of the *lembang*-council was the *puang* (or *to marandan*); its members were *to parengnge'*, *anak to makaka* and *to sumomba*. (For further details, see Seinstra: 106-107.)

At the end of this survey we must dwell for a moment on the term *district*. We have used it as a synonym for *lembang* in the sense of an *adat*-community as described in this subsection. However, the colonial administration of Tana Toraja had divided the area into thirty-two districts, fewer than the number of the *lembang* here enumerated including Ratte, Buntao', Kesu' and the three princedoms which we left out of discussion in this survey. The total number of *lembang* is thirty-seven, five more than early administrative districts. The point is that some of those districts consisted of more than one *lembang* because the *lembang* concerned were so closely federated that administratively they could be considered as one. This was the case with Ratte, incorporated in Pali.

Before turning to Buntao', we continue this survey with a brief discussion of Pantilang, an *adat*-community which, like Ranteballa, did not lie within Tana Toraja but rather within the bounds of the neighbouring princedom of Luwu'. Data have been derived from Pronk's *Memorie van Overgave* (1935) and from oral information provided by Dr. Van der Veen. Today Pantilang still is part of the *kabupaten* of Luwu'. During the period of unrest between 1950-1965, approximately half the inhabitants of Pantilang turned fugitive and migrated to the north of Palopo, the capital of Luwu'. Here they have

remained. By now the Toraja of Pantilang have without exception adopted Christianity.

Pantilang was divided into four *tongkonan*, the *Tongkonan A'pa'* (cf. Sangalla):

1. Pantilang, which has a claim to the title 'The Great Rice Mortar' (cf. Buntao' and the Pitung *penanian*);
2. Maindo, with the title *A'riri Bassi* ('The Iron Headpost' or 'The Iron Pillar');
3. Kanna', situated along the upper reaches of the Jenemaaja, with the title *Sembang Kada* ('He who speaks the decisive word');
4. Bolu, under a chief who bears the title *Balimbing Kalua'* ('The Great Root') also called *Lo'ko tang kauranan* ('Cave where one escapes from the rain').

What exactly the functions of the heads of these *tongkonan* entail, is something I have been unable to ascertain. All four titleholders had the legal (administrative) position of *parengge' lompo*, or great *parengge'* (for the *parengge'*, see chapter III). To assist them (but more probably as their superior) an official of the principedom of Luwu' resided in the area.

Pantilang is at times alluded to as the 'Sixty *Tongkonan*', the *Annan Pulona Tongkonan*. Indeed, each of the *Tongkonan A'pa'* exercised jurisdiction over fifteen *tongkonan* of lesser status. The heads of these *tongkonan* bore the title of *indo' palapa*.

It is reported as exceptional that this *adat*-community, which in 1935 included some 11,500 people dispersed over thirty-six settlements, did not celebrate the major *bua'*-ritual. The greatest ritual observed was the *merok*-feast. The small *bua'*-ritual (*bua' padang*) may have been known, but no relevant information has come to light. Every year some of the leading persons of Pantilang went to Luwu' to pay homage to the *Datu* ('Prince'). A cock was invariably part of their tribute. In return they received from the Prince sowing rice which he, personally, had blessed.

IV.1.5 Buntao', an autonomous *patang penanian*

Buntao' lies east of the territory of Kesu'; the region is a *patang penanian*, a federation of four villages. The significance of this union is above all obvious at the time of ritual observances (see Vol. II: The rites of the *merok* in Buntao'). Similar village leagues also appear elsewhere in Tana Toraja, notably in Kesu'. Buntao' is thus subdivided

into four areas (informants spoke of areas of jurisdiction). These areas have the following titles:

1. *Issong Kalua'* ('The Great Rice Mortar')

The territory of 'the Great Rice Mortar' includes the village of Tallang Sura' and half of the village of Kadinge' (also called Buntao'). The following phrases of elaboration are joined to the title: *to manua' balun-balun ampa'* (*balun* etc. means 'to be wrapped in a mat') and *to matindo balian tang urrangi oninna manuk* which signifies 'the one who lies on one side, deaf to the crowing of the cock'. These descriptions are difficult to explain. The Issong Kalua' is the leading *adat*-chief in all of Buntao'. His office obliges him to conduct all forms of negotiations and to bring up their contents for public discussion. He is chairman of the council of Buntao'. Should it prove impossible in any of the other three territories to settle a given matter, the affair is brought for discussion to a council meeting presided over by the Issong Kalua'. This makes it clear that the four areas of jurisdiction of Buntao' together constituted a single larger realm under one law. In addition the Issong Kalua' fulfilled the same function in certain rituals — in feasts dedicated to the *deata* — as the *sokkong bayu* in the villages of Kesu' (the responsibilities of the *sokkong bayu* are discussed below, see IV.1.6). The account later in this work of a *merok*-feast celebrated in Buntao' (Vol. II) includes mention of the role of 'The Great Rice Mortar'. The area designated as Issong Kalua' encompasses both the center and the east of Buntao'.

2. *Rinding Kila'* (*rinding* = wall; *kila'* = lightning)

This title belongs to the area co-extensive with the village of Balabatu situated in the west of Buntao'. The role of the relevant functionary is indicated in the following terms: *To diporinding kila'na* — *diposapan susulandu'na Patang Penanian*, which, freely translated, is 'Outpost and Sentry of the *Patang Penanian*' (*To diporinding kila'na*: the one who as a wall, forceful as the lightning is utilized; *diposapan susulandu'na*: the one who as a barrier, flashing like a falling star is employed). The functionary conducts all deliberations and disputes within his village, but whenever an affair cannot be brought to a satisfactory conclusion in the village council, it can be submitted for consideration to the Issong Kalua'.

3. *Tongkonan Basse Tiropadang* (*basse* = to be under oath)

The area of his jurisdiction is confined to that half of the village of

Kadinge which is called Tiropadang. His title is further elaborated as *to umpandan bulo sanglampa* and *umpakumararak tallang tang kale-soan*. 'The one who puts down a joint of bamboo lengthwise' is a rough paraphrase of the initial phrase; the second phrase resists translation but may be an analogue to the first. The task of the head of *Tongkonan Basse Tiropadang* is to see to it that Buntao' lives in peace with all areas neighbouring on the *Patang Penanian* and, if need be, to perform friendly services for these areas. He, too, can settle disputes in his own territory, appealing to the Issong Kalua' when he fails to impose a solution.

4. *Rinding Daun Induk* ('The [protective] Wall Made of Sugar Palm Leaves')

The area of jurisdiction of the functionary who presides over this area contains the village of Paniki in the north of Buntao'. The title is one which we encounter in Kesu' as well. The expanded form of the title, *to diporinding daun induk, diposapan kua-kua* means: 'that which is fenced in with the leaves of the sugar palm, that which is provided with a dam of reeds'. The functionary must display tolerance towards neighbours; he must maintain peace with people outside the *Patang Penanian*, serving thus in the same fashion as the head of *Tongkonan Basse Tiropadang* above. His office, however, entails more defensive responsibilities.

Here it should be stated emphatically that the offices just described belong to the long-standing *adat*-system which at present only continues to function during ritual celebrations. Administratively Buntao' is, today, known as a *lembang*, a subdivision of a *kecamatan* which is administered by a *kepala lembang* (*kepala* is the Indonesian term for chief).

The *adat*-functionaries mentioned above are the *to parengnge'*; they have definite functions in ritual. The functionaries celebrating the rice ritual are here called *to dolo* (elsewhere *to indo' padang*). As elsewhere, the most eminent among them is the *bunga' lalan*. A third category of priests are the *to minaa*; their functions are described at some length in chapter IX.

As additional functionaries mention must be made of:

- a. the *petulak* (see IV.2.2);
- b. the *takinan la'bo'*. Every *penanian* has its *takinan la'bo'*. This title means 'those who gird on their swords' and their function is

circumscribed as 'those who are joined in one hand like swords, who form a bond with each other in battle, who constitute a federation of *adat*-communities that preserves security and maintains order'. A *takinan la'bo'* is thus entrusted with keeping order and assuring the safety of those in the *penanian*. He belongs to the elders of the village (*to matua ulu*) among whom he is *primus inter pares*, for it is the *takinan la'bo'* who in first instance can introduce a law case for discussion. Should he and the other *matua ulu* be unable to settle the legal dispute, it is then laid before the head of the *penanian* — Rinding Daun Induk, for example (Seinstra 1940: 106). To what extent the *takinan la'bo'* still confers with the *gora tongkon* (see below) is not clear. The *takinan la'bo'* is not considered one of the *to parengnge'*;

c. the *parandangan* ('The Points of Support')³ whose job description reads: 'to care for prosperity';

d. the *tutungan bia'* ('Those who light the torches'),⁴ a function which is compared to that of intelligence officers in a modern army. These torch-lighters must look into whatever potentially might provoke unrest;

e. the *gora(-gora) tongkon*, a name which also appears in Nonongan. These are the leading *to makaka* who are consulted when disputes must be adjudicated.

The federation of Buntao' is a composite of four parts. Yet, another division is of even more importance: that of the rituals of the East, during which the above-mentioned *to parengnge'* and *to indo'* perform roles, and the rituals of the West during which the priest of the dead officiates. The helper or assistant of this latter priest also appears, however, during the *merok*-ritual, officiating throughout the night (cf. the account of the *merok*-feast in Buntao' in Vol. II).

IV.1.6 *The federation of Kesu' (Map 3)*

Kesu' encircles and includes the town of Rantepao. The inhabitants of this region are, justifiably, proud of their home area. It is one of the most beautiful parts of Tana Toraja which, in its entirety, has been generously endowed with natural splendour. Kesu' is also rich in myths. Here Puang riKesu', the mythical ancestor, descended from heaven to the peak of Kesu' Mountain. He built a house that would later be called *tongkonan Kesu'* and would finally be completed by

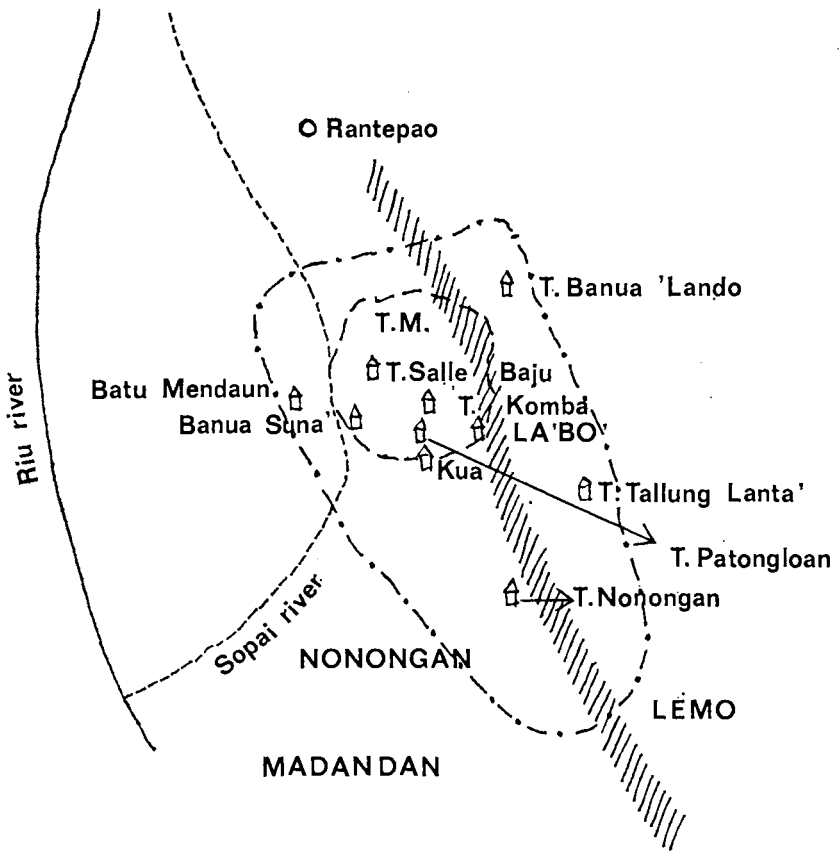

- Pantan' nakan lolo
- . - . - . Kesu'
- Sangtendanan langngan
- //////

T.M. Tikunna Malenong

Map 3 Kesu'.

his son-in-law Pabane'. Pabane' celebrated the *mangrara banua*, the great consecration feast for a new *tongkonan* (cf. VIII.1).

Many spots throughout Kesu' have legends of their own. Here, too, is situated the *sawah To' Kamiri* where Manaek set her brother Polopadang free when his hand had become jammed (through this deed, Manaek became the successor of Puang riKesu', see VI.2). Myths, legends and more recent history — the war against the Buginese Aru Palakka, for example — have contributed to the forging of a certain degree of unity in Kesu'. One might call the region a federation, a community with its own traditions and, in certain respects, its own *adat*. Even my Sa'dan-Toraja informants had difficulty in proposing a proper term for describing Kesu' as a socio-political entity; *sangparenggesan* proved to be the best designation they could find:

Sangparenggesan means, literally, 'what belongs to or is connected with one *parengge*'. The term *parengge*' is here taken in the narrow significance attached to it by the colonial administration, that of chief of an *adat*-community (*lembang*) (oral information from H. van der Veen). The best translation of *sangparenggesan* would thus be: 'area administered by a recognized chief'.

An alternative which was suggested was the name *sanglembang* ('the people who occupy a *lembang*, a proa', or 'those who belong to one *lembang*'). This is the current term for an *adat*-community, though, at present, it may be also used to denote a *kecamatan*.

According to informant Ne' Sangga, the federation came into being six generations after Puang riKesu'.

Kesu' can be broken down into three areas, Kesu', La'bo' and Nonongan, each of which consists of a complex of villages. The three areas all have a number of important titles which are linked up with specific *tongkonan*.

a. *Tikunna Malenong* ('That which is situated round about the Malenong cliff') lies in the center of Kesu'. It is referred to as *Panta'nakan Lolo* ('The Nursery for Young Rice Plants'; *panta'nakan* = nursery; *lolo* = umbilical cord). Another designation for this area is *Kambuno Talluna Kesu'* ('The Three Parasols of Kesu') which is an allusion to the titles of the three most eminent *tongkonan* in the vicinity: Sallebayu, Banua Sura' and Komba. The first name, however, *Tikunna Malenong* is the one most commonly used; it is also the title of the leading titleholder in the region, i.e. the title connected

with the *tongkonan* Sallebayu.⁵ (The previously mentioned 'clan'-house of Puang riKesu' and Pabane' which originally stood on Kesu' Mountain has since been transferred to the village of Ke'te' in Bonoran and thus no longer stands in *Tikunna Malenong*. No title is tied to this important *tongkonan*, a fact which apparently is connected to the impossibility of identifying any direct descendant of the original inhabitants of this house.) Just as other important titles in Kesu', a parallel title of *tongkonan* Sallebayu in Tonga is related to the cultivation of rice: *Kambi'na Panta'nakan Lolo* ('The Keeping of the Nursery for the Young Rice Plants'). This titleholder is alternately known as *Lantang Bualanna Sukaran Aluk* ('The Golden [feast] Hut Where All *Adat*-Regulations are Displayed'). This designation indicates that the titleholder is especially concerned with matters which involve the *adat* (*lantang* is a general term for a hut or shed; such a *lantang* is a ceremonial building in the rice ritual; see Vol. II).

The next significant title in *Tikunna Malenong* (*Panta'nakan Lolo*) is *Pekaindoran*, a title belonging to the *tongkonan* Banua Sura' in the village of Ba'tan; this house, 'The House with Carving', was founded by Emba Tau. The term *pekaindoran* also signifies a certain form of kinship; in this context it is roughly the equivalent of 'she who is regarded as the mother of the *adat*-community, who leads this *adat*-group, who is looked upon as the head of the *adat*' (*Woordenboek*: 166). However, we should not overlook the reference to the *to indo*', the rice priest.

Pesungan Banne is the third important title in *Tikunna Malenong*; it is allied to *tongkonan* Komba which was established by Bulu Ara'. Literally, this title can be translated as 'The place where the rites for the cultivation of rice are opened', i.e. commence. This titleholder is responsible for financial arrangements in the event of war.

A further title in this region is *Sandan Panta'nakan Lolo* ('The Dam of the Nursery for the Young Rice Plants'), a title belonging to *tongkonan* Patongloan in Tadongkon. My informant interpreted this name as 'He who drafts the budget'. Probably this functionary determined how much every village or *tongkonan* should contribute in specific instances.

In addition one other title deserves citation: *Rinding Bassina Kesu'*, a title linked to *tongkonan* Kua in the village of Pao in the south of *Tikunna Malenong*. *Rinding Bassi* signifies 'Iron Wall', suggesting a protective function. The parallel title of *tongkonan* Kua is *Rinding Matoto'na Kesu'* ('The Strong Wall of Kesu').

The figure of most prominence in Tikunna Malenong is the head of *tongkonan* Sallebayu, the parenthouse founded by Tonglolangi' (or, according to Allo Rante, alias Ne' Sangga, by Lusa'). He is the chairman of the Tikunna Malenong council.⁶

b. The second important area is *La'bo'* ('sword', 'machete'). The most significant title is connected to *tongkonan* Banua Lando ('The Long or High House') founded by Palinggi' in the village of Marante in the north of *La'bo'*. This title is *Issong Kalua'* ('The Great Rice Mortar'). The titleholder was involved in economic affairs and in matters related to agriculture, such as, for example, the cultivation of rice on the *sawahs* and the planting of gardens. It was he who indicated where various crops were to be raised. He also set prices for produce such as rice and coffee, and other commodities which were sold beyond Kesu'.

The remaining important title in *La'bo'* is associated with *tongkonan* Tallung Lanta ('The Three Rooms') which Puang Kalua' established in the south of this region. The title, *Pa'palumbangan*, can be paraphrased as 'The piling up of rice bundles on the *sawah* dike'. Once again the title embodies a notion derived from the cultivation of rice. The *Pa'palumbangan* arranged all transactions related to the internal organization of the region, but he also rallied the people in times of war (as he did for example during the *untulak buntunna* Bone ('the battle against Bone')). Here, farther south, the defensive aspect of the federation comes into prominence. In Nonongan this is even more pronounced. *La'bo'* is also a *patang penanian*.

c. *Nonongan*, too, has an eminent genealogy. Here is found the *tongkonan* Nonongan, Manaek's house, the important female ancestor of Kesu'. It is Manaek who — when the *to minaa* recites the *mantaa bati* on the *bala'kaan* (= scaffolding where the division of meat takes place during a ritual for the dead) — is invoked with the epithet of *Datu Baine* ('Goddess' or 'Princess').⁷ In the same text Tangdilino', the most important ancestor of many ramagees in the Sa'dan region, whose *tongkonan* Banua Puan stands in Mengkendek, is called God or Prince (see Vol. II). Manaek was married to a descendant of Tangdilino'. The titles Prince and Princess point to Nonongan's ambiguous position in the federation. It is allied with Kesu', but keeps up close relations with the outside world, in particular with the *puang*-realms.

The two important titles in this region are suggestive of protection

and of arbitration. The *Pentionganan* (a title belonging to *tongkonan* Nonongan) issued warnings when he detected trespasses and he settled disputes. In the event of war he was responsible for supplying the warriors and guards, presumably those of Madandan and Lemo (see below). The name *Pentionganan* means 'a place to take shelter' (possibly this implies cooperation with the Pesungan Banne). *Pa'paelan* is a title connected to *tongkonan* Batu Mendaun ('Stone with Leaves') situated in the west of Kesu'. This official had to set matters straight whenever difficulties arose: on difficult questions he was consulted for his advice.

Nonongan is also called *Nabale Salu Lian* ('The Region separated by the river from the other Side'; the other side is the rest of Kesu').

Three areas are allied with Kesu':

d. *Lemo*, referred to as *Takinan La'bo'na Pentionganan* ('Like in one bond girding on the swords of the Pentionganan'; the name alludes to the security forces of Lemo which serve the *tongkonan* Nonongan: previously members of the security forces wore swords);

e. *Madandan, Dokena Pentionganan* (*Madandan*, 'Like in one bond holding the spears of the *Pentionganan* in readiness'), an indication that in Madandan battle formations stood in readiness to defend Nonongan (and thus Kesu') should it be attacked. In the past the spear was another weapon of the Toraja warrior. We have already spoken of Madandan in our review of the *lembang* (IV.1.4).

f. In this context the *Sangtendanan Langngan* ('One in the setting up of a *langngan*' i.e. a kind of roasting spit) also deserves mention. This *adat*-community stretches from Mariri (Nonongan) to Kondongan (Tikala) and thus in part falls outside of Kesu'. The region consists of the following *bua*'-circles (villages): Kadundung, Sangpuloangin, Sarre, Kalindungan, Maruang, Mariri, Tampak, Sollo', Pangrante, Ba'lele and Kondongan (the last two *bua*' were added to the *lembang* Tikala by the Dutch). There are two titles to distinguish in this community: *Barra' Massakaranna* ('People who prepare the food' viz. for the warriors) and *Tillok bulaanna Kesu'* ('The Golden Beak of Kesu''), who serves as judge when disputes must be settled. Perhaps the word *beak* is an allusion to the bill of the cock: before the arrival of the Dutch, major controversies were adjudicated through cock fights. The function of the 'Golden Beak of Kesu'', however, is not

quite clear. The regions mentioned under *d*, *e* and *f* are not, strictly speaking, part of Kesu', and yet in event of war they stand ready to fight as its allies.

Not only is Tikunna Malenong the center of Kesu' by its geographical location, its prominence is also assured by its ties with Puang riKesu' and through the presence of *tongkonan* Kesu', the most important house of the *to manurun* in this region. It is thus the most ancient territory, but nonetheless is referred to in terms of something which is extremely young, i.e. 'The Nursery of the Young Rice Plants' which sprout anew every year, symbolic of the resurgence of life. The young, the nursery, the center must be cared for: this is the reason why it is, as it were, surrounded by councillors and guardians. The name 'The Nursery of the Young Rice Plants' could be an allusion to the life-center, the origin of the community of Kesu' (information from Van der Veen).

There are titles in Nonongan, Tikunna Malenong and La'bo' which allude to a protective function, viz. *Pentionganan*, *Rinding Bassi* and *Issong Kalua'*. This last title also means 'Protector, protective authority'. Furthermore we note that titles in Tikunna Malenong are more closely connected to the initial phase of rice cultivation whereas titles in La'bo' have more to do with the later phases of the rice cycle. Such titles are missing in Nonongan. Perhaps we must connect the fact that Tikunna Malenong and La'bo' in this respect constitute a kind of entity, to the officiating in both regions of the *to burake tambolang*, a hermaphrodite (male) 'priestess'. This in contrast to Nonongan where a *burake tattiku'* officiates who is a real priestess (see IX.5). Yet, this is merely a hypothesis. The *burake tattiku'* also holds office outside of Kesu' in the districts of Dende' and Pangala' and in the territory of Riu in Tikala, and to explain the specifically female character of all these territories is a difficult proposition.

More important is that the residents of Tikunna Malenong and La'bo' have frequently inter-married, thus accentuating the ties which bind the two regions.

The unity of Kesu', primarily a matter of certain myths of descent, has been strengthened by the common war against invaders from Bone. In addition this region shares a specific, communal *adat*; customs are uniform which is manifest, to cite one example, in the mortuary ritual which displays identical traits everywhere throughout Kesu'. On the other hand, one should not imagine that the federation

is characterized by any advanced form of integration. The activities of Kesu' as a whole were only of significance in the event of war or when other pressing questions arose of common interest, such as the export price of rice and coffee. The region had no ritual which brought together all the inhabitants of Kesu' (such as, for example, the mortuary ritual for the *puang* of Sangalla'), nor did it possess regalia which were of significance for Kesu' as a whole.

Tikunna Malenong and La'bo' were more of an entity in that the villages they contained (upon the instigation of Pong Panimba?)⁸ celebrated the *bua' padang*-feast in succession so that a kind of feast cycle originated. The titles of the *tongkonan* in these regions which have to do with the cultivation of rice could be related to this cycle. But: the cycle originated in La'bo' where the title of the *tongkonan*, 'The Piling of Rice Bundles', has a direct connection to the concluding phase of the rice cycle. All in, the organization at village level was of more significance for daily life than either titles or offices. The names appearing above are those of the titleholders or functionaries in this federation. In the villages these functionaries have the title *sokkong bayu*. There are more *sokkong bayu*, however, than those cited above — twenty-three in all, as many as there once were villages.

IV.1.7 *The principdom of Sangalla', one of the Tallulembangna*

Sangalla' is one of the Tallulembangna ('the Three Proas'), the name of the three principdoms in the south of Tana Toraja which were governed by a *puang* ('prince'); the two remaining small states are Ma'kale and Mengkendek. Formerly three separate districts they have retained separate identities but have been united in one of the 9 new *kecamatan* into which Tana Toraja is divided. The information presented below comes primarily from Puang Willem Popang Sombolinggi' and Puang Paliwan Tandilangi', the sons of Puang Lasok Rinding who died in 1968. The two informants describe Sangalla' (*Padang di Sangalla'*, 'the Land of Sangalla'') as a small kingdom. The head of the kingdom is the *puang* who bears the title of Puang Palodang (Puang Bulu is the title of the *puang* of Ma'kale, Puang Paetong the title of the *puang* of Mengkendek). Ma'kale is called the *Basse Kakanna* which is tantamount to saying that it is considered to the most ancient of the three *puang*-domains. Mengkendek is the youngest, the *Basse Adina* (*basse* = agreement, pact or bond; *adina* = younger sibling) with, as its leading *tongkonan* (*tongkonan* Layuk) the house of Otin (cf. Tandilangi' 1975: 93-105). Sangalla' is the

middle 'child' (brother or sister) of this federation of three siblings, the *Basse Tanggana*. In this context we should not interpret the word *sibling* too literally; it is rather an indication that the *puang*-regions share close ties and that in the mythical past Tamborolangi', the most important ancestor of the *puang*-ramages, divided a certain area among his three sons. The oldest child (Ma'kale), without doubt, is the most important. When a new *puang* was chosen in Sangalla' (Melantik), the *lembangs* of Ma'kale and Mengkendek also had a voice in the selection process.

The *tongkonan* Layuk, the parenthouse of the *puang* of Sangalla' is *tongkonan* Kaero, is situated more or less in the center of the state. The building is of the same type as other *tongkonan* in Tana Toraja. A designation for the principal resident of this parenthouse (the *puang*) is *Kalindo Bulan*, *Kabarrean Allo* ('Shined on by the beams of the moon ['The Glorious'], Lit by the rays of the sun ['The Splendid']'). His countryhouse is *tongkonan* Buntu Kalando. This building was originally a *tongkonan* of the old Toraja model; at the time of Dutch rule, it was replaced by a modern house but about 1965 this was rebuilt in traditional *tongkonan* style so that, in 1970, it could be used for the mortuary rites of Puang Lasok (So') Rinding.

The first *puang* of Sangalla' is said to have been a woman (Patola Baine). Her husband, Patola Muane (*baine* = wife; *muane* = husband) handled the affairs of state. Patola Muane sprang from Dulang, at present the territory of the Tanduk Tata' (see below under *To A'pa'*). It is not clear whether the initial *puang* was succeeded by a son or a daughter. The family tree of the *puang* stretches back some fifty generations. The important ancestor of the *puang*-families is Tamborolangi' (see chapter VI); his descendants divided his kingdom into various smaller states. Upon the demise of a *puang*, one of his sons succeeds his father, not necessarily the first born. The new *puang* is designated by the *To A'pa'*, the dignitaries to be discussed below, who are advised by the *puangs* of Ma'kale and Mengkendek. When the 'prince of Kaero' (= the *puang*) dies, his 'people' (Indonesian: *rakyat*) have no say in who will succeed him.⁹ In this context we refer to the "Tangdona Sulle Gayangna Bullu Matua" [The inaugural oath of Puang Matua's successor], (the new *puang* of Ma'kale), transcribed and translated into Dutch by Dr. H. van der Veen (Van der Veen 1979: 17-38).

Only the *To A'pa'* (*tongkonan A'pa'*) ascertain who shall be the new *puang*. In what manner the two fellow kingdoms could influence

the election was not revealed. Informants confined themselves to enumerating the conditions which the heir apparent had to meet to be appointed the successor of the dead prince. He might be poor or less capable than another eligible candidate, what counted were the conditions which were publicly divulged after the installation.

At the installation of a new *puang*, a simple meal is set in front of him on the afternoon of the day he takes office. On that day not even a pig is sacrificed. The next day the following animals are slaughtered: a red cock with white feet (*londong sella'*); a spotted pig with a white belly (*ballang*); and a spotted buffalo (*bonga*).¹⁰ All the dignitaries of the principedom are present on this occasion.

After the sacrifice the *to minaa* ('priest') announces the precepts mandatory on the *puang* (the conditions for his election): he may observe no other religion than that of the *manurun di langi'* ('those come down from heaven') thus the autochthonic Toraja religion; he must be just; he must be upright; he may pay no heed to agitators; he must be independent in his judgement; he must take advice to heart; he must help his fellow man; he may not be lazy; he may not be a hothead; he must lead his people wisely; he may judge no one without any form of trial; he may not behave insultingly; he must defend his rights; he may not covet another man's possessions; etc. (there are two additional precepts but their text is not clear).

The whole affair is simple and as such well in keeping with the modest size of the kingdom, some 21,000 people living in an area of no more than 216 sq. km. Not everything in the kingdom was so simple. On the contrary, organizationally, Sangalla' had all the airs of a veritable realm. The leaders of four noble houses, the *To A'pa'*, acted as vice-regents whom my informants compared to modern state ministers; four additional masters of noble houses were entrusted, along with other duties, with military tasks. Their lofty titles justify the use of the term 'commanders' (if not generals) for these noblemen. A fourth category of functionaries were the heads of four houses (also called *tongkonan*) of freemen (*to makaka*) who held various ceremonial and ritual offices. They represented the four dependent regions (*lili'*) of the great or central *adat*. After them came the *lili'* of the seven categories of slaves, fulfilling numerous specific and by no means always undistinguished functions. Then there were the dependent regions (*lili'*) of the small *adat*, six in number, all with their leading *tongkonan*. Apparently, their leaders, too, were freemen, as opposed to the leaders of three other areas, the *Padang di Aluk*

which, in one way or another, also formed part of the kingdom. Although the term by which these parts were denoted is rather obscure, the rank of their *tongkonan* was not. One of them at least, described as the deputy of the *puang*, had a status of high nobility.

All in all an impressive array of functionaries and of regions connected with them. The Toraja speak of these regions (those of the To A'pa' included) as the twenty-four *Sereala penanian*, the twenty-four subdistricts, possibly an allusion to the twenty-four poles which support a *tongkonan*. Because this number is divisible by both 4 and 8, however, important numbers in Toraja symbolism, the term should not be taken too literally. In fact, adding up the categories mentioned, we come no farther than 21, if slaves are excluded, reaching either 22 or 28 if we count them. Differences of this kind are not disturbing to the Toraja. The symbolic value of a number is more important than its quantitative precision. The same holds true for the inflated titles and momentous functions ascribed to office-bearers. These are important in man's ritual and symbolic intercourse with the gods and the upperworld, not in the uneventful routine of everyday life. Today this is even more true than in the past, when Sangalla' was an independent realm which had to see to all those worldly affairs which have since become the responsibility of government. The last time the ceremonial apparatus functioned in full was on the occasion of the mortuary feasts celebrated for Puang Palodan XII (Puang Lasok Rinding) in 1970 and 1972. All the same we will discuss these functions and territories here in more detail before we reconsider the structure of the kingdom as a whole.

A. The *To A'pa'*, the vice-regents of the principedom assisted the *puang* in his administrative task.

1. The chairman of the *To A'pa'* held the title *Tanduk Tata'* (literally: 'Sharp, Pointy Horns'). His concern was justice. His *tongkonan* was Dulang (according to a different informant, his parent-house was said to be *tongkonan* Palagian).
2. The second *To A'pa'* held the title of *Londong Kila'* (*londong* = cock; *kila'* = lightning). His region was Buntu Tongko'. He engaged in affairs concerning the defense of the kingdom. Buntu Tongko' was his *tongkonan* (according to others it was *tongkonan* To Masaa).
3. The title of the third ministerial post was *Pangala' Tamman* (literally: 'Impenetrable Wood through which no human sound penetrates', alternately: *Kurra manapa'* i.e. 'Dense thicket', 'Dense Under-

brush'). His region was Suaya, his *tongkonan* had the same name. He attended to the financial affairs of the state.

4. The final functionary bore the title *Pa'palumbangan* (literally: 'The Piling of the Bundles of Rice on the *Sawah* Dike', alternately *Pa'palukan* = ?). His responsibilities included religious observances and the *adat* of Sangalla'. His region (*tongkonan*) was Solo'.

Informants compared these managerial assistants with public officials in western countries, e.g. Minister of the Interior and Justice (no. 1), of Defense (no. 2), of Economic Affairs (no. 3), etc.

The *tongkonan* of the To A'pa' lie in a semi-circle to the south and the west of *tongkonan* Kaero (see the sketch of Map 4). The To A'pa' met together only when there was a pressing reason for them to convene. As far as kinship with the *puang* is concerned, only the ramage that inhabited *tongkonan* Dulang was related to that of *tongkonan* Kaero. The ramage of the Tanduk Tata' is also related to that of *tongkonan* Suaya. Relations among these *tongkonan* were governed by specific rules of reciprocity. A buffalo head presented by one *tongkonan* A'pa' to another, need not be reciprocated if it derived from a sacrifice that constituted part of the ritual obligations of the giving *tongkonan* towards Kaero.

B. The next four important functionaries were the *Limbu A'pa'na Sangalla'* (*limbu* = cornerpost). These officials were referred to as the 'Four Cornerposts' of Sangalla'.

1. The first functionary, entitled *Bulian Massa'bu* ('The Thousand Blowpipes'), had jurisdiction in Boto'. His second title was *Doke Mangriu* ('The Thousand Spears'). His *tongkonan* was Batara Lan (according to Puang Tandilangi', *tongkonan* Boto'). Boto' lies in the southwest of Sangalla' to the *southwest* of Kaero which is located in the center of the state.

2. Tokesan is the place of residence of the second functionary whose title is *Palasa Makati'*. The title means, roughly, 'Some who is like a bull with a hump that itches him constantly, someone who is annoyed and is continuously ready to attack the enemy'. Another title: *Tanduk Beuaran* ('Poisoned Horns'). His *tongkonan* was Patobok (Puang Tandilangi' says it was Tokesan). Tokesan is situated in the *southeast* of Sangalla'.

3. Lampio is the region where the third functionary exercised authority. His title was *Guali Bassi* (literally: 'Iron Doorframe', alternately, *Ba'ba Lumuran* i.e. 'The Door Covered with Moss'). Toarasan was his *tongkonan*. Lampio is in the *northwest* of Sangalla'.

4. The fourth official's region is Leatung in the *northeast* of Sangalla'. His title was *Rinding Daun Induk* (literally: 'The Wall made out of Sugar Palmleaves', alternately: *Sapan Kua-Kua*, 'Dam or Barrier of Reeds that grow in Puddles').¹¹ Should an enemy approach from the northeast, then this titleholder would sound the alarm. His *tongkonan* was Ne' Lallo.

Many of these titles, e.g. *Bulian Massa'bu*, and *Tanduk Tata'* are indicative of a defensive function; 'The Iron Doorframe' and 'The Wall of Sugar Palmleaves' also convey the notion of a protective function. The situation of the *tongkonan* of these functionaries in the four corners of the state (see sketch Map 4) is of specific interest. Apparently they guard the four corners of the realm.



Map 4 A sketch of the princedom of Sangalla'; the location of the *tongkonan* of the *Puang*, the *To A'pa'*, and the *Limbu A'pa'na Sangalla'*.

C. Sangalla' is further subdivided into various dependent regions known as *lili'*, each with its own title-bearing *tongkonan*. These *lili'* are of three kinds. The first is that of the *Ada' Tangnga Sali* ('the *adat* of the middle of the *sali*-room'). The *sali* is the central room of the *tongkonan* and the name apparently refers to the geographic location of the four *lili'* which belong to this *Ada'* in the central area which surrounds Kaero. They are not indicated on the sketch of Map 4.

Another association evoked by the name *Ada' Tangnga Sali* is that of the Indonesian term *hadat* for court, as applied in, e.g., the term *Hadat Luwu'*, the court (or state council) of Luwu'. This, however, cannot further be substantiated. We must return to the four *lili'* concerned. They are:

1. Longga Patalo, to the south of Kaero, with Kolaa' as its *tongkonan*, entitled *To Pasumbungan Puduk, Paumpu' Pau-Pau* ('The Spokesman; the Joiner of Words, the Conveyor of Words'). If someone wanted to enter Kaero he was not allowed to do so straightaway but had first to pay his respects in Longga Patalo. This even holds for the *To A'pa'* as well!
2. Mariangga, to the east of Kaero, with *tongkonan* Kasaeen, entitled *Tumanan Talinga tang bimbang lemedan pili' tang pingo-pingo*. Translation of this elaborate title is difficult. *Tumanan talinga* means 'pricking up the ears'; *tang bimbang* means 'not tilting, not wavering towards one side'. Apparently the title refers to a certain vigilance, because it was the task of this functionary (or functionaries) to report directly to the Londong Kila' (state administrator no. 2 above) if he (they) observed any signs of unrest locally (thus in Sangalla').
3. To' Kalumpini', with Karassik as its *tongkonan*, entitled *Disangan Kande Pakunna Sikambi' Kaunan Matutu lan tangnga sarinna Kalindo Bulanan*. The title means something like: 'Who is called after the ferns which are his food together with the assiduous slaves in the midst of the elite surrounding His Majesty'.

When an important feast was scheduled (a ritual for the dead or another celebration), the leading functionary from this group was entrusted with arranging the chores of the *kaunan*, such as the fetching of water, the gathering of firewood, etc.

4. Salembe' with *tongkonan* Kalintua' with the title *Disangan Kande Pakunna Sikambi' Tona' Tedong pa'lak* etc. This title is also difficult to translate. *Disangan Kande Pakunna*: 'who is called after the ferns which are his food'; *Sikambi'*: 'care for each other'; *Tona' tedong*: 'the power of the buffaloes', thus something like 'taking care of the

powerful buffaloes'. These names all seem to refer to the rendering of simple services and to the supervision of slaves. This, together with the services required from the three preceding *lili'*, accords with the fact that they are all members of the class of the three farmers, the *to makaka*, who reside in these subdistricts. All are middle-class people who do middle-class work.

D. After these *lili'* of the *to makaka* of the central area follows the *lili'* of the Basse Maruang who belong to the class of the *kaunan* ('slaves'). Basse Maruang may be freely translated as 'The Agreement with the slaves' (*basse*: agreement or league; *maruang*: a specific piece of meat from the breast of a sacrificial animal always allotted to the slaves). The Basse Maruang as a class is entitled *Todipokarambau tempe' lan esungan to manurun disanga pegung dapo' parande lalikan, petimba uai, pele'to kayu dan tongkonan layukna Kalindo Bulanan*. Translation again entails difficulties; the title is connected to functions. *Pegung (Peguntu') dapo'* = 'The one who holds the three hearthstones in the open palm' (?); *Petimba uai* = 'The one who fetches water for the *puang* living in the *tongkonan layuk'*.

The following functionaries and titles fall under the Basse Maruang:

1. To Mannanna, belonging to *tongkonan* Batu A'riri in the settlement of Saninong. This official arranges everything connected with work on the *sawahs*. The *sawah* referred to as *kabusungan* ('the rice fields of the *puang* which have been consecrated') was cared for, report has it, by the entire population of Sangalla' (but then apparently on a rotation basis). Cutting of the rice was the job of descendants of the *kaunan* Sarruk from the village of Kaero (To' Waka'). Terms of payment for those performing the cutting were not reported. (N.B. Even slaves had a *tongkonan* of their own.)
2. To Malia, whose *tongkonan* lies in Tampak. As a servant in the *tongkonan* Layuk, the titleholder arranged everything that had to do with meals.
3. To Malia (with Kalembang as *tongkonan*) who served as courier between the *tongkonan* Layuk and those of the *To A'pa'*.
4. Sapupang of To' Waka' (Uaka') who fetched wood and water for the palace.
5. Lai' Riang of Bubunbai, with the task of sewing, seeing to preparation of clothing that was necessary (for feasts), etc. at Kaero. The designation Lai' is an indication that the function was filled by a woman.

6. Pong Daun Lau' at Tampak; he oversaw the pounding of the rice and other matters related to rice and to eating and drinking, etc.

7. Sae Kallong at Kasanan who acted as midwife in the palace and if necessary and possible, as wet-nurse of a new prince or princess. The functions listed above fall to *kaunan* who descend from a particular figure. There were thus usually a sort of court attendant and fell under the *kaunan bulaan*, the highest category of slaves (see III.2).

In the *lili'* of the Basse Maruang there are five villages: 1. Suaya; 2. Katangka; 3. Wala (Uala); 4. Raru'; 5. the area between Siya and Kambutu.

E. Next come the dependent regions (*lili'*) designated as Ada' Bitti' (literally: 'Small *Adat*'). These include the following *tongkonan*:

1. Bokko, entitled *To dipaulunna Sangalla'* ('The one who is placed as the Head of Sangalla''), also at times referred to as the *Tallung penanian* ('The Three Regions'): Tambunan, Tandan Batu and Bokko.

2. Bebo', entitled *Talinga rara'na Kabarrear Alloan*, or else, *Dipari-matanna Kabarrear allo*, which mean: 'The splendid Ear of the Illustrious, the splendid Eye of the Illustrious'; the title joined to the *tongkonan* alludes to vigilance.

3. Tumanete, entitled *A'riri Posi'* (the *a'riri posi'* is the most important of the piles of a *tongkonan*; see VIII.1). The function allied with Tumanete implied that the functionary was spokesman and chairman during meetings (in this region?).

4. Aa', entitled *To dipalisuna Umbu'* ('He who is made into the soft center of the young rice grain'; *palisuna* = center; *umbu'* = the young rice at the point of coming into the ear). This functionary assists the *Pa'palumbangan* (see A4).

5. *Tongkonan* To Gandang in Sarapang, with the title *Gandang Boro* ('the Good Drum, the Peaceful Drum').

6. *Tongkonan* Padandan (reported by a different informant as *tongkonan* Sibunoan) at Kaliba', also bearing the title *Gandang Boro*.

F. Finally there are the dependent regions known by the ambiguous name of *Padang diAluk*, a designation which — perhaps — may be explained as land according to custom (belonging to Sangalla'). The explanation is uncertain. *Padang* means earth or land, *aluk* ritual and, occasionally, custom. To these belong:

1. Batualu, entitled *Liku Lambe'na Kalindo Bulan*, alias *Tasik*

tikululunna Kabarrear Allo, with Buntu as its leading *tongkonan* (according to Puang Sombolinggi' To Katapi is the name of the pre-eminent *tongkonan*). The first title means: 'The vast, deep pool of the Majestic One'. The alias signifies: 'The wavy sea of the Splendid One'. There is a title connected to Buntu: *Pekampa Langsa'*, *Perompo Durian* i.e. 'The guarding of the *langsa'* (a fruit, *Lansium domesticum*), The fencing of the *durian'* (also a fruit, *Durio Zibethinus Murr*). This *tongkonan* is spoken of as the deputy of that of the *puang*. In this region also *tongkonan* Papa tallang (Pada tallang?) should be mentioned, with its associated title: *Samungan pudukna Kalindo Bulanan*.

2. Simbuang (Sibuang),¹² entitled 'the Space under the House for the buffaloes' (*To disulu' Tedong*) or 'The Buffalo Corral' (*To diborntong Karambau*), with Marintang as its leading *tongkonan* which bears the title *Bara' Bulaanna Kalindo Bulanan Manete Kandauren Kabarrear Allo* ('The Golden Longitudinal Beam of the Majestic One, The Ridge Beam of the Splendid One that shines like an Ornament of Beads'). This *tongkonan*, situated in the east of Sangalla', functions as a kind of sentry or sentinel (to the east lies Luwu').

3. Uluwai (Ulu uai), designated as *Inggok Bulaanna Kalindo Bulanan* ('The Golden Tail of the Kalindo Bulanan') and also as the *Taru'tuk Kandaurena Allo*. The first title is connected to the southerly location of Ulu uai which now lies in Mengkendek. The second I cannot explain because no translation is known for *Taru'tuk*. Furthermore Tandilangi' (1967) makes mention of Pada Tallang, falling under the Padang diAluk, as the spokesman of the Kalindo Bulanan.

The functions which are fulfilled in the Ada' Bitti' and Padang diAluk are of different kinds. Here, too, we encounter a protective, perhaps defensive task. *To dipaulunna Sangalla'* ('The Head of Sangalla'') kept a look-out against possible dangers that might come from the north; the 'Tail of Sangalla'' was alert to threats originating to the south; Simbuang guarded against danger from eastern sources, the former state of Luwu'. Batualu also had a function at feasts and saw to the completeness of rituals.

The *Talinga rara'na Sangalla'*, as mentioned, kept their ears open; they functioned as a sort of intelligence or security force for the leading *tongkonan*, that is, for Kaero. The *Gandang Boro* was occupied with affairs which 'went forth' from the prince, the *Kalindo Bulanan Kabarrear Allo* (my informant let the word 'propaganda' fall in connection with this office, yet the word strikes me as too western to clarify the job of the *Gandang Boro* satisfactorily). Moreover, there

were two *Gandang Boro*, one in the west (Sarapung) and one in the east (Kaliba'). The *A'riri Posi'* handled affairs which concerned Kaero itself. The *To Dipalisunna Umbu'* had a similar function.

Furthermore the *Borisan Rinding* ('the Boundaries of the Wall') should still receive mention. They remained attentive to everything that happened inside their region. If there was a feast, they brought the *barasang* (large basket shut with a lid) in their retinue as a sign that they had already brought a *kerbau* (buffalo) or a pig to the leading *tongkonan* (= Kaero). They did not sit down until a mat was spread for them because only once the mat was down was their reception official.

Although Sangalla', like Kesu', was built up of smaller territorial units (*penanian*, and others), it had a rather different structure. Its administration was more centralized; the significance of the prince — a central figure who in Kesu' actually was non-existent — was great even though, in all sorts of worldly affairs he was very much dependent on the cooperation of his nobles who all owned their private territories. The prince's greatness was primarily a matter of the elaborate ceremonial that formed the real focus of his subjects' life and interests. This prevalence of ritual and ceremonial values has a solid basis in myth. The myths of Tamborolangi' and Lakipadada contain the origin of the princely families in the *puang*-lands (see VI.2.1). In Sangalla', as in other *puang*-regions, important regalia of mythical origin are in safe-keeping. These regalia are still preserved in the princely *tongkonan* and brought forward at great rituals.

We do not know what terms were used to speak of the princes of Ma'kale and Mengkendek (respectively the older and younger brothers of the prince of Sangalla'). We do know, however, how the *puang* of Sangalla' was referred to:

"Gleaming like the Moon, Shining as the Sun,
When he raises his voice, no one can oppose him,
When he makes a statement, no one can disagree.
His origins merit awe, his ancestors deserve honour.
He dwells in a palace that is like a diamond,
He takes repose in a house that is like a precious stone . . ."

(Puang Paliwan Tandilangi' 1975: 96)

Tandilangi's versions of the *puang*'s titles differs somewhat from translations which Van der Veen provided for me: the prince is not illuminated by the celestial bodies, rather he is compared to them.

On the basis of Tandilangi's text it is possible to associate the prince with Puang Matua and Pong Tulakpadang who represented day and night. His realm, too, is *Lepongan Bulan* ('Round as the Moon'), *Pandan Matari' Allo* ('Extensive as the Sun'). The *puang* is illustrious and exalted, and, judging from the conditions set for the successor of such a prince, he is more than an ornamental figure. Whenever the diverse councils within his principedom gathered, he had the decisive voice, for example, in discussions concerning war and peace. When it was impossible to settle a quarrel at the village level, the case was laid before the *puang*. Certain *puang*, such as Lasok Rinding who died in 1968, were extremely knowledgeable about *ada'* and *aluk*, about the *adat* and the ritual.

The prince is the center of his domain, but he does not stand alone. He is protected by his 'Four *Tongkonan*' (The *Tongkonan A'pa'*) and his 'Four Cornerposts of Sangalla' (*Limbu A'pa'na Sangalla'*). The *Tongkonan A'pa'* lie primarily to the west and south of the prince's residence; perhaps they mark the border between West and East, two spheres which are strictly segregated. The western part is that of the earth and ancestors from 'olden times', the eastern that of the ancestors who, deified, ascended to heaven. The house of the *puang* has the *tongkonan* of myth, 'the Swaying House' (*Banua diToke'*), home of his ancestor originating in heaven, as its prototype. It has 'Four Cornerposts' (the *Limbu A'pa'na Sangalla'*) which represent the four cardinal wind directions (NW, NE, SW, SE); these, as it were, assure the safety and keep guard over the *puang's tongkonan*. The center (*Tongkonan Kaero*) is surrounded by four *tongkonan* and protected by four others on the western side; Sangalla' numbers twice four plus one (= nine) important *tongkonan*.

The dignitaries cited above belonged to the nobility. The *lili' Ada' Tangnga Sali* included the *to makaka*, while those of the Basse Maruang contained the slaves so that, as far as class is concerned, a tri-partite division existed.

The *to makaka*, the free, stand between the nobility — with the prince as their leading figure — and the unfree. This perhaps explains why the titleholders in this group function as mediators or go-betweens: no one is permitted to enter Kaero without the knowledge first of 'The Joiner of Words'. The 'Eyes' and 'Ears' of this class must report all irregularities and iniquities to the Londong Kila', the state administrator who is entrusted with affairs of defense. Yet another of these functionaries acted as intermediary between the palace

and the offspring of the *kaunan*, the slaves. We might, so it seems, clarify the designation *Ada' Tangnga Sali* ('the *Adat* of the Middle Room') by remembering the position which this room (the *sali*) occupies in the houses of Sangalla': as far as elevation is concerned, it lies midway between the other two rooms (the nobility? the slaves?).

The Basse Maruang are the slaves. Their periphrastic title 'Those who are used like buffaloes on the *sawah*' makes their position in the past explicit (one should realize that this past is not so very far behind us). The hewing of wood and the drawing of water were slaves' tasks. It is striking, however, that slaves were also given important functions such as conveying messages between the *tongkonan* Layuk (Kaero) and those of the *To A'pa'*. Their offices also included caring for the children of royalty, for the apparel of those in 'the palace', for the thirst and hunger of palace residents. The agreement or the bond contracted with the slaves in the past specified that not only did they have duties, but rights as well.

The following should be added to this description of Sangalla'. The state stood in a certain relation to the princedom of Luwu'. The prince of Sangalla' had a specific title: *Datu Matampu'* ('The Prince of the West'). The prince of Luwu' was the *Datu Matallo* ('The Prince of the East'). The two states thus stood in a west-east relation to each other. The one was the 'Lord of the Dominion of the Sinking Sun', the other was 'Lord of the Kingdom of the Rising Sun'.

The rice ritual falls in the sphere of the rituals of the East. Once a year a delegation from the prince of Sangalla' brought a cock to the Datu of Luwu'; he in turn presented a gift of sowing rice. The custom is known as *melondong Datu* ('the bringing of a cock to the *Datu'*, the prince). I do not know how far into this century Sangalla' continued paying this tribute — for it certainly is a tribute — but there can be no misunderstanding about the relation. It is one of West and East in which West is necessarily inferior to East.

IV.1.8 *Ma'kale and Mengkendek*

Ma'kale consisted of four federations of *bua'* (*penanian*): Ma'kale (with 8 *bua'*), Kasimpo (with 4 *bua'*), Pabuarang (with 6 *bua'*) and Mendetek (with 6 *bua'*). The state was ruled by a *puang*. In his administrative task, he was assisted by:

1. the Tanduk Tata' who resolved law cases which could not be settled within a *bua'*-circle;

2. the Ampang Bannu' (*ampang* = threshold; *bannu'* = strips of bamboo) who seconded the prince and the Tanduk Tata' in their work;
3. the Takia' Bassi ('the Iron Arm') who commanded the warriors in wartime.

Mengkendek contained 8 *lembang* or *bua'*: Bala, Tinoring, Tantri, Parorean, Baturondon, Palipu, Tengan and Marinding. The last three are called *To Tallu Penanianna, sesena Mengkendek* ('The Three Penanian, the half of Mengkendek'). The remaining five *bua'* constitute the other half. These five areas were under the authority of a Tanduk Tata' (or of *the* Tanduk Tata'?), the other three under a *Papalumbangan*. The *Papalumbangan*, too, had an administrative task.

Another part of Mengkendek is that of the *adat*-communities Gandangbatu, Silanan and Tampo. Silanan has an *adat* that differs in many respects from that of Mengkendek. It was originally an independent realm that united (voluntarily or under compulsion) with Mengkendek and afterwards was called *Bassena Tau Karua, Tau Sangpulo* ('The League of the People of the Eight [= Mengkendek] with the People of the Ten [= Silanan]').¹³

IV.2 The village: functions

IV.2.1 Introduction

A village (*tondok*) consists of farmsteads that are somewhat dispersed. Before the arrival of the Dutch the farms stood closer together. Villages then were usually surrounded by an earthen rampart. One can divide the village area in three:

- a. the compounds, where houses (and opposite them, rice barns) stand;
- b. cultivated land, *padang* or — sometimes — *pempatuanna*. The latter word usually denotes the complex of irrigated rice fields, the most valued of all arable land;
- c. the village woodland, *pangala'*.

Within the village area also fall: graveyards (sometimes in combination with other villages); the *rante kala'paran*, a field where the important rites of the great *bua'*-feast take place (sometimes several villages possess such a terrain collectively); the *rante*, a flat space where the concluding rites of the entombment rituals are celebrated (in some regions, e.g. in the Tallulembangna, this space is called the

pantunuan). Some villages also have a place where a market is held regularly.

The Toraja village is sometimes divided into a high and low part. A point in case, to which we shall return below, are Kesu' villages. The opposition between high and low, on the face of it reminiscent of the Balinese opposition between sea-side and mountain-side, is, however, of quite another nature than in Bali. In Bali the opposition is part of a generalized system of orientation (and classification) in which sea-side and mountain-side coincide with south and north (or inversely), but in Tana Toraja the opposition high-low is of purely local definition and independent of cardinal compass-points.

Social centers of the village are the small common areas already mentioned (*rante*, *rante kala'paran*, the market terrain, graveyards and in modern times, the church).¹⁴ Village houses, too, have such a function; those houses which enjoy a certain status and to which a title belongs are social centers of special importance. The position of these *tongkonan*¹⁵ is also a subject to which extensive attention will be devoted in the discussion of ritual (Vol. II). The settlement plays a great role in the life of the Toraja. The significance of the villages is closely related to the significance of ritual in society. The Toraja concept of an ideal, archetypal settlement (as a place where rich people live, a spot where all thrives and prospers) is conveyed in Van der Veen's translation of the *Lofprijzing op de gemeenschap der dorpen* [Laudation of the community of the villages]. (Van der Veen 1979: 199-212.)

From the standpoint of administrative organization, the village is the smallest autonomous unit. Van Baal (1972: 306-316) has directed attention to the fact that in Indonesia the power of the prince extended as far as the village-borders. This statement hardly obtains for the Toraja: the might of the *puang* in the Tallulembangna permeated far into the villages. It is true that at present in certain instances this might is on the decline, yet, on the other hand, certain members of the *puang*-ravage are still resourceful enough to exercise their authority through a clever combination of the *adat* and of opportunities provided by the modern political system (see Crystal 1974).

The material culture of the Indonesian village prior to World War II has been excellently described. Yet, how such settlements functioned in practice, the way things proceeded at the administrative-organizational level, is a matter which presented great difficulties to outsiders who tried to penetrate into its daily ins and outs. The best

accounts are those dealing with the *desa* on Bali.¹⁶ The ancestor who founded the village is invariably of great importance. Van der Veen reports how during the *ma'tomatua* ceremony, the *to minaa* addresses this village founder, the *pangala tondok*, in his prayer:

“Oh, ancestor, thou who hast founded the village in its fullest extent (literally: *lepongan tondok*, ‘the circle of the village’) we desire blessings, for the good day has dawned upon which we, the golden descendants, appear before thee”

(The Chant: 7)

The descendants of this village founder are the *anak patalo* or the *gora-gora tongkon* (see III.1.2).

The construction of the first *sawah* is also significant; people are still able to point out which rice field was the first. It is referred to with a categorical name: *tandung tiulu* (‘the first *sawah* laid out’; *Woordenboek*: 679, v. *tiulu*: that which is the beginning, the source; or *tandung*: spacious field).

IV.2.2. Kinship in the settlement

Pangala tondok is the appellation of the founders of the village. Their descendants can occupy different positions in the settlement. It is probable that a large proportion of village inhabitants is related to each other, yet no research confirming this probability has yet been carried out. Kennedy, however, speaks of village endogamy and argues that, should someone choose to marry a spouse from ‘far off’, this could raise difficulties when the time came for celebrations (in this case, especially mortuary feasts): invited family members would then have to travel a vast distance (Kennedy 1953: 161). This depends, however, on the kind of feasts to be observed: for a *merok*-ritual relatives convene from far and wide. Thus, despite village endogamy, one has kin who live far away. This is above all true for the upper classes, but even for the lower classes the term village endogamy should not be accepted as strictly valid.

IV.2.3 Local divisions in connection with the offices which village residents hold

The majority of the village population farm; an extremely small percentage holds an office in government, or works as a craftsman (for statistical profile, see Kennedy 1953: 159-160). Often people both

farm and practice a craft. In the text below it is primarily offices within the traditional social structure (thus not the position of the village schoolteacher, etc.) which are discussed. Mention should be made of the fact that this structure can differ according to region (in this respect little is known about Baruppu'). Most villages are divided into two or into four (division into three occurs also, but not frequently). Kennedy has described a village divided into four: Marante in Kesu', situated in La'bo' (Kennedy 1953: 149-150); I have supplemented his data with explanations from Van der Veen's *Woordenboek* (1940). Every quarter of the village is called *tepona tondok*, derived from *tepo* ('to divide into four' or 'one quarter of') and *tondok* ('village'). The quarter parts are also at times referred to as *kande padang tepo tondok* ('the portion of the meat [literally: the food] for the land of one quarter of the village'). Whenever on the occasion of a ritual, a buffalo is sacrificed in one of the quarter parts of the village, then the beast is cut into four; the *tepo padang* where the sacrifice took place retains one share, the other three shares are distributed equally among the remaining three village components.

In Kesu' these (*sang*) *tepo padang* are in turn further subdivided into *saroan*, wards, whose residents are obliged to furnish each other with mutual aid.¹⁷

The word *saroan* comes from *saro* ('payment or compensation for work'). A *sangsaroan* is a group of people who inhabit such a ward together. In rotation they farm each other's land. After the fields of one have been cultivated, work begins on the land of another fellow *saroan*-resident, and so on, until the work of all has been accomplished. Mutual aid also takes the form of helping to repair and to maintain the *sawah* dikes. People also assist each other during the *menammu pare*-sacrifice that is made at the start of the harvest (these Toraja words have the literal meaning of 'receiving the rice, bringing the rice in'). The offering takes place at the time people are about to start to harvest the ripe grain; a thanksgiving offering is then made to the rice. Every *saroan* performs this *menammu* separately. All the inhabitants of the ward are supposed to contribute towards procuring the number of pigs needed for the sacrifice; contributions consists of rice or of money. From every house, moreover, a pot full of boiled rice must be brought to the place of the sacrifice, part of the contents of which will be used in the offering (*Woordenboek*: 363, v. *menammu*).

The *sangtepo padang* are each divided into four to six *saroan* (in

La'bo'), see fig. IV.1. Each of the four principal village parts, and every *saroan*, too, has a name. One of the four quarters is taken to be the oldest, and here more village *tongkonan* are situated than in any of the other quarters. To take Marante as an example:

1. Tondok, the 'oldest' quarter, includes *tongkonan* Buntuasa, Sullukan, To Mendarang,¹⁸ Rante, Katik;
2. Bo'ne has *tongkonan* Balatan, Pa'utanan, Sudu;
3. Linda has *tongkonan* Tampang Allo, Sura' and Sipate;
4. Balatana, the newest quarter, contains only *tongkonan* Bakeke.

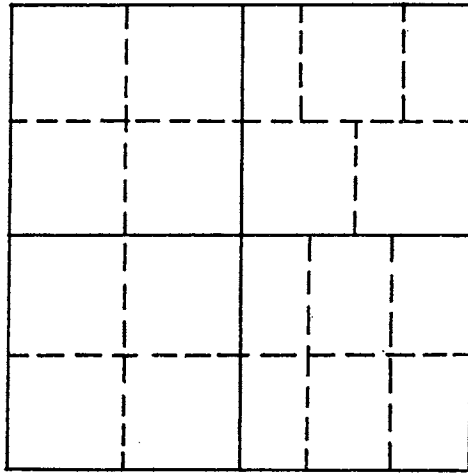

Fig. IV.1 Schematic representation of the division of a village into four *sangtepo padang* (a), and four to six *saroan* (b). In reality the division is not likely to be so absolutely geometric, nor so precisely oriented to the directions of the wind. It is usual, as in Marante, for the senior *sangtepo padang* to occupy the highest part of the village site.

Seven of this total of twelve *tongkonan* have a *to parengnge'* at their head. The *tongkonan* without a *to parengnge'* are apparently of later origin. Each of the *to parengnge'* has a specific title (Kennedy 1953: 152). The village council exercises authority over the village as a whole; its members are the *anak patalo*, the heads of the village quarters and of their constituent *saroan*, and experienced old men,

including the village head, the *to pongmasa'ga'* ('the powerful one').¹⁹ There are no councils for the separate quarters, although the heads of these quarters have a function in the organization of rituals. Kennedy reports that these figures are called *anak to makaka*.²⁰ Every *saroan* also has its head, the *pangarak* ('he who calls people to do their duty'); formerly these duties included the statutory labour prescribed by the colonial administration. *Saroan*-heads, in contrast to the heads of the four quarters who must always be nobles, may belong to any class.

Besides, the village of Marante is also part of a federation with three other villages: Mengke'pe', Tandung and Karatuan. They are known as *patang penanian*, a federation of four *bua'*-communities (*Woordenboek*: 379). The complex of the four villages is compared by Kennedy to the Javanese *moncapat*; similar divisions into four, as is well-known, exist also elsewhere in Indonesia (cf. Duyvendak 1940: 116; Van Ossenbruggen 1918; and IV.1.3 above). Although the comparison is not without ground, the impact of this partition into four should not be overestimated. It is a trend, not a must. Thus, for example, when buffalo meat is exchanged as part of the *ma'kande padang*, one of the mortuary rituals, meat will be presented to three neighbouring villages. If the village happens to be contiguous to three other villages, but if there are only two neighbouring villages, then there will be but three partners in the exchange relation.

Whenever several *kerbau* are sacrificed in the course of a mortuary feast, four, let us say, then, according to Kennedy, each of the partners in a four-strong exchange relation such as that which characterizes the *patang penanian* will receive one buffalo (1953: 181). This is perhaps an oversimplification of what happens; presumably specific parts of every *kerbau* sacrificed were distributed among the three other villages.

The internal structure of one village may well differ from that of others. At times the parts of a village in Kesu' constitute together a single *bua'*-circle, at times each of the parts separately is already such a community whose members celebrate the *bua'*-feast collectively. The village of Angin-angin, also in Kesu', has a subdivision into halves. The village is split into two: the more elevated portion is designated as *donalu* (*do* = above; *lu* = [up] there); the lower as *diongnalu* (*diong* = below).²¹ The leading personage in each village-half of Angin-angin is the *sokkong bayu* (literally: 'the collar of the jacket').²² His other name is *datu muane* ('lord' or 'prince'). The *sokkong bayu*

has more status than the *datu baine* (the 'female' lord or prince) who is the second head, a function again found in each of the village parts. The *datu baine* is, as a rule, a man, despite the femininity of his appellation. (It is possible for women to occupy this position as well as that of *datu muane* or other positions to be mentioned subsequently.)

The *sokkong bayu* (*datu muane*) and the *datu baine* form, as it were, a pair. Tradition has it that the title of *sokkong bayu* was first instituted during, or shortly after, armed resistance to the invasion of the Bonese (*untulak buntunna* Bone). In a number of other villages in Kesu', other than Angin-angin, there are also two *sokkong bayu* and two *datu baine* for the village as a whole.

In Angin-angin (as in other villages in Kesu') there is no clear-cut division into 'east-west' or 'right-left' but rather a partition along the lines 'high-low'. Titleholders play a part in specific rituals. There are still other functionaries in each section of the village, not all of whom are *to parengnge*'.

Functionaries in Angin-angin (Kesu')

donalu:

sokkong bayu (*datu muane*): 'the collar of the jacket'; he performs the *mangimbo*

datu muane: lord or prince

to ussomba tedong (*datu baine*): the one who consecrates the *kerbau* at the *merok*-feast. *Datu baine*: the 'female' lord or princess

to manobok: the one who slays the *kerbau* with a lance at the *merok*-feast²³

to massadi: the one who cuts the meat of the sacrificed *kerbau* into pieces

to ma'nasu: the one who cooks the meat

to massanduk (or *ma'sanduk*): the one who serves the rice

to usserek daun punti: the one who tears the banana leaves; *daun punti* — on which the offerings are set down

*diongna*lu:

The same seven functionaries as listed above for *donalu*.

Originally there was yet an eighth office-holder in each of the two village sections; apparently he is mainly remembered because he completed the number of 8 functionaries, 8 being a favourite number in Sa'dan-Toraja culture.

In Angin-angin *donalu* the *sokkong bayu* is the heir of the oldest *tongkonan* (the 'mother'-*tongkonan*), *tongkonan* Komba; the *to us-somba tedong* is the head of *tongkonan* Manaeng, a *tongkonan* of longer standing than the other functionaries listed below him. Among the other titleholders there are those who are the heads of *tongkonan* of more or less equivalent rank. Not all functionaries are heads of a *tongkonan*, only the first four on the list. There are four *tongkonan* in upper-Angin-angin (*donalu*), and four in lower-Angin-angin (*diongnalu*). There is a story that in the past an altercation arose as a consequence of a disagreement (*sisakka*) between the *to parengnge*' of Komba and of *tongkonan* Manaeng. The *sokkong bayu* of Komba practically lost this dispute. The village council convened to make peace; the function of *datu baine* remained the privilege of *tongkonan* Manaeng, but at the same time *tongkonan* Parinding was also awarded this title. (The situation is not altogether clear, presumably *tongkonan* Parinding was an ally of *tongkonan* Komba.) This controversy took place about five generations ago, in any event after the *untulak bun-tunna* Bone (information from L. Pakan).

Diongnalu has the same allotment of titles as *donalu*. If a person holds a feast in one section of Angin-angin and slaughters a buffalo, the beast is divided in two; half is then given to the other section of the village (cf. the *patang penanian*).

Angin-angin, too, is subdivided into *saroan*, wards whose populations are pledged to mutual aid just as in Marante, the village where Kennedy carried out his study. What obtains for Angin-angin is true for the whole of Tikunna Malenong, the complex of villages around the cliff of Malenong: Ba'tan, Tonga, Angin-angin and Pao. The principal lines along which the internal division of the villages takes place are the same. In all these villages, *donalu* and *diongnalu* either each constitute a *bua*'-circle (Angin-angin) or together make up a single *bua*'-community to which all inhabitants belong (Ba'tan).

Titles are connected to particular *tongkonan*. Members of a *tongkonan* propose someone for a title from among the descendants of the founders of their house; their nomination must be confirmed by the village council. The installation of the *sokkong bayu*, or of another important *to parengnge*' takes place during the *merok*-feast or some

other major ritual. A great ritual is the occasion which gives substance to these titles, whether it be a *merok*-, a great *bua*'-feast or any other big celebration for which guests are invited from far and near.

For the offices which exist in the village of Tonga in the territory of Kesu', see Vol. II sub *Manganta*'. Below follows a summary of titleholders in Ba'tan, Kesu'. Here the two village-halves, Ba'tan *doan* and Ba'tan *diongan*, do not have identical sets of titles, but have the various functions divided between them.

Titleholders in Ba'tan, Kesu'

Ba'tan doan

1. *Sokkong bayu (datu muane)* a title belonging to *tongkonan* Banua Sura' founded by its ancestor To Batu (or Emba Tau); he delivers the *mangimbo* ('prayer') at the following feasts:

- a. *merok*
- b. *mangrara banua*
- c. *la'pa' kasalle*
(i.e. *bua' kasalle*)
- d. *la'pa' padang*
(i.e. *bua' padang*)

He recites the prayer in the yard of the celebrating *tongkonan*.

3. *Ma'sanduk*, a title belonging to *tongkonan* Tangdo Ruma-ruma; founded by one of To Batu's sons. He performs the *ma'sanduk* within the compound at the following feasts:

- a. *mangrara banua*
- b. *merok*
- c. *la'pa' kasalle*

Ba'tan diongan

2. *Datu baine*, a title belonging to *tongkonan* Ne' Pareakan founded by Palibiran who named it after his grandfather; he performs the *massomba tedong*, the consecration of the sacrificial *kerbau* at the following feasts:

- a. *merok*
- b. *mangrara banua* (if a *kerbau* is sacrificed)
- c. *la'pa' kasalle*

He also performs the *mangimbo* inside the celebrating house at the *mangrara banua* and the *merok* but only over sacrificial pigs.²⁴

4. *Ma'sanduk*, a title belonging to *tongkonan* To' Kamiri', founded by Sa'abu, another of To Batu's sons. Performs at same feasts as No. 3 but fulfils his office inside the *tongkonan* rather than in the yard.

Ba'tan doan

5. *Mantobok*, a title belonging to *tongkonan* Tammun Allo, he stabs to death the sacrificial animal(s) slaughtered during the feasts listed under *ma'sanduk* above; this takes place outside, in the yard of the compound.

7. *Sipalakuan*²⁶ is a title belonging to *tongkonan* Tarra'. This functionary assists the *sokkong bayu* at meetings, rituals and minor rites. When troubles arise, his help is asked. He also assists at offerings.

(Note: the functionaries under 3, 4, 5 and 6 are actually also *petulak* ('helpers'), for they, too, assist the *sokkong bayu* and the *datu baine* in the event of difficulties, during rituals and at meetings. Meetings invariably take place in the compound of the *sokkong bayu's tongkonan*. *Tulak* means to support, i.e. here: to help higher functionaries perform their task.)

All the titleholders cited above are counted among the *to parengge'*. The *matua ulu* below are not. They are *to makaka*. A *matua ulu* prays for rain if no rain falls at the time people want to sow.

Ba'tan doan

9. *Matua ulu*, a function belonging to *tongkonan* To' Kamiri (Note: there are two houses with this name in Ba'tan).

11. *Matua ulu*, a function belonging to *tongkonan* Lelelamba.

Ba'tan diongan

6. *Mantobok*, a title belonging to *tongkonan* Kalimbu'bu; he stabs sacrificial animals to death inside the house during the feasts specified under *ma'sanduk* above.²⁵

8. *Sipalakuan*, a title belonging to *tongkonan* Lempo'; this house, however, stands in *Ba'tan doan*. For his function, see sub 7.

Ba'tan diongan

10. *Matua ulu*, a function belonging to *tongkonan* Pong Babu.

12. *Matua ulu*, a function belonging to *tongkonan* Kaluku founded by Tumbang.

The *matua ulu* of *tongkonan* To' Kamiri functions as the *mangrande londong* at the *merok*-feast and at the *la'pa' kasalle*-feast, and also during the *mangrara banua* (if a *kerbau* is sacrificed). The *mangrande*

londong is the one who holds the cock, which is sacrificed during the consecration of the *kerbau* which is to be put to death. The *matua ulu* of *tongkonan* Pong Bau' is the *mangrere londong*, the one who cuts the neck of the cock sacrificed during the feasts mentioned above. There is still another *matua ulu*; he probably is the same as the *pariasuru*', a functionary who performs at the *ma'nene'* (*ma'tomatua*). He is a member of *tongkonan* Tangke Mamali.

In addition to all these functionaries and titleholders there are also eight *to indo' pa'dang* and three *to minaa*, distributed between *Ba'tan doan* and *diongan*. Here follows a list of the *to indo'*; no further data is available about the *to minaa*.

To indo' padang

Ba'tan doan

1. Member of *tongkonan* Bamba bamba. Functions of this leader are the *mangimbo* at

- a. *tawan pemali*
- b. *ussembong bunu'*

(See Vol. II, the rice ritual.)

3. To' Kaluku is the *tongkonan*, *ma'sanduk* the function, at *umbukai pemali*, the terminating of the food taboos during the rice ritual.

5. Pasang Ma'dika is the *tongkonan*, *Mantobok* the function or title. This *to indo'* officiates during *massabu pantanda*. (See Vol. II.)

7. Banua Sura' is the *tongkonan*, *pabalian* helper, the function, *mangrara*, the rite. (*Mangrara* or *mangrara banua* is an important rite accompanying the founding of a house; see VIII.1.1).

Ba'tan diongan

2. Member of *tongkonan* Kullin. (For function, see under 1.)

4. Kullin Tangnga is the *tongkonan* of this *to indo'*; he, too, functions as *ma'sanduk* but it was not reported during what ritual(s) in particular.

6. Mabu is the *tongkonan*. See further under 5.

8. Banua Sura' is the *tongkonan*. This, however, lies in *Ba'tan doan*. Function identical to 7. This *to indo'* officiates at the *mangkaro palembang* ('the digging of the ditch'), a rite in the rice ritual.

Not all rites can be performed by functionaries in Ba'tan. The *to menani*, a person who functions during the *bua' padang*-ritual, is an office attached to *tongkonan* Buntu Karunanga in Angin-angin.

Several of the *tongkonan* mentioned in this context are each other's *sibali*, i.e. there is a bond of reciprocity between them. If, for example, a buffalo is sacrificed during a ritual observed by the members of *tongkonan* Ne' Pareakan, then the head of the animal is sent to *tongkonan* To' Kamiri. To' Kamiri repays the gesture when it observes an appropriate ritual.

Banua Sura'	↔ many <i>tongkonan</i> in Kesu' such as Sallebayu, Komba, etc.
Ne' Pareakan	↔ To' Kamiri
Kaluku	↔ Dengen
Tarra'	↔ Lempo
Tangdo Ruma-ruma	↔ Tammun Allo

Nonongan

In Nonongan in the village of Kanuruan, for example, a rather different division of offices exists. Here there is a quartet of functionaries who are *to parengnge'*:

1. the *sokkong bayu*;
2. the *to ma'sanduk*;
3. the *to manobok*;
4. the *tulakna lamba'*.

No. 4, 'the supporter of the *lamba'*-tree', the prop of the protector, is also described as a functionary who is ever in readiness to help No. 1 at his tasks. No. 2 is designated as the substitute of No. 1; No. 3 as a 'messenger' or someone to whom all kinds of chores can be delegated.

Also important in Kanuruan are the four *ambe' tondok* (the heads of the *saroan*), the *to indo'* (of which there are twenty-four) and the *to minaa*. They all have a seat on the village council. The elders who are consulted because of their accumulated experience, are designated as the *matua ulu*. In this village, the upper layer of the class of free farmers (usually designated as nobility, and in Nonongan, as already reported, called *gora-gora tongkon*) is of the same importance as the *to parengnge'* who fill offices like that of *sokkong bayu*, etc. If an *ambe' tondok* (*ambe' saroan*) wants to give a feast, he is only obliged

to inform the *gora(-gora) tongkon*, of his intention. All these *ambe' tondok* are *to makaka*.

The appellations of titleholders, functionaries, etc. thus differ from district to district and even from village to village. They officiate during feasts rather than in the routine of every day life. During rituals, the number of these functionaries is increased (see, for example, the description of the *manganta'*, Conversion Rituals in Vol. II). Side by side with the functionaries here mentioned there are officials who occupy a post in the current administrative system (village head, etc.). They, too, form part of the impressive body of local authorities who, together, contribute to the glory of a festive celebration.

In Kesu' villages usually exhibit a twofold division; separate parts are distinguished by the notions 'high' and 'low'. The *datu muane* ('prince') resides in Ba'tan 'high'; the *datu baine* ('princess') in Ba'tan 'low'. At times the male-female opposition is repeated: in Angin-angin, for example, there is a *datu muane* and a *datu baine* in each half of the settlement.

During rituals the *datu muane* sits on the southwest side of the floor beneath the rice barn (the part of the *alang* where those who command respect sit to overlook the feast), the *datu baine* on the southeastern side; the prince sits to the right, the princess to the left (these places can also be occupied by the *anak patalo*, cf. VIII.2). Women of the noble class sit further back. People of less status take places on the ground in the yard; they are protected from the sun by palm branches.

IV.2.4 Summary

The larger *adat*-communities are composites of smaller units, usually *bua'*-circles, which usually are conterminous with villages or organized parts of villages. These smaller units continue to function today if there remain sufficient adherents to the *Aluk to Dolo* to celebrate relevant rituals. A few of the larger communities such as the *lembang* or *patang penanian* of Buntao' are still operational as such because there are enough people who still harbour ancient beliefs so that rites can be organized. This is also true of the *adat*-communities in Pangala', in the *lembang* Sa'dan, and on the slopes of the mountain of Sesean. Sangalla', too, a vast area, was still an *adat*-community in the traditional sense of this designation as recently as 1970. Yet, these *adat*-communities no longer make decisions concerning war and peace

and they have been deprived of certain powers, such as those of passing legal judgement.

Although contemporary political figures — members of the old nobility — sometimes make use of autochthonic structures as they once functioned within *adat*-communities, the modern era has spelled the demise of many major *lembang* such as, for example, Kesu'.

PART II

RELIGIOUS NOTIONS, SYMBOLS, AND FUNCTIONARIES

CHAPTER V

PROMINENT CHARACTERISTICS OF SA'DAN-TORAJA RELIGION

And Pong Lalondong said
"I will enter the Land of the Souls,
in order to cut short the lives of
those whose span of life is near
its end"

(Merok: 73)

V.1 Introduction

The original religion of the Sa'dan-Toraja was named *Aluk to Dolo* (literally: 'Ritual of the Ancients'). Sometimes a somewhat briefer form is used, *Alukta*. The suffix *ta* probably is derived from *tau*, man, people, so that the term may be translated as Ritual (Religion) of Man. The *Aluk to Dolo* was officially recognized as a legitimate form of religious observance related to Hinduism sometime around 1970. Although its classification under the umbrella of Hinduism may strike us as a bit odd, worshippers apparently sought to attach themselves to the denomination among the various world religions sanctioned by the Indonesian government with which they felt the greatest spiritual affinity.

In spite of official recognition the number of those who profess themselves adherents to the *Aluk to Dolo* is rapidly decreasing. According to a statistical report kindly provided by the Makale Office

of the Bank Rakyat Indonesia, traditional believers accounted for 38 % of the total population of Tana Toraja in 1970:

<i>Denomination</i>	<i>Number</i>	<i>Percentage</i>
Protestants	125,952	41
Roman Catholics	34,391	12
Muslims	27,792	9
<i>Aluk to Dolo</i>	118,527	38
Total	306,662	100

A statistical report for which I am indebted to the Department of Religious Affairs of the Kabupaten Tana Toraja, contains the following data concerning religious affiliation in 1975:

<i>Denomination</i>	<i>Number</i>	<i>Percentage</i>
Protestants	152,626	47
Roman Catholics	38,918	12
Muslims	32,760	10
<i>Aluk to Dolo</i>	97,336	30
Total	321,640	99

The subtotals differ slightly from those of other population statistics (cf. Annex Ib of chapter I) but the discrepancies do not affect our conclusion that traditional religion is on the rapid decline. This development is less a matter of mass conversion, than of the dying out of the older generation. As children, the adults of today began to observe one of the great religions at the time they attended primary school. Most of their parents, however, remained adherents of the *Aluk to Dolo*. That the older generation is now growing extinct has detrimental consequences for the orderly celebration of rituals. Once an appreciable percentage of those who formerly fulfilled functions in ritual adopts Christianity, many ceremonies will no longer be able to be performed. In the district of Kesu' this situation already exists.

On the other hand, the dwindling ranks of *Aluk to Dolo* do not imply the total disappearance of traditional religion and ceremonies.

Many registered Christians nevertheless invite a traditional priest to preside over certain ceremonies and rites in order to remain on good-footing with their ancestors. In Christian practice many elements from the older belief system survive. Whenever a member of a Christian family has been away from home for a long time, his return is celebrated by a family feast which, in its organization, is reminiscent of the *merok*-feast. There are many instances of persisting traditional devotion in otherwise Christian communities. This is a topic, however, — together with discussion of religious movements under Christian influence, such as the messianic movement of 1917 — which I cannot enter into here. It is part of the process of cultural change which, since the arrival of the Dutch, has affected Toraja culture. Such change, despite its intrinsic interest, falls beyond the scope of this book which is limited to the description of traditional culture and ritual.

V.2 Principles of classification in Sa'dan-Toraja cosmology

Two pairs of opposition dominate Sa'dan-Toraja cosmology and ritual behaviour: one between upperworld and underworld, and the other between East and West. In both oppositions, mankind functions as middle term. The earth, the scene of man's life and activities, is a middle world, separating the spheres of upper- and underworld. East and West are the cardinal directions according to which man orients his ritual behaviour. He faces East when he presents his offerings to the gods, West when he addresses himself to the dead. Here again man is in the middle, standing between the powers of East and West.

The two basic pairs of opposites are interrelated. The East-West opposition is involved in a further polarity, that between North and South. The North is associated with the East and the upperworld, the South with the West and the underworld. East and West correspond with sunrise and sundown, North and South with zenith and nadir. Consequently, the prescribed directions for arranging a sacrifice and for addressing the powers of upper- and underworld are often modified into northeast and southwest, an obvious combination of vertical (upper and under) and horizontal dimensions (East and West).

These principles are applied in myth and ritual in a manner which, on the face of it, suggests a strong leaning towards systematization which assigns every object, every act, every mortal and every god or spirit a preordained place which defines behaviour. Yet, there is no such thing as a Toraja theology. Systematization occurs, but it is

always *ad hoc*, situation-bound. Such systematizations have not been incorporated into an all-encompassing logical system. What prevails and recurs is the opposition of pairs and not their elaboration into any tripartite division like that of the universe. Even the latter gives way time and again to the duality of the world of man opposed to that of the gods, the upperworld. In discussions with informants, in particular with those who had enjoyed an education which went beyond primary school, it would not have been difficult to elicit rationalizations of a more general and systematic nature. They readily indulge in speculations upon their cosmology. Thus one of the participants in a discussion concerning the upperworld and all that surrounds it turned up the following day to tell me that the upperworld really should be thought of as a vast plain, just as the earth, and that it resembled an animal (buffalo) in its having a head and a tail. This image, which fails to find support in most of the traditional sources, must be set apart as native speculation evoked by an ethnographer's questions.¹ I have tried to avoid becoming embroiled in such speculations as far as possible by confining my sources to authentic texts and to observation or accounts of actual ritual. It does not strike me as a researcher's task to stimulate the modernization or elaboration of traditional religion and worldview.

Among these authentic texts on which I have depended those published by Van der Veen in his book on the *Merok* feast (1965) are of particular importance for information about Toraja notions concerning tripartition of the universe into upper-, middle- and underworld. The upperworld is the world of the gods, the *deata*, often — the more important among them, invariably — addressed as *Puang*, *Pong*, or *Datu*, titles which precede their proper names. *Puang* and *datu* both mean prince or lord; *pong* is possibly a contracted form of *puang*. (It is of some interest to note that *pong* is also the term of address used for a father of several children; cf. *Woordenboek*, v. *pong*.) The upperworld is divided into twelve hemispheres² which should be imagined as concentric, fitted inside each other. *Puang Matua*, one of the most important gods of the Sa'dan pantheon, resides in the zenith (*tangngana langi'*, middle of the heavens, or *ulunna langi'*, head of the heavens); it was he who established the first rituals and created man, together with the ancestors of the most important plants, beasts and inanimate objects, all of which originated in the upperworld and afterwards descended to the middleworld.

The middleworld, the dwelling place of men (*lino*, *padang* or *tana*)

is a later creation of the gods. It was populated by men, 'those who descended from heaven', the *to manurun* who brought with them the more important crops and beasts from above. The earth, which spread out in the midst of the ocean, is sometimes spoken of in a more or less anthropomorphic way: ritual anthems make mention of the 'rump of the earth' or of the earth's 'back' (see, e.g. Merok: 35). The earth is kept in place by Pong Tulakpadang, the 'lord who supports the earth' (*padang*). Assisted by eight minor gods, he carries the earth on his hands and head. His dwelling place is beneath the earth, in the underworld, in the centre of the universe, where an axis which could be drawn from zenith to nadir would pierce the earth.

Like the upperworld, the underworld is divided into twelve concentric hemispheres. Here Tulakpadang resides, not like his counterpart Puang Matua in its outermost reaches, the nadir, but, instead, on top, in the centre, where he keeps the earth in balance with the assistance of eight helpers who support the earth at places further removed from the centre. Together they keep day and night separate, a task at which Puang Matua labours in the zenith of the universe (Merok: 29). Day and night were called into existence by Pong Tulakpadang's wife, the daughter of Heaven and Earth, a dreadful goddess who forged the lightning and sets off earthquakes (Tikala). Here, in the underworld, we also find the *to kengkok*, folk with a tail, but not — and that is what is surprising in Toraja cosmology — the dead, who, by virtue of their close association with the West, we would have expected to meet here. No, the land of the dead is on earth, far away to the southwest, i.e. in the direction associated with the underworld, but not in the underworld itself.

This is surprising because visualization of data concerning a tripartition of the universe like the one presented in Annex Va, suggests a cosmos complete in itself, one which offers room for all aspects of life and death. Explanations, which we have added corroborate the view that the underworld is an equivalent, a counterpart to the upperworld. And yet this is not the case. On the contrary, the underworld as such plays a surprisingly modest part in the religious thinking and practice of the Toraja. For the sake of clarity, I repeat: the underworld *as such* is not particularly significant, but at the same time the underworld *aspect* of everything connected with the dead and with death in general is a regulative idea of great importance in Toraja religion. The point is that the realm of the dead does not lie in the underworld but on the earth in a region ideologically associated

with the underworld. The opposition heaven-earth prevails over the tripartition, an assertion affirmed by the fact that the most important god of the underworld does not reside in its lowest depths like Puang Matua does at the ultimate summit of the upperworld, but rather near its surface, immediately beneath the earth with which he is connected by bearing it on his head and hands. In this context mention should also be made of the fact that Tulakpadang's terrible spouse, Indo' ('Mother') Ongon-ongon³ is in some parts of Tana Toraja not a prominent goddess at all. In Kesu', for example, her name is hardly ever heard, another indication of the minor function of the underworld in religious practice.

Toraja preference for reducing the opposition high-low to that between heaven and earth implies that in ritual practice (in which death and the facts of death are involved) the opposition East-West prevails. East, *matallo* (from *allo*, sun) is associated with North (*daa*) which is *expressis verbis* identified with the zenith: *daa ulunna langi'* ('the north is the head of the sky'). The *aluk rampe matallo*, the sacrificial ritual of the East, is the ritual for the gods. It is enacted on the east or northeast side of the *tongkonan*, and the officiating priest addresses the gods while facing the (north)east. In this expression *aluk* means ritual, *rampe* side; the same words return in the term used to denote the ritual sacrifices for the West (*matampu'*), the *aluk rampe matampu'*. These are made on the west or southwest side of the house with the priest facing in that same direction.

The most important category among the West-oriented rituals is the *aluk to mate*, rituals for the dead (*mate*). The *aluk rampe matallo*, those of the East, rituals for the living, promote the welfare of man, animals and crops. The association of these rituals with upper- and underworld respectively are explicit in the description of sacrifices for the East as 'climbing smoke' (*rambu tuka'*) and sacrifices for the dead as 'laying smoke' (*rambu solo'*). The former, the East-oriented sacrifices, must be brought in the morning, before noon, the latter in the afternoon, towards sunset. In spite of the close association of the dead with the underworld the dead do not dwell in the underworld but in *Puya*, to the southwest of Tana Toraja, further down the Sa'dan River, somewhere between Kalosi and Enrekang. According to A. C. Kruyt, Puya lies south of Duri on the far bank of the Balua River (Kruyt 1923/24: 170). It is also from the southwest that the ancestors came, or rather, it was in the southwest that they first set foot on land when they crossed from the mythical island of Pongko' (Round

Earthmound) with eight proas (the already described *lembang*) to the mainland. In addition to Pongko', Kalebu' ('Small Hill') is named as the island of origin in poetic language; most probably it must be the same as Pongko'. Neither island can be further identified. Although it might seem attractive to hypothesize some sort of historical connection between the location of Puya and the early migrations of the Toraja people, the mythical journey of the ancestors from the southwest to the northeast can just as well — and perhaps even better — be explained as a symbol of the idea that man's ultimate destination is the northeast, that is, the upperworld. This, in fact, is the destination of the deceased, but before he can reach it all elaborate mortuary rituals must have been celebrated for his soul, a privilege accorded to rather few. Even for those who reach their goal, it is a long journey.

First of all, the soul has to go to Puya which must be reached through a sort of hole or tunnel in the earth (cf. the *liang*, rock grave). On its way it is submitted to various trials which are described differently from place to place. The judge of the dead is Pong Lalondong, the king of Puya. A cat is his helper, though he is also associated with a cock. The various stories of dangers threatening the dead are of no appreciable consequence for religious practice. The fortunes of the dead depend upon the rituals performed on earth by their relatives. The unclean soul, the *bombo*, must be purified and enabled to mount up Bamba Puang, a mountain west of Puya and north of Enrekang. Reaching Bamba Puang is a turning point in the soul's career. From here, thanks to the celebration of the highest death ritual, the soul can reach the firmament and enter the upperworld to live on as a *deata*, a god or, in this case, a deified ancestor.⁴ By now he has left the sphere of the West behind and entered into that of the East from where he looks down upon and watches over his descendants; they may call upon him for help in all the affairs of the living, in particular, to assure the prosperity of their rice.

Consequently, the final rituals for the dead are rituals of reversion. The sacrifices, first brought to the West, are now brought to the East, to the powers of life. These shall be discussed in Vol. II. All the same, quite a number of dead never achieve this destiny. Such fortune is largely confined to the rich and their relatives. Those of the highest nobility, the *puang*, sometimes are thought to depart to the upperworld straightaway. However, this notion again has no influence on ritual behaviour. For a deceased *puang* mortuary rites are celebrated anyway; they belong to the most elaborate observances imaginable.

The fate of those in whose honour only the smaller mortuary rites are celebrated, is not quite clear. Some may remain dangerous *bombo*, others stay in Puya without disquieting their relatives. It is uncertain whether they may be classed as *matua*, the spirits of the southwest who are closely associated with the dead. Usually the *to matua* are classed as the ancestors of the southwest, ancestors who also established the sacred *adat*-institutions and who, on different occasions, are honoured with sacrifices. Because these *matua* or *to matua* are also called ancestors of the middle period, it is tempting to assume that, in the long run, the dead who can not ascend to heaven, become part of that rather non-descript body of *to matua*. Such an assumption, however, would be an act of theologizing with insufficient support in Toraja statements on this point. All one can say is that the southwest, the realm of the dead, is not simply a bad region, just as the underworld where Pong Tulakpadang carries the earth and watches over the separation of day and night is not exclusively bad, or threatening either. Tulakpadang even has a reputation for beneficence and, in spite of his sojourn in the underworld, is classed with the gods of the East who must be approached with *aluk rampe matallo*, rituals of the East.

Apparently, the duality which characterizes the universe as a whole, tends to imprint itself as well in each of its parts. An interesting case as far as the associations of West and South are concerned, is that of Van der Veen's classification of the cardinal directions in one of his earlier works (1929a: 397):

North

kalimbuang boba, the sources of the blessing water. Refers to the sources of the Sa'dan River, here associated with the *deata*

West

bulaan masak, the patch of pure gold. Refers to the fact that in the western part of Tana Toraja gold is found. In myth Puang Matua went there to fetch gold (Van der Veen 1965: 87)

East

aluk sola pemali, institutions and prohibitions

South

sukaran aluk, institutions, and *pa-nanda bisara*, determining of rules of *adat*-law

The association of the West with gold and riches, of the South with the institutions of *adat-law* and the *to matua* who introduced them is illustrative of the dual appreciation of the various parts of the universe. We will meet other cases in the course of our description which will also confront us with a few (very few, admittedly) instances in which the direction adopted by a priest during his prayer or address puzzles us as apparently deviant. The rules of classification are clear enough in themselves, but their application depends on *ad hoc* situations which can only be elucidated by detailed observation and a full knowledge of adventitious circumstances. Among relevant details, colours occupy an important place. Sacrificial animals must be of the colour defined by the nature of the relevant ritual. Thus the hen sacrificed to the *to matua* of the West must be black, to the *deata* in the East yellowish.

Finally, one concluding remark. The rules of classification are not limited to the celebration of rituals. They are also relevant in seemingly secular affairs such as house-building or the administration of a law-case. A house must face North, a *to minaa* in a law-suit, East. In his sleep anyone should avoid to have his head turned southward.

V.3 The gods

Just as no Toraja theology exists, there is no standard Toraja pantheon either. There are numerous local differences, but these do not detract from the prevailing pattern. Indeed, a general impression of that pattern suitable to the aims of this introductory chapter can better be achieved on the basis of a description of one of its variants, than by attempting a lengthy comparison of all. For this reason, I shall confine myself mainly to Kesu', the district with which I am best acquainted.

Efforts at systematizing the pantheon are not lacking in Kesu'. The gods are divided into two categories, those of East (and North), and those of West (and South). Informants add that there are eight gods in each category. This sounds quite promising because the family tree of the gods of the Kesu' pantheon, enumerated in Annex Vb, includes 16 gods (provided we ignore the original founding couple of Heaven (Langi') and Earth (Padang), the parents of three of the four gods of the first generation). Yet, there are only two out of sixteen who can with some certainty be associated with the West: Tulangdenna and Pong Lalondong. All the others are more readily associated with the East because, in principle, the gods (*deata*) belong to the East. Even

the god of the underworld, the great Tulakpadang, belongs to the East. It was impossible to achieve clarity on this point. The division of the gods into two times eight is more a matter of deference to the principle that there must be eight of everything important than it is the result of thoughtful systematization. Also here, the symbolic value of a number outweighs the importance of substantive content.

It is evident that the contrast between East and West, between upper- and underworld does not lead to a clear classification of the gods. Neither does another principle for classification: land or sky versus sea or water, in combination with male versus female. Like the first pair of oppositions, that between East and West etc., it, too, is frequent in Indonesian mythology, and traces of it are not lacking in Toraja religion either. In the course of the *dirapa'i*, the highest mortuary ritual, a deceased male of high rank is honoured with a title which has to do with the sun or the sky; *Ta'dung Allo*, ('Sun screen from the Sun'); *Rante Allo* ('Sunfield'), *Batara Langi* ('Skygod'), *Lalong Kila* ('Mighty as the Lightning'), are some of these male titles. Corresponding female titles are *Liku Tasik* ('Depth of the Sea'), *Tiku Tasik* ('Bounding the Sea Entire'; 'The Sea Encircling'). (See The Chant: 5.) Impressive, resonant names which reflect the contrast between sky or sun and the sea. Yet, the sea god himself is addressed as *Datu Muane*, male lord, and conceived of as male.

In a comparable vein, crocodiles are thought of as female. They are associated with river spirits, and as such have much in common with eels. Both are honoured with the title *pa'puangan* ('they who are honoured as a lord'). Yet, To Sopai, the frightful river-god of the Sa'dan who is visualized as a gigantic eel, is masculine. He is the god of the mountain Sopai who, during heavy rains, immerses himself in the Sa'dan River where, in the shape of a monstrous eel, he swims in search of victims. As soon as To Sopai has seized (human) prey, the rains stop and the *banjir* (Ind.: flood) comes to a halt. Some informants even told accounts of a married couple of eels, a concept which brings to mind the two cosmic serpents in the religions of the Hindu-Balinese, the Nias islanders, and the Olo Ngaju of Borneo (cf. Stöhr 1965: 274, 317). A second guise of To Sopai is that of a great *bungkang tasik*, a sea crab, in this form he is also associated with the sea. More important is that To Sopai, whose name does not figure in the list of gods of Annex Vb, is probably identical with one who is mentioned there Pong Tulangdenna, the son of Pong Banggairante and Tallo' Mangka Kalena. He, too, has his abode on the Sopai

mountain. He takes life from those who pass over his river without presenting him with a gift and he also stays in the irrigation canals of the rice fields. Of specific interest is the name Tulangdena ('he who stands upright, erect, in a definite place'). In combination with To Sopai's eel-shape this suggests a phallic deity.

In contrast to this one example of the association of river and water with the male sex, there are many more which express a relation with the female sex. We have already cited the honorific titles given to deceased women during the *dirapa'i*-ritual, and the female sex of the crocodile. Another case is that of Sandabilik, the wife of Tamborolangi', one of the leading *to manurun* of mythical history. She came from the depths of the Sa'dan River. Marrin diLiku, moreover, the wife of Manurun diLangi', the divine ancestor of Tikala, originated from a pool (*liku*). Yet, this too is not a hard and fast rule. In fact, most of the wives of the denizens of heaven do not come from river or sea, but from the rocks, one of the best known illustrations being that of the spouse of Puang Matua. Here, however, there is no question of deviation from the pattern which tends to associate the female sex with depth, and the male with what is on high.

Enough has been said by now to give substance to the view that the existence of a number of general patterns does not suffice to draw an adequate picture of the Sa'dan-Toraja pantheon. We must study each of the gods in his individual role and history, to accomplish which we must turn to the chapter on myth (chapter VI). In this context we shall confine ourselves to a sketch of some of the most prominent among them.

Pong Lalondong. Of all the children born to Pong Banggairante, the Earth God, and Tallo' Mangka Kalena ('the Egg which spawned its own Beginning'), the most feared is Pong Lalondong, the Judge of the Kingdom of the Dead. *Londong* indicates that he is a cock.⁵ Another son of the Earth God and the Egg, the Ocean-god Tandiminanga, at times also sits in judgement over mankind, but not, as his brother does, over the dead, but over the living. He overturns the proa (*lembang*) of those who have transgressed against the *adat*. (Tandiminanga is sometimes identified with his brother Puang Radeng, 'the Lord who leans sitting against Something'; see Merok: 70-71.)

Pong Tulakpadang and Puang Matua. Pong Tulakpadang, the other god of the underworld, is not portrayed as inspiring terror. To the

contrary, during the consecration of the buffalo which takes place during the *merok*-feast, he is described as a god full of mercy,⁶ the 'support of prosperity', someone who carries the well-being of man in the palms of his hands, their protector (Merok: 42f.). It is remarkable that earlier in the same song, Pong Tulakpadang is credited with the creation of sun, moon and stars. He dwelled first in the upper-world and together with Puang Matua (who is also mentioned as creator of the heavenly bodies) he arranged the first ricefields, ordained the relevant sites for sacrifice, and originated the mist, the thunder, and the rainbow, which connects heaven and earth. Later did he move to the underworld. His habitation should be imagined directly beneath the earth, aligned with his upperworld counterpart Puang Matua who sits enthroned in the zenith. It is as if Pong Tulakpadang has made room for Puang Matua. The pair maintain day and night in equilibrium. Two-in-one they remain at their stations along the world axis, a complementary pair. Together they constitute a natural day, Pong Tulakpadang symbolizing the hours of darkness and Puang Matua those of light.⁷ The Sa'dan divide the day into rather fine periods (see *Woordenboek* under *allo*). These divisions are significant for making sacrifices. Offerings to the gods, placed towards the East (in most instances east or northeast of the *tongkonan* of the celebrants) are to be accomplished before noon.

Puang Matua ('the Old Lord'), less frequently called by the name To Kaubanan, is an especially prominent deity for the Sa'dan-Toraja. *Arrang diBatu* ('The Radiance in the Stone'), his wife, comes originally from a rocky cliff which Puang Matua had to enter to possess her. The marriage feast of Puang Matua together with that of Gaantikembong, became prototypes for such celebrations on earth.

Puang Matua created man and saw to it that there was order on earth. He made man mortal.⁸ Afterwards his interest in the affairs of mortal man slackened, the consequence of man's misbehaviour, the violation of his commandments by the committing of incest and thievery (see chapter VI.3: Myths concerning the consequences of incest). In anger Puang Matua severed the bonds between heaven and earth. Nevertheless, he remains the greatest among the gods, and among the Sa'dan who remain committed to their old religion his position, apparently under the influence of imported Christianity, has become more important than ever. Yet, the archaic language of the Sa'dan religious litanies which never tire of ascribing leading roles to

Puang Matua, confirms the antiquity of his position so that we may assume that his stature has been immense for generations:

He resides in the heart of the firmament;
 he is the god of the dazzling sun;
 he is the god whom the honoured ancestors (the *nene'* and the *to dolo*) solicit to partake when the sacrifice stands ready;
 he has laid out the irrigated ricefields, indicated where the offering places for the rice should be;
 he created the three-eared rice and he created mankind, the forefather of the water buffalo, etc.;

he formed the sun; he cut out the moon as a circle, he made the clouds, and caused the roar of thunder;
 he is associated with the zenith.

(statements borrowed from Merok: 27-33, verses 40-88)

Elsewhere in the *Passomba Tedong*, the litany from which these statements have been borrowed, Puang Matua is described as unapproachable, inaccessible. He lives behind his 'curtain'; he is swathed in sacred *maa'*-cloth (with the pattern *doti langi'*).⁹ He is a merciful god, a god with much compassion (Merok: 33). Sometimes people speak of two Puang Matua, an old and a young one; I can offer no explanation for the duality which, moreover, does not play any important role. Puang Matua is thus *not* to be seen as a *deus otiosis*. His participation in the affairs of mankind is most obvious in the arrangement of the *surasan tallang*, the shrine where people place offerings for the *deata*. The shrine has two platforms or 'floors'. On the uppermost the gifts for Puang Matua are placed, on the lower one those for all the remaining deities. Puang Matua is conceived of as aged: To Kaubanan, 'He who has grey hair'. He is associated with the sun, and makes his home in the zenith. The ridge of his *tongkonan* runs east-west in contrast to the ridges of houses belonging to eminent people on earth which run north-south. In spite of all this there is something odd with Puang Matua. According to generation he is (with his wife) the youngest of all the members of the pantheon. Apart from his curious relation with Tulakpadang, the supporter of the earth, Puang Matua's name is ambiguous. We translated it by 'The Old Lord' but a translation by 'Lord of the to Matua' (the ancestors of the southwest) is equally justified. Moreover, it suits his position as a god who has specific relations with mankind. Is this because the youngest among the gods is nearer to the ancestors of mankind than

any older member of the pantheon? We simply do not know, except that his significance for mankind is beyond doubt. When I asked people of note in Nonongan whom they looked upon as the leading gods, they answered, "Puang Matua and Pong Lalondong". Apparently this opposition is of more direct importance than that between Puang Matua and Pong Tulakpadang. In Kesu' Puang Matua's significance was such that he overshadowed all other divinities; people were emphatic about the henotheistic character of their religion. Christianity and Islam, they argued, don't they, too, involve several gods and spirits?

Female gods. Gods are marginally more important than goddesses. There are numerous father figures. Puang Matua can be considered the first of these. Although crops and useful plants are brought into association with mother earth, no image exists of an affectionate goddess figure. Mother Earth is hardly ever spoken of and even in the genealogy of the gods (Annex Vb) she is not advanced as a real personality. It would not be proper, however, to represent the goddesses in the Sa'dan pantheon as trivial personages. Indo' Ongongon has already been introduced as an important deity in some regions. Of even greater importance is the rice-goddess (Indo' Pare'pare'). Besides there are goddesses who instituted important rituals. Lokkon Loërara' commissioned Usuk Sangbamban to conduct the cleansing ritual, the first in Sa'dan history. Arrang diBatu, moreover, had a hand in the creation (see VI.1.1). Indo' Belo Tumbang is another goddess deserving mention: she, unlike other female deities, did not originate from a rock. Apparently, she belonged to the upperworld from the beginning. She is the 'Mother beautifully dancing' (or leaping) referred to in the *Passomba Tedong* (Merok: 144f.). She was the first female physician in the upperworld, summoned there by Puang Matua to attend to the sick Banno Bulaan ('The Golden Rice-water'), a goddess about whom we know nothing further.¹⁰ The patient was cured. Indo' Belo Tumbang, whose other name is Indo' Bunga Sampa' ('Benevolent Mother Blossom'), is regarded as the protective spirit of the medicine used to heal the sick during the Maro Feast (see Vol. II). An alternative translation of Indo' Belo Tumbang is: 'Mother Ornament of People in a State of Trance' (Merok: 142, verse 728). *Tumbang* alludes to the women (also called *tumbang*) who enter into a trance during the *maro*-ritual. A connection exists, thus, between this goddess or protective spirit, the healing of the ill and trance phenomena.

Nevertheless, the Sa'dan goddesses rarely appear as care-givers. There are no nurturing mother-figures among them, this in contrast to nearby Mamasa where To Tiboyon, the goddess or goddesses of the rice promote(s) growth of the crop.¹¹

If now we revert to the Sa'dan division of the cosmos into three, then Puang Matua is the god of the upperworld; Gauntikembong ('The Cloud which Swells Out of Itself', mentioned in Annex Vb) is the god of the Air; Pong Banggairante (or P. Banggai diRante) is the god of the Earth and Pong Tulakpadang is the god of the under-world, the latter with Indo' Ongon-ongon in his company.

Remaining deities will be introduced when I examine Sa'dan myths about the creation of the world (see VI.1).

V.4 Souls, ancestors, and spirits

The gods are powerful and important, but they are far off. Closer by and more familiar are the souls of the (more recently) dead, the ancestors of the West (*to matua*) and of the East (*deata*), and the spirits associated with specific locations. In section 2 of this chapter we discussed the place of the dead and of the ancestors in the prevailing system of classification. Here we must enter into some further details concerning their fortunes and power.

V.4.1 Souls (*bombo*)¹²

In Kesu' people hold the view that the soul, once the first mortuary rites have been celebrated, proceeds straightway to Puya to meet his judge, Pong Lalondong. In other regions of Tana Toraja it is not as simple as all this. The soul first must cross the dangerously swaying bridge over the Salu Bombo, the River of the Dead, and even before he arrives there his trials commence. A cat, *Bali karae*, crouches there trying to waylay the souls. The cat (or cats; sometimes there are more of them) snatches from thieves all that they have stolen to return it to the rightful owner when he, in his turn, must cross the bridge. She hinders the souls of criminals from advancing any farther;¹³ they must remain in a hollow the bottom of which is lined with the waste of buffaloes. If all goes well they have to cross the bridge, a golden one for souls descending from a *puang*-ramage, one of rattan for *to makaka* souls, and one made out of sugarpalm-leaves for souls of slaves. This does not make much difference, however, because none of the bridges sways less wildly than any of the others. We are not told what happens to those who fall into the river.

Apparently they share the fate of other souls who never reach Puya.

These are the souls for whom no mortuary rites have been celebrated, or have been celebrated in an aberrant fashion. To the former belong the souls of stillborn children (*silakku'*) who are buried in a pot (or in a small bag of plaited *tuyu*-leaves), or of children who died before cutting teeth, who are laid to rest in a tree. *Silakku'* are able to eat rice growing in the fields. Among the dead done away with in an aberrant fashion are the souls of lepers (*to golenan*), of suicides (*to mentuyo*), and of those fallen in battle (*to ditatak*). Together with the souls of those who have no scars on their arms from fire, they tarry on the plain which stretches before the entrance to Puya. All these souls are dangerous to the living (A. C. Kruyt 1923/24: 173f.).¹⁴ They roam about at night.

In fact, the soul of every dead person for whom no adequate ritual has yet been carried out — a ritual in which all the members of the family have participated — stands in bad odour. He wanders about on earth, frightening the living. *Bombo* are visible only to media and cats. They travel when darkness descends and see the *bombo* of men and women who are on the point of death.

Only the *burake bombo*, the priest who dresses the corpse, can dedicate offerings to them. Like the corpse the *burake bombo*, mostly a *kaunan* (slave), is considered unclean. People are afraid of the *bombo*. I can remember how my Christian Toraja guides quickened their pace when evening began to fall and we had to make our way down from a mountainside village. Half-joking they voices their fright for the *bombo*, a fright which seemed more intense than any concern over a non-illusory slip and fall on the steep mountain trail.

The souls which are admitted to Puya first have to meet Pong Ladondong. The cat, Bali karae, acts as his helper (*bali*, also *pabalian* means helper) though she is sometimes identified with the god. In Ma'kale people talk of a female 'Judge of the Kingdom of the Dead', Indo' Barikalu. Details on the procedure of jurisdiction are lacking. The souls of wrongdoers are consigned to fire, but the location of that fire is as thoroughly unknown as the duration of the ordeal. The word for hell (*ranaka*) which the Toraja borrowed from the Buginese, evidently is a transposition of Sanskrit *naraka*. They speak about it (though only occasionally) but the notion of a last judgement is not really functional in Toraja religion. All depends on the performance of the mortuary rites by the deceased's relatives. And even this is not wholly true. The *puang*, and certainly the rulers among them, go

directly to the upperworld, a privilege also allotted to the *to burake tambilang*, the highest among the priests. By their direct descent from the *to manurun*, the first humans who descended from heaven, these nobles are, as it were, nearer to heaven than other mortals, even though, theoretically, the latter, too, spring from *to manurun*. According to myth, even slaves descend from a heavenly progenitor.

Despite their direct ascent to heaven, the souls of these privileged nobles need a grand-scale ritual anyhow. It differs in details from other comparable rituals, but it cannot be (and certainly is not) omitted, nor executed on a more modest scale than the rituals for a soul who first has to pay his respects to the ruler of Puya. Rituals are of the greatest importance. The highest mortuary rite, the *dirapa'i*, the one which permits the soul to ascend to heaven, can only be celebrated for those who, during their lifetime, performed a *bu'a' kasalle*-feast, the highest ritual of the East (just as the *dirapa'i* is the highest ritual of the West). Once every prescribed rite has been completed, the soul rises on high, departing from Bamba Puang in the west of Puya, where "it rose on high like a coconut palm and reached the firmament" (The Chant: 5). The soul then takes his (or her) place in either Ursa Major or the Pleiades, star clusters of importance in rice cultivation. Rice is considered as more or less under their protection (The Chant: 5). The Pleiades, whose emergence indicates it is time for commencement of rice cultivation, are known as *Bunga' lalan* ('the one who prepares the way', 'the opener'), just as the ritual leader who carries out the rites of rice cultivation (Vol. II). From their place on high the deified ancestors continue to care for their descendants who will call on them for a prosperous harvest of rice, their main crop.

Only few reach this lofty status, and these few are primarily members of the noble class. No ordinary people could afford to arrange the elaborate rituals and costly sacrifices required to that end. Toraja society is class-conscious and this class-consciousness does not halt at the porches of death. The remark of a *to makaka* from the lower classes which Van der Veen reports (The Chant: 6) provides explicit information about class structure in the afterworld and about the privileged position of individuals of prominent family after death: "That this (the ascension of the soul of a man of status who has perished) is not accepted as applying to people belonging to the lower class of the *to makaka* . . . was brought home to me once after I had spoken at an Evangelical gathering in one of the villages about the

life hereafter as outlined in the Gospels. In the discussion at the end of the talk, one of the guests, an old man who was in the lower rank of the *to makaka* class, said to me: 'That life in heaven about which you spoke, is not for such as us who are not of high rank. Our spirits do not ascend to heaven when we die; but only those of people of high rank who have held the great *bua*'-feast during their life and for whom the ritual of the *dirapa'i* has been carried out.'

Does this imply that ordinary people awaits a miserable lot in the hereafter? It is difficult to say. Such a thing as eternal bliss hardly plays a role in Toraja thought. They are more interested in what after death the souls are going to do to the living than in questions of what their private fate will be. The dead who do not ascend to heaven will stay in Puya or thereabouts, somewhere in the west and south-west. The Toraja have no clear ideas about what life there is like. All that can be said with some certainty is that the dead for whom the ordinary (the smaller) mortuary rites have been performed remain there and that they need not and probably will not roam about in the land of the living. This does not mean that they are of no consequence. They stay with the *to matua* and share in the powers for good and for evil which all ancestors have. They are not forgotten; the living call on them. Even the recently deceased are capable of bringing drought, a notion voiced during the singing of the *badong* (death song): "Father ('mother' if the deceased is a woman) will see to it that it does not rain". On various ritual occasions they will be commemorated, until they gradually fade into anonymity.

V.4.2 Ancestors

The general term for ancestors is *to dolo* ('those of the past'). They often are referred to as *nene*' ('grandparents'). They are of different kinds. There is in the first place the difference between *deata*, deified ancestors associated with the East, and *to matua*, the ancestors of the West, a difference already discussed in section 2 of this chapter. In the second place, there is a ranking according to seniority in which the highest grade is that of the *to manurun*, those who descend from heaven.¹⁵ They are the great ancestors who play leading roles in mythology, a feature which Sa'dan mythology has in common with that of the Buginese and Makassarese, and of even other Indonesian peoples (e.g. the Nias Islanders; cf. Møller 1934: 139-160). With the sole exception of Baruppu', these *to manurun* ancestors are reported in all Sa'dan districts.¹⁶ These 'ancestors from the time beyond memory'

were followed by those from the middle period (*nene' tangnga*) and from the latter period (*nene' undi*) "who succeed each other as the steps of a stairway, as the rungs of a ladder" as a text, quoted by Van der Veen, has it (Merok: 166-167).

Usually, attention concentrated on the ancestors of the oldest generation. Consider the following text taken from the Merok (p. 26, verse 38):

"Apa umbai limbongmo nene' bunga' mellao langi'
inde barira banuanna to ma'rapu tallang
umbai tasikmo to dolo kapuanganna
to manganna sangka' inde rampe matampu'".

"But perhaps the ancestors, as the first men who descended from heaven,
have assembled here, near the bamboo fence round the space under the house of those who are numerous as bamboo culms,
it may be that the forefathers, revered as Lords,
are gathered in a multitude at the west side".

Who, however, are the ancestors of the middle period? It seems plausible to identify them with the ancestors who came from mankind's first earthly abode, the island of Pongko', to set foot on the Sulawesi mainland southwest of Tana Toraja. They then would be those about whom a text says:

"You, who sit gathered on the edge, on the western rim,
You, who below draw near to one another at the setting of
the sun, . . ."

(Van der Veen 1929: 405).

The text evidently refers to the *to matua* who are settled in the West. These ancestors are addressed as *nene'*, a term more or less synonymous with *matua*. To conclude from all this that the ancestors of the middle period are the same as the *to matua* requires merely one step, but a frightfully long one. It includes an effort at systematization which goes far beyond Toraja methods of systematizing which are always *ad hoc* and not at all general. The division of ancestors into ancestors of three periods can, with equal right, be interpreted as just another specimen of Sa'dan predilection for baroque expression. We have to content ourselves with the fact that, to them, there are ancestors everywhere, older and younger ones, ancestors deified in the East, ancestors non-deified in the West; these ancestors, whatever their location or specific role, invariably are powerful, almost as powerful as the gods, and mankind has to win their grace and cooperation.

whatever their rank or denomination in the classification of the universe.

V.4.3 *Spirits (localized)*

Mountains are among the special haunts of spirits. The Sopai mountain, it was earlier remarked, is where a god of the same name makes his residence. Sesean and Sado'ko are two other peaks sheltering deities. Puang riKesu', an ancestor descended from heaven, inhabits Kesu' Mountain. The eel god of the Sopai, however, is regarded as more dangerous than any of these. Myths tell of certain habitations of the gods on earth: Pong Tulangdenna dwells in the irrigation ditches of the wet rice fields, Tandiminanga, 'Supporter of the River-mouth', is found where the Sa'dan River empties into the sea (Merok: 71, verses 344, 345). Eel spirits splash about not only in the Sopai and Sa'dan Rivers, but in certain springs as well: in Talondo tallu (near Leppang, Ma'kale territory), in Ke'pe' (Mengkendek), in Bea (Sangalla'), and in Bombo uai (near Barana'). Men feed eels in these waterways; the eels themselves may not be consumed. Eels in springs near particular villages, Mengke'pe' (Kesu'), Mata uai (Tadongkon), Bu'tu uai (Ba'tan) receive sacrifices, for they can provide riches, an abundant harvest and the blessing of many children (A. C. Kruyt 1923/24: 316-320). Spirits also live in specific stone formations, as in the two giant slabs of rock known as the 'Drums' which stand beside the road which leads from Rantepao to Marante. Whoever places a gift at the base of the 'Drums' and makes a wish, can find his wish fulfilled. One Toraja woman confided to me that she once saw two yellow shapes (spirits) seated on these stones; the shapes were silent; she herself recoiled in fear and hurried away.

There are furthermore spirits who live in the ground; *ampu padang* (possessors of the earth) they are called. Whoever is about to dig a hole, should first make an offering to these spirits. *Ampu padang* have yellow hair and teeth like nails.

V.4.4 *Dangerous spirits and dangerous people*

Evil spirits are *Indo' Orron*, *To Paragusi* and *Datu Maruru'*. *Indo' Orron*, alias *Limbong Allo* (*limbong* = pool, pond; *allo* = day), bellows as a buffalo, assumes the form of a pig or a cat, and tears the eyes of her victims out. *To Paragusi* is a white spirit, tall and comely (according to J. Tammu the name is perhaps a bastardization from Portuguese). *To Paragusi* is a werewolf who gnaws the livers

of men and beasts. He is honoured during the *ma'bugi'*-feast. Datu Maruru', also known as Puang Maruru' ('the Righteous Lord') or To Mangambo' ('the Sower'), is the god of smallpox.

To Paragusi and Datu Maruru' do not fall, as one might suppose, within the sphere of the West, but of the East instead. The evils brought by them are cured by means of respectively the *bugi'*-feast and the *maro*-ritual, purification rituals which are associated with the East.

Dangerous people are the *batitong*, the werewolves. During the day they are ordinary people, not at all exceptional in their appearance. Towards dusk, however, and in the deep of night they become *batitong*, werewolves. This western term is not quite appropriate for *batitong*. They never assume the form of a beast but remain humans, at least to the onlooker's eye. Men and women both can be *batitong*. It is common knowledge also that certain individuals in the village, in the surrounding area, at night or already when the sun is setting can turn into werewolves who feed upon the livers of people asleep. *Batitong* prowl about to see if they can find livers hanging through the floor of a house, suspended in the space beneath the house. Should the sleeper's time to die not yet have come, the *batitong* cannot fulfil his fell intent. Once the *batitong* feeds upon a liver, however, the owner's life ends. The *po'pok* is another sort of werewolf, one who flies. Among the werewolves, one who is no longer an extant person but one who has been incorporated in myth, is *Paragusi*, the dangerous spirit mentioned above.

The *batitong* comprise an army, as it were, which draws itself up into formation in a particular region at night, ranks facing in all directions of the compass so that nothing which displeases them can penetrate their midst. The town of Rantepao also has its legion of *batitong*. They have a leader, too. One of my informants, a woman, had caught sight of two werewolves within the last year:

The first time, towards sundown, a woman approached from behind her while she was fishing in the *sawahs*, going from one ricefield to another. The woman asked her for a share of the fish she had caught, but she did not comply with the request. Later she thought the woman could well have been a werewolf and one may never deny a *batitong* what she asks. Under a full moon she went on with her fishing in the company of three other people. All at once a shade drew near the fishing party which fled away in terror. It was the *batitong*

who had not been given any fish, a woman from the village whom they knew.

The second time the informant who told me of her experiences with werewolves either dreamed or thought she noticed water in the well rising swiftly. When she rose and went to look, the water had already begun to pour over the edge. It was as if a flood threatened. Suddenly a neighbour woman arrived, but she appeared somehow different from her usual her. Three gleaming spots shone from her face, one on her forehead between her eyebrows and one each at the far corners of her eyes.

V.5 The concepts of spirit and soul; conclusion

These concepts among the Toraja, just as in our own culture, are difficult to describe. In his *Woordenboek* Van der Veen presents a wide array of definitions. He points out that 'spirit' in Sa'dan-Toraja is expressed by *penaa*. The original meaning of *penaa*, like the Hebrew word *ruah* (Arabic-Indonesian: *roh*) and the Greek *pneuma*, is 'breath'. The root of the words *penaa*, *menea*, 'to breath', is *naa*, a word related to the Indonesian *nyawa*: soul, life. *Inaa*: 'mind, meaning, thought'; *minaa* in *to minaa*, literally: 'someone who ponders, who has *esprit*'. *Penaa* also has the meaning of 'heart, frame of mind', for example in: *melo penaanna*: 'he is a kind soul'. The inner life of man is often described poetically in terms of various parts of the body. 'To take to heart' in Toraja is '*umpatama ara*': 'to place in the breast', or '*umpatama tambuk*': 'to put in the stomach'. The Dutch expression 'he has no brains' is in Toraja: *tae' pa'dunna*: 'he has no spleen'. A treacherous person is called: *to pa'du riri*: 'someone whose bile is yellow' (information H. van der Veen). *Sumanga'* means 'consciousness' or 'soul', for example, in *kurre sumanga'* a plural form is contained. Considering that this form also appears in ancient litanies such as the *Passomba Tedong* (in which *kurre sumanga'* is also used in the plural form when the ancestors are addressed) it appears probable that an old form is involved here.

Bombo is used primarily for the uninitiated dead, although one also speaks of *bombo mendeata*: 'soul that after death becomes a divinity, deified soul'. We already took note, however, that *bombo* can also signify the dreaming soul, but it is remarkable that Wilcox in his comment on *bombo* as the dreaming soul makes special reference to the dreamer's visit to the land of souls (Wilcox 1949: 110).

The denotation 'soul of someone in life' is fairly closely approximated by the word *deata*. Of someone who is startled is said, *mallai*

deatanna 'his soul flies off' (*mallai* = run away, flee). The word *deata* is also used for the dead who have ascended to heaven, for whom a complete mortuary ritual has been observed, or for deified ancestors.

Finally, Sa'dan-Toraja uses the term *sunga'* (= in Tikala *suma'*, in Riu *suna'*) which means 'thread of life, the predetermined span of life'. It is said *dikatu' sunga'na*, 'the span of his life has been broken', *nalambi'mo sunga'na*, 'the end of his life has arrived' (information H. van der Veen).

Our survey leads to an intriguing conclusion which throws new light on the Sa'dan-Toraja worldview. There are three terms for soul, *sumanga'*, *bombo* and *deata*, all more or less synonymous. Their use depends on the context in which they are applied. The point of interest is that these three words rather closely reflect the tripartition of the universe, the term *deata* associating the soul with the life-giving upperworld, and *bombo* with the dreamland of death and the dead. Again a dual opposition prevails over the tripartition; to claim an association of *sumanga'* with the middleworld would be to stretch the facts. And yet it is not without significance that there is a third term which is unaffected by the opposition constituted by the others. *Deata* and *bombo* find their unity in the human individual who combines in his personal self the two opposing aspects of all there is. The Toraja system of classification may not be systematized, at least not in any manner which complies with western norms, but in critical regards its consistency is unsurpassed: it places man in a universe which is every bit as much a synthesis of contrasts and contradictions as he himself is.

ANNEX Va

SCHEMATIC REPRESENTATION OF SA'DAN-TORAJA COSMOLOGY

- a. Puang Matua, "the god whom we see ascending, lord whom we behold rising upwards" (Merok: 27, verse 47).
- b. Pong Tulakpadang, "the god who supports the earth".
- c. The eight gods who help prop up the earth (not all eight are sketched in in the figure).

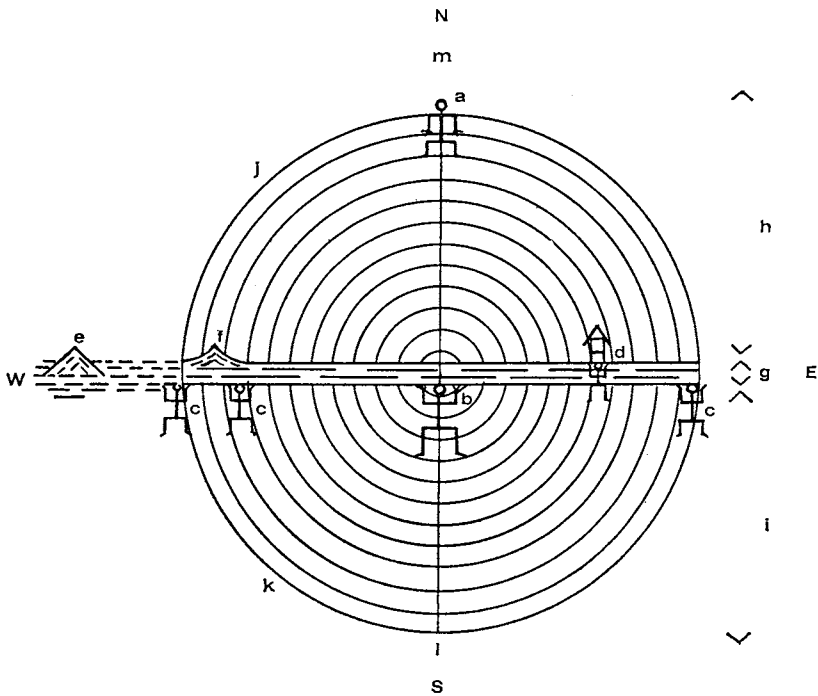

- d. Drawing of a house, a *tongkonan* and of the earth spirit who supports the habitation.
- e. The island Pongko' which lies west of the earth and is separated from the earth by sea (*tasik*).
- f. The mountain Bamba Puang.
- g. The earth, The Middle World (*lino* or *padang*).
- h. The upperworld, *langi'* (heavens).
- i. The underworld, most often described by the Toraja as *Puang to Kebali'bi*, "Gods of the underworld" (Merok: 160-161) or *Deata sangpapa'na rokko... deata kaseranna papa'na rokko*, "Gods of the first layer below... gods of the ninth layer below" (*rokko* = below). Ibid.: 44-45.
- j, k. The hemispheres, respectively of the upper- and underworld.

- l, m. The line which symbolizes how Puang Matua and Pong Tulakpadang maintain day and night in equilibrium. The idea of an axis is not conceptualized by the Toraja; they content themselves with symbolic references such as a central post (cf. A. C. Kruyt 1923/24: 96). Their terms for zenith and nadir are of a similar, circumscriptive kind.
- l. Nadir, "They (i.e. the layers of the regions below the earth) have a point like the tip of a lance" (Merok: 175, verse 101, see also page 47, verse 169).
- m. Zenith (*tangngana langi'* = middle of the heavens; *ulunna langi'* = head of the sky; *massaloko batunna*, *massondong kandaurena*: "He (Puang Matua) has a zenith going to a point and tipped with a stone, it is as a piece of beadwork, wide-based and narrow at the top"; *ibid.*: 32-33, verse 76).
- N. The North (*daa*).
- S. The South (*lao'*, *lau'*, in Nanggala territory: *lo'*).

This schematic drawing represents my attempts to visualize what Toraja informants told Van der Veen about how they comprehend the cosmos. A cross-section of the three realms, upper, middle and lower, is presented. Puya, the kingdom of the dead, does not appear. Nor have I inked in the ladders to the sky down which Toraja ancestors descended to the island of Pongko', nor the palm trees up which the dead climb to help them reach the firmament. Perhaps the heavens could also be depicted triangularly, for they are on occasion compared to a roof (triangular in cross-section) or to a *kandaure* which is a coneshaped ornament consisting of beads.

In addition I wish to emphasize that in their visual arts the Sa'dan-Toraja never depict their gods as creatures resembling humans.

ANNEX Vb

THE FAMILY TREE OF THE GODS (KESU')

Langi' (Heaven) = Tana' (Earth)
Padang

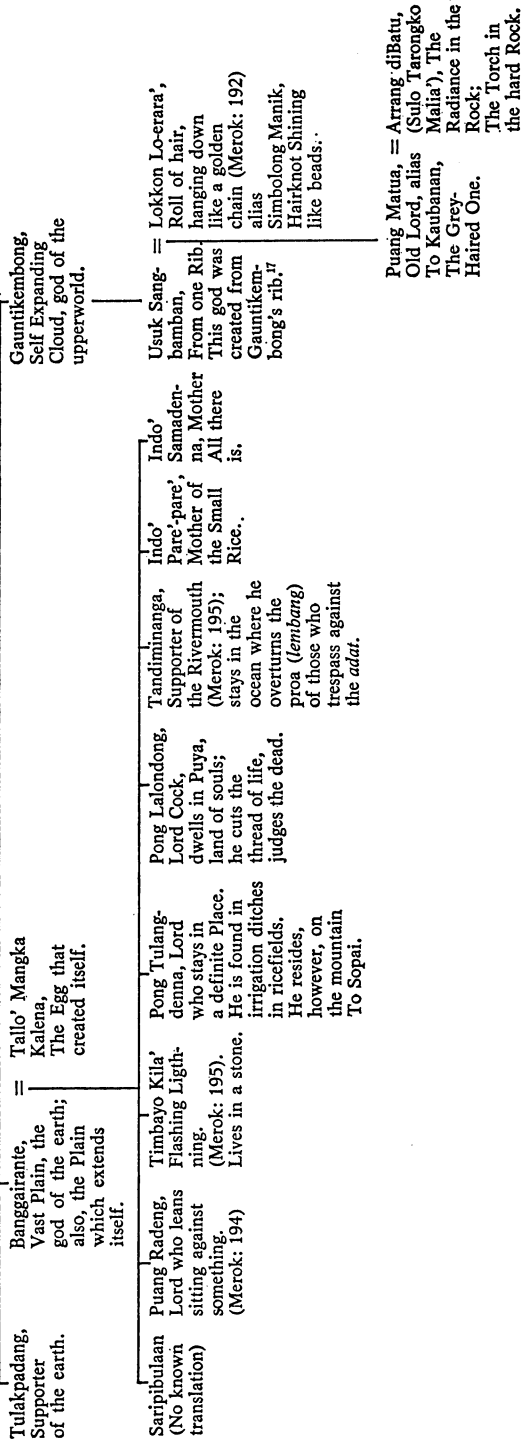

Puang Matua, = Arrang diBatu, Old Lord, alias (Sulo Tarongko To Kaubanan, Malia'), The Grey-Radiance in the Rock; Haired One. The Torch in the hard Rock.

CHAPTER VI

MYTHOLOGY

Myth is a matter of focal interest to the Sa'dan-Toraja. They will point out the significance myths have for *aluk*, ritual, and for *ada'*, the complex of their habits and customs.¹ The mythical history of these ancestors is also the history relating how rituals were established in the upperworld, how the first man and the plants and animals important to his existence were created, how class divisions came into being and how certain customs were adopted. Ancestors who descended from heaven brought these *aluk* (in the sense of *adat-decrees*) down to earth.

The Toraja have no special term for 'myth'; the term used for myths, *ossoran*, has the broader denotation of 'tradition'. When I inquired from my Toraja informants whether folk tales might be considered part of mythology, their answers were negative: folk tales, they explained, had no significance for the *aluk* (in the sense of ritual and *adat-decrees*). Nevertheless, when I pursued my questioning, it appeared that many folk tales were told specifically at the time that the rice began to ripen. In contrast to the myths which deal with gods and deified ancestors, these narratives are variations on the Cinderella-theme. It is quite conceivable that these tales have the promotion of the growth of the rice as their goal. The poor child who becomes rich has its analogue in the immature rice which eventually ripe (own interpretation). There are, however, also tales without any ritual or magico-ritual purpose, e.g. those in which a Till Eulenspiegel character is the protagonist, or thievery is the theme. Though, it is difficult to classify them as a special category because the same themes may recur in stories which have a cosmological impact. For this reason we shall, unlike the Toraja, call the entire treasure of mythological traditions and folk tales *myths*.²

The following collection of mythological data represents a selection from a vast number of tales; they have been grouped under four headings:

1. myths about the creation of the universe and the institution of rituals;
2. myths telling about the arrival of the ancestors on earth (often sequels to myths in the preceding category);
3. myths concerning the disastrous consequences of incest;
4. miscellaneous myths such as myths having a Cinderella-theme, myths relating about the underworld, Till Eulenspiegel stories and, in between, a number of myths which cannot be assigned to any one special category without raising problems about the classification of myths in general.

The collection closes with an unabridged version of the popular tale of Rangka Bulaan, a typical specimen of the Toraja style of narration. On the whole I have tried to confine myself to tales which are of specific significance for the organization of Toraja society and for the understanding of its elaborate ritual, or else which typify recurrent themes. In my comments, I have refrained from lengthy explanations, trying to limit myself to a few observations which might aid a reader to understand inherent symbolism.

VI.1 Myths about the creation of the universe and the institution of rituals

VI.1.1 *Kesu': Passomba Tedong, the consecration of the buffalo*

The universe originates from the holy marriage of heaven and earth,³ a general, worldwide mythic motif (see Fischer 1929) which is also part of Sa'dan heritage (Merok: 67). The creation as portrayed in the myths of the Sa'dan-Toraja is depicted in the *Passomba Tedong*, the consecration of the buffalo to be sacrificed at the *merok*-feast. This myth has been translated, and annotated in detail, by H. van der Veen (1965).⁴

In the beginning chaos reigned: "At that time when, so we are told, heaven and the broad earth still lay on each other, all was chaos; then, so it is said, the all-enfolding still touched the regions of the earth, all was still in disorder" (Merok: 67). Thereafter heaven and earth drew apart and spacious land was revealed. How or why the separation took place is not mentioned. Three children emerged from the union of heaven and earth: Pong Banggairante (God of the Earth), literally: 'The God whose Surface is Vast', Pong Tulakpadang and

Gaantikembong,⁵ 'The Self-expanding Cloud'. Pong Banggairante married Tallo' Mangka Kalena, the 'Egg that propagated itself'. (The mythological egg is a widely spread theme in Austronesian myths; sometimes the earth itself develops from such an egg. For more on the subject, see Muensterberger 1939: 231; for emergence of gods from an egg in Indonesian religions, see Stöhr 1965: 52.)

From his own rib, Gaantikembong ('The Self-expanding Cloud') created Usuk Sangbamban. This name is roughly equivalent to 'Rib of one piece'. (On linguistic grounds Van der Veen contests the possibility of Christian influence; the word-forms used in the myth are too ancient, though not so ancient that influence via the *Koran* can be precluded.)

Usuk Sangbamban⁶ married a woman from a rock, Lokkon Lorerara' ('Hairknot dangling like a golden chain') who is also called Simbolong Manik ('Hairknot gleaming like beads'). Before Usuk Sangbamban saw her, he heard her laugh deep inside the rock.⁷ From this union Puang Matua was born.

The three sons springing from the marriage of heaven and earth are referred to as a trinity and are compared to the three hearthstones. This trinity created sun, moon and stars (Merok: 69). Pong Tulakpadang ('Supporter of the Earth') is the god of the underworld, Pong Banggairante the god of the earth and Gaantikembong the one of the air. Banggairante is mentioned as the first to institute the ritual of the *ubi*⁸ (yam: *Dioscorea alata* Linn). Yams are thus regarded as older than rice, for rice was later created from Puang Matua's bellows.

From their union eight children arose (as elsewhere in Indonesia, the number eight recurs frequently in religious contexts). One of their eight children was the previously mentioned Pong Lalondong, the judge of the kingdom of the dead. (There are also accounts mentioning eight judges in Puya.)

The eight divine children generated in the course of the marriage of Gaantikembong and Tallo' Mangka Kalena (cf. chapter V, annex Vb) acquired the most diverse functions; they differ greatly in character and each of them has his own residence. Some, such as Pong Tulangdenna and Tandiminanga, are guardians of morality, others are quarrelsome at heart, e.g. Indo' Pare'-pare' and Indo' Samadenna.⁹ Some of these gods live on earth; others like Puang Radeng¹⁰ and Pong Tulangdenna, live more or less near the boundary line between worlds. Timbayo Kila', the Flash of Lightning, when not performing the function

of his name, resides in a stone. The two daughters, Indo' Pare'-pare' ('Mother Small Rice Species') and Indo' Samadenna ('Mother All there is') are associated with both the earth and the upperworld. The myth relating the conflict between these sisters and how they finally took refuge, the one with the sun and the other in the moon, has been communicated by A. C. Kruyt (1923/24: 325). The episode is touched on briefly in the *Passomba Tedong* (see Merok: 71), more or less as a sideline, the interpolation of an 'astral' myth supposed to be well-known. Indo' Sadenna or Indo' Samadenna is identical with Tulangdidi', the principal character in a myth of which various versions are in circulation (see VI.4.3).

Tandiminanga ('He who supports the mouth of the river') resides in the sea (or the place where the (Sa'dan) River issues into the sea). He is a guardian of morality who overturns the proas of those who have transgressed the *adat*-laws (Merok: 72-73). Pong Tulangdenna, finally, resides in the irrigation canals serving the rice fields.

The *Passomba Tedong* now turns to Gaantikembong's son, Usuk Sangbamban. This son married Simbolong Manik; the birth of their child, Puang Matua, has already been reported. Puang Matua, the supreme god, took the goddess Arrang diBatu ('The Radiance in the Stone' or 'The Radiance in the Rock') for his wife. This goddess sent Puang Matua to seek for gold in the West (there are indeed gold mines there, in Bittuang). Puang Matua makes ready to melt down the gold. From his double bellows, *sauan sibarrung*, the first human arose, Datu Laukku' (*ukku'* is the cry of a born infant). According to one version, the first human being was a man, according to the other, a woman (in the *Passomba Tedong* sung during the *merok*-feast in Kesu', Datu Laukku' is a woman; see Merok: 88-89). Datu Laukku' had seven siblings, who, like him, were created in the divine bellows. They were, successively, Allo Tiranda, the ancestor of the poisonous *upas*-tree (*Antiaris toxicaria* Lesch); Laungku, the ancestor of cotton; Pong Pirik-pirik, forefather of the rain; Menturiri, the ancestor of poultry; Manturini, the forefather of the buffalo; Riako', the ancestor of iron; and Takkebuku, the ancestor of (boiled) rice. The cinders left over after the creation of the eight siblings were scattered and trees arose from their ashes (Merok: 91). Laungku announced her marriage with the earth. She commanded that her body be spun into a thread resembling the skeins of a spider's web, and the thread was then to be woven into sacral *sarita*-cloths bearing the motif of swimming men, and into *maa'*-clothes decorated with crosses.

Datu Laukku' bore one son, Manturino (cf. the close similarity of his name with those of the ancestors of poultry and buffalo). The origin of his wife is not reported. Her name, Tumba' Sulotabang, reminds us of the *to tumbang*, the young women or girls who fulfil a ritual role during the *bua' kasalle*-feast, an important ritual to promote the well-being of men, animals and crops.¹¹

Manturino and Tumba' Sulotabang had a daughter who married a man whose descent remains unspecified. They in turn had three daughters who are compared to the three hearthstones.

After this, Puang Matua went on to create progeny from his bellows. On this occasion, he made six children. One of these was Kambunolangi', the first of the *to minaa* (a priest). Kambunolangi' had the status of a demi-god. The descendants of one of Kambunolangi's brothers received a more lowly place on the social ladder: they were Datu Bakka' and Pong Malaleong, the first slaves, 'used like a buffalo to work on the rice fields'. We made their acquaintance during our discussion of class divisions (see III.1.1).

Kambunolangi's other four siblings, Pande Patangnga' ('He who is good at planning'), Pande Pandita (or Pande Paita), Pande Manarang ('the skilful Carpenter') and Pande Paliuk ('He who is extraordinarily capable') came together to help Puang Matua build the Iron House in the Middle of Heaven, the prototype of important dwellings on earth. When the house was completed, a *sawah* was laid out, the first wet rice field ever made. The *sawah* did not prosper, however, for the rice did not thrive. Then again two figures were created from the bellows, the first rice priests, Datu Mengkamma' and Karaeng Ma'loko-loko. Once these priests had performed the (first) rice ritual, the crop turned out all right.

In addition to the rice ritual, the ritual for the Iron House in the upperworld was instituted (Merok: 123), followed in succession by the *maro*-ritual for curing the sick (idem: 143), the great *bua'*-feast and, last but not least, the *merok*-ritual. On the occasion of the *merok*-ritual, the *to minaa* or *sokkong bayu* recites the *Passomba Tedong* quoted so often in the present text. During the first (celestial) celebration, the richly laden *sendana* (= sandelwood) tree was set up in the upperworld. And Puang Matua decreed:

"Here is the richly laden *sendana* tree to which we shall bind the buffalo with skin befitting the offering rites, for this is the tree with the blood of mankind, herewith is the tree whose branches are full of precious things, to which we shall

tie up the kerbau with the neck hair suitable for the *adat* performances, the tree with the life-fluid of the people of the earth" (Merok: 153).

The above passage reveals how the sacrifice of a special buffalo was prescribed (which, further questioning disclosed, should have a grey skin). Similar details are set down for other rituals: every feast, and also certain less elaborate rites, involves a sacrificial animal of a specific colour. The markings of appropriate hens are described at length in the *Passomba Tedong* (see Merok: 94-96; 124-128). Similar criteria determine what buffaloes are to be sacrificed, criteria further complicated by prescripts including a pairing of colours and social classes (idem: 126-128).

The litany closes with the marriage of Sambiralangi', the son of the first *to minaa*; the union took place in the upperworld, the bride was a dazzling, yellow star. From this marriage came a son, 'The Foam of Heaven'.

The 'Foam of Heaven' married Kembong Bura, 'Full of Foam'. Via the 'Heavenly Steps', Eran diLangi', the couple descended to the earth. In heaven, this couple had received from Puang Matua 7,777 rules concerning the rituals (*aluk*). In order to take these rules down to the earth, 'Foam of Heaven' requested the assistance of Puang Matua. He ordered a slave, called Pong Paku Lando ('The Long-leaved Fern') to carry the rules down to the Earth. Pong Paku Lando found this burden too heavy and therefore he only carried 777 *aluk*-rules; this is why the number of rules amounts to 777 only.

The 'Foam of Heaven' and Kembong Bura begot a son, called Pong Mulatau, which means 'First Man (on Earth)'.

The contents of the *Passomba Tedong* can be summarized as follows:

1. The settling out of the universe: first the sundering of heaven and earth in two, followed by a tripartite division of heaven, earth and underworld. The division of day and night.
2. The genesis of the more important gods; those most prominent are Gaantikembong, god of heaven; Pong Banggairante, god of the earth; Pong Tulakpadang, god of the underworld; Pong Lalondong, god of the realm of the dead; Indo' Belo Tumbang, the Protectress of Medicine; and Puang Matua, the uppergod.
3. The creation of the first human and the two significant sacrificial animals, the buffalo and chicken, all of whom emerged from the

ashes of Puang Matua's bellows. Important plants also originated, such as cotton, the three-eared rice, and the ancestor of boiled rice. The gold dust of the bellows produced the poisonous *upas*-tree whose poison is of importance for hunting (cf. boiled rice vs. *upas*-plant; hunting among the Toraja may indeed be of significance, but not as a source of food).

4. The creation of iron, the raw material for agricultural tools and weapons.
5. The construction of the first house and of the first rice field.
6. The origin of class divisions.
7. The institution of the main rituals.
8. The introduction of rules concerning sacrificial animals.

VI.1.2a *The creation myth as handed down in Riu (lembang Suloara, kecamatan Sesean)*

Van der Veen owes his account of the origin of the universe and of the first celebrations of the major rituals to the *to minaa* of Kesu'. The account reflects something of the charms of the Kesu' landscape which, with its soaring limestone outcrops, reminds the visitor of sketches drawn by Chinese landscape artists. The rendition of the myth as printed below comes from Riu, a region situated on the slopes of the Sesean where *sawahs*, often crammed between colossal stone formations, veer from close to the summit down to the plain. The landscape is the product of a fascinating interplay between the works of man and nature. Seen from on high the sky is reflected in hundreds of wet rice fields often so small that they cannot be tilled with a plough. It is a wonderful landscape but until between eight and ten o'clock in the morning it is all wrapped up in mist. It only reveals itself during the heat of the day. Towards five o'clock in the afternoon fog descends from the peak of the mountain and envelops the charms of the landscape's terras in a grey mist. The Riu landscape is wilder than Kesu'. Its story of creation reflects the dynamics of the landscape.

The genesis of the universe and the family tree of mankind were retold and described by the *to minaa*. He insisted that I record the story of the creation, because the rites of the *buu'*-feast could not be communicated without being preceded by the myth of origin.¹²

In the beginning To Kaubanan, 'He with the Grey Hair' (the alternative name for Puang Matua in Kesu'), the supreme god in heaven, lived at the zenith, *do tangnganna langi'*, in the centre of the firmament. He married Arrang diBatu, the 'Radiance in the Rock', who

is associated with *ulunna langi*, i.e. the 'head' of the upperworld (cf. Merok: 85).¹³ From their marriage six children were born:

1. Datu Masarrang, the fierce Datu, a savage character;
2. Datu Laulo';
3. Tau Allo;
4. Kanda Matu;
5. Pong Mulatau (the ancestor of mankind) and
6. Datu Laukku'.

Datu Laukku' married with Datu Etan ('the Black Lord') who also dwelled in *ulunna langi*. He wished to build a house and sacrificed a chicken (this chicken was the first sacrifice for the building of a house; chickens of all colours, except white, are acceptable for such a sacrifice). The offering is presented on a banana leaf (*pesung*).¹⁴ Thereafter the house was constructed.

From Datu Laukku's marriage with Datu Etan six children were born:

1. Seno Betuan who was entrusted with performing the *ma'pesung* during the *ma'nene*-rite;
2. Do' Pare'-pare' (Indo' Pare'-pare'). She should perform the *ma'pesung* on the occasion of *ma'papa*, the renewal of the roof of the *tongkonan* (see VIII.1; for this sacrifice, a pig must be killed);
3. Datu Manappa', The Reliable Lord, who celebrates the *ma'sura tallang*, a sacrifice made to expiate for transgressions;
4. Do' Rua Tumbang (Indo' Rua Tumbang) was given the task called *ma'bate*, carrying out the bamboo pole. She was the first *tumbang*. This is surprising, because the task allocated to her (*ma'bate*) forms part of the *maro*-ritual. Presumably the name *Tumbang* does not refer to the *tumbang* of the *bua*'-feast, but to a functionary who must fall in trance in the course of the *maro*-rites;
5. Lua' Toding (*Toding* is the name of a black animal with a white patch on the forehead). He instituted the original *merok*-feast and laid down directives for its celebration;
6. Lando' Samara, the youngest child, performed the first *bua*'-feast, a ritual which incorporates, as it were, all other rites. *Samara* is the term for a buffalo entirely black except for a white spot on its head and at the tip of its tail.

These six founders of the rituals, the children of the gods Datu

Laukku' and Datu Etan, all dwelled in the 'head' of the upperworld (*ulunna langi'*).

Pong Mulatau, also abiding in *Ulunna Langi'*, married Datu Langi' who had her residence in heaven. Their children were delivered in the zenith:

1. Indo' Samadenna, who, with her Golden Spinning-wheel (*Unuran Bulaan*) prepared the first thread;
2. Barrang diLangi' made the first *sawah* and brought the appropriate offering of three eggs: *tallung telu*;
3. Datu Laega founded the first market (*pasa'*) and handed down rules for its operation;
4. Tamma Lelu was the first gambler and laid down the rules for throwing dice;
5. Sambira Langi' introduced cock fights;
6. Datu Mangkamma was the first *to indo' padang*; it is explicitly stated that he was not only the leader of the rice ritual, but the priest of all crops. Today the *to indo' padang* is exclusively the leader or priest of the rice ritual;
7. Manurun diLangi', 'He who came down from Heaven', became the *kambi'* (keeper) of the 7,777 rituals. He categorised the rituals;¹⁵
8. Pande Patangnga', the first iron smith;
9. Pande Langi'na made the first buffalo;
10. Pong Lumbang Koko was the *kambi'* (keeper) of the *to kasalan*, of those who had committed a trespass;
11. Tambuli Langi' was the first *to minaa* (for the priestly office, see chapter IX);
12. Killi'-killi', literally: words spoken to a small child while showing a finger poised to tickle him and to make him laugh.

Thus, gradually, order in matters of every description was achieved, thread was spun, rice planted, jobs were distributed and rituals established. From that juncture on, the myth concentrates on Manurun diLangi'. When this god wanted to descend from the southern part of heaven, he spied a vast sea (literally: when he dwelled in the tail of heaven and the heavenly gateway opened, he saw a large sea). He built himself a house between heaven and earth (*ma'banua ditoke'*) that was rocked to and from by the wind (*malentong dianginni*). His heart 'enlarged' when he saw the great world and he pondered how he should reach this world for everywhere there was only water. He

consulted To Kaubanan and asked for a piece of land. He acquired a bit of soil (*sangka'pan padang*) and To Kaubanan told him, "Toss this clump of earth that I have given you into the sea". To Manurun diLangi' did so, and then he asked, "What am I supposed to do with that small plot there? Sure there is land now, but no grass and nothing to eat". To Kaubanan gave him seeds which he strewed. These sprouted. Still, there was no livestock, and once again To Manurun diLangi' applied for help to To Kaubanan who replied, "Here are buffaloes". So the petitioning went on until everything on earth was present in full. Then Manurun diLangi' asked To Kaubanan how he should descend from Banua diToke. He requested a 'way to below'. To Kaubanan said, "I will provide a *sepena langi'*" (a branch of the sky), and instructed him to call Pong Pakandona (a slave?). Pong Pakandona then fashioned a ladder — actually a mountain of earth which he raised by trimming the edge of the island that originated from the clod of earth which Manurun diLangi' had thrown down from heaven. Now all was complete, the animals inhabited the earth, the earth itself divided into regions: Sulawesi, Europe,¹⁶ etc. When Manurun diLangi' had landed on his lump of earth, called Lebukan, he slaughtered three chickens as a sacrifice for the building of a house. In the meantime he had also asked for a wife and the request had, as all the others, been granted. A woman was tossed down out from the upperworld. He met his wife next to the well. Her name was Marin diLiku (*liku* = pothole). She asked him, "Have you no servant?" Manurun diLangi' replied, "Just call someone whose name is Indo' Kalumpepa". Together with this servant from the Sesean (a mountain) Marin diLiku went to Manurun diLangi', and their union could then be accomplished. From their marriage, eleven children were born:

1. Banggai diRante; he is the *kambi'* (keeper) of the *pitu lampa'na*, *pitu pulona'*, *pitu ratu'na*, *pitu sa'bunna*, the 7,777 rituals already cited. He shared this responsibility with Manurun diLangi';
2. Sarong Lia, who went to Europe;
3. Arung Bone, who made his way to Bone;
4. Banne Rara', who traveled to A'riri Langi', the Pole of Heaven;
5. Datu Gantanan, who stayed in Lebukan;
6. Datu Mangoting, who proceeded to Palopo;
7. Rangga Danun, who went to Butu Apian;

8. Kila' kila' (the Lightning), who returned (to heaven);
9. Bota bulaan, who advanced to the sea (perhaps to become a fisherman?);
10. Mohammad, who directed his steps to Mecca;
11. (Not reported).

Banggai diRante left Lebukan after he had slaughtered a chicken. He departed from the island in a proa, taking the rituals along with him. He arrived in Rante Bulaan (the Golden Plain, a poetic or mythic name for Tana Toraja). Here he married Rangga Uai (Watersnake; a *rangga* is a snake with a forked head). From their union, five children were born:

1. Puang diRano;
2. Puang Siguntu';
3. Puang diKalembang;
4. Puang diAo;
5. Seppa Bulaan.

Puang diRano remained in Rante Bulaan but the other siblings set off elsewhere. In Rante Bulaan the *kapa'* was institutionalized. Further details about this *kapa'*: the fine imposed on *tana' kua-kua* was set at one pig, on *tana' karurung* one buffalo, on *tana' bassi* six buffaloes, on *tana' bulaan* twelve buffaloes. For an explanation see II.5.2. Consequently, those of the first two categories were unable to celebrate a *bua'*-feast because two buffaloes (= *sang ayoka*, a team) must be offered on such an occasion.

Puang Siguntu' brought his followers to the settlement of Siguntu' and held a *maro*-feast. He made a mistake, however, so that everyone went mad. They scattered everywhere. In a trance they entered the forest but could not recover. This induced the five siblings to convene a meeting. They went to Bone where they again celebrated a *maro*-feast. All people came, even those who were out of their minds, and these then returned to their senses. Then people turned back to Rante Bulaan. Upon their arrival there a *bua'*-feast was celebrated, the first *bua'*-ritual on earth, the *aluk sumpu langi'*, the completion of all feasts because everything has been brought to an end.

The myth differs from the one narrated in the *Passomba Tedong* of Kesu'. No mention is made of partition of the universe in three. The names elsewhere conferred on the first human being, Datu Laukku' and Pong Mulatau, also appear in this myth, but here Manu-run diLangi' is of supreme importance. As in other versions, rituals,

markets, cock fights, etc. are all of supermundane or sacred origin. It is not always clear, whether those who established the rituals were male or female.

At times we meet with the same names of gods and their offspring as in Kesu', but often their tasks or function differ from those of their namesakes. Here, too, the important ancestors who make their home on the earth, often take wives who are associated with water (Pothole, Watersnake).

The myth was presented by the *to minaa* (priests) in its entirety to emphasize the importance of the great *bua'*-feast.

VI.1.2b *The creation myth from Tikala, lembang Suloara'*

In the Riu-version of the creation myth two important goddesses are absent who are described at some length in the 'Traditions recorded by Ne' Mani'. They are Indo' Ongon-ongon and Simbolonpadang (the last name means: Hairknot of the Land; *Indo'* = mother, *Ongon-ongon* is untranslatable). The goddesses were sisters who had various brothers, one of whom was Labiu-biu. Simbolonpadang created the lightning and fashioned all that is bad; then heaven and earth parted. Labiu-biu then brought an expiatory offering: he kindled a torch. Indo' Ongon-ongon descended to the underworld where she married the Supporter of the Earth, Pong Tulakpadang. The couple created the earthquakes. Puangdilalundun, one of the brothers of Labiu-biu and his two sisters, had a son, Puang Matua the Older (or Puang Matua the Earlier). He in turn fathered a son, Puang Matua the Younger (this differentiation of two Puang Matua is found in neither the mythology of Kesu' nor Riu). Puang Matua the Younger created the first human being in the upperworld, Datu Laukku', a man (in Kesu' the first human is a woman). From his divine bellows he also created: the first *to minaa* (a priest); Killi'-killi', the forefather of the *burake*-priests; the ancestor of the *to ma'gandang*, together with the *to burake* an important functionary during the great *bua'*-feast; the ancestor of the rice priest; the forefather of the first slave; the ancestor of the buffalo bull; the first chicken; the first pig; the first dog; the first cat; the forefather of the rice; that of the cotton; that of the bamboo-varieties called *tallang* and of the thick bamboo called *pattung*; the ancestor of betel, of the sugar palm; of the poisonous *ipo*-tree; of the *sendana*-tree; the forefather of the banana and that of iron. The number of ancestors exceeds that mentioned in other creation myths (e.g. that of Kesu'), but Ne' Mani's 'Traditions' omits

the small rains. On the other hand, it presents the story of Mad Chicken, who lost his reason because he married his sister. Also in Tikala, rituals originated in the upperworld. The first man descended to the island of Pongko', and the more important animals, too, came down from the upperworld. However, no reference is made to a healing ritual in the upperworld, nor to the goddess Indo' Belo Tumbang (cf. Merok: 142-143, verse 728). Only the cure of the child of Tulakpadang in the underworld plays a role; the child is cured by Marampio Padang. Ne' Mani' winds up his 'Traditions' with this story, part of that of the thief from the underworld, and thus ends his account of the great deeds of the gods far down in the underworld.

VI.2 Myths telling about the arrival of the ancestors on earth and the adventures of their descendants

VI.2.1 *The to manurun in the puang-regions: Tamborolangi' and Lakipadada*

a. *Tamborolangi'*

What follows below has been borrowed largely from articles written by Puang Paliwan Tandilangi' (Tandilangi' 1967, 1968). Tamborolangi' and Lakipadada are the famous ancestors of the *puang*-ramage (or ramage) reigning until recently in Tallulembangna (the *puang*-regions). Roughly forty generations ago Puang Tamborolangi', the son of Puang Matua, lived in the upperworld. Datu Laukku', the first human being, already was on earth, dwelling there in the company of other of Puang Matua's creations — useful plants and animals, such as the water buffalo, the pig, the chicken, the rice, the cotton, etc.

Originally Datu Laukku' could make use of the ladder to heaven (*Eran diLangi'*, celestial ladder) to consult regularly with Puang Matua. But then Puang Matua, angered by a transgression committed by one or more mortals,¹⁷ overturned the ladder so that further visits were out of the question. Ever since Datu Laukku' could meet Puang Matua only in dreams.

Since mankind could no longer confer with Puang Matua and, consequently, the *sukaran aluk* (the *adat*-decrees) deteriorated, the Supreme god resolved to send someone down to earth to purify and to complete these decrees. At the time these *adat*-rules — as far as mortuary rituals were concerned — consisted merely of rituals of a lower order, i.e. those not surpassing the *tallung bongi*. Puang Tam-

borolangi' was then sent below in order to bring the *sukaran aluk sanda saratu'* which contained the 7,777 *adat*-decrees (here, too, significance is attached to the number 7; *sukaran* means measure, *aluk* ritual, *sanda* complete, and *saratu'* one hundred). No mention is made of the slave who left 7000 *aluk* behind him in heaven. To the accompaniment of violent noise, thunder and lightning (the word *tamboro* signifies drum according to Tandilangi'; *Woordenboek* page 668 defines it as a basket plaited from palm leaves), the *puang* descended from heaven (*langi'*). He did not arrive straightaway on earth! A door gaped open in heaven from which a house was lowered destined for him and his retinue. It floated between heaven and earth. This 'Hanging House' (*Banua diToke*) was suspended above Kandora, a mountain some five kilometers south of the town of Makale (Ma'kale). In it resided the son of the Master of Heaven with all those who had descended with him from above: *to makaka*, slaves, buffaloes, etc. Mention of the *to makaka* (the class of free farmers) and of slaves indicates that classes had already been instituted in the upperworld and that slaves, too, are of heavenly origin. In other words: the institute of slavery is no innovation but sanctioned by ancient myth.

Considering that, in their entirety, the *adat*-decrees also embrace rules for marriage, the earthlings connected with Puang Tamborolangi' that he could not possibly teach them as long as he himself remained unmarried. Then he took princess Sanda Bilik as his wife, a woman who emerged from a boulder in the river near Sapan Deata (situated where the Sa'dan and Maulu Rivers merge; *sappan* = dam, *deata* = god or goddess).¹⁸ The river goddess did not throw caution to the winds; before marrying Tamborolangi' she wanted to know everything there was to know about the *sukaran aluk* which meant that a slave had to shuttle back and forth a full twelve times between Sapan Deata and Kandora before the *deata's* curiosity was slaked. Then the water princess joined Tamborolangi', who had descended from heaven, in matrimony. The ceremony was the prototype for all marriages on earth to follow (for the marriage ritual among the Sa'dan-Toraja, see Van der Veen 1950). It should be noted that in Kesu', Puang Matua's wedding in heaven serves as a model for mortals' marriages: in Tallulembangna, the model is the *sukaran aluk* given by Tamborolangi', their direct ancestor.

Before the wedding of Sanda Bilik and the *to manurun* was consecrated, there was discussion about where the better place to settle

would be, Banua diToke, which, encircled by winds, was cold, or Sanda Bilik's home, damp and cool because of the river water. The couple decided to make their home elsewhere, upon the cliffs of the mountain Ullin in the district of Banga. The *tongkonan* of that name which was founded here was the first on earth (there remain no traces of the building any more).

Three kinds of sacrificial animals were presented to the couple at their wedding: 12 buffaloes, 12 pigs and 12 chickens, all of which have since become obligatory offerings at the *mangrara tallu*-ritual (probably this ritual accompanies the inauguration of a distinguished house; *mangrara* = to cover in blood, *tallu* = tree). Then followed the institution of all the *adat*-decrees in full, the *sukaran aluk sanda saratu*' valid for, primarily, the Tallulembangna and Ullin up to the present day. They included decrees for everything, the rituals for the dead and those associated with law, those of significance for social interaction as well as those pertaining to agriculture. In this same context mankind was taught how to cultivate the *sawah* with the plough; a stone plough brought from heaven served as an example, the *tengko batu* (*tengko* = plough, *batu* = stone).

Eight children were born to the water princess Puang Sanda Bilik and her husband, the *to manurun* Puang Tamborolangi'. Two went to heaven, two entered the water, so that four returned to their father's and mother's places of origin, respectively. (She herself, later, also went back to where she had come from.) The oldest of the four remaining children, Puang Maeso, married Puang Tanrakisa. Their *tongkonan* stood at Rano. From this union, princess Deatanna was born. Puang Maeso received a buffalo as a gift which was called *Sokko Remak*.¹⁹ The second child who remained on earth, Puang Papa iLangi', lived in Gasing (Mengkendek) and married a wife who emerged from a pond also lying in Gasing. Her name was Puang Lolong Kila'. From their marriage came four children: Puang Landek who settled in Simbuang in Sangalla'; Puang Paetong (or Pa Etong) who made his home in Otin in Mengkendek; Puang Toding, who settled in the *tongkonan* Banua Lande at Ma'kale; and Puang Panggoso who also chose a residence in Ma'kale.

The third child of Tamborolangi' and Puang Sanda Bilik was Puang Tambuli Buntu or Puang Tumambuli Buntu (sometimes abbreviated to P. Mambuli Buntu). Tambuli Buntu signifies: he who smites a hole in a hill. This is how he supplied himself with water, a motif reminiscent of Moses and the rock (Exod. 17: 6). According to an

alternate version, Bombo Kosik, a slave, had the power to patch such a hole with betel-saliva (Nobele 1926: 123). Bombo Kosik is a remarkable name; it is the name of a aquatic insect which gives off a cadaverous odour. It is believed that this beast appears when the decomposition of a corpse sets in (*Woordenboek*: 246, under *kosik*). This could be an indication that this slave was associated with the dead and the West. Puang Tambuli Buntu, the son of Tamborolangi', was a hunter who acquired a hunting hound (from his father: legacy?) called Saliko Landara. Puang Tambuli Buntu married Manaek, the daughter of Ambun diKesu'. From the marriage of Manaek with this prince (later she married another), eight children were born; Puang Patimba Bulasa, who lived in Kaero was the first (Kaero became the *tongkonan layuk*, the most eminent *tongkonan*, in Sangalla'); this first born married Puang Pattala Bantang, the child of Lakipadada and the princess from Goa. They founded the principedom of Sangalla'.

Puang Tambuli Buntu and Manaek's second born was Puang Palaga who chose (*tongkonan*?) Tarongko in Ma'kale for his residence. Their third child was Puang Pasongka who settled in Bamba in the district of Nonongan. The fourth born was Puang Patulak Allo about whom no further details are known. His younger brother, Puang Marimbun, made his home in Bungin in the district of Ma'kale. The sixth son, Puang Bongga, went to Salu, the seventh, Puang Timban, to Adi Tondongkan, and the eighth and last, Puang Bilu, to Lando (?). The roll-call of these children serves the single purpose of illustrating how at a very early time the progeny of the *puang*-lineage already scattered to make their homes at different locations not only within the *puang*-regions but also beyond.

The fourth child of 'Tamborolangi' and Sanda Bilik, Puang Sandaboro, journeyed even further away and arrived, during a hunt, in the vicinity of the Bay of Bone. He was about to split a bamboo when a tiny little voice called him to spare her and to marry her instead, and build a *tongkonan* in Batu Borong, a place whose location is today no longer traceable. The voice turned out to belong to a beautiful princess who stepped forth from the bamboo. Sandaboro married her. From this union Lakipadada was born.

b. *The adventures of Lakipadada as told by Puang Willem Popang Sombolinggi' (Sangalla' 1969)*

Puang Lakipadada is the founder of the princely ramage in the three *puang*-regions (Tallulembangna) in Tana Toraja, and of those of the

rulers of the Buginese kingdom of Luwu' and the Makassarese kingdom of Goa.

Lakipadada, contemplating the problems of death, conceived the plan of going in search of immortality (*tang mate*). In the company of his faithful dog, he set out. The dog remained by him as far as the edge of the ocean, close to heaven, and then could not accompany him further. Here at this place Lakipadada met a pure white water buffalo, Bulan Panarring, who spoke to him: "If I bear you over the ocean, you will agree not to eat of my flesh, nor of the flesh of my descendants. The white buffaloes which will be born in your country will be blind" (blindness among white buffaloes indeed appears prevalent in Tana Toraja where, at birth, such animals are tossed into a cavern or pit and left to their fate). Lakipadada accepted the proposition. The buffalo, however, could not complete the passage. He drowned. Puang Lakipadada saved himself, climbing onto a limestone rock.²⁰ He had been perching there a long time when a giant sea crab (*bungkang tasik*)²¹ accosted him, offering to carry him to heaven. When Lakipadada finally arrived there, Puang Matua granted him eternal life on the condition that he would not sleep for seven days and seven nights. For six days Lakipadada remained awake, but on the seventh he fell into a deep slumber. Puang Matua then removed something from Lakipadada's sword as proof that sleep had overcome him. The god then told him of his failure, but allowed him to live for six generations. (For another version, see Nobeles 1926: 121-127.)

Throughout his long life, Puang Lakipadada made many journeys, bringing back home a small number of remarkable swords, the *la'bo' penai*. These swords were the *Sudan*, originating from the Sudan, Africa, and now in the possession of the princes of Goa; the *Maniang* and the *Doso*, now the property of the *puang* of Ma'kale; and the *Bunga aru*, or *Bunga waru*, owned by the *datu* (prince) of Luwu'.

On one of his voyages, Lakipadada was shipwrecked but could rescue himself on a rock. Gradually he was covered over completely with seaweed. Happily he could sustain life by eating *mangga*-fruits, for a *mangga*-tree was growing from the rock.²² For seven years he fed from this tree. One day a certain sea eagle or *garuda*,²³ *Langkang Muga*, alighted on the rock. After eating from the *mangga*-fruit the bird fell asleep and Lakipadada then grabbed hold of one of the bird's spurs. On his person Lakipadada stowed away a pit of a *mangga*.²⁴ The eagle flew on high with Lakipadada clinging fast to

its spur. Above Goa, the bird began to descend. Lakipadada loosed his hold and fell onto a forked branch. The *garuda*, flying on, disappeared from sight. Lakipadada, draped in seaweed, looked more like a strange beast than a man. People who came to draw water, saw Lakipadada. First a slave (*kaunan*) of the *raja* tried to drag Lakipadada from the tree, but the slave died. Then a *to makaka* came. He, too, tried to dislodge Lakipadada from the tree but he, too, perished. Then the *Raja* of Goa himself came, and only then Lakipadada could descend from his lofty perch. The *raja* ordered Lakipadada to be cleaned. Initially, the seaweed refused to come off. Then a bird cried, "Wash him with an extract of *lemo laa'* (citrus fruit); he then will regain the colour of a *danga-danga* (species of *gladiola*)". The advice was followed, whereupon the seaweed peeled away. Lakipadada now received food from plates presented in succession by a number of people belonging to different classes. None of these were of noble blood, and they all died. Finally, the *raja* offered him food from his own dish. Since the *raja* did not die, it was evident that this unseemingly and extraordinary stranger must be a person of princely blood. In the meantime drums were being beaten without cessation. Lakipadada asked what this meant. He was told that the *raja's* wife was on the point of delivering a baby. Up to that time women in Goa could not give birth except by means of an operation. Lakipadada inquired what his reward would be if he helped the wife of the *raja* bear her child without the use of any artificial aids, and he added, "Actually, I don't really want any reward. I only want your child if she happens to be a girl." All the time the *raja* had realized that Lakipadada was not an ordinary person. He agreed. Lakipadada assisted at the delivery and all went well. Later he married the princess who, by his help, had seen the light of day.²⁵ From their marriage three sons were born: Patala Bunga, Patala Bantan, and Patala Merang.

Before he died, Lakipadada climbed a peak of the Latimojong and divided his realm into three parts. Patala Merang acquired Goa and the title of Samba ti Goa; Patala Bunga received Palopo, i.e. the region north of Bone Puto and east of Buntu Puang. He acquired the title of Datu i Waraë and Payung ti Luwu'. Patala Bantan received the area now known as Tana Toraja (but the territory allotted to him by Lakipadada is not the same as contemporary Tator; it encompassed the region north of the Mappolo Lambang as far as the Tomini-bend). This son was endowed with the title Puang Matasak ti Toraja.

The ruler of Goa inherited the sword Sudan and the *doi' i manuk* (literally: money with a bird, 'fighting cock farthing', a coin minted by the English). The *datu* of Luwu' was given the sword Bunga Waru. The son who reigned over Tana Toraja received the Bate Manurun, a flag descended from heaven, a red cloth carrying the image of a *garuda*.²⁶ The flag may be exhibited only when a pig is sacrificed. It is on display at mortuary rituals, or solemn state occasions, and on official visits by high dignitaries. This same royal son was presented with V.O.C. (Dutch East Indian Company) coins as *pusaka* (!) together with a *kandaure*, an ornament of beads, named Pattara. According to Nobeles he also received two ancient textiles: Indo' Lebo and Arang to Buang (Nobeles 1926). The sword Maniang also remained in Tana Toraja, in Ma'kale itself. For additional *pusaka*-items cited by Nobeles, the reader should consult Nobeles's article.

Lakipadada's adventures, by dint of the many wonders which take place, resemble those characteristic of a Malayan *hikayat*; the narration also reminds us of the I La Galigo and the story of Tele Raa among the Bare'e-Toraja. In the latter work the protagonist, Tele Raa, is transported by Tobongkilo, a hen-harrier, to Tana ngKalë-loë, the 'Hanging Country', an island in the celestial sea (Adriani and Kruyt, vol. III, 1914: 440-442). This 'Hanging Country' is comparable to the Hanging House of Tamborolangi' (cf. VI.2.1a). In a second version of the story of Tele Raa, she and Tobongkilo cross the sea to land on a rock where a *taripa jambi* (*Lodoicea Sechellarum*) grows. This motif also crops up in the story of Lakipadada (cf. VI.2.1b). In the limited space available it is not possible to explore the parallels between the myth of Lakipadada and the I La Galigo. (For the I La Galigo, see R. A. Kern, *I La Galigo, Catalogus der Boegineesche, tot de I La Galigo-cyclus behorende handschriften* [I La Galigo, a catalogue of Buginese manuscripts belonging to the I La Galigo-cycle], Leiden 1939.)

One descendant of Lakipadada is Sawerigadeng, the hero of many myths. One of these current in Tana Toraja (in the *puang*-region Mengkendek) has been recorded by Salombe' (Salombe' 1975).

An effort at interpreting the Lakipadada myth

Whereas Tamborolangi' is a kind of culture hero or *Urheber* (he teaches mankind various techniques and having completed his mission he returns to heaven), Lakipadada's concern for humanity is of a

different nature. Lakipadada, of heavenly origins but himself resident on earth, seeks immortality. He sets himself this goal. His quest for *tang mate* is less on behalf of humanity than it is for himself. After all, the *to manurun*, from whom he descends, are invariably immortal. The first animal to accompany and to assist Lakipadada, is a dog. When they have reached the ocean the hero, compared to Odysseus by Nobele, sets out to cross the waters which separate the earth from heaven. Among the Toraja the ocean is not simply chthonic as it is thought of in Bali: the sea constitutes the link between the earth and the upperworld. Ocean passage is accomplished with the aid of a white buffalo and a sea crab. The first helper falters; he, like mankind, is mortal, for of all animals the buffalo is closest to man (see also VII.1). The white colour of the buffalo alludes to the close ties between this beast and the *puang*-lineage which is held to have white blood. Assisted by the second animal, a sea crab, Lakipadada succeeds in reaching heaven. Since at regular intervals, it is, like the snake which sheds its skin, a symbol of eternal life. Lakipadada is set a task by Puang Matua: not to sleep (sleep = death). He fails, but because he has managed to keep awake a long time a long life is apportioned to him.

Other prominent aspects of Lakipadada's person are the following: in Goa he succeeds in bringing an end to the era of complicated childbirth which presents him in the light of a medicine man. This is an example of his dedication and helpfulness towards mankind, but also a form of compensation for not having attained the goal of immortality. He travels a great deal, assisted by celestial birds (cf. his flight with a *garuda* or sea eagle) and by creatures of the deep. They symbolize his association with both the upper- and the underworld. These associations also emerge from Lakipadada's sojourn on the rock in the midst of the ocean. There he is transformed into something of a marine creature. He is a man in disguise, to all appearances a beast that has been spawned by the sea, wretched in seaweed. The ocean connects heaven and earth; Lakipadada as an animal of the sea is a mediator between man and gods. The tree in which he perches for so long is the world tree; the rock where he is marooned, the world mountain.

The gladiola has a colour which is associated with higher mortals. Eating from a specific dish is for the Toraja linked up with a specific class. The chthonic and the celestial elements (ocean and upperworld), opposite poles, are conjoined in Lakipadada. Because emphasis is

placed heavily on his princely blood, he represents both priest and prince. He had three sons; they reigned over the three most important princedoms of South Sulawesi: Goa, Luwu' and Tana Toraja. Later three *puang*-regions came into being, the Three Proas, ruled by the descendants of Tamborolangi'. The number three is related primarily to matters originating in the upperworld. Just as there are three important gods, so in important regions there often are three rulers (Kesu', Tallulembangna). From the upperworld came the three-eared rice; the three hearthstones often serve as a metaphor on occasions which have to do with the upperworld.

VI.2.2 *The to manurun in Kesu'*

VI.2.2a *Manaek and Polopadang (told by Bua' Sarungallo)*²⁷

From the first marriage of Ambun diKesu' with Puang Mora, a son and a daughter were born: Palonga and Manaek. Palonga was killed by the people of Luwu'.²⁸ From the second marriage of Ambun diKesu', that with Pabane', similarly, a son and a daughter were born: Polopadang and Lai' Ambun. Since Palonga had been killed, Polopadang was destined to become the foremost dignitary in Kesu'.

One day Polopadang went to catch fish in Tadongkon, in a *sawah* known as To' Kamiri (*kamiri* = *Aleurites triloba*). The *sawah*, situated in Kesu', is also called To Kalimbuang, 'The Place of the Well'. Polopadang was accompanied by his dog. In the *sawah* a fish-trap had been constructed, a *gusian*. A *gusian* is a rectangular or round space in the *sawah* which has been partitioned off with walls reinforced by rods or poles that criss-cross each other. The *sawah* itself is the fish pond and is, as every *sawah*, surrounded by an earthen dam. To let the water flow out of the *gusian*, Polopadang removed the soil of the outlet. Then he ladled out the stranded fish with the help of a *bingka'* (a small winnowing fan). When he had captured most of the fish, he went looking for those which had taken refuge between the poles. In between the poles often deep spaces exist. Reaching in to probe such a gap, Polopadang's hand became stuck. No matter how he tugged, his hand would not come free. Then he bade his dog to fetch his halfsister Manaek. The dog ran to the house of Manaek where he barked and carried on so fiercely that she followed along with him for a distance. Then Manaek turned back home, but the dog began again to bark. This happened several times. Finally Manaek went with the dog far enough to discover her brother

Polopadang. He implored her to get his jacket and promised her to renounce his right to succession. Manaek brought the jacket and struck Polopadang's arm with it three times. Then Polopadang was able to free his hand.

My informant concluded his narration with the information that the *kabusungan* went to Manaek and the *kandean saratu'* to Polopadang. This comment demands explanation. *Kabusungan* can be translated as 'sacral, consecrated', or better yet, as 'extremely holy'. It implies that Manaek had attained a status equivalent to that of a *puang*. This is the reason that she bears the epithet of *Datu Baine* (Goddess or Princess, the title by which she is addressed during the *mantaa' bati* (see Vol. II and this Vol., IV.6.1). *Kandean saratu'* means a hundred dishes or hundred eating bowls. In English *undundui kandean saratu'* is roughly equivalent to 'to touch the hundred eating bowls with the lips'. This means that one is allowed to take food from all dishes except that of a slave. For a *puang* this signifies such degradation that he eats from the plate of a *to makaka*. Applied to a *to makaka* of high birth, the expression implies that he eats from the dishes of a low ranking *to makaka* (cf. *Woordenboek*: 123). In the present story the *saratu'* indicates that Polopadang — like the Biblical Esau — yielded his rights of primogeniture and joined the ranks of the *to makaka*. Although the pure descendants of Manaek, through their *puang*-status, actually outrank the descendants of Polopadang, one scarcely notices any distinction in practice. However, objects which are associated with Manaek have a sacral tint. This is especially the case with the product of her hands known as the Unfinished Cloth (*Tannuntangmangka*) discussed in chapter VIII section 3.

VI.2.2b *Polopadang and Deatanna (told by B. Sarungallo)*

One day Polopadang was walking through a maizefield when he saw a lovely woman with very light skin.²⁹ Her name was Deatanna, and she had just climbed down to earth from heaven along a rainbow. Polopadang seized her. Startled, she cried out, "Earthling, why do you make bold with a goddess like me?" "I heartily wish you to be my wife", Polopadang said, "for you are so beautiful." But Deatanna replied, "I refuse. I am a goddess and you are a mere mortal." Polopadang, however, would not release her. Finally Deatanna yielded on the condition that he promised never to speak vile words. This promise he gave her.

From the marriage of Deatanna and Polopadang a son was born. His name was Pairunan (Paerunan). One day Pairunan was playing

with the golden top which he had received from his father. The toy bumped against his father's shin so that Polopadang uttered a few curse words. Directly Deatanna said, "Your father has used vile language, so now we will leave this house and this world". She had hardly finished speaking, when a rainbow appeared; Deatanna, her child in her arms, mounted to heaven. Polopadang saw her fade from view. He, too, tried to ascend but fell back to earth. He grieved over them deeply. With stratagems of every sort he tried to reach his wife and son, but to no avail. Then he tried another way: he wanted to climb on high via the horizon but this too miscarried. Weeping and miserable he squatted on the beach. Then a white buffalo approached him. Tedong Bulaan (= White Buffalo) was his name. The shaft of a bamboo spear protruded from its back. Someone had stuck it there to chase the animal from a forest. The buffalo drew near and asked Polopadang, "Why are you weeping?" Polopadang answered that he was in search of his wife and child who were in heaven but that he had not succeeded in meeting them. Then the buffalo replied, "Pull the spear from my back and I will bring you part of the way to your destination". Polopadang did what was asked of him. Then the agreement was made that his descendants would not consume the flesh of white buffaloes; those who did would contract scabies.

The buffalo then carried him to the horizon. Here he dropped Polopadang who once again broke into tears because he could go no further. Then the sun said that he was willing to come to his assistance, "but I am too hot, you cannot climb up along me. I will ask my younger brother, the moon, to help you". Happily the moon too had compassion for Polopadang, and with the help of this celestial body Polopadang could reach the upperworld. Here he encountered a slave who was drawing water from a well. Polopadang inquired for whom the water was intended, and the slave answered him, "For Deatanna and her son". Then Polopadang asked him, if he might drink from the water he had just drawn. Unobserved he dropped the golden top which he had brought with him into the bamboo (with water).

When Pairunan took a bath, the top appeared. He cried out, "The top, my top!" At first Deatanna would not believe that it was indeed Pairunan's toy, but finally she decided to interrogate her slave. "Perhaps Polopadang has managed to reach heaven", she said then. The next morning Polopadang went to his wife. Deatanna's servants asked him what he had come for. "I want to see my wife and my son Pairunan". The servants went to Deatanna and returned with the

message: "You may see your wife and child provided you carry the water needed for today in this basket". This was an impossible task because the basket was loosely plaited. Then Polopadang sat down on the bank of the river and burst into tears. An eel poked his head out of the water and asked him, "Why are you crying?" Polopadang answered him, "I have to haul water and must carry it in this basket. Since this is more than I can do, I will never lay eyes on my wife and child again". Then the eel wove its body through the openings in the basket so that no water could leak from it. Ever since, for the descendants of Polopadang, the eating of eels has been taboo.

But Polopadang had not reached his goal yet, for a second task followed. The servants informed him that before sundown he had to divert the water from a spring to the yard of Deatanna's house. He made a start at the endless task, but he soon sat down and broke into tears. A *serangkak* (?) happened to pass by and asked, "Why does the man cry?" Polopadang explained to him how matters stood, whereupon the *serangkak* summoned his friends who together with him carried out Polopadang's work.

Once more, however, he was not permitted to come face to face with Deatanna. A new task was announced: before the day was over he had to fill four baskets with maize, grain by grain.³⁰ This time mice came to Polopadang's rescue, however, the people were still unwilling to part with Deatanna (it is not clear who is meant by "the people": the inhabitants of the upperworld? Deatanna's relatives?). A further labour followed: before the day was over, he had to eat an entire field of sweet potatoes. Now wild pigs kept Polopadang from failing. Then a final task was set forth: in pitch darkness Polopadang had to point out his wife and child in the midst of a vast crowd of people. This time a cat and a firefly helped him out. The cat, miauling, sat in front of Deatanna, and the firefly alighted on her hair knot. Thus Polopadang could point out his wife and child. He received permission to take them back with him to earth where they enjoyed a long and happy life. (See also Radjab 1950, story no. 17, pp. 108-116.)

VI.2.3 *The to manurun in Riu*

(Suloara' and Lando Rundun: the genealogy of Riu, as recounted by the *to minaa* in that region, 1970)

After the institution of the rules concerning the *kapa'* (the fines imposed upon divorce which go along with class divisions), the Riu

people celebrated the first *maro*- and *bua'*-ritual. Puang diRano, the son of Banggai diRante and Rangga Uai (see VI.1.2a), married Datu Lino; for the marriage he journeyed to Lino, a village or area which my informants, the *to minaa*, were unable to locate exactly (Lino actually means the visible world, the world of men, this world).

The couple had four children:

1. Pong To Minaa (the first *to minaa*);
2. Sangga diOlang;
3. Datu Nangka;
4. Marambio Padang (Marampio Padang). In many parts of Tana Toraja he appears in a myth which tells of the exploits of a thief from the underworld, sometimes disguised as a pig (cf. VI.4).

Pong To Minaa went from Lino to Rura; he took the 7,777 *aluk* (*adat*-precepts, rituals) with him and performed a *bua'*-feast (remarkable because the presiding priest at the *bua'*-feast is not the *to minaa* but the *to burake*). Sangga diOlang went to Olang somewhere in the south (Palopo?). The two remaining siblings stayed in Lino.

Pong To Minaa married Datu Rura. From this match Londong diRura was born (at this point the *to minaa* related the story of the incest committed in Rura; see VI.3). Londong diRura drowned, and with him the two children whom he wanted to marry each other.

Pondan Padang (Marampio Padang) abided by the instructions concerning the rules of marriage. He had one child, Puang diLino, who took Buen Manik for his wife in Rura. They had eight children:

1. Pabane', who went to Kesu';
2. Paiiri, who journeyed to Matampu' (the west);
3. Pasonti', who settled in Kabutuan Allo (the east);
4. Pong Saban Ranga, who traveled to Sinadi (the name of a high mountain in Duri);
5. Padarra went to Rappan (Rappang);
6. Beka'-beka' and
7. Bara Dondi remained in Rura;
8. Pong Rumase went to Palopo.

Pabane' took the 7,777 *aluk* with him to Kesu' where he married Ambun diKesu'. In Kesu' the most celebrated of their offspring are Polopadang and Manaek. Polopadang (Polo Padang) stayed in Kesu', Manaek resided in Nonongan. The other children of Ambun diKesu' and Pabane' scattered:

Petimba Bulaan made his home in Sangalla';
 Malulung Sandi migrated to Rangri (?) in Sangalla';
 Pata Langi' went to Tikala;
 Takia Bassi to Angin-angin;
 Pong Songgo lived in Tadongkon, Kesu';
 Amba Bunga dwelled in Ma'kale, Pangarungan in Tallunglipu;
 Tengko Asik in Barana', Tikala;
 Palairan went to Tagiri on the Sesean and married Kiding Langi'. This pair had three children:

1. Seredadi;
2. Bongga Tonapo;
3. Pong Sanda Bulunna.

Seredadi married Bai (Pig). Their children were Datu Manoting, Karaeng Dua and Tali Siba'ba. Datu Manoting stayed in Karua, Karaeng Dua set out for Palopo, Tali Siba'ba for Duri.

Bongga Tonapo married Datu Banne. They had three children:

1. Lambe' Susu, who went to Salokan (Riu);
2. Patieng Boro, who went to Buntu (Riu);
3. Bongga to Salu, who departed for Salu (Kesu').

(At this juncture a summary followed of the important ancestors of the Toraja elsewhere, e.g. Karasiak in Madandan, etc.)

The most significant information concerning the history of Riu has to do with the descent of Lambe' Susu ('Long Breasts'). She married Salokan. The child of Lambe' Susu and Salokan was Lando Rundun, the beauty of the Sesean with the long hair, who married a prince from Bone. In brief the tale runs as follows: Lando Rundun, a beautiful 'princess' was accustomed to bath herself in a spring (this source is still exhibited to visitors). One day she lost one of her hairs which was washed by the current down to the lower reaches of the Sa'dan River. Here a Buginese prince discovered the hair. He was impressed by the length of the hair which could only have belonged to a beautiful woman. He proceeded upstream until he found Lando Rundun (*lando*: long; *rundun*: letting the hair hang loose as, for example, after bathing). She, however, did not immediately agree to become his wife: the prince had to perform many feasts before he could call her his own. For this tale see Van der Veen 1979: 1-17.

Lambe' Susu, after divorce from Salokan, married Emba Tau. From this union Suloaara'³¹ was born, the renowned ancestor of the Sesean-ramages which inhabit the mountain region. He had a number

of male siblings some of whom went elsewhere to live. In this context Marimbunna is of importance. He went to Tikala. He almost was vanquished in the war against the Bonese. Suloara', however, did not suffer any defeat. Marimbunna then summoned a meeting. He proposed to unite forces with Suloara'. As allies they renewed the struggle against the Bonese under the leadership of Suloara'. Bone was defeated. Again a meeting was convened. Here Suloara' (Riu) was acclaimed as *ambe'* (father), Marimbunna (Tikala) as *indo'* (mother), a duality thus with a male and a female in power.

When Tikala celebrates a mortuary ritual, the heads of the buffaloes are sent to Riu; when Riu celebrates, then the heads go to Tikala. This exchange takes place between *tongkonan* which are each other's *sibali*.³²

VI.2.4 *The arrival of the ancestors from the island of Pongko'*

According to Toraja myth, their ancestors left heaven in the dim past to land down on the island of Pongko' ('Round Earthmound'; also called Kalebu' = Small Hill). This island lay somewhere to the north of Sulawesi. When the inhabitants of Pongko' heard that an enemy from the west was nearing Pongko' with a fleet of proas, the island ruler summoned a meeting. One of his army commanders offered to try to defeat the enemy. He did not await the arrival of the hostile fleet, but launched proas to meet them at sea. On their way the defenders were hit by a storm. Their eight proas (*lembang*) swerved from their course and finally came ashore at a deserted uninhabited region near the mouth of the Sa'dan River. The people aboard the proas then followed the course of this river until at length they arrived in Rante Bulaan, the Golden Plain. From here they set out for Limbong and Rura. The latter village is in Duri: it is the setting for the ensuing myth (see VI.3).

In part the myth is supported by prehistoric artefacts found throughout the Duri region, i.e. coffins of the same type as those found in Tana Toraja. These sarcophagi are no longer used at present. Also mention should be made of the fact that the Duri are looked upon as Islamized Toraja. The form of government of several federations in this area bears a strong resemblance to those of the *puang*-regions in Tana Toraja (Tideman 1933: 359, 467).

VI.3 **Myths concerning the consequences of incest**

The most important myth in this context is that of the drama of Rura. We follow the version as narrated by B. Sarungallo (1969). The events took place at a time when heaven and earth were still

connected by a ladder. There were two brothers, Londong diLangi' and Londong diRura (*londong* = cock, or, in poetic diction, man). The former was unmarried, the latter was married and had four children, two boys and two girls. When these reached maturity they sought for marriage partners but there were no people with whom they could wed (or, if such people existed at all, they were perhaps of too low standing to marry them). The four siblings wondered whether there wasn't some way out of their quandry and they resolved to send two slaves, Pong Maleleong and Pong Datu Bakka', to Puang Matua to ask whether they could possibly marry among themselves. Both slaves set off, but under way they thought better of it and took counsel with each other. Should Puang Matua give them negative answer, there would surely be no marriage feasts. Therefore they retraced their steps and reported to their masters that Puang Matua had granted his consent to the brother-sister marriages of the brothers with their sisters. Now preparations were made in Rura (situated in Duri)³³ for a great *la'pa' kasalle* (*bua' kasalle*)-feast. Singing and dancing were to take place and a *burake* (priest) would officiate. The celebrants, however, were afflicted by the wrath of Puang Matua: a mighty flood inundated the whole site of the feast and whoever was there drowned. The two slaves and Londong diRura also perished. Only Londong diLangi'³⁴ was spared. Puang Matua decided then to summon Londong diLangi' to heaven. Londong diLangi' came and inquired why he had been called: Londong diRura was already drowned, wasn't he? Puang Matua answered that he was about to sunder the connection with the earth because he was unwilling to be involved further in the affairs of the earthlings. First, however, he gave Londong diLangi' four nuts of the betel palm: one of the four was still whole, one was in halves, a third in quarters and the last was split into eighths. "Take these nuts with you, plant them and see which germinate." After Londong diLangi's departure, Puang Matua overturned the celestial ladder; the remains of this ladder are not in Duri, but in Kesu', in the form of the Sarira rock-complex.

After his return to earth, Londong diLangi' planted the nuts. The whole nut did not come up, which implied that marriages between brothers and sisters were not allowed. The second nut did sprout, however, signifying that marriages between first cousins, *sampu pissan*, were permitted. The third and fourth nuts also germinated, which meant that marriages between *sampu penduan*, second cousins, and between *sampu pantallun*, third cousins, were permitted.³⁵

In this myth a few points stand out: the incest committed takes place between brother and sister, thus not between father and daughter or mother and son. The story is the mythic foundation of marriage regulations on earth which obtain for relatives of the same generation, and — this point is less obviously made — of the same class.

The slaves are in large part responsible for the punishment; their meddling contributed to the severance of the link between heaven (cf. VI.4.2a, the tale of Pong Sumbung Sare Pio, the poor man, who caused the overturning of the celestial ladder by stealing Puang Matua's flint and steel). Puang Matua appears as a punitive god, a role otherwise consigned to the gods Tandiminanga and Pong Lalondong in the underworld. Having meted out punishment, Puang Matua no longer interferes with mankind (but see p. 119 for the argument that he did not become a *deus otiosus*).

For a different version of the deluge in Rura, see Kruyt 1923/24: 95-97. Still another version comes from Dr. H. van der Veen which is here summarized as follows:

Londong diLangi's son was going to marry his own sister. Pong Maratintin, the Teller of Lies, was sent by the parents of the young couple to ask Puang Matua if such a marriage was allowed. First Puang Matua split a betel nut into halves and said that a marriage of this order of relationship (i.e. between brother and sister) was not permissible. Then he broke one of the two halves down the middle and declared that a wedding between partners so related, between first cousins thus, was not permitted either. Only if the two were second cousins a marriage could be contemplated. The devilish Pong Maratintin, however, wished to disrupt good order on earth and reported to Londong diLangi' and his wife that marriage between brother and sister was permitted. The wedding feast was celebrated. The wrath of Puang Matua swept down upon the place of celebration. The connection with heaven was severed. The 'Golden Age'³⁶ passed away. The rice no longer grows as it should and is exposed to crop failure. Plagues strikes the livestock so that it no longer multiplies in abundance; and diseases is the scourge of mankind.

VI.4 Miscellaneous myths

VI.4.1 *Ulelean*; introduction

In many *ulelean* the heroes and heroines, poor at the outset, achieve prosperity: they acquire *sawahs* and buffaloes and they themselves,

or their parents, are entombed according to a death ritual of high order. Whereas European tales of this genre prefer a good fairy in the role of the sender of wealth, the Sa'dan tales have the poor protagonists being helped by the rice who is transformed into a person (Van der Veen 1924c: 2-4) or by animals: the cat, a ricebird, the dog, a monkey, the rat, the eel, etc. When the rice acts as the rescuer, the *ulelean* are frequently told at the time the rice is ripening. Another important helper of the poor is the buffalo. In these folk tales he is Sokko Mebali, or Sokko Remak, a buffalo with horns curving down (a trait which the Toraja appraises as ugly). He is the symbol, as it were, of poverty and low status, but he can speak, a gift which even the most costly buffalo in the society is not able to match. Through the medium of this buffalo its poor owners, a girl in the tale of Babu' Solong, a youth in the story of So' Patelang, compile vast riches.

The *ulelean* are for the most part tales of the Cinderella-type. Another favourite character in the stories is Pottala, the Toraja Till Eulenspiegel. The Cinderella theme recurs in the tales of Saredadi (Radjab 1950, Tale no. 14), To lao Mepare, To Ma'bone, Seba Sola Pia biung (Van der Veen 1924c: 2-4), Babu' Solong, So' Patelang, Tonggo (The Very Good) Sere Tapong, Sere Dodo and To Kalala', the Poor (Van der Veen 1924c).

Sometimes the names of the heroes and heroines in these narratives refer to their scanty clothing: Sere Tapong, 'The one who wears a torn sarong of *akan*-fibers'; Sere Dodo, 'The one whose sarong is tattered'; Babu' Solong, 'The one who uses an areca leaf-sheath for a back covering' (instead of a mat braided from rushes). In other *ulelean* the protagonists are misformed. On occasion the poor heroes are aided by *deata*, gods and goddesses. This happens, for example, in the stories of Tonggo and of To Kalala'.

The *ulelean* reflect the Toraja wish-dream: many buffaloes, full rice barns, etc. The 'table-be-laid'-motif, in which the role of the donkey is played by a cock or a buffalo who makes all wishes come true, occurs with frequency. Also elsewhere in Indonesia, the cock and the buffalo are wish-dream fulfilling agents. The poor and the orphans who come into wealth can be regarded as figures poised between 'poor' and 'rich', as 'social mediators' in the sense which Lévi-Strauss attaches to the term (Lévi-Strauss 1967: 223).

VI.4.2 *Tales of thievery and the underworld*³⁷VI.4.2a *The tale of Pong Sumbung Sare Pio* ('He who wears a loin cloth of stitched-together rags')

Formerly the earth was connected with heaven by a ladder (Eran diLangi' = celestial ladder). The foot of the ladder stood in Rura (see VI.3). People who had something to ask of Puang Matua or the *deata*, climbed up the ladder. Once Pong Sumbung Sare Pio (the name suggests a poor person) climbed the ladder and stole the flint and steel of Puang Matua. In anger at the theft, Puang Matua kicked down the ladder. It came to earth in pieces. The far end of it is the Sarira, a ridge of mountain peaks running through Kesu', Rantepao and Ma'kale (the name *Sarira*, or, better yet, *Tindak Sarira*, means Rainbow).

After the ladder had been shattered, it happened that a child of Londong diLangi' in Rura fell ill. In despair the child's mother cried out, "How can I go to heaven now to ask Puang Matua for medicines to cure my child?" Then Puang Matua let a *tille*-stalk fall to earth and said, "Use this in place of the celestial ladder". (Told in: A. C. Kruyt 1923/24: 160-161.) The myth is known in a number of versions. In some of them Pong Sumbung Sare Pio is called Pong Sumbung Pio Saratu', 'He who has sewed together one hundred shreds of loin cloth'.

VI.4.2b *The myth of Marampio Padang*

When mankind began to settle on earth, their guide on their way was sacrifices, they determined the domain of the village all around. A start was made at cultivation, the *kaise'*-shrubs grew in rows (*kaise'*: a shrub with red fruits). Then there came the child of someone from the underworld and took fruits away. Marampio Padang saw that his *kaise'*-fruits were few by night and many by day. He borrowed the lance of Datu Nakka'. Marampio Padang stabbed the child of someone from the underworld. Datu Nakka' looked for his lance, he saw it no more.

Marampio Padang offered buffaloes and *sawahs* and pure gold, but Datu Nakka' refused these. Datu Nakka' held him responsible, and made a demand which could not be fulfilled. Then Marampio Padang went to collect a fortune-giving liana and a rattan with converging axils.

Marampio Padang made a basket. Sampurari opened for him the layers of the earth which lie on top of each other and Marampio

Padang moved along the rope, using the basket as a ladder, descending to the underworld.

There he arrived in the upper branches of a mango-tree. He heard the sound of the drum of the people of the underworld. Then Marampio Padang said, "For whom is the drum being beaten?" A buffalo-herd answered, "For the child of Pong Tulak Padang that was stabbed above in the sky. Many medicine men have tried to cure him, but the child has not recovered". Marampio Padang said, "Bring me to the child". The buffaloherd said, "Give me mangoes, then I will bring you there".

Upon arriving at the village Marampio Padang said, "For my part, when there are no longer any people above in the house, then I will begin applying my medicine". When he had gone up in the house, he passed the flat of his hand several times across the child's body and then pulled the lance out. The princely body of the inmate of the underworld, it arose in well-being and went up to the river bank, as healthy as usual. Payment for Marampio Padang was proposed to him. He said: "A fit reward for me would be for you to perform that which brings blessings".

Then they placed the offering on the altar; everything contributing to the beauty of the sacrifice was laid on the altar. Marampio Padang saw it and said, "That now is my payment: the beauty of the sacrificial ritual". He asked and said: "What is planted of the bananas over there?" They replied: "The trunk of it". Marampio Padang asked again: "And of the sugar palm?" He was told: "The fruits of it are planted".

Marampio Padang again inquired: "And the *cedana*-tree?" (sandalwood; Toraja: *sendana*). People said, "The branches are cut off and stuck into the ground".

He asked once more: "And that slender bamboo?" They said, "The rootstock is planted".

He went on asking, "What is that which makes a noise there?" People answered and said: "The drum". Then Marampio Padang said, "Let all that be my payment!"

Marampio Padang took the payment and placed it in his basket. He returned by the rope, repeatedly beating his drum.

The inmates of the underworld said: "He came to cure what his hand had misdome". The plants which come down from heaven by now have congregated with the plants which appeared on earth. Marampio Padang returned the lance to Datu Nakka'.

Marampio Padang went to tap palm wine. Rain started. Now Datu Nakka' ripped off one of the leaves of Marampio Padang's tree. Then Marampio Padang said to Datu Nakka': "Give me my leaf back; your lance, didn't I also return that to you?" Datu Nakka' returned it but the leaf had already wilted. Datu Nakka' offered his possessions, but Marampio Padang refused them. His own person Datu Nakka' offered. And Marampio Padang began to use Datu Nakka' as a slave for doing work in the *sawahs*. Marampio Padang was a generous man; he called him his child.

Marampio Padang than perished the cycle of his rites: the feast of the sacrifice of a pig in the house, the sacrifice on an altar, the *merok*-feast, the rites of the *maro*-feast during which a bamboo-shoot is inserted into the ground. They all serve for protection; thereafter the *bua'*-feast was celebrated.³⁸

We learn from the story that the underworld is not as bad as the word suggests. In our culture the term has gloomier connotations than among the Toraja. The latter believe that various cultivated plants originated in the underworld and also that good relations can exist between the people on earth and those of the world below.

Different versions of the story of Marampio Padang have come down to us.³⁹ In the version above the thief is a child from the underworld, in other versions it is a pig. This pig then is the counterpart of the pig created in the upperworld. The *sendana*-tree from the underworld is the counterpart of the heavenly sandalwood tree mentioned in the *Passomba Tedong* (Merok: 152-153). The mango-tree in the underworld has also its pendant in a celestial tree. The sugar palm which originated in the underworld can be recognized by the fact that its branches on the left side point downwards; next to this there also exists an *Arenga saccharifera* which derives from the upperworld (Merok: 91). The healing of Pong Tulakpadang's child in the underworld finds a parallel in the cure wrought by Indo' Belo Tumbang in the upperworld when Puang Matua's child Banno Bulaan, 'The Golden Ricewater', was sick (Merok: 142-143, verses 726ff.).

Marampio Padang's descent into the underworld is the reverse of mankind's most serious ambition, i.e. contact with the upperworld. Yet, it also is a complement, a counterpart even of man's efforts at communication with the upperworld. In ritual, however, no attempt is made to act out such a descent into the underworld, for such an

endeavour would jeopardize the priest by its associations with death. The kingdom of the dead is reached by a hole in the ground.

VI.4.3 *Tulangdidi' and Bulu Pala'*

VI.4.3a *Tulangdidi'*

Tulangdidi' was weaving beneath the house when her father's dog came and soiled her work. Then she struck the dog with her 'sword' (the weaver's beam; Toraja: *balida*) so that he died. She carried the dog to the side of the house and covered him with a mat. A crow told the news to her father. Seeing that his dog had been killed, he asked who had done this. Tulangdidi' said it was she. Then her father said that he would have Tulangdidi' die together with the dog. (Note: the dog was already dead; probably we should read *like* the dog.) Her mother gave her a chicken egg with uncooked rice (*barra'*). They went out; then her father said, "Here I will kill you". She said, "A little bit farther north, there where the pigeons gather and the birds come together". Having journeyed upstream, her father said: "Here". She said: "Wait, I'll first go and relieve myself". Then Tulangdidi' added a pigeon egg to the chicken egg she had. When she came back she said, "Hack me, please, through the middle".

Thereupon Tulangdidi's father struck her square down the middle. A pigeon came out of the egg; it pecked open the chicken egg. When the chicken (cock) was full grown it collected the maggots from Tulangdidi's body.⁴⁰ The cock of Tulangdidi' fulfilled the task of the *to ma'peuli'*, the female slave who removes maggots from the corpse (cf. Vol. II), an act of purification making part of mortuary rituals of high order. Here again the cock is intermediary between under- and upperworld. Having gathered them, the cock said, "Live again, Tulangdidi' " (Van der Veen 1924/25: 71-72). Thus she was brought to life, went to live in the woods and accumulated great wealth because the cock made buffaloes, rice, etc. appear by magic. Someone informed her parents that she was still alive and had come into wealth. They wouldn't believe it. However, they paid the girl a visit. Tulangdidi' treated her mother better than she did her father. She gave him his food in a cat's bowl and had him presented with an empty limestone cylinder. When her father wanted to shake some chalk out of the case, the floor caved in. After he had fallen through the floor, Tulangdidi' told her buffaloes to kill her father. He was trampled to death and buried under buffalo dung. When, later, her mother died, she was interred with pomp.

Once upon a time people were busy pounding rice. Tulangdidi's cock was struck by a scoop used for dishing out pig fodder.⁴¹ He flew to heaven with Tulangdidi' holding onto his tail feathers. "Let us fly to the moon", the cock said. There Tulangdidi' still remains, known ever since as Indo' Sadenna or Indo' Samadenna (translated as: Mother Everything in Hand, Mother All there is; Merok: 71, verse 348).

In the *Passomba Tedong* Tulangdidi' is one of the daughters of Pong Banggairante. According to another version of the story, Tulangdidi's cock changes into a constellation (Manukna Lapandek or Londongna Tulangdidi'). When this constellation appears in the sky, the Kesu' (Rantepao) farmers begin to sow their rice. On this occasion a chicken is sacrificed (Van der Veen 1924c: 69).

What we are dealing with appears to be a moon-myth (the weaving Tulangdidi'; Tulangdidi' cut in half). Another connection is that of Tulangdidi' with the cock and the rice. The astral aspect emerges in the following poem:

"Indo' Sadenna has a golden spinning wheel which she uses
as a stick,
What has been mixed she takes for her share, the cock of
Lapandek,
They follow each other to the moon on high,
spurring each other on, the seasons have their meeting,
Whereby they pay attention to the waning and the waxing
of the moon."

(Transcribed and translated into Dutch
by Van der Veen 1924c: 69)

The cock is Tulangdidi's companion who has brought her riches:

"The fowl of Lapandek, the cock of Tulangdidi'
these full grains of sowing-rice are now being sown,
that speckled of hue, on the golden mat
playing with the richly flowing well water;
Let (the crop) be protected,
Let not its roots knock against anything,
so that (the crop) may rise on high,
whose young shoots do not die."

(Translation from Van der Veen 1924c: 69)

The two fragments of poetry here reproduced in their logical sequence appear in the original in reversed order. I cannot explain why. The poem as such is a litany recited before sowing the rice seed by the *to indo' padang*, the rice priest. The litany confirms the importance of Tulangdidi' and her cock for rice cultivation.

Londongna Tulangdidi' or Manukna Lapandek, the Cock of Tulangdidi' or the Fowl of Lapandek (a place in the *puang*-regions, Tallulembangna), is a constellation used in scheduling the phases of the agricultural year (Van der Veen 1924c: 70).⁴²

The translation of the name Tulangdidi' is difficult. Van der Veen regards 'The Upright Yellow (One)' as an accurate attempt, a name moreover which is perhaps a reference to (ripe) rice.

For additional versions of the myth of Tulangdidi' see Radjab 1950: 104-107 and Van der Veen 1924c: 69-73).

VI.4.3b *Bulu Pala'*

Because this tale is in many regards a counterpart to that of Tulangdidi', I reproduce it at some length (after A. C. Kruyt 1923/24: 310ff.).⁴³

There once was a father with seven sons who lived on the mountain known as Lapandek near Mebali. (His house, stable and other property which belonged to him can still be identified at this location.) The youngest son's name was Bulu Pala', 'Hairy (Hand)palm'. "This boy", so his father said, "might bring misfortune". But many people who saw the child said: "This child is good". As a consequence the father began to love his youngest son more than his other children. Therefore the boy's brothers grew envious of him and decided to murder him. One day one of the brothers said, "Father has died, come let us dig a grave in which to bury him". When the brothers had prepared the grave, they asked Bulu Pala': "Be so good as to see whether by now the grave is large enough for father". Bulu Pala' lay down in the grave and stretched himself out. His brothers then hurriedly poured earth on him and buried him alive. The dog and the cock of the boy, however, dug their master free. (The cock, it is reported, was an extraordinary animal for he could give his master everything the latter desired: a buffalo, a pig, a house, whatever he wished.) When the boy who was supposed to be dead returned among his brothers, they wondered at his reappearance, but their hate for him remained unabated. One day they said, "Father is dead, let us go to cut wood to make a coffin (*duni*) for father".⁴⁴ When the coffin was prepared, they said, "Brother, lie down in it, so we can tell whether it is large enough for father". Bulu Pala' did what was asked, but as soon as he lay in the coffin, his brothers shut the coffin, bound its planks together and tossed everything into the river.

The river flowed rapidly and bore the coffin out to sea. The dog

and the cock were left behind. Since no one gave them anything to eat any more, the cock wanted to peck at the fodder that the brothers gave to the pigs, but one of them gave him a blow so that his wing broke. The cock now went to find his master to complain but look where he would, he could not find him. He searched by the river and questioned the current: "Have you seen my master?" But the current replied that the previous day his master had floated past and by now was certainly very far away. The cock, in the company of the dog, made his way downstream and when they arrived at the mouth of the river they saw a wooden coffin floating there. The cock flew to it and perched on top. He managed so to scratch and to rock that the coffin drifted landwards and ran aground. (Kruyt 1923/24: 311).

The dog pulled the coffin ashore and bit through the ropes. His master sprang out alive. Bulu Pala', who had developed a dislike for his brothers, built a house in a lonesome spot. After some time he told both his companions that he wished to go to heaven. The dog was unable to follow him there and dug a hole in the ground that served him for shelter. The cock went along with Bulu Pala'. Before his master departed for heaven, he promised the dog to give him a sign when it was time for him to come out from his lair. "When there is much thunder every day and the winged white ants come out of the earth, it is the dog of Bulu Pala' who was changed into the larve of the white ant (the termites). Everyone can see Bulu Pala' and his cock in the sky; they are carried in a palanquin." (A. C. Kruyt, loc. cit.) Apparently the constellation of and around Orion is here referred to.

Radjab gives a somewhat different version (1950: 18-36). He heard the tale from the late Puang Lasok Rinding of Sangalla'. In this narrative Pong Bulu Pala' is already a married man when his brothers deceive him in the manner described above. The wife of Bulu Pala' is the daughter of a man in whose house Bulu Pala' has been a guest. In this house he received his cock and his dog as gifts, the cock who brought wealth and who apparently aroused the jealousy of Bulu Pala's brothers by its ability to provide their younger brother with everything desirable. Yet, even before this the brothers were so hostile that they had twice tried to have Bulu Pala' be trampled by buffaloes. This plot went wrong because of the recalcitrance of the buffaloes who spared Bulu Pala's life. In the myth as told by Puang Lasok Rinding of Sangalla', mention is made of three-eared rice. It originated

in heaven and was carried away by the protagonist of the tale.

In this version of the story Bulu Pala's father worries greatly about his son to whom he is deeply attached. The boy's mother has a bit more prominence in the proceedings, for she gives birth to Bulu Pala' in an extraordinary manner: he is delivered from the palm of her right hand. He grows astonishingly fast and already speaks to his parents while he is still being carried about; the gist of his speech is that his parents must take good care of him and not abandon him to his fate. He had not appeared on earth to do wrong, or spread evil, but to dispense welfare and prosperity to all living things. Oddly enough, after these words he did not speak again for a long time. Besides, he was extremely precocious and could already herd buffaloes when he was one year old. In this version it is Bulu Pala's wife who, together with his dog and cock, rescues him from drowning by freeing him from the coffin. Finally, the cock and Bulu Pala' go to heaven, and his wife and dog are changed into larvae of white ants.

The two narratives resemble each other closely; it only needs to be added that Radjab's version takes place in Papanura near Duri. The parallelism between the Bulu Pala' myth and that of Tulangdidi' is striking in spite of differences between them. In the schematic comparison on page 171 we stick to the two versions of the Bulu Pala' tale here reproduced.

In spite of a few basic differences (good versus bad father, bad versus good dog) the overall agreement of the two tales emerges vividly. Tulangdidi' and Bulu Pala' could well be the female and male aspects of one and the same being, some sort of rice-, agriculture- or fertility-deity. The cocks of Tulangdidi' and that of Lapandek (B.P.) are almost identical. They are often mentioned in the same breath (see Merok: 30-31). The cock of Lapandek is said to be Orion. In the myth as related by the late Puang Lasok Rinding of Sangalla', Bulu Pala' and his seven siblings are the constellation of Orion. Pong Bulu Pala' drifted downstream in his coffin, the direction of the ancestors, the *to matua*. In contrast Tulangdidi' asked to be interred upstream, the direction of the *deata* (gods and goddesses). This, too, can be an indication that the two protagonists are, as it were, each other's complement.

The one finally retires with his cock to a configuration of stars indicating the proper time to begin the cultivation of rice. The other finds refuge as the divine weaver in the moon, another appropriate

symbol of the agricultural cycle. The one gave his parents, shortly after his birth, the good advice to nurture him well because he would dispense well-being and success to mankind. The other became Indo' Samadenna, Mother of All there is.

TULANGDIDI'

BULU PALA'

Leading character

girl, woman	is killed (cut in half)	boy, man
	is buried and eaten by maggots	is buried, or put in coffin
	is restored to life by cock	is saved by cock and dog

Role of animals

dog	bad; killed by Tulangdidi' and placed under a mat	good; saves B. P. buries himself in the ground becomes larvae of white ants; (cf. Tulangdidi's identify with maggots)
cock	good; enriches; wing broken by people; ascends to heaven	good; enriches; wing broken by B. P.'s brothers
buffaloes	trample T.'s father to death	refuse to trample B. P.

Kinship relations

father	bad; kills his daughter	good
mother	good	good
brothers	?	bad; try to murder B. P.

Obsequies

father	trampled by buffaloes, buried in their dung	
mother	buried with pomp	
self	T. buried <i>upstream</i>	B. P. placed in coffin <i>down- stream</i>
	ascends to moon with cock	ascends to heaven with cock

VI.4.4 *Till Eulenspiegel tales*

The Till Eulenspiegel figure is prominent in the story of Pottala. His antagonist is Datu, a rich glutton, to whom he is in debt. In the

context of the story it is not of particular importance whether we take the *datu* (prince, master) to be the Datu of Luwu' or merely any wealthy Toraja. Let us assume that he is a well-to-do gentleman who went to Pottala's house to press for payment of the money Pottala owed him. Pottala had a premonition his creditor was coming. He prepared rice with a sauce which he had let simmer with an axe in it. The Datu found the sauce particularly tasty and asked for the recipe. Since Pottala was unable to pay off his debt, the Datu claimed the axe instead so that he could make the same delicious sauce at home. Yet, what he cooked remained just ordinary water. Once again he went to Pottala, handed back the axe and again pressed him for payment. Pottala promised to pay. He stayed at home, took his blowpipe and shot three ducks who were on the sea. Afterwards three wild ducks lay in the house, one in the central room, one in the southern part of the bedroom and one next to the hearth. Pottala roasted the ducks. When Datu came to be paid, a tantalizing odour greeted him. He claimed the blowpipe as repayment of his loan and Pottala gave it to him. Yet: no wild ducks from the sea ended up in Datu's house. Again he paid Pottala a visit. Pottala asked for a short respite to collect money others owed to him, so he could pay Datu.

Then Pottala gave his dog several coins to eat. Datu arrived at the moment that the dog shat gold and he demanded the animal. Yet, once Datu was home again, the miraculous animal turned out to be no wonder at all. Datu returned the dog, tied Pottala up and wanted to set him afire. (Burning a person is punishment for a major transgression.) First, however, he entered Pottala's house to eat. Meanwhile a hunch-back passed by and asked Pottala why he was tied fast. Pottala replied that he, too, once was a hunch-back and now was being straightened out. The hunch-back took Pottala's place. Datu came back downstairs and in blind rage kindled a fire which consumed the hunch-back, Datu believing that he was burning Pottala. Pottala went to clear a patch of wooded land. When that yielded proceeds he took them to Datu. Datu was astonished to see him. Hadn't he set Pottala on fire? Pottala answered, "After the Datu had burned me up, I met my ancestors". The Datu expressed a wish that he, too, be set on fire so that he could meet his ancestors. He ordered his *kaunan* (slaves) to fetch wood. The fire was ignited, he leapt into it and died.

The above story is borrowed from Radjab (1950: 98-104) and Van der Veen (1924c: 52-62).

It is possible to interpret the present folk tale, following Wertheim, as a form of social protest. Pottala is a good example of a lower class Eulenspiegel who dupes a rich aristocrat, a Datu or Lord.⁴⁵ Yet, another interpretation is possible, one hinging upon Pottala's name. Van der Veen (1924c: 59) points out that *tala* means sexually deviant, a man who acts like a girl or is feminine in appearance. The figure of Pottala is highly reminiscent of the *burake tambolang*, the priest considered to be an hermaphrodite (cf. chapter IX: Priest). He is, as it were, a pseudo-*burake*. The *burake tambolang* is a person who enjoys much respect in Toraja society: during the great *bua'*-ritual, it is he who makes contact with the upperworld; he is the priest of the rituals of the northeast which are associated with the *deata* (gods). Pottala, as a parody of the *burake*, comes from the diametrically opposed direction: he tells Datu that he has visited his ancestors (*nene'*) — these dwell in the Southwest. His report, moreover, is pure fabrication and belongs to the prank of hopes to ensnare Datu with. Who, then, is Datu in this interpretation? Rather than merely a rich, highranking man, he can also be seen as the personification of an important god of the upperworld.

Wertheim regards certain folk tale motifs as protests against the established order. This does not alter the fact that stories like those about poor orphans and people such as Pottala are current among all classes. Often they are tagged with a moral; at the end of the tale of The Congenital Cripple, for example, we hear:

“We then, we people, all of us, the high and the low alike, the rich as well as the poor, the prominent and the humble, When we are wealthy we must not say, I am rich and respected, how can anything ever stand in my way. Whatever I choose to do to these poor and lowly creatures, who would ever criticize me; for I am rich and respected. To behave like this, is wrong, because the fate of man is unfathomable. If you say that one there is inferior and poor, perhaps later he will become rich like The Congenital Cripple. And the rich man, may become poor in his turn.”

(Van der Veen 1924c: 10-11)

VI.4.5a *The myth of Pano Bulaan*

This myth was transcribed for the first time by Adriani and A. A. van de Loosdrecht. Below appears an abridged version in English of his original Dutch translation (*Mededeelingen van wege het Nederlandsch Zendelinggenootschap* 1914: 225-244).

Pano Bulaan (the Golden Skin Disease; *pano* is a skin disease causing the skin to flake off, a kind of fungus) was pregnant and went into the forest to find some sour fruits to eat (no commentary is offered; presumably these fruits served to satisfy appetitive desires arising from pregnancy). She tripped over a snake (a python) who, when she touched his head, wanted to swallow her. Pano Bulaan said that the snake might marry her (if he gave up the idea of eating her). The snake consented, whereupon Pano Bulaan said that she would put him into a hollow tree. This happened; the snake thereafter provided Pano Bulaan with food, and with golden krisses and golden jewellery (*rara'* = jewellery worn by upper class women).

When the moment that Pano Bulaan's child would be born drew near, the snake said that he would let the child live if it was a girl and that he would devour the baby if it proved to be a boy. Pano Bulaan gave birth to a son, Panggalo'-galo' (The Bold One), whom she concealed. The boy grew up and ordered shipbuilders to make ready an iron vessel for him. When the snake was off again scouring for food, the ship set out for the open sea with Pano Bulaan and her son on board. They had taken along the goods and jewellery. The ship was well-protected, for it was covered with swords and sharp iron.

The snake saw their departure and swam out into the sea. He pounced upon the ship but was cut into three pieces. The snake's head fell onto the iron proa; Panggalo'-galo' picked it up and the head turned to gold (what happened with the remaining sections of the snake's body is not reported).

The son then asked his mother what course to follow. She answered him:

“Look for the coconut palms standing in a row,
The areca trees stretching in a line,
Point your proa in their direction . . .”

Panggalo'-galo' struck out as his mother had directed. Then she told him to climb a coconut palm (which belonged to Pano Bulaan's plantation). When he had reached the top he heard a woman's voice: “Who is that? Who comes climbing the coconut palm of Pano Bulaan as if he were some god,⁴⁶ seeing that the owner has disappeared and the dishes have been shattered for her and the rice-pounders broken into pieces?” Panggalo'-galo' turned back and told his mother that he had been spoken to 'from above'. This repeated when he climbed up an areca palm (Toraja: *kalosi*).

Pano Bulaan then revealed to her mother — for, it was her mother who had reprimanded the youth — who she was and she introduced Panggalo'-galo' to his grandmother. Since Pano Bulaan's husband had remarried,⁴⁷ mother and son took up residence with the grandmother. First they celebrated the *merok*-feast and then the *manganta'*.

As the result of her skin disease which causes the skin to peel away, Pano Bulaan has some snake-like features. The forest, however, is not her true habitat: she comes from a village. She is of high status: she has a golden colour and receives jewellery (*rara'*) from the snake which is appropriate to women from the upper class.

Formerly, this story would have been classified as a moon myth: both the snake and Pano Bulaan with her scaly skin condition are mythical figures who shed their skins and thus renew themselves. The snake's wish to swallow Pano Bulaan and later her son can be interpreted as a mythical explanation of the phases of the moon. There is no certainty, however, that this is the true meaning of the myth. There are other features to be considered. The golden hue of the protagonist (*bulaan* = gold) is associated with the upperworld. The myth is portraying an opposition which plays a leading role in Toraja religion: life and death. Pano Bulaan escapes death by marrying the snake. The snake is presented as an animal that lives in the forest; Pano Bulaan sets up house for the snake in a hollow tree trunk, the place where the Toraja bury children who die before they grow teeth. The forest stands in opposition to the civilized environment from which Pano Bulaan originally comes.

In this story we can observe different phases of burial rituals: the 'interment' of the snake in a hollow tree; 'head-hunting', also a component of the ritual for the dead; the celebration of the *manganta'* and the *merok*-feast. Both these feasts can be of various import, but one of their ritual meanings involves conveyance of the dead from the sphere of the West to that of the East (the gods).

In the following subsection appears a second version of the story of Pano Bulaan. It differs from the first in several minor regards. We selected it not because of these differences but because in its unabridged form it is a typical specimen of Toraja narration.

VI.4.5b *Rangga Bulaan* ⁴⁸

In a certain country there once was a girl, *Rangga Bulaan* by name, who was the daughter of a rich man. She was pregnant, but not (yet) married. Her mother and father were very surprised when they noticed

that their daughter was with child although she had no husband yet. The mother and father were very distressed about their daughter because she could not escape from being punished and probably would be exiled. One day all the chiefs, village elders and notables came together to mete out righteous punishment to Rangga Bulaan which she had earned for her sin, a sin of great shame. Their decision was to drown her in the deep ocean, ban her from the country, and declare her dead. Then Rangga Bulaan was declared dead and her death ritual was held.

After some time it appeared that Rangga Bulaan who had been pronounced dead and for whom a death ritual had been enacted was in fact not yet dead. She came to life again. She floated on the ocean and was carried ashore by the current. Then Rangga Bulaan climbed onto the land. She saw no houses; she noticed that she stood near the edge of a dense forest. Rangga Bulaan was filled with sorrow when she thought of her fate. Where would she pass the night, where would she find protection and a place to sleep? Rangga Bulaan went looking for a place to pass the night and entered into the underbrush. She found shelter under an enormous tree. There she spent the night, just as if it was her own home. Every day and night she had nothing to eat but the fruits of the forest. How sad and lonely she felt in the thick woods. She thought about digging a well where every day she could bathe herself to her heart's content. So she dug a well under a tree. Now each morning and afternoon she could bathe as often as she wanted.

On a certain day while Rangga Bulaan was bathing as it pleased her to do, an enormous snake (*saa* = python) came slithering towards her, much to her alarm. She became very frightened and shivers ran up and down her whole body when she saw the snake, which was very huge. *Saa* spoke to Rangga Bulaan thus:

“Hé, heaven is closed, the earth is satiated,
 you, dear and lovely child of man,
 I will swallow you in one bite,
 I mean I'm going to kill you, child.”

Rangga Bulaan answered him thus:

“Your words are but all too true,
 heaven I will no more see,
 no more will I be able to lie on the earth,
 since I cannot fly away,
 do then what your heart prompts you to.”

Thereupon Saa spoke thus:

“I won’t devour you,
if you will marry me.”

Rangga Bulaan pondered a long while for it was difficult to reach a decision. She couldn’t do anything but agree. So it happened that Saa’s request to marry Rangga Bulaan was granted.

From that moment forth Saa and Rangga Bulaan were married.⁴⁹ They lived as husband and wife and had a nest for a house. Saa had made a nest in the jungle that he destined for the residence of Rangga Bulaan. As head of the family Saa had to go out from the nest to look for food and to accumulate riches in gold and silver. So time after time Saa went off in quest of food and wealth in order to bring them back to the nest as their property. The wealth consisted of gold and silver and the food were intended for them both.

When Saa noticed that his wife was expecting a child, he was very glad. He said to Rangga Bulaan: “If you bear a child and it is a girl, I will love her because she will be able to catch shrimps to feed me. But if the baby is a boy, I will swallow him, because if I let him grow into a man, he will turn against me and perhaps he will kill me”.

Rangga Bulaan replied: “I will obey you in all things, if only the child is delivered successfully. It is good that you collect food for us and wealth of gold and silver. In addition, you must look for many swords⁵⁰ for us so that we can protect ourselves”. Rangga Bulaan thought to herself, if the child turns out to be a boy I will conceal him until he is fullgrown. If Saa saw him, he would swallow him, skin and bones. But if the child grows up he can build for us a boat with a roof of swords.

She let Saa go off to collect food and to assemble wealth and swords. Saa remained away a long time to find food and amass riches. When he came back he brought food, wealth and swords into the nest that served Rangga Bulaan as a home. Slowly the wealth and swords piled up and all this was their property.

When delivery was about to take place, Rangga Bulaan once more sent Saa to search for food and to collect riches. Rangga Bulaan thought to herself, if I give birth presently to a boy he will be swallowed skin and bones by Saa, just as Saa said he would do.

Indeed, Rangga Bulaan bore a son. She gave her child the name of Panggalo’-galo’, ‘The Brave One’. How sad Rangga Bulaan was when she thought about how things stood. She said to herself, when

Saa comes back shortly and sees this baby, a boy, alas, then he will certainly swallow him. She conceived of a ruse and concealed the tiny penis of the baby so that it looked like a girl and Saa would not realize it was a boy.

Finally Saa came back from his expedition to find food and gold and silver and swords as Ranga Bulaan had asked him to do. When Saa saw that the child was born, he was very happy and said, "A little daughter, I will certainly love her dearly". Saa did not see the penis of the child because it was hidden. Ranga Bulaan said to Saa, "So you promised me when I was pregnant, if the child I bore was a boy you would swallow him but if it was a girl then you would cherish her truly". How content and full of delight Saa felt because his child was a girl that he would love truly.

Ranga Bulaan spoke to Saa: "Go off to find food for us and all kinds of wealth, but especially seek out more swords that we can use to defend ourselves". Ranga Bulaan further insisted by telling Saa: "It is good that you work hard to find food for us and gather wealth of gold and silver and swords to collect in our nest". Not long afterwards there were vast quantities of food and riches piled high in the nest inside the huge tree with the thick shrubbery growing all around.

At last Panggalo-galo' became larger and stronger. When Panggalo-galo' already was a big boy it was difficult to hide his penis. His mother hid the boy and when Saa asked, "Where is my child?", then Ranga Bulaan answered him, "She is at play". Panggalo-galo' was constantly concealed by his mother whenever Saa asked for his daughter. The food and wealth and swords which Saa had brought home filled the entire nest that was a home for them in the huge tree with the thick shrubbery growing all around.

Ranga Bulaan thought deeply, called her child Panggalo-galo' and together they reached a decision. She spoke, "Ah, my child, you have grown up now; if we do not flee from this place, the day will come when Saa swallows you. It is good if now you make a boat for us which you must equip with a roof of swords". When Panggalo-galo' heard the words of his mother, he set to work at once to build the boat and he made it with a roof of swords as his mother had requested.

Thereupon Ranga Bulaan sent Saa again to look for food and to gather wealth with the words, "Saa, go now to seek food and to collect riches for us so that they can become the property of our child.

This time you must stay away for months and only then return with the goods which you have assembled". Then Saa set off and he remained away for many months in search of food and for wealth as Rangka Bulaan had asked him. Only then could he return home.

Panggalo'-galo' was very busy making the boat so that it would be ready before the return of Saa. When the boat was finished, Panggalo'-galo' fitted it out with a roof of swords. When everything had been completed, Panggalo'-galo' spoke to his mother: "The boat you wanted me to make is finished and it is fitted out with a roof of swords the way you told me". Rangka Bulaan answered her son, "Good, now bring the boat to the edge of the sea and come back to fetch all the goods of gold and silver and the food as well to bring them to the boat. When you have done that, we will flee from this place before Saa comes back".

As soon as the gold and silver and the food were loaded into the boat, Panggalo'-galo' called his mother to come on board so that they could swiftly travel to the country of his mother. Saa, who had not yet come back from his travels in search of food and wealth, did not know that Rangka Bulaan and her child had run away. Panggalo'-galo' and his mother journeyed back to the land where she was born. In the middle of the ocean Panggalo'-galo' did not know what course to set to reach his mother's native country. He asked his mother what to do:

"O, my mother Rangka Bulaan,
who brought me into the light of day,
in what direction lies your land,
the land that is your home,
so that I will steer this boat there,
so that I will guide this vessel in that direction."

Rangka Bulaan answered him thus:

"O, my son Panggalo'-galo',
the country of your mother's birth,
her home is there
where *induk*-trees⁵¹ stand in a row,
where coconut trees grow next to one another,
steer your boat there,
in that direction steer your vessel."

Thus they journeyed further and further. A gentle wind conveyed them to the country of Panggalo'-galo's mother's birth. And all the while he kept speaking with his mother.

When Rangga Bulaan looked up, behind the boat she saw an object cleave the water. She became deeply afraid and Rangga Bulaan spoke to Panggalo'-galo' thus:

“My son, Panggalo'-galo',
whose boat is that which follows us,
whose vessel pursues us from afar,
is that not the boat of Saa,
is that not the boat from Koko,
perhaps he is coming to kill us,
perhaps he follows us to destroy us.”

Panggalo'-galo' answered his mother thus:

“Ah, my dear mother, Rangga Bulaan,
don't be afraid,
don't be upset,
his boat won't be like ours,
his vessel won't be like ours,
our boat has a roof of sharp swords,
our vessel has been roofed with swords for shingles,
reinforced with *oda-oda* blades.”⁵²

A short time later, while Rangga Bulaan and Panggalo'-galo' continued talking to each other in verse, the body of Saa suddenly rose from the sea and hurled itself upon their boat. The balance of the boat was hardly even disturbed when Saa's body landed upon it. There was no danger. The body of Saa was cut into pieces by the sharp edges of the swords which made up the roof of the ship. How sorrowful were Rangga Bulaan and Panggalo'-galo' when they saw Saa's dead body that was cut into pieces.

Panggalo'-galo' and Rangga Bulaan continued their voyage and Panggalo'-galo' asked his mother:

“O, my mother, Rangga Bulaan,
who brought me into the light of day,
in what direction lies your land,
the land that is your home,
so that I will steer this boat there,
so that I will guide this vessel in that direction.”

Rangga Bulaan answered him thus:

“O, my son, Panggalo'-galo',
the country of your mother's birth,
her home is there
where *induk*-trees stand in a row,

where coconut trees grow next to one another,
steer your boat there,
in that direction steer your vessel."

So Rangga Bulaan and Panggalo'-galo' spoke to each other in verse and not long afterwards they came near the coast. When Rangga Bulaan saw the *induk*-trees which stood in rows and the coconut trees growing side by side, she pointed them out to her son, saying, "Look, there is the place where your mother was born".

Panggalo'-galo' headed the boat to the place and they reached the coast where the coconut trees grew next to each other. There the boat was hauled ashore and Rangga Bulaan had it tied fast with a rope.

Rangga Bulaan told Panggalo'-galo' to climb a coconut tree and pick a young coconut so they might drink from it. No sooner had Panggalo'-galo' climbed into the tree than a messenger from Rangga Bulaan's mother came in order to forbid Rangga Bulaan's son to climb the tree. The messenger said, "Whose son is that who just climbs the coconut tree of Rangga Bulaan? How does he dare climb the tree just like that? Doesn't he know that Rangga Bulaan has already been dead for a long time. She is already buried under a well and the front of the house had been blackened. These coconut trees we consider as dedicated to her memory. Hé, you, come down from the tree at once!"

Panggalo'-galo' climbed down, went back to the boat and told his mother everything he had heard: that the man was angry and forbade him to climb the coconut tree. Rangga Bulaan told her son to try another tree, but again he was forbidden to climb the coconut tree. Several times Panggalo'-galo' went back to pluck a young coconut for his mother, but on each occasion he was not allowed to and people grew angry with him.

Rangga Bulaan said to her child: "If again someone forbids you to climb into the tree, you must tell him that the owner of these coconut trees has sent you because it has been a long time since she has eaten a young coconut. Now the owner herself has sent me to pluck a young coconut so that she can drink the milk".

Panggalo'-galo' went back and climbed up another coconut tree just as his mother had instructed. Not long afterwards the man returned. He forbade Panggalo'-galo' and became angry, saying: "Hé, who are you, who have climbed yet again in the coconut tree of Rangga Bulaan whereas she died long ago. Come down right away!"

Panggalo'-galo' replied, delivering his mother's message: "My mother, Rangga Bulaan, has sent me back to climb up in the coconut

tree to pluck a young coconut so that she can drink from the milk".

The people who had heard Panggalo'-galo's words were very surprised. Rangga Bulaan's mother came and said wrathfully: "Who are you, to call the name of my daughter Rangga Bulaan who perished woefully long ago! Where is she now, have the birds of prey or the fish of the ocean eaten Rangga Bulaan? I am amazed that someone has been ordered to climb up her coconut tree. You have defiled her memory".

Panggalo'-galo' answered Rangga Bulaan's mother: "Impossible! I am Rangga Bulaan's son. My mother is now waiting in the boat. She sent me here to climb up the coconut tree to pluck a young coconut because she wanted to drink coconut milk. If you don't believe me, go to the boat to see for yourself if I have lied".

All who heard the words of Panggalo'-galo' were extremely surprised because they knew that long ago Rangga Bulaan had been drowned at sea, that she really was dead and that a ritual for the dead had already been celebrated for her. The people said: "Good, let us go have a look. Perhaps it is true".

The mother of Rangga Bulaan sent a reliable messenger to inspect the boat. When the messenger came close to the boat, he saw Rangga Bulaan sitting on board. He saw the boat fully loaded with goods of gold and silver and very much food. The messenger of Rangga Bulaan's mother returned to relate what he had seen. He said: "It is true that Rangga Bulaan is on the boat. I saw that the boat was fully loaded".

But Rangga Bulaan's mother did not yet place confidence in this messenger. She sent yet another messenger in whom she had even more trust, to visit the boat and see if Rangga Bulaan was there. When this messenger saw that indeed it was Rangga Bulaan who was sitting on the boat, he came back and reported to Rangga Bulaan's mother: "It is true that Rangga Bulaan is on the boat. She was exiled from the country, she was drowned in the ocean, but now she is alive again".

Only then did the mother and father of Rangga Bulaan go to see if their daughter was on the boat. After the mother and father had seen Rangga Bulaan with their own eyes, they believed that Rangga Bulaan who had already died long ago, happily now was alive again.

The mother and father of Rangga Bulaan saw Panggalo'-galo' and they asked: "Whose child is this?" Rangga Bulaan answered her mother and father: "It is my child, your grandchild. His name is Panggalo'-galo'. He built the boat so that we could come back here,

Mother!" The grandparents embraced Panggalo'-galo' and they wept. The mother and father invited Rangga Bulaan and her child to go with them and said, "Let us return to our house". Rangga Bulaan answered: "We would rather remain in the boat to rest. Your daughter committed a sin, she was exiled, drowned at sea and banished from the land".

The mother and father of Rangga Bulaan turned back at these words to their village and said to the chiefs and village councillors: "Our daughter Rangga Bulaan died and has come back to life. Has that ever happened before?" Then all chiefs and village councillors convened to speak with one another so that they might reach an agreement that by coming back Rangga Bulaan had admitted her sins and the error of her ways. They concurred that it was fitting to be grateful to Rangga Bulaan now that she had returned with her son Panggalo'-galo' and had brought along such riches in gold and silver.

Rangga Bulaan was very happy now that she was at home with her child and an abundance of wealth in gold and silver and had come back with a boat equipped with a roof of swords. She had been declared dead for such a long time already, and a mortuary ritual had been celebrated for her, but she was still alive.

Only then was Rangga Bulaan willing to return to the house of her mother and father, because people had already agreed to hold a *merauk* (= *merok*)-feast in token of their gratitude. The thanksgiving was celebrated by the mother and father of Rangga Bulaan and all inhabitants of the country took part. The *merauk*-feast could be held as a vote of thanks because Rangga Bulaan who was already dead had come back to life.

Thanksgiving was dedicated to heaven, to god, because Rangga Bulaan was already given pardon for her sins. The thanksgiving sounded thus:

"Let it be an example for the village,
 an example for the country,
 no one shall die by drowning
 if the same sort of thing happens again,
 no one will be exiled
 when the same sort of thing happens again,
 but let it be a warning for the people,
 an example for the living."

Thus the tale of Rangga Bulaan became an example for the country down unto the present day.

CHAPTER VII

ANIMALS AND PLANTS IN RITUAL AND MYTH

“These are buffalo people.”
(Kennedy, Field Notes on Indonesia: *South Celebes*,
1940-1950)

VII.1 White and pied buffaloes

The *kerbau* (*Bos bubalus* var. *sondaica*) is the most important animal in the culture of the Sa'dan-Toraja. People are preoccupied with water buffaloes. In daily conversation the word *tedong* ('kerbau')¹ crops up again and again. People talk about buffaloes with the fervor of Europeans discussing pedigree dogs. The *kerbau* of the Sa'dan-Toraja are colossuses among the buffaloes. The sound which the megataurus makes comes as something of a surprise: it is not the bellowing of a steer, but rather the gentle bleating of a goat. *Tedong* is the word commonly used for 'kerbau', *karambau* is a more solemn term which appears in ritual songs.

VII.1.1 Colour, markings and other characteristics

The Toraja, just as other people for whom livestock are an important part of their culture, distinguish various types of *kerbau*. There are buffaloes which are *bonga*; these are spotted, sometimes even more dappled than Dutch cattle. They are white (or reddish) with black patches and often have China-blue eyes ('wall-eyes'). Such *kerbau* are also found in several other parts of Indonesia: for example, among the To Bada of Central Celebes, on Sumba, Flores, Roti and Timor (Kreemer 1956: 30-31). Here, however, such animals are, proportionately, less common. According to the veterinary surgeon Mansjur these piebald *kerbau* are not so rare among the Sa'dan-Toraja: he counted some 875 out of a total 20,000 which he inspected (Mansjur 1940: 24).

In addition to the highly priced dappled colouration of the animals, attention is paid to the location and direction of ridges in its coat;

for the significance of these signs which can be favourable as well as unfavourable, see Mansjur's article.

A pied buffalo with favourable hair-ridges bestows much luck on its owner. Such luck, however, was never the lot of the common man in *puang*-regions for long, because in previous times whoever owned a *bonga*-calf had to cede it to the prince as a token of homage. It remains unknown how this dappled variety originated; the Toraja maintain that cross-breeding to achieve special markings, is not done and that the birth of a *bonga* is a matter of chance. One pied buffalo can be valued at 10 to 20 ordinary, solid black buffaloes.

Below follows a categorization of buffaloes according to their colour and markings: *all* black-and-white pied *kerbau* are accorded the designation *bonga* regardless of how the black and white are proportional to each other. A *saleko* (*doti*) is a buffalo with roughly equal amounts of white and black skin area (*masaleko-leko*) and many spots. Mr. W. Papajungan who was my principal source of information commented, "The markings of the *saleko* look like the tracks of someone who has kept going back and forth". *Doti* is a word heard more frequently in Mamasa. The markings of the *doti* are compared to a woodcarving motif of the same name which consists of a combination of white crosses; it is a motif which one finds as well on ancient *maa*'-cloths (*doti langi*'). Some of these specimens are as speckled as lapwing eggs; the plenitude of flecks is associated with abundance and indicates wealth.² For an illustration, see Mansjur (1940: 25).

A *bonga ulu* has only a white head (= *ulu*); there is no white on the buffalo's neck. Should the white of the head begin only before the ears, the animal is known as a *bonga sori* or *bonga rori*'. The price demanded for such a buffalo in October 1966, a bull, was 875 Dutch guilders (the price of an 'ordinary' *bonga ulu* was 750 Dutch guilders). The head of *bonga tengnge*' and half the neck are white, like the *tengnge*', the hen-harrier. A *todi* (*samara*) has a white circle on its forehead. The same term is sometimes used for a blazed horse.

For all the categories of *kerbau* cited here, it is essential that the tail, or at least the tip of the tail, be white. Should buffaloes have a black tail, then they may not be used for sacrificial slaughter. In describing such animals, my informant used the Arabic-Indonesian word *haram*, taboo. Such beasts are less valuable. A *kerbau* which is as expensive if not more expensive than either a *bonga* or *saleko* is the *lotong boko*, one with black hind quarters.

In addition to various *bonga*, other types of *kerbau* are recognized.

The *pudu'* is a common black buffalo; should the end of a *pudu'* tail happen to be white, the beast is known as *pangloli*. An ordinary *pudu'* is black except for the buttocks which are of a lighter hue. A black *kerbau* with white feet is a *suppak* (Bittuang, Pali and Balla); a beast with such markings is also called *tedong ma'kallang*.

The *sambao'* has a tint of its own which my informant encountered difficulty in describing. He asserted that the colour was yellowish or greenish; others have told me it is ashen. Papajungan called the *sambao'* the *kaunan tedong* = the slave among the buffaloes, a characterization also found in the *Passomba Tedong* (Merok: 128-129). *Sambao'* may only be killed by nobility after a number of buffaloes of higher types have already been put to death. It is customary for *kaunan* to slaughter only *sambao'*; (rich) to *makaka* sacrifice *kerbau* having the same colour and markings as the *kerbau* which nobility sacrifice.

Apart from the colour of the hide, the form and length of a buffalo's horns are taken into account. The horns should (together) present the form of a sickle moon, and be right-angled in cross-section (see fig. VII.1).

Tanduk kolong are horns which arch backwards with the points towards each other (*Woordenboek v. tandoek*). Mansjur calls them *tanduk tarangga*. The horns of oxen (*balian*) grow very large; if stretching sideways (*tanduk pampang*) the span can be as wide as 140 cm. Such horns are also depicted as a motif in woodcarving: *pa'tanduk rape*. *Tanduk sikki'*, two semi-circular horns which touch each other at their tips, are considered ugly. Should horns curve downwards and almost meet, then they are referred to as *sikukku'*. *Kerbau* with horns of the particular shape called *tanduk bibang* are sacrificed during the *ma'nene'* (*ma'tomatua*)-ritual. *Bibang* signifies 'sherd from a cooking pot'. In the *Passomba Tedong* such buffaloes are mentioned: "They are the atonement offering to the West, for the ones who are revered as ancestors" (Merok: 129). *Sokko mebali* is the buffalo of low value with horns bending downwards which appears in folk tales (cf. Belksma 1924: Tales 3 and 4). Yet, in some of these tales the animal (then called *sokko remak*) brings wealth to the poor owner (Van der Veen 1924c).

The value of a young *kerbau* is determined by the span of its horns. The wider the span the more precious the animal. Really precious beasts are housed in special stables which are so constructed as to prevent damage being done to the valuable horns. The more expensive

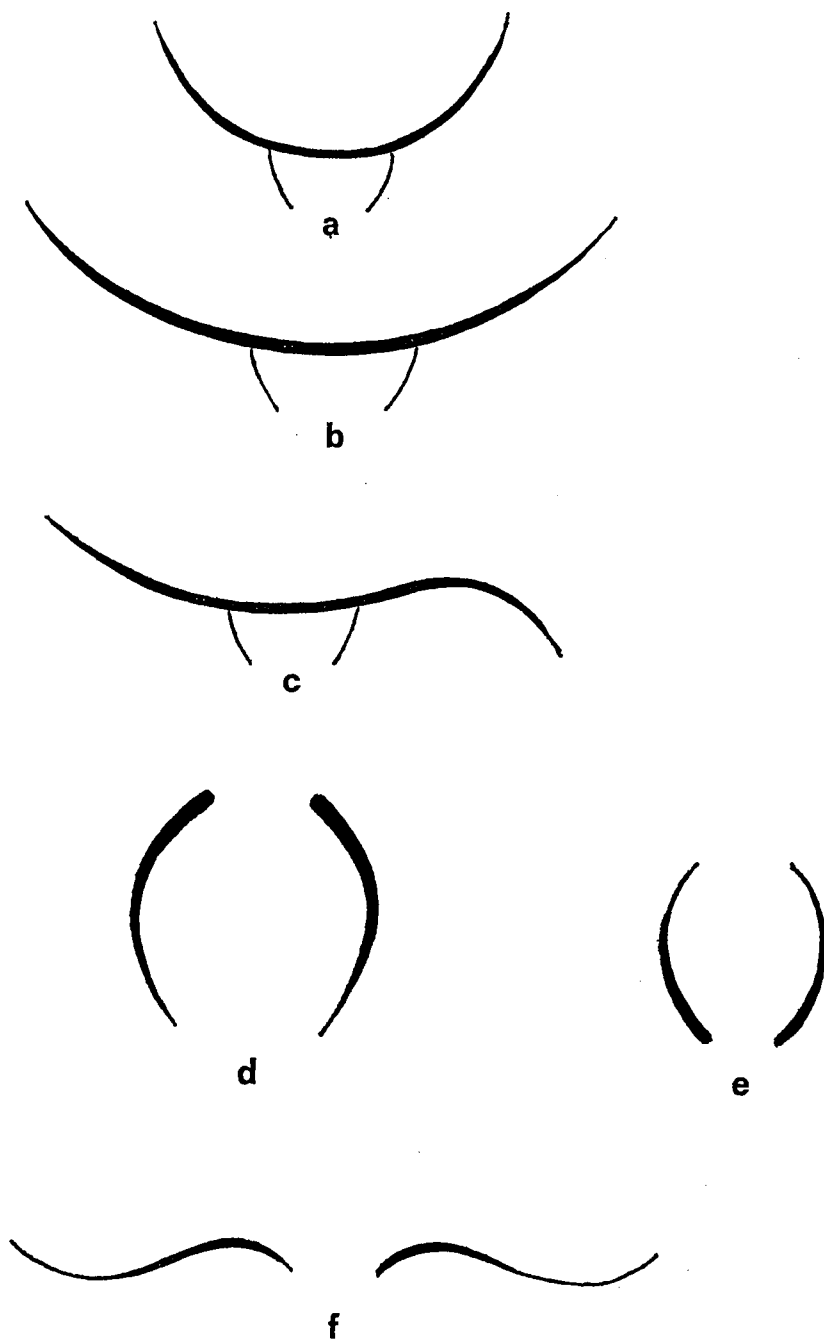

Fig. VII.1 The form of *kerbau* horns:

a. Tarangga

b. Pampang (usually of an ox, *balian*)

c. Tekken langi'

d. Sokko

e. Sikki'

f. Tanduk ra'pe

ped *kerbau* are also lodged in stables. Such *bonga* are never castrated, for people are of the opinion that "they are already pretty the way they are".

There are pitch black buffaloes (*pudu'*) with beautifully shaped horns which are worth as much as a *saleko*. W. Papajungan had commissioned a woodcarver to copy the heads of three of his comely buffaloes, and had these fastened to the front and back of his new house and to the front gable of his ricebarn. On these naturalistically depicted heads real horns rose up, for during the interim the beasts themselves perished in a mortuary ritual.

The value of a *kerbau* thus depends upon its colour and the configuration of its horns — at least if they are bulls or oxen. Cows never have attractively formed horns and even when they are pied the older cows have only a comparatively low value.

The length of a buffalo's horns, a variable which affects the animal's value, is an indication of its age. In Kesu' the following categories of size are distinguished (see also *Woordenboek*):

1. *sanglampa taruno*, the top of a (middle) finger long (in extraordinary circumstances such a young *kerbau* is sacrificed as part of the offering known as *pa'karu'dusan*);
2. *duang lampa taruno*, two finger tops long;
3. *sompok rangka'* (*sompok rakka'*), one finger long;
4. *limbong pala'*, half a hand;
5. *sangkumabe'*, just longer than half a hand (see fig. VII.2);
6. *sanglengo*, a hand. Such a *kerbau* is already equivalent in value to a fat pig (in 1969: 12,500 rps or 125 Dfl);
7. *sangtaruno mengkaluo*, one hand and one finger (which is held crosswise under the hand). Similarly with two and three fingers, until —
8. *sangpala'*, one hand and four fingers (cf. fig. VII.2);
9. *sangbusukan ponto*, from the top of the middle finger to the armband, i.e. a hand and half of the forearm;
10. *alla' tarin*, up to the elbow or just below;
11. *inanna*, past the elbow.

Formerly, less valuable buffaloes were stabled under the house; the former Netherlands Indies government put an end to this practice. In addition to stables, buffaloes are now housed in corrals. Until the moment they are sacrificed at a mortuary ritual or other feast,

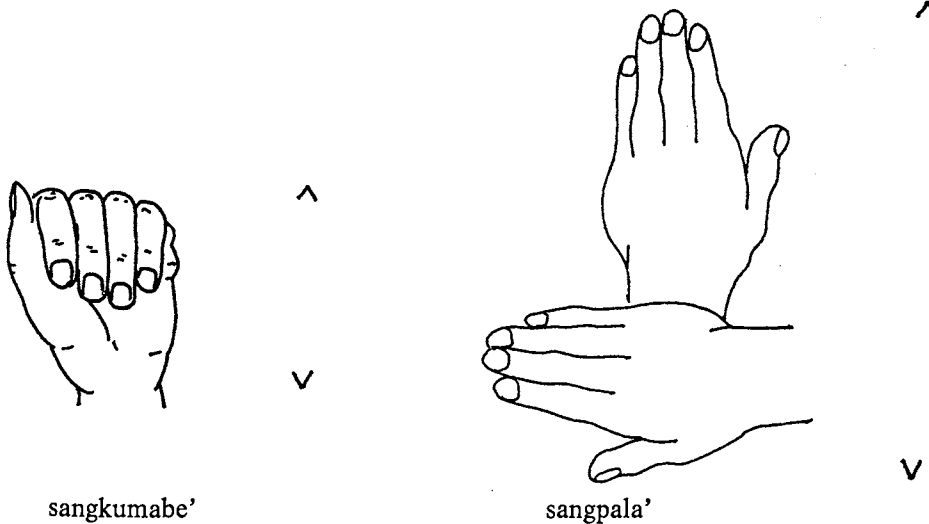

Fig. VII.2 Measurements of the length of *kerbau* horns.

buffaloes, especially costly ones, lead a soft life. *Kerbau* of any value are never harnessed to a yoke; others may be, but even they are never compelled to work excessively, even though their labours are regarded as comparable to the work of slaves:

“Then Datu Bakka’ and Pong Malaleong, completely exhausted, bowed their bodies, thereon they were treated like buffaloes used for work on the rice fields, they were handled like ‘karambau’ used for labour on the sawahs.”

Passomba Tedong (Merok: 137) ³

A pure white buffalo is known as *tedong bulan* (*bulan* = moon); the word also means ‘light in colour’. White buffaloes are never slaughtered at a mortuary ritual. Meat from these animals may not be eaten in most districts, with the exception of Baruppu’. Myths provide explanations for the taboo, but these rationalizations are not all alike. In the story of Polopadang which circulates in Kesu’ and Sangalla’ the prohibition arises because the hero is helped by a white buffalo (see VI.2.2b). The white buffalo astride whose back Lakipadada, the legendary forefather of the *puang* of Ma’kale, Sangalla’ and Mengkendez, tried to cross the sea, failed to reach his destination.

The beast could not reach the far shore and was therefore (according to a version of the story, which differs from that of VI.2.1b) cursed by Lakipadada. For this reason people may not eat the meat of white buffaloes — a rather different clarification of the taboo from the one contained in the preceding myth.⁴

Yet another line of reasoning departs from the assertion that the blood of Puang Matua is white, just as the blood of the rulers in part of the Sa'dan region, the already cited *puang* of Ma'kale, Sangalla' and Mengkendek. White animals, associated with gods and rulers of heavenly descent, may therefore not be consumed; this obtains for all of South Celebes. Elsewhere in Indonesia — and sometimes in Asia — white cattle are associated with princes. It is possible to draw a parallel with the Dalai Lama who, when he was still the monarch of Tibet, rode on a white yak upon certain occasions. The belief that it is forbidden to eat the flesh of a white (albino) buffalo occurs also elsewhere in Indonesia (see Kreemer 1956: 115, 216). No such taboo is found, however, either in Baruppu', or among the Mamasa-Toraja who are close relatives of the Sa'dan-Toraja. The Sa'dan do not raise any white buffaloes: albino calves are abandoned to their fate upon birth so that a speedy death is assured. At present some people spare such calves' lives. The Sa'dan themselves maintain that most white buffaloes are born blind.

Kerbau are herded and cared for by young boys 6-12 years old; this is one of the finest periods in the life of any Sa'dan-Toraja entrusted with the responsibility. When school children are invited to write about their lives, the time when they tended the buffaloes is described with verve; even boys from acculturated milieu recall such days with nostalgia. The cumbersome animals are like putty in the hands of their small keepers. The boys lavish care on the *tedong*, rubbing them down, polishing their hooves and shining their horns until they gleam like steel. Now that school demands much of a boy's time, herding buffaloes becomes more difficult.

S. L. Pasapan from Tallulolo was very proud of his *bonga ulu*. Like all costly *kerbau*, the beast was only put out to graze during the morning; it was washed with soap and rubbed with oil. The bull was housed in a clean stable where it was fed with fine grass. The buffalo itself was extremely clean; its skin, ruddy and black, shone; its tail hung like a white brush and its horns were perfectly shaped and right-angled in cross-section; its damp nose was bright. In short, the bull was Pasapan's pride and joy. It did not roll its eyes the way one

might expect a bull to do; the pale blue-green orbs stared peacefully from its faded pink face. Such *kerbau* have a special attendant. Administering proper care is not a full-time job, and usually it offers welcome, supplementary income to a farmer of simple status. His remuneration consists of a daily portion of rice, perhaps with some smoking materials thrown in. Should a buffalo that has been under a herd's care be slaughtered, he is given a part of the heart.

Vehement objections are being raised against the role of buffaloes in Sa'dan-Toraja culture — alternately by the church, by the young, and by modern-oriented members of the older generation. Their common argument runs that the value of *kerbau* is highly exaggerated considering their limited economic usefulness. Capital sunk in these animals could be put to better uses. This position is set forth by Siregar in an article in *Madjalah Universitas Hasanuddin*, no. 16, 1965. He maintains that in 1961 there were 278,959 *kerbau* in Tana Toraja and the total value of *kerbau* slaughtered during various feasts amounted to 207,360,00 rps (Siregar 1965). In Dutch currency the sacrificial bill was about 1.8 million guilders.

The *kerbau* is so thoroughly woven into the social-religious structure of Sa'dan-Toraja life that we can confidently speak of a 'buffalo complex'. It is easier to point a finger at this preoccupation, than it is to propose guidelines for change. Even the most modern-oriented Toraja continue to sacrifice buffaloes at rituals for the dead.

From a more objective point of view, *kerbau* are not really the totally useless creatures that some pretend. Their meat, eaten during mortuary feasts and other rites, is considered a treat. Buffalo hides, moreover, represent an important export article. Buffalo cows do provide milk (Kennedy 1953, A. C. Kruyt 1923/24), even if not with the abundance of Dutch cows. Buffalo milk is thought to have healing properties and is drunk as a cure for venereal diseases. Occasionally in 1950 I saw buffaloes harnessed to a plough, a sight which occurred with more frequency in 1966 and 1969 when I was again doing research in the field.

As I mentioned earlier, only bulls and oxen are of real value. Males, indeed, are the only acceptable beasts for sacrifice, not only among buffaloes but also among pigs and chickens (although with fowl, exceptions are allowed). What tells with buffaloes is not only that males are larger than females, but that their horns are more splendid as well. Absolute rigidity, however, is not insisted upon. Should one, for example, have sacrificed the really essential number of oxen and

bulls on the 'great day' of a major ritual, he will not scruple to slay some cows as well. Preference for males is the rule, but necessity can be conveniently tolerant.

Bulls and bullocks are individually given a name, usually a glorious one. The favourite *kerbau* of W. Papajungan, immortalized in wooden images ornamenting the gables of his home and ricebarn, had the following names: *Ballo matari* ('Well-carved' or 'he who has a comely form'), *Rangga manurun* ('He who came down from heaven', periphrasis for the animal's perfection), and *Arrang Samalele* ('Light that is evenly diffused', a name deriving from the buffalo's markings which were said to be dazzling). The names of these buffaloes are as widespread and famous as those of human notables in the society. Papajungan had even made a number of epigrams (*londe*) in praise of his favourites. Consider, for example, this composition in honour of *Rangga manurun*:

Torro madatu ritondok
Rara' ballo matari'
Natidukunni linggi' rangga manurun
 "He remains in the village like a prince,
 A finely carved neck ornament of gold.
 Descended in full perfection from heaven,
 At once those of high rank approach him."

VII.1.2 *The family tree of the kerbau*

Mythical buffaloes also have names. Just as people, these animals have important ancestors. According to traditions from Sangalla', Kesu' and Banga, the first bull came down from the upperworld, but the first cow sprang from the earth (A. C. Kruyt 1923/24: 299 and 301-302).⁵ The first union of buffaloes in myth is reminiscent of the marriage of the *to manurun* who chose women of the earth for their wives; these women sprang from a river or a well. The first cow emerged also from water; Sanda Bilik, the ancestress of the *puang*-family, brought this cow with her. A. C. Kruyt (1923/24: 301) offers the following genealogy of the mythical *kerbau* in Kesu':

Manturini = Laelo'
 |
 Tanduk paku
 |
 Tanduk waka'
 |
 Sokko remak⁶

This genealogy illustrates how important the buffalo is, and how illustrious his ancestry. Indeed, isn't Puang Matua himself, as a husband, compared to a bull buffalo? "Puang Matua was as steadfast in the marriage as a centipede in a deep sleep, To Kaubanan was constant in the union like an adult ruminating buffalo bull" (Merok: 85).

Before a buffalo is sacrificed during the *merok*-feast, the *to minaa* recites its family history aloud.⁷ Just as during the *bua' kasalle* a specific person is praised in poetic language and his excellence is emphasized, so the buffalo about to be sacrificed is extolled. I was told that during this praise, the animal stands very still. It is as if it understands the significance of the laudation, as if a bond exists between the person who recites the praise and the tethered *kerbau*. "Tears even well up in the eyes of the mighty animal, he is so deeply touched" (oral information from Mr. Pasaka, Rantepao).

VII.1.3 *The kerbau in art and in ritual*

Kerbau horns, remnants of rituals for the dead, adorn Sa'dan-Toraja houses (in 1966 one saw far fewer such horns, for thieves had made away with these trophies for the purpose of carving horn combs from them). The jawbones of the buffaloes hang in the parent-house of dignitaries, the *sokkong bayu*. (This manner of decoration, possibly designed to ward off evil is widespread among the megalithic peoples of Southeast Asia, Indonesia included.) The horns of the buffalo slaughtered at the *merok*-feast are hung on a *sendana* (sandalwood) tree. The ultimate destination of these horns is something I have been unable to ascertain.

The horns have magical significance: they repel evil influences. Stylized *kerbau* heads are carved upon the doors of ricebarns. The same motif, *pa'tedong*, is also part of the woodcarving decorations on the front and sides of the *tongkonan*,⁸ more specifically on the *sangkinan rinding*, the broad posts into which the wooden panels of the walls are inserted. At times the doors of rockgraves are also adorned with a stylized *kerbau* head; these often are more impressive, more gruesome than the *pa'tedong* fashioned on houses and ricebarns. Lively depicted *kerbau* are sometimes found on the sacral *maa'*-cloths. In more static guise they also turn up on the *pio*, loin cloths with woven designs, which are hung out as banners (*tombi*) during certain celebrations (see fig. VII.3). On these ancient textiles the buffalo is reproduced with turned head so that it displays its horns to better advantage. A look beneath ricebarns often reveals decorations, scenes

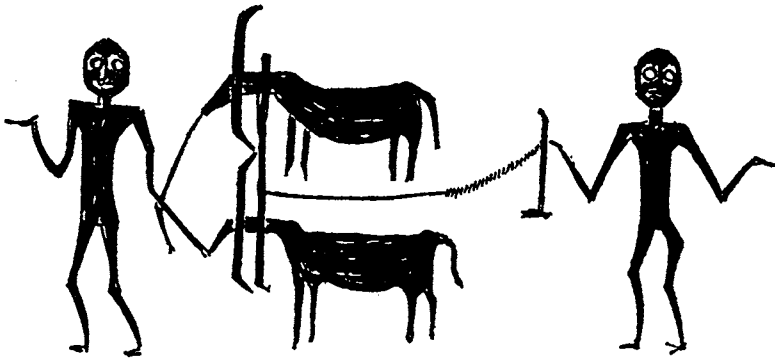

Fig. VII.3 Farmers at work on the land with a team of *kerbau* drawing a plough. Motif woven into a loin cloth (*pio*) hung up as a *tombi* (banner) during ceremonies; owned by Mr. S. P. Pasapan from Sangbua', Kesu'. Colours: dark blue on a white background. Actual size. (Drawing by Miss Suzanne Taub.)

from daily life, along the inside of the lowest horizontal beams: *kerbau* frequently figure in these scenes. One can see the *bonga* reproduced with its natural colouration (this kind of art is particularly noticeable in the district of Tikala).

The carved buffalo heads, life-sized, which adorn the façade of the *tongkonan* and the important post which supports the roof, the *tulak somba*, are life-like. They are very naturalistic, indeed: once I saw a *tulak somba* with a carved buffalo head on which a carved heron was perched; it would not have surprised me if the white bird had suddenly taken flight! Ricebarns also are sometimes fitted out with ornamental buffalo heads, as are some modern homes (I have already mentioned those on the modern residence of Mr. W. Papa-jungan).

The horns which jut from the wooden buffalo heads are real, and are carefully selected; one is choosy about their form. Someone from Sallebayu, I was told, the most eminent *tongkonan* in Tonga, Kesu', was hard in search of a buffalo with beautiful horns so that these horns might be affixed to his *tulak somba*. The wooden buffalo heads on the *tulak somba* and on the front of the house are called *kabongo'*. The buffalo heads described here are presumably meant as a defense against evil influences (see also VIII.1).

Children also model buffaloes. Boys make clay versions, *tedong-tedong*; Wilcox tells how these *tedong-tedong* are given such great horns that the buffaloes become top heavy and topple over. Adults

also apply themselves to making clay buffalo models. It is a leisure occupation independent of the model-maker's age. A game popular among children is 'mortuary-feast'. Part of the reenactment of the ritual is the 'sacrifice' of buffaloes, buffaloes of clay. When girls play at such a pastime, tubers fulfil the role of *kerbau*. During my field-work I discovered that I, too, had become susceptible to a certain cultural preoccupation: increasingly more buffaloes were being scribbled in my sketchbook. A *to makaka* from Kalambe' showed me photographs of his comely buffaloes, with enthusiastic commentary. And how proud S. L. Pasapan from Tallulo was of his *bonga ulu!* (see above p. 190).

Stones in the shape of a buffalo are called *punduk sarai*. Such stones are considered to be able to bring their owners many buffaloes. Buffalo horns are worn during the dances which must be performed during certain rituals, and they are part of the ceremonial dress of particular persons. *Ma'randing* is a dance executed by a group of men who sport imitation buffalo horns (see Claire Holt 1939: 69 and photos 56 and 57). These imitation horns (*tandu' allang* or *tanduk gallang*; *gallang* = brass) are made of brass. Around their necks the dancers wear the *tora-tora*, a necklace of crocodile teeth with the fangs of a wild boar hanging in front. Each dancer carries a shield in his hand. Roughly half a dozen men take part in the *ma'randing* which is performed at the funeral of persons of eminence, particularly for deceased who had a name for bravery. The dance is thus a war dance during which the dancers wear buffalo horns. The dancers (*to ma'randing*) are members of the slave class (*Woordenboek v. randing*).

Ma'tenten is another war dance.⁹ This dance used to take place when the *kerbau* slaughtered during death rituals were speared to death. They then bled slowly to meet their end. Another war dance is *mangaru'*, a term for war dance also occurring in Buginese (in Makassarese: *ngaru*). The dance is a form of homage to the prince or some other figure of authority upon his arrival. As far as I was able to determine, these dancers do not wear buffalo horns. All that is known is that while they dance the dancers shimmy with their entire bodies in a fashion similar to war dances on Nias. The *ma'tenten* is described in Claire Holt's book (1939: 69-70, 110).

In the dance known as *manganda'* the dancers' head-dress consists of real buffalo horns. The head-dress is extra heavy because between the horns a cloth is stretched which in part serves as a backdrop for coins. The coins can be ancient. There are some dating from the first

quarter of the seventeenth century; they apparently are to convey an impression of wealth of abundance. The head-dress also includes feathers. The whole weighs so much that an assistant is necessary to lift it onto the dancer's head. Sometimes two krisses are attached between the horns. Nine dancers do the *manganda'*. One of the figures they trace is a ring dance during which they first move counter-clockwise and then reverse direction. (For further particulars, see Claire Holt 1939: 66ff. and photos 65-68.)

Buffalo horns are also worn by those who officiate at major feasts. During the great *bua'*-feast such a man is the *to ma'tanduk* (J. Kruyt 1921: 63). At the *la'pa'-padang*-feast, the priests (*to menani*) wear imitation horns, fashioned from the ribs of sugar palm leaves. According to Ne' Sangga, they wear real horns which are pointed up.

Buffalo horns then, real or artificial, are worn at rituals related to both death and fertility. In the Rantepao region (Sangalla', Kesu' and Tikala) old coffins (*rapasan*) had a buffalo head as decoration at one end.

Sacrificed buffaloes accompany the deceased to Puya; a special buffalo path stretches through the kingdom of the dead. Life in the hereafter is imagined as an extension of life on earth, and the deceased must be able after death to comport himself at the level to which he was accustomed during life. This idea was repeated to me by Toraja informants. Relatives assist by sacrificing buffaloes to go along with the deceased to Puya. In the past the burial of a prominent member of certain *tongkonan* in Kesu' and Tikala entailed the killing and decapitation of a human being to tend the herds of the deceased notable in the hereafter.¹⁰

The Netherlands Indies government set a limit to the slaughter of the number of buffaloes permissible at a mortuary ritual. The Indonesian government has done likewise. Anyone who wishes to celebrate a mortuary ritual for the dead, must report the number of buffaloes to be put to death during the proceedings. The proposed number is sometimes cut back severely by the authorities: one asks for permission to kill twenty and receives to go-ahead to sacrifice four. It also happens that the children of the deceased agree among themselves to limit the number of *kerbau* to be slaughtered. Limitations introduced by the colonial government perhaps had the effect that they drove up the price of a *saleko* (*bonga*); Kruyt reported that a pied *kerbau* was valued at the price of four ordinary ones (in 1923/24: 304). Because the government's rule restricted only the *number* of buffaloes to be

slaughtered, the element of competition shifted from number to quality with the effect that pied buffaloes rose in price.

In crisis situations buffaloes are sacrificed in payment of a fine, or to expiate a sin. Thus, if incest has been committed, or when a person has been killed and decapitated and revenge has not been taken.

The mortuary ritual for a deceased of high status demanded the sacrifice of many buffaloes, several of which are of specific significance; the *parepe'* or *tandi rapasan*, and the *tulak bala'kaan*. The *parepe'* is killed at the *dirapa'i* ritual; in Ma'kale, Sangalla' and Mengkendek at the mortuary ritual for a *puang*. Another buffalo sacrificed in the course of a funeral of high order is the *sumbung penaa* (see *Woordenboek*, s. *penaa*, the appendage of the soul). This beast, and the buffalo called *pa'karu'dusan* are killed on the first day of the death ritual.¹¹ The *pa'karu'dusan* is considered to have died simultaneously with the dead person and is more or less identified with him (cf. Vol. II). Close family members of the dead may not eat the meat of this buffalo. In the past, but on occasion also in the present, the *pa'karu'dusan* was brutally slaughtered (Kruyt 1923/24: 147).

In Rantepao the *parepe'* is the equivalent of the *tandi rapasan* (another name is *kampa tatau*). Family members may partake of the meat of this sacrifice. From the day that the body of the deceased is laid into the *rapasan*, the *tandi rapasan* stays in the room beneath the dead person's home during all the time that the rites called *dipalimang bongi*, *dipapitung bongi* and the first part of the *dirapa'i* are celebrated (cf. the mortuary rites as discussed in Vol. II). When the buffaloes are led in procession about the terrain where the final mortuary feast is held, the *tandi rapasan* goes in front. A *maa'*-cloth is draped over its back. This *kerbau* is slaughtered on the day that the deceased is brought to the rockgrave to be entombed. The other name for this buffalo, *kampa tatau*, the guardian of the *tatau*, is an allusion to the doll (*tau-tau*) made in effigy of the dead person. In burial huts in Mamasa-district one sometimes sees such dolls seated astride a wooden buffalo; these depict the deceased and his mount on their way to the next world. In the Sa'dan region, the *tau-tau* rides a horse, although here, too, the notion exists that a *kerbau* carries the dead to the hereafter (the mount then is the *parepe'* and not the *tandi rapasan*).

Tulak bala'kaan is the name of a buffalo which is bound tightly to a pole (*tulak*) of the *bala'kaan* (= the scaffolding upon which the

meat of a sacrifice is distributed). The meat of this *kerbau* may only be eaten by those who are members of the *tongkonan* of the deceased. The same holds true for the meat of the *parepe'*. Other buffaloes with a special function will be discussed in the chapters on mortuary rites (Vol. II). The more exalted the ritual, the more buffaloes are put to death and the more buffaloes have specific functions to fulfil.

During rituals for the dead we thus encounter the following ideas in relation to water buffaloes:

- a. identification of the deceased with the *kerbau* (specifically with the *karu'dusan* and the *sumbung penaa*);
- b. the *kerbau* as the animal on which the dead person rides to the hereafter (the *parepe'*);
- c. the buffalo as guardian of the dead (*kampa tatau*).

The function of the *tulak bala'kaan* is difficult to explain. In addition: *kerbau* are considered to accompany the dead to the next world and they determine the status of the deceased in the realm of the dead.

Upon the place of slaughter, the buffaloes are tethered to wooden poles (respectively, the trunks of the sugar palm, the areca palm, the pseudo sugar palm, and the *bambu betung*¹²) which rise from the ground next to the upright stones (*simbuang batu*). Before the buffaloes are killed, they sometimes are pitched against each other in battle. It is a show of might: head crashes against head, the vast bodies shivering with the impact. The fighting, however, is not bloody. The actual slaughter of the animals is thus all the more gory. In 1950, 1966 and 1969 I witnessed mortuary feasts at which one giant *kerbau* after another crumpled in a heap after a single blow of the machete. Boys raced about to catch the ebbing life blood, the same boys who had been the buffalo's playmates and their keepers. Ethnographers with a camera were as a rule thrust into the front ranks of spectators where they might capture the spectacle on film. This vantage, however, entails legitimate reason for fear: the dying buffaloes can still plunge about. People do not regard slaughtering as cruel; in former times when the buffaloes were speared to death, the act was indeed more barbarous. The blade descends while the buffalo is standing. The animal's right or left fore-leg is bound to a post with rattan. While one man pulls the buffalo's head up by tugging on the bamboo ring which the beast wears through its nose, another slashes at its throat.

Considerable pride is attached to this manner of dispatching them which requires adeptness. Yet, the execution can be bungled and then the buffalo suffers beyond measure. During the slaughter, the crowd sometimes shows signs of excitement comparable in some respects to the emotion of spectators at bull fights.

When I asked if people didn't find it a pity to kill such expensive creatures and inquired whether they didn't grow attached to their buffaloes, the answers I received were all negative. "We sacrifice our costly animals so that we can acquire part of the dead man's legacy and can become rich!"

Distribution of the meat and the various remnants of the slaughtered buffaloes is connected to extant patterns of reciprocity (between villages, *tongkonan*, family members, friends, acquaintances, and so on). The division of society into classes also becomes manifest in the procedure.

The *kerbau*, status symbol, price index, sacrificial animal, mount for the dead and expiatory offering, is of all the animal kingdom the closest to man. Thus in the *Passomba Tedong* it is said of the first man's son:

"He received the name of Manturino,
and his other name was Datu Muane,
He was all but the namesake of the divine progenitor
of the buffalo,
with only a small difference, he had the other name of
the begetter,
revered as a lord, of the kerbau."

(Merok: 103)

One differentiates kinds of *kerbau*, higher and lower sorts, just as people are differentiated. The common green *kerbau* belongs with those 'who wear an armband of clay', the *to kaunan*, the lowest class; this is iterated in a litany which the *to minaa* recites during the *merok*-feast.¹³

The *tedong bulan* is associated with the *puang*. What Evans Pritchard has written about the cattle of the Nuer also obtains for the *kerbau* of the Sa'dan-Toraja: "They furnish certain ritual categories; and they greatly enrich the language of poetry" (Evans Pritchard 1947: 41).

People's attitudes towards the *kerbau* is ambivalent. The beast is spoiled during its life but is allowed to die — especially in days past — a gruesome death. Pong Lalondong severed the thread of life spun for mankind; man puts an end to the buffalo's life. Buffaloes are

slaughtered during feasts which have to do with life and well-being, but also during rituals for the dead. Living beings exchange *kerbau* and present to their dead parents the most costly possession which they own: the buffalo. In return they receive something valued as highly: ricefields. The *kerbau* is the symbol of wealth and also of property of the ramage. This emerges in the opening of the poem which has been translated in section VII.1.4: "Three are the symbols with which we began" (i.e. the hairs, the lice and the parasites on the buffalo).

It was the prerogative of the *burake*, the leading priest (priestess) to kill a dappled buffalo during the great *bua'*-feast. This was the most precious *kerbau* of all.

The white *kerbau* remains an outsider to the entire buffalo-complex; in myths, especially those traditions concerning Polopadang and Laki-padada (cf. VI.2.2 and VI.2.1b), this animal is a prominent actor, but he cannot be sacrificed.

VII.1.4 *The buffalo as a symbol of the ramage's power and wealth*

The following poem, transcribed by Bua' Sarungallo, gives a condensed survey of the implications of the *kerbau* as symbol of the ramage's power and wealth (Dutch version by H. van der Veen).

- | | |
|---|--|
| <i>Tallumo te dandanan sangka' kitirandukki</i> | "Three are the symbols (clues, signs) with which we began." |
| 1. Bulunna tinde tedong darun bulaanna to ma'rapu tallang. | The hairs of this buffalo are the golden needles of the ramage-members, numerous as bamboo culms. |
| 2. Kutunna tinde tedong ba'tan bulaanna to ma'rapu tallang. | The lice from this buffalo is the golden millet of the ramage-members . . . |
| 3. Lissena tinde tedong bu'buk bulaanna to ma'rapu tallang. | The parasites on this buffalo are the golden sawdust of the ramage-members . . . |
| 4. Balulangna tinde tedong lotong boko'na to ma'rapu tallang. | The hide of this buffalo is the <i>maa'-kain</i> (<i>lotong boko</i>) with the figure of a buffalo with a black back belonging to the ramage-members . . . |

5. Ikko'na tinde tedong kandaure salombe'na to ma'rapu tallang. The tail of this buffalo is the beaded jewellery with long loops belonging to the ramage-members . . .
6. Tandukna tinde tedong gayangna to ma'rapu tallang. The horns of this buffalo are the golden krisses of the ramage-members . . .
7. Lentekna tinde tedong banua gayangna to ma'rapu tallang. The feet of this buffalo are the sheaths of the golden krisses of the ramage-members . . .
8. Kalungkungna tinde tedong suke salappa bulaanna to ma'rapu tallang. The hooves of this buffalo are the golden betel cases of the ramage-members . . .
9. Isinna tinde tedong lai lola'na to ma'rapu tallang. The teeth of this buffalo are the precious stones imbedded in the large golden armbands of the ramage-members . . .
10. Lilana tinde tedong pesangle bulaanna to ma'rapu tallang. The tongue of this buffalo is the golden serving spoon of the ramage-members . . .
11. Pollo'na tinde tedong purrusan bulaanna to ma'rapu tallang. The hind quarters of this buffalo are the golden sack with lance ribbon belonging to the ramage-members . . .
12. Galingna tinde tedong doke pando' bulaanna to ma'rapu tallang. The *galing*¹⁴ of this buffalo is the golden lance with the silver ribbon on the shaft which belongs to the ramage-members . . .
13. Bayana tinde tedong saritanna to ma'rapu tallang. The spleen of this buffalo is the blue *cindai*-cloth¹⁵ with white figures that belongs to the ramage-members . . .
14. Tambun tenena tinde tedong peruru bulaanna to ma'rapu tallang. The entrails of this buffalo are the golden bullets of the ramage-members . . .
15. Tumabangna tinde tedong kandu' bulaanna to ma'rapu tallang. The stomach of this buffalo is the great golden bag of the ramage-members . . .

- | | |
|--|--|
| 16. Lalikanna tinde tedong balubunna to ma'rapu tallang. | The chamber of the stomach for food that is chewed a second time belonging to this buffalo is the golden <i>martavan</i> ¹⁶ of the ramage-members . . . |
| 17. Buana tinde tedong lampo'na to ma'rapu tallang. | The heart of this buffalo is the great, cone-shaped bag of the sheath of the sugar palm which belongs to the ramage-members... |
| 18. Balangna tinde tedong sepup' bulaanna to ma'rapu tallang. | The lungs of this buffalo is the golden betel pouch of the ramage-members . . . |
| 19. Atena tinde tedong sangeran bulaanna to ma'rapu tallang. | The liver of this buffalo is the golden whetstone of the ramage-members . . . |
| 20. Talinganna tinde tedong talinga maa'na to ma'rapu tallang. | The ears of this buffalo are the ancients cloths (<i>maa'</i>) with ear motifs belonging to the ramage-members, numerous as bamboo culms. |

VII.1.5 *The division of the meat*

The laudation of the *kerbau's* virtues and symbolic values, so eloquently voiced in the preceding section, should not induce us to overlook the animal's more prosaic but all the same very useful gifts, all of which can be summarized in one word: meat. Whether dedicated to the gods or to the dead, the meat of the sacrificial animal is, with few exceptions, destined for the living, and for the living this meat is not an incidental extra but an integral part of each celebration. The division of the meat is a matter of immense social relevance and the Toraja everywhere have fixed rules for meting out everyone's share. The rules may differ from place to place, but never is the division of the meat left to chance or circumstances. In the following pages we describe the procedures followed in Ba'tan (Kesu'). Our informant was Bua' Sarungallo.

The buffalo is toppled by a slash with a machete (*la'bo'*) or else pierced through with a lance. Execution by spear, now obsolete, was formerly reserved for only the *karu'dusan* and the buffalo which was sacrificed during the *merok*-feast (and presumably also *kerbau* put to

death during the great *bua'*-ritual). It was (and continues to be) considered unlucky if the spear had to be thrust twice into the beast instead of once only. Similar belief pertains to wielding the machete as the instrument of death. If speared, the buffalo was supposed to fall to the right; a fall to the left was regarded as an ill omen. As soon as the buffalo has fallen to earth, small boys rush up — at a ritual for the dead — to collect escaping blood in bamboo containers.

The buffalo is butchered and skinned; then small boys (testimony has it these are children of the *to parengnge'*) make off with the hooves. They tie these to a string and play a game with them: two boys cross the strings to which the hooves have been attached and then pull until one of the strings breaks.

The cutting up of the carcass continues as follows: the *kerbau* is divided into two along its underside. The entrails are removed. Then division of the meat takes place. The front part of the breast is the portion of the *to parengnge'*. As far as the other parts are concerned: the bottom of the neck (actually the top of the throat) is, in part, set aside for the butchers. The host also receives part of the throat and some of the shoulder. The owner of the slaughtered *kerbau* is given part of the heart and the thigh.

Below follow further details concerning the division of the most important parts of the buffalo. The meat is handed out by the *sokkong bayu*; if he does not himself officiate, he must designate a substitute who is a member of his *tongkonan*.

Division of buffalo parts in Ba'tan, Kesu'

1. If only one buffalo is killed, the head, complete with the neck as far as the ears, goes to the *sokkong bayu* (the head of the leading *tongkonan*).
2. The *buku lesu*, the hip joint of a hind leg with surrounding meat (left or right is immaterial) is allotted in its entirety to the *sokkong bayu*.
3. The other rear leg is divided in two, one of the pieces roughly twice the size of the second one. The larger portion is given to the *datu baine*. The upper part goes to the first *petulak*. The shins of both hind legs are split into two so that four pieces can be distributed, one each for *petulak* numbers 2, 3, 4 and 5. Should there be additional *petulak*, then either the front leg or the hind leg is still further divided.
4. One and a half portions are considered to remain from the front

legs. (Note: Just as the rear legs are considered to extend as far as and to include the hip joint, so the front legs are taken to reach, and to include, the 'shoulder joint' or shoulder blade.) The pieces which make up this remaining one and a half portions are divided into three. The *buku sanduk* (the shoulder blades) go to the *to indo' padang* (the leaders of the rice ritual) and to the *anak patalo*, among whom they are divided further.

5. Certain pieces of meat (*pariu?*, *puyung?*) go to the *pa'buntuan sugi'*, to the rich, the respected (literally: to those whose wealth is like a mountain; this is also the title of an *adat*-chief who has much prestige). These can be family relations of the *to parengnge'*.

Only the belly and the back and ribs now remain. A part of the liver, the kidneys, a portion of the stomach, etc. are cut into small pieces and given to the *to parengnge'* and the *to indo' (padang)*. The ribs and what is left over from the stomach are distributed among 'the people', the heads of families in the village and also among people attending the feast who do not live in the village. The ancestors themselves receive only small bits of meat; see *Woordenboek* v. *kiki'*. Rules for passing out the ribs (with the meat on them) are not very exact.

The *aak* (the slab of meat which clings to the spine from just above the hip joints) is in La'bo' apportioned to the *kaunan*. In Tikunna Malenong, the *palona* ('his breast bone', i.e. the buffalo's) is also reserved for the *kaunan*. *Palo* is the name for the meat attached to the midriff of a *kerbau* (or pig, for that matter).

When many buffaloes are slaughtered, then the *kaunan* may possibly receive an entire hind quarter. The members of this class share it further, one part going 'to the side of the mother' and one 'to the side of the father', that is to the former slaves and descendants of the deceased's (late) mother's family and to those of the deceased's (late) father's family.

Special buffaloes

The head of the *karu'dusan*, together with part of the neck, goes, according to one informant, to the *tongkonan* with which the *tongkonan* of the deceased maintains reciprocal relations (*dipasibali*); another informant said this special piece was set aside for the most prominent among the (former) slaves.

The following reciprocal relations between *tongkonan* exist in Kesu':

Sallebayu	↗	To' Sendana
Aya'	↗	To' Uë
Gantanan	↗	Banua Sura'
Sangkombong	↗	?

Yet, exchanges between these *tongkonan* only take place on the occasion of a *mantunu* (a slaughter of *kerbau* for the dead).

The head of the buffalo which is sacrificed during the *ma'doya*, another mortuary rite, is presented by Sallebayu to the *tongkonan* of the *to mangrande londong*, the functionary who, during the *merok*-feast, holds the cock which is to be sacrificed.

During the *ma'batang*, yet another rite of the mortuary feast, Sallebayu gives the head of the buffalo to a related *tongkonan* of lower status, a junior *tongkonan*. The head of the animal which is called *karu'dusan* is presented by Sallebayu to a *tongkonan* of lower rank, for close family members may not partake of it. *Dipatongkonan*: the gift of *kerbau* heads to related *tongkonan*. There is no limit to the number of houses which may be involved. Nonetheless there is only one *tongkonan* which stands in a fixed relation to any given *tongkonan*, i.e. its partner in reciprocal exchanges as cited above, its *dipasibalian*. It was remarked, prompted by the above, that people sometimes sent the head of a slaughtered buffalo to someone with whom they were feuding. This antagonist, when the occasion arose, returned the favour in kind.

Further information indicates that the heart of a slaughtered *kerbau* is divided up among members of the *marapuan*; the host of the feast, moreover, receives not only part of the breast but also part of the heart and the kidneys.

When portions are meted out to the *to indo' padang* (those thus who receive the upper segments of the front legs) the portion of the one who performs the *mangimbo* (presumably the *bunga' lalan*) exceeds that of the rest. Should only one buffalo be killed, the head and one *buku leso*, as previously specified, go to the *sokkong bayu*. When more are sacrificed, nevertheless only one head and one *buku leso* are accorded to the *sokkong bayu*.

One shin of the slaughtered *kerbau* (at a mortuary feast?) goes to the *to ma'ba'ta*, those who tap palm wine. Old people are given the brains and the tongue of a buffalo that has been killed, for these are soft (in the Sa'dan region, the *to parengnge'* share the tongue). To take a bit from all portions of a sacrificial animal in order to make

an offering to the gods (*deata*) is called *pantiti'*. *Pemanala* is the term for setting something aside from all portions of the sacrificial animal to offer it to the *bombo*, the spirit/soul of the deceased (see VII.1.6).

VII.1.6 *Pemanala; the parts of the pesung*

A *pesung* is an offering for the gods to eat which consists of cooked rice and scraps of meat from all the different parts of whatever animal has been sacrificed, with the exception of the *buku sanduk*, or shoulder blade. This offering is set out on banana leaves (*Woor-denboek v. pesung*). The constituent ingredients of a *pesung* prepared after the sacrifice of a *kerbau* during the *merok*-feast in Kesu' include small pieces from:

1. *Buku lesa*, the hip joint;
2. *Kalumpani'na*,¹⁷ a thin layer of meat in front of the hind legs;
3. *Bale'ke'na*, the kidney;
4. *Atena*, the liver;
5. *Lompona*, fat;
6. *Balangna*, the lungs;
7. *Buana* (presumably) the heart (*bua pollo'* = buttock);
8. *Tampak usukna*, the far end of the rib;
9. *Kollongna*, meat from the neck that is cut off in rings;
10. *Sokkongna*, back of the neck;
11. *Ikkona*, the tail and/or one hind leg;
12. Some plain meat for the *tuak*, the palm wine;
13. *Baana*, the spleen;
14. *Ruangna*, meat from one of the halves of the trunk;
15. *Palopalo*, meat from the midriff.

For purpose of comparison, I here list the parts taken from a cock sacrificed at the *merok*-feast to be included in a *pesung*:

1. *Buku lesa*, the hip joint;
2. *Rakka*, the toes;
3. *Buku palangkina* (part of the lower leg?);
4. *Tampak usukna*, the tip of a rib;
5. *Pangreresan*, that portion where the neck is cut off;
6. *Lilana* (a piece of) its tongue;
7. *Tampak passi'na* (two parts of ?);
8. *Songdongna*, ?;
9. *Buana*, the heart;
10. *Atena*, the liver;
11. *Papan palengko'na*, the intestines (?).

VII.2 The pig

Pigs are of the type found generally throughout Southeast Asia (*Sus vittatus*). Today European and Bali pigs have been imported. Among the approximately 100 swine (killed) during a mortuary feast in Tondon (1966), it was possible to pick out two English boars by their snub noses. Just as *kerbau*, pigs are carefully bred.¹⁸

According to one myth, the pig (*bai*) is of earthly origin; according to another of supermundane. According to the *Passomba Tedong*, the consecrational litany for the *kerbau* sacrificed at the *merok*-feast, the first pig emerged from a rock (Merok: 111). This implies a heavenly origin to this animal. In the story of Mambio Padang, however, an analogue of the tale of Marampio Padang (Kruyt 1923/24: 354ff.) circulating in Nanggala, it is told how a pig stole edible roots from Mambio Padang (see VI.4.2). This pig had emerged from the underworld through a hole and retreated the way he had come. The pig appeared to be the child of the lord of the underworld. (In other versions the thief is a human being from the underworld.) The ancestor of the swine, whatever his origin, is spoken of in terms of respect. His appearance in the world was not unaccompanied by a measure of sumptuousness. To the tune of his squealing, his round nose first poked up, then a golden trotter came into view. Yet, the name of the forefather of the pig is not illustrious: *Tamio*, a kind of fat worm. In Sangalla' the ancestor of the swine is known as *E'gon*.

After the *kerbau*, the pig is the most important sacrificial animal. At all feasts, pigs are slaughtered; a hoard are involved in the renewal of the roof of a parenthouse (*tongkonan*), the celebration of a *mangrara papa*. Another important feast at which numerous pigs are killed is the *mangrara banua* (see VIII.1: The *tongkonan*). Pigs are carried to these feasts and to the *merok*-feast on stretchers. These stretchers (*letto'-letto'*, *lettoan*, *lem poan*) are decorated with clothes, krisses, beads and the red leaves of the bloodwort. Even on more modern festival occasions, on the anniversary of Indonesian Independence for example, pigs are carried in this fashion.

Pigs are regularly being brought to market. Piglets are carried in a sort of small sack (*kamboti*) plaited from palm leaves. Large pigs, in addition to being transported on stretchers or litters, are also at times carried to feasts by two men after being trussed to a bamboo, sometimes provided with a bamboo support. Support or not, this mode of transport is anything but painless.

In contrast to buffaloes and chickens, the colour of pigs is of minor

importance in sacrifices. Only for certain rites are specific markings required of a sacrificial pig. Black pigs are called *pudu'*, pigs with a white spot on the front part of the face, *todi*; *bai ballang* are pied pigs. Mainly males are sacrificed during feasts, a fact deserving attention, for the same exclusiveness obtains for buffaloes and fowl. Seldom, at least when an important feast is being held, will female animals be part of an offering. Males are more impressive, and thought to be more beautiful.

Pigs which have been sacrificed at a feast are prepared on a kind of spit. This spit (*langngan*) serves to singe away the animal's bristles. The liver and the gall bladder of the dead pig are examined for purposes of divination. The rules for distributing the meat are recounted in VII.2.1.

Swine do not often appear in art as a stylized motif. In naturalistic scenes painted underneath ricebarns, however, pigs are common enough, rendered at times with considerable wit. On one ancient loin cloth (*lindo pio*), a heirloom in the possession of S. R. Pasapan from Tallulolo, stylized pigs do appear.

VII.2.1 *Division of the meat after the sacrifice of a pig in Kesu'*; *informant Bua' Sarungallo*

If only a single pig is sacrificed, then the *buku sanduk* (for explanation of the parts of the pig's body to which this and other terms refer, cf. VII.1.6) goes to the *sokkong bayu*. The *kollong*, cut in a ribbon from the neck, is placed with rice upon a *dulang*; this is then called the *kollong to parengnge'*.

On the occasion of the *manganta'*, all *to parengnge'* and *to indo'* receive a *kollong*. The sacrificial pig is distributed together with other slaughtered pigs at such feasts. During the *mangrara banua*, no special *buku sanduk* portion is reserved for the *sokkong bayu* because so many pigs are put to death. The *ikko'* is that part of the rear section of the carcass which is given back to the owner of the pig after the animal is slaughtered.

Persons of respect are not permitted to eat from the *palo*, meat attached to the pig's diaphragm; if they did, they would catch scabies. Formerly, it was said that those who ate from this part of the animal would turn into cowards in battle. The midriff is therefore put aside, and allotted to women and, after them, to men of low class. During the great *bua'*-feast, however, the *palo muane*, half of the midriff of the pig sacrificed as part of this ritual, is awarded to the *to indo'*

padang and the *to parengnge'*, the *adat*-chief. The other half, *palo baine*, falls to the women.

Dimamatai indicates that the pig which is divided is still raw. Should one pig be sacrificed and then be cooked, then the *sokkong bayu* receives the *buku lesu*. This is served on the *dulang* garnished with rice.

VII.3 The chicken

From his bellows Puang Matua created the ancestor of chicken, the cock Menturiri (Merok: 90-91, verse 439), at the same time that he brought into being other important forefathers of animals, plants, and metals, including the ancestors of the buffalo, cotton, rain, iron, and boiled rice. The ancestor of the chicken carried on like a madman; he pecked away at kernels of grain without ever taking a pause. For this reason he was called Puang Maro, The Possessed (*ibid*: 94-95, verses 464-466). His hyper-active pecking is apparently regarded as neurotic. This helps clarify the relation of the chicken to the *maro*-ritual which is held to prevent illness and to ward off evil influences. During this feast certain individuals become possessed just as Puang Maro once was. Throughout the *maro*-ritual — with the sole exception of the *maro pembali* (see Vol. II, Rituals of Conversion) — only chicken are sacrificed.

Puang Maro married the hen Landokollong (alias Landobaroko = Long Neck). Informants told me that the *katik*, the carved chicken's head which appears on the façade of the *tongkonan* is an image of this mythical bird. From this first marriage chickens issued that were of different colour, each colour subsequently being reserved for particular rituals:

a black chicken (*lotong*) is killed facing West as a sacrifice to the ancestors;

a brown(ish)-yellow chicken, *tasak*, is sacrificed during the rice ritual;

a black chicken with white spots or flecks, *karurung*, serves as an offering when buffalo or pig stalls are being built to promote fertility of these animals (a plenitude of spots or dots symbolizes abundance);

a black-and-white chicken, *koro*, is sacrificed by goldsmiths when imploring the gods to bless their work;

a chicken with markings suggestive of colouring by raindrops, the *uran-uran*, is sacrificed in rites associated with the cultivated land of

an entire *tongkonan* (apparently the raindrop colouration also is associated with abundance);

a brown cock with white spots, *seppaga*, is sacrificed in preparation to making palm wine, "so that the sap may flow like blood" (B. Sarungallo informed me that such a cock must also be sacrificed when two brothers who have fought with each other settle their differences);

a brown cock with white feet, *sella'*, is associated with the cock for the gods;

a brown cock with white ear-laps, *sella' mabusa*, is used for sacrifice by leaders of the rice ritual (the *to indo'*).

During the *la'pa'* (*bua'*) *kasalle*-feast, a small basket with a white hen in it is hung on top of a stout bamboo pole together with a few bundles of rice. A long rattan cord keeps everything in place. The cord hangs down to the ground and the leaves of the bamboo are left intact. The pole (*lumbaa*) is erected in the *gorang* (a platform for ceremonial use), facing in the direction of the *deata*. "The next morning, at a very early hour, participants in the feast take turns pulling on the cord until one of them has broken the bamboo pole and can capture the white hen. People believe that the lucky man who succeeds at this has been allotted long life. He lets the white hen live in the hope that it will lay many eggs. The clusters of rice are then divided among those taking part in the feast in order to be sown later." (*Woordenboek*: 323 v. *loembaa*.)

Buri', speckled cocks, are pitched into the fighting arena should people wish to ascertain the judgement of the gods (*Merok*: 461-481). Indeed, whenever the *to parengnge'* or elders who must settle a dispute cannot reach a decision, a cock-fight is arranged to determine right from wrong. This is the reason that the cock is spoken of as 'The Highest Judge'.

The chickens enumerated above all have a place in myth. They sometimes play a leading part (cf. the myth of *Tulangdidi'*, VI.4.3a). The colours, or observances appropriate to certain sacrifices are set forth in detail in the *Passomba Tedong*. Finally, B. Sarungallo made mention of the *barumbun*, a brown chicken with grey spots, which is sacrificed to commemorate the birth of a child (oral information). In most circumstances cocks are preferred to hens. Yet, sometimes a hen is required, as, for example, the white hen tied to the *lumbaa*. During a *maro*-ritual, held to speed recovery of a sick person, many

chickens are killed; then both cocks and hens are slaughtered in numbers.

The chicken, like the *kerbau*, is closely allied to mankind. He accompanies man as a sacrificial animal, both at cyclic rituals and at rites of passage. In Vol. II we will meet with many examples of this sacrificial use. The cock also has a function in the administration of justice. Personally, I am inclined to associate the cock with Pong Lalondong (*londong* = cock), The Judge in the Kingdom of the Dead, but my Sa'danese informants disagree. To them the cock is too clearly a bird of the upperworld; heaven was the scene of the cock's creation. In woodcarving, the cock is invariably portrayed on the front of the *tongkonan* and of the ricebarn, together with the *barre allo*, the sun motif. The symbolism is obvious: the cock crows at the crack of dawn. He is the herald of morn:

"The fowl of Lapandek high up in heaven,
the cock of Tulangdidi',
awake the sleeping to join their companions,
the rock of heaven gapes open,
it is light."

(From A. C. Kruyt 1923/24: 309)

Mr. Parinding, however, offered me another interpretation of the ubiquitous carved chicken motif: the cock is a fighter, a hero; its image signifies that members of the *tongkonan* (inhabitants of the house but also descendants of the founder of the house) must act heroically. B. Sarungallo's view is that "the cock is depicted on the house because, like the *kerbau*, he belongs together with man but most important of all is that he is regarded as the highest judge". It is in connection with this perception that in what follows below I have paid close attention to the rules which govern cock-fighting.

The cocks are brought to the place where they will fight. A large basket (*salokko'*) is carried along, the cock's coop; the cock himself, already strutting, rides on its trainer's arm. Should one meet anyone on the way, no conversation is exchanged because talk might have a negative influence on the outcome of the fight. As fight time nears, you can see people arriving in long lines from every point of the compass, many of them holding one or more fighting cocks carefully.

Those who have already arrived at the site of the cock-pit have inspected the blades which are to be fastened to the cock's spurs. People are constantly busy pampering the cocks, observing portents (how the feathers grow, colouration, etc.) and permitting cocks to

skirmish with each other in warm-up encounters — without knives. The holding of a cock-fight is called *massaung*, the cock-pit *ala-ala* or *laa*. The arena is roughly rectangular and surrounded by a fence made of diagonally woven bamboo. Cocks of roughly the same dimension but different colours are paired off as combatants. The colour difference is to prevent confusion. The *pa'kayun* is the person who holds on his arm the fighting cock which people want to see do battle. Opposite him there stands the other *pa'kayun*, distinguishable from the first through his clothing, and/or cap. The *panglappa'* is the one who releases the cock in the arena after having taken him from the *pa'kayun*. The birds, however, are first compared. There are thus two *panglappa'* inside the fighting space. The *passikki* is the person who fastens the artificial spurs consisting, as already mentioned, of razor-sharp blades (see fig. VII.4). The *passepak* is umpire, he must

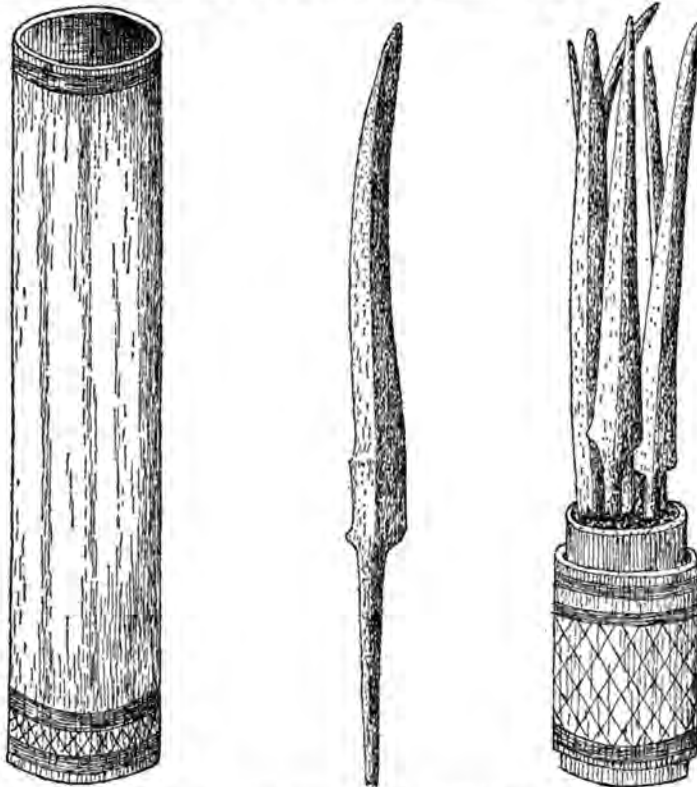

Fig. VII.4 Artificial spurs (*tadi*) used during cock fights. Collection Lambaga Kebudayaan Indonesia, Museum Pusat, Jakarta (inv. no. 23548). (Drawing by Subokastowo.)

watch closely to see who wins or loses; he crosses to the loser and cuts off one of its legs (*sepak*). The leg is part of his payment. *Mamun* is the term used to denote pitting a cock without artificial spur against one that is so equipped; this happens when one bird is larger than its adversary. Sometimes the larger one receives one spur.

The cock which is vanquished during the fight is laid on the *parasila* (a kind of wooden fork). The victor is then urged to peck at the head of the cock he has defeated. If he pecks away, this is a sign that he has won the fight indeed; if he fails to peck, then the bout has not been decisive.

The owner of one cock can serve as *pa'kayun* or *panglappa'* for another. *Dere* is the custom of presenting the owner of a fighting cock, or of fighting knives which have been borrowed, with a gift should one's bird prevail.

In my eyes the fighting cocks are cruelly treated. Prior to battle their feet are bound to the *basong manuk*, a decorated piece of wood. The fight itself is bloody, unless the loser is almost at once mortally wounded, which not uncommonly happens. Even the winner often does not leave the arena whole. Still, the lot of the winner is better than that of the loser, who is always put to death, usually only after the *sepak* is cut off while he still lives. Cock-fights are extremely popular and involve heavy betting.

VII.4 Other birds

Birds, if they are able fliers, belong to the upperworld.¹⁹ They are mediators, messengers between gods and men. Great value was attached to the cry and flying patterns of birds — especially on head-hunting expeditions. The *koang*-bird is an omen of success, if it is heard to the right; should the *koang* be heard on the left, however, then misfortune is in store. The *korong* (called *kayo* in Ma'kale and Sangalla'), a kind of heron, is auspicious if it flies over the road from left to right; good luck is pending, also, if it comes from the north. Should the bird approach from the south, the enterprise had better be renounced. When this bird is spotted flying from right to left, this is described as *diampang*, thwarting (from *ampang* = threshold); this, too, is an unfavourable line of flight.

The same beliefs were attached to the flight of the *puyo* (quail) and of the *angin-angin*. A. C. Kruyt, our principal source of information on these matters (1923/24: 265-269) also provides the names of some other birds which were of significance for head-hunting

expeditions: the *sekke*, the *dassi'-dassi'*, the *ma'sak* and the *kaloko'*. This last bird has various ways of calling or crying out to which people join special significance. One of the *kaloko'*'s cries is known as *ma'tinti*. "When a priest (*to minaa*) is on the point of invoking the spirits (*deata*) and a *kaloko'* gives forth with a *ma'tinti*, then he need not further call upon the gods because they are already there. This was also to be the case should the prince of Ma'kale, Puang Tarongko, chance to pass by." (*ibid.*: 267).

In general it is thus favourable when birds accost a group of warriors from the north. The north, after all, is the direction of the *deata*. Head-hunters also are attentive to hen-harriers and other such birds but, oddly enough, not to the *alo*, the hornbill which elsewhere in Indonesia (for example, on Borneo) is closely associated with head-hunting. This *alo* merely portends drought should one spy him winging over the landscape. In myths and legends birds often play the part of messengers, or they bring men an important item of culture, such as rice (for further examples, see A. C. Kruyt 1923/24: 328 and Van der Veen 1929: 397).

With the bird names *kayo*, *tambolang* (a black and white coloured stork) and *tattiku'* (a small bird), three categories of priests are alluded to, respectively the *to ma'kayo* (the death priest), the *to burake* and the *to burake tattiku'*.

VII.5 The dog

In the *Traditions* reported by Ne' Mani' (Van der Veen 1976) it is told how the ancestor of the dog was created in the upperworld: *Buriko*, He Who is Grey of Hue with Black Stripes.

The breed of dog found in Tana Toraja resembles a Dutch *keeshond* with its slanted eyes, pointed ears and tail resting on its rump. Dogs of practically every gradation of colour can be seen. Long hair is also not common, although on the slopes of Sesean I did observe some few isabelline dogs with long-haired coats. A dog's colouration and behaviour have predictive value (*ibid.*: 299ff.). Should a dog be killed as part of a sacrifice, the tint of his hair is carefully considered.

Dogs are numerous in Tana Toraja. They are for sale at markets,²⁰ tied to a bamboo pole as 'leash'. The poor animals have no idea of the lot and peer about rather pitifully in the strange surroundings. At present they are in demand as food, more so than in the past when they were only eaten by *kaunan*. The *puang*-lineages, certain *to makaka* families in Ma'kale, the descendants of Ambun diKesu' and Manaek

were not allowed to (or still may not) consume dog meat. In the last case the prohibition can apparently be traced back to the important role as messenger and intermediary which the dog fulfils in the mythical stories of Manaek and Polopadang. In other myths, too, the dog plays a leading part, sometimes not a very praiseworthy one, as in the myth of Tulangdidi', yet sometimes as the saviour of the protagonist, as in the myth of Bulu Pala'.

VII.6 The cat

The cat is called *serre'* (Rantepao) or *sese'* (Ma'kale).

VII.6.1 Beliefs and categories

The cat comes from the upperworld but lives, according to Toraja belief, as judge in the hereafter. Together with the earliest rice, the cat came down to earth from the upperworld (arriving at the former district of Sa'dan), or else she descended with the first being from heaven; according to a variant of this story, the cat's descent brought her to the mythical island of Pongko', or Lebukan (A. C. Kruyt 1923/24: 280). Like all important animals originating from the upperworld, the cat, too, has her ancestor: *Tanduk Bangkudu*, The Red-horned One (Sangalla' District). It seems likely that the 'horned' is a reference to the cat's erect ears. Traditions in Tikala and Riu assert that the cat's ancestor was created in the upperworld at the same time as the first human being.²¹

There are cats which occupy something of an elite position in society: they dwell indoors and never set foot on the ground. These are the *serre' datu*.²² Van der Veen maintains that these cats do not differ in colour or in appearance from others, but Harry Wilcox disagrees, identifying the *serre'* or *sese' datu* as small tabbycats with a long tail (and not a stumpy one).²³ Both authors emphatically report that these *serre' datu* do not come into contact with the earth, which is consistent with their elevated status (Wilcox 1949: 113). A *serre' lao* is a cat which also enjoys being cared for but is allowed to prowl about the yard. In 1949-1950 I had not seen a *serre' datu* and so was unaware exactly how a 'princely cat' looked. In 1966 when I returned to Tana Toraja, such cats had already become scarce. The residents of *tongkonan* Panganan in Ba'tan were kind enough to fetch their *serre' datu* from the attic for my inspection (1966). The cat, however, considered such treatment as profane, and unbecoming to her station. She was a handsomely coloured tabby. All *serre' datu*,

I was informed, had similar markings. She was almost as tailless as a Manx cat (from the Island of Man in the Irish Sea; a European short-haired cat). Her kitten, pitch black with a long tail was considered the offspring of a misalliance because of his colour; this aspersion would seem to contradict Van der Veen's account of *serre' datu* of all colours. It had become difficult to find appropriate mates for *serre' datu* now that so many insolent ordinary cats wandered about. Moreover, these cats are becoming increasingly rare because the hearth, their cat's box, is at present quite often located in a separate house next to the *tongkonan*.

The cat, the rice and the fire are closely related to each other. Cats guard the rice by hunting mice. This perhaps explains why the position of the Sa'danese cat is so important: one considers her the protector of all the goods of her master. In Kesu' she is called the 'mother of all goods', who hold things together.

"The cat belongs to the family of the goods.
She is the guardian of the basket of woven bamboo
with the cover of wood in which the jewels are kept,
The ribbon of the low basket full of jewels."

(Passage from Van der Veen's Dutch translation
of a *ma'buu'*-litany)

Van der Veen provides yet another example of chanting the praise of cats. It was recited during the *ma'singgi'*, the ceremonial songs of laudation voiced in the course of a great feast:

"The cat is the source of goods.
She sees to it that the mice no longer stir,
the mice with their betel tails.²⁴
Through her the cloths remain durable which
lie on the bottom of the basket, the hairs
do not stand on end because of the valuables of
every description."

(Van der Veen 1924a: 366)

Thus the cat minds the contents of the *baka bua* in which — formerly — clothing and valuables were stored. While originating from the upperworld, the cat keeps a vigil over the goods of men in this world and, in addition, fulfils an important function in the Land of Souls. The cat assists Pong Lalondong, the Judge of Puya, to strip worldly goods from those souls which committed theft during their sojourn on earth.

VII.6.2 *Prohibitions and customs*

The cat must be treated with distinction; she may not be eaten or killed. Above all no one can strike her with a piece of firewood, for firewood is associated with the hearth fire; for the same reason a bamboo blowpipe, the instrument used to make the hearth fire blaze, may not be used as a cudgel against her. The cat's place is beside the hearth, her favoured sleeping place. Nor it is permitted to take a swipe at a troublesome cat with a winnowing fan. Nevertheless it does happen that people kill a cat that eats chickens (a *serre' datu* never commits such a sin, for she remains in the house). The person who has killed a cat must sacrifice a chicken or else he will descend into poverty. In the Rantepao region, the death of one of the inmates of the house is announced to the cat; the animal is at once brought to another residence. In Ma'kale district such transportation takes place because otherwise the cat would grow stiff from staring at the dead: then she wouldn't be able to catch mice anymore. In Kesu' the cat dies a ceremonial death should the master of the house die: she is thrown down from high up "to let her feel that her master has perished". The intention is for the cat to accompany the deceased to the hereafter, there, too, to stand guard over his possessions. In the past many valuables were sent along with the dead.

A dead cat is laid to rest in a tree.²⁵ In Kesu' in a small basket, in Ma'kale rolled in a mat. In Kesu' a male cat is provided with a needle upon burial, a female with a rice knife. Elsewhere, in Ma'kale, Baruppu', Sangalla' and Rantepao, the dead cat receives food for her journey to the next world. For more details on cats see A. C. Kruyt 1923/24: 280ff.; most of the information presented here has been borrowed from this work.

One can place the cat in the *ma'bu'a'*; as mouser, she is coupled with the rice. Yet a further step is possible: she is guardian of all the goods of the house, the courtyard, and even beyond, a position emphasized in the *ma'bu'a'*-litany. Even in the hereafter she fulfils this role; she restores stolen property to its rightful owner. Yet, her position is not without ambivalence. On the one hand she is kept far from every contact with death. The cat may not look at the dead, and in some places (Sa'dan district) not even in the eyes of those who are dying. Just as life and death are kept as distinct as possible and ceremonies concerning rice are entirely separate from ceremonies involving death, so, too, the cat, associated with rice, may not come into contact in this life with the dead. But: the Sa'dan also believe

that cats are able to see souls. Through her behaviour, a cat can predict approaching death. She has an important function in the land of the dead, too, as Pong Lalondong's assistant. A cat must be respected. Whoever ridicules a cat runs the risk of being reborn as one. Tall stories are told about cats. Some of them form part of Toraja mythology (cf. VI.2.2b, Deatanna and Polopadang), others are mere fairy tales. Wilcox (1949: 113) speaks of a 'wild cat with a gleaming iron collar, a kind of fairy tale beast. Whoever succeeds in stealing such a necklace thereby acquires power. Van der Veen was also aware of the fable (oral information).

Together with the *kerbau*, the cat is the most fascinating animal in Sa'dan-Toraja culture. Unintentionally, the cat calls to mind the *burake*, the most important priest(ess). She has the same protective function, superintendence of social welfare. The cat, too, belongs to different worlds. And therefore it is no wonder that in Kesu' the cat is spoken of as the ancestor of the *burake tattiku'*. This was the cat *Burake Manakka* (*manakka* = accomplished, quick-witted, to be full of spirit). The *burake manakka* are *burake* who search for mice during the *ma'bu'a'*-feast.

VII.7 The snake and the eel

To A. C. Kruyt's way of thinking, Pong Tulangdenna' is the god of snakes and eels. He also cites a myth telling how an eel conveyed an infant to a princess of the *puang*-ramage. People deduced that this girl must be married to the eel and therefore members of the *puang*-lineage refrain from eating eel (A. C. Kruyt 1923/24: 320). Why the descendants of Polopadang and Deatanna may not eat eel is also clarified by the myth about them (cf. VI.2.2b). In the past, considering the images of snakes on ancient coffins and old *tongkonan* (see VIII.1), the role of the snake must have been more important in Toraja land than it has become today.

A. C. Kruyt devoted considerable attention to the snake (1923/24: 320-323). A snake which dwelled in a *tongkonan* was looked upon as a tutelary spirit to whom people referred as they would to *to matua* (the ancestors who are associated with the ritual of the West). Such a snake may not be driven away. No sacrifices are offered to the snake, however. Should a snake enter into an ordinary house, this is a sign that one of the household, or one of the domestic animals, will die. Whenever possible people try to kill a snake under these circumstances; if successful, they must then sacrifice a chicken to the gods

to ward off evil (a chicken must also be offered if the snake escapes).

If one comes across a snake on the way to the rice fields, or sees a snake in the field, this presages a good harvest. (Cf. the *burake tambolang* and the *burake tattiku'* who, playing the *garatung*, a clapper drum with a tympan of python skin, try to persuade people to provide them with their due tribute from the rice harvest.)

It is believed that women can give birth to snakes. Such a snake is brought to a bamboo bush; it is considered innocuous. Should a woman die while bearing a snake, then a rope of beads is placed around the animal. The snake is given puffed rice (*ratuk*) to eat and then released. If a woman is 'pregnant' with snakes, people call this *kea'tang deata*, with child by the *deata'* (A. C. Kruyt 1923/24: 323).

It is believed that a snake will not die if someone does not kill it. The animal sheds its skin and lives on. Anyone who finds such a loose skin will become brave, and will own ancient *maa'*-cloths.

Just as with other important animals in Sa'dan mythology, snakes and eels have two sides: they are associated with the upperworld and with the northeast just as they are with the southwest. The eel is, it goes without saying, a creature that is connected with water; the eel-god of the Sopaï, moreover, is dangerous. For specific aspects of the snake figure, a reader is referred to the myths of Pano Bulaan and Rangga Bulaan, VI.4.5a and b.

VII.8 The tree of life

It is remarkable, considering that the tree of life plays such a great role in the culture of the Sa'dan-Toraja that it is almost absent as a motif in their plastic art. The Toraja know two living trees of life: the *barana'*, the banyan tree (Indonesian: *waringin*, *Ficus religiosa*) and the *sendana*, the sandalwood tree (Indonesian: *tjendana/cendana*, *Santana album*). The first is central to the *bua' kasalle*-feast as it is celebrated in Kesu', the second is an integral part of the *merok*-ritual (see Vol. II). The *barana'* used to be planted with the intention of organizing a great *bua'*-feast in due time; the tree would be full-grown towards the time that the ritual could be celebrated. But the *sendana* used in the *merok*-feast is only a mere sapling. The intention is that it will grow and flourish, thus symbolizing the well-being of the ramage.²⁶

The *barana'* is not celebrated in chant but the heavenly prototype of the *sendana* is acclaimed in poetic language in the *Passomba Tedong*.

Puang Matua himself removed a sandalwood tree from the dike surrounding the heavenly *sawah*, saying as he did so,

“Here is the richly laden *tjendana* tree to which we shall bind
the buffalo with the skin befitting the offering rites,
for this is the tree with the blood of mankind,
herewith is the tree whose branches are full of precious things,
to which we shall tie up the kerbau
with the neck hair suitable for the *adat* performances,
the tree with the life-fluid of the people of the earth.”

(Merok: 152-153, verse 778)

From Puang Matua's pronouncement, one could argue that the *sendana* is not strictly speaking a tree of life (Cosmic Tree) in the sense that Eliade attaches to the term (Eliade 1964: 269, *The World Tree*), because the tree is identified with mankind. Yet, slightly further along in the *Passomba Tedong*, mention is made of how the rice prospered better after the planting of the heavenly *sendana* (see verse 781) so that one of the pre-conditions of a tree of life, the bestowal of fertility and abundance, is fulfilled. It is a symbol of vitality anyhow. It is the “tree with the life-fluid of the people of the earth” (Merok, verse 778). In the *Passomba Tedong* the *sendana* is called the tree with seven branches and seven leaves. It was felled by the first carpenter, To Tanarangga, in the north of the firmament. Since the carpenter was unaware of the sacrifices he should have offered, the tree disappeared into the heavenly spring (which provided water to the rice fields of the upperworld). Thereupon Puang Matua taught To Tanarangga the sacrifices which are required: three chickens coloured like dark red beads (*tinggi*) to be offered on a *likaran biang* as altar²⁷ (Merok: 107-109). Since that time mankind presents offerings whenever trees must be cut down.

The four *sendana* posts mentioned in the mythic narrative — their exact origin remains unclear to me — probably symbolize the *tongkonan*, the parenthouse. The richly laden sandalwood tree belongs to this house, so that perhaps both the *sendana* and the main posts of the mythical *tongkonan* derive from the tree of heaven. The divine forefather of the earthly *sendana* was transplanted by the people in the upperworld to a hill because the roots of the tree had damaged their golden plough. The tree, however, was unwilling to flourish on this hill and wished to be planted in the *sawah*-dike. It is there that Puang Matua, wishing to hold a *merok*-feast, went to fetch the *sendana*

whose branches were weighed down with costly things. Apparently, the *tongkonan*, and the prosperity of man and rice, are closely related to the sandalwood tree. The preceding account pertains to Kesu' but elsewhere the sandalwood tree has the same significance. The intention underlying the rites which revolve around the *sendana* and the *barana*' is always to ask for the blessing of the upperworld.

In addition to the use of the *sendana* in the celebration of the *merok*-feast, the tree is also employed as a means of symbolic expression on other occasions. The *sendana lalong* is planted beside the entrance to the village and, together with the warriors of the village, it must watch over the security of the settlement. The tree was involved in a ritual which was enacted at the village entrance.

The *sendana bonga* is the sandalwood tree which, together with *passakke*-leaves (the leaves of the *Cordyline fruticosa*) and bloodwort leaves, is placed next to a stone, the *patangdo*, which is imbedded in the earth in front of the house which is the center of the great *bua*'-feast (information from Van der Veen).

The tree of life thus plays a major role in the *bua*'- and *merok*-feasts, two important rituals of the East, the *aluk rampe matallo*. The *sendana*, however, has its counterpart in the rituals of the West, the *aluk rampe matampu*', the ritual for the dead. During a rite of the *ma'tomatua* the *sendana dongka* is planted, a variety of sandalwood tree differing from the heavenly *sendana*. This tree has no red heart-wood, like the *sendana bonga*; the heart-wood is whitish instead. This *sendana* is only planted if a *kerbau* is slaughtered during the ritual named above, and not if pigs alone are slaughtered. The *kerbau* is then tied fast to the *sendana* by the horns.

VII.9 The *bate manurun*, the 'flag' which came down from heaven²⁸

This *bate* ('flag') is an enormous bamboo pole adorned with sacral objects which is erected during a great *maro*-ritual. Whereas the tree of life points upwards, stretching itself towards heaven as a medium for man to come in contact with the upperworld, the *bate manurun* has descended to earth, come down from the upperworld (*Singgi' Gelong Tallang* [An Eulogy in Praise of the Bamboo], Van der Veen 1979: 135-155). Although the *maro*-ritual must be classed among cyclic rituals, it stands somewhat apart because a disturbance is always one of the main incentives for its celebration, a lack of order which must be restored. Such a ritual response is required for example, when an epidemic breaks out. The movements in this ritual

often are contrary, opposed to those of other rituals; they have a different orientation. A person who is entranced sees everything in reverse.

In the *bate*-song (transcribed and translated by Van der Veen but not yet published) we are told how the glance of the Ruler of Heaven falls on the earth to locate an appropriate *tallang*-bamboo for the *bate manurun*. The radiance emanating from such a bamboo is so intense that it illuminates the village and the sky (the pole is decorated with red dracaena leaves; the red, conceivably, symbolizes the radiance). Another chant in the 'Eulogy in Praise of the Bamboo' relates how bamboo sprouted in the firmament, it is rooted in the face of the moon. In a later verse, the bamboo is compared to the moon and to a silver *rijksdaalder* (Dutch coin, equivalent 2.50 Dutch guilders, see Mevius 1979: 66-67). Bamboo was not planted by man, but by the Ruler of Heaven. He let the bamboo descend from the 'upper regions', "he made it go down below from the opposite side". For this passage the gate of the firmament (the window of the gods) was opened. It is also mentioned that the bamboo was attended by *Dracaena terminalis*, a symbol throughout all of Southeast Asia and Oceania of blood, vitality, and the repulsion of evil. With its leaves the *bate manurun* is lavishly decorated. Other symbols serving to ward off evil, also adorn the vast bamboo: sharp swords and old, magical cloths.

The 'Eulogy in Praise of the Bamboo' also narrates how the bamboo descended on Pongko', the island of the ancestors, and how from there it spread across the earth. It enumerates all the many things that can be made out of this sort of bamboo, so that the practical value of the *tallang* receives due notice.

In this context I want to emphasize the significance of *manurun*, 'descended from the firmament'. The enormous bamboo pole was lowered by the gods from the upperworld to defend man from all harm (epidemics, etc.); the massive pole is, as it were, a helping hand extended by heaven to mankind on earth (own interpretation).

VII.10 Rice

Rice is the main crop of the Sa'dan-Toraja. There are countless traditions concerning its origins. These differ in their design but they fall into two categories: the first contains the myths in which rice is created in the upperworld and afterwards brought to the earth; and the second those which tell how rice was created on earth. In the

former category, Puang Matua is the parent of the cooked rice (see Merok: 70f., verse 347 and 90f., verse 440). The Ruler of Heaven then either gave the rice directly to mankind, or else birds, mice or men served as the go-betweens who smuggled the grain into human hands. This is why mice, ricebirds (*dena'*) and other enemies of this crop demand part of the rice harvest as their reward (A. C. Kruyt 1923/24: 326-328).

In the second category of myth rice originates from man's sperm. It sometimes happens that both categories of myth coexist in a single district — in Mengkendek, for example. Below I present abbreviated versions of several rice myths reported by A. C. Kruyt.

Rice was created by the Ruler of Heaven in the upperworld. His daughters, Indo' Simanggala and Indo' Samadenna', quarreled about this kind of grain. Indo' Samadenna' lost the quarrel and went away with her golden reel. (In the version reported by Van der Veen (1965: 72f.), the two fight over a golden spinning wheel.) It is possible that Indo' Samadenna' symbolizes rice in general whereas Indo' Parepare' is the name for a specific variety of rice. In another rice myth which A. C. Kruyt reproduces, Londong diLangi' receives the rice to bring to earth, and is instructed in the customs which must be observed in the cultivation of the grain. He laid out the first *sawah* close to Leleu and Rura (in the south of the country of the forefathers; Rura lies in Duri).

In Sangalla' it is said that rice came from the south (which is more of a factual report than a mythic interpretation). In Mengkendek rice is of celestial origin. In Ma'kale it is alleged that rice came from the north. In keeping with another legend in this same region, it was a small bird (*maniku*) who let three ears of rice fall on the earth. These were found by people who planted them. Another rice myth, also from Ma'kale, relates how a buffalo herdsman mixed his own seed with buffalo milk and threw the mixture into a wallow where the buffaloes used to splash. Here rice plants grew up which had three ears. (A Ranteballa variant of this story has milk from a woman's breast as the second ingredient of the mixture.)

In many rice myths it is stated that originally *three* rice stems sprouted, or that birds let *three* ears of rice fall to earth. The *three* ears referred to are apparently identical to the *pare' tallu bulinna*, the *pare' tallu etengna*, the three 'ears', the three 'clusters', the 'three-eared' rice alluded to in the *Passomba Tedong* (Merok: 22f.).

The above-mentioned myths can be consulted in longer versions in

A. C. Kruyt, 1923/24: 324-333. In one of these myths the sun and the moon play roles; they give rice to mankind, the moon also advising man to pay attention to her various phases when planting the rice (cf. Indo' Samadenna', alias Tulangdidi' who lives in the moon — own addition). Kruyt also records a tradition from Tondok Litak in which the rice originated from a gold nugget. One half of the gold became rice, the other half became the first man, Pong Laukku'. The gold itself came from 'the source of the river', thus from the north (A. C. Kruyt 1923/24: 330). In reading this myth one cannot help thinking of Tulangdidi' who was cut in half; this heroine, whose story has been told in VI.4.3a is known among the Bare'e-Toraja as 'The Exceedingly Yellow One' (cf. gold) and among the Sa'dan-Toraja as 'The Upright Yellow One' (cf. rice); about to be cut in two she requests burial upstream, further to the north.

VII.11 Millet

In the past, according to A. C. Kruyt's evaluation, millet was important to the Sa'dan-Toraja. It would seem rice has largely displaced it. When there was no rice yet, millet would have been offered to the gods. Even today some millet may be offered (see Merok: 78f., verse 383). Millet is called *lonno*', or alternatively (another variety?) *ba'tan*.

VII.12 Maize

Maize is said to have sprung from the teeth of Padakka after he was buried (in the district of Sangalla'). From the man's fingers grew *dora'* (a yam variety); from his penis, a root crop called *lame*²⁹ (a yam variety). From Padakka's head, a gourd sprouted (*Lagenaria vulgaris*); a bird darted from his eyes, the *pitutai*. A similar legend survives in Tabang (Masuppu' River).

Elsewhere too in the Old and New World important crops have grown from a buried corpse; on Java and Bali, even the rice is alleged to have arisen from a man interred in the earth, but this theme in relation to rice does not appear in Tana Toraja. Its absence can be explained: maize is closely associated with the recent dead whereas rice is linked with the purified dead who have acquired a place in the upperworld.

Relatives observing mourning may eat no rice throughout the mourning period; in Ma'kale people eat no maize during the season that they harvest the rice. Those who wear mourning for a *burake*

tambolang, however, are not allowed to eat maize (or rice for that matter); they must subsist on millet or tubers (Van der Veen 1924: 398). Maize and rice are particularly subject to various food taboos. These taboos alternate so that when it is permitted to eat one of them it is forbidden to eat the other. During the *maro*-feast people in Kesu' are not permitted to eat boiled rice for three full days. Only rice that has been soaked in water may then be consumed, otherwise people would turn to stone. This petrification happened to a woman from the village of Pao. People point out the spot where it happened. This is the *Batu Eran* ('Stairs of Stone').

VII.13 The *tabang* (*Cordyline terminalis*): bloodwort

Bloodwort with its red leaves plays a role in the *maro*-ritual. The colour of the *Cordyline terminalis* is associated with blood, it symbolizes life and vitality. Those who participate in the *maro*-ritual fasten these leaves like a fillet around their head and employ them as a styptic to wounds incurred during the feast (ideally no blood should flow during the ceremonies).

In the *Pangimbo Manuk*, 'The Prayer over the Hen Sacrifice, reported by Ne' Kalo, *to minaa* of Sereale' (translated and annotated by Van der Veen but not yet published), it is told how the tearing off of *tabang*-leaves from the plant was initiated in the upperworld for Indo' Belo Tumbang (see verse 68). The rending of bloodwort leaves also is described in the *Passomba Tedong* in the verses described the treatment of the ailing child of Puang Matua in the upperworld:

"Then began the tearing off of the leaves of
the dragon's blood plant, in the iron house,
thereon started the pulling off of the foliage of
the croton plant, before the poles with strong fibres
Indo' Belo Tumbang applied thereto the treatment of
splitting,
Indo' Bunga Sampa' employed thereon the remedy that
brings recovery."

(Merok: 144-145, verses 739-740)

The *tabang* is also the plant down along which the gods who reside at the edge of the firmament are entreated to make their way, the way which leads to this world (see verses 12 and 13 in *Gelong Maro Sangaju* [The *Maro*-song of Sangaju'], Van der Veen 1979: 109-129).

Finally, the *tabang* occurs in the underworld, too; here the gods of this region have fins or tails of bloodwort leaves (*ibid.*: verse 12f.).

VII.14 **Langsat (langsa', Lansium domesticum)**

For this tree, consult the description of head-hunting expeditions (Vol. II) and the *Passomba Tedong* (Merok: 130-131, verse 661).

VII.15 **Induk (sugar palm, Arenga saccharifera)**

The sugar palm figures in mortuary rituals of a high order. During such important burials, a buffalo is tied to the trunk of an *induk*; then the trunk is referred to as *simbuang induk* (see Merok: 130-131, verses 664-666). If one realizes that the buffalo is thought to be very close to man and that the souls of the dead are considered to rise to the firmament by ascending the trunk of a palm, then the symbolism involved becomes evident. The sugar palm has yet an additional role in these rituals; the ribs of the leaves of this palm, with bits of kapok drenched in the blood of sacrificial animals upon them, constitute part of the shrine called *palanduan-duan* (Merok: 152-153, verse 775).

The *induk* also furnishes palm wine (*tuak*). This is one of the reasons why the cultivation of the palm is important. During the *merok*-feast, an offering is made on their behalf. This offering consists of the first blood to gush from the wound of the *kerbau* which is slaughtered. The palm wine tappers collect this blood: "The object of their taking the first blood is to ensure that the juice in the sugar palms will flow abundantly when they tap them" (Merok: 8).

VII.16 **The banana**

Although banana leaves play a significant role in sacrificial rituals, the banana did not come into being in the upperworld. In the story of Marampio Padang it is related how he brought the banana to earth with him, up from the underworld. Banana leaves serve primarily as a base on which to arrange food, not only for humans, but for the gods as well. A *pesung* is an offering of food for the deities, consisting of rice boiled in a pot or bamboo cylinder, and small bits of meat from various parts of the sacrificial animal; this offering is set out on four or more pieces of a banana leaf, presented to the gods with an accompanying prayer (*Woordenboek*: 461; cf. also VII.1.6 and VIII.7). In some rituals (the *maro*) banana leaves are replaced by a leaf of the bloodwort plant (*tabang*).

As serving platter for the offering, the banana leaf is torn into specific pieces. A whole banana leaf is selected for this purpose, the stem pointing to the operator. The right half of this leaf — with its

upper side facing upwards — is then ripped off and used to make the scraps of leaf upon which the offering will be presented. Only the right half of the banana leaf is used (for this manner of tearing the leaf, see also J. Kruyt 1921: 51).

VII.17 Ipo

The ancestors of plants created by Puang Matua with the help of his bellows are almost all ancestors of cultivated plants, with the exception of the forefather of the poisonous *ipo*-tree, Allo Tiranda (Merok: 88f., verse 437; 90f., verses 446-450). The name Allo Tiranda signifies 'beaten against something' (Van der Veen 1924b: 370). An alternate name for this ancestor is Datu Merrante, 'The Lord who makes his home on level ground'. Perhaps the name Allo Tiranda is not an allusion to the tree but to the poison that it yields. There is, indeed, a story about Allo Tiranda's marriage to a tree with white stripes on it, a tree with long, white spots (Merok: 90-91) called, respectively, *kayu toding* and *kayu lando samara*. (A *toding* is actually an animal with a white patch on the forehead; a *lando samara* is a buffalo with a tail that is white from about halfway downwards.) This tree was *tongle-tongle*; in other words, it rose above all other trees. All other trees in the vicinity died and all birds which alighted on the tree also died. So the tale runs (Van der Veen 1924b: 370). The *ipo* is said to be the resin of the tree designated as *lite kayu*. Perhaps the tree thus singled out is the *upas*-tree (*Antiaris toxicaria*), but it is still more probable that it is the tree which on Kalimantan/Borneo the Dayak call *ipo*, the *Strychnos nux vomica*, which contains a vast quantity of strychnine. (Although *Antiaris toxicaria*, the *upas*-tree, also contains this poison, the amount of *antiarine* dominates.) That the *ipo*-poison, used to tip arrows shot from a blowpipe, is highly valued can be seen from the fact that the creation of this *ipo* is narrated not only in the *Passomba Tedong* but also in other traditions. It served to prevent Datu Laukku', the first man, from being trampled upon. In his *Aantekeningen over blaasroer, schild en pijl en boog bij de Sa'dan- en Binoeang-Toradja's* [Notes concerning blowpipes, shields and bow and arrows among the Sa'dan- and Binuang-Toraja] Van der Veen (1924b: 368-373) provides a clear exposition of how the poison is prepared and utilized, together with an account of the weapons and other utensils used in conjunction with it. The value of the *ipo*-poison also emerges from the bit of market information which he added: three small cylinders full, two fingers wide, were

worth a buffalo. The poison was used during head-hunting expeditions and on hunts.

VII.18 **Bilante (*Homolanthus populneus*)**

Bilante is used during a particular rite of mourning. One boils the leaves of this plant in water and then immerses clothing in the solution to dye it black.

VII.19 **Suke bombo**

This small plant (a *Drosera* species) catches insects; it is a 'meat eater'. Even ants can fall into this ingeniously constructed trap. In such entrapped ants, the Toraja believe, house the souls of ancestors. This is why the fly-catcher (*Drosera*) is named *suke bombo* or *suke-suke bombo*: 'That which has the form of a bamboo cylinder of the souls of the dead'. Should these plants be set on fire then belief has it the souls of the dead change into clouds which rise up in the West (the direction of the Land of the Dead) and bring rain, rain which promotes the growth of the rice (*Woordenboek*: 623, under *soeke*; and *The Chant*: 10).

VII.20 **Cotton and other plants**

Datu Laungku, ancestor of the cotton, was created out of the divine bellows in the upperworld together with the forefathers of mankind (Datu Laukku'), of the poisonous *ipo*-tree (Allo Tiranda), of the chicken (Menturiri), of the *kerbau* (Manturini), of the iron (Riako') and of the boiled rice (Takkebuku) (see VI.1.1). The ancestor of the cotton foretold how thread would be spun from him like the skiens of a spider web and that sacral cloths would be woven from them. In the *Traditions* reported by Ne' Mani', the original name for cotton is given as Rambutikembong, The Self-Unfolding Threads (alternate name: Datu Kembong, The Self-Unfolding Lord). "When men had a cover" (i.e. when men first wore clothing), the litany tells, "people had respect for each other as for princes" (Van der Veen 1976: 426-427). Occasionally, cotton has ritual importance: the *burake* purifies a bunch of raw cotton during one of the rites of the *bua' kasalle*-feast; this act possibly symbolizes the ceremonial purification of the atmosphere.

Below I have listed several additional plants which fulfil a role in myth and ritual:

The *bambalu*-liana is considered to bring good luck; cf. how this

creeper is used in the *merok*-ritual. The *kaise'*, a shrub with red fruits, appears in the myths of Polopadang and Deatanna and of Marampio Padang. In both narrations the fruits of the *kaise'* are stolen so that the shrub's owner wonders who the thief might be. *Ma'kaise'*, moreover, is a rite in the mortuary ritual of the *puang* during which clothing is dyed red with an extract from *kaise'* fruits. On this occasion, a buffalo and a pig are sacrificed. Red is the colour of blood and of life and the ceremony appears to allude to the fact that the *puang* arrives in the hereafter more quickly than others who die (and thus can begin sooner to protect the rice).

The number of plants that appear in Toraja myths is vast; many of these plants are used in performing various rites. Just as many other Indonesian peoples, the Mentawaians, for example, and other Toraja peoples, the Sa'dan are constantly busy with plants as part of their religious activities, including those designed to heal the sick (such as the *curcuma*-root). We will examine such practices when discussing the medicine men and women who employ the leaves (needles) of the *buangin* (*Casuarina equisetifolia*) and of the *passakke*, a plant with red flowers and small conical fruits which have a cooling effect and confer a blessing. The salutary *passakke* leaves are also present on the small shrine set up for the *deata* during the *manganta'* (see Vol. II). The leaves of the *darinding* also are used on this occasion.

Several plants act to ward off evil influences; the bloodwort, as earlier described, is one of these. The leaves are associated with the east-oriented rituals, just like the leaves of the *croton* (*Codiaeum variegatum*) and the young leaves of the sugar palm. The red flowers of a variety of gladiola, *danga-danga*, are also used in these ceremonies.

Bamboo provides the material used to build shrines, etc. in rituals both of the East and of the West. The *bate*, constructed from bamboo called *tallang*, is employed exclusively in the *deata*-sphere even though in the *bate*-song it is called the 'banner of Luwu'. This standard belongs to the rituals for the dead. Whereas this sort of bamboo (the *tallang*) was created in the upperworld, the bamboo known in Indonesia as *betung* (Toraja: *pattung*) came from the underworld together with the *nangka*-fruit, the banana and the sugar palm (cf. the tale of Marampio Padang, section VI.4.2b). Above all the emergence of the banana and the sugar palm from the underworld is difficult to explain, for the leaves of these plants have a function in feasts for the *deata*.

How the *tille*-reed (*Andropogon Halepensis* Stapf) is manipulated for purposes of divination and how it symbolizes, as it were, a ladder

to heaven, are discussed in the following chapter (see VIII.7).

Chewing betel plays a part in all ceremonies and has a major social function (since modern youth disdain to chew betel any longer, this social function is disappearing). For an exposition of the role of the use of betel during marriage celebrations, see Van der Veen (1950: 298). Betel leaves are a common motif in Sa'dan art (*pa'daun bolu*).

As far as the role of species of palm in ritual is concerned: via the tall coconut and sugar palm the souls of prominent dead climbed to the firmament. The leaves of some kinds of palms, the *lambiri* or pseudo-sugar palm among them, are employed during the great *bua'*-feast. The trunk of the *lambiri* serves as *simbuang kayu* at the place where *kerbau* are slaughtered during the great *dirapa'i*-ritual for the dead. It is the counterpart of the *simbuang batu*, the menhir to which the buffaloes are tethered and, apparently, symbolizes the palm by means of which the soul of the deceased ascends to heaven.

Finally, the parasol of persons of status was fashioned from the leaves of the fan-palm, the *kambuno*. Such a sunshade was a symbol of their dignity. The name of the first *to minaa* priest was Kambunolangi', the Sunshade of the Firmament (see IX.1 and Merok: 106 and 192).

The *lamba'*-tree is a kind of Ficus. The name *lamba'* is used to denote a person of rank.

CHAPTER VIII

MATERIAL SYMBOLS

“Hail to this soil, rich with blessings!
It is soil spread out like an old woven
cloth with *seleng* motifs . . .”

(Merok: 187)

In this chapter the symbols will be discussed which are manifestations of the Toraja's material culture, symbols which they themselves fashion in wood, stone or some other medium.

VIII.1 The *tongkonan*

“Hail to this house, with its front shaped like
the faces of the gods,
where the supreme feast is to take place,
abundant be the blessing upon this façade,
formed like the countenance of the lords,
where the foremost adat performances
are to be carried out.”

(Merok: 18, verse 6)

VIII.1.1 *General description of the tongkonan; function*

What do we mean when speaking of a *tongkonan*? It is a house that not only provides shelter but which, as the seat of a (sub)ramage, is the center of the social and religious activities of this group in its entirety. The word seat in this context is appropriate, for *tongkonan* derives from the verb *tongkon* which means to sit, to have become seated. The house commemorates the origin of the (sub)ramage, for at the moment that an ancestor founds a new *tongkonan* a new *rapu* originates. The process of ramification characteristic of the Sa'danese kinship system, has the consequence that there are *tongkonan* of varying importance, senior and junior ones. All have a name of their own. To each *tongkonan* a compound and number of *sawahs* belong; this property provides the resources for sponsoring feasts (organized with the house at their center) and for keeping the house in good

repair. Rice fields and groves of sugar palms are important in helping to meet *tongkonan* operational costs. Every *tongkonan* of some status possesses certain regalia. Other heirlooms and jewellery belonging to the family group can also be stored for safe keeping in the *tongkonan*.

The head of the (sub)ramage is in most instances the person who presides over the house and its goods; he need not actually live in the *tongkonan*, however. *The tongkonan is thus the visible symbol of the ramage.* Special constructions and ornaments are sanctioned for certain *tongkonan* of status which lesser houses may not permit themselves. Similar limits obtain for homes in general (the generic term for house is *banua*). Such limitations concern the privileges of having an *a'riri posi'* (a central post) under the house of adding a *longa* (a porch), and of applying woodcarving.

The houses and ricebarns of the Toraja fit harmoniously into the surrounding landscape. As architectonic creations they are every bit as impressive as the buildings on Nias, the houses of the Toba- and Karo-Batak, the Minangkabau and the buildings found on the Palau Islands. Resemblance to these houses is often extensive. The walls of the *adat*-houses of the Toraja are similarly ornamented with woodcarvings painted in black, white, brown and brownish yellow. Mother Earth provides the following pigments: yellow, red and redbrown earth. These earth colours are mixed with palmwine to make the paint durable. Black comes from the kitchen: black paint is prepared from the ash scraped from the bottom of cooking pots and pans. As fixer, sap drawn from the trunk of the banana tree is used. Nowadays people also make use of residue lubricating oil to acquire black paint. For the most part earth paints are used: *litak mararang*, red paint; *litak mabusa*, white paint; *litak mariri*, yellow paint. *Litak* denotes earth, yet it is also the word for paint; *litak malotong*, black paint, is not an earth product (the terms for these colours are borrowed from Tangdilintin 1975: 235).

The Toraja house stands on piles which, in cross-section, are rectangular or octagonal. The floorplan of the house — and that of the ricebarn as well — is rectangular. Just as with Toba-Batak and Minangkabau houses, the ridge of Toraja roofs turns upwards at both ends. (Cf. figs. VIII.1-VIII.5 for illustration of Toraja houses.)

When the house of a prominent ramage must be built, the first step is to erect the central post, the *a'riri posi'*, an operation termed *umpatama a'riri* or *umpabendan a'riri posi'*. A hole must first be dug in which to set the post; permission to dig must first be requested

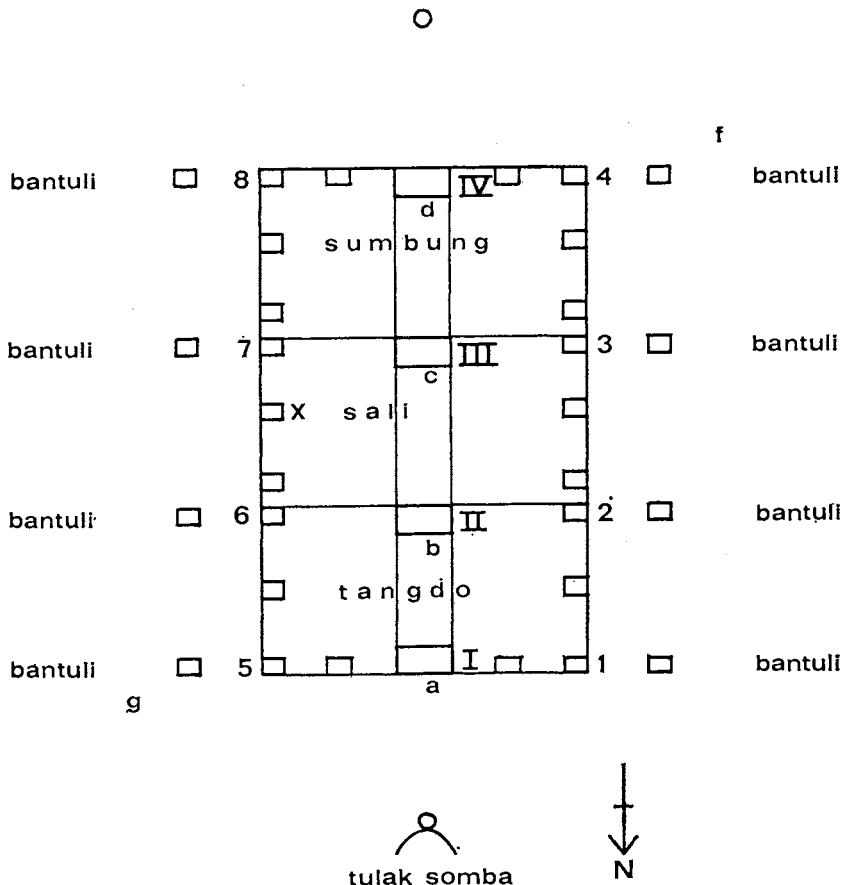

Fig. VIII.1 Groundplan of a *tongkonan*.

Key: 1-8 The *garopang*. These are connected by horizontal beams, the *roroan*; to the side of the *garopang* stand the *bantuli* which support the overhanging roof.

a-d The vertical *parande pata'* which rest on the earth. The piles without numbers are called *patongkon*. There are 24, 36 or 48 vertical piles, always a number divisible by 4 (this applies only to the outermost piles). Four, like eight, has a special significance in Sa'dan-Toraja religion.

I-IV The *petuo*: these rest on a horizontal floor beam which runs parallel to the ridge of the roof, the *pata'*. The *petuo* are a continuation of the vertical poles which rest on the ground.

III The *a'riri posi'*.

The *tulak somba* is fitted out with a buffalo head. In Kesu', however, this is far from invariable. In Tikala such a buffalo head can be seen more frequently. The long, protruding *katik* is attached to the front wall right in the middle. This wall is also decorated with life-sized wooden buffalo heads bearing real horns.

f. Site for placing offerings for the ancestors.

g. Site for placing offerings to the gods.

x. The hearth.

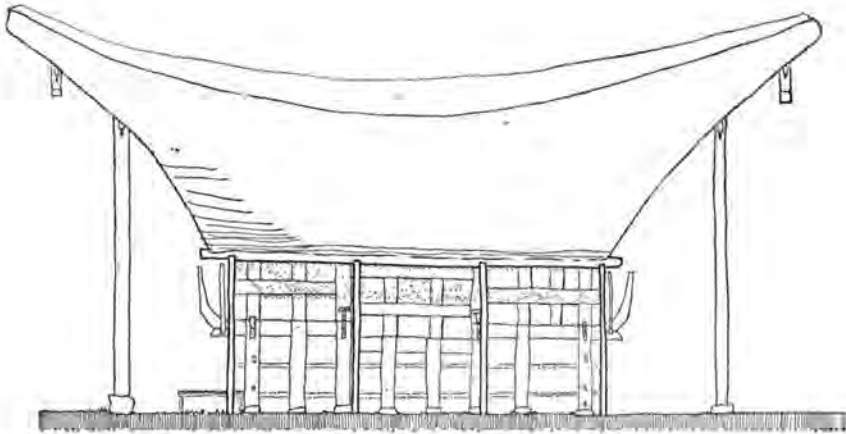

Fig. VIII.2 Side view of a *tongkonan*.

from the earth spirit, or spirits (*ampu padang*). At the bottom of the hole a yellow bead is placed. On the occasion of *umpatama a'riri* the carpenter sometimes sacrifices a pig. Then the workers proceed to set up the remaining posts. Some residences rest on as many as two dozen of such piles.

The *bantuli* are the vertical piles located outside the actual living area of the house; they help to prop up the roof. The extremities of the ridge of the roof of leading *tongkonan* are supported by two *tulak somba*, one in front, one behind (*tulak* = to support; *somba* = the venerated, exalted). Often a realistically executed image of a buffalo head is fastened to the *tulak somba*. This woodcarving (*kabongo'*) is fitted out with real horns.

No nails are used in construction of Toraja houses or ricebarns; beams and piles are tenoned and wood pegs hold joints together (for such technique, see fig VIII.4). Besides, they also make use of rattan ropes to bind components together. Houses constructed in this way, the Toraja maintain, are better able to withstand earthquakes than modern homes.

Horizontal beams are, of course, an important part of housing construction. An important beam is the *pata'* which, at floor-level, runs the length of the house down its center. The *pata' serre'*, 'the beam on which the house cat sits', supports the attic and runs parallel with the *pata'*. The arched ridge of the roof is attached to the *pata'*

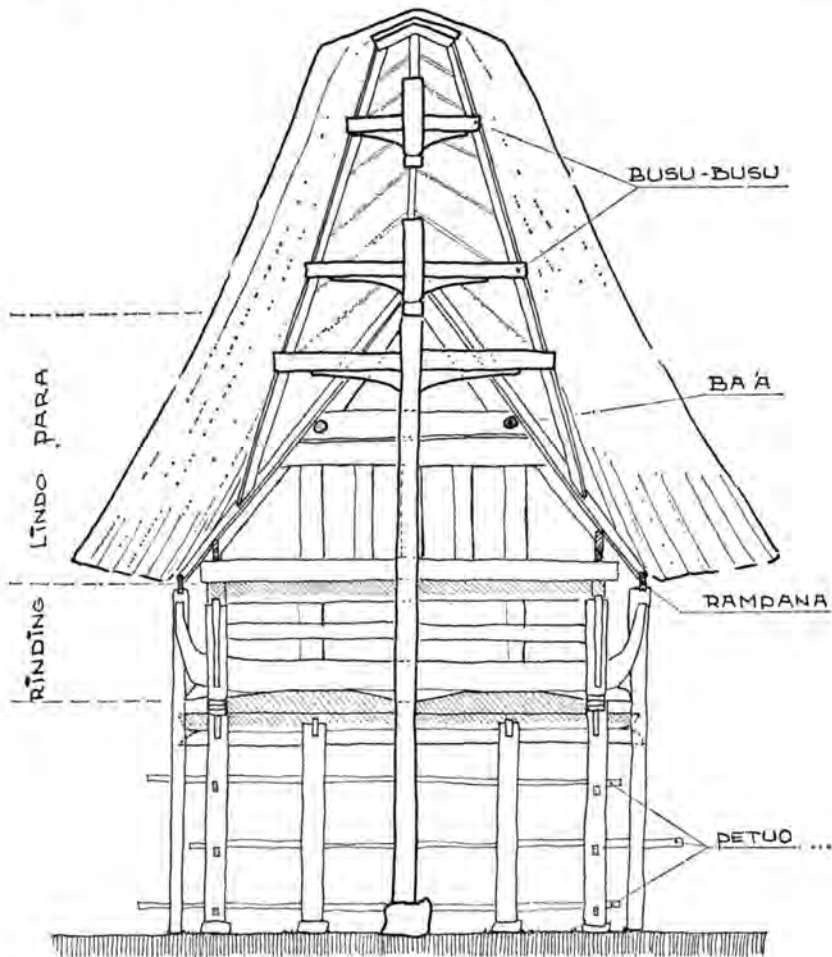

Fig. VIII.3 Front view of a *tongkonan*.

serre' with ropes of rattan. The framework of the roof is extremely complicated. It consists of various lengths of bamboo bent towards each other. Resting on the horizontal beams and inserted between the vertical piles, the walls of the *tongkonan* rise. If these walls (*rinding*) are covered with ornamental woodcarving, the carving is done before the walls are set in place.

Only the homes of nobility are allowed to be so decorated. More eminent *to makaka* may decorate their houses partially. Lower *to makaka* and (former) slaves must refrain from any ornamentation.

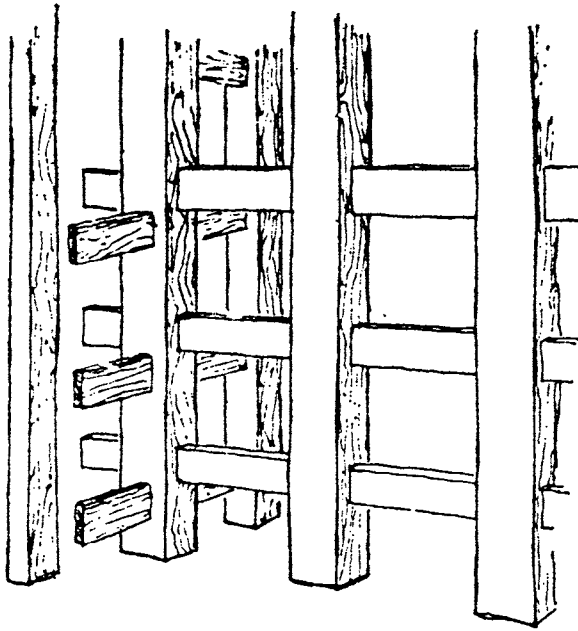

Fig. VIII.4 The house is supported by a vast number of tenoned piles.

The covering of the roof consists of bamboo stakes vertically split into halves; these are laid in parallel rows, concave and convex alternately overlapping (cf. Roman shingles, so-called 'monks and nuns'). In advance the lengths of bamboo are cut to size and brought into juxtaposition to make up required surface areas; they are then stitched together with rattan (see fig. VIII.5). After being stitched together

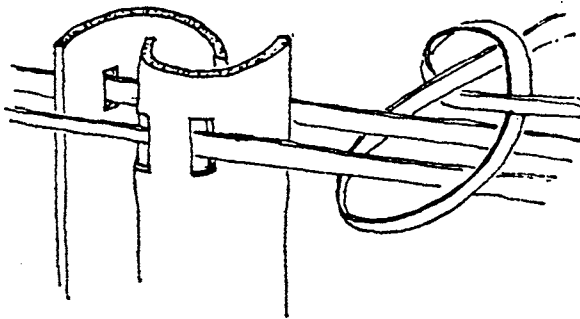

Fig. VIII.5 Fixing the roof shingles, bamboos which have been cut in half are stitched together with convex and concave sides alternating; this is how roof shingles are made.

the shorter segments are the first to be placed on the roof; they make up the bottom side of the roof. Hereafter follow the longer ones. This is the origin of the Torajan riddle, "Which came first, the mother (= the assemblages of larger bamboos) or the children (= the smaller bamboos)?" To which the answer has just been given.

Certain houses are provided with a verandah or porch (*longa*) created by the extension of the roof well beyond the front and rear walls. Such a *longa*, held up by the *tulak somba*, is a prerogative of nobility. Each detail of the construction of a house is, of course, subject to elaborate rules.

VIII.1.2 *The internal layout of a tongkonan* (see fig. VIII.1)

There are three or four rooms in a Sa'danese house. In the latter case there are four *petuo*, middle posts (cf. VIII.1.4).

a. The *sali*

Sali means, literally, floor. This is the central room of the house. The floor of the *sali* in contemporary houses is lower than that of the other living spaces (*Kesu'*). Formerly slaves (house slaves) and guests slept in the *sali*. Here, too, is the hearth: *dapo'*. The hearth consists of a wooden tray filled with earth. Three hearthstones support the cooking pot. (It is usual to have two sets of three hearthstones.) The triad of stones are an often quoted metaphor in myth and chant. Thus in the *Passomba Tedong*, the three most important gods, Tulakpadang, Gauntikembong, and Banggairante, are compared to the three hearthstones as a trinity (Merok: 67). Above the hearth a rack is suspended, the *palanduan*, on which firewood is stored.

The hearth is exclusively a woman's domain. Here, she cooks daily meals. (Food used during rituals is prepared by men in the open air.) The kitchen is located on the eastern side of the *tongkonan*, probably because of the association of prepared food, especially rice, with the sphere of the East (own interpretation).

But: the *sali* is also the room where the dead are placed on view before burial. A corpse, however, is set out in the western side of the house, for it is the West which is associated with the dead.

In the *sali* as well the *kabusungan* are kept the sacral goods which belong to the (sub)ramage — at least when a *tongkonan* is rich in status. Such goods are stored in the eastern portion of the room.

b. The *sumbung*

The *sumbung* is the room at the rear of the *tongkonan*, its southern

end, where husband and wife sleep. Its floor is higher than that of the *sali* (Kesu').

c. The front room

The front room of the *tongkonan* has different designations in different regions: *tangdo'* or *paladan bo'do'* in Sangalla' and Ma'kale; *tambing* in Kesu' and Rantepao. It is here that people eat together and that guests are received. The gallery which is situated in front of the *tambing* or *tangdo'* is also referred to by the name *tambing* or *tangdo' bo'do'*.

Some residences have four instead of three rooms. In old homes in Kesu' the *sali* is the front room and the floor of each new room as one penetrates deeper into the house is at a higher elevation so that such a *tongkonan* seen from the side is distinctly asymmetrical. Examples of this architecture survive in Sangalla'.

Partition of the *tongkonan*, at least as far as rooms are concerned, hardly corresponds with Toraja principles of cosmic systematization. With the cosmic system in mind, we might expect the married couple's bedroom to be the northern rather than the southern room. Even the central room would seem a more appropriate place. For the sake of completeness I should add that in the course of a marriage ceremony the bridegroom and his family go to the house of the bride and take seats in the front room, whereas the bride and her family assemble in the southern chamber. Yet, it would perhaps be going too far to deduce from this arrangement that in this case the south should be associated with the female element of Sa'dan society and the north with the male element. Let us remember: the woman's domain, the kitchen, lies in the eastern part of the house! In certain respects the *tongkonan* can indeed be regarded as a cosmic symbol — but this topic will arise shortly (see VIII.1.6).

In Kesu' the wall which separates the *sali* from the *sumbung* is adorned with the *ruma-ruma*, or *ampang bilik* (see VIII.2). This ornamentation includes images of a buffalo, a pig and a cock, the three animals which are sacrificed during the *merok-* and *la'pa' kasalle-* feasts, rituals which involve the participation of the entire family group (see also VIII.1.5). The *tongkonan* is always at the center of these rites.

VIII.1.3 Woodcarving; special motifs

Sa'danese houses in the old style are covered in woodcarving that

consists for the most part of geometrical patterns which have been coloured in. Several of the recurring motifs are associated with the upperworld; the *pa'barre allo* (*barre allo* = sun disk with rays), is one example. Two *pa'barre allo* designs appear high on the northern gable of the house. Often they are flanked by cocks, symbol of day-break. The sun motif is also at times applied to the inside of shutters, a clever inspiration, for when the shutters are thrown open the motif is literally brought to light. (For several illustrations of woodcarving motifs used on houses, see photo pages.)

Another conspicuous motif is called *pa'kapu' baka*, 'the tightly-bound basket'. Kadang (1960: 17, motif 13) offers the following explication of this motif: the pattern represents the basket in which all the valuables of the house, and of the family, are sturdily packed. Just as with the image of the sun, the *pa'kapu' baka* motif appears in many parts of the world: we meet it under the name *windu* among the Balinese, and under the name *bindu matogu* among the Toba-Batak. The figure, consisting of loops in an octagonal arrangement, is connected by these peoples with the underworld (in Balinese mythology the loops, in the form of two snakes, coil about the turtle Badawang who bears the world on his back). It is dubious whether among the Toraja the motif evokes similar associations: to them it is rather a symbol of prosperity. Even the *pa'bungkang tasik*, the sea crab, despite its home in the ocean, is not associated with the underworld. This motif is used on the north gable of the *tongkonan*, the part of the house corresponding to the upperworld.

When we compare the *tongkonan* with the traditional house of the Toba-Batak, or the chiefly residence in a settlement on Nias, houses of markedly similar structure, we are struck by the paucity of 'underworld'-symbols and motifs associated with the World Sea on Sa'dan-Toraja dwellings. In some instances, it is true, mythical snakes like those carved into the lowest horizontal support beams of houses on Nias do also appear in Toraja lands. On some older *tongkonan*, the front ends of the floor-beams have been crowned with wooden boards on which two snakes have been represented in relief, surrounded by the *pa'bulu londong* (= cock feathers) motif.

In former times habitations of the dead were also decorated with two snakes: ancient coffins, shaped either like a proa or a house. The snake was carved as an ornament onto the lid of the coffin which had the form of the roof of a Toraja house. It was cut out in com-

bination with the *pa'bulu londong* motif. These coffins, however, have since fallen into disuse.

Carving symbols are frequent which refer to the *kerbau*. The *pa'tedong* (= buffalo head) motif is often carved onto windows and doors, openings through which evil influences might enter into the *tongkonan*. Other ornaments also are composed of sharp *kerbau* horns, which, apparently, are considered capable of warding off feared influences. Even the ricebarn is provided with a buffalo head ornament.

Pa'doti siluang is a decoration made up of a combination of cross- and diamond-motifs. The name signifies: speckled *kerbau*. Such a buffalo is costly, consequently the decoration is an allusion to wealth and prosperity (desired on behalf of the house and its occupants). *Pa'barra'-barra* (= many grains of rice) is similar suggestive; Kadang (1960: 25, motif 21) points out that it expresses two wishes: an abundance of rice and of descendants.

Another ornament of houses which belong to nobility is *pa'boko komba kalua'*, the massive golden arm-band (which only noble women may wear). The motif refers to the class status of the owners. Other designs (which bear a close resemblance to each other) have to do with plants: *pa'baranae*, shoot of a banyan tree (Kadang 1960: 39, motif 35); *pa'lolo tabang*, shoot of a bloodwort (ibid.: 37, motif 33); *pa'takku pare*, paddy bending low (i.e. paddy with a well filled ear) (ibid.: motif 41) and *pa'batang lau*, stalk of the *lau* (= gourd, ibid.: motif 43). Banyan tree, bloodwort and rice are ritually important. The same holds true of betel chewing. One of its prime ingredients, the *sirih* leaf (*pa'daun bolu*) is a favourite ornament on the walls of Sa'dan houses (ibid.: 50, fig. 46).

In Kesu' many *tongkonan* are decorated with a *katik*, woodcarving representing a bird's neck with a head resembling that of a hen. Informants told me that the *katik* represents Lando Kollong, a mythical hen, 'She of the Elongated Neck'. In Sangalla' one does not find either *katik* or *kabongo'* (a wooden buffalo head with real horns). (For further information about woodwork motifs, a reader should consult Kadang 1960 and Pakan 1973.)

VIII.1.4 *The a'riri posi'*

Just as the earth itself is held up by Pong Tulakpadang, 'The Supporter of the Earth', so houses, too, are supported by a god or earth spirit (or several such spirits?). The *tongkonan* rests on short posts set into corbels on the ground consisting of stones cemented with lime. Among

the most important piles inside the house are those located in the middle. They rest on the horizontal floor beam which divides the house lengthwise down the center and buttress the ridge-pole which runs parallel to the central floor beam. They are called *petuo* (= supporters of life). In turn the floor beam is held up by posts which stand below the spots where the *petuo* are erected. The most crucial of these posts, hewn from *nangka*-wood, is decorated with woodcarving. Its foot rests on the earth; it shores up the middlemost *petuo*. This is the *a'riri posi'* which rests not upon, but in the earth. Its installation is preceded by ritual; sometimes the carpenter slaughters a pig for an offering (cf. VIII.3ff. and p. 246).

During the era when *tongkonan* still perched on the cliffs, before the Dutch Administration ordered houses to be relocated in the valleys, the *a'riri posi'* consisted of a circular stone pillar. *Tongkonan* Banua Sura' in Ba'tan, Kesu', has retained such an *a'riri posi'* in its possession.

A'riri posi' means, literally, navel post. It can be regarded as the symbol that the house, in the sense of a microcosmos, is vitally connected with the earth, the macrocosmos (own interpretation). Despite the designation 'navel post' the *a'riri posi'*, especially when of stone, looks much like a phallus.

During the *bua' kasalle*-feast, a bundle, called *anak dara*, is bound to the *petuo* which rests on the *a'riri posi'*. This bundle is composed of a banana-stem, various sacral leaves and other accessoires, all tied to a spear. The *anak dara* is fastened to the north side of the *petuo*. The name means virgin or sister. According to the Toraja, the *anak dara* is the female symbol of the family group. (Perhaps also in the sense of a fertility symbol, for women bring forth the children of the group; own interpretation.) The *anak dara* will be discussed in the context of the major *bua'*-ritual (Vol. II).

VIII.1.5 *The ampang bilik or ruma-ruma*

The *ampang bilik* appears to be a kind of fence consisting of three or four horizontal and three vertical planks (see fig. VIII.6). The term literally means 'the threshold of the house'. The *ampang bilik* figures in the *la'pa' (bua') kasalle*-feast. The constituent planks are decorated with carved, painted motifs. Although all kinds of variations occur, two snakes are never omitted.

In addition the following figures are depicted: a human being, certain birds (cocks or a *tambolang*), at times also *kerbau* or horses.

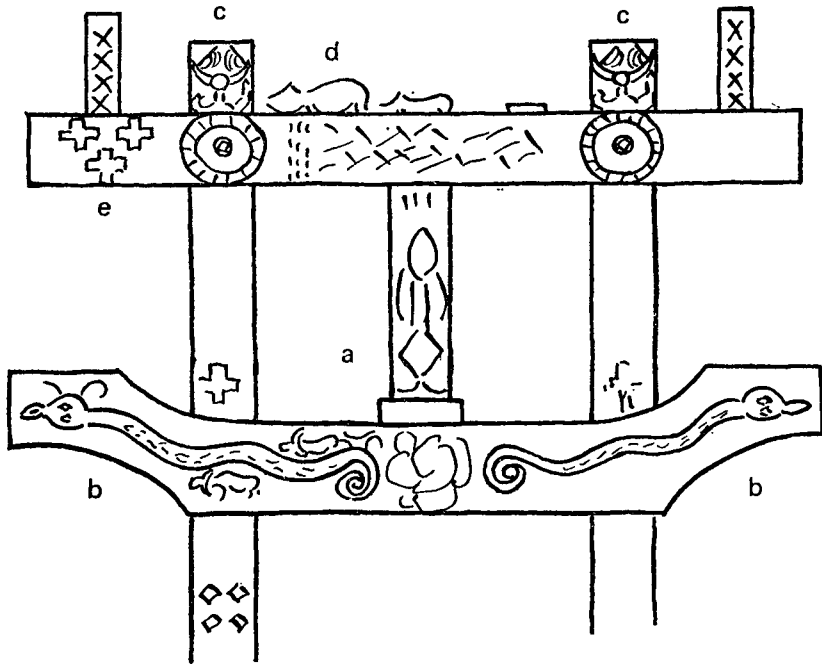

Fig. VIII.6 The *ampang bilik* in *tongkonan* Buntu Pune in Ba'tan, Kesu' (schematic representation):

Key: a. human figure

b. image of two snakes with, between them, the *pa'bungkang tasik*-motif (according to B. Sarungallo the snakes signify that the *ampang bilik* is considered sacral (see also fig. VIII.6a)

c. picture of the head of a *to manganda'* dancer; these dancers perform at the great *bua'*-feast (see also fig. VIII.6b)

d. *kerbau* and other animals depicted in 3-dimensional sculpture

e. *doti langi'*-motifs; these symbolize wealth and abundance.

(Sketch by S. Taub.)

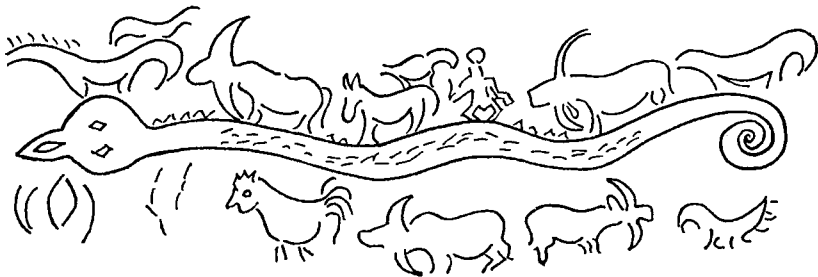

Fig. VIII.6a Animals portrayed on the *ampang bilik* of *tongkonan* Buntu Pune, Kesu'.

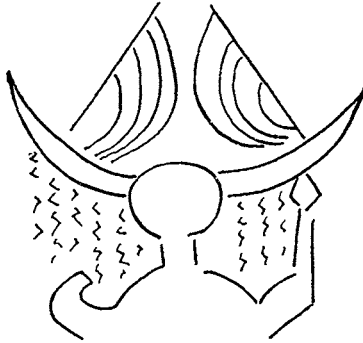

Fig. VIII.6b *Manganda'*-dancer depicted on the *ampang bilik* of *tongkonan* Buntu Pune, Kesu'.

The remaining ornamentation consists of geometric designs: the *pa'-daun bolu* (betel leaf that is offered as a sacrifice to the gods, but not to the ancestors); cross motifs (*doti langi'*) which symbolize wealth and abundance; figures which portray the leaves of the banyan tree (*pa'barana'*); moreover, the *pa'bombo uai*,¹ the *pa'tedong* (the buffalo head), and others. All are important motifs connected with life, or significant as symbols to keep evil influences at bay. Not in relief, but as three-dimensional images, buffaloes, painted in dark colours, and/or pigs stand on the cross-beams of the *ampang bilik*. A human figure occupies a central position. At times only a human head with the accessoires of a dancer appears, at times a body in entirety. It is not surprising that the *kerbau* is depicted considering the role which this animal fulfils during various rites. When a *bua' kasalle*-feast is celebrated in Kesu', the *ampang bilik* is placed in the *tangdo'*; upon conclusion of the feast it is transferred to the western portion of the rear wall of the *sali* as a memento of the fact that the *tongkonan* has celebrated the great *bua'*-feast. This location is remarkable, for the *ampang bilik* with its images of snakes, beasts, birds and man is beyond mistake a cosmic representation, the concrete embodiment also of the group's great feast: as such one would expect to find it in a more central place in the *tongkonan*.

It goes without saying that not all *tongkonan* have such an *ampang bilik*, but only the most important ones, such as those which have been the center of a great *bua'*-ritual. In Kesu' I saw these artifacts in *tongkonan* Tammunallo in Ba'tan and in *tongkonan* Buntu Pune, also

in Ba'tan. Most *ruma-ruma* (*ampang bilik*) in Kesu' were old and, to some extent, worn.

We do not know whether in Tikala and Riu, too, the *ruma-ruma* is also housed in the *tongkonan*, as a token that the members of this *tongkonan* have celebrated the great *bua'*-feast. The Toraja assume that by the placement of the *ruma-ruma* the southern room in the *tongkonan* is closed off from the central and northern rooms. This blockage conveys the symbolism of the *bua' kasalle*: the Southwest oriented rites are cut off from the northeastern ones.

VIII.1.6 *The tongkonan as a cosmic symbol*

Considering its form, the *a'riri posi'* can be conceived of as a phallic symbol. Yet its name, *posi'* (navel), suggests that it represents some connection with the cosmos. The house, connected through the *a'riri posi'* with the (macro)cosmos is itself a representation of this world order. The *anak dara* fastened to the *a'riri posi'* is a fertility symbol, the symbol of the women of the family whose very center is the *tongkonan*. Should many children be born to the group, that is a blessing for the *marapuan* (for the ritual which includes the appearance of the *anak dara*, see Vol. II).

The roof of the *tongkonan* — and of Toraja houses in general — is indeed on occasion compared to the sky. This can be noticed in the *ma'bubung*, the prayer that is spoken when the roofing of the *tongkonan* is renewed. A verse from this prayer reads: "God who arched the firmament downwards, lord who curved the all-enfolding as the covering roof" (Merok: 170-171, verse 18). Between heaven and roof an analogy is drawn. Besides every house on earth has its prototype in 'The Iron House' that was constructed in heaven. This 'Iron House' was roofed with sacral *maa'*-cloths (ibid.: 117, verse 587).

Renewal of the roof is a feast of great activity, featuring cock fights and gambling. During the *merok*-feast, when the ridge of the *tongkonan* roof is draped with pieces of bamboo which have been beaten flat, a prayer is delivered by the *to minaa* after he has presented an offering of betel and areca nuts. In this prayer the priest draws a parallel between the roof of the *tongkonan* and the heavens (ibid.: 4 and 168f.).

The northern part of the *tongkonan* is associated with gods and with the deified dead. This appears from the following: the bodily remains of the *burake tambolang*, the 'hermaphroditic' priest, a person of high status, is carried out through the north side of the gable of

the *tongkonan*; to do this a piece of this façade must be broken out. According to Van der Veen a similar exit is made for the *puang* and for family members of the *puang* (1965: 19 and 1966: 23). This is called 'the way of the gods' (*lalan deata*). Other corpses depart from the house through a door (*ba'ba sade*) in the western wall (West is the sphere of the dead). This egress is called *lalan bombo*, 'the way of the *bombo*' (the soul that has not yet been purified). For as important a man as the *burake tambolang* purification rites are not necessary: his soul ascends directly to the upperworld. The front part of the *tongkonan* is indeed spoken of as *lindo puang*, the face of the *puang* or the countenance of the *deata* (gods). The nomenclature suggests that the Toraja think of the house anthropomorphically. People also refer to the front gable as *ba'ba deata*, the door of the gods. The gods, to be sure, who inhabit the Northeast, enter into the *tongkonan* via its northern side (Merok: 19). An important *tongkonan*, connected to the earth by its 'navel post', is the symbol of the microcosmos.

VIII.1.7 *The house in history and myth; and the ritual of its construction*

The creation and development of things is an important theme in Sa'dan-Toraja myth. According to Bua' Sarungallo, houses too went through a process of development. The first type of dwelling is said to have been a small hut of shrubs. It was called *kalumba*. Afterwards people built the *pandokko' dena'*, literally: 'the residence of ricebirds', houses which only had a roof of bamboo. The next step was the construction of the *patongkon a'pa'*, a house resting on four piles but without any walls. Then people proceeded to the construction of a *banua tamben* which, my informant commented, resembled a cage or a stable rather than a human dwelling. This description, however, pertains only to the part of the *banua tamben* located below the actual floor. Several *banua tamben* can still be seen today, e.g. in the district of Tikala. In 1966 I saw a house of this type with wooden walls. It showed hardly any traces of woodcarving: decoration consisted merely of parallel lines notched in the wood. The space under the house indeed resembled a kind of corral made from horizontal poles.

The following phase in house development brought the debut of the *banua rapa'*, 'beautiful houses'. The name actually signifies a well-built, solid house (*Woordenboek v. rapa'* II). Although earlier houses were covered less bountifully with woodcarving, I consider it highly

doubtful that the Sa'dan dwelling followed the course of progress which Bua' Sarungallo outlined to me. The possibility cannot, of course, be discounted completely. Personally I am more impressed by the fact that contemporary *tongkonan* have so much in common with the houses of Nias, of the Toba-Batak on Sumatra, of the Palau islanders, and of other oceanic peoples. Further discussion of these similarities, however, would be out of place here.

A specific kind of house belongs to each specific class. Separate prescriptions determine the layout of each kind, and each has its own *aluk* (= ritual).

1. The house of slaves, *banua kaunan*, is not adorned with wood-carving; it is a *banua di pasituang*, 'a house which is passed by', which has nothing that is in and of itself important. The roof is of palm leaves, and when the house has been built, a minor rite is observed for a single day.

2. The *banua di sangalloi* (*banua* = house; *sang* = one; *allo* = day) are occupied by people who descend from a father of noble blood and a mother of the slave class. *Sang alloi* pertains to the fact that the consecration rite for this dwelling lasts one day. The same feast is celebrated for a small *tongkonan*. During the feast, no drums may be used. A *sokkong bayu* does not officiate, merely a *to indo*'. Houses of this category may be decorated with certain woodcarving motifs.

3. As the name implies, consecration rites for houses of the type known as *banua di tallung alloi* last three days. Here *tongkonan* are concerned which have an *a'riri posi*', the significant central post. When this is set up, a pig is slaughtered if the chief of the *tongkonan* is a *to parengnge*', a leading nobleman whose house is decorated with many sorts of woodcarving.

Below a summary follows of the sequence of actions and ceremonies which take place when a *tongkonan* must be renewed. When a totally new *tongkonan* is built, the procedure to be followed is the same. It may appear that the order of construction and ritual is rather illogical, yet we should keep in mind that the Toraja house (and this is true as well of their ricebarns) is the product of a kind of pre-fabrication process. The posts and piles of the house are cut and possibly carved and painted with designs before being brought into place. Walls, similarly, are completed as units before being added to the framework. The roof shingling is cut to size and stitched together before final positioning. The new piles, walls and roof covering are

assembled in the vicinity of the old house. The first ceremonies are observed before any actual construction of the house takes place.

Rites connected to the building, or repair of a *tongkonan* are celebrated in two phases. We begin with:

a. Rites associated with actual construction work (informants: Allo Rante from Ba'tan, *tongkonan* Banua Sura', supplemented by data from R. Panimba and B. Sarungallo).

1. First the *ma'pallin* is held, intended to ward off evil influences. The offering is also reported as part of the *merok*-feast (Merok: 156-158). Toraja informants told me that on this occasion a red cock (*sella'*) is sacrificed; according to Van der Veen this cock must be black.

2. The *manglika' biang* (see Merok: 158-164) which then follows may be celebrated on the same day as the *ma'pallin*. Once again, a red cock is sacrificed.

3. The next rite is that of *ma'lelleng kayu* (*lelleng* = cutting, i.e. the trees that are needed for construction; *kayu* = wood). A cock (of unspecified colour) is sacrificed.

4. For *ma'patassu kayu*, 'fetching the wood from the forest', again a red-feathered cock is selected for an offering. This and the previous rite are led by the *to minaa*.

5. After the *ma'tamben*, for which once more a red cock is sacrificed (possibly a pig instead), construction of the *tongkonan* commences.

6. Then follows the *mangrondon*, 'the pulling down of the ruin' (the old *tongkonan*), a rite conducted by the *to mano'bo* whose function will be discussed below.

7. For the *manglo'po' patongkon*, 'the digging of a hole for the first post of the house', the carpenter (*to manarang*) sacrifices a pig (at least, if the *tongkonan* is of high rank). Van der Veen asserts that this offering can be postponed until the *mangrara banua*, the feast which is held when the house is ready for occupancy.

8. For the *ma'pabendan*, 'the raising of the piles', a pig is slaughtered.

9. The *mangono'* comes next, 'the stacking of sections of roof covering in predetermined order'. The sections are sorted and laid out on the ground in such a manner that they can be put in place quickly and efficiently.

10. The placement of the floor beams which run the length of the house is observed with the rite known as *ma'palumbang pata'*. *Pata'* is the beam in the center which rests on the *a'riri posi'*. The name of the rite means 'to lay the *pata'*'. No animal is sacrificed.

11. Nor is any animal sacrificed at *ma'kemun rinding*, 'covering the framework of the house with walls'.

12. The last important rite before the actual *mangrara banua* begins is the *ma'papa*, 'laying the roof'. A pig is sacrificed. In addition various pigs are slaughtered as payment for those who have helped to lay the roof. With the *ma'papa* the first phase of the renewal of a *tongkonan* is brought to a close.

b. Then, possibly after an interim, follows the *mangrara banua*, 'the covering of the house with blood', a consecration feast for which members of the ramage from far and wide assemble. The feast continues for a minimum of three days. A diviner (*paita*) is consulted to select a favourable day to begin.

1. The first rite is the *mangrampung* or *mangrapu*, the making of a sacrifice as a family group at a place on the outskirts of the village.² The *to minaa* or the *matua ulu* presides. (For a description of the *mangrampung*, see Merok: 4, 166-168.) Then follows:

2. *Membase* (= to wash, to wash the hands, to cleanse) is a purification rite. A pig is sacrificed.

3. The next rite celebrated at this juncture, the *ma'pakande to matua*, 'the providing of food to the ancestors (of the Southwest)', is also customary during various other ceremonies (see Merok: 2). During *ma'pakande to matua* the ancestors are considered to dwell temporarily inside the house. Upon conclusion of this rite, the actual festivities begin. Those who have been invited to participate (*rapu*-members, friends and acquaintances) will by this time have arrived.

On the first day of the festivities *ma'tarampak* takes place, 'the placing of the small sections of roof covering along the edge of the roof'. This is also the name of the offering which opens the series of sacrifices which are customary whenever a new or renewed house is being consecrated. The *to indo'* leads the rite. In front of the *tongkonan* one, sometimes two pigs are killed; the meat is distributed among those present by the *to indo'*.

On the second day eight important functionaries come to the fore. The ritual is called *allona* (literally: high-day); it goes on for two days. The *sokkong bayu* leads the ceremonies; he recites the *mangimbo* (prayer) on the compound. The *datu baine* performs the *mangimbo* as well as the *ma'pesung* inside the house. In Ba'tan *donalu*, the title of *sokkong bayu* was connected to *tongkonan* Banua Sura', that of *datu baine* to *tongkonan* Tangdo' Ruma-ruma. In Ba'tan *diongan*, the *sokkong bayu* from *tongkonan* Ne' Pareakan performed the rite of *mangimbo*. The function of *to massanduk* (the one who serves the rice during ceremonies, usually a woman) was tied in Ba'tan *donalu* to *tongkonan* Banua Sura' and in Ba'tan *diongan* to *tongkonan* To' Kamiri.

In the morning the *ma'gellu'* is danced, a dance previously also done by men but now only by women. Its performance is restricted to rituals which are related to life.

Afternoons, women form into a line, singing and making dancing movements as they do so (see *Woordenboek* v. *dandan*). On this day many pigs are slaughtered, between one and somewhere up to three hundred. The carpenter, the *to manarang*, and the *to mano'bo* receive the largest portion of meat. From every pig they receive something.

On the third day follows *ma'bubung*, 'laying the ridge covering made of flattened bamboo-*betung*'. On this day of the *mangrara* a pig is sacrificed. The most prominent functionary is the *to mano'bo*. He walks back and forth on top of the roof, in his one hand carrying fire (a torch?) and wearing a wreath of red leaves from the bloodwort on his head. Dressed in a long coat (his clothing is compared to that of a Catholic priest), brandishing a sword in his other hand, he paces along the ridge; finally he hurls the fire down onto a *dulang* (a dish on a pedestal) which stands on the ground below. The *to mano'bo* portrays a champion or warrior; the performance probably is an expression of the *tongkonan's* prowess (own interpretation). Or, armed with fire and sword, he is a figure who must ward off evil influences (interpretation Van der Veen). His spectacular performance concludes the series of rites.

Throughout *mangrara banua* only pigs are sacrificed. For an extremely important *tongkonan* in Ba'tan (Banua Sura' and Bamba) a *kerbau* may, exceptionally, be sacrificed. At the renewal of *tongkonan* Kesu', the mother-*tongkonan*, several *kerbau* were even slaughtered. As a token that the *mangrara banua* has been celebrated, in Kesu' a

yellow board with a crenate-edge, the *bung allo*, is fastened beneath the central floor beam at the front of the house. Van der Veen denied any knowledge of the term *bung allo*; possibly *bunga' allo* was what my informant had in mind (*bunga'* = to open; *allo* = day).

Below I give a brief description of the *tongkonan* Banua Sura' (= 'The House Decorated with Woodcarving') in To' Bunbun, a section of the village of Ba'tan. This, the most important house in the village, has been somewhat modernized. In 1966 *tongkonan* Banua Sura' was the residence of old Ne' Sangga and his wife. Until his conversion to Christianity in about 1940, Ne' Sangga had been the *sokkong bayu* of Ba'tan *donalu*. Originally the house stood high up on the Malenong cliffs, a location chosen for reasons of defense (and possibly, too, seen as symbolically fitting for the elevated status of its occupants). After the definitive establishment of Dutch authority, the house was rebuilt on a lower site. In the 1930's renovation of the house began, lasting until 1957. Not before 1947 did renewal get under way in earnest — accompanied by the highest ritual, for the house is a *banua di tallung alloi*.³ Together with *tongkonan* Bamba, *tongkonan* Banua Sura' is the only house entitled to sacrifice a *kerbau* during the *ma'tarampak*. For this event all functionaries who are instrumental in the ritual — the *sokkong bayu*, the *datu baine* and others — were on the premises. A prayer of thanks to the gods preceded the offering.

The house, naturally, has an *a'riri posi'*. When it still was perched on the cliff, this central post was of stone: a cylindrical stone decorated with a zigzag line. At present this stone still lies next to the *tongkonan*; the current *a'riri* is hewn entirely from wood and decorated with carved designs. Inside the *tongkonan* the legacy of the group is preserved, heirlooms brought out for use during the feasts. The treasured goods include a mammoth Chinese vase dating from the Ming period, various *kandaure* and loin clothes of considerable length (on special occasions used as *tombi*, banners), golden krisses and the great wooden dish on a pedestal (*dulang*) which the ancestor Ne' Tikuali used. Ne' Tikuali was one of the *adat*-chiefs who provided leadership in the war against the Bonese prince Arung Palaka; he was one of the *to pada tindo* (see I.5). With infadible precision the worthy Ne' Sangga can enumerate the whole sequence of ancestors who have lived in the *tongkonan* since the time of To Batu, the founder of the house. At first the house was not decorated; then it was called *Mane toë* (? , presumably Manete). Ne' Sangga in his white *sambu'*, with his

grey hair and sharp nose, looking like a Roman senator, summed up his forefathers:

To Batu, a man;

Ne' Rorrong, a woman;

Emba Tau, a man, the ancestor who beautified the house with wood-carving, from which it acquired its present name;

Sanda Uma, a woman;

To Tarranuang, a man;

Ne' Tikuali who called the Sa'dan together in the 17th century to do battle against the Buginese;

Pongo Pasauran, a man;

Tato' Pasauran, a man;

Ne' Lai' Panda'panda, a woman;

Limbong Bulaan, a woman;

Ne' Masembo, a woman;

Ne' Malisa', a man;

Ne' Tikusugi', a woman;

Ne' Sangga.

In addition to the position of *sokkong bayu*, there remain a number of other titles, including that of *to indo'*, the leader of the rice ritual, which rest with *tongkonan* Banua Sura'. It is above all Ne' Tikuali, the distinguished hero, whom the *tongkonan* has to thank for its prominence.

Below I have described the *mangrara* as observed for a simple house (*mangrara banua di sangalloi*) held in Angin-angin *diongan*, Kesu', on October 23, 1966, 11.00 AM). The roofing of the house that had no woodcarving decorations, was renewed. Then followed the *mangrara*, the simple rite of a single day.

The disposition of guests was the usual one: dignitaries sat on the floor beneath the ricebarn, the most important among them sitting in front. Guests arrived with their gifts; women carried boiled rice in a bowl that was wrapped in a cloth, men brought *tuak*. Several pigs had already been slaughtered; their meat was being prepared in bamboo tubes. The *to indo'* performed the rite. From one pig an offering was prepared that was placed on a banana leaf. The offering consisted of bits of liver, heart, lung, fat, tail, a sliver from the thigh, the spine and the *buku lesu*, the important hip joint; added to it were glutinous rice, *upe* (a kind of taro with large arrow-shaped leaves), *tuak* and ingredients for chewing betel. The *pesung* was laid on a

bingka', a small winnow which was brought into the house where, on the east side, it was presented to the gods (Puang Matua, Pong Tulakpadang, Pong Banggairante, Gaantikembong and the *deata*, the ancestors who had ascended to heaven).

At this point the *to indo'* delivered the *mangimbo* (prayer), standing within the eastern portion of the house. After prayer, people ate. Meat was divided as is customary. Since the village is separated in two, each section with its own dignitaries, portions were also set out in two rows. In the process shares were also meted out to the *to matua* and to the *deata*, also to an important *tongkonan*, to the *to indo'* who recited the *mangimbo*, and to the *sokkong bayu*; thereafter meat was distributed to functionaries in both sections of the village — to the *to massanduk*, the *to mantobok*, the *to pabalian*, the *londong datu* and the three *matua ulu* (for these officials, see IV.2.2). Here I have chosen not to render in detail how the meat was divided, for one of my informants assures me errors were committed, deviations from *adat*-prescripts.⁴ Had only he been entrusted with arranging matters all would have gone as it should, for no one surpassed him in this capacity!

VIII.2 The ricebarn

The ricebarn is something of a smaller edition of a *tongkonan* with the significant difference that the piles on which the building rests are round, not square. Piles for the ricebarn are fashioned from the trunk of the *banga*-palm (Indonesian, *nibung*: *Metroxylon elatum* Mart.); these trunks are so smooth that mice cannot find any foothold to climb them. The piles themselves are also called *banga*. As a rule a ricebarn (= *alang*) has four piles, sometimes six. Beneath the *alang* an elevated floor is laid (*sali*), see fig. VIII.7 and 8.

To a large extent ricebarns are decorated like houses. Most of the ornaments are the same. Thus the *pa'tedong*-motif is common on ricebarns, just as the *pa'daun bolu*-ornament is. The bottom of the *sali* is often decorated with carved geometric designs which are coloured in with paint. Even the boards which form an extension as it were of the walls and which jut out under the *sali*, are ornamented with woodcarving. In Kesu', for example, this woodcarving entails stylized images of the *dena'*-bird, a species of ricebird; elsewhere, including Riu, Tikala, Pangala', the Sa'dan district and Rimbon, one sees entirely different images on the boards: rather than stylized motifs, scenes of daily life appear. Women who pound rice, men and women bringing

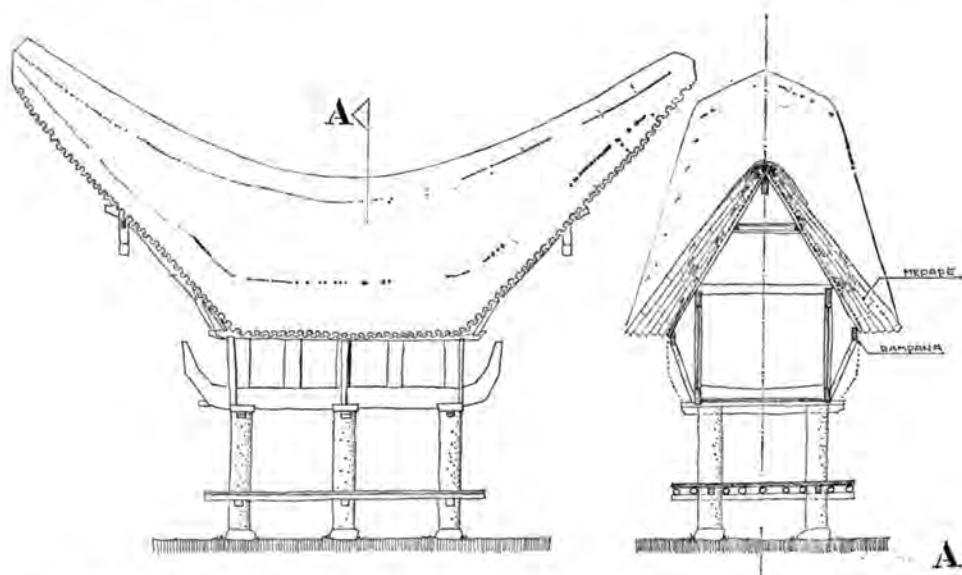

Fig. VIII.7 Side view of a ricebarn.

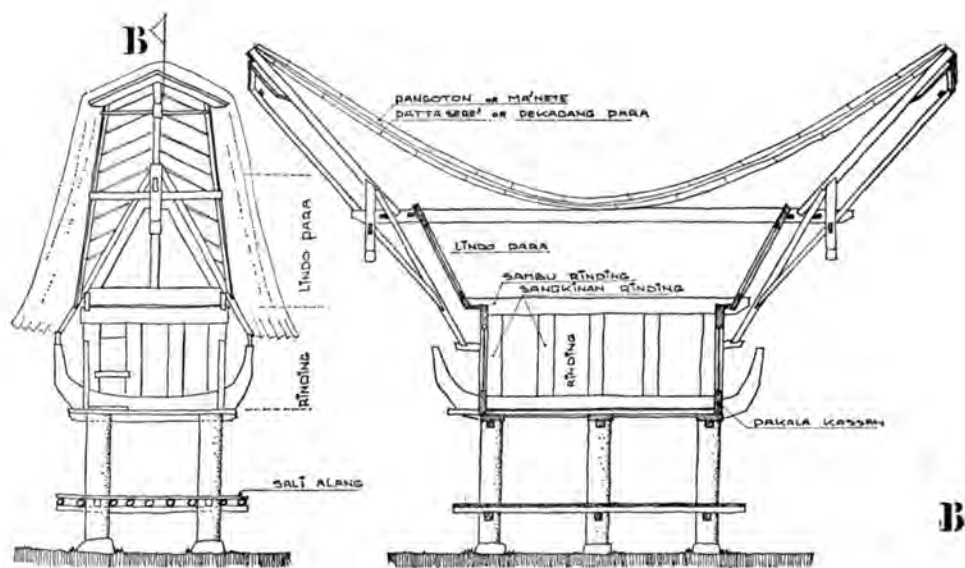

Fig. VIII.8 Front view of a ricebarn.

their wares to market, people setting out on a deer hunt, carrying staffs with a loop attached, used to capture deer as with a lasso in the manner that is also popular in Buginese and Makassarese areas (and in South-China). Or horsemen with soldiers afoot, or *kerbau* and pigs that are being brought to a ritual for the dead. Buffalo and swine are pictured frequently, usually in the form which people consider the most beautiful.

Certain ricebarns — the large ones in Kesu' and Buntao' — are decorated with a *kabongo'* (= wooden buffalo head with real horns). Like the *tongkonan*, the ricebarn is a status symbol. People see how wealthy a family is by the dimensions and the woodcarving of these buildings.

The primary function of the *alang* is the storage of rice, but the barn has other uses as well. The *sali* is a work place; this floor furthermore serves as a place for people to sit or to sleep during mortuary feasts. When guests sleep there, cloths woven from fibers are draped around the *banga*. The *sali* is also where people sit when meetings of fellow villagers are convened. The compound of the village head or of the most important *to parengnge'* (Kesu') is where such meetings take place; then the *sokkong bayu* and the *datu baine* sit in the front of the *sali* of the *alang*, the former to the left, the latter to the right. The ricebarn is situated invariably opposite the *tongkonan* so that during ceremonies the *sokkong bayu* and the *datu baine* sit in the southern part of the barn.

Ricebarns — and *tongkonan* — are not of uniform appearance in the various parts of Tana Toraja. One finds roofs covered with bamboo-shingles especially in Kesu', Buntao', Tikala, Tondon, Nanggala, Sa'dan, Madandan, Ma'kale and Sangalla'; in these districts houses and ricebarns decorated with coloured carvings are also common. In Bittuang roofs consist of shingles made from small slats of wood; in Mengkendek the roofs of dwellings and ricebarns alike are covered with *ijuk* (Indonesian: black fiber growing between the leaf-sheathes and the stem of the sugar palm).

The form of the buildings varies as well as the materials used in construction. In Bittuang houses are wider than in Kesu'. The execution of details also differs in various regions but these are of small consequence in this context. What is of importance is that ricebarns as well as houses fulfil a role in ritual, albeit that the prominence of *tongkonan* prevails. *Tongkonan*, moreover, are not exclusive to Tana Toraja; they are found also in Mamasa, in Luwu', and in Duri.

VIII.3 Other symbols: *kandaure*, swords, *krisses*, sacral textiles and drums

The objects discussed in this section are used during both the *rambu tuka'*-rituals, those of the East, and the *rambu solo'*-rituals, those of the West.

VIII.3.1 *Kandaure*

The *kandaure* is an ornament fashioned of beads. It is shaped like a casting net or a half-opened parasol. When it is used as an ornament for vivifying a ritual, the *kandaure* is stretched upon a frame of bamboo-rods that is reminiscent of the rib-work of an umbrella. The bamboo frame is then set on a pole. When during the *gellu'*, which is performed as part of the *maro*-ritual, the female dancers wear the *kandaure*, the ornament hangs over the back with its fringe of beads knotted on the breast. The human figures on the upper edge of the *kandaure*, eight in number, then stand on their heads. I suggested there might be some connection between this position and the contents of the *gelong maro*, the *maro*-songs which make mention of things which have been stood on their head or are somehow inverted, but my informant Bua' Sarungallo rejected this idea. He had a practical explanation for the way the *kandaure* was worn: it would be difficult to fasten it in any other fashion. Only girls or young women wear the *kandaure* at a *maro*-feast, whereas during mortuary rituals (e.g. the *ma'parando* in Sangalla') male greatgrandchildren also may dress in the ornament. At a mortuary feast the fringe of beads is not knotted on the breast, but braided. A bride in *adat*-costume also has a *kandaure* on her person. The bead plaitings of the *kandaure* are attached to a woven band. People no longer are able to weave such bands although in the past they did indeed make them by a kind of card weaving.

The bead ornaments often have a proper name; *Daranding*, for example, is the name of the *kandaure* which was in the possession of Allo Rante (Ne' Sangga'), the former *sokkong bayu* of Ba'tan. This *kandaure* was believed capable of preventing rainfall.

Kandaure are precious and can have a value of one or more buffaloes. The price depends in part on the beads: should many expensive *masak* (a kind of ancient bead) be part of the ornament, then its value is high. Some *kandaure*, similar to *maa'*-cloths, are considered sacral.

Certain *kandaure*, indeed, are more than merely decorative but

contain power to do something: to bring rain, for example. *Kandaure* belong to a particular *tongkonan*; they can be given out on loan, but then some favour is demanded in return.

The *kandaure* is used as a metaphor to denote a prospering ramage (Van der Veen 1929: 409).

VIII.3.2 *Swords*

Many swords are also looked upon as having religious significance. An ancient sword with a decorated handle of carved horn is called a *la'bo' pinae*. It is assumed that these *la'bo' pinae* came down from heaven together with the *to manurun* (ancestors). The blades of these swords are damascened, and the design of the inlay helps determine the value of the piece. Like the *kandaure*, these swords have proper names. Also like the bead ornaments, they are used during rituals for the dead as well as during *rambu tuka'*-feasts (= feasts of the East). The manner of their use varies considerably. During the *maro* and *ma'bugi'*, these *la'bo' pinae* are used to inflict blows or cuts during trance; in the course of the former feast they also serve as a symbol that dispels evil influences.

VIII.3.3 *Krisses and other weapons*

Krisses (*gayang*) are not as highly treasured as swords and *kandaure*. Rather they are symbols of the wealth of the (sub)ramage, or of the prestige enjoyed by the wearer. They are part of the costume of the female *gellu'*-dancers. Men wear them at certain rituals falling in the sphere both of *rambu tuka'* and *rambu solo'*. Men who command respect wear krisses when observing the *dirapa'i*-ritual. The daggers, by grace of their golden appearance, convey some aura of things heavenly, but they are not thought of as sacral (there are exceptions, however). They are also hung on the front wall of a house of mourning during certain rites, and attached to the *sarigan* and the portable chair of the *tau-tau* (see mortuary rites, Vol. II). In the past a dead man was furnished with a kris in his grave. The model of the kris hints at a Balinese or Javanese origin.⁵ Presumably the Buginese imported them. The handle, an anthropomorphic figure, resembles the handle of Balinese krisses. The sheath, however, is of Buginese form. People are able to identify certain krisses as of non Tana Toraja manufacture. Later Toraja goldsmiths made copies. Manda' was a renowned goldsmith.

Other weapons

A number of other important weapons deserve mention. *Mata Bulaan*, 'The Golden Eye', is the name of the sword of Manaek, the female ancestor of Nonongan. The *Duabontik*, also called *Tallutopongna*, is a weapon which, according to tradition, belonged to the female ancestor Lai' Bue, the daughter of Tangdilino and Buenmanik. This weapon is compared to a hook by which the *rapu* (ravage) can rake in prosperity and precious possessions (Merok: 184-185). The *Kayok* is an ancient sword which is the property of the most outstanding *rapu* in Buntao'.

VIII.3.4 *Sacral cloths*

Among the most important artifacts of the Sa'dan-Toraja are their textiles which are used at feasts and mortuary rituals. *Pio*, loin cloths, often of great length and with motifs woven into the fabric at both extremities, are also of significance. These *pio* are hung out as *tombi*, flags or banners. Usually these are *pio uki'*, loin cloths with woven designs, usually geometric but occasionally representative (e.g. a team of *kerbau* harnessed to a plough, pigs, a cock), at both ends. The *sarita* are tinged with religious value: light and dark blue cloths of uncertain origin, narrow in shape, *sarita* are also displayed as a kind of pennant. Of greater sacral value, however, are the *maa'*-cloths, old *cinde's* and other cloths from India, probably imported to Sulawesi (Celebes) by the Dutch East India Company and later traded to Tana Toraja by the Buginese. Such cloths can be worth 10-20 buffaloes. They are stored in a basket. Before a *maa'*-cloth is taken out (which is always an act performed by a woman), it is first given a 'kiss', that is to say that the cloth is held for a moment near the nose and then breathed upon. The sacral cloths have various patterns:

daun bolu, betel leaves, blue and red. A fabric with such a pattern is exhibited during the *merok*-feast and the *mangrara banua*-ritual; *doti langi'*, 'spots of heaven' (= stars), a cross motif. The cloth with this motif is hung out on display when the *merok*-feast or *mangrara banua*-ritual is observed;

oli barra', 'ears of rice'? (*barra'* actually means hulled rice). This cloth is shown not only during the *merok*- and *mangrara banua*-feasts, but also during the *maro*-ritual and mortuary feasts;

lotong boko', 'a buffalo with a black back', named after the dominant dark colour of the cloth;

seleng, a textile with a cross motif (see Merok: 186-187).

Further patterns mentioned by informants include: *busirrin*, 'that which has the scent of ants'; these are cloths with a design of ant figures; *maa' to unnorong*, fabrics with figures of small swimmers; and *mata puyo*, textiles decorated with quail eyes.

Sacral cloths are displayed on the occasion of diverse rituals. They can be worn by certain individuals; and they can be used in other ways.

Below there follows a summary of how the holy fabrics are ritually employed:

a. During the mortuary rituals: the corpse, which has been swatched in sheets, is covered with such a cloth; the back of the *kerbau* called *parepe'*, the mount of the deceased on his passage to the Land of the Dead, is draped with a *maa'*-cloth; during a particular rite of the *dirapa'i*-feast, female relatives take their place under a *maa'*-cloth known as the *duba-duba*; sometimes the roof of the litter in which the deceased is conveyed is decked with a *maa'*-cloth.

b. During rituals of the East: the heads of the *anak dara*, women or girls who play a part in the great *bua'*-feast, are covered during certain rites with *maa'*-cloths.

Sacral *maa'*-cloths are often carried on the head. In addition to the *maa'*-cloths, some other textiles have a holy aura as well, such as the fabric that is said to have been made by Manaek, the important female ancestor of the Nonongan rames. Whoever wants to lay eyes on this cloth, must first sacrifice a small, pied pig. Also the Bate Manurun should be cited in this context, an ancient textile resembling a batik; it is one of the sacral heirlooms of the princely house of Sangalla'.

The textiles are thus of ancient origin. Today, however, imitation old *maa'*-cloths are occasionally fabricated by printing cloth with a bamboo stamp of traditional model. These imitations are made in the villages and districts of La'bo', Pangala' and Riu. In myth the sacral cloths are frequently compared to rice and to abundance, with the (fertile) earth or with long life (see Merok: 180f., 186f.).

Even *tali bate'* (square batik head cloths imported from Java) are used as a kind of pennant and hung out during ceremonies. On special occasions these same cloths may be worn by the *to minaa* as a head-dress. In the category of sacral textiles one may further include a number of cloths, bags, etc. with woven motifs. They are all old; their appearance testifies to their age. Moreover, nobody any longer weaves cloths with such motifs; the relevant technique has been lost. One of

these textiles is a carrying bag with human figures (now in the possession of Indo' Lai' Rante of Ba'tan), another, the *Tannuntang-mangka*, the Uncompleted Cloth of the female ancestor Manaek of Nonongan (see Merok: 63 verse 299 and Nooy-Palm 1969: 186).

VIII.3.5 Drums

Outwardly drums (*gandang*) which are beaten during a mortuary ritual do not differ from those played at a *deata*-feast. But the same drum used during one of the latter occasions, may never be played during a ritual for someone who has died. The distinction extends yet further: there is one *gandang* which is reserved for use during the *merok*-feast alone, and another which is played during the *mangrara banua*. When the drum is beaten at the great *la'pa'* (*bua'*) *kasalle*-feast, this signifies that everything which is not good in the family 'is done away with'. The drum has a purifying function.

During ritual, a *pesung* and betel are placed as an offering on the drum; first one lays down the betel, then the food on the banana leaf.

VIII.4 The grave, 'the house from which no smoke rises'

It has been reported that seven to ten generations ago people in Tana Toraja first began to scoop out graves in the cliffs (Van der Veen 1924a: 364). At that time they also adopted the custom of fashioning *tau-tau* (dolls) for the dead, as well as preparing *tuang-tuang* during the *dirapa'i*-ritual (which is only made for a deceased who, during his lifetime, had captured an enemy's head). In Sangalla', however, a *tau-tau* was found in the company of coffins of more ancient kind. It is difficult to venture an explanation for the introduction of burial in rock graves. Security reasons could have been one reason, the desire to commemorate status differences another. The higher a person's status, the higher the final resting place hewn out for him in the cliffside.

The Toraja rock grave, 'the house from which no smoke rises' as it is called in the death chants, is sealed with a wooden door which is usually decorated with the stylized head of a *kerbau*. The door which shuts out the outside world, lends itself to a symbolic interpretation (yet: outside the grave stand the *tau-tau* which represent the deceased; they look down on the comings and goings of the living). Behind the wooden door a short corridor half a meter long opens onto a square chamber which, from grave to grave, varies much in its dimensions. In this chamber the dead are deposited, next to or on

top of each other. The graves thus are family tombs. Sometimes one finds a second chamber, joined to the first by a short hallway. In the front chamber the *kaunan* were laid to rest so that their master, when both had died, would constantly have his slaves available to serve him (it must be stated emphatically that a slave was never put to death upon the demise of a prominent personage). The custom of burying *kaunan* in an antechamber was already popular among the more well-to-do *to makaka*. A *to parengnge'* or a *puang* could during his lifetime designate a household slave who later would be buried with him in his rock grave. The digging out of the graves is work for experts who come from Bori' and Riu.

Some rock graves are very high up in mountain cliffs (at Sangbua' and in Sangalla', for example, and on the slopes of the Sesean); others are comparatively close to earth, hollowed out of boulder (in the river basin of the Sa'dan, for example). Other forms of rock graves are hewn out from the summit of a large slab of rock or a boulder downwards. On top of such a *patane* a small house is built in the model of a *tongkonan*; in the house *tau-tau* find a place. Beneath the living quarters of the *tau-tau* a highly realistic wooden *kerbau* (or horse) is stabled. One such grave is found near the village of Kalambe; Pong Maramba' had it prepared for himself and his family (A. C. Kruyt 1923/24: 163). Elsewhere, too, one comes across such mausoleums but in Kesu' they have come to be replaced increasingly by rectangular constructions out of cement (which people also call *patane*); these are preferred because they are less vulnerable to theft. *Patane* are constructed for those for whom the *dirapa'i* death ritual is observed.

The further west one travels in Toraja regions, the fewer rock graves meet the eye; on the right bank of the Masuppu' River they cease to appear. Between the Masuppu' and Mamasa Rivers the dead are buried in coffins placed in small huts which have the form of a Toraja house. These houses are called *tangngan* (in Rantepao this term either denotes longitudinal floorbeams, or else a lath laid as a girder underneath a coffin; cf. Van der Veen 1923/24: 365, note 26). In these burial houses people hang sunhats, betel baskets and pouches and other household accessories. Also cat's cradles (figures made out of thread) are installed which, according to A. C. Kruyt, represent the *barre allo* (sun-ray motif). Here, too, with greater frequency than in the region of the Sa'dan-Toraja, one encounters images of a rider on horseback. For further details concerning these *tangngan*, see A. C. Kruyt 1923/24: 165ff.

From the moment he dies a man of some status is always sheltered under a roof or covering which has the shape of a *tongkonan*. The *sarigan*, the palanquin in which the remains of the deceased are transported to the *rante*, the place where buffaloes are sacrificed, and then on to the grave itself, is also fitted out with such a roof.⁶ Such a beautiful litter is only used during more significant rituals for the dead. It is ornamented in various ways. Sometimes there is even a small *katik*. A *sarigan* in Tikala which I found abandoned near a grave, had *payung-payung* (figures of thread) which dangled from the roof as ornamentation. Besides, *sarigan* used to be decorated with woodcarving motifs: *pa'tanduk rape*, *pa'bulu londong*, *pa'doti langi'*, *bua tina* or others (cf. also Kadang 1960 and Pakan 1961). The roof of the *sarigan* is at times studded with feathers.

Some twelve to twenty men are needed to carry the *sarigan* to the *rante*. Here, the deceased, swathed in winding sheets, is transferred to the *lakke-lakkean* or *lakkian*, a hut on high poles where he resides during the festive days passed on the slaughtering place of the buffaloes.

The *lakkian* stands on six poles; it is for two thirds decorated with red, and for one third with yellow material. At the ends of the roof and to one side of the *lakkian*, *tombi* are exhibited; *kandaure* also belong to the decorations (see Bodrogi 1970, fig. 6). The stay of the deceased in the *sarigan* and *lakkean* are to be regarded as transitional phases in his progress from the house of mourning to his final resting place, the grave.

VIII.5 The tau-tau (effigies)

The word *tau-tau* means 'little person', or, also, 'like a person'. Spoken rapidly the words sound like *tatau*. The *tau-tau* is the image of the deceased, dressed in clothing, complete with accessories and jewellery (*Woordenboek v. tau*). The effigy is more than a memorial statue as we know it, for it is thought to have a soul, the soul of the deceased.

VIII.5.1 *Manufacture of a tau-tau*

A specialist (*pande tau-tau*) fashions the effigy out of *nangka*-wood. Certain individuals have won fame in the making of these dolls; the carving supplies them with supplementary income. Well-known *pande* are Teken in Kesu' and Pong Salapu in Sangalla'. Resemblance to the deceased is the specialist's goal. Nowadays, since some *tau-tau* craftsmen, Teken, for one, have had training in sculpture on Bali,

increasing verisimilitude is being achieved but, it seems to me, at the cost of something of the fascination and mystery characteristic of early death dolls.

Manufacture of the *tau-tau* is accompanied by offerings. They will be discussed in Vol. II. Here the technique demands our attention. *Tau-tau* have the genitals of whichever sex which they represent. The dolls have movable limbs so that, for example, even the forearm and upperarm can be detached from each other. The head, too, can be removed. Old effigies found in the vicinity of ancient coffins, do not have movable limbs.⁷

The *tau-tau* are clothed exactly like a Toraja of status — in an early phase of the ritual, in simple garments, but in grand apparel when he is carried to the slaughtering place of the *kerbau*.

Finally the *tau-tau*, approximately one and a half meters tall, are set up beside the rock grave. As they represent the deceased, offerings are made to them. This explains Protestant opposition to the inclusion of the dolls in the burial ceremony. At the funeral of Lai' Kalua' (end 1930's), however, a *tau-tau* was part of the procession in spite of the fact that, before she died, she had converted to Christianity. For the burial of a woman of prominent descent, which took place in Kesu' in 1975, a *tau-tau* was also created. The effigy prompted protests from several family members and from the deceased's church, the Protestant Gereja Toraja. In 1978, however, an effigy was carried in the cortege of a Christian funeral.

VIII.5.2 *Function of the tau-tau*

The *tau-tau* is fashioned before the second phase of a major mortuary ritual for the dead commences. During the manufacture of the doll, the woodcarver sleeps near (or even under) the house where the deceased lies on view. Actual work on the effigy also takes place in the vicinity of this house, possibly even on the floor of the ricebarn opposite the *tongkonan*. When the image is completed it is placed beside the dead. Just like the deceased, the *tau-tau* receives food to eat (an offering, indeed, for giving food to the *tau-tau* is a ritual process). All this occurs before and during the second phase of the ritual, in other words for quite some time, as the time lapse between the first and the second phase of the ritual can be considerable. When the deceased is brought down to the floor of the ricebarn to lie in state there, the *tau-tau* is also brought down and set in position before the barn. Before this the effigy stood in front of the *tulak somba* of the

house. The doll then had on rather simple clothing, for a male *tau-tau* a pair of short white trousers (*seppa tallu buku*). The outfit remains unchanged when the *tau-tau* takes position in front of the ricebarn. Only once the effigy together with the dead — and in the same manner — is carried in a palanquin to the slaughtering place of the buffaloes, does it acquire fancy dress. A head-dress appropriate to the status of the deceased is set in place, expensive jewellery is hung round the doll's neck, and his body ornamented with sash and krisses. At the slaughtering place of the buffaloes, the *tau-tau* remains in the immediate vicinity of the corpse.

The *tau-tau*, stationed before the grave (or on top of it) keeps alive the memory of the ancestor 'of old'. Once every so many years, his clothing is changed, usually before burial of a new person of rank takes place. From a great height, one by one, the effigies are carried down where they are carefully dressed anew, later to be carried aloft again to their posts in front of the grave. "That it Puang X", people cry out as a doll is carried down from the cliffs. "And that is Puang Y". Older people often recall exactly who the effigies (in Suaya more than a dozen in all) represent.

That the effigy only plays a role shortly prior to the second phase of the mortuary ritual is probably a matter of the 'maturation' of the deceased. In the first phase of the death feast, *aluk pia*, the 'child ritual', the deceased has not yet attained a state in which he can do anything for the rice and for his descendants. During the second stage of the death ritual, however, he already approaches that state. Then the *tau-tau*, the image of the deceased, the 'living dead', is stationed beside the corpse. In the course of the first phase of a death ritual for an extremely eminent personage, a temporary *tau-tau* is occasionally fashioned from a bamboo rod. Decked with clothes this effigy rather resembles a scarecrow. Such a temporary *tau-tau* is called *bate lepong*, and will be further discussed in our description of the *ma'batang* in the village of Parinding in Tikala (Vol. II).

VIII.6 Megaliths

VIII.6.1 Description

Ethno-historians of the culture-historical school would classify the culture of the Sa'dan-Toraja as megalithic. Within the process of European-Asiatic diffusion, they discern a number of sub-currents (see, among others, Heine-Geldern 1932, 1952; Kwang-Chih 1959; Perry 1918; Riesenfeld 1950). For Indonesia, Heine-Geldern distin-

guishes two culture streams: the older one, identified by the occurrence of menhirs and dolmen, used implements dating back to neolithic times; the younger one, characterized by stone sarcophagi and ancestor statues hewn from stone, had tools of iron and bronze. The culture of later origin, moreover, had mastered the art of weaving; its decorative motifs were characterized by the appearance of spirals (bronze age design).

Although the Toraja erect menhirs, they have no stone tools, only iron ones. Besides, they have mastered the art of weaving, and spirals often turn up in their decorative art. All this demonstrates how slippery a business such categorization is.

Certain traits, however, are of more general occurrence: where menhirs are found, headhunting is usually practised also. A case in point is Tana Toraja though not in all locations. And where the Toraja did not hunt heads, they nevertheless set up great slabs of stone! Such monoliths are found most of all in societies with a certain degree of social stratification. Menhirs often are status symbols — as they are among the Toraja.

The German ethnologist Stöhr pointed to the connection between particular forms of myths and the nature of the megaliths in a society. Where the wives of the gods originate from a rock, for example, menhirs are found (Stöhr 1965: 85ff. and 150ff.). In most instances the megaliths (menhirs as well as other stone monuments) have something to do with a feast of merit, or the menhirs function as a monument in honour of the dead.

During mortuary feasts the Sa'dan-Toraja, too, erect large (or, on occasion, somewhat smaller) monoliths, similar to those found among the Kuki (Purum) in Assam on the Asian mainland, and the Kelabites of Borneo (Kalimantan). Megaliths are also raised by the inhabitants of Nias and by the Nga'da and Nage of Flores. In part these megalithic cultures belong to the past, but not among the Toraja. As far as Sulawesi is concerned: many forms of stone culture are known, from both the past and in the present. Menhirs, however, are confined to the island's southwestern peninsula. In the area of the Buginese, menhirs once were erected: prehistoric remains consisting of huge upright stones decorated with a shield carved in bas-relief, and enormous menhirs raised on early-Islamic graves in the interior testify to some form of megalithic culture in the past. (For megaliths on Sulawesi, see Kaudern 1938 and A. C. Kruyt 1923/24: 335-339.)

The monoliths of the Sa'dan-Toraja are called *simbuang batu* (*batu*

= stone). It is not always evident what such a menhir stands for. In some instances, but not without exception, menhirs can be interpreted as phallic symbols. They are raised for dead persons of either sex. The Toraja were unable to tell me much about the significance of the menhirs. They are designed to commemorate persons of consequence after their death. Stones shaped like a phallus usually are hewn but menhirs for a female dead often are hewn too. This makes it a matter of controversy whether they may be considered phallic or not. At times a menhir resembles a stone *a'riri posi'* (cf. VIII.1.4). The higher the class of the deceased, the more considerable his status, the larger his menhir.

A new *simbuang batu* is only erected as part of the two major categories of burial rituals, the *dipapitung bongi* and the *dirapa'i* (described in Vol. II). For a deceased of standing, two to five *simbuang batu* may be set up, as, for example, took place at the mortuary feast for Pong Maramba' from Kalambe' in Kesu'. They can consist of un-cut, rather modest-size monoliths, but, for estimable dead, large *simbuang batu*, up to two meters high, are raised. Most of these in Kesu' are hewn. Full of pride, Johanna Linorante showed me the monolith erected for her mother some years ago in the neighbourhood of Barana'. The monoliths are often hauled a vast distance: extensive manpower is required for the transport of large *simbuang*, and effective organization. Labour in this form ordinarily demands a developed degree of social stratification. In raising the monolith in honour of Lai' Kalua', who died shortly after the end of World War II, the KNIL (Royal Dutch East-Indian Army) lent its assistance by hoisting the menhir into place with a tow-truck crane. In his book Wilcox (1949: 73-75) provides an animated description of the transport of such a monolith.

VIII.6.2 *The raising of a monolith*

Below there follow two accounts of the raising of monoliths. The first was set down by Bua' Sarungallo (October 1969), the second by Puang W. P. Sombolinggi' (1969).

VIII.6.2a *Mangriu' batu, the hauling of a monolith in Kesu'*

First of all an appropriate stone (*mebatu*) is selected. Before people go out to fetch the monolith, a pig is sacrificed to the spirits of the earth (*ampu padang*) because after all the stone is going to be removed from their kingdom. As a shrine a *likaran biang* is used (see Vol. II,

Conversion Rituals). No mention is made of who presided over the rite, but this was presumably the *to minaa*. The sacrifice falls under the sphere of the East, that is the sphere of the gods, of the 'living' (although perhaps one might suppose that it would fall within the sphere of the dead). The stone is dragged by a large number of men. The number of participants depends upon the size of the stone. Since the transport is a form of public amusement, the whole village is likely to lend a hand. Moreover, the work is well paid. One or more buffaloes, sometimes as many as four or five (costs to be paid by the immediate family of the deceased) are slaughtered. Labourers also receive rice. At times several stones may be hauled.

The stone is dragged right through *sawahs* and gardens whose owners are not entitled to demand payment for damages. A great deal of merry-making accompanies the stone on its way. People spatter each other with mud, etc. According to Bua' Sarungallo the stone can even claim a victim, for someone during the hauling can be crushed. He did not say, however, if such an accident ever took place.

Before the stone arrives at the *rante* (the field where the *kerbau* are killed during the ritual for the dead), a pig is slaughtered. It is used as an offering which falls in the *rambu solo'* sphere, the sphere of the West, of the dead. Once the monolith reaches the *rante* where it must be put in an upright position, another pig is sacrificed because a hole has to be dug in the earth (*ma'tambuli*). The *to minaa* is the one who addresses the earth spirits. The offering falls under the sphere of the East, of the gods. After the sacrifice, the monolith is set on end.

The names of those for whom such a stone is erected live on in memory. It is not known precisely how long this memorial remains vivid, but in most instances one is able to identify the *simbuang* of father, mother, grandfather, grandmother and greatgrandparents.

Next to every *simbuang batu* on the slaughtering place of the buffaloes, a certain tree trunk is also erected, the *simbuang kayu* (*simbuang batu* = stone *simbuang*; *simbuang kayu* = wooden *simbuang*). These are lengths of various kinds of tree trunks, and a pole from the *betung* bamboo. Buffaloes are tethered to these wooden *simbuang*, one to each that is set on end. I never found out why stone and wood should be raised in juxtaposition.

VIII.6.2b *In Sangalla'*

The procedure is about the same as on Kesu'. An appropriate stone

is chosen with special consideration of its form; in Sangalla' there is at times a preference for an extraordinary shape, a stone that looks like a bird, for example. In Kesu' there is no predilection in favour of odd shapes. In Sangalla', on the other hand, stones are never hewn. They favour a monolith, which rings clear when struck with a machete. Just as in Kesu', an offering is made before the dragging and the raising of the stone. The menhir is hauled by means of bamboo straps passed over a spar. The stone is transported, preferably, during the rainy season. For a deceased of importance as many as five stones may be hauled. Menhirs are erected if the mortuary ritual is of an order equivalent to or higher than *dipapitung bongi*. At least one monolith must be dragged to the *pantunuan*, (the *rante* in Kesu'). The cost of hauling one monolith amounts to approximately 100,000 rupiah, the cost of food, buffaloes and pigs for the workers included (in 1969, 250 rps. was about 1 USA \$). Of course, expenses will be proportional to the distance which the stone must be dragged and to the size of the monolith.

In Sangalla', too, monoliths are raised on the spot where buffaloes are killed during the ritual for the dead. Again, next to each *simbuang batu* a *simbuang kayu* is set up, which, as in Kesu', serve as tethering posts for *kerbau*.

The *simbuang batu* remain standing on the slaughtering place; they can be used anew at any subsequent mortuary ritual. For the use of a *simbuang batu* slaves were obliged to pay a *kerbau* — which implies that slaves were permitted to use a *simbuang*, but not to erect one. It also implies that there is a difference between the use of the *simbuang* on the *pantunuan* and the significance of these stones as memorials for the dead.

Yet, the *pantunuan* is the proper place for the *simbuang batu*. If a new *rante* is prepared, this is combined with the raising of a *simbuang batu*. There are many menhirs on an old *rante*, up to twenty or even more. They are arranged either in a circle or in rows (see fig. VIII.9). When a *rante* comes to be abandoned, they remain in place; at times thus they come to stand in the midst of rice fields or along the side of a road. In Kesu' for those for whom the *dirapa'i* death ritual is celebrated a stone is erected also in their *sawah*. Similar *sawah* monuments are also customary elsewhere; that these are phalli can be deduced from one observed by A. C. Kruyt in Bittuang, which had its top painted red (Kruyt 1923/24: 336).

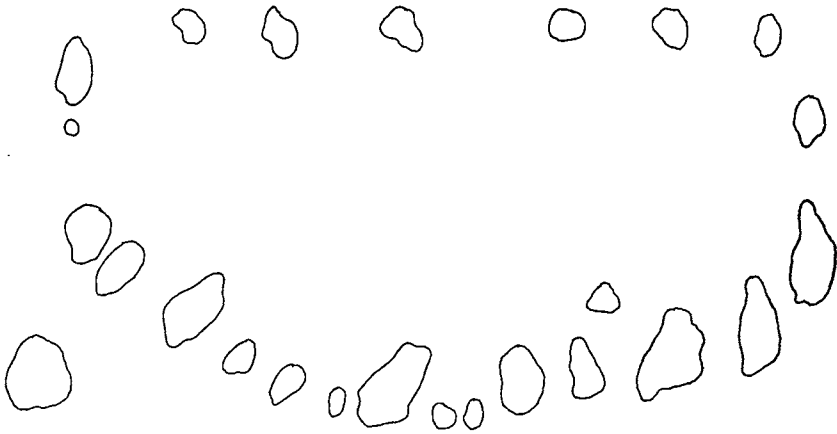
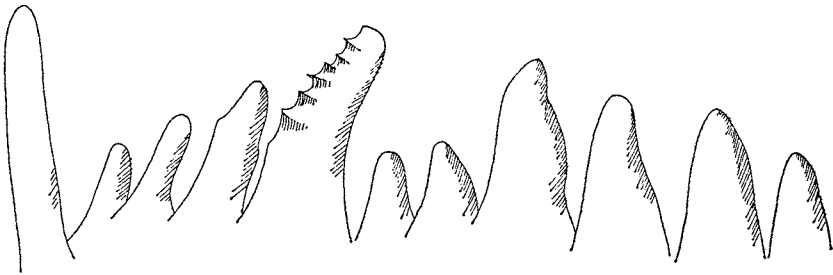

Fig. VIII.9 *Rante* with menhirs arranged in a circle.

a. The menhirs, seen from above.



b. Part of the menhirs on this *rante* (side view).

VIII.6.3 *Other stones*

Surrounding such phalli, there are usually some smaller stones, the 'children', most of the time four in number. These stones usually lay on the earth near the place where water enters the *sawahs*; they are never allowed to stand on the south side, the direction (sphere) of the underworld. A. C. Kruyt (1923/24: 336) maintains that these stones are found only on the irrigated rice fields of the *parengnge*'. Kennedy's informant, W. Papajungan, denied this, contending that every *to makaka* can have such a stone on his *sawah*. When such a stone is set on end, a pig and a chicken must be killed. If this coincides with the planting of the rice, stone and rice seed are sprinkled with the blood of the sacrificial animals. At harvest time three rice plants close to

the stone are left standing; these are called *pare deata* (rice for the gods). The *sawah* stone rises straight up and, I assume, can be seen as a phallus. The pendant of this stone, its female counterpart, according to Eric Crystal, is the *batu polo barra'* (= stone which depicts a grain of rice still half in its husk? — or, perhaps: *batu polo para'* = stone which is half of the male or female genitals). This stone does not stand, but lies next to a sacral tree (*barana'* ?) which grows on the plain where the rites of the *bua'*-feast are celebrated. This feast serves, in part, to promote the fertility of the rice. The stone houses a female spirit (Crystal 1974: 121-122). The suggestion arises that these two stones, the standing and the lying one, represent a *lingga* and *yoni*. There is no word for *lingga* and *yoni* in Sa'dan-Toraja language. Nevertheless, they do occur. Close to the mountain of Kandora (an important peak in the mythical history of the *puang*-territories), in Mengkendek, lies the village of Potok Tengan (the Top of Tengan). At the center of the village — the place is 'secret' — one finds a *lingga*, a *yoni* and a stone shaped like a goose. The two first-mentioned stones are symbols of fertility and power (Salombé 1975: 270). It is uncertain what the third stone symbolizes. The stones play a role in the 'greening' (fructification) of the rice. The *to parengnge'* (and thus not the *to indo' padang*, the rice priests!) put down offerings near the stones. For a day and a night dances are performed: *manimbong*, *ma'dandan* and *ma'gellu'*.⁸ Then the myth of Sawerigadeng is recited (cf. Salombé 1975: 269-293). Elsewhere, too, local stones are reversed (see A. C. Kruyt 1923/24: 337 for the worship of a stone in connection with rice cultivation in To'kalaa near Barana', Tikala).

VIII.7 Sacrificial shrines

VIII.7.1 *Substitutes for the celestial ladder*

An interesting and symbolically significant form of sacrificial shrine is that constructed from *biang* reeds. The shrine is of the simplest, the offering small, but its symbolism refers to the most critical event in human history.

In the tradition of Pong Sumbung Saratu Pio (Pong Sumbung Sare Pio) it is told how Puang Matua in his wrath threw down the Heavenly Steps, *Eran diLangi'* and how the *tille*-reed is regarded as a substitute for the stairway that was destroyed (see VI.4.2a: The tale of Pong Sumbung Sare Pio). This reed (*Andropogon halapensis* Stapf) is equated symbolically with the *biang*, another reed variety (*Miscanthus Japonicus* Anderson). The *tille*-shoot is used by the *to minaa* — priest

for divining (whereby, however, the word divining, *ma'biangi*, is borrowed from the name of the other reed; Van der Veen 1929: 396f.).

When the *to minaa* is about to split the divining reed for the first time, he puts his knife on the reed and addresses it. The litany begins with the invocation of the ancestors and clan fathers to draw up their ranks in the West, that reach of heaven where the deceased abide. The *to minaa* informs them that in the hollow of his hand he is holding the divining reed, the substitute for the celestial ladder (*Sullena Eran diLangi*). Three shoots of reed stood in the midst of heaven, the *indo' datunna*, the 'royal mother' of the reed on earth. "They stood there as if they were the three hearthstones of those who since the days of yore have been invested with authority" (Van der Veen 1929: 401). The comparison which the litany makes with the celestial ladder runs like this:

"Incline your ear to me, hear what flows from my mouth.
For cupped in my hand, I hold the golden breast of the
substitute for the ladder to heaven.

I brush along the back of the substitute for the ladder of
the enveloping (i.e. the firmament) . . ."

(Van der Veen 1929: 404-406)

For an account of the litany as a whole and a description of divining procedures, see Van der Veen 1929, and below under IX.1.

The *biang*-reed is used when offering is made because buffaloes are sick. Then, "four *biang*-reeds are inserted next to each other along the path which these animals are accustomed to follow; the leaves are tied together and the food-offering for the gods, the *deata*, is placed inside them. People do likewise at those places of the *sawah* where the water enters" (A. C. Kruyt 1923/24: 161). Kruyt calls this offering *ma'biangi*, we know from Van der Veen that this term denotes divining. If *biang* are used in the context of an offering to the gods or the ancestors, then they speak of *ma'lika biang* or *manglika' biang*. The offering is but a small one. Four *biang* reeds are planted in a square in the earth; the leaves of the reeds are then wound about the four shoots and twisted into a kind of nest where the sacrificial food is placed. In some districts a *dirak*- or casuarine-branch is added to the reeds, if the offering is directed towards the gods (*Woordenboek v. biang*).

The accompanying prayer is the *likaran biang* (see Merok: 158-164). In this prayer, Puang Matua and all other *puang* ('gods') are called upon; they are supposed to descend to earth:

“Shall thy stairs of beadwork be lowered,
 shall thy golden steps be let down.
 Let the rainbow then be thy path,
 thou shalt make thy way along the arch of the sky-region,
 like the coming of a prau,
 in order that thou comest to this blissful land,
 like a small boat jumping [against a landing stage].”

(ibid.: 160-161, verses 23-25)

The *lumbaa langi'*, the bamboo rod which figures in the final phase of the great *buu'*-feast, can also be considered as a kind of 'sky ladder'. For the rite in which the *lumbaa langi'* is used, see Vol. II and *Woordenboek: loembaa*.

VIII.7.2 Other shrines and receptacles

The Toraja make offerings⁹ of food, stimulants and drink. The food consists of rice (boiled, puffed or uncooked) and of meat from sacrificial animals. In addition uncooked maize, millet (*lonno'*) and vernal grass (*tagari*) can occasionally be presented as an offering. The stimulants and drink are *sirih-pinang* (betel and areca nuts), palm wine and water. Offerings are presented in small portions. Seldom are they placed down without something underneath or something to contain them. Only during the *babo bo'bo'*, an offering which takes place during the most elementary form of a conversion ritual, are grains of cooked rice allowed to fall three times in succession, a gift to the gods, in an (easterly) corner of the *sumbung* or of the *sali* within the house. With the *piong sanglampa* and *pesung sangdaun* (see Vol. II) it is in the Toraja's eyes the simplest version of an offering.

Piong sanglampa (a single bamboo-joint of cooked food) and *pesung sangdaun* (*sangdaun* = one leaf) in fact go together. The bamboo-joint is a receptacle in which the food destined for the gods is cooked (in actuality people ordinarily prepare food in the same manner). Glutinous rice is put inside the bamboo which is then leaned against a kind of rack (*langngan*, see below) beneath which a small fire is kindled. From time to time, the bamboo is rotated until it is charred brown or black on all sides and its contents thoroughly cooked. Such a length of bamboo together with its contents is called *piong*. On a piece of a banana leaf (*pesung sangdaun*), some of the contents of the *piong* are then spilled out to serve as an offering (cf. VII.16). The gods do not receive much; they are considered to take for their share the

essence of the food, leaving the rest to be dispatched by humankind.

In practically all rituals of the East, the *pesung* plays an important role. Usually the priest sets down more than one *pesung*.

In many offering rituals, especially in those which are East-oriented, the stem of a bamboo *aur* (*ao'*, *Dendrocalamus strictus*) is used as a 'shrine'. The top of this bamboo is left intact and the stem so turned that the top bends to the northeast. A string hangs down from it to which some meat or a small package of food is attached as an offering for the gods. The package contains glutinous rice wrapped in plaited sugar palm leaves, *belundak*. Sometimes the food for the gods is laid down in a small basket (*karerang*) made out of loosely plaited sugar palm leaves and also suspended from the bamboo pole. The bamboo is known by various names: *pentiroan* (the look-out), *tete ao'* (bridge of bamboo *aur*) and *tadoran* (no translation known). When a *karerang* is used for presenting the offering, the pole always is spoken of as *tadoran*. Then, moreover, a young, just unfolded leaf of the sugar palm covers the entire length of the pole.

A *suke* is a joint of bamboo, usually narrow and short, into which some water or palm wine for the gods is poured. The *suke* in most instances is attached to one of the legs of the shrine constructed for the more consequential (larger) rituals of the East and West. This shrine is made up of four lengths of bamboo about one and a half to two meters high, set up at the corners of a square; two platforms of plaited bamboo are inserted between these legs, one above the other. The ends of the bamboos are decorated with woodcarving (for the motifs applied see the illustration of the shrine in J. Kruyt 1921: 202).

On the upper platform (*para-para*) food and *sirih-pinang* are set down for Puang Matua. On the lower platform (also called *para-para*) *sirih-pinang* and food are served for the remaining *deata*. The food is set out on three *pesung*. On the ground in front of the shrine, i.e. to the northeast, a *pesung* is placed for the *sikambi lolo tau*, the keepers of the rites of men. To the southwest of the altar the *to minaa* puts down a *pesung* for the *ampu padang*, the grandfathers of the ground (my informant Bua' Sarungallo claims that this *pesung* is not offered to the mice although these animals are at times also referred to by the name *ampu padang*).

Shrines consisting of really elaborate scaffolding are the *gorang*, assembled during the (great) *bua'*-feast, and the *balaka'an* (*balakayan*) which is erected for mortuary rituals of a higher order. For a

description of other utensils and shrines employed during offerings, I must refer to the description of the relevant rituals in Vol. II.

Finally, the *langngan* requires mention; this term has been translated by Van der Veen as 'roasting spit' (*Woordenboek v. langngan*). Men usually do the cooking during rituals. They cook in bamboos (the variety used is the bamboo *tallang*). The bamboo cylinders are stood against a simple rack consisting of two times two poles crossed in the form of an X with a longer pole laid in the crossings between them. The bamboo tubes lean upright against the longer pole under which a fire burns. This singes the bamboo, thus slowly cooking whatever is inside. During rituals of the West, the knots of the binding material fastening the pole to the crossings, are turned down, towards the earth, whereas during rituals of the East, they face upwards.

The terms used for shrines and receptacles for offerings entail frequent confusion. A *tadoran*, for example, can also be the name for a bamboo-pole to which a plaited platform has been attached somewhere roughly in the middle. For the Toraja, the number, colour, sex and kind of the sacrificial animals are of more importance than the artifacts on which offerings are served up.

Below a list of shrines and offerings in order of their ascending importance:

Shrine	Offering
<i>Babo bo'bo'</i> (no shrine or receptacle)	Glutinous rice from a <i>piong</i> (few grains)
<i>Pesung sangdaun</i>	Glutinous rice from a <i>piong</i>
<i>Likaran biang</i>	Meat from a red chicken and some glutinous rice from a <i>piong</i>
<i>Tadoran</i>	Meat from a red cock and some glutinous rice from a <i>piong</i>
<i>Tete ao'</i>	Some meat from a pig and some glutinous rice. Offering takes place in the yard
<i>Palangngan para</i> (small board attached to the front wall)	Meat from a pig and some glutinous rice
<i>Palanduan-duan</i> (not mentioned in the text above)	Meat from a <i>kerbau</i> , pig and cock, some glutinous rice.

CHAPTER IX

PRIESTS

“The one was called Datu Mengkamma’
the other was named Karaeng Ma’loko-loko.
They watched over the complete number of
a hundred prohibitions for The field
lying at the head of the firmament.”

(Merok: 121)

The Sa’dan-Toraja have various categories of priests and priestesses, each with a specific competence in the enactment of rituals. In one and the same ritual different priests may officiate. Besides other persons also fulfil fixed functions in ritual, persons who occupy a position which is otherwise secular. By virtue of their supernatural descent *adat*-chiefs — the *puang* and the *to parengge’* — naturally have a significant role in the celebration of any important feast. Part of their functions the chiefs can delegate to the priests, especially the recitation of litanies. Other roles are not transferable. It is the leading member of society who, officially at least, takes the initiative to hold a community feast; execution of the ritual, recitation of the pertinent litanies and the presentation of offerings are, to a great extent, the prerogatives of a priest who has his own, inalienable functions.

There are six principal categories of priests:

1. the *to minaa*;
2. the *to menani*;
3. the *to indo’ padang (bunga’ lalan)*;
4. the *to mebalun* or *burake bombo*;
5. the *to burake tattiku’* and *to burake tambolang*;
6. the *to ma’dampi*.

Perhaps the *to ma’gandang*, ‘he who beats the drum’, should also be included. He officiates at the *bua’ kasalle*-ritual. We did not include the *paita*, the seers who have knowledge of fortunate and unfortunate days. They are consulted on all sorts of occasions, both ritual and profane, but do not officiate as such in ceremonial functions. Nor did

we discuss the *sando*, a priest who functioned only in Mendetek, in this chapter. Neither did we mention the *manakka*-priest of Simbuang, who functioned in the *manakka*-ritual, a part of the great *bua*'-ritual in that region. Essential information concerning religious functionaries was first presented by Van der Veen (1924). (For magic see Vol. II.)

IX.1 The to minaa

Because the *to minaa* officiates in so many rituals, he necessarily is the first to be discussed in the present review. Many *to minaa*, moreover, are well-versed in mythology, litanies and *adat*-prescripts. This priest is, as it were, a scribe in a society without script or scripture. Some *to minaa* possess really capacious memories — matched, it is true, by a few *to parengnge*'. The recitation of the *Passomba Tedong*, the consecration litany of the *kerbau* sacrificed at the *merok*-feast, is not a task for just any *to minaa*. In Kesu' its recitation from start to finish lasts twelve hours. The style of the litany is ornate and discursive; parallelism and metaphors abound. Today, therefore, the *to minaa*'s use of language is difficult to comprehend.¹

Minaa means literally 'rich in thoughts'. Among the occasions at which the *to minaa* officiates are the *merok*-feast and a later phase of the *aluk rampe matampu*'. Although the latter is part of the mortuary ritual, the *to minaa* does not function as a death priest. He occupies himself with the ancestor worship of this ritual, with veneration of the *to matua*, just as during subsequent conversion rituals he will address himself to the *deata*, the ancestors of the East. Furthermore two *to minaa* have responsibilities during marriage rites. Divination is also consigned to the care of these priests. This *ma'biangi* (see Van der Veen 1929) is resorted to when someone is seriously ill. Sickness, according to the Sa'dan-Toraja, is the consequence of transgression. The *to minaa* must investigate whether the sick person has violated either the *adat*-regulations (*aluk*) or taboos (*pemali*). Should a violation have been committed, then one half of the divining reed with the convex side turned upwards (*lumbang*) will fall to the right of the *to minaa*, while the other half with its hollow side turned up (*tungara*) will come to lie at the priest's left side after the reed has been cut down the middle. Should the right hand half of the reed fall in the *tungara* position and the left hand one in *lumbang* position, then this is an indication that no transgression of *adat*-regulations or taboos has been perpetrated. The cleaving of the reed takes place on a board, 'the head cushion of the reed' (*allonan biang*). During the divination,

the *to minaa* sits in the *sali* (the central room of the house, site of the hearth) with his face to the northeast.

During the *bua' kasalle*-feast, a *to minaa* eulogizes attending personages of respect (*ma'singgi'*). The priest also interprets the meaning of the particular situation of the organs of a sacrificial pig or cock, or the omen announced by the cry of a certain variety of screechowl. Whereas the priest's incantations have the past for their content, his divining activities concentrate on the future. Before warriors entered battle, the *to minaa* prayed that their efforts would be blessed. He then stood on a hill with a staff in his left hand. When the Toraja set out to revenge the death of one of their number, the *to minaa* raised a shield (*unnambo' balulang* = to sow the shield) and implored a blessing. Before a headhunting expedition departed, the *to minaa* crowed like a rooster (A. C. Kruyt 1923/24: 312). Then the party set out. Should they return with a head, the *to minaa* would sacrifice a pig, the head of which would be fastened to the front wall of the house (of the family of the deceased for whom revenge had been taken?). In Rante Tabang the severed human head would be set on the neck of the Toraja villager who had lost his own. When, subsequently, the latter was buried, the head of the *parepe'-kerbau* (see VIII.1) was conveyed to his rock-grave (Van der Veen 1924: 386).

A distinction is made between more and less accomplished *to minaa*. The *to minaa manakka* is an extremely gifted official who knows all rituals in detail, whereas the *to minaa ulu manuk* is a *to minaa* whose services are repaid with no more than the head of a chicken, because he is unfamiliar with the great sacrifices.²

When presiding at major rituals, the *merok*-feast, for example, the *to minaa* wears a *maa'*-cloth on his head, the ends of which hang down his back. This head-dress of the *to minaa* also receives mention in the *Passomba Tedong* (Merok: 152-153). In addition he wears a long jacket, *bayu lamba'* (*lamba'*: a kind of fig tree; metaphorically: rich, respected) which is left open in front. This jacket probably is of Arabic origin and borrowed by the Toraja from the Buginese; a picture of this jacket is found in Matthes' *Ethnographische Atlas bevattende voorwerpen uit het leven en de huishouding der Boeginezen* [Ethnographic Atlas including artifacts from Buginese life and household], photo XIV, fig. 18.

Like so many other important figures, people and things among the Sa'dan, the *to minaa* also has a celestial ancestor: *Londong diLangi'* ('Lord in the Firmament'); next to this forefather, people in Kesu'

also cite Kambuno Langi' (*langi'* = heaven; *kambuno* = a parasol made from the leaves of *Corypha gebanga*, the fan-palm), also known as Ta'dung Kaissanan. In Pangala' other ancestors reported are La'lang Langi' ('Parasol of the Heaven'), or Batare Palinge, one of the eight children of Datu Laukku'. Pong Tambuli Buntu, one of the eight children of Pong Tandi Minanga, is yet another mythical *to minaa*. Van der Veen lists yet more names (1923/24: 375ff.). With all these mythic figures, emphasis is placed on the priests' heavenly origins and, at times, on their divine descent. Pong Tambuli Buntu was the first *to minaa* who came down from heaven to earth to sacrifice during a marriage ceremony. He did likewise when the legendary carpenters, Pong Kate'bak or Kateba' and Pong Pande Patangnga' were about to build a house. Whether the latter is one and the same as Tandi Minanga's son is not clear. The son of the god Tandi Minanga escaped from the flood that inundated Rura (cf. VI.3) and, together with two other *to minaa*, officiated at the sacrifices made during the *la'pa' kasalle*-ritual to atone for the incest that had been committed. The activities of other mythical *to minaa*, Kambuno Langi', for example, were largely confined to the precincts of heaven.

The heavenly origin of the *to minaa* adds to their status. The position appears in most instances to be inherited, yet this is not a fixed rule. In Pangala', only a *to makaka*, a person from the class of free men can be a *to minaa*, but in Ranteballa also a *kaunan*, a slave, could officiate. Elsewhere, too, in Ma'kale and Kesu', this possibility is not precluded. Yet, a priest from the *kaunan*-class can never make an offering at a ritual or feast given by a prominent *to makaka* (Van der Veen 1924). It seems that *to minaa* can be called to their office by a certain dream, one in which activities connected with *to minaa*-hood play a role, e.g. the beating of a drum. In Nonongan a man can succeed his father as *to minaa*. One becomes a priest as an adult, after gaining knowledge about rituals, learning to recite the litanies, and mastering the right way to express oneself. One can also become an apprentice to a *to minaa*. Women seldom become *to minaa*. In general the status of any *to minaa* depends both on his social position and on his personal qualities.

For a *to minaa* no special burial rites are observed, except if he was of noble descent. A good case of the latter is the funeral celebrated in the 1920's for the father of the *to parengge'* (*adat*-chief) of Pangala' where two *to minaa* sang the praise of the deceased. Such eulogies for the dead are restricted to persons of eminence. In Ma'kale

and Kesu' the wording of the death chants sang over a dead *to minaa* differs from that raised for other people.

Dr. Van der Veen kindly provided me with the following particulars concerning the *to minaa*. Of the role of this priest during a mortuary ritual, one can say that he does not officiate over that which constitutes the essence of the ritual offering to the soul of the deceased (that is the function of the *to mebalun*), but rather that he lends assistance by reciting the relevant litany which he alone knows. Moreover, the *to mebalun* (the death priest), is so contaminated by the sphere of death that he is not permitted to execute certain solemn, more or less sacral actions such as the consecration of the *pa'karu'-dusan*, the *kerbau* which is considered to die simultaneously with the deceased (a component of the mortuary ritual observed for a *puang*).

The *ma'nene'*, Van der Veen maintains (and here he is seconded by B. Sarungallo), falls under the *aluk rampe matampu'* (the West-oriented rituals) even though the action takes place at the rock grave. The *to minaa* fulfils an important function in this ritual (see Vol. II; The Chant: 7f.). He officiates also during the *ma'pakande to matua*, the offering to the ancestors. Although these are the 'ancestors of the West', he apparently is not contaminated by contact with the sphere of death. In sacrificing a black hen during this *ma'pakande to matua*, however, he does become involved in the ritual to ward off evil powers.

The *to minaa* furthermore presides over rites of consecration such as the previously mentioned *massurak*, the blessing of the *pa'karu'-dusan*. Such rites of consecration probably all aim at keeping evil influences at bay. Thus, for example, the *to minaa* consecrates the pig that is put to death during the *menammu pare*-ritual; the *to indo' padang* (the priest who is of utmost significance in the rice ritual) performs the sacrifice.

At the *mangrara banua* (the feast consecrating an important house), the *to minaa* recites the blessing over the pig that will be sacrificed, praying that the form of its gall bladder may be auspicious. Here the carpenter or the *to parengnge'* conducts the sacrifice proper (but he can invite the *to minaa* to replace him).

The *to minaa* often is active in warding off harmful, injurious influences, for example during the *mangrambu langi'*, designed to expiate incest. Also in case of sickness or bad dreams the *to minaa* is called upon.

In this context Van der Veen also mentions the functions of the *to minaa* and the death priest during the ritual of the *ma'tomatua* in Balusu, known there as *mangula'i*. Pigs and one *kerbau* are slaughtered in front of the grave; the death priest, 'the one who swaddles the corpse in its winding sheat', performs the sacrifice which is presented to the deceased. The following evening an offering is presented to the ancestors at the western side of the house of mourning; now it is the *to minaa* who makes the offering. This rite in turn ushers in the conversion ritual, performed to transfer the soul of the deceased from the sphere of the West to that of the East, the sphere of the *deata* or the gods.

IX.2 The *to menani*

Another functionary is the *to menani* who officiates at the *buu'* (*la'pa'*) *padang*-feast in Kesu' and Ma'kale. An account of his role will be presented in our description of this ritual (Vol. II). In Kesu' only members of a certain *tongkonan* (Buntu Karunanga in Angin-angin) are eligible for this office. No reason for this restriction could be uncovered.

To Siuang Tanduk, 'The one who carries a horn', was the first *to menani* who came down from heaven (Van der Veen 1924: 393). At the above-mentioned feast, this priest wears imitation horns made out of sugar palm-leaves.

IX.3 The *to indo' padang*

The *to indo' padang* is well-informed about the *aluk padang*, the *adat* and ceremonies connected with arable land (in this instance, the rice fields). The priest's title (*indo'* means mother) might suggest that the priest could be a woman. Yet, the *to indo' padang* is invariably a man. *To indo'* can be translated as 'the one who mothers', a metaphorical expression for, 'the one who bears responsibility for' (the ritual of rice cultivation); it is the priest's task to promote the growth and ripening of the rice. *Indo' padang* thus means 'mother of the land', 'keeper of the soil'. There are various priests of the rice; the pre-eminent *to indo' padang* is the *bunga' lalan*, 'the one who goes first along the way' (of the rice ritual). This *to indo' padang* is the leader of the ritual: he is the first to sow rice, the first to plant the young shoots and also the one who brings the requisite offerings. In short, he has the same function as the 'leader of the rice' among other Indonesian and Southeast-Asian peoples. Yet, this priest also officiates

at *mangrara papa*, the feast of the renewal of the roof of the parent-house. The association of the ritual of the rice with the roof of the *tongkonan* is not an obvious one; I can merely comment that both feasts are connected with the upperworld. The mythical ancestor of the *to indo' padang* is Datu Mangkamma', one of the eight children of Datu Laukku'.³

IX.4 The *to mebalun*

The *to mebalun* is 'the one who swaddles corpses in their winding sheat', a name indicating one of his specific tasks. He is also called the *burake bombo*, the priest of the *bombo*, and is the 'outcast' of Sa'danese society. Tradition has it that the eight offspring of Datu Laukku' all chose a craft, except for one. He beat his sister to death and became the first *to mebalun* (Kruyt 1923/24: 142).⁴ Van der Veen names Pundu Kasisi' as the first wrapper of the dead (1924: 391). Contact with the deceased who have not yet been transported to the sphere of the gods makes him impure. Aversion to (and thus presumably fear of) the *to mebalun* is strongest in Ma'kale and, to a somewhat lesser degree, in Rantepao. In the district of Ma'kale no one will set foot in the house of a death priest though the priest himself is allowed to enter the house where the deceased is kept. His services are needed there. To summon him to perform these services, people throw a stone against the wall of his house three times, calling out, "You have to come quickly, for your seed is rotting" (Kruyt 1923/24: 141). In Kesu', too, this is common practice. The priest knows what it is all about, and calls in turn, "When does the feast start?" The answer is, "In three day's time".

When the *to mebalun* wants rice, he goes and sits at the side of the road and cries, "Here is someone who has need of rice". Informants told me that in Kesu' the residence of a *to mebalun* stands some distance apart from other houses. He may not enter the homes of others, but they all are allowed to enter into his. He is the sole individual who is permitted to eat rice during a mortuary ritual. For all others — relatives and guests — this is taboo. The *to mebalun* has his own spring; he may not take water from other wells, and he is obliged to keep at a safe distance from anything connected with the *deata* or the *to dolo* (ancestors who died long ago and thus are purified).

The taboos cited above do not exist in Mamasa. In the Sa'dan region the wrappers of the dead are, as a rule, people from the lowest class,

the *kaunan*. A. C. Kruyt (1923/24: 142) reports, however, that in the Rantepao region also *to makaka* can be death priests.

A *to mebalun* cannot serve as any other kind of priest. Although his children usually are less tainted by the contagion of death than he himself is, they are not allowed to become a *burake tambolang* or *burake tattiku'* (for information about these priests, see section 5 below). Van der Veen (1924: 396) has told how the son of a *to mebalun* in La'bo' (Kesu') received a calling to become a *burake tambolang*, but no one was willing to make use of his services.

The *to mebalun* or *burake bombo* is the priest of the impure dead, the *bombo*. Other names for this functionary include *parengnge' matampu'* (= the chief of the West) and *burake matampu'* (= priest of the West). Puya, the kingdom of the dead, lies in the West. He conducts the ritual for the dead until attention turns to the gods whereupon he cedes precedence to the *to minaa*.

The name *burake bombo* is unknown in Kesu'. In Nonongan (which historically belongs to the federation of Kesu') and in Buntao' people use the term *to parengnge' matampu'*, Lord of the West. Elsewhere (precise locations are not specified) this priest is known as *to minaa to mombo*, the priest of souls (A. C. Kruyt 1923/24: 142). In the *puang*-regions (at any rate in Ma'kale and Sangalla') the wrapper of the dead is called *to ma'kayo*. *Kayo* is the name of the grey heron; in this context, it is of interest to note the title of a *burake*-priest to be discussed in the next section, i.e. the *burake tambolang*. The *tambolang* is a large, black and white, long-legged wading bird. Apparently, here the *to ma'kayo* is regarded as the counterpart of the *burake tambolang*.

In contrast to the immediate family members of the deceased and to those who have stepped on the sleeping mat of the dead person, and in contrast, too, to the deceased himself, the *to mebalun* is allowed to eat rice during a certain period of the death ritual (the period during which he officiates). A *kaunan*-woman prepares this rice; she is known as the *to massanduk bo'bo'*, 'the woman who ladles out cooked rice' (A. C. Kruyt 1923/24: 144). According to F. K. Sarungallo (Kesu') the *to mebalun* is also allowed to take as much meat from the slaughtered pigs and buffaloes as he wants. In addition he receives rice and money as compensation for his services (see also Kruyt 1923/24: 143).

For a description of the death priest's apparel, see the account of the ritual for the dead observed for Sia Sa'pang in Kesu' (Vol. II).

Although I was unable to attend the ceremony, informants told me that the *to mebalun* wore a special hat while carrying out his duties. The hat was made from the sheathes or spathe of the areca palm; a reference to the hat crops up in the death chant (*badong*):

“Ne’ Sara, he was summoned then;
He wears the dried areca leaf.”

(The Chant: 32, verse 148)

Finally, the family of the deceased and the local *to minaa* consult the *to mebalun* about the sequence and the number of rites to be observed and also the length of the period within which these are to be celebrated. The death priest is aided by an assistant, the *to pabalian* (the generic term for a helper or aide).

IX.5 The *to burake*: the *to burake tattiku'* and the *to burake tambolang*

All of the priests discussed thus far have been men. The most important religious functionaries among the Sa'dan-Toraja, however, are a woman, the *burake tattiku'* and an hermaphrodite, a man dressed as a woman, the *burake tambolang*. They fill the leading roles during the *la'pa' kasalle*-feast which J. Kruyt has described as the *bua'*-ritual (1921: 45-78 and 161-187). Unlike the *to minaa*, the *to indo' padang* and the *to mebalun*, the *burake* (and this holds for the *to tambolang* as well as for the *to tattiku'*) cannot boast descent from a celestial ancestor. Only Ne' Kendek of Salu (Kesu'), the informant of A. C. Kruyt and H. van der Veen in 1923/24 identifies an 'ancestor' of the *burake tattiku'*: Burake Manakka, the gifted *burake*, the cat who sought the mice for their *bua'*-feast (see A. C. Kruyt 1923/24: 289, as a story about the cat this was reported in the same year by Ne' Pande in Angin-angin, Kesu'; cf. above VII.6.2). Van der Veen, however, points out that this is not a general accepted explanation of the origin of the *burake*.

The *burake* only makes his appearance in myth after the descent of the ancestor to the earth (cf. VI.3, Myths concerning the consequences of incest). In addition they are mentioned in the litany recited during the *merok*-feast (Merok: 147ff.). The fact that so little is reported concerning the descent of the *burake* probably increases the significance of these priest(esse)s, or at any rate contributes to the air of secrecy which enshrouds them. The word *burake* means impotent, or hermaphroditic. Possibly, the Bare'e-Toraja word *wurake*

provides an alternate (though hardly more enlightening) explanation; *wurake* is a spirit of the air. However that may be, the Sa'dan have come to conceive of only the *burake tambolang* as impotent or hermaphroditic (usually he is a transvestite). According to Kennedy's informant W. Papajungan all *to tambolang* were hermaphrodites. Wilcox was told that the *burake tambolang* of Makula' (Tokesan) was an hermaphrodite. In Wilcox's opinion, however, this priest was a sexual invert. Yet, all this is contradicted by the experience of Dr. Van der Veen who stated that many *burake tambolang* were married, and often fathers of children before they received the calling to enter priesthood (1924: 396). He adds, however, that after assuming office as *burake* they can marry a man.⁵ The name *tambolang* possibly refers to the dualism of this priest. *Tambolang* is the name of a certain stork said to be black and white.⁶ According to the Toraja, the *burake tambolang* is half-man, half-woman ('above' a woman, 'below' a man). Little is known about the clothing worn by the priestess, the *burake tattiku'* (*tattiku'* is the name of a small bird; Latin name unknown). Among her attributes (as among those of the *to burake tambolang*) belongs the *garapung*, a small musical instrument with a handle;⁷ the instrument makes a clattering sound because two strings of beads click against the drumhead. This instrument, the clapper drum, is also known in other parts of Southeast-Asia.⁸

When, during the harvest-season, the *burake tambolang*, made 'her' rounds — he is considered to be female — then 'she' had to be received by the *sawah*-owner who slaughtered a pig for 'her'. As recently as two generations ago the *burake tambolang* still enjoyed much respect. Should 'she' appear on the battlefield, then fighting stopped. The esteem accorded to this 'priestess' can also be deduced from the ritual for the dead celebrated for a *burake*. When 'her' corpse was carried out of the house of mourning then part of the front wall, the north wall, of the house was broken away (cf. VIII.1.6).

According to Van der Veen, this treatment pertains only to the *burake tambolang* not to the *burake tattiku'* (1924: 397). Whether the token of honour (the bunch of rice-stalks is given to the *burake tambolang* as 'she' passes through the *sawahs*) also is bestowed on the *burake tattiku'*, is not known. Certainly, however, the *burake tambolang* is more highly regarded than the *burake tattiku'*. The latter is always a woman, apparently in most instances an older woman. Besides hermaphrodite, the word *burake* also means impotent, empty, in this case probably reference to someone who has reached an age

where she can no longer bear children. More often than not a *burake tattiku*' succeeds her mother. As a rule she belongs to the class of the *to makaka* (the free) and can be married to a *to minaa*.

The calling of a *burake tambolang* to priesthood is, emotionally, a more complex process than that of a *to minaa*. A single dream is sufficient inspiration for a *to minaa*, whereas the *burake tambolang*'s summons takes the form of a state of ecstasy which, according to Van der Veen, can last up to three or four months. Undoubtedly the *tambolang-to-be* goes through a period of tension in which auto-aggression is observable. In trance he/she presses a sword against the flesh without incurring a wound, etc. Afterwards a kind of rebirth follows: the *to tambolang* is 'created anew by the *deata*' (as a woman) to quote one of Van der Veen's early informants (1924: 395). Probably the calling comes at a somewhat advanced age; we noted that often he was already a married man and a father when he entered priesthood. The medical officer W. Meyer at Makassar has reported that the *burake tambolang* is not an hermaphrodite. This priestly function in days gone by when war was more a constant preoccupation presumably offered men of peaceable disposition a 'way out'. It is possible that the priest's calling has something to do with a feeling of being summoned to play the part of a guardian of the balance between upperworld and underworld on this earth. The office, it goes without saying, is not one which can be inherited.

A *puang* can never be a *to burake tambolang*, even though both figures belong to the foremost members of Sa'dan society.

The position of the *burake tattiku*' and of the *burake tambolang* has diminished in significance as a consequence of the spread of Christianity, education and the influence of modern times in general. Furthermore, the feast at which they officiate, the great *bua*'-feast, is often very costly. As early as 1923 Kruyt reported that, in those days, such feasts had already become extremely rare because expenses were virtually prohibitive.⁹ This is true of Kesu'. Yet, such celebrations are still held elsewhere, in Tikala among other places. Here the feasts entail less expenditure than they did in Kesu'. In Simbuang the *burake* is also summoned to participate in the rite which is observed when a house has been finished (*ma'burake*). In Pangala' the *burake tattiku*' also officiates in the course of the *merok*-feast; it is she who sprinkles the sacrificial buffaloes with hulled rice. The role of the *burake* will be further discussed in our account of the *bua*' (*la'pa*') *kasalle*-feast (Vol. II).

The *burake tambolang* is a man dressed like a woman; the *burake tattiku'* is a woman. What is remarkable is that during the *bua'*-feast the *burake tattiku'* appears wearing the clothing of the opposite sex. At a certain phase of the celebration, she binds her hair up like a man, takes a sword and shield in hand and dances together with another *to burake* around the *tangdo'*.¹⁰ The dance is something of a war dance or a dance of exorcism. During another phase of the ritual the *to burake tattiku'* and the *to ma'gandang* enact a parody of a marriage proposal. The *burake tattiku'* then plays the part of the bride.¹¹

The *burake* is the most important functionary during the *bua'*-feast, a celebration considered as a feast to nurture communal welfare, to promote the prosperity of man and beast, and is also a fertility feast. The *burake tattiku'* (and *to tambolang* as well) act as the promoters and protectors of the spiritual and secular well-being of the community.¹² At the same time the *burake* (in Kesu' at least) stand in their turn under the protection of the *deata* ('gods') of Kesu'. Both categories of *burake* are referred to as *burake deata*, the *burake* of the gods, or, the *burake* who are involved in the ritual of the gods. Mabuchi (1964) has pointed out that the prestige of the priestess derives in part from her power to curse.¹³ In this context the myth of Rura is instructive, in the course of which the *burake* pronounces a curse (cf. VI.3).

It is not certain whether or not the *burake* enters into a trance. Van der Veen's *Woordenboek* (12, v *alোক*) gives two definitions for *mangaluk*: 1. the invocation of the *deata* by the *burake*; 2. a demon possesses someone. Such possession is not connected to the *burake*, however. She comes exclusively in contact with the gods and is not possessed by the souls of ancestors. (When attending at a *bua'*-feast on the slopes of the Sesean in 1970, I saw no signs of trance in the *burake tattiku'* during the *mangaluk*.)

The *to burake tambolang* and the *bissu* of the Buginese either both emerged from the same type of priest (comparable to the *berdache* among the Zuni, see Benedict 1934; chapter IV, the Pueblos of New Mexico: 41-52) or else the *to burake tambolang* owes its origin to Buginese influence. The region where this priestess of the '*berdache*'-type functions borders on Luwu', but the *bissu*-type associated with agriculture is more common in Segeri whereas it is absent in Luwu'. On the other hand, one also encounters the term *bissu* in Mamasa and Pitu Ulunna Salu on the western border of the Sa'dan region.

Here the *bissu* officiates at the *melangi'*-feast, a feast comparable to the *la'pa' kasalle* of the Sa'dan. The priestess (a woman, no *berdache*) then climbs into a banyan tree, a gesture symbolizing contact with the upperworld (Merok: 147).¹⁴

Among certain Dayak tribes (Iban, Olo Ngaju) both sorts of priests were known, a woman and a man dressed as a woman, just as among the Bare'e-Toraja.

Below follows some further information about the last *burake tambolang* in Tana Toraja (data acquired in 1975). As a result of the tireless efforts of informant Johanis Lobo' I finally met the *to burake tambolang* in a village in Sangalla'. The priest's name is Tumba' Upa' (*tumba'* = to spring up, also a second name for the *anak dara* during the great *bua'*-feast; *upa'* = prosperity, fortune). In contrast to the *to burake tattiku'* who still officiated during the great *bua'*-feast celebrated in Riu, the *burake tambolang* had not performed any of the duties of his office in a long while. What is worse, he (or 'she') had lost esteem and was pestered by local youths. That is why he had taken refuge in a house in this village somewhere in the *puang*-regions; a family had taken him in with loving hearts because after the *burake tambolang* had in the past said a blessing over this couple, they indeed produced children after long years of barrenness.

The *burake tambolang* was approximately seventy years old (his own estimate of his age was much higher). He had curly grey hair, fine, rather feminine features, and, for all his years, surprisingly sturdy limbs. The *burake* had a bag in which he carried such as collection of junk that he looked like a tramp. The priest still had the *garapung* with him; he made continual music on it. Tumba' Upa' conveyed the impression that he was not completely sane; this provoked the taunts of the young. Moreover, the memory of the priest had sorely suffered. This interfered with the collection of exhaustive information. The following data emerged from our meeting:

He was born in 1850 and was thus 125 years old (a boast which practically everyone present accepted as true). His birth was miraculous. His mother had been pregnant a full year when in 1850 in the village of Makula' in Sangalla' she brought a son into the world. When after several days, however, she wanted to light a fire in the hearth early in the morning, she saw a small child lying there. She drew this child out of the hearth; it turned out to be a girl. Then she called her husband. The two of them examined the baby carefully and reached the conclusion that it was their newborn son who had been turned

into a girl. The parents raised the girl until she was practically full-grown. Thereafter Tumba' Upa' received the inspiration which converted her into a *to burake tambolang* (it proved impossible to find out what form the inspiration took).

The *burake* then told us that during the great *bua'*-feast he climbed upon a wooden platform (apparently the *gorang*) where he sang the praise of those in attendance. In Riu this *ma'singgi'* is a task which falls to the *to minaa*. The praise extends to the prominent members of the society, the *to parengnge'* and the *to matua ulu*.

During the *bua'*-feast, the *to burake's* apparel consisted of a yellow sarong (*dodo kuni*) or a sarong studded with coins (*dodo uang*). When asked if he climbed the *barana'*-tree to stay there for a while as is the custom in Kesu', the *burake* answered, No.

After the rice harvest, the *to burake* went from village to village with his *garapung*, praying for a blessing over the rice that had been stored, praying that it would multiply (see the second song sung by the *to burake tambolang*), all the while rattling with his *garapung*. Tumba' Upa' demonstrated how he sang and played. The manner of singing closely resembled that of the *to burake tattiku'* who officiated at the great *bua'*-feast in Riu. Tumba' Upa' also confirmed that he is able to bless childless married couples so that they become fertile.

Here follows the first song of the *burake tambolang* Tumba' Upa' from Sangalla', transcribed by Johanis Lobo' (1975); Dutch translation by Dr. Van der Veen:

- | | |
|--------------------------------------|---|
| 1. Inde diong sanggandangku | Here then is my fellow priestess, |
| 2. padangku ma'giring-giring. | my companion in office who rings
the bell. |
| 3. To laen-laen dadinna, | Someone of a remarkable birth, |
| 4. to senga' panggaranna. | of an extraordinary creation. |
| 5. Mara'na tonna ditampa, | Alas, when she was brought into
being, |
| 6. tonna diammun elo', | when her (mother) had put into
her mouth what she desired. |
| 7. Apa nakande indo'mu tom-
niu | What did your mother eat when
for your sake she acquired an
appetite, |
| 8. dipangngidenan, to dikom-
bong | You who were formed in her
belly, |

- | | |
|--|--|
| 9. lau ri tambuk to ditampa i bannean | who were brought into being in her womb? |
| 10. Allo ia umpelobo'i, bulan undaranai. | The sun, he causes her to prosper, the moon takes care of her. |

Second song of the *burake tambolang* Tumba' Upa' from Sangalla', transcribed and translated as above.

- | | |
|--|---|
| 1. Pare tambun dao lingai', | The rice has been set in the ground above in heaven |
| 2. pare mandoti londungna. | the dark brown, long-haired glutinous rice (?) |
| 3. Pare umbena' rupana, | The rice . . . (?) is her form. |
| 4. langngan dirembu pemala' | Upwards incense is burned above the offering, |
| 5. ditangkean bulu manuk | in the hand chicken feathers are held over it, |
| 6. ladisuru' diong pangrante mali'na ¹⁵ | to offer it on the drying floor of the rice |
| 7. sola rampean ponnona, | filled even to all its edges, |
| 8. dipasala sumanga' na, | her life spirit is fended off, |
| 9. dipasitammu oranna, | she is connected with the stalk that contains the ear which is to be cut off. |
| 10. dibangunan memba' ka'len di, | She is raised up, multiplying all the time |
| 11. to diong rara manuk. | as a result of the blood of the cock. |

Finally, we must turn to the geographic distribution of *burake tambolang* and *burake tattiku'*. They never appear in combination in any one region. They are local variants confined to distinct geographical areas as indicated in table IX.1.

It is difficult to explain this mutual exclusion. As far as the *puang*-realms are concerned, Mengkendek, Ma'kale and Sangalla', one might ascribe the position of the *burake tambolang* to Buginese influence. Yet, in other places where the *burake tambolang* officiates, in Madandan for example, the Buginese influence is of less intensity than in *puang*-regions. On the other hand, the occurrence of a *burake*

tattiku' in Nonongan could be related to the importance of the female ancestor in this area (the previously mentioned Manaek). Again, this is an *ad hoc* explanation which is not valid for the other districts where a *tattiku'* officiates.

Table IX.1: Geographic distribution of *burake tambolang* and *burake tattiku'*

<i>Burake tambolang</i> in the district of:	<i>Burake tattiku'</i> in the district of:
Mengkendek	Balepe'
Sangalla'	Riu
Ma'kale	Pangala'
Buntao'	Tikala
Madandan	Dende'
Tikunna Malenong (Kesu')	Piongan
La'bo' (Kesu')	Banga
	Taleon
	Malimbong
	Nonongan (Kesu')

IX.6 The to *ma'dampi*

The *to ma'dampi* is a medicine man, or woman, who performs in the *maro*-ritual and at *ma'bugi'* (see Vol. II). The mythical medicine woman is Indo' Belo Tumbang, also known as Indo' Bunga Sampa' (cf. the *Passomba Tedong*, Merok: 142ff.). She is the female protective spirit who watches over the medicine as it is used in the *maro*-ritual.

In most instances the office of the *to ma'dampi* is hereditary. Below there follows a brief biography of Ne' Banne, a man of Kanuruan in Nonongan. He is not only a *to ma'dampi* but a *to minaa* and a *to indo'* as well. Through the combination of his offices he is an extremely busy person. Here I shall restrict the account to his functions as a *to ma'dampi*.

Ne' Banne must act on behalf of three categories of gods and spirits:

- a. the first (and most important) is Datu Maruru', the spirit who induces smallpox. Datu Maruru' is not simply an evil spirit; he falls within the sphere of the *rampe matallo*, the rituals of the East. His name means, literally, the Righteous Lord. He has

- provided Ne' Banne with specific instructions about how to cure smallpox;
- b. the second group is that of the *deata*; these gods were the ones whom he first encountered;
 - c. the third group of spirits assisting him, are the *to diponene'*, the ancestors.

Ne' Banne does not consult Datu Maruru' every time a new case arises, for curing smallpox has become a routine affair. If he bungles his work, Datu Maruru' becomes angry. Even a *to ma'damp*i can err; he must abide by the instructions once given to him. It was in 1922 that he 'met' Datu Maruru' for the first time (in a dream). Ne' Banne has brought many persons back to health. He must stick to the guidelines provided by Datu Maruru' or this spirit will punish him — by throwing a stone at him, for example, or by hiding Ne' Banne's betel pouch. Other *to ma'damp*i also have such a protective spirit and all these spirits have a name; one medicine man was reported to have a protector of the name Kurre Sumanga' ('Thank You', or more exactly, 'come, *sumanga'*).

Ne' Banne does not officiate at *maro* and *ma'bugi'*-rituals; he confines himself to the treatment of individual cases of illness in his village. He cures smallpox by rubbing the patient's sores with water from a *kandian lau* (a water jar fashioned from a calabash). In the water he has placed leaves from three plants: the *passakke*, *darinding* and *tananti*.¹⁶ He uses three water jars, because a different *kandian lau* is required for each kind of spirit assisting him.

When a patient summons Ne' Banne he does so by sending a mediator with *sirih-pinang* (betel and areca nuts). Ne' Banne cuts the nut in half and sees whether he detects auspicious signs.¹⁷ Then he addresses a prayer to his three categories of helpers. Then he proceeds to his therapeutic work, becoming, as he himself put it, 'crazy'. From his words must be inferred that he enters into a trance. Should the patient recover, then Ne' Banne receives payment: for Datu Maruru', 7 'dimes' (Indonesian: *ketip*) and 36 small bundles of rice (1 bundle = one *sangkutu'*); for the *deata*, 5 'dimes' and 36 *sangkutu'*; for the *to diponene'*, 6 'dimes' and also 36 *sangkutu'*. He may not receive any less, neither is he allowed to ask for more; this would enrage his spirits. They fixed his payment when they proposed to him that he become their 'messenger'.

Ne' Banne is always busy as a result of his triple function and

sometimes his offices conflict with each other. Once while he was performing as a *to indo'*, for the rice cycle had already begun, Ne' Muda, a prominent personage in his village, Kanuruan, called upon him to come to treat his three sick children. Since rice and illness belong to different spheres which are not compatible with each other (disease must be kept far from the rice),¹⁸ Ne' Banne was at a loss to do. His perturbation was all the greater because one of Ne' Muda's children had already died before the medicine man was sent for. Fortunately, improvement took place rapidly, releasing Ne' Banne from a difficult choice.

Ne' Banne must submit to certain taboos; he may not wear black clothing; during particular phases of the moon (*bulan sampe* and *bulan sombo*, waning and waxing moon, respectively) he may eat no pork. In the room of a patient there may be no black objects (black is the colour of the mourning).

Ne' Banne has not grown rich from his three functions. He told how he became a medicine man: he was a rich man's righthand-man and helped him pay out wages to those who worked on his *sawahs*. Once after helping to hand out pay, Ne' Banne felt ill and lay down on a *sawah* dike. Someone saw him there, a man called Ne' Ranggina and in order to comfort him, he tread with his foot on Ne' Banne's stomach. Ne' Ranggina thought that by so doing he had brought the patient relief, but meanwhile Ne' Banne had fainted. Ne' Ranggina was taken aback and with four other men brought Ne' Banne to the hospital. Ne' Banne stayed there for some time but was then sent home. He did not return to his own house, but rather to the home of the above-mentioned Ne' Muda. There he fell asleep but then a number of tiny spirits came to tease him. At first he mistook them for small children. They were of a yellow colour, with yellow hair and yellow teeth (this is a common description of the appearance of the *deata*). He also felt something cold in his heel; these were the *linggis*¹⁹ of the *deata* who were stabbing him there. No blood flowed, however. Next — also in his sleep, but with eyes wide open — Paragusi came (see V.4.4). This visitor placed a stomach (complete with intestines) next to Ne' Banne and said, "This is the stomach of the dog that belongs to X". But Ne' Banne answered: "It might well be *my* stomach and intestines!" He did not accept Paragusi as a protecting spirit or tutor because he found him to be an evil spirit (intestines are the food of the *batitong*, werewolves). The whole time that Paragusi was in his vicinity, Ne' Banne was afraid: the spirit was

dreadfully large, and had a long beard. The following day Ne' Banne learned that the dog of X was indeed dead.

Then Datu Maruru' came and at the same time the *to diponene'* appeared as well as the *deata* who had teased him. They provided him with the means for curing the sick: into the water jar described above, the *kandean lau*, they poured water and then added *passakke*, *daun buangin*, *kuni* (curcuma), *manik riri* (yellow beads) and *pamuntu* (scrapings from a piece of an iron pan). They also told him that the medicine could only be used for one specific illness (i.e. smallpox, perhaps also chicken pox). The healing substance had to be used, however, in the name of Datu Maruru'. In the past days, Datu Maruru' explained, smallpox came at set times, but at present (the time when Ne' Banne was presented with the medicine) everyone is struck who first drinks water from the well in which 'I' have sown the disease. Since their first encounter, Ne' Banne has seen Datu Maruru' now and again (who, he said, is yellow like the gods and wears a dress 'like you' — the last remark concerning me). He also catches glimpses of the *to diponene'* (who look like Toraja) and the yellow-tinted *deata*, but he no longer sees them as frequently as he once did.

IX.7 The burake and the priests of neighbouring peoples;

Summary

The *burake tambolang* displays marked similarity to the *bissu* of the Buginese and the *sanro* of the Makassarese. An antiquated word for *burake*, indeed, is *bingsu*; the term is still used at the *merok*-feast (Merok: 146f., verse 755). The *bissu* of the Buginese is also a homophile (?), a transvestite or a 'hermaphrodite' with a religious function: in Luwu' and at princely courts elsewhere in South-Celebes, these priest(ess)es used to be the guardians of regalia. In Segeri, near Pare-Pare, the *bissu* took the lead in the cycle of rice cultivation by performing the ritual ploughing. The *bissu* are also masters of medicine. This function is not allotted to the *burake tambolang*, nor is officiating during the rice cycle.

It is beyond doubt that some connection exists between the Buginese (Luwu'nese) *bissu* and the Sa'danese *to burake tambolang*. Whereas the latter officiates at a feast aimed to promote the well-being of a larger group, the *bissu* in Luwu' is a court dignitary, the keeper of the regalia on which the overall prosperity of the kingdom depends. In Segeri (also Buginese territory) the *bissu* is the foremost functionary in the rice ritual.

The *to burake tambolang* is associated with the polarity as well as the balance between upper- and underworld, day and night, man and woman. In the person of the *to burake tattiku'* the scale would appear to rise a bit upwards towards the realm of the upperworld. The titles bestowed on these two categories of priests are borrowed from birds: the large *tambolang* (stork), the small *tattiku'*-bird.

The *burake bombo* is the priest of the impure dead; he performs in mortuary rituals, those of the lefthandside, those of the southwest.

The *to minaa* guides men along the path of life. He officiates at rites of transition, is the keeper of the traditions of the ramage or *adat*-community and performs at the *merok*-feast celebrated by the host and his kinship group. He is the priest who functions in the world of man.

Finally, there is the *to ma'dampi*. He is one of the two shamans of Sa'dan-Toraja culture. The other is the *to burake*, both the *tambolang* and the *tattiku'*. The *to ma'dampi* is a typical example of the type of shaman medicine man found in so many parts of the world (only in the district of Balepe' does the *to burake tattiku'* also minister to the sick). Both the *to burake* and the *to ma'dampi* undergo at the outset of their official lives the so-called 'shaman-disease' which manifests itself in psychic tension, trance phenomena, dreams, and disturbances of memory, etc. (cf. Eliade 1964, chapters II-IV).

All those priests we shall meet again in Vol. II of this book which is devoted to the description of the ritual and ceremonial life of the Sa'dan-Toraja. They are the masters of ceremony who immediate between the people and their gods and thus see to it that calamities be averted and man and beast be blessed with peace.

NOTES

CHAPTER I

- 1 Brevity characterizes this introductory chapter because several topics, such as the clothing and adornment of the Toraja and how the Toraja differ ethnically from neighbours, have been treated at length in other publications (Nooy-Palm 1969 and 1975). These subjects will reappear, moreover, in a series of monographs about Indonesian peoples. The aim of this series dictates that the monograph about the Toraja will deal with contemporary administration, education, material culture, and forms of handicraft.
- 2 The kingdom was also called Luwu' but was spelled with a *hamzah* (glottal stop) at the end.
- 3 Pongkapadang, the important ancestor of the Mamasa-Toraja, is a descendant of one of the oldest Toraja ancestors (oral information from Dr. H. van der Veen).
- 4 The Toraja, inclusively speaking, were in fact differentiated into East-, West- and South-Toraja; the Sa'dan-Toraja fall within the category of South-Toraja.
- 5 Oral information by the late Prof. A. A. Cense to Dr. H. van der Veen.
- 6 The *Kroniek van Wadjo'* [The Wajo' Chronicle], translated and annotated by J. Noorduyn, is an exception (see also section 7 of this chapter).
- 7 Catholic priests came from Belgium and the south of Holland, Protestant missionaries from other regions of The Netherlands.
- 8 On this section see Van Braam Morris 1888, 498; Crystal 1974; Van Lijf 1948; Van de Loosdrecht 1921, 131-153; Pol, undated (1947?); Van Rijn 1902; Van der Veen 1940a.
- 9 Table 1 (agricultural use of land) fails to communicate whether dry fields and *ladang* are used for rice production exclusively, or also for maize and manioc.
- 10 *Tae' (Zuid-Toradjasch)-Nederlandsch Woordenboek met register Nederlandsch-Tae'* by H. van der Veen ('s-Gravenhage 1940). Later there appeared also J. Tammu and H. van der Veen, *Kamus Toradja-Indonesia* with collaboration of L. Pakan (Jajasan Perguruan Kristen Toraja, Rantepao 1972).
- 11 A civil servant of an administrative branch, when departing from his post had to leave behind for his successor a complete survey of the region under his jurisdiction. These reports provide information about both land and people.
- 12 *Memories van Overgave* can be found in the non-circulating library of the Museum and Social Science Research Division of the Royal Tropical Institute in Amsterdam and in the library of the Royal Institute of Linguistics and Anthropology in Leiden. There are also copies in the Government Archives at The Hague and, for *Memories* up to and including 1900, in the Government Archives at Schaarsbergen. Additional *Memories* are available in the Statistical Archives of the Ministry of the Interior at The Hague.
- 13 A sequel was promised to this second article which Van Lijf, alas, was unable to finish because of his premature death.

CHAPTER II

- 1 This word can also signify the naming of the parts of the body in sequence which might suggest that one conceives of the ramage anthropomorphically.

- 2 These honorific names are acquired, by women as well as by men, on the occasion of a great *buah*-feast. A dead man of rank receives a new name again during a certain stage of the ritual for the dead. In quotidian life, however, one is simply called Lasok X or Pong Y or Ambe'... if a man, and Lai' Z or Indo'... if a woman. Grandparents are often designated by the name of their oldest grandchild: Ne' Sangga ('Grandfather of Sangga'). (*Ambe'* = father, *indo'* = mother; *Ne'* = grandfather or grandmother.)
- 3 Making use of bits of the ribs of sugar palmleaves is called *rebongan didi* (literally: the breaking of the veins of the leaf of the sugar palm). This works as a memory aid; see the process as described in the text.
- 4 The number of generations counted varies according to whether the first ancestor in heaven is included or counting begins with the first ancestor who descended to earth.
- 5 For the names Patabang, Telebuë, Parange and Pata'ba I am unable to provide any translation.
- 6 Although this territory is part of Kesu' it has a separate status.
- 7 See Robin Fox 1967: 164ff. In Toraja there is no special word for kindred.
- 8 *Dapo'*: hearth. *Rampanan* has different meanings: 1. a thin beam on the side of the house which supports the lower extremities of the roof; 2. to let go, to free, to lay down. *Kapa'* also has more than one meaning: 1. a fine to be paid by a marriage partner who commits adultery; 2. cotton (see also II.5.2).
- 9 J. S. Bulu', 'Hukum perkawinan (*rampanan kapa'*) menurut adat Toraja Sa'dan', stenciled manuscript, Ujung Pandang 1970 (translation: 'Marriage law according to the *adat* of the Sa'dan Toraja').
Mangesu' Matandung, 'Tinjauan selayang padang tentang Pasandak Salu Lako Rampanan Kapa' sebagai delik adat pada masyarakat Toraja Sa'dan', stenciled manuscript, Ujung Pandang 1973 (translation: 'Global considerations concerning the *Pasanduk Salu Lako Rampanan Kapa'* as common law delinquency in the society of the Sa'dan Toraja').
(Note: Here only Indonesian words have been translated; the Toraja expression *Pasanduk Salu*... remains to be elucidated.)
Access to both sources is difficult; Matandung's thesis is contained in the Research Library of the Royal Tropical Institute at Amsterdam.
- 10 Matandung's view strikes me as having more to offer. Indeed, during a certain rite of the great *buah*-feast (see Vol. II), the *burake*-priest purifies cotton with a cotton-bow, that is normally used for cleaning seeds from the raw cotton, symbolizing thus the cleansing of the atmosphere.
- 11 The term also means: important village meeting.

CHAPTER III

- 1 He was one of the seven children who originated from the seven leaves of a tree which sprouted from the ashes of Puang Matua's bellows (see Merok: 104ff).
- 2 The use of the name Tumba' is surprising; it is usually reserved for women of the upper class who attend the great *buah*-feast.
- 3 The poetic name for a slave is *to ponto litakan* ('the one who wears a bracelet of clay').
- 4 These are chores which fall to *kaunan* (slaves) during a ritual. At present (former) members of the slave class still perform them as their part in a traditional exchange of services.
- 5 Sometimes *kaunan* can also own land, occasionally even *sawahs*. (Information from H. van der Veen, who, during his sojourn in Tana Toraja, rented a plot

- of ground for making clay bricks from a man who belonged to the *kaunan*-class.)
- 6 Even formerly it 'was not proper' to use the term *kaunan* in the presence of a slave.
 - 7 *Garonto'* = stock, land, beginning, origin; *bulaan* = gold. The term *kaunan bulaan* was used especially for the household servants of the *puang*, all of whose possessions, his own person included, were associated with gold.
 - 8 N.B. Here the term *kaunan* itself is used, and not a polite alternative.
 - 9 *Tuyu* is a kind of rush used for braiding mats and handbags; *passasaran tuyu*: small pieces of *tuyu*; *pare pare nangka*: the hard bits of the *nangka*-fruit which are inedible. *Anak patalo*: *anak* = child, *patalo* = victor.
 - 10 In the following districts people do not speak of *to parengnge'*, but rather of *to ma'dika* ('the free'): Balepe', Bau, Balla, Bittuang, Buakayu, Kurra', Mappa', Rembon, Ulusalu, Sesseng, Simbuang, Taleon, Palesan, Rano, Pali and Tapparan.
 - 11 The name might be translated as follows: the *to makaka* who are carried (*direngnge'*), who, in fact, do not belong entirely to the *to makaka*-class but are tolerated, carried along with it (own interpretation).
 - 12 This hypothesis, extremely difficult to test, comes from informants from Kesu'.
 - 13 The *tandilo* is a musical instrument (a stick-cither) which resembles a *geso-geso*, a kind of violin; *tandilo ula'* is the name of the clapper-drum of the *burake* ('priest'), the *gamaru* or *garatung*.
 - 14 Although the above is stated in the past tense, certain functions of the *tongkonan layuk* are filled to the present-day.
 - 15 The same holds true for more lowly *to makaka*.

CHAPTER IV

- 1 According to Tandilangi' (1975) and Tangdilintin (1975 : 180/85) a *bua'*-circle is divided into several *penanian*. It is possible that this only obtains for the Tallulembangna.
- 2 For location, see Map 2. The name Buntao' is a contraction of Buntu Ao': 'the Hill on which the Bamboo Aur [a particular variety] grows'.
- 3 Cf. *batu parandangan*, stone corbels upon which the piles of a house or a ricebarn rest.
- 4 The term *Talinga rara'na Sangalla'* (see IV.1.7) was similarly elucidated.
- 5 There is still a further title attached to Sallebayu: that of *sokkong bayu* of Tonga.
- 6 Tikunna Malenong consisted originally of the *bua'*-circles (which are also villages) of Ba'tan, Angin-angin, Pao and Tonga. Two other *bua'*-communities (= villages) joined Tikunna Malenong later. When this happened, I do not know.
- 7 The important tradition of Nonongan also played a part in political decisions of more recent days. At the time that a successor to Pong Maramba' had to be chosen, in about 1916, Nonongan pretended that it had a better claim than others to the office of territorial head for all Kesu', it only acquired the office of *kepala bua'*, or *bua'*-head. Tikunna Malenong and La'bo' also received a *kepala bua'* at that time; these functionaries were eliminated later on.
- 8 Pong Panimba, the father of my informant Roson Panimba, was an important *adat*-chief in Kesu' prior to World War II.
- 9 It is doubtful whether a new prince will indeed be chosen considering the fact that the state of Sangalla' has acquired another legal form and considering

- also that the sons and daughters of the deceased *puang* Lasok Rinding have converted either to Christianity or to Islam.
- 10 All these animals are parti-coloured; some of their patches, characteristically, are white — the colour with which the *puang* is associated.
 - 11 *Kua-kua* is probably *Rottboellia glandulosa*. The name *kua-kua* points to slaves; cf. *tana' kua-kua*, class or status of slaves (information from Van der Veen).
 - 12 This *Simbuang* should not be confused with the (former) district, the *lembang Simbuang*.
 - 13 In the modern era, the church has become a social (religious) center. Often a number of settlements share a single church building.
 - 14 Originally Silanan consisted of two *lembang*, Silanan and Pemanukan, which were united under the name of Maduan Salu: 'The Three Rivers'. The whole area was divided into ten *bua'* under a *pa'palumbangan* (for this title see IV.1.7). The *pa'palumbangan* was related to the *puang*. The *puang*-dynasty had also intermarried with the principal *tongkonan* of Silanan. The family of the *pa'palumbangan* is referred to as *ma'dika*. Another part of Mengkendek was Gandang Batu ('The Stone Drum'). This region was also called Sikampa Susunna Arra ('The Watch near the Boundary Post') or Tallu Kurinna ('The Three Cooking Pots') a name which refers to its three *bua'*. This area was governed by a *pa'palumbangan*.
 - 15 To prevent any misunderstanding: there are also *tongkonan* with no titles attached. A *tongkonan* is an *adat*-house, which, if status permits, is decorated with attractive carving; it serves as a center for a particular (sub)ramage. Not every (sub)ramage, however, is in possession of a title. Slaves also have a *tongkonan*.
 - 16 C. J. Grader, 'Tweedeling in het Oud Balische dorp', *Mededelingen van de Kirtya Lieftrinck-van der Tuuk* (Singaradja 1937); F. W. F. Hunger, 'Eenige aantekeningen over de Noord-Balische Aga desa's Sidatapa en Pedawa', *Djawa XVII*: 367-371, 1937; V. E. Korn, *De Dorpsrepubliek Tnganan Pa-gringsingan* (Santpoort, 1933). See also: V. E. Korn, *Het Adatrecht van Bali* [The *Adat*-law of Bali], 2nd ed. ('s-Gravenhage, 1932); and for information on other regions, R. M. Koentjaraningrat, *Villages in Indonesia*.
 - 17 In Madandan the *saroan* is a community whose members farm a vast *sawah* collectively and together receive payment for their work. It is thus a territorial work-community with an economic base. Sometimes the Sa'danese *saroan* is highly reminiscent of the Balinese *sekaha* or *banjar*, a ward in a Balinese village. (A *sekaha* is a society: *sekaha subak*, a *subak* society, comparable to a polder or river-board.) There are, however, structural differences. In Madandan a large *saroan* with some 30-40 members is called a *sarobussan*; a small *saroan* with no more than 3-8 members, a *saro'-saro'*. Just as is true for the Balinese *subak*, every *saroan*-member has equal rights even though formerly the *kaunan* yielded precedence to the *to makaka* because class differences were deeply imprinted on society. Membership in a *saroan* was obligatory, in fact, for a fine was levied on those who did not participate. A *saroan*-member is known as *to sumaro* (Harahap 1952: 60). Harahap maintains that *saroan*-heads were from the *to makaka*-class; they were sometimes called *indo' saroan* (= mother of the *saroan*). The head of the *tongkonan* is then also the *saroan*-head. In the territory of Simbuang the *saroan* has the name *akka'*, a word which conveys the meaning 'to take up and to shift'. This organization is an institutionalized form of mutual aid.
 - 18 *Buntuasa* is the name of a cliff situated in the region of Marante. *To Mendarang* is derived from *mendarang* ('to warm oneself by the fire').

- 19 This can also be a proper name; *To Pongmasa'ga'* was the leader of the resistance against the Dutch-Indies regime in 1917.
- 20 The *anak to makaka* of Ranteballa (Palopo) and Rongkong must be equated with the *parengnge'* of the Sa'dan region.
- 21 Each of the two wards is further subdivided into two, e.g. *diongnalu* in the wards Koro-koro and Bo'ne.
- 22 As my Toraja informants themselves observed, it is difficult to give any explication of this title. In Kanuruan, Nonongan, I was told that the 'jackets' stood for family members, usually the other *to parengnge'* in the village. The 'collar' is, as it were, that part of the garment from which the rest hangs (i.e. on which the whole depends).
- 23 *Manobok* is literally 'to pierce with a lance'. It was formerly the custom to kill the *kerbau* with a spear-thrust through the heart. Because the Chinese merchants pay more for undamaged *kerbau* hides, piercing with a lance through the breast has in many territories been replaced by delivering a death blow to the throat with a large machete.
- 24 Van der Veen told me that the tasks alternate if the feastgiver's *tongkonan* is in Ba'tan *doan*, then the *sokkong bayu* recites the prayer in the compound; if, however, it is in Ba'tan *diongan*, it is the *datu baine* who performs this office.
- 25 During the *mangrara banua* and the *merok*, two pigs are sacrificed, one in the house, the other in the yard.
- 26 *Sipalakuan*: to ask each other for something; see also *Woordenboek*: 257, v. *lakoe*.

CHAPTER V

- 1 Nevertheless, I since found a similar notion suggested in Merok: 34.
- 2 Sometimes division into seven spheres is assumed; cf. the sacrificial prayer during the *Mangrara Pare* (Vol. II).
- 3 For Indo' Ongon-ongon, see *Overleveringen van den Beginne vanuit de Hemel in geregeld volgorde medegedeeld door Ne' Mani', priester uit Sereale*, edited and translated into Dutch by Dr. H. van der Veen, *Bijdragen* 132 (1976) : 418-438.
Translation of the title: 'Traditions of the Beginning descended from Heaven and reported in proper sequence by Ne' Mani', a priest from Sereale. Sereale lies on the slopes of the Sesean; Ne' Mani' was a *to minaa*. The work will be quoted as: *Traditions reported by Ne' Mani'*.
- 4 *Deata* also means spirit in the sense of life spirit. When a man experiences sudden fright people say *mellai deatanne*, his life spirit flies. Evidently, *deata* in the sense of deity indicates a living god, a god of life.
- 5 A quarrel is adjudicated, if necessary, by a cock fight. Pong Lalondong's cock's feather splendour has to do with his function as judge.
- 6 The other gods are also referred to as 'merciful gods', 'lords of great compassion' (Merok : 40-41).
- 7 Earlier, during the consecration of the buffalo which is recited during the *merok*-feast Puang Matua is depicted as measuring out and balancing the periods of night and day against each other (see Merok: 29).
- 8 According to A. A. van de Loosdrecht it is Puang Matua himself who shears the thread of life for man (Van de Loosdrecht 1914 : 239).
- 9 *Doti* are dots; the *doti langi'* are a symbol of abundance.
- 10 In the light of both her name, *bulaan* = gold, and her situation in the zenith, she conjures up thoughts of the sun.

- 11 *To Tiboyon*, when thought of as a single deity, lives in a *sawah* beside Karua, a mountain in Bittuang. In this *sawah* rice always flourishes. Belief also places her home either in the lower reaches of the major rivers or in *sawahs* generally (Bikker 1930 : 348).
- 12 *Bombo* is also the term for the soul of the living, the soul which can abandon the body during sleep, and journey about, even to the land of the dead (A. C. Kruyt 1923/24 : 74; Wilcox 1949 : 109).
- 13 Occasionally it is claimed that the sacrifice of a dog in front of a rock grave is performed so that the dog's soul shall chase away the cats which lurk at the entrance to the land of the souls (information from Dr. H. van der Veen).
- 14 The souls of women who died in childbed (elsewhere in Indonesia more feared than anything; cf. Sell 1955) do not arouse terror in Tana Toraja. Such women are buried in the same manner as other people and there are no rumours about their souls being dangerous.
- 15 Not to be confounded with *Datu Laukku'*, the first man created by Puang Matua.
- 16 Why not in Baruppu'? Perhaps because the position of a ramage-leader is here less prominent than elsewhere? Or is that position weaker because the tradition of a heavenly ancestor is lacking? We simply do not know.

CHAPTER VI

- 1 In practice the concepts *aluk* and *ada'* are not always clearly differentiated; *aluk*, the term for ritual, is also used in the sense of a precept or commandment underlying a custom.
- 2 Actually, among the Toraja, too, instinct often prevails over principles, for the so-called *ulelean* are on occasion incorporated as 'tales' in the *ossoran*; see, for example, Van der Veen 1976, *Ossoran Tempon daomai Langi'* (Traditions reported by Ne' Mani'), in which the folk story of Marampio Padang has been incorporated. And the *Passomba Tedong* contains a condensed segment of the story of Tulangdidi' (see Merok: 70-73).
- 3 The earth (Mother Earth) is pictured as feminine. Subsequently, a masculine god of the earth is born, Pong Banggairante.
- 4 Diverse versions of the creation myth exist; thus the 'Traditions of the heavenly beginnings of things' recorded by Ne' Demme, an *adat*-expert from Kesu', presents a somewhat different picture than that of our present text which has been borrowed from the *Passomba Tedong*. Ne' Demme's work has been translated and annotated by Dr. H. van der Veen but I have chosen not to discuss it here because it remains uncertain whether these 'Traditions . . .' will be published.
- 5 These names admit alternate spellings: Pong Banggai Rante, Pong Tulak Padang, Gaun Tikembong. I have chosen, however, to adhere to Van der Veen's spellings.
- 6 Other names for this deity are Puang Bassi-bassian, 'The Lord who is covered with the speckles of age', and To Kaubanan, 'The one with the grey hair'; the latter is also a second name of Puang Matua.
- 7 Stöhr associates the theme of divine spouses who originate from rocks with megalithic cultures (1965 : 150-151). The theme recurs in the Minahasa, North Borneo, South Nias and Riung (Flores).
- 8 *Ubi* is the Indonesian term; the Sa'dan-Toraja word is *dua'*.
- 9 These important goddesses are also associated with rice.
- 10 In Ne' Demme's 'Traditions . . .' this is an alternative name for Pong Lalondong. Cf. note 4, above.

- 11 The young women and girls performing *to tumbang* roles attach the word *Tumba'* as a prefix to their names. *Tumba'* means to leap, to jump up. (For the *buu'*-celebration, see Vol. II.)
- 12 The creation story here given deviates from the 'Traditions recorded by Ne' Mani'. Ne' Mani's tale is more elaborate than the present text which is an abridgement of the creation myth in circulation in Riu. In Ne' Mani's account the goddesses Simbolongpadang and in particular Indo' Ongon-ongon are prominent. The former separated heaven and earth by creating the lightning. The latter descended to the underworld to become the wife of Pong Tulakpadang. Indo' Ongon-ongon made the earthquake and shock the ground. Moreover, she created the night. Comparable goddess protagonists are absent from the Kesu' myth.
- 13 Van der Veen's translation of the Merok text (p. 85, verses 407f) ignores one important detail. Puang Matua is instructed by his works to penetrate into the rock hiding his future wife by means of a *tallang baine*, (a piece of) a *female* bamboo *tallang*. The inversion of sex (bamboo normally is a male symbol) attributed to the god's action should not be passed by unnoticed. Puang Matua's bellows carry a comparable inverted symbolism. An informant, consulted on the meaning of these bellows, explained to me that the two bamboo pipes of the bellows are their female organ, the bellows proper, the belly, the male part, and that the whole is a symbol of marriage.
- 14 Also the name of a certain sacrifice, see VIII.7.
- 15 Naturally, 7,777 is a symbolic number. Seven is an important number in this culture. The four sevens indicate the total inclusion of all rituals one can think of.
- 16 It goes without saying these are late additions to the story.
- 17 In Tandilangi's article (1967) the reason given for destroying the ladder was an act of incest in Rura (see VI.3: Myths concerning the consequences of incest). Another account of the removal of the celestial ladder comes from elsewhere in Tana Toraja; see VI.4.2a: The tale of Pong Sumbung Sare Pio'.
- 18 Sanda Bilik, who sprang from a *boulder* in the *river*, combines the origins of a goddess in heaven who originated from a *rock*, and an important ancestress on earth who emerged from a river or a well. See also Van der Veen 1979: 20 note 14.
- 19 *Sokko* = horns which are turned downwards; *remak* = garrulous; *Sokko remak* = The Garrulous Buffalo Whose Horns Curve Downwards.
- 20 Another version tells how the buffalo when he could swim no further, sacrificed himself by letting a crocodile eat him. In payment the crocodile offered to bring Lakipadada safely over the sea. Before he sacrificed himself, the buffalo made Lakipadada promise not to eat the flesh of his descendants, the white buffaloes. For yet another account, see Nobele 1926 : 127-128.
- 21 This might explain why, in the context of the higher rituals for the dead in the *puang*-regions (and in Kesu' and Nanggala, too), during a certain rite a small wooden figure, carved and adorned with paint, is carried along which bears the name of *bungkang-bungkang* (= that which resembles a crab).
- 22 *Mangga*, Indonesian for mango; Toraja: *pao*.
- 23 *Garuda*: a mythical bird in Hindu mythology.
- 24 Later this pit turned into a dish divided into two parts. It now belongs to the *pusaka*-objects of the *puang*-family. This '*mangga-pit*' is, in fact, the nut of a palm, *Lodoicea Sechellarum*, that is indigenous to the Seychelles!
- 25 In Nobele's version Lakipadada marries the granddaughter of the prince (Nobele 1926 : 126). Puang Tandilangi' pointed out to me that he himself had followed the example of his famous ancestor by marrying a princess from

- Goa (Puang Tandilangi', as Puang Sombolinggi', is a son of the late Puang Lasok Rinding of Sangalla').
- 26 For information about the two *pusaka*-flags owned in Goa and Luwu' respectively, see Nobele 1926. (*Pusaka* is the Indonesian term for heirloom, often a heirloom of sacral value.) The 'flag' of Sangalla' here mentioned should be distinguished from the *bate manurun* (the *bate* come down from heaven) which plays a role in the *maro*-ritual as celebrated, among other places, in Tikala (see Vol. II).
- 27 The name Manaek is untranslatable; Polopadang = Part of the Land (Earth).
- 28 The antagonism between Kesu' and Luwu' reaches back to this mythical event.
- 29 There exist a number of versions of this myth. In one of these Deatanna is called Tonglo Sugi', The Exceedingly Rich One. She repeatedly stole *kaise'*-fruits from Polopadang's fields. The thievery caught his attention. Finally Polopadang succeeded in unmasking the culprit.
- 30 According to another version: four baskets full of millet.
- 31 Suloara': 'He whose breast shines as a torch'.
- 32 *Sibali*: become a pair, marry. This concept entails a form of reciprocity between two houses (subramages). See VIII.1: The *tongkonan*.
- 33 Duri is the mythic — and probably also the real — country of origin of the Sa'dan-Toraja on Celebes; is is, in any event, the area where these Toraja lived for a time.
- 34 Two versions of this myth exist. According to the other one, Londong diRura was spared and became the patriarch of the Sa'dan-Toraja.
- 35 The present myth is from Kesu' and might just as appropriately have been printed in section VI.2.2: The *to manurun* in Kesu', which pictures Londong diLangi' (or Londong diRura) as the initial ancestor of all important ramagees in the Sa'dan region. The myth has been placed here, however, because it portrays how marriage restrictions entered the world.
- 36 Not a Toraja expression.
- 37 One version of VI.2.2b: Polopadang and Deatanna, might fit here. In this version Deatanna steals *kaise'*-fruits from the field of Polopadang.
- 38 Marampio Padang also appears in the *Pangimbo Manuk*, the prayer to be said at the Chicken Sacrifice, similarly annotated and translated into Dutch by Van der Veen (see verse 124). Unfortunately, this 'prayer' has not yet been published.
- 39 For variations on Sulawesi, see Van der Veen 1976 : 434, note 119. Throughout Indonesia this tale recurs; the form may vary but the theme remains the same: theft committed by a person or animal from the underworld. A similar story is found also in Goa (see B. F. Matthes, *Boeginese en Makassaarse legenden* [Buginese and Makassarian Legends] in Ds. H. van den Brink, *Dr. Benjamin Frederick Matthes*, Amsterdam 1943 : 384-385). For the tale as it exists among the Batak, see W. Braasem in *Oriëntatie* no. 17; for the version current with the Iban, see Gomes 1911 : 300-316.
- 40 According to Radjab, the cock collected Tulangdidi's bones; presumably this author suspected a connection with the Indonesian word *tulang*, bone. However, in Toraja, Tulangdidi' means 'The Upright Yellow (One)'.
- 41 In an alternate version the instrument was a rice pestle; the cock suffered a broken wing and flew up to the sky.
- 42 Precisely which constellation the Toraja mean is not clear. A clue is provided, perhaps, by the constellation Tamangkapa (= the Wing Flapper, the Cock) of the Bare'e' Toraja. It has a role analogous to that of Londongna Tulangdidi' among the Sa'dan-Toraja. The Pleiades constitute its head, Orion's Belt

- the body and Sirius the tail (Van der Veen 1924c : 70). The myth of Tulang-didi' and her cock is also found among the Bare'e' Toraja.
- 43 Radjab has also included this myth in his anthology of tales (Radjab 1950 : 18-36). His version differs from Kruyt's. The story is also known among the Bare'e' Toraja.
- 44 This is an old element in the myth, for the dead today are no longer interred in a coffin.
- 45 According to Wertheim folk tales circulate first and foremost among the lower classes. These tales are characterized by an element of social protest. In this they differ from myths which must be associated primarily with the upper classes (Wertheim 1964 : 21-37).
- 46 The souls of dead persons of status are thought to reach the firmament by ascending along a coconut tree.
- 47 This information is remarkable because up to this point the tale has suggested that Pano Bulaan was made pregnant by an unknown, or socially non-acceptable partner.
- 48 Rangga (= having branches) Bulaan (= gold) is the name of a girl also called Adeng (= ?) Bulaan or Pano Bulaan. The story was translated into Dutch by R. M. Djojowiriono. The original Toraja text with the Dutch translation are in the Research Library of the Royal Tropical Institute in Amsterdam. The text was taken down from narration by Mr. L. Pakan who also wrote an explanatory introduction which runs as follows: The marriage customs practiced in Tana Toraja are highly respected. They date from the beginning of the world. If a woman became pregnant before she had a husband she would bring the utmost disgrace to her mother and father and all other family members besides. Such a woman had to be punished, banished from the country and drowned in the deep ocean.
- 49 In the Toraja text: *rampanni kapa'* and *napobaine*. For information about *kapa'*, see II.5.2.
- 50 In the Toraja text the words used for sword are *la'bo' penai*; these are short swords which have a special function in the *maro*-ritual See VIII.3.2. and Vol. II.
- 51 *Induk*: sugar palm, *Arenga saccharifera*.
- 52 *Oda-oda*: a stabbing or cutting weapon.

CHAPTER VII

- 1 *Tedong* is also used in Buginese for *kerbau*. In Sa'dan-Toraja there is no specific word for a bull except in the territories of Ulusalu, Bittuang and Mamasa: *aa'* and in Ma'kale: *aya*. A large adult sacrificial bull, however, is called *penamile* or *pinamile* (*penule* in the district of Dende').
- 2 A concentration of flecks, dots, etc. is associated with the stars in heaven and with an abundance of grains of rice.
- 3 These verses follow a passage from the *Passomba Tedong* discussed in III.1.
- 4 For the story of a white buffalo who cured a princess of Luwu' from her skin disease by licking her, see Noorduyn 1955 : 32 and 33.
- 5 In addition to the notion that the first male buffalo came from heaven, the first female from earth, there is also a belief that a buffalo trail winds through the Kingdom of the Dead and that there is a cave full of *kerbau* who trample the souls of criminals.
- 6 A descent line of the *kerbau* is also presented in the *Passomba Tedong* (see Merok: 120-133, verses 439, 653ff.) Cf. also *ibid.* 90f, and 1976 : 427, verse 11.
- 7 This happens, too, whenever the *pa'karu'dusan* is sacrificed during a mortuary

- ritual of high order. For further information about the role of the sacrificial *kerbau* cf. Vol. II on the *merok*, the *bua' kasalle*-feasts.
- 8 According to informant B. Sarungallo it is wrong to call this motif *pa'tedong*, for the name should really be *pa'ulu tingke'*, 'the head of the spinning-wheel'.
 - 9 Other information indicates that the *ma'tenten* is danced at the *bua' kasalle*-feast.
 - 10 In other areas, for example in Sangalla', this was not customary.
 - 11 *Sumbung penaa* is sometimes translated as 'that which follows the breath'.
 - 12 Indonesian for a thick variety of bamboo: *Dendrocalamus flagellifer*.
 - 13 For the association of the parts of the *kerbau* with the possessions of the ramage, see section VII.1.4.
 - 14 H. van der Veen could not find a translation for this word; it is not clear what part of the buffalo is meant.
 - 15 *Sarita*, sacred cloth from India.
 - 16 A big, glazed pot of Indian origin; these jars were exported from Martaban (Burma).
 - 17 *Na* = possessive pronoun, 3rd person (sing.).
 - 18 Sometimes a person is contracted to tend a pig; eventual profit is divided evenly between owner and caretaker.
 - 19 The crow, however, is not associated with the upperworld.
 - 20 The government banned this practice some time around 1975.
 - 21 See *Traditions* reported by Ne' Mani' (Van der Veen 1976).
 - 22 The cat *serre'* that is treated as a *datu* (lord); who, just as the Buginese prince of Luwu', never leaves his house (*Woordenboek*).
 - 23 *Woordenboek*: *serre' datu* are black, grey or speckled and can have a stumpy tail. Usually they have such a tail, despite Wilcox's observation.
 - 24 The tail of these rodents is compared to (the stem of) a betel leaf.
 - 25 *Pa'pong*: a kind of ficus. Another tree, the *kapok*-tree, is also cited; cf. Kruyt 1923/24 : 138.
 - 26 Another symbol of the growth of the ramage is the *tallang*-bamboo. It develops many shoots which all grow closely together in a dense cluster. Cf. Merok: 164-165.
 - 27 For this shrine see VIII.7.
 - 28 The *bate manurun* discussed here should not be confused with the *bate manurun* which is one of the *pusaka* of the *puang* of Sangalla'.
 - 29 Another name for this *ubi* (yam) is *dua'*.

CHAPTER VIII

- 1 *Pa'bombo uai*, a motif in woodcarving. *Bombo uai*: an insect that moves swiftly over the surface of the water.
- 2 According to Allo Rante, *mangrapu* also took place before construction of the house began, thus already prior to *mangono'*. The *to minaa* brings an offering to the ancestors who have lived in the *tongkonan* (the offering can also be brought to one of the *to matua*, i.e. the elders of the village). The offering takes place outside the actual village, in the fields where a pig is sacrificed.
- 3 This despite the fact that the occupant (Allo Rante, alias Ne' Sangga), was converted to Christianity. One should, however, keep in mind that a *tongkonan* is the center of a vast family group not all of whose members are Christians. The new *sokkong bayu*, Allo Rante's successor, led the celebration.
- 4 Deviations from *adat*-prescription do occur; we cannot here pursue these departures in detail, even though they are often instructive.

- 5 For the Javanese kris, see W. H. Rassers 'On the Javanese Kris' in *Panji, The Culture Hero* (1959) : 217-297.
- 6 For illustrations of a *sarigan*, see Harahap 1952 : 8, and Holt 1939: fig. 54.
- 7 This does not agree with the earlier-mentioned report that the fashioning of *tau-tau* came into vogue for the first time some 7 to 10 generations ago (above, VIII.4).
- 8 For the *manimbong*-dance, see Claire Holt 1939 : 74-76; for the *gellu'*-dance, *ibid.* : 70-73. During the *ma'dandan* women in festive clothing draw up in a row and sing certain songs.
- 9 Here I use Van Baal's distinction between offering and sacrifice: 'In this paper I call an offering any act of presenting something to a supernatural being, a sacrifice an offering accompanied by the ritual killing of the object of the offering' (Van Baal 1976 : 11).

CHAPTER IX

- 1 Several specimens of litanies, eulogies and other recitations were recorded in 1966 and 1969; *Pa'singgi'* (performed by Ne' Sesa, district of Kesu) and several parts of the *Passomba Tedong* as recited during the *merok*- and *buu' kasalle*-feasts (sung by Enoch Palolean Amba Titedok, former *to minaa* from the district of Nonongan). These tapes are now kept in the Ethno-musicological Center Jaap Kunst, Amsterdam.
- 2 According to C. Salombe (lecturer at the Faculty of Letters at the Hasanuddin University in Ujung Pandang) there are five categories of *to minaa*. The highest category has the right to a special form of burial resembling that of *to burake tambolang*; the corpse of such a *to minaa* is carried out of the house via a breach made in the inclining portion of the northern gable of the *tongkonan*.
- 3 Van der Veen, in his account of the *merok*-feast, cites two ancestors of the *to indo' padang*: Datu Mangkamma' and Karaeng Ma'lokoloko, created by Puang Matua (Merok: 97).
- 4 No mention is made of this in the *Passomba Tedong*.
- 5 This implies that the *burake tambolang* sometimes is a homosexual.
- 6 Despite efforts begun in 1969 to trace a *tambolang*-bird, I have been unable to detect one. I have been asserted, however, that it must be the white-necked stork.
- 7 So named in Ma'kale and Sangalla'. Elsewhere also called *garatung* and *gamaru* (Buntao', Rantebua, Ranteballa, Pantilang).
- 8 In Indonesia it was used by Chinese pedlars, thus as a purely profane instrument. On Bali, however, the *katipluk* is the instrument of the chthonic priest, the *sengguhu*. In Tibet the instrument constitutes part of the outfit of the lamaistic-Buddhist priests and is associated with tantrism. The term musical instrument is, in the opinion of the musicologist E. Heins, not particularly apt: a signalling instrument would be a more appropriate term, one, for example, to catch the attention of spirits. The drumhead of the *garapung* is made of python skin.
- 9 Actually A. C. Kruyt meant the *la'pa' kasalle*-feast identical in theory to the *buu' padang*-feast but in practice more expensive and extensive. The *buu' padang* refers simply to the rice ritual.
- 10 *Tangdo'*: a platform constructed on the occasion of the *buu' kasalle*-feast in front of the celebrating *tongkonan*. Both priests wear parakeet feathers (*bulu baan*) on their heads, a symbol of the upperworld.
- 11 Love scenes provoking laughter, apparently deriving from a fertility ritual,

are also performed on Bali, during Galungan. Two mammoth figures in masks, Jero Luh and Jero Gede', play the lovers. What is so surprising is that the mask of Jero Luh, the female figure, is white and that of Jero Gede', the male, is black; one would anticipate just the opposite (black: underworld and female; white: upperworld, male).

- 12 Cf. the position of the *bissu* in Buginese princedoms as the guardians of regalia.
- 13 Toichi Mabuchi, *Spiritual predominance of the Sister* (1964).
- 14 *Melangi'* might mean: to seek a connection with the upperworld. In the *puang*-realm of Sangalla' *malangi'* (= *tumbang*) means: to execute a dance during the *maro*-feast to the singing of a litany (*tumbang* = to spring up during the jig performed at the *maro*-feast).
In the *Gelong Maro* as sung by the *to minaa* Ne' Nora from Bungin (transcribed by J. Tammu in 1975) the words *to tumbang*, *to malangi'* and *to sala padang* occur; Van der Veen has translated these to mean 'They who fall in a trance, They who dance to the singing of a litany, They who may not tread the ground' (see verses 18 and 19 of *Gelong Maro*):
'At the sight of the progeny of those who are in a trance,
of the descendants of those who dance to the singing of a litany,
the offspring of those who may not tread the ground,
the performances of those who are possessed by a spirit.'
(Van der Veen 1979: 47)
- 15 *Londungna*, *umbena'*, *mali'na*: correct translation uncertain.
- 16 The *passakke* is a plant with red berries and small pits shaped like hailstones; *masakke* means cool, salutary. The name of the plant thus hints at a godsend. *Darinding* is a creeper with a thin significance of gentle coolness. *Madarinding* means: cool, healthy, blessed. The name of this plant, too, implies beneficence (information from H. van der Veen). For *tananti*, see *Woordenboek*.
- 17 According to Toraja belief illness is often the result of a violation of incest taboos. For the meaning of the splitting of areca nuts see page 160.
- 18 This regardless of the fact that the rice rituals and those designed to heal the sick both belong to the same sphere, that of the East-oriented *deata*-rituals. Only one single group of Ne' Banne's aiding spirits, the ancestors, fall under the sphere of the West.
- 19 *Linggis*: iron rods, used in agriculture.

A GLOSSARY AND INDEX OF THE MOST FREQUENTLY USED TORAJA AND INDONESIAN TERMS AND NAMES

- aak*, a slab of meat which clings to the spine joint above the hip joints, 204.
- ada'* (see also *adat*, Indonesian), the complex of habits and customs, 85, 90, 133.
- adat* (Indon.), the complex of habits and customs, 52, 59, 68, 74, 75, 78, 81, 83, 90, 91, 92, 93, 117, 138, 220, 231, 279, note 9 chapter II.
- adat*-(chief), the head of an *adat*-community, 13, 61, 62, 70, 209, 274, 277, note 8 chapter IV.
- adat*-(community), 6, 16, 58, 59, 60, 62, 67, 72, 74, 75, 77, 91, 104, 105, 112, 293.
- adat*-(decrees), 133, 143, 146.
- adat*-(institutions), 114.
- adat*-(law), 114, 115, 136.
- adat*-(precepts), 157, 252, 275.
- adat*-(regulations), *adat*-(rules), 26, 145, 275.
- adat*-(sanctions), 38.
- Ada' Bitti', 'The Small *Adat*', and *adat*-community in Sangalla', 81, 87, 88.
- Ada' Tangnga Sali, 'The *Adat* of the Middle Room', titleholders who belong to the *to makaka* in Sangalla', 90, 91.
- adi*, *adi'*, *adina'* (see also Basse Adina), younger sibling, younger cousin, 42, 79.
- akan*, a palm tree (*Borassus flagellifer?*), 162.
- akka'*, 'to take up and to shift', the name of a *saroan* in Simbuang, note 17 chapter IV.
- ala-ala*, cock-pit, 212.
- alang*, ricebarn, 104, 252-254.
- alla' tarin*, 'up to the elbow or just below', a measure for buffalo-horns, 188.
- allo*, day, sun, 80, 88, 90, 112, 118, 126.
- allona*, the high-day of a ritual, 249.
- allonan biang*, 'the head cushion of the reed', a term used in divination, 275.
- Allo Tiranda, the ancestor of the poisonous *upas*-tree, 136, 228.
- alo*, hornbill, 214.
- aluk* (see also *sukaran aluk*), ritual, also used in the sense of *adat*-precepts or *adat*-regulations, 26, 67, 90, 112, 114, 133, 138, 146, 147, 157, 275, 285, note 1 chapter VI.
- aluk matampu'*, see *aluk rampe matampu'*.
- aluk padang*, the ritual (or the *adat* and ceremonies) connected with arable land (ricefields), 279.
- aluk pia*, 'the child ritual', the first part of an important death ritual, 263.
- aluk rampe matallo*, 'the Ritual of the East', the rituals for the living, 112, 114, 278, 289.
- aluk rampe matampu'*, 'the Ritual of the West', comprising the rituals connected with death, 51, 112, 275, 278.
- aluk sumpa langi'*, 'the completion of all feasts', the final stage of an important ritual of the eastern sphere, 143.
- aluk susu*, an *adat*-regulation (in the mortuary rites) that is customary in the family of the mother, 26.
- Alukta*, see *Aluk To Dolo*.
- Aluk To Dolo*, 'The Belief of the Forefathers', 10, 104, 107, 108.
- aluk to mate*, 'the Ritual for the Dead', 112.
- ambe'*, father, 30, 41, 50, note 2 chapter II.
- ambe' saroan*, head of a *saroan*, 103.
- ambe' tondok*, 'the father of the village' (= *ambe' saroan*), 103, 104.
- ambe' ure* (see also *pa'amberan*) MoBr, FaBr, 29, 41.
- Ambun diKesu', see Lai Ambun diKesu'.
- ampang*, threshold, 92, 213.
- ampang bilik* (see also *ruma-ruma*), 'the threshold of the house', a construction of decorated planks in a *tongkonan* of importance, 238, 241-244.
- ampo*, grandchild, 29, 42.
- ampo guntu'*, greatgrandchildren, 29, 42.
- ampo salemberan*, greatgreatgrandchildren, 22, 42.
- ampo todoan*, greatgreatgreatgrandchild-

- dren, 42.
ampu padang, earth spirit, earth spirits, 126, 234, 265.
anak, child, note 9 chapter III.
anak ba'gi, persons who have a share in a legacy, 37, 38.
anak baine, daughter, 29, 41.
anak dara, 1) Si, FaBrDa, FaSiDa, MoBrDa, MoSiDa (man speaking), 28, 42; 2) girls or women who play an important part in the great *bua'*-ritual, 258; 3) a sacral object in the *bua' kasalle*-ritual, 241, 244, 286; 4) virgin, 28.
anak disarak, foster child, foster children, 39.
anak disese, child or children of marriages between members of the *puang*-class and the *to makaka*, 32, 55, 56.
anak muane, 'male child', son, brother, cousin, 28, 29, 41.
anak pangngan, 'betel child', a child who inherits only a share of his father's estate because he (she) is illegitimate, 37, 39.
anak pare pare nangka' (*anak passasaran tuyu*), nobility, 49, 50, 52, 54.
anak patalo, nobility, people of rank, 44, 49, 50, 54-56, 94, note 9 chapter III.
anak sangtepo, 'quarter child', a child who inherits one fourth (*sangtepo*) of his father's estate, 37.
Anak Tallu, 'The Three Children', a council in Balusu, 65.
anak to makaka (see also *to makaka*), note 20 chapter IV.
anak ure (see also *pa'anakan*), nephew, niece, 29, 42.
angin-angin, a kind of bird, 213.
Annan Pulona Tongkonan, 'Sixty Tongkonan' (= Pantilang), 69.
ao' (Indon. *aur*), *Dendrocalamus strictus*, a bamboo variety, 272.
api', brother or sister (in chants for the dead), 28.
a'riri, post, pile, 250.
A'riri Bassi, 'The Iron Pillar', the title of an *adat*-chief in Pantilang, 69; *ibid.* in Sangalla', 88.
a'riri posi', 'navel post', an important post or pillar of a *tongkonan*, 87, 232, 233, 240-241, 244, 246, 248, 250, 265.
Arrang diBatu, 'The Radiance in the Stone', a female deity, 118, 120, 132, 136, 139.
Arung Palaka, a Bonese prince, 8, 19, 60, 62, 250.
ate, *atena*, the liver, 202, 206.
baa, *baana* (*bayana*), the spleen, 201, 206.
ba'ba, 1) door, 30; 2) bride price, 30.
ba'ba deata, 'the door of the gods', the front gable, 245.
Ba'ba Lumuran, 'The Door Covered With Moss', a title in Sangalla', 83.
ba'ba sade, a door in the western wall, 245.
babo bo'bo', an offering of grains of cooked rice, 271, 273.
babu', a garment, a back covering plaited from rushes, 162.
babu' solong, a back covering made from an areca-leaf sheath, 162.
Babu' Solong, a figure in a myth, 162.
badong, a chant for the deceased which is sung by a group of people attending the mortuary feast who as they sing perform a round dance, 16, 124, 282.
ba'gi, a share in a legacy, 38, 39, 40.
bai, pig, swine, 207.
bai ballang, pied pig, 207, 208.
baine, woman; wife, 42, 80.
baisen, parents of child's spouse, 30, 42.
baka bua, a large basket for storing clothing and valuables, 216.
bala'kaan, the scaffolding upon which the meat of a sacrifice is distributed during a ritual for the dead, 76, 197, 198, 272.
balang(na), the lungs, 206.
baleatang, a kind of fine, 53.
bale'kena, the kidney, 206.
Balepe', a *lembang* (district), 20, 65, 289, note 10 chapter III.
bali (see also *pabalian* and *sibali*), helper, one of a pair, counterpart, 122.
balian, *baliang*, ox, 186.
Baliara, a title in Balusu, 65.
Bali karae, the cat of the underworld, 121, 122.
balida, the beam of a weaving loom, 166.
Balimbing Kalua', 'The Great Root', a title in Buntao', 69.
Balla, a *lembang* (district), 20, 67, note 10 chapter III.
ballang, *bai ballang*, a black pig with a white belly, 81.
Ballo Matari, 'He who has a Comely Form', name of a buffalo, 192.

- Balusa, a *lembang*, 20, 33, 67, 279.
bambalu, a kind of liana, 228.
 Bamba Puang, a mountain from which souls ascend to heaven, 123, 130.
bambu betung (Indon.), a variety of bamboo, 198, 249.
bangsa, 1) *Metroxylon Elatum Mart.*, a palm tree, 252; 2) a pile of a ricebarn, 252, 254.
 Bangsa, a *lembang* (district), 20, 63, 64, 67, 289.
 Banggairante, Banggai diRante, Pong Banggairante, 'The Vast Plain', 'the Plain which extends itself', the name of the god of the earth, 117, 121, 132, 134, 135, 138, 142, 143, 252, notes 3 and 5 chapter VI.
banjir (Indon.), flood, 116.
 Banno Bulaan, 'The Golden Rice-water', a child of Puang Matua, 120, 165.
bannu', strips of bamboo, 92.
bantuli, a vertical house pile located outside the actual living-area of the house, 233, 234.
banua, house, 232.
banua di pasituang, 'a house which is passed by', a house which is considered of lesser importance, 246.
banua di sangalloi, 'a house of one day', ritual connected with the building of a house of lesser importance, 246.
banua di tallung alloi, 'a house of three days', ritual connected with the building of a house of this type lasting three days, 246.
 Banua diToke, 'The Hanging House' (in myths), 90, 141, 142, 146, 147.
banua kaunan, a house of slaves, 246.
banua rapa', a beautiful house, 245.
banua tamben, an old type of house, 245.
barana', *Ficus religiosa*/*Ficus benjamini*, 24, 219, 221, 269, 287.
 Barana', a village in Tikala, 158.
 Bare'e-Toraja, 151.
barra', uncooked rice, 166.
 Barra' Massakaranna, 'People who prepare the food' (food = rice), the title of an *adat*-community in Kesu', 77.
barre allo, sun disk with rays, a motif in wood-carving, 211, 239, 260.
barumbun, a brown chicken with grey spots, 210.
 Baruppu', a region in Tana Toraja the inhabitants of which call themselves *To Baruppu*', 'The People of Baruppu', 33, 34, 66, 124, 189, 190.
basong manuk, a decorated piece of wood used in a cock-fight, 213.
basse, agreement; to be under oath, 70.
 Basse Adina, 'The Bond with the Younger Sibling' (Mengkendek in the Tallulembangna), 79.
 Basse Kakanna, 'The Agreement with the Older Brother' (= Ma'kale in the Tallulembangna), the principedom considered the most ancient of the *puang*-domains, 79.
 Basse Lepongan Bulan, 'The Agreement (concerning the region) Round as the Moon', the name for Tana Toraja (or a part of it) in mythical times, 8, 19, 60, 62.
 Basse Maruang, 'The Agreement with the Slaves' (in the Tallulembangna), 86.
 Basse Tangngana, 'The Agreement with the middle Child' (Sangalla' in the Tallulembangna), 80.
 Basse Tau Karua, 'The League of the People of Eight', the title of a community in Mengkendek, 92.
ba'tan, millet, 224.
 Ba'tan, a village in Kesu', 100-103, 215, 247, 249, 250, 259, note 6 chapter IV.
 Batari Uai, the Water Goddess, 26.
bate, 1) a flag, a banner, 221, 222; 2) a sacral cloth (in Sangalla'), 151; 3) a bamboo-*tallang*, decorated with a banner, used in the *maro*-feast, 221, 222, 229.
bate lepong, a temporary *tau-tau*, made of bamboo, 263.
bate manurun, the banner which is descended from heaven, 221, 222, note 28 chapter VII.
 Bate Manurun, a sacral cloth from Sangalla', which is descended from heaven, 151, 258.
bate-(song), a song sung at a *maro*-feast, 222, 229.
batitong, a werewolf, 127-128, 291.
batu, stone, 147.
 Batu Eran, 'Stairs of Stone', a staircase in the myths, 225.
batu parandangan (*batu pare*), stone corbels on which the piles of a house or a ricebarn rest, note 3 chapter IV.

- batu polo barra'*, a stone resembling a grain of rice still half in its husk, 269.
- batu polo para'*, a stone representing half the male or female genitals, 269.
- Bau, a *lembang* (district), 20.
- bayu lamba'*, a long jacket, 276.
- belundak*, a package of glutinous rice, 272.
- biang*, a kind of reed, 40, 269, 270.
- bibang*, sherd from a cooking-pot, 186.
- bilante*, *Homolanthus populneus*, 228.
- bindu matogu* (*Batak*), a motif in Batak art and religion, 239.
- bingka'*, a small winnowing fan, 153, 252.
- bingsu* (= *to burake*), a priest of the eastern sphere, 292.
- bissu*, a priest of the Buginese, 285, 292, note 12 chapter IX.
- Bittuang, a *lembang* (district), 20, 30, 33, 67, 254.
- Bombing, a resistance leader in Tana Toraja, 9.
- bombo*, the unclean soul, the soul of the deceased before purification, 113, 114, 121-124, 128, 129, 206, 245, 279, note 12 chapter V.
- bombo kosik*, an aquatic insect with a bad odour, 148.
- Bombo Kosik, the name of a slave in myth, 148.
- bombo mendeata*, a soul that after death becomes a divinity, a deified soul, 128.
- bombo uai*, note 1 chapter VIII.
- bonga*, a pied animal (buffalo or pig), 81, 185, 194, 196.
- bonga rori'*, a black buffalo with a partly white head, 185.
- bonga tengge'*, a black buffalo with a white head and a neck which is half white, 185.
- bonga ulu*, a black buffalo with a white head, 185, 190, 195.
- bongsu*, the youngest child, 41.
- bori'*, boundary; see *Bori'* and *Borisan Rinding*.
- Bori'*, a region in Tikala, 67.
- Borisan Rinding*, 'The Boundaries of the Wall', a social class in Sangalla', 89.
- bua*, *buana*, fruit, heart, 206.
- bua'*, *bua' area*, *bua'-circle*, an area in which a *bua'-feast* is held (see also *bua'* or *penanian* and *bua'-communities*), 50, 54, 60-63, 64, 65, 67, 91, 92, 104, notes 6 and 14 chapter IV.
- buangin*, *Casuarina equisetifolia*, 229.
- bua'-communities*, communities which encompass a *bua'-area* or a *bua'-circle*, 50, 60, 62, 66, 68, 77, 91, 92, 97, note 6 chapter IV.
- bua'-feast* (see also *bua' kasalle* and *bua' padang*), a feast of the East for the welfare of the crop and/or the community, 67, 92, 100, 124, 137, 140, 143-144, 157, 196, 200, 208, 218, 219, 221, 258, 269, 272, 282, 285, 286, 287, note 2 chapter II, note 2 chapter III.
- bua' kasalle* (see also *bua'-feast*), a ritual of the East, a ritual of the highest order, 22, 47, 57, 61, 62, 100, 123, 137, 160, 193, 210, 228, 241, 244, 259, 274, 276, 285, 286, notes 7 and 9 chapter VII, notes 1, 9 and 10 chapter IX.
- Buakayu, a *lembang* (district), 20, 64.
- bua' padang*, a ritual for the welfare of the crop (or of the fields), 60-62, 69, 79, 100, 103, 196, 279, note 9 chapter IX.
- bua tina*, a motif in woodcarving, 261.
- Bugi', Buginese people.
- bugi'*, *bugi'-feast*, an exorcistic ritual, 127.
- buku*, bone; see *buku lesu*.
- buku lesu*, the hip joint of a hind leg of a buffalo, 203, 204, 206, 209, 251.
- buku sanduk*, the shoulder-blade, 204, 206, 208.
- bulaan*, gold, 175, note 7 chapter III, note 10 chapter V, note 48 chapter VI.
- bulaan masak*, 'the patch of pure gold', a (mythical) region in Tana Toraja, 114.
- bulan*, moon, 291.
- bulan sampe*, waxing moon, 291.
- bulan sombo*, waning moon, 291
- bulian*, blowpipe, blowgun; see *Bulian Massa'bu*.
- Bulian Massa'bu*, 'The Thousand Blowpipes', a title in Sangalla', 83, 84.
- bulu baan*, parakeet feathers, note 10 chapter IX.
- Bulu' Pala*, 'Hairy Handpalm', a figure in the myth of that name, 166, 168-171, 215.
- Bunga aru* (*Bunga waru*), the sword of the prince of Luwu', 149.
- bunga' lalan*, the most important of the rice priests, 205, 274, 279.
- Bunga' lalan*, the Pleiades, 123.

- bungkang-bungkang*, 'that which resembles a crab', a wooden figure which is carried along in a death ritual of high order, note 21 chapter VI.
- bungkang tasik*, 'sea crab', a guise of the deity To Sopai, 116.
- Buntao', a *lembang* (district) 20; a *patang penanian*, 25, 54, 67, 68-72, 254, 289, note 2 chapter IV, note 7 chapter IX.
- burake*, see to *burake*.
- burake bombo*, the priest who dresses the corpse, the death priest, 122, 274, 281, 293.
- burake manakka*, a priest in Simbuang, 275.
- Burake Manakka, the mythical cat at a *buah*-feast, 218.
- burake tambolang*, see to *burake tambolang*.
- burake tattiku*', see to *burake tattiku*'.
- huri*', a speckled cock, 210.
- Buriko, 'He who is Grey of Hue with Black Stripes', the mythical ancestor of the dog, 214.
- busirrin*, 'which smells of ants', a sacral cloth, 258.
- cendana*, *Santana album*, sandalwood, see *sendana*.
- cinde*, *cindai*, old sacral cloth of Indian origin, 201, 257.
- daa*, north, 131.
- daa ulunna langi*', 'the head of the heavens', zenith, 112.
- danga-danga*, a variety of gladiola, used in religious activities, 150, 229.
- darinding*, a plant used in religious activities, 229, 290, note 16 chapter IX.
- dapo*', hearth, family, marriage, 23, 30, note 8 chapter II.
- dassi*'-*dassi*', a bird, 214.
- datu*, lord, prince, master, 43, 149, 151, 172, note 22 chapter VII.
- Datu, 1) Lord, Prince, 69, 91, 110; 2) a figure in myth, 171-173.
- datu baine*, a title in Kesu', 54, 97-100, 104, 203, 249, 250, 254.
- Datu Baine, Goddess, Princess; the title of the ancestress Manaek in Nonongan, 76, 78, 154.
- Datu Bakka', the name of the first slave in myth, 43, 44.
- Datu Etan, 'The Black Lord', a deity, 140, 141.
- Datu Laukku', the first human being, 136, 137, 140, 141, 143, 145, 227, 228, 280, note 15 chapter V.
- Datu Laungku', the ancestor of the cotton, 136, 228.
- Datu of Luwu', 69, 91, 149, 151, 172.
- Datu Manappa', 'The Reliable Lord', a child of Datu Laukku', 140.
- Datu Mangkamma (Datu Mengkamma), the first *to indo*' *padang*, 141.
- Datu Maruru', the Lord of the Smallpox, 126, 127, 289-292.
- Datu Masarrang, 'The Fierce Datu', 'The Righteous Lord', 140.
- Datu Matallo, the prince of the East, 91.
- Datu Matampu', the prince of the West, 91.
- datu muane*, a title in Kesu', 97-100, 104.
- Datu Muane, 'Male Lord', the sea god, 116.
- daun bolu*, 'betel leaves', a motif in art, 257.
- daun buangin*, *Casuarina* leaf, 292.
- deata*, 1) god, goddess, spirit, 70, 110, 113, 114, 115, 119, 121, 124, 129, 130, 146, 162, 163, 170, 173, 206, 210, 214, 229, 245, 252, 259, 272, 275, 280, 284, 285, 290, 291, 292, note 4 chapter IV, note 4 chapter V; 2) soul, 128, 129.
- Deatanna, a woman of heavenly origin in myth, 154-156, 218, 229, note 37 chapter VI.
- dena*', ricebird, 223, 252.
- Dende', a *lembang*, a region in Tana Toraja, 20, 67, 78, 289.
- diali*, to put to death, to exile, 38.
- diampang*, thwarting, 213.
- diong* (*diongan*, *diongnalu*), 97, 98, 99, 100-102, 249, 251, note 24 chapter IV.
- dipalimang bongi*, a death ritual which lasts five nights, 197.
- dipapitung bongi*, see *pitung bongi*.
- dipasibali*, reciprocal relations between *tongkonan*, 204, 205.
- dirak*, a *casuarina*-branch, 270.
- dirapa*'i, a death ritual of the highest order, 116, 117, 123, 124, 197, 230, 258, 259, 260, 265, 267.
- direngnge*', to be carried in the manner in which a woman carries a load, note 11 chapter III.
- disanga anak*, a person adopted as an

- adult, 39.
- do*, *doan*, above, up there, 97, 98, 99, 100-102, note 24 chapter IV.
- dodo kuni'*, a yellow sarong, 287.
- doi'i manuk*, 'money with a bird', a coin with the image of a cock, 151.
- donalu* (see also *doan*), up, 249, 250.
- dora*, a yam variety, 224.
- Doso, a sword (heirloom) owned by the *puang* of Ma'kale, 149.
- do tangnganna langi'*, zenith, 139.
- doti*, 1) dots, note 9 chapter V; 2) a special kind of buffalo (white with black dots), 185.
- doti langi'*, 'spots of heaven', cross motifs, 119, 185, 243, 257.
- dua'*, yam, note 8 chapter VI, note 29 chapter VII.
- Duabontik, a weapon which belonged to the female ancestor Lai' Bue, 257.
- duang lampa taruno*, 'two finger tops long', a measure for the horns of a buffalo, 188.
- duba-duba*, the *maa'*-cloth which is used in a death ritual of high order, 258.
- dulang*, a dish on a high pedestal, 53, 208, 209, 249, 250.
- duni*, coffin, 168.
- Duri, 1) a region south of Tana Toraja, 112, 159, 170, 223, 254; 2) an ethnic group living to the south of the Sa'dan-Toraja, 6, 7, 8.
- durian*, a fruit, *Durio Zibethinus Murr*, 88.
- E'gon, the first swine in myth (Sangalla'), 207.
- engkok* (see also *ingkok*, *ikko'*, *ikko'na*), tail, rear part of the carcass, 201, 206, 208.
- Eran diLangi', 'Heavenly steps' (in myth), 145, 163, 269, 270.
- gallang*, brass, 195.
- gamaru*, see *garapung*, *garatung*.
- gandang*, drum, 259.
- Gandang Boro, 'The Good Drum, the Peaceful Drum', a title in Sangalla', 87-89.
- garopang*, pile of a house, 233.
- garapung*, *garatung*, a clapper drum, 283, 286, 287, note 13 chapter III, notes 7, 8 and 13 chapter IX.
- garonto'* (see also *kaunan garonto'*), stock, land, beginning, origin, note 7 chapter III.
- garuda* (Indon.), eagle (in myth), 149-152, note 23 chapter VI.
- gayang*, kris, 256.
- Gauntikembong, 'Self Expanding Cloud', the god of the upperworld, 118, 121, 132, 135, 136, 138.
- gellu'*, a dance which is performed during the *maro*-ritual, 249, 255, 256, 269, note 8 chapter VIII.
- gelong maro*, songs sung at the *maro*-ritual, 255.
- geso-geso*, a kind of violin, note 13 chapter III.
- gora(-gora) tongkon*, 'the sitting crier', a class in Kesu' and Nonongan, 52, 72, 103, 104.
- gorang*, a wooden platform on piles; the structure is used for ceremonial purposes during the *bua' kasalle*-feast, 210, 287.
- Guali Bassi, 'The Iron Doorframe', a title in Sangalla', 83.
- gusian*, a space in the *sawah* partitioned off with walls, 153.
- haram* (Arab., Indon.), taboo, 185.
- Hadat Luwu', the Court (or State, Council, Indon.) of Luwu', 85.
- hikayat* (Indon.), narration, story, tale, 151.
- ijuk* (Indon.) black fiber growing between the leaf-sheaths and the stem of the sugarpalm, 254.
- ikko'*, *ikko'na*, *ingkok* (see also *engkok*), tail or back part of a buffalo or a pig, 201, 206, 208.
- inaa*, mind, meaning, thought, 128.
- inanna*, 'past the elbow', a measure of buffalo horns, 188.
- indo'*, 1) a kinship term (Mo, MoSi, FaSi), used as a term of address or a term of reference, 29, 30, 41, 50; 2) a person bearing authority, 50, 63, note 2 chapter II.
- Indo' Belo Tumbang, 'Mother Ornament in a State of Trance', the first female physician in the upperworld, 120, 145, 225, 289.
- indo' bua'*, the chief of a *bua'*-circle, 63.
- Indo' Bunga Sampa', 'Benevolent Mother Blossom', see Indo' Belo Tumbang.
- indo' datunna*, 'the royal mother' (of the reed on earth), 270.

- indo' lembang*, 'the mother of a *lembang*' (the chief of a *lembang*-community), 63.
- Indo' Ongon-ongon, the wife of Pong Tulakpadang, 112, 120, 121, 144.
- Indo' Orron, a dangerous spirit, 126.
- indo' padang*, to *indo'* (*padang*), the rice priest, 50, 52, 71, 72, 102, 141, 167, 204, 205, 208-209, 210, 246, 248, 251, 252, 269, 274, 278, 279-280, 289, 291, note 3 chapter IX.
- indo' palapa'* (*palapa'*?), the title of the head of a *tongkonan* in Pantilang, 69.
- Indo' Pare'-pare', 'Mother of the Small Rice', a goddess, 120, 132, 135, 136, 140.
- Indo' Rua Tumbang, 'The Mother of the Eight Tumbang', a child of Datu Lauku', 140.
- Indo' Samadenna (Indo' Sadenna = Tulangdidi'), 'Mother all there is', a goddess, 132.
- indo' saroan*, head of a *saroan*, note 17 chapter IV.
- indo' ure*, a kinship term, MoSi, FaSi, 29.
- induk*, *induk*-tree, sugarpalm, 179, 180, 181, 182, 226, note 51 chapter VI.
- ingkok*, see *engkok*.
- Ingkok Bulaanna Kalindo Bulanan, 'The Golden Tail of the Kalindo Bulanan', a title in Sangalla', 88.
- ipa'*, a kinship term, BrWi, SiHu, HuBr, HuSi, WiBr, WiSi, 42.
- ipo'*-(tree) see *upas*-tree, the *ipo'*-tree (*upas*-tree in Indon.?) of which poison for arrows is made, 144, 227-228.
- issong*, rice mortar, see *Issong Kalua'*.
- Issong Kalua', 'The Great Rice Mortar', a title in Buntao', 70, 71; *ibid.* in Kesu', 76.
- issong kalua'*, a title in Pantilang and some other regions, 54, 78.
- kabongo'*, a wooden buffalo-head hung on the *tulak somba* or on the front wall of a house or a ricebarn, 194, 240, 254.
- kabupaten* (Indon.), regency, 3, 7, 13, 58, 68.
- kabusungan*, 1) sacral, consecrated, extremely holy, 154; 2) sacral goods which belong to the ramage, 237.
- kada*, word, words, story, see *Sembang Kada*.
- kaise'*, a shrub with red fruits, 163, 229, note 29 and 37 chapter VI.
- kaka* (term of reference), older brother, older sister, older cousin, 29, 42.
- kaka'* (term of address), older brother, older sister, older cousin, 42.
- Kalebu', 'Small Hill', the mythical island of origin of the Toraja, 113.
- kalimbuang boba*, 'the source of blessing water' (= the source of the Sa'dan River), 114.
- kaloko'*, a kind of bird which is of significance in headhunting, 214.
- kalosi*, Areca-palm, 174.
- kalumba*, a hut, one of the first types of dwelling, 245.
- kalumpani'na*, a small layer of meat in front of the hind legs, 206.
- kalungkung*, hoof, hooves, 201.
- kambi'*, keeper (of a ritual), 141, 142.
- Kambi'na Pantanakan Lolo, 'The Keeping of the Nursery for the young Rice Plants', the title of *tongkonan* Sallebayu in Kesu', 75.
- kamboti*, small bag plaited from palm-leaves, 207.
- kambuno*, fan-palm, *Livistona rotundifolia*, 230.
- Kambunolangi', 'The Shunshade of Heaven', the name of the first to *minaa*, 137, 230, 277.
- Kambuno Talluna Kesu', 'The Three Parasols of Kesu', a region in Kesu', 74.
- kamiri* (see *To 'Kamiri*), *Aleurites triloba*, 153.
- kampa tatau*, 'the guardian of the *tautau*', the name of a buffalo in a death ritual of high rank, 197, 198.
- kandaure*, an ornament fashioned of beads, used in the *gellu'*-dance and in ceremonies, 11, 131, 151, 250, 255-256, 261.
- kandean*, *kandian*, bowl, dish; see *to makaka kandian*.
- kandean lau*, a bowl fashioned from a calabash, 290, 292.
- kandean saratu'*, 'a hundred dishes' or 'a hundred eating-bowls', 154.
- kapa'*, the penalty to be paid by the marriage partner who is responsible for dissolving the marriage bond, 30, 34-37, 53, 143, 156, note 8 chapter II, note 49 chapter VI.
- karambau*, a solemn term for buffalo in rituals, 184.

- karerang*, a small basket made out of loosely plaited sugarpalm leaves, suspended from a bamboo pole, 272.
- karopi*, a subdivision of a *tepona padang*, 65.
- Karua penanian, 'the eight *penanian*', a community in Sangalla', 62.
- karu'dusan*, *pa'karu'dusan*, a buffalo which is killed during the first part of a death ritual of higher order, 188, 197, 198, 202, 278, note 7 chapter VII.
- karurung*, a black chicken with white spots, 209.
- kasalle*, big, large, see *bua' kasalle*.
- kasisuran*, family, 23.
- katik*, a woodcarving representing a bird, 209, 233, 240, 261.
- katipluk*, a clapper drum, used by the *sengguhu* on Bali, note 8 chapter IX.
- kaunan (to kaunan)*, a slave, a serf, the unfree, people who do compulsory labour, the lowest rank, 26, 32, 44, 45, 46, 47, 48, 49, 50, 51, 52, 54, 55, 56, 85, 86, 91, 122, 150, 172, 186, 199, 204, 214, 260, 281, notes 4, 5, 6 and 8 chapter III, note 17 chapter IV.
- kaunan bulaan*, 'the golden slaves', slaves who belong to the *tongkonan*; see *kaunan garonto*'.
- kaunan garonto*', slaves who belong to the *tongkonan* and can never be sold, 45, 46, 55, 87.
- kaunan indan*, slaves who are unable to pay off their debts, 45.
- kaunan mengkaranduk*, persons who, either from fear or because they had been plunged into destitution by adversity, sought protection from a rich and/or powerful master, 45.
- kaunan sandang*, see *kaunan indan*.
- kaunan tai manuk*, 'chickenshit slaves', the slaves of slaves, 52, 55.
- kayo*, a grey heron (see also *ma'kayo*), 213, 214, 281.
- Kayok, the name of an ancient sword in Buntao', 257.
- kayu*, wood, 247.
- keatang deata*, 'with child by the *deata*', said of a woman who is thought to be pregnant of a snake, 219.
- Kebali'bi, underworld, 130.
- kecamatan*, district of a *kabupaten*, 3, 5, 43, 62, 71, 74.
- kepala* (Indon.), chief, 66.
- kepala pitu*, 'the seven heads', a community of seven villages in Lolai, 66.
- kerbau* (Indon.), buffalo, 184-206, 207, 208, 211, 221, 226, 228, 230, 240, 241, 243, 249, 250, 257, 267, 273, 278, note 23 chapter IV, notes 1, 5, 6, 7 and 13 chapter VII.
- Kesu', 1) a *lembang*, 20, 43, 51; 2) a federation, 30, 31, 32, 54, 55, 69, 72-79, 89, 95, 97, 98, 100-103, 104, 115, 126, 139, 143, 144, 153, 188, 202, 204, 217, 237, 238, 243, 265-267, 276, 277, 279, 280, 285, note 6 chapter II, note 8 chapter IV, notes 28 and 35 chapter VI.
- ketip* (Indon.), 'dime', 290.
- kiki*', small bits of meat offered to the ancestors, 204.
- kila*', lightning, 82.
- Killi'-killi', the forefather of the *burake*-priest (Tikala and Riu), 141, 144.
- koang*, a bird which is of significance as an omen, 213.
- kollong*, meat cut in a strip from the neck, 206.
- kombong*, a village meeting, 36, 53.
- kombong(an) kalua*', a large, important village meeting, 35, 36, 53.
- koro*, a black and white chicken, 209.
- korong*, see *kayo*.
- kosik*, see *bombo kosik*.
- kua-kua*, reed, *Rottboelia glandulosa*, 53, 54, note 11 chapter IV; see also *tana' kua-kua*.
- kuni*', *Curcuma*, 292.
- Kurra', a *lembang*, 20, 67, note 10 chapter III.
- Kurra Manapa', 'Dense Thicket', 'Dense Underbrush', the title of one of the *To A'pa* of Sangalla', 82-83.
- kurre sumanga*', 'Call your soul', Come, *sumanga*' (= soul), used in prayers to address to the ancestors; also used to say thanks, 128, 290.
- kutu*, lice, 200.
- laa*, see *ala-ala*.
- la'bo*', sword, machete, 202.
- La'bo', a community in Kesu', 74-77, 289, note 7 chapter IV.
- la'bo' pinae*, ancient sword, 149, 256, note 50 chapter VI.
- ladang* (Indon.), dry field, swidden, 12, note 9 chapter I.

- Laelo, name of the first cow in Kesu' myths, 192.
- Lai Ambun diKesu' (Ambun diKesu'), 'The Morning Mist of Kesu', a female ancestor in Kesu', 26, 153, 157.
- Lakipadada, the founder of the princely ramales in the *puang*-region, 145, 148-153, 190.
- lakke, lakkean, lakian, a 'hut on high poles', used in a death ritual of the highest rank, 261.
- lalan bombo, the way of the bombo (= the soul that has not yet been purified), the name for a door in the western wall, 245.
- lalan deata, 'the way of the gods', the upper part of the northern wall of a house, 245.
- lamba', a kind of tree, also used to denote a person of high rank or who is 'rich, respected', 103, 230, 276.
- Lambe' Susu, a female ancestor in Tikala, 158.
- lambiri', the pseudo-sugarpalm, 230.
- lame, a yam variety, 224.
- Lando Kollong, a hen in myth, 240.
- Lando Rundun, a female ancestor in Riu, 156-159.
- langi', heaven, heavens, upperworld, 131.
- Langi', Heaven, 24, 115, 132.
- langngan, a kind of roasting-spit, 77, 208, 271, 273.
- langsa', a fruit, *Lansuim domesticum*, 88, 226.
- lantang, hut, shed, 75.
- Lantang Bulaanna Sukaran Aluk, 'The Golden (feast) Hut, where all Adat-Regulations are Displayed; a title in Kesu', 75.
- lao', south, 131.
- la'pa' kasalle, see *bua' kasalle*.
- la'pa' padang, see *bua' padang*.
- lau, gourd, 240.
- lau', see *lao'*.
- layuk, the principal, the most important, see *tongkonon layuk*.
- Leatung, a region in Sangalla', 84.
- Lebukan, 'lump of earth' (in myth), 143.
- lembang, 1) proa, 113, 117, 132, 159; 2) district, *adat*-community, 6, 58, 60, 61, 62-69, 74, 92, 104, 105, 113, 144; 3) a division of a modern *kecamatan*, 3.
- Lemo, a community in Kesu', 77.
- lemo laa', a kind of citrus, 150.
- lentong, lempong, a framework of poles for carrying a pig, 207.
- lepong, round, see Basse Lepongan Bulan. Lepongan Bulan, 'Round as the Moon', region in Sangalla', 90.
- le'to, siblings, 28.
- letto-lettoan, see *lentong*.
- liang, rock grave, 18, 113.
- likaran biang (*manglika' biang*), 1) an offering, 265, 273; 2) a prayer, 220, 270, 273.
- liku, pool, pothole, 117, 142.
- Liku Lambe'na Kalindo Bulan, 'The vast, deep pool of the Majestic One', a title in Sangalla', 87-88.
- lila(na), tongue, 201, 206.
- lili', dependent regions in Sangalla', 85-87.
- limbong, pool, 126.
- Limbong Allo, see Indo' Orron.
- limbong pala', 'half a hand', a measure for buffalo-horns, 188.
- limbu, corner-post, 83.
- Limbu A'pa'na Sangalla', 'The Four Cornerposts of Sangalla', a title in Sangalla', 83, 90.
- lindo puang, 'the face of the gods', the front part of a *tongkonan*, 245.
- lingga, a phallic symbol, 269.
- linggis, iron rod, 291, note 19 chapter IX.
- lino, the middleworld, the dwelling-place of men, 110, 130.
- litak mabusa, white paint, 232.
- litak malotong, black paint, 231.
- litak mararang, red paint, 232.
- litak mariri, yellow paint, 232.
- lo', see *lao'*.
- lokkon loë rara', 'coil of hair, dangling like a golden neck ornament'; *lokkon lo'erara'*, the title of a woman of high rank, 50.
- Lokkon Lo'erara' (Lokkon Loërarara'), a goddess, 120, 132, 135.
- Lolai, a region, 66.
- lolo, umbilical cord, 29.
- lompo(na), fat, 206.
- londong, cock, 117, 211.
- londong datu, a functionary in a village in Kesu', 252.
- Londong Kila', 'The Lightning Cock', the title of the To A'pa' from Sangalla', 82.
- Londong diLangi', 'The Cock from Hea-

- ven', an important ancestor, 24, 25, 160, 161, 223, 276, note 35 chapter VI.
- Londong diRura, 'the Man - or Cock - from Rura', who according to myth was drowned in Rura, 157, 160.
- Londongna Tulangdidi', 'The Cock of Tulangdidi', a cock who plays a role in the myth of Tulangdidi', 166-168; a constellation, 168, note 42 chapter VI.
- londong sella'*, a red cock with white feet, 81, 210.
- longa*, the verandah or porch of a house of a nobleman, 237.
- lonno'*, millet, 224, 271.
- lotong*, a black chicken, 209.
- lotong boko'*, 'a buffalo with a black back', the name of a *maa'*-cloth, 257.
- lumbaa langi'*, a bamboo pole which figures in the final phase of the great *bua'*-feast, 210, 271.
- Luwu, modern district, 7, 68.
- Luwu', old kingdom, 6, 8, 17, 37, 68, 85, 88, 149, 172, 285, note 2 chapter I, note 28 chapter VI.
- lumbang*, half of a divining-reed, with its convex side turned upwards, 275.
- maa'*, sacral cloth, 119, 136, 185, 200, 202, 219, 257-259, 276.
- ma'ba'ta*, 'those who tap palm-wine', a rite of the mortuary feast, 205.
- ma'batang*, an important rite of a mortuary feast, 205, 263.
- ma'bate*, 'carrying out the bamboo-pole', a rite of the *maro*-ritual, 140.
- ma'bua'*, see *bua'*-ritual.
- ma'bua'*-litany, 216.
- ma'bubung*, the prayer which is said when the roofing of a *tongkonan* is renewed, 244, 249.
- ma'dampi*, see *to ma'dampi*.
- ma'dandan*, a dance, note 8 chapter VIII.
- Madandan, 1) a district, 20; 2) a *lembang*, 29, 66, 67, 77, 158, 289, note 17 chapter IV.
- ma'dika bua'*, head of a *bua'*, 64.
- ma'dika (ma'dika lembang)*, head of a *lembang*, 63, 64, 66, 67.
- ma'gellu'*, see *gellu'*.
- makaka*, see *to makaka*.
- Ma'kale, 1) a traditional *lembang* governed by a prince, 13, 15, 29, 30, 54, 55, 79, 80, 89, 91-92, 146, 147, 149, 189, 190, 197, 214, 215, 217, 224, 254, 277, 279, 280, 288, 289, note 7 chapter IX; 2) the capital of the *kabupaten* Tana Toraja, 3; 3) a district in the colonial administration, 20; 4) a modern *kecamatan*, 21.
- Makassar (Macassar), the former name of Ujung Pandang, capital of South Sulawesi, 7, 9.
- ma'lelleng kayu*, 'cutting the trees that are needed for construction', (*kayu* = wood, *ma'lelleng* = to cut), a rite associated with the actual construction of a house, 247.
- Malimbong, a region, 20, 64.
- mallai*, to run away, flee, 129.
- Mamasa, a region which borders on Tana Toraja in the west, part of the *kabupaten* Polmas (= Polewali-Mamasa), 279, 285.
- Mamasa-Toraja, a group which closely resembles the Sa'dan-Toraja, 6, 7, 190, note 3 chapter I.
- ma'mimi*, pure, 55; see also *puang ma'mimi*.
- mamintungku baine*, daughter-in-law, 42.
- mamintungku muane*, son-in-law, 42.
- Manaek, the most important female ancestor of Nonongan, 26, 157, 257.
- manakka*, accomplished, quick-witted, 218.
- ma'nene'*, see *ma'tomatua*.
- Maniang*, a *pusaka*-sword in Ma'kale, 151.
- mangaluk*, the invocation of the *deata* by the *to burake*, 285.
- manganda'*, a dance in which the dancers wear buffalo-horns, 195, 196, 242, 243.
- manganta'*, a conversion ritual, 100, 104, 175, 208.
- mangimbo*, a prayer, to pray, 98, 100, 102, 205, 249, 252.
- mangaru'*, a war dance, 195.
- mangga*, mango-fruit, 149.
- maniku*, a bird, 223.
- mangkaro palembang*, an important rite accompanying the founding of a house, 102.
- manglika' biang (likaran biang)*, a rite during the construction of the house, 247, 265, 270.
- manglo'po' patongkon*, a rite which is held when a house is built, 247.
- mangono'*, a rite which is held after the building of a new house, 247, note 2

- chapter VIII.
- mangrambu langi*, see *ma'rambu langi*.
- mangrande londong*, 'the one who holds the cock', a functionary at the *merok*-feast, 101-102, 205 (to *mangrande londong*).
- mangrapu*, 'to gather together in a family group', a rite in several rituals, note 2 chapter VIII.
- mangrara banua*, 'to cover the house with blood', a ritual which is held for a new house, 100, 101, 102, 249, 251.
- mangrara tallu*, a ritual for the inauguration of a distinguished house, 147.
- mangrere londong*, a functionary in Kesu', 102.
- mangrondon*, 'the pulling down of the ruin' (= the old building), a rite in the process of house-building, 247.
- mangulai*, see *ma'tomatua*.
- manimbong*, a dance, 269, note 8 chapter VIII.
- mano'bo*, see *to mano'bo*.
- mantaa bati*, a litany, 76.
- mantobok*, (see also *to mantobok*), a title in a Kesu' village, 101, 102.
- mantunu*, the slaughter of buffaloes for the dead, 205.
- Manturini, the first buffalo (in myth), 136, 192, 228.
- Manturino, Datu Lauku's son, 137.
- manurun*, see *to manurun*.
- manurun di langi*, 'those who came down from heaven', the ancestors who descended on earth, 81.
- Manurun di Langi' (To Manurun di Langi'), 'Come down from Heaven' (= Puang riKesu'), the most important ancestor in Kesu', 24-26; *ibid.* in Tikala, 117, 141, 142, 143.
- ma'pabendan*, a rite which is held when a house is in process of construction, 247.
- ma'palumbang papa*, a rite connected with house-building, 248.
- ma'pakande to matua*, to give food to the ancestors (of the Western sphere), an important rite in several rituals, 248, 278.
- ma'pallin*, an important rite in many rituals; the sacrificial animal is a black chicken, 247.
- ma'papa*, the renewal of the roof of a *tongkonan*, a rite, 248.
- ma'parando*, a rite of a death ritual in Sangalla', 255.
- ma'pesung*, bringing an offering on pieces of banana-leaf, 140, 249.
- ma'patassu kayu*, 'fetching the wood from the forest', a rite connected with the building of a house, 247.
- Mappa', a district, 20, 64.
- ma'rambu langi*, 'to cover the heavens with smoke', an expiatory offering, 31, 33.
- Marampio Padang, a mythical hero, 157, 163, 165, 229, note 38 chapter VI.
- ma'randing*, a war dance, 195.
- marapuan*, a ramage, 22, 23, 24, 27, 59, 205, 244.
- Marimbunna, an ancestor in Tikala, 159.
- Marrin diLiku, the wife of Manurun diLangi', 142.
- maro*, a purificatory or exorcistic ritual, 120, 127, 137, 140, 160, 221, 226, note 26 chapter VI, note 14 chapter IX.
- maruang*, a specific piece of meat allotted to slaves, 86.
- ma'sak*, a bird, 214.
- ma'sanduk*, a title in a Kesu' village, 100, 101, 102, 103.
- massang*, pure (of noble birth), 55.
- massaung*, a cockfight, 212.
- ma'singgi*, the laudation of a special category of people, 50, 216.
- massomba tedong*, the consecration of the sacrificial buffalo at the *merok*- and the great *bua'*-feast, 100.
- Masuppu'(river), 7, 14, 15.
- ma'sura tallang*, a sacrifice in expiation of a transgression, 140.
- massurak*, the blessing of the *pa'karu'dusan*-buffalo, 278.
- Mata Bulaan, 'The Golden Eye', the name of the sword of Manaek, the female ancestor of Nonongan, 257.
- ma'talla*, the process of buying oneself out of slavery, 56.
- ma'tamben*, a rite connected with the building of a house, 247.
- ma'tenten*, a dance, 195, note 9 chapter VII.
- ma'tomatua (ma'nene)*, a ritual for the ancestors, 102, 140, 186.
- matua ulu*, the village elders, titleholders in Buntao' and Kesu', 72, 101, 102, 103,

248.
matusa, WiFa, WiMo, HuFa, HuMo, 42.
melangi (malangi), 'to seek a connection with the upperworld', a ritual, note 14 chapter IX.
menammu pare, 'to receive the rice', 'bringing the rice in', a ritual at the start of the harvest, 95, 278.
 Mengkendek, 1) a district in colonial time, 20; 2) a *lembang*, governed by a prince, 1, 3, 8, 30, 55, 76, 79, 80, 88, 89, 91-92, 147, 189, 190, 197, 223, 254, 288, 289; 3) a *kecamatan*, 21.
 Menturiri, the first chicken (in myth), 136, 228.
merok-feast, *merok*-ritual, a feast given by the ramage, 13, 27, 28, 43, 47, 53, 54, 57, 65, 67, 69, 99, 100, 109, 110, 118, 134, 137, 140, 165, 175, 183, 193, 202, 206, 207, 220, 221, 226, 229, 244, 247, 257, 275, 282, 293, note 7 chapter VII, note 1 and 3 chapter IX.
mettamben lako barana' tang sirrinan, 'to set forth diagonally on a banyan tree at a place where there are no ants', i.e. to marry with a woman of pure (noble) blood, 24.
minaa, see *to minaa*.
muane (ku), husband, 42, 80; see also *anak muane*.
mula, the first, see Pong Mulatau.
naa, soul, 128.
 Nakka, see *manakka*.
 Nanggala, a district, 3, 20, 66, note 21 chapter VI.
nani, to sing, 61.
naraka, Sanskrit for hell, 122.
Ne', ne', grandfather, grandmother, used as a prefix before a name (*Ne' Sangga*), 29, 30.
nene', grandfather, grandmother, forefather, -mother, ancestor, 29, 30, 119, 124, 125.
nene' guntu, great-grandfather, great-grandmother, 29, 41.
nene' salemberan, great-great-grandfather, great-great-grandmother, 29, 41.
nene' tangnga, 'ancestors from the middle period', 125.
nene' todoan, great-great-great-grandfather, -grandmother, 29, 41.
nene' undi, 'ancestors from the latter period', 125.
 Nonongan, a region, 76-77, 120, 277, 289, note 22 chapter IV, note 1 chapter IX.
oda-oda-(blades), a sword, swords, 180, note 52 chapter VI.
oli barra', 'ears of rice', a pattern on a *maa'*-cloth, 257.
ossoran, myth, 133, note 2 chapter VI.
pa'amberan, FaBr, MoBr, 41.
pa'ampoan, Br's or Si's grandchildren, 42.
pa'anakan, nephew, niece, 29, 42.
pabalian, helper, a function in the village, 102, 271.
 Pabane', an ancestor in Kesu', 153, 157.
pa'barana', 'the leaves of the waringin', a motif in woodcarving, 2, 35.
pa'baranae, 'a shoot of a banyan tree', a motif in woodcarving, 240.
pa'barre allo, a sun disk with rays, a motif in woodcarving, 239.
pa'batang lau, a stalk of the *lau'* (= gourd), a motif in woodcarving, 240.
pa'boko komba kalua', 'the massive golden armband', a motif in woodcarving, 240.
pa'bombo uai, an insect that moves swiftly over the surface of the water, 243, note 1 chapter VIII.
pa'bulu londong, cock's feathers, a motif in woodcarving, 239, 240, 261.
pa'bungkang tasik, the sea crab, a motif in woodcarving, 239.
pa'bantuan sugi', 'the rich whose wealth is like a mountain' (the very rich), 204.
 Padakka, a figure in myth, 224.
padang, earth, land, 61, 92, 110, 111, 115, 130.
 Padang, Earth, a deity, 115.
 Padang di Sangalla', the land of Sangalla', 79.
pa'daun bolu, 'betel leaves', a motif in woodcarving, 230, 240, 243, 252.
pa'doti langi', a figure in art, 261.
pa'doti siluang, 'the speckled buffalo', a motif in woodcarving, 240.
pa'indoran (pekaindoran), FaSi, MoSi, 41.
pa'aita, seer, 137, 274.
pa'kapu' baka, 'the tightly bound basket', a motif in woodcarving, 239.
pa'karudu'san, see *ka'ru'dusan*.
pa'kayun, a functionary in a cockfight, 212, 213.
paladan bo'do', see *tangdo'*.

- palanduan*, a rack on which firewood is stored, 237.
- palanduan-duan*, a shrine, 226, 273.
- palangngan para*, a small shelf affixed to the front wall, used for offerings, 273.
- Palasa Makati', 'some who is like a bull with a hump that itches constantly', a title in Sangalla', 83.
- Palesan, a *lembang* (district), a region, 64, note 10 chapter III.
- Pali, a region, 67, note 10 chapter III.
- palo*, the meat of the midriff of a buffalo, 204, 208, 209.
- pa'lolo tabang*, a motif in woodcarving, 240.
- palona*, breastbone, 204.
- Palonga, a brother of Manaek, 153.
- pa'longkona*, the hind quarters of a pig, 40.
- pampang*, horns of an ox, 187.
- pananda bisara*, determining the rules of *adat-law*, 114.
- Pandan Matari Allo, 'Extensive as the Sun', a title of the *puang* of Sangalla', 90.
- Pande Manarang, 'The Skilful Carpenter', a sibling of Kambunolangi', 137.
- Pande Paita (alias Pande Pandita), 'The Skilful Seer', a sibling of Kambunolangi', 137.
- Pande Paliuk, 'He who is extraordinarily capable', a sibling of Kambunolangi', 137.
- Pane Patangnga', 'The first iron-smith' (in myth), 141, 277 (also Pong P.P.).
- pandokko' dena'*, 'the house of ricebirds', a house with a bamboo roof, 245.
- Pangala', a *lembang*, 20, 66, 78, 277, 289.
- Pangala' Tamman, 'Impenetrable Wood', a title in Sangalla', 82.
- pagala tondok*, 'the founder(s) of the village', 94.
- pagarak*, head of a *saroan*, 97.
- Panggalo'-galo', 'The Brave One', the child of Pano (Rangga) Bulaan, 173-183.
- Pangimbo Manuk, 'The Prayer over the Hen Sacrifice', 225.
- panglappa'*, a functionary in a cockfight, 212, 213.
- pangloli*, a *puđu* (black buffalo) with a white tip on its tail, 186.
- pangngan*, betel, see *anak pangngan*.
- pano*, a skin disease, 174.
- Pano Bulaan (= Rangga Bulaan), 'The Golden Skin Disease', a woman who plays the principal role in the myth of the same name, 173-183, 219, note 48 chapter VI.
- panta'nakan lolo*, 'a nursery for young riceplants', 74, 75.
- Panta'nakan Lolo, 'The Nursery for the young Riceplants', an area in Kesu', 74, 75.
- Pantilang, a region in Luwu' inhabited by Toraja, 68, 69.
- pantiti'*, an offering to the *deata* (gods) 206.
- Pa'palumbangan, 'The Piling up of Rice Bundles on a *sawah-dike*', a title in Kesu', 76.
- pao*, mangga, note 22 chapter VI.
- pa'pong*, a kind of tree, note 25 chapter VII.
- pa'puangan*, 'those who are honoured as a lord', crocodiles, eels, 116.
- Paragusi, see To Paragusi.
- parande pata'*, house pile, 233.
- para-para*, the platform (or shrine) on which offerings for Puang Matua are placed, 272.
- Parandangan, 'The Points of Support', functionaries in Buntao', 72.
- parengnge'*, see to *parengnge'*.
- pare pare nangka*, 'the hard, inedible bits of a *nangka-fruit*', a class in Kesu', note 9 chapter III.
- parepe'*, a buffalo figuring in a superior type of funeral, 197-198, 276.
- pare' tallu bulinna (pare' tallu etengna)*, 'the three clusters (ears) of rice' (in myth), 233.
- pariasuru'*, a functionary who performs at the *ma'nene'* (*ma'tomatua*) ritual, 102.
- pasanduk salu rampanan kapa'*, 'a marriage to test the way one sounds the depths of a river', an expression which refers to the binding element in the marriage agreement, 34.
- passakke*, a plant, 221, 229.
- passepak*, a functionary in a cockfight, 212-213.
- Passomba Tedong (*passomba tedong*), 'the laudation of the buffalo', the litany by which the buffalo is consecrated in the *merok-ritual*, 43, 45, 119, 120, 134-

- 139, 165, 167, 186, 219, 220, 223, 225, 237, note 2 chapter VI, notes 3 and 6 chapter VII, note 1 chapter IX.
- pata'*, a horizontal beam in a house, 233, 234-235, 248.
- Patala Bantan, a son of Lakipadada, 150.
- Patala Bunga, a son of Lakipadada, 150.
- Patala Merang, a son of Lakipadada, 150.
- pata' serre'*, 'The beam on which the cat sits', a beam which supports the attic, 234.
- patalo*, victor, note 9 chapter III.
- patane*, a tomb hollowed out of a boulder, 260.
- pa'tanduk rape*, a motif in woodcarving depicting buffalo-horns, 261.
- patang*, four, 61.
- patangdo*, a stone placed in the ground in front of the house which acts as the center of a great *bua'*-feast, 221.
- patang penanian*, the four *penanian*, an *adat*-community, 60, 61, 62, 66, 69-72, 76, 97, 99, 104.
- pa'tedong*, a stylized buffalo-head, a motif in art, 193, note 8 chapter VII.
- patongkon*, house pile, 233.
- patongkon a'pa'*, a house resting on four piles, but without any walls, 245.
- patung*, a bamboo variety, 144, 229.
- pa'ulu tingke'*, 'the head of the spinning-wheel', a motif in art, note 8 chapter VII.
- payung-payung*, figures of thread used in a death ritual, 261.
- pekaindoran (pa'indoran)*, 1) a title in Kesu', 75; 2) a kinship term, 41.
- pemanala*, parts of the *pesung*, 206.
- Pemanukan, a division of the region of Silanan, note 14 chapter IV.
- pempetuanna (= padang)*, cultivated land, 92.
- penaa*, breath, 128.
- penamile (pinamile, penule)*, a large sacrificial bull, note 1 chapter VII.
- penanian*, an *adat*-community which celebrates the *bua' padang*-feast, 60, 61, 62-69, 72-82, note 1 chapter IV.
- pentiroan*, 'the look-out', the name of a bamboo used for an offering, 272.
- Pentionganan, 'the look-out', a title in Kesu', 77, 78.
- penule*, see *penamile*.
- pesung*, an offering on a banana-leaf, 206, 226, 251, 259, 272.
- pesung sangdaun*, an offering consisting of a banana-leaf in which food is wrapped, 271, 273.
- Pesungan, Banne, a title in Tikunna Malenong, 75.
- Petimba uai, 'the one who fetches water for the *puang'*, a title in Sangalla', 86.
- petulak*, village elder, helper, 68, 71, 101, 203 (see also *tulak*, support).
- petuo*, 'supporters of life', the name of house-posts, 233, 241.
- pinamile*, see *penamile*.
- pio*, loin-cloth, also used as a ceremonial banner, 193, 194, 257.
- pio uki'*, a loin-cloth (*pio*) with a woven design (*uki'*), 257.
- piong*, a bamboo-joint in which food is cooked, 271, 273.
- Piongan, a district, 20, 67.
- piong sanglampa*, a single bamboo-joint for cooked food, an offering, 271.
- pitung bongi (dipapitung bongi)*, a death ritual which lasts seven nights, 197, 265, 267.
- pitutai*, a kind of bird, 224.
- pollo'na*, hind quarters of a buffalo, 201.
- Polopadang, an ancestor in Kesu', 153-156, 189, 218, 229, notes 27 and 37 chapter VI.
- pong*, a contracted form of *puang*, lord; a term of address for a father of several children, 110.
- Pong Banggairante, see *Banggairante*.
- Pongkapadang, the ancestor of the Mamasa-Toraja, note 3 chapter VI.
- Pongko', 'Round Earthmound', the island on which the ancestors landed, 62, 112, 113, 125, 130, 131, 145, 159.
- Pong Lalondong, 'The Lord of Puya', the Realm of the Dead, 115, 117, 122, 132, 135, 138, 161, 216, 218, note 5 chapter V.
- Pong Maleleong, one of the first slaves in myth (Kesu'), 43, 44, 137.
- Pong Maratintin, 'The Teller of Lies', a mythical character, 161.
- Pong Mulatau, the first man (on earth), an ancestor, 25, 137, 138, 140, 143.
- Pong Paku Lando, 'the Longleafed Fern', a slave in myth, 138.
- Pong Pirik-pirik, 'The Small Rain', the forefather of the rain, 136.

- Pong Tiku, the resistance leader in Tana Toraja, 9.
- Pong Tulakpadang, 'The One who supports the Earth, The Lord of the Underworld', 114, 116, 118-120, 121, 129, 131, 132, 134, 135, 138, 144, 145, 252, note 5 chapter VI.
- Pong Tulangdenna, 'The Lord dwelling in a particular Place', 115, 116, 117, 126, 132, 135.
- po'pok*, werewolf, 127.
- posi'*, navel, 241, 244.
- Pottala, a mythical character, 162, 171-173.
- potto kalembang*, the name for slaves in Buntao', 44, 45.
- Potto Kalembang, the first female slave in myth, 44.
- puang* (Puang), lord, prince, 8, 17, 18, 30, 31, 32, 63, 65, 79-90, 110, 122, 132, 134, 136, 146, 154, 189, 190, 197, 199, 229, 245, 252, 260, notes 10 and 14 chapter IV, note 28 chapter VII; *puang*, gods, 270.
- puang-area*, -realm, -regions, principedom, 16, 18, 25, 26, 63, 76, 151, 185, 288, note 14 chapter IX.
- puang-family*, 17, 18, 25, note 24 chapter VI.
- puang-lineage*, *puang-dynasty*, *puang-ramage*, 18, 23, 26, 33, 121, 214, 218, note 14 chapter IV.
- Puang Lakipadada, see Lakipadada.
- Puang Maruru', see Datu Maruru'.
- Puang Matua, 'The Old Lord', the most prominent god of the Toraja, 111, 112, 117-120, 129, 131, 132, 137, 138, 145, 146, 149, 160, 161, 190, 193, 220, 223, 225, 272, note 6 chapter VI.
- Puang Mora, an ancestor in Kesu', 153.
- Puang Radeng, 'The Lord who leans sitting against Something', a deity in Kesu', 117, 132, 135.
- Puang riKesu', an ancestor in Kesu', 74, 75, 78, 126.
- Puang Tamborolangi', 'The Drum of Heaven', an ancestor in the Tallulembangna, 145-148, 151.
- Puang Tambulibuntu, son of Tamborolangi', 148.
- pudu'*, a black buffalo or pig, 186, 208.
- punduk sarai*, stones in the shape of a buffalo which bring their owners luck, 195.
- pusaka* (Indon.), heirloom, 151, notes 24 and 26 chapter VI, note 28 chapter VII.
- Puya, realm of the dead, 113, 114, 121, 122, 131, 132, 135, 196, 216.
- puyo*, quail, 213.
- raja*, 1) prince; king, 150; 2) princely people, 6; 3) grand, magnificent, 6.
- rajang* (Buginese), west, 6.
- rambu tuka'*, 'climbing smoke', the sacrifices for the East, 112, 255, 256.
- rambu solo'*, 'laying smoke', the sacrifices for the dead, 112, 255, 256.
- rampanan kapa'*, 'the laying down of the kapa', the agreements made at marriage, 30, 34-37, note 9 chapter II.
- rampean*, cognates, 27, 42.
- ranaka*, hell, 122.
- rangga*, 'having branches', 143, note 48 chapter VI.
- Rangga Bulaan, see Pano Bulaan.
- Rano, a district, 20, 64.
- rante*, the plain where the concluding rites of the entombment rituals are celebrated, 92, 93, 261, 266, 268.
- Rantebua (Rantebua'), a district, 20, 68.
- Rante Bulaan, 'The Golden Plain', a region in myth, 143, 159.
- rante kala'paran*, the plain where the *bua'*-rites are celebrated, 93, 261.
- Rantepao (Rante Pao), 1) a town, 3, 72, 126; 2) a district, 21, 215, 260, 280.
- rapu*, subramage, 22, 23, 31, 59, 231, 257.
- rara'*, jewelry worn by upper-class women, 174, 175.
- Ratte, 1) a former district, 68; 2) a village, 66.
- rebongan didi*, 'breaking sugar-palm leaf-ribs'; these sticks of the sugar-palm leaf are used as a mnemonic aid in the recitation of the genealogies and in enumerating the various *adat* acts to be performed, 23-24.
- Rembon, a region, 3.
- rengnge'*, the manner in which a woman carries a load, 48, 49.
- retteng*, occasional or topical poetry, 16.
- Riako', the ancestor of iron, 136, 228.
- Rinding Bassi, 'Iron Wall', a title in Nonongan, 78; *ibid.* in Tikunna Malenong, 75.
- Rinding Bassina Kesu', 'The Iron Wall of Kesu'', a title in Kesu', 75.

- Rinding Daun Induk, 'The Wall made of Sugar-Palm Leaves', a title in Buntao', 71; *ibid.* a title in Sangalla', 84.
- Rinding Kila', 'The Wall of Lightning', a title in Buntao', 70.
- Riu, a region, 144, 156-159, 286, 287.
- rokko*, below, 130.
- ruangna*, meat from one of the sides of the body, 206.
- Rura, a region in myth, 159-161.
- ruma-ruma*, a decoration constructed of planks, previously used as a decoration in a great *buah*-feast, 238, 241-244.
- Saa, the python in the myth of Pano (Rangga) Bulaan, 173-183.
- Sa'dan, a district, 20, 37, 65, 254.
- Sa'dan River, 3, 7, 15, 62, 116, 158, 159.
- Sa'dan-Toraja, 2, 6-8, 10, 11, 13, 14, 15, 16, 17, 18, 19, 22, 59, 66, 107, 117, 118, 131, 134, 190, 191, 193, 218, 222, 224, 260, 274.
- saleko*, a buffalo with roughly equal areas of black and white skin, 185, 188.
- sali*, 1) floor, 237, 243, 252, 254, 276; 2) the central room of a *tongkonan*, 237.
- Sallebayu, a *tongkonan* in Kesu', 75, 103.
- salu*, river, 24.
- Salu Bombo, The River of the Dead, 121.
- samara*, a buffalo with a white circle on its forehead, 185.
- sambao*', the buffalo of the slaves, 186.
- sampu*, cousin (cross- or parallel-), 28, 42, 160.
- sampu pissan*, first cousins, 28, 33, 42, 160.
- sampu penduan*, second cousins, 28, 42, 160.
- sampu pentallun*, third cousins, 28, 32, 42.
- Sampu rari, a god of the underworld, 163.
- sanda*, complete, 146.
- sando*, a priest, 275.
- Sangalla', 1) a *lembang* (district), a principedom governed by a *puang*, 8, 18, 20, 21, 62, 69, 79-91, 189, 190, 197, 254, 286, 288, 289; 2) the name of one of the present districts in Tana Toraja, 21.
- Sangbua', a *buah*-circle in Kesu', 67.
- sangbusukan ponto*, 'from the top of the middle-finger to the armband', a measure for buffalo-horns, 188.
- Sanda Bilik, the wife of Tamborolangi', 146, 147, 148.
- Sanggalangi', a district, 21.
- sanggaria*, a governor in Luwu', 7.
- sangkapan padang*, a lump of soil, a clod of earth (in myth), 142.
- sangkumabe*', 'just longer than half a hand', a measure for buffalo-horns, 188, 189.
- sanglampa taruno*, 'the top of a (middle) finger long', a measure for buffalo-horns, 188.
- sanglengo*, 'a hand', a measure for buffalo-horns, 188.
- sangpala*', 'one hand and four fingers', a measure for buffalo-horns, 188, 189.
- Sangpalin Bangunan, 'To rise together' (in a fight), the name of an *adat*-community in Tikala, 67.
- sangparengngesan*, 'one *parengnge*'-ship', a word denoting a socio-political entity, 74.
- sangsaroan*, a group of people inhabiting a ward, 95.
- sangtaruno mengkaluo*, 'one hand and one finger', a measure for buffalo-horns, 188.
- Sangtendanan Langngan, 'One in the setting up of the *langngan*', an area allied with Kesu', 77.
- sangtepo padang*, see *tepona padang*.
- Sangulu Bai, 'Forming One Swine's Head', an *adat*-community in Tikala, 67.
- Sapan Kua-Kua, 'Dam or Barrier of Reeds growing in Puddles', a title in Sangalla', 84.
- saratu*', one hundred, 146, 154.
- sarigan*, a palanquin containing the remains of the deceased, 261.
- Saripibulaan, a god, 132.
- sarira*, a rainbow, 163.
- Sarira, a rock-massif in Kesu', 160.
- sarita*, a sacral cloth, 136, 257-259.
- saro*, payments (or compensation) for work, 95.
- saroan*, mutual aid organization, 18, 54, 65, 66, 95, 96, 97, 99.
- sauan sibarrung*, double bellows, used by Puang Matua to create man, plants, animals and iron, 136.
- Sawerigadeng, a hero in myth, 151.
- Seba Sola Pia Biung, a character in

- folktales, 162.
- sekke*, a bird which is of significance in headhunting, 214.
- sella'*, see *londong sella'*.
- Sembang Kada, 'He who speaks the decisive word', a title in Buntao', 69.
- sendana*, sandalwood tree, 164, 165, 219.
- sendana sugi'*, 'the tree of heaven laden with riches', 57.
- sepagga*, a brown cock with white spots, 210.
- Sere Dodo, a mythical character, 162.
- Sere Tapong, a mythical character, 162.
- Sereale Penanian, 'The Twenty-four Sub-districts' (of Sangalla'), 82.
- serre'* (*sese'*), cat, 215-218.
- Sesean, a mountain, 3, 126, 159; 2) a district, 21, 158.
- Sesseng, a *lembang*, 20, 67.
- si bobo'* *bannang*, 'boiled rice, used to starch thread', a simple form of marriage, 35.
- sibali*, possessing a bond of reciprocity, 103, 159.
- sikukku'*, horns which curve downwards and almost meet, 186.
- Silanan, a region in Mengkendek, 92, note 14 chapter IV.
- sile'to loloku*, (my) full brother or sister (same Fa and Mo), a poetic expression (*lolo* = umbilical cord), 28, 42.
- simbolong manik*, 'hairknot, shining like beads', a title for a woman of noble birth, 50, 64.
- Simbolong Manik, a goddess, 135, 136.
- Simbuang, a *lembang* (district), 13, 20, 64.
- simbuang batu*, a menhir, 198, 265-269.
- simbuang kayu*, a tree-trunk used for ritual purposes in a funeral of high order, 266, 267.
- singgi' to kaunan*, the laudation of the unfree, 47.
- sipula'*, a reason for requiring payment of the *kapa'*, 35.
- siruran*, family, 23.
- sisura'* (*sisula'* *sirrin*), 'pell-mell', referring to the prohibition against marrying one's brother-in-law's sister, 33.
- siulu'* (*siulu'* *lanmai tambuk*), brother or sister, 29, 42.
- siulu' dio ambe'*, half-siblings (same father), 42.
- siulu' dio indo'*, half-siblings (same mother), 42.
- Sokko mebali, the buffalo with horns bending downwards in folktales, 186.
- Sokko remak, see Sokko mebali.
- sokkong*, to support (the back of the neck), 206.
- sokkong bayu*, 'the collar of the jacket', a title in Kesu' and elsewhere, 53, 54, 65, 70, 97, 98, 99, 100, 101, 103, 137, 203, 208, 249-251.
- solonna tandilo rante*, 'the companion of the *tandilo'*, a special name for a gifted *sokkong bayu*, 54.
- somba*, brideprice, 31, 37.
- sompok rangka'*, 'one finger long', a measure for buffalo-horns, 188, (also *sompok rakka'*).
- So' Patelang, a mythical character, 162.
- Sudan, a sword of the ancestor Lakipadada, 149, 151.
- sukaran*, measure, 146.
- sukaran aluk*, prescriptions for the rituals, 67, 68, 114, 145, 146, 147.
- suke bombo*, a *Drosera* species, 228.
- sule to gandang*, 'the substitute for the drum', a name given to a gifted *sokkong bayu*, 54.
- Sullukan, a *tongkonan* in Kesu', 96.
- Suloara', 1) a *lembang* (district), 144; 2) an important ancestor of the ramagees in the Sesean-area, 158, 159.
- Suma'*, see *sunga'*.
- sumanga'*, soul, 129, 290.
- sumbung*, the room at the rear of the *tongkonan*, its southern end, 233, 237-238.
- sumbung penaa'*, 'the appendage of the soul', the name of a buffalo sacrificed during the first part of a funeral of high order, 197, 198.
- sunu'*, see *sunga'*.
- sunga'*, 'thread of life, the predetermined span of life', 129.
- surasan tallang*, a shrine for offerings for the *deata*, 119.
- susuk*, pole, 36.
- tabang*, bloodwort, 215.
- tadoran*, a bamboo pole used as an offering, 272, 273.
- Takkebuku, 'Having no Kernel', the ancestor of (boiled) rice, 136.
- takinan la'bo'*, 'those who gird on their

- swords', the title of a group of functionaries or the security forces in a *penanian*, 71, 72.
- Takinan La'bo'na Pentionganan, 'As in one bond girding on the swords of the Pentionganan', the name of the security forces of Lemo which serve the *tongkonan* Nonongan, 77.
- tala*, sexually deviant, 173.
- Taleon, a *lembang* (district), 20, 64, 289, note 10 chapter III.
- tali*, a ribbon, 49.
- tali bate*, a square batik cloth imported from Java, 258.
- tali pakkaridi'*, a hair ribbon, 49.
- talla'*, buying one's freedom, 47.
- tallang*, a variety of bamboo, 222, 273.
- tallang baine*, a female bamboo *tallang*, note 13 chapter VI.
- Tallo Mangka' Kalena, 'The Egg which spawned its own Beginning', a goddess, 117, 132, 135.
- Tallu Kurinna, 'The Three Cooking-Pots', the name of three *bu'a*, in Mengkendek, note 14 chapter IV.
- Tallulembangna, 'the Three Proas', the name of the three princedoms in the south of Tana Toraja which were governed by a prince, 60, 79-91.
- tallung bongi*, a death ritual which lasts three nights, 145.
- tambolang*, a stork, 293, note 6 chapter IX.
- Tamborolangi', the important ancestor of the *puang*-lineages, 18, 24, 26, 64, 65, 66, 117, 145-148, 151, 153.
- tambun*, bladder, 201.
- Tamio, a kind of fat worm, the name of the forefather of the pig, 207.
- tampak usukna*, the tip of a rib, 206.
- tana*, earth, land, 110.
- Tana, Earth, 132.
- Tana Matarik Allo, 'Land that has the Shape of the Sun', the name of the league fighting Arung Palaka, 62.
- Tana ngKalë-loë, 'Hanging Country', a mythical land of the Bare'e-Toraja, 151.
- Tana Toraja, 'The Land of the Toraja', a regency (*kabupaten*), 2, 3, 7, 8, 9, 19, 93, 125, 149, 159.
- tana'*, peg, stake, boundary-post, real, acknowledged as valid, so that it has become a hard and fast rule, 35, 52.
- tana' bassi*, 'the iron stakes', the rules applicable when a member of the *to makaka* class breaks the marriage laws, 52, 53, 56, 143.
- tana' bulaan*, 'the stakes of gold', the rules applicable when a man of high nobility violates the marriage regulations, 52, 53, 56, 143.
- tana' karurung*, the rules applicable when a person of low rank violates the marriage rules, 52, 53, 56, 143.
- tana' kua-kua*, class or status of slaves, 143, note 11 chapter IV.
- tandilo*, a stick-cither, note 13 chapter III.
- tandilo ula'*, a clapper-drum (cf. *gamaru* or *garatung*), note 13 chapter III.
- Tandiminanga, 'The Supporter of the Rivermouth' (of the Sa'dan River), a deity, 117, 132, 136, 161.
- tandi rapasan*, 'the supporter of the *rapasan*' (= coffin), a special kind of buffalo which is sacrificed at a death ritual of high order, 197.
- Tanduk Bangkudu, 'The Red-horned One', a name for the cat, 215.
- tanduk bibang*, buffalo-horns of a particular shape, 186.
- tanduk gallang* (*tandu' 'allang*), horns made of brass, 195.
- tanduk kolong*, horns which arch backwards with the points toward each other, 186.
- tanduk pampang*, horns with a wide span, 186.
- tanduk sikki'*, two semi-circular horns which touch each other at their tips, 186.
- tanduk tarangga*, see *tanduk kolong*.
- Tanduk Tata', 'Sharp, Pointed Horns', an important functionary (vice-regent) in Sangalla', 82-84, 91, 92.
- tandung tiulu*, the first sawah laid out (*tiulu*: the source; *tandung*: spacious field), 94.
- tangngana langi'*, the middle of the heavens, 110, 131.
- Tangdilino' (TangdiLino'), 'Not from the Earthquake', the most important ancestor of many ramares in Tana Toraja, 25, 76.
- tangdo*, the room in the north part of a *tongkonan*, 243.

- tangdo* (*tangdo'*), a platform constructed on the occasion of a *bua' kasalle*-feast, 285, note 10 chapter IX.
- tang mate*, immortality, 149.
- tanggan*, 1) a coffin in the form of a house, 260; 2) a longitudinal floorbeam (Rantepao), 260.
- Tapparan, a *lembang* (district), 20, 63, note 10 chapter III.
- taripa jambi*, *Lodoicea Sechellarum*, 151.
- tasak*, a brown-yellow chicken, 209.
- tasik*, sea, 130.
- tattiku'*, a small bird, 214.
- tau-tau*, effigy, 197, 256, 259, 260, 261-263.
- tedong*, buffalo, 184-206.
- tedong bulaan*, a white buffalo, 199.
- Tedong Bulaan, the white buffalo in myth, 155.
- tedong ma'kallang*, a black buffalo with white feet, 186.
- tedong-tedong*, buffaloes made of clay, 194.
- Tele Raa, a mythical figure of the Bare'e-Toraja, 151.
- tepona padang*, 'one fourth of the land', a division of a settlement, 65, 95, 96.
- Tikala, a *lembang* (district), 20, 67, 77, 117, 144, 145, 254.
- Tikunna Malenong, 'That which is situated round the Malenong Cliff, a region in Kesu', 74-79, 289, notes 6 and 7 chapter IV.
- tille*, a kind of reed, *Andropogon Halepensis Stapf*, 229, 269.
- Tillok bulaanna Kesu', 'The Golden Beak of Kesu', a title in Kesu', 77.
- Timbayo Kila', 'Flashing Lightning', a deity, 132.
- tingga'*, the recitation of a genealogy, 23.
- tinggi*, dark-red beads, 220.
- To A'pa', 'The Four', the vice-regents of the principedom of Sangalla', 80-84.
- Tobongkilo, the hen-harrier, a mythical figure of the Bare'e-Toraja, 151.
- to burake*, a rice-priest in Buntao', 71, note 10 chapter II, note 13 chapter III.
- to burake bombo*, the death priest (= *to mebalun*), 119, 122, 274.
- to burake tambolang*, a 'hermaphrodite' priest of the eastern sphere, 51, 123, 173, 200, 219, 224-225, 228, 244, 245, 274, 282-289, 292-293, notes 2 and 5 chapter IX.
- to burake tattiku'* (*burake tattiku'*), a priestess of the eastern sphere, 27, 78, 144, 214, 218, 219, 228, 274, 282-289, 292-293.
- To di'paulunna Sangalla', 'The one who is placed as the Head of Sangalla', a title in Sangalla', 87.
- To disulu Tedong, 'The Space under the House for Buffaloes', a name for the region of Simbuang in Sangalla', 88.
- to dolo*, the Ancestors of the Southwest, 119, 124, 280.
- to goleanan*, the (souls of) lepers, 122.
- to indo'* (*to indo' padang*), the rice-priest, 52, 71, 72, 102, 167, 204, 205, 208, 209, 210, 246, 248, 251, 252, 269, 274, 279-280, 289, 291, note 3 chapter IX.
- To kalala', 'The Poor', a figure in myth, 162.
- To' Kamiri, a *sawah* in myth (Kesu'), 74, 153.
- To Kaubanan, 'He who has grey Hair' (Puang Matua), 119, 132, 139, 142, note 6 chapter VI.
- to kengkok*, 'folk with a tail', people living in the underworld, 111.
- to ma'dampi*, the medicine man, 274, 289-292.
- to ma'dika*, 'the free' (= *to parengnge'*), note 10 chapter III.
- to ma'gandang*, 'the one who beats the drum', a priest, 27, 144, 274.
- to makaka*, free people, free farmers, a class, 32, 44, 48, 52, 53, 55, 56, 72, 81, 90, 97, 104, 121, 124, 146, 150, 154, 186, 195, 214, 235, 260, notes 11 and 15 chapter III, note 17 chapter IV.
- to makaka direngnge'*, an intermediate class of low-ranking *to makaka*, a class between the *to parengnge'* and the *kau-nan*, 48, 49, 52, 53.
- to makaka kandeana*, 'the *to makaka* who have their own dishes', a high-ranking class of *to makaka*, 53.
- to ma'kayo* (= *to burake bombo*, *to mebalun*), the name of the death priest in the *puang*-realms, 214, 280.
- to manarang*, a carpenter, 249.
- to ma'nasu*, 'the one who cooks the meat' (of the sacrificed animal), a functionary in Kesu', 98.
- To Mangambo', 'The Sower', a deity, the

- god of smallpox, 127.
- to mangrande londong*, 'the one who holds the cock', a functionary in a *merok*-feast, 205.
- to mano'bo*, a person functioning in a house-building ritual, 249.
- to manobok*, 'the one who slays the kerbau with a lance at the *merok*-feast', a functionary in Kesu', 67, 98, 103.
- to mantobok*, a functionary who kills the animal used as an offering in a ritual, 252.
- to manurun*, an ancestor who descended from heaven to live on earth, 18, 23, 32, 51, 78, 111, 117, 123, 124, 146, 152, 192, 256.
- to ma'randing*, war dancers, 195.
- to massadi*, 'the one who cuts the meat of the sacrificed *kerbau* into pieces', a functionary in Kesu', 98.
- to massanduk*, 'the one who serves out the rice', a functionary in Kesu', 98, 103, 249, 252, 281.
- to matua*, 'the old ones', the ancestors of the Southwest, 114, 115, 119, 121, 124, 125, 252, 274.
- tombang*, a sacrifice brought upon the occasion of a divorce, 53.
- tombi*, banners, 193, 194, 250, 257, 261.
- to mebalun*, 'the one who wraps' (the body), the death priest, 51, 52, 274, 278, 280-282.
- to menani*, a priest who wears (imitation) buffalo-horns at the *lapa'-padang* feast, 196, 274, 279.
- to mentuyo*, suicides, 122.
- to minaa*, a category of priests, 13, 17, 47, 51, 52, 71, 76, 81, 103, 115, 128, 137, 138, 139, 144, 157, 193, 199, 214, 224, 247, 248, 258, 266, 269, 270, 274, 275-279, 289, notes 1 and 2 chapter IX.
- tondok*, a village, 92-94.
- Tondok Lepongan Bulan, 'Land forming one whole round like the Moon', the name of the league fighting Arung Palaka, 62.
- Tondon, a district, a *lembang*, 20, 65.
- Tonggo, 'The Very God', a figure in myth, 162.
- Tonglolangi', an ancestor in Kesu', 32.
- tongkon*, to sit, 231.
- tongkonan*, important house, family center, center of a (sub)ramage, 19, 22-28, 41, 48, 49, 53, 57, 59, 64, 65, 66, 67, 69, 72, 74, 75, 76, 80, 81, 82, 84, 85, 86, 87, 88, 93, 96, 99, 100, 101, 102, 103, 118, 119, 140, 148, 193, 194, 199, 203, 205, 210, 211, 215, 216, 220, 221, 231-252, 254, 256, 261, 279, note 15 chapter IV, notes 2 and 10 chapter IX.
- Tongkonan A'pa', 'The Four Tongkonan', a kind of council in Pantilang, 69.
- Tongkonan Basse Tiropadang, a functionary in Buntao', 71.
- tongkonan layuk*, an important *tongkonan*, 55, 86, 148.
- tongle-tongle*, a big tree, 227.
- Tonglo Sugi', 'The Exceedingly Rich One' (= Deatanna), note 29 chapter VI.
- to pabalian*, the helper (of a priest or another person) who functions in a ritual, 252.
- To Paragusi, a dangerous spirit, 126-127.
- to parengnge'*, a rank of important people, nobility, 38, 48, 49, 50, 53, 54, 55, 56, 57, 63, 65, 68, 69, 71, 72, 96, 103, 203, 204, 205, 208, 209, 210, 254, 260, 274, 275, 277, 278, notes 20 and 22 chapter IV.
- to parengnge' aluk rampe matallo* = *to parengnge'*, 50, 57.
- to parengnge' aluk rampe matampu'*, 'the *to parengnge'* of the ritual of the West', the death priest, 50.
- to pongmasa'ga*, 1) 'the powerful one' (= the village head), 97; 2) a leader of the resistance against the Dutch, note 19 chapter IV.
- to ponto litakan*, 'the one who wears a bracelet of clay', a poetic name for a slave, note 3 chapter III.
- Toraja, a collective name for all people who inhabit the mountains of Southwestern and Central Sulawesi, 6, 8.
- Torajang, 'The People from the West', a name given to the Sa'dan-Toraja by the Buginese, 6.
- tora-tora*, a necklace made of crocodile teeth, with the fangs of a wild boar suspended in the front, 195.
- To-ri-aja, 'The People of the Interior, the People of the Highlands', 6.
- To Sopai, the deity of Mount Sopai, 116, 126, 219,
- to sugi'*, the wealthy, 57.
- to sumomba*, the helpers (= *petulak*),

68.
 To Tiboyon, the goddess or goddesses who promote(s) the growth of the rice (*Mamasa*), 121, note 11 chapter V.
to tumbang, see *tumbang*.
to usserek daun punti, 'the one who tears the banana leaves in which the offerings are set down', a functionary in Kesu', 98.
to ussomba tedong = *datu baine*, 98.
tuak, palm wine, 11, 206, 226.
tuang-tuang, a decoration used in a death ritual of the highest order, 259.
tulak, to support, 101, 197.
 Tulak Bala, 'The Supporter of the Dike', a title in the district of Balusu, 65.
tulak bala'kaan, 'the supporter of the *bula'kaan*, the name of a special buffalo in a death ritual of high order, 197, 198.
tulakna lamba', 'the supporter of the *lamba'*-tree', a functionary in Kesu', 103.
 Tulakpadang, see *Pong Tulakpadang*.
tulak somba, an important post which supports the roof of an important *tongkonan*, 194, 233, 234.
 Tulangdenna, see *Pong Tulangdenna*.
 Tulangdidi', a girl figuring in a myth, 136, 166-168, 171, 205, 224.
tumba', to leap, to jump up, note 11 chapter VI.
 Tumba', a word used as a prefix before a name, note 11 chapter VI.
 Tumba' Gantanan, 'She who leapt on dry Land', an ancestress, 25.
tumbang (*to tumbang*), 1) a woman who enters into a trance during the *maro*-ritual, 120, 140; 2) a girl or a woman who fulfils a ritual role in the great *bua'*-feast, 137, note 11 chapter VI.
tungara, a particular position of a reed used in divination, 275.
tutungan bia', 'those who light the torches', a set of functionaries in Buntao', 72.
tuyu, a kind of bulrush, 122, note 9 chapter III.
 Ua Saruran, a resistance leader in Tana Toraja, 9.
ubi (Indon.), yam, 135, note 8 chapter VI, note 29 chapter VII.
uki', see *pio uki'*.
ukku', the cry of a newborn infant, 136.
ulelean, tales, 161-162, note 2 chapter VI.
ulu, head, 185.
ulu', sibling, 29.
ulunna langi, 'head of the upperworld', zenith, 110, 131, 140, 141.
 Ulusalu (Ulu Salu), a *lembang*, 20, 66.
umpabendan a'riri posi' (= *umpatama a'riri posi'*), 'to erect the central post', a rite associated with the building of a house, 232-234.
unbolloan pa'to', 'to drop rice which has already been boiled', a tresspass calling for the payment of *kapa'*, 36.
unnambo' balulang, 'to sow the shield', a rite, 276.
unrampanan doke biang, 'the releasing of a spear that resembles the *biang*-reed', a suspension of obligations in a death rite aimed at preventing a wealthy relative from taking advantage of the slaughtering of beasts in this ritual principally in order to be rewarded with land, 40.
untengkai susuk, 'going beyond the boundary posts', a tresspass calling for the payment of *kapa'*, 36.
 Untulak buntunna Bone, the battle against Bone, 76, 99.
unu', sibling, 29.
upas-tree (*upas*, Indon.), *Antiaris toxicaria* Lesch., a poisonous tree, used for making poison, 117, 136, 139, 227.
upe, a kind of taro or *Arum*, 251.
uran-uran, 'raindrops', the name of a chicken with certain markings suggestive of colouring by raindrops, 209.
 Usuk Sangbamban, 'From one Rib', a god created from Gauntikembong's rib, 132, 135, 136.
wurake, see *to burake*.

BIBLIOGRAPHY

List of literature consulted but not explicitly mentioned in the text

Chapter I

- I.2. Abendanon, E. C., 1917/18; Kornrumpf, M., 1935; Kruyt, A. C. and J., 1922.
- I.4. Koubi, J., 1972; Mills, R. F., 1975.
- I.5. Pol, H., 1941; Van der Veen, H., 1940a.
- I.6. Paerels, B. H., 1927 and 1945; Jacobs, Y. 1971.

Chapter II

- II.1. Dijk, W. van, 1939.
- II.1-5 Ihromi, T. O., 1975 and 1978; Josselin de Jong, J. P. B. de, 1952; Schmitz, C., 1964.

Chapter III

- III.1.1-1.2 Lanting, H. Th., 1926; Pronk, L., 1935; Seinstra, G., 1940.

Chapter IV

- IV.1.1-1.7 Crystal, E., 1964; Lanting, H. Th., 1926; Pronk, L., 1935; Seinstra, G., 1940.

Chapter VI

- VI.1.3. Prins, D. C., 1922/23.
- VI.2.1. Prins, D. C., 1921/22.
- VI.4. Prins, D. C., 1922/23a; Van der Veen, H., 1940a.

Chapter VIII

- VIII.1.3. Hoop, A. N. J. Th. à van der, 1949; Walcheren, P. M. van, 1971.
- VIII.3.4. Nouhuys, J. W. van, 1925/26.
- VIII.4. Keers, 1939.
- VIII.6. Chang, Kwang-Chih, 1959; Heekeren, H. R. van, 1958; Heine Geldern, R., 1928, 1932, 1945; Perry 1921; Riesenfeld, 1950.

Chapter IX

- IX.1-7 Belo, J., 1949 and 1960; Wulfften-Palthe, P. M. van, 1940.

List of abbreviations used in the bibliography

<i>A</i>	<i>Anthropos</i> , Salzburg.
<i>AdV</i>	<i>Alle den Volcke</i> , Maandblad van de Gereformeerde Zendingsbond ('All the People' [Luk. 2 : 10], Monthly of the Reformed Mission League [of the Dutch Reformed Church]).
<i>BKI</i>	<i>Bijdragen van het Koninklijk Instituut voor Taal-, Land- en Volkenkunde</i> (Contributions of the Royal Institute of Linguistics and Anthropology), The Hague: Martinus Nijhoff.
Handboekerij RTI	Afdelingsbibliotheek Sociaal Wetenschappelijk Onderzoek Koninklijk Instituut voor de Tropen (Library of the Department of Social Research of the Royal Tropical Institute), Amsterdam.
<i>I</i>	<i>Indië</i> , geïllustreerd Weekblad (The Netherlands Indies, Illustrated Weekly).
<i>IAE</i>	<i>Internationales Archiv für Ethnographie</i> (International Archives of Ethnography), Leiden.
<i>KIM</i>	Koninklijk Instituut voor Taal-, Land- en Volkenkunde, afd. Handschriften (Royal Institute of Linguistics and Anthropology, Manuscript Section), Leiden.
<i>KIT</i>	Koninklijk Instituut voor de Tropen (Royal Tropical Institute), Amsterdam.
<i>KITLV</i>	Koninklijk Instituut voor Taal-, Land- en Volkenkunde (Royal Institute of Linguistics and Anthropology), Leiden.
<i>Madjalah</i>	See <i>TBG</i> .
<i>MNZ</i>	<i>Mededeelingen vanwege het Nederlandsche Zendelinggenootschap</i> (Communications by the Netherlands Missionary Society).
<i>MTZW</i>	<i>Mededeelingen, Tijdschrift voor Zendingwetenschap</i> (Communications, Journal of Missionary Science).
<i>NION</i>	<i>Nederlandsch-Indië, Oud en Nieuw</i> (Dutch East Indies, Old and New).
<i>TBG</i>	<i>Tijdschrift voor Indische Taal-, Land- en Volkenkunde</i> van het Bataviaasch Genootschap van Kunsten en Wetenschappen (The Batavia Society Journal of Indonesian Linguistics and Anthropology), continued as <i>Madjalah untuk Ilmu Bahasa, Ilmu Bumi dan Kebudajaan</i> , Batavia (Jakarta).
<i>TNAG</i>	<i>Tijdschrift van het Koninklijk Nederlandsch Aardrijkskundig Genootschap</i> (Journal of the Royal Netherlands Geographical Society), Amsterdam, Utrecht, Leiden.
<i>VBG</i>	<i>Verhandelingen van het Bataviaasch Genootschap van Kunsten en Wetenschappen</i> (Transactions of the Batavia Society of Arts and Sciences), Batavia.
<i>VKI</i>	Verhandelingen van het Koninklijk Instituut voor Taal-, Land- en Volkenkunde (Transactions of the Royal Institute of Linguistics and Anthropology), The Hague.
<i>VMKAW</i>	<i>Verslagen en Mededeelingen der Koninklijke Nederlandse Akademie van Wetenschappen</i> (Reports and Communications of the Royal Netherlands Academy of Sciences), Amsterdam.

Selected bibliography to volume I

- Abendanon, E. C.
1917/18 *Midden-Celebes expeditie*, 3 vols, Leiden.
- Adriani, N.
1930 'Zijn de Sa'dangers Toradjas?', *Adatrechtbundel* 33: 39.
1932 'De Indonesische Priestertaal', *Verzamelde Geschriften* III: 7-22, Haarlem.
1932 'De Toradjasche vrouw als priesteres', *Verzamelde Geschriften* I: 190-216, Haarlem.
- Adriani, N. and Alb. C. Kruyt
1912/14 *De Bare'e-sprekende Toradja's van Midden-Celebes*, 3 vols. + vol. Illustrations, Batavia. (2nd ed. 1950/51, Amsterdam).
- Adriani, N. and A. A. van de Loosdrecht
1914 'Het verhaal van Pano Boelaan', *MNZ* 58: 224-244.
- Adriani, N., A. A. van de Loosdrecht and H. van der Veen
1916 'Sa'danse Volksverhalen', *MTZW* 60: 270 and 371.
- Andi Lolo, G. K.
1969 'Semba', olah Raga adu kaki specifiek Toraja', *Bingkisan* 3: 76-101, Macassar.
- Anonymous
1906 'De inneming van Bontoe-Batoe', (door een ooggetuige), *Eigen Haard*: 661-663, 686-688, 698-702 and 718-719, Amsterdam.
- Anonymous
1909 'Krijgsgeschiedenis van Celebes; De bestorming van Lalilondon', *Indisch Militair Tijdschrift*: 510-514, Batavia.
- Atlas*
1938 *Atlas van Tropisch Nederland*, The Hague.
- Baal, J. van
1947 *Over wegen en drijfveren der religie. Een godsdienstpsychologische Studie*, Amsterdam.
1971 *Symbols for Communication*, Assen.
1972 'De kleine Wereld: Dorp in de Tropen', *De Gids*: 306-316.
1976 'Offering, Sacrifice and Gift', *Numen* 23: 161-178.
- Belksma, J.
1918 'Een Toradja huwelijk', *AdV* 12: 90-94.
- Belksma, J.
1923-24 'Verbodsbepalingen bij de Toradja's', *AdV* 1923: 111ff, 125ff; 1924: 5ff, 15 ff.
1924 'The Sa'dan-Toradjas in the Island of Celebes', *Inter Ocean* 5: 327.
1940 'De Adat der Sa'dan-Toradja's', in: *Om te Gedenken, 25 jaar Zendingsarbeid van de GZB onder de Sa'dan-Toradja's van Zuid-Midden-Celebes*, pp. 25-34, Delft.
- Belo, Jane
1949 *Bali; Rangda and Barong*, Monographs of the American Ethnological Society 16, New York.
1960 *Trance in Bali* (with a preface by Margaret Mead), New York.
- Benedict, Ruth
1934 *Patterns of Culture*, New York.

- Bikker, A.
 1930 'Enkele ethnografische mededeelingen over de Mamasa-Toradja's', *TBG* 70: 348-378.
 1932 'Een en ander over het ontstaan der districten in de Onderafdeeling Boven-Binoeang', *TBG* 72: 759-766.
- Bodrogi, Tibor
 1970 'Beiträge zu den Bestattungsbräuchen der Sa'dang-Toradja (Zentral-Celebes)', *Scientiarum Hungaricae* 19: 21-38, Budapest.
- Braam Morris, D. F. van
 1889 'Het landschap Loehoe', *TBG* 32: 498-556.
- Braasem, W. A.
 1949 'De twist tussen Si Sang Maima en Datoe Daloe', *Oriëntatie* 16: 30-47.
- Brouwer, G.
 1916 'Het To Maro feest onder de Toradjas', *De Macedoniër*: 65ff.
- Bulo, J. S.
 1970 *Hukum perkawinan (rampanan kapa')* menurut adat Toraja Sa'dan (stencilled report), Hasanuddin University, Ujung Pandang.
- Camerling, H.
 1928 *Ueber den Ahnenkult in Hinterindien und den grossen Sunda-Inseln*, Amsterdam.
- Chabot, H. Th.
 1950 *Verwantschap, stand en sexe in Zuid-Celebes*, Jakarta.
- Chang, Kwang-Chih
 1959 'A working hypothesis for the early cultural history of South China', *Bulletin of the Institute of Ethnology, Academica Sinica* 7: 75-103.
- Crystal, Eric
 1964 *Toradja Town*, (Dissertation), Berkeley: University of California Press.
 1972 'A death in the tribe', *Oriëntations* 7: 28-32.
 1973 'Ritual of Renewal', *Oriëntations* 4: 26-32.
 1974 'Cooking pot politics: a Toraja village study', *Indonesia* 18: 118-152.
 1974a 'Man and the Menhir; Contemporary megalithic practice of the Sa'dan Toraja of Sulawesi, Indonesia', *Monograph IV. Archaeological survey*, Institute of Archaeology: 117-125, Los Angeles: University of California.
 1976 'Ceremonies of the ancestors', *Pacific discovery*, California Academy of Sciences 29: 9-19.
- Delsman, H. C.
 1951 *Dierenleven in Indonesië*, 's-Gravenhage-Bandung.
- Dirks, A.
 1938 *Memorie van Overgave van het bestuur van de afdeeling Loewoe van den aftredenden Asistent-resident van Loewoe* (unpublished report), Handboekerij RTI, Amsterdam.
- Downs, R. E.
 1955 'Head-hunting in Indonesia', *BKI* 111: 46-71.
- Dronkers, P. L. and B. Goris
 1953 See B. Goris and P. L. Dronkers.
- Dijk, W. van
 1939 'Het begrip Marapoe in West-Sumba', *BKI* 98: 497-517.
- Duyvendak, J. Ph.
 1940 *Inleiding tot de Ethnologie van de Indische Archipel*, Groningen-Batavia.

- Eliade, Mircea
1964 *Shamanism; Archaic Techniques of Ecstasy*, London.
- Evans-Pritchard, E. E.
1940 (1947) *The Nuer*, Oxford.
- Fahrenfort, J. J.
1943 'Over vrije en onvrije arbeid', *Mens en Maatschappij* 19: 29-51.
- Firth, Raymond
1957 'A note on descent groups in Polynesia', *Man* 57: 4-8.
- Fischer, H. Th.
1929 *Het heilig huwelijk van Hemel en Aarde*, Amsterdam.
- Flines E. W. van Orsoy de
1939 *Verslag omtrent een reis voor onderzoek en studie van de antieke uitheemse keramiek, voortkomende in Zuid- en Midden-Celebes van eind maart tot begin mei 1939* (unpublished report), Library of the Museum Pusat, Jakarta.
- Fox, Robin
1967 *Kinship and marriage*, Harmondsworth.
- Galestin, Th. P., L. Langewis and Rita Bolland
1956 See L. Langewis.
- Gerritsen, J.
1932 *Memorie van bestuursovergave van de onderafdeling Palopo, Palopo* (unpublished report), Handboekerij RTI, Amsterdam.
- Gervaise, Nicolas
1600 (1700) *Description historique du royaume de Macassar*, Paris, Ratisbonne (Regensburg), London.
- Gomes, E. H.
1911 *Seventeen years among the Sea Dyaks of Borneo; a record of intimate association with the natives of the Bornean jungles; and an introduction by J. Perham*, London.
- Goris, B. and P. L. Dronkers
1953 *Bali; Atlas Kebudajaan; Cults and Customs; Cultuurgeschiedenis in Beeld*, Jakarta.
- Goslings, J. F. W. L.
1928 'Verslag der Ethnologenbijeenkomst te Amsterdam (hierin wordt mededeling gedaan over de vondst van een bronzen bijl uit Rantepao)', *Mens en Maatschappij* 4: 287-288.
- Graaff, G. T. de
1936/37 *Memorie van Overgave van de onderafdeling Mamasa* (unpublished report), Handboekerij RTI, Amsterdam.
- Grader, C. J.
1937 'Tweedeling in het Oud Balische dorp', *Mededelingen van de Kirtija Lieftrinck-van der Tuuk*, Singaraja.
- Groeneveld, F. J.
1938 *Memorie van Overgave van de onderafdeling Palopo* (unpublished report), Handboekerij RTI, Amsterdam.
- Grubauer, A.
1923 *Celebes; Ethnologische Streifzüge in Südost- und Zentral-Celebes*, Hagen-Darmstadt.

- Harahap, Parada
1953 *Toradja*, Bandung-The Hague.
- Heekeren, H. R. van
1958 *The Bronze-Iron Age of Indonesia*, VKI 22, The Hague.
- Heine-Geldern, R.
1928 'Die Megalithen Südostasiens und ihre Bedeutung für die Klärung der Megalithenfrage in Europa und Polynesien', *A* 23: 276-315.
1932 'Urheimat und früheste Wanderungen der Austronesier', *A* 27: 543-619.
1945 'Prehistoric research in the Netherlands Indies', in: Pieter Honig and Frans Verdoorn (ed.), *Science and Scientists in the Netherlands Indies*, pp. 129-167, New York.
- Hoek, J.
1949 *Dajakpriesters*, Amsterdam.
- Holt, Claire
1939 *Dance Quest in Celebes*, Paris: Les archives internationales de la Danse.
1967 *Art in Indonesia; Continuities and change*, Ithaca-New York.
- Honig, Pieter and Frans Verdoorn
1945 See R. Heine-Geldern.
- Hoop, A. N. J. Thomassen à Thuessink van der
1949 *Indonesische Siermotieven, (Ragam-ragam Perhiasan Indonesia, Indonesian Ornamental Design)*, Bandung.
- Hunger, F. W. F.
1937 'Eenige aantekeningen over de Noord-Balische agadesa's Sidatapa en Pedawa', *Djawa* 17: 367-371.
- Ihromi, T. O.
1975 'Sistim kekerabatan pada suku Toraja Sa'dan', *Antropologi* 7: 2-18.
1978 *Adat Perkawinan Toraja Sa'dan dan Tempatnya dalam hukum positip masa kini (Suatu Studi Antropologi hukum)*, Jakarta.
- Josselin de Jong, J. P. B. de
1929 'De oorsprong van den goddelijken bedrieger', *VMKAW*, Afdeling Letterkunde, vol. 68, serie B, no. 1, Amsterdam.
1952 *Lévi-Strauss's theory on kinship and marriage*, Leiden.
- Kadang, K.
1960 *Ukiran rumah Toradja*, Jakarta.
- Kaudern, W.
1927 *Ethnographical studies in Celebes; results of the author's expedition to Celebes, Vol. III, Musical Instruments in Celebes*, Göteborg.
1930 *Ethnographical studies in Celebes, Vol. IV, Games and Dances in Celebes*, Göteborg.
1938 *Ethnographical studies in Celebes, Vol. V, Megalithic Finds in Central Celebes*, Göteborg.
1944 *Ethnographical studies in Celebes, Vol. VI, Art in Central Celebes*, (posthumous work ed. by Teres Kaudern and Henry Wassén), Göteborg.
- Keers, W.
1939 'Over de verschillende vormen van het bijzeten der doden bij de Sa'dan-Toradjas', *TNAG*: 207.
- Kennedy, Raymond
1953 *Field notes on Indonesia; South Celebes 1949-1950*, Human Relation Area Files, New Haven.

- Kern, R. A.
1939 *I La Galigo; Catalogus der Boegineesche tot de I La Galigo-cyclus behorende handschriften*, Leiden.
- Koentjaraningrat, R. M. (ed.)
1967 *Villages in Indonesia*, with contributions by P. R. Goethals, C. E. Cunningham, J. M. Hudson et al., Ithaca: Cornell University Press.
- Korn, V. E.
1932 *Het Adatrecht van Bali*, 2e ed., The Hague.
1933 *De Dorpsrepubliek Tenganan Pagringsingan*, Santpoort.
1960 'The Village Republic of Tenganan Pangeringsingan', in: *Bali, studies in Life, Thought and Ritual*, pp. 301-369, The Hague-Bandung.
- Kornrumpf, M.
1935 *Mensch und Landschaft auf Celebes*, Breslau.
- Koubi, Jeanine
1972 'Rapport de mission en pays de Toradja; (Août '71-Janvier '72), *Asie du Sud-Est et Monde Insulindien* (Centre de Documentation et de Recherche sur l'Asie du Sud-Est et le Monde Insulindien) 3: 77-100, Paris.
- Kreemer, J.
1956 *De karbouw; zijn betekenis voor de volken van de Indonesische Archipel*, The Hague-Bandung.
- Kruyt, A. C.
1920 'De To Rongkong in Midden-Celebes', *BKI* 76: 366-398.
1920 'De To Seko in Midden-Celebes', *BKI* 76: 398-431.
1922 'De Soembanezen', *BKI* 74: 233-260; 78: 466-608.
1923/24 'De Toradja's van de Sa'dan, Masoepoe- en Mamasa-rivieren', *TBG* 63: 81-175.
1935 'Het stamfeest op Midden-Celebes', *TBG* 75: 550-604.
- Kruyt, A. C. and N. Adriani
1912/14 See N. Adriani en Alb. C. Kruyt.
- Kruyt, A. C. and J. Kruyt
1922 'Een reis onder de Toradja's van Sa'dan en Mamasa (Celebes)', *TNAG* second series 49: 678-717.
- Kruyt, J.
1921 'De Boea' en eenige andere feesten der Toradja's van Rantepao en Makale', *TBG* 60: 45-77; 161-187.
- Kruyt, J. and A. C. Kruyt
1922 See A. C. Kruyt and J. Kruyt.
- Kuilman, L. W., K. van der Veer and G. J. van der Meulen
1946/50 See K. van der Veer, L. W. Kuilman and G. J. van der Meulen.
- Langewis, L.
1956 'Lamak, A woven Balinese Lamak', in: Th. P. Galestin, L. Langewis and Rita Bolland, *Lamak and Malat in Bali and A Sumba Loom*, Royal Tropical Institute CXIX, Department of Cultural and Physical Anthropology 53, Amsterdam.
- Lanting, H. Th.
1926 *Nota van den Controleur van Makale/Rantepao*, KIM, Leiden.
- Lévi-Strauss, Claude
1963 (1967) *Structural Anthropology*, New York.
1969 *The Raw and the Cooked*, New York.

- Loebèr, J. A.
 1915 *Geïllustreerde beschrijving van Indische Kunstnijverheid. Vol. VI, Leder- en perkamentwerk, schorsbereiding en aardewerk in Nederlandsch-Indië*, Koloniaal Instituut, Amsterdam.
- Loosdrecht, A. A. van de
 1921 'Onder de Toradja's van Rantepao', *MTZW*, pp. 131-153 (with notes of Dr. H. van der Veen).
- Loosdrecht, A. A. van de, and N. Adriani
 1914 See N. Adriani and A. A. van de Loosdrecht.
- Loosdrecht, A. A. van de, N. Adriani and H. van der Veen
 1916 See N. Adriani, A. A. van de Loosdrecht and H. van der Veen.
- Lijf, J. M. van
 1947/48 'Kentrekken en problemen van de geschiedenis der Sa'dan-Toradja landen', *Indonesië* I: 518-536.
 1951/52 'Tana Toradja 1905-1950', *Indonesië* V: 352-375.
- Mabuchi, Toichi
 1964 'Spiritual Predominance of the Sister', in: *Ryukyuan Culture and Society*, pp. 79-91. University of Hawaii Press.
- Mangemba, H. D.
 1956 *Kenallah Sulawesi Selatan*, Jakarta.
- Mansjur, Moh.
 1940 'Enkele bijzonderheden over de beoordeling en waardebeeping van de buffel door de Toradja', *Nederlandsch-Indische bladen voor Diergeneeskunde* vol. III, 1: 21-29.
- Matandung, Mangesu'
 1973 *Tinjauan selayang; Pasandak salu lako rampanan kapa' sebagai delik adat pada masyarakat Toraja Sa'dan, Ujung Pandang*, (stencilled report), Handboekerij RTI, Amsterdam.
- Matthes, B. F.
 1872 *Over de Bissoe's of Heidense Priesters en Priesteressen der Boegineezen*, Amsterdam.
- undated *Ethnographische Atlas; bevattende afbeeldingen van voorwerpen uit het leven en de huishouding der Boegineezen*, drawings by C. A. Schröder, S. Batelt and Nap Eylers.
- Mattulada et al.
 1979 See Nooy-Palm et al.
- Meulen, G. J. van der, K. van der Veer and L. W. Kuilman
 1946/50 See K. van der Veer, L. W. Kuilman and G. J. van der Meulen.
- Mevius, Johan
 1979 *Speciale catalogus van de Nederlandse munten van 1795 tot heden, met Ned. West-Indië, Suriname, Curaçao, Ned. Antillen*, 2nd ed., Amsterdam: Mevius Numisbooks Int.
- Mills, R. F.
 1975 'The Reconstruction of Proto-South-Sulawesi', *Archipel* 10: 205-225.
- Möller, A.
 1934 'Beitrag zur Beleuchtung des religiösen Lebens der Niasser', *IAE* 32: 121-166.

- Münsterberger, W.
1939 *Ethnologische Studien an indonesischen Schöpfungsmythen, ein Beitrag zur Kultur-Analyse Südasiens*, The Hague.
- Nobele, E. A. J.
1926 'Memorie van Overgave betreffende de Onderafdeeling Makale', *TBG*, vol. 60: 1-144.
- Noorduyn, J.
1955 *Een Achttiende-eeuwse kroniek van Wadjo'; Buginese historiografie*, The Hague.
- Noort, A. C.
1952 'De Mamasa-Toradja's', in: *Pergilah kamoe! Gaat dan heen! Geschiedenis van de buitenlandse Zending der Christelijk Gereformeerde Kerken in Nederland tot 1952*, pp. 58-73, Dordrecht.
- Nooy-Palm, C. H. M.
1972 'Southern Toradja' in: F. LeBar (ed.), *Ethnic Groups of Insular South-east Asia*, pp. 133-137, New Haven, HRAF.
1975 'Introduction to the Sa'dan Toraja People and their country', *Archipel* 10: 53-92.
1975a *De Karbouw en de Kandaure*, Catalogue of the Ethnografisch Museum Nusantara, Delft.
1976 'Toradja, Sulawesi', in: *Family of Man*, vol. 7, 90: 2499-2503, Marshall Cavendish Ltd., Radlett, Herts.
1978 'Bibliography; Survey of Studies on the Anthropology of Tana Toraja, Sulawesi', *Archipel* 15: 163-192.
- Nooy-Palm, Mattulada, Arianus Mandadung, Simon Petrus, Edward Poelinggomang, Sharya, Saraha, Johanis Lobo
1979 *The Sa'dan-Toraja in Ujung Pandang (Sulawesi, Indonesia). A migration study*. KIT, Amsterdam - Universitas Hasanuddin, Ujung Pandang.
- Nouhuys, J. W. van
1925/26 'Was-batik in Midden-Celebes', *NION* 6: 237-244.
- Ossenbruggen, F. D. E. van
1917 'De oorsprong van het Javaansche begrip Montjâ-pat in verband met primitieve classificaties', *VMKAW, Afdeling Letterkunde*, 5de reeks, deel III, Amsterdam.
- Paerels, B. H.
1927 'Agronomische beschrijving van de koffiecultuur in de Zuidelijke Toradjalanden', *Mededeelingen van de Afdeling Landbouw*, no. 11, Weltevreden.
1949 'Bevolkingskoffiecultuur', in: C. J. J. van Hall and C. van der Koppel (ed.), *De landbouw in den Indischen Archipel*, IIB: 100-109, The Hague.
- Pakan, L.
1972 See J. Tammu and H. van der Veen.
1973 *Rahasia Ukiran Toradja; The secret of typical Toradja patterns*, Ujung Pandang.
- Perry, W.
1921 *The Children of the Sun*, London.
- Pires, T.
1944 *The Suma Oriental of Tomé Pires and the Book of Francisco Rodrigues*, The Hakluyt Society, second series, LXXXIX, XC, London. Vol. 1:

The Suma Oriental of Tomé Pires, an account of the East from the Red Sea to Japan, written in Malacca and India in 1512-1515.

Pol, H.

[1941] 'Geschiedenis van Loewoe', in: *Om te Gedenken; 25 jaar Zendingsarbeid van de GZB onder de Sa'dan-Toradja's van Zuid-Midden-Celebes*, pp. 121-141, Delft.

[ca. 1948] *De Zending en de Sa'dan Toradja's*, Huizen, N.-H.

1963 'Roera en Golgotha', *AdV*, pp. 23-35.

Prins, D. C.

1921/22 'Het Verhaal van de onsterfelijkheid en afkomst van de Toradjavorst van Makale', *I* 5: 781.

1921/22a 'Het To-Marro-Marofeest', *I* 5: 756.

1922/23 'Oud Verhaal der Toradja's over de Verwoesting van 't dorp Roera', *I* 6: 269.

192/23a 'De Geschiedenis van Pong Boeloe Pala', *I* 6: 371.

Pronk, L.

1935 *Memorie van Overgave van de onderafdeling Palopo* (stencilled report), Handboekerij RTI, Amsterdam.

Radjab, M.

1950 *Dongengan Sulawesi Selatan*, Jakarta.

1952 *Toradja Sa'dan*, Jakarta.

Rassers, W. H.

1959 *Pañji, The Culture Hero*, Translation Series 3, KITLV, The Hague.

Riesenfeld, A.

1950 *The megalithic culture of Melanesia*, Leiden.

Rijn, A. P. van

1902 'De tocht naar de boven-Sadang', *TNAG* 2nd series XIX-1: 328-372.

Salombé, C.

1975 'Une version orale du Mythe de Sawérigadeng recueillie à Kandora, Méngkédek, Pays Toraja', *Archipel* 10: 269-289.

Sarasin, Paul and Fritz

1905 *Reisen in Celebes*, Vol. II, Wiesbaden.

Sarira, J. A.

1972 *Sebuah negeri diatas gunung*, Stencilled report published by the Toraja Church, Rantepao.

Schärer, H.

1946 *Die Gottesidee der Ngadju Dajak in Süd-Borneo*, Leiden.

Schmitz, Carl

1964 'Grundformen der Verwandtschaft', *Basler Beiträge zur Geographie und Ethnologie*; Ethnologische Reihe, Heft 1, Basel.

Schulte Nordholt, H. G.

1971 *The Political System of the Atoni of Timor*, VKI 60, The Hague.

Seinstra, G.

1940 *Memorie van overgave betreffende de onderafdelingen Makale en Rantepao* (unpublished report), Handboekerij RTI, Amsterdam.

Siregar, M. G.

1965 'Sedikit tentang pemotongan hewan di Tana Toradja', *Madjalah Universitas Hasanuddin* 16-17: 24-29.

- Stegeman, B. J. and G. A. Tideman
1933 See G. A. Tideman.
- Stöhr, W. and P. Zoetmulder
1965 'Die Religionen der Altvölker Indonesiens und der Philippinen', in: Waldemar Stöhr and Piet Zoetmulder (ed.), *Die Religionen Indonesiens*, pp. 1-223, Stuttgart.
- Suzuki, P.
1955 *The Religious System and Culture of Nias, Indonesia*, The Hague.
- Tammu, J. and H. van der Veen
1972 *Kamus Toradja Indonesia* (with the assistance of L. Pakan), Jajasan Perguruan Kristen Toradja, Rantepao.
- Tandilangi', Puang Paliwan
1967 'Datu Laukku' dan Pong Mula Tau', *Bingkisan* I-21: 21-37, Yayasan Kebudayaan Sulawesi dan Tenggara, Macassar.
1967a 'Pong Mulatau muntjul diatas Bumi', *Bingkisan* I-22: 29-40.
1967b 'Puang Tamboro Langi' membawa sukaran aluk sanda saratu', *Bingkisan* I-5: 23-32, Macassar.
1968 'Pembahagian Sukaran aluk', *Bingkisan* I-6: 33-35, Macassar.
1968a 'Tananan Basse', *Bingkisan* I-12: 23.
1969 'Rapasan doan', *Bingkisan* II-6: 2-16, Macassar.
1975 'Les tongkonan, maisons d'origine des Toraja', *Archipel* 10: 93-105.
This article is an abbreviated version of his article in *Bingkisan* I-5: 32ff., *Bingkisan* I-8: 17ff. (1968) and *Bingkisan* I-10: 20 (1968) Mem-perkenalkan Tongkonan.
- Tangdilintin, L. T.
1975 *Toraja dan Kebudayaanannya*, Tana Toraja.
1975a *Toraja, an introduction to an unique culture*, Rantepao - Ujung Pandang.
1976 *Tongkonan dengan seni dan Konstruksinya*, Tana Toraja.
- Tideman, G. A. and B. J. Stegeman
1933 'Gegevens over Land en Volk van Enrekang', in: *Mededeeling no. 6 van het Encyclopaedisch Bureau van de Koninklijke Vereeniging "Koloniaal Instituut"*, Amsterdam.
- Toradjagebied*
1939 'Ethnografische gegevens betreffende het Toradjagebied', *Adatrecht-bundel* 31: 103.
- Veen, H. van der
1924 'De Priesters en Priesteressen bij de Sa'dan-Toradja's', *TBG* 63, 374-401.
1924a 'Aanteekeningen bij het artikel van A. C. Kruyt 1923/24', *TBG* 63: 356-368.
1924b 'Aanteekeningen van Dr. H. van der Veen over blaasroer, schild en pijl en boog bij de Sa'dan- en Binoeang-Toradja's', *TBG* 63: 368-373.
1924c 'Sa'dan-Toradja'sche Volksverhalen', *VBG* 65, 2nd part: 32.
1929 'Nota betreffende de grenzen van de Sa'danse taalgroep en het haar aanverwante taalgebied', *TBG* 69: 50-97.
1929a 'Een Wichel-litanie der Sa'dan-Toradja's', in: *Feestbundel Koninklijk Bataviaasch Genootschap van Kunsten en Wetenschappen*, pp. 396-411, Batavia.
1940 *Tae' (Zuid-Toradjasch)-Nederlandsch Woordenboek*, KITLV, The Hague.
1940a 'Voorheen en thans', in: *Om te Gedenken, 25 jaar Zendingsarbeid van den GZB onder de Sa'dan-Toradja's, Zuid-Midden-Celebes*, pp. 35-54, Delft.

- 1950 'De Samenspraak der beide priesters, de woordvoerders van bruid en bruidegom bij de huwelijksplechtigheid der Sa'dan-Toradja's', *Bingkisan Budi*: 291-306.
- 1965 *The Merok Feast of the Sa'dan-Toradja*, VKI 45, The Hague.
- 1966 *The Sa'dan-Toradja Chant for the Deceased*, VKI 49, The Hague.
- 1976 'Ossoran tempon daomai Langi' (Overleveringen van den Beginne vanuit de hemel, in geregelde volgorde meegedeeld, door Ne' Mani, priester uit Sereale - landschap Tikala)', *BKI* 132: 418-438.
- 1979 *Overleveringen en zangen der Zuid-Toradja's*, VKI 85, The Hague.
- Veen, H. van der, N. Adriani and A. A. van de Loosdrecht
1916 See N. Adriani, A. A. van de Loosdrecht and H. van der Veen.
- Veen, H. van der and J. Tammu
1972 See J. Tammu and H. van der Veen.
- Veer, K. van der, L. W. Kuilman and G. J. van der Meulen
1946/50 'Rijst', in: C. J. J. van Hall and C. van der Koppel (ed.), *De landbouw in den Indischen Archipel*, Vol. II A, pp. 7-112, The Hague.
- Verdoorn, Frans en Pieter Honig
1945 See R. Heine-Geldern.
- Villages in Indonesia*
1967 See R. M. Koentjaraningrat (ed.).
- Walcheren, P. M. van
1971 'Ornamentiek bij de Toradja's', *NION* 1: 147.
- Wertheim, W. F.
1964 'Society as a composite of conflicting systems', in: *East-West Parallels, sociological approaches to modern Asia*, pp. 21-37, Deventer.
- Wilcox, Harry
1949 *White Stranger*, London.
- Wulfften-Palthe, P. M. van
1940 'Over Trance', *Geneeskundig Tijdschrift voor Ned-Indië*, 36-80: 2123-2153.
- Yacobs, Yan
1971 *Data-data perekonomian sosial, wilayah BRI Tjabang Makale*, stencilled report Bank Rakjat Indonesia, Kantor Tjabang Makale.
- Zoetmulder, P. and W. Stöhr
1965 See W. Stöhr and P. Zoetmulder.

For a detailed and annotated bibliography on the Sa'dan-Toraja, see Nooy-Palm, 'Bibliography; Survey of Studies on the Anthropology of Tana Toraja, Sulawesi', *Archipel* 15: 163-192.



Mount Bamba Puang between Enrekang and Kalosi.
(Photo F. van der Kooi, 1937)



The limestone formation of Mount Sarira, with in the foreground sawahs near Tadongkon (district of Kesu').
(Photo F. van der Kooi, 1937)



Mount Sesean (district of Tikala).
(Photo F. van der Kooi, 1937)



Tongkonan in Tadongkon (district of Kesu').
(Photo F. van der Kooi, 1937)



Buffalo head (*pa'tedong*) carved in bas-relief and painted in polychrome (black, white, orange-red and yellow) on the door of an *alang* (rice barn) in Tikala. Like many other buffalo heads in Tana Toraja, this one seems to have a double pair of horns. The motif on top of the head is probably a stylized tree of life. Unlike other *pa'tedong* in Tana Toraja, this one has an ornamental motif between the eyes. The same rhomb is also found on masks in the Hindu culture of Bali, Java, Farther India and Tibet. In conception the Tikala buffalo heads are different from and more dynamic than those of Kesu'.

(Photo R. Schefold)



Tangke rapa': leaf stalks in close configuration.



Pa'daun bolu: figures representing betel leaves (Piper betel).



Pa'bulu londong: the cock feather motif, also found on ancient coffins.



Pa'bungkang tasik: the lobster or sea crab; this motif differs from the *bung-kang-bungkang* displayed during a mortuary ritual of high order.



Pa'kapu' baka: representing a tightly woven basket (*baka*) symbolizing the wealth of the ramage of the *tongkonan*.



Barana' rapa': close formation of leaves of the *Ficus religiosa*.



Old wood-carving, presumably the end-piece of one of the outer floor beams of a house, showing a snake carved in relief and along the right-hand edge the *pa'bulu londong*-motif (*bulu londong* = cock's feathers). (Collection Lembaga Kebudayaan Indonesia, Museum Pusat, Jakarta; inv. no. 23603)



**A wood-carver and his son in the village of Ba'tan (district of Kesu').
(Photo Hetty Nooy-Palm/Royal Tropical Institute, 1966)**



A young *bonga* in Kesu'. This type of buffalo is white with black spots. The spots are a symbol of wealth and prosperity.
(Photo Hetty Nooy-Palm/Royal Tropical Institute, 1966)



A cliff near Patui, in the vicinity of Sossok (Duri). The old coffins of the Duri people are stacked up on a ledge running the whole width of the wall.
(Photo F. van der Kooi, 1937)



The shelf with the coffins near Pasui, in the vicinity of Sossok.
(Photo F. van der Kooi, 1937)



Patane in Kalambe' (district of Tikala). This kind of memorial consists of a large boulder into which a cavity has been hewn as a depository for the remains of the deceased; the opening is then covered with a lid . Over the vault a house is erected in the shape of a Toraja dwelling in miniature. A *tau-tau* (effigy) is placed in this house.

(Photo F. van der Kooi, 1937)



Rocks tombs in the district of Tikala.

(Photo F. van der Kooi, 1937)



Rice barn in front of the house of Ne' Lai' Ambun, the mother of the former chief of Tadongkon. On the floor of this barn a *tau-tau* (wooden doll) is placed, which represents the deceased Ne' Lai' Ambun, a woman of noble birth. After some days this *tau-tau* will be carried to the *pantunuan*, the plaza where the buffaloes are slaughtered in honour of the deceased. (Photo F. van der Kooi, 1937)



A *to minaa* engaged in *rebongan didi* in the first phase of the mortuary feast of Puang Lasok Rinding of Sangalla' (1970). *Rebongan didi* means literally 'breaking sugar-palm leaf-ribs', but is generally used in the sense of 'enumerating the offenses of a person confessing his guilt' with the intercession of the *to minaa*. The *to minaa* may also use these sticks as a mnemonic aid in recitation of the genealogies and in enumerating the various *adat* acts to be performed, as in the case of Sangalla'.

(Photo Hetty Nooy-Palm/Royal Tropical Institute, 1970)



Dragging the *simbuang* for Ne' Lai' Ambun's mortuary ritual up a *sawah* embankment after crossing the *sawah*.
(Photos F. van der Kooi, 1937)





Tongkonan in the village of Tadongkon (district of Kesu').
(Photo F. van der Kooi, 1937)



**View of a village at the foot of Mount Sarira near
Lemo (district of Ma'kale).**
(Photo F. van der Kooi, 1937)



Pulling up the young rice plants (*bibit*) from the seedbeds for transplanting in the *sawah*, near Tadongkon (district of Kesu').
(Photo F. van der Kooi, 1937)



The market of Rantepao.
(Photo F. van der Kooi, 1937)



Rice barns of the late Rombelayuk in Kawassik (district of Nanggala).
(Photo F. van der Kooi, 1937)