

Matthijs J. Koornstra

.....

# *Changing Choices*

PSYCHOLOGICAL  
RELATIVITY  
THEORY

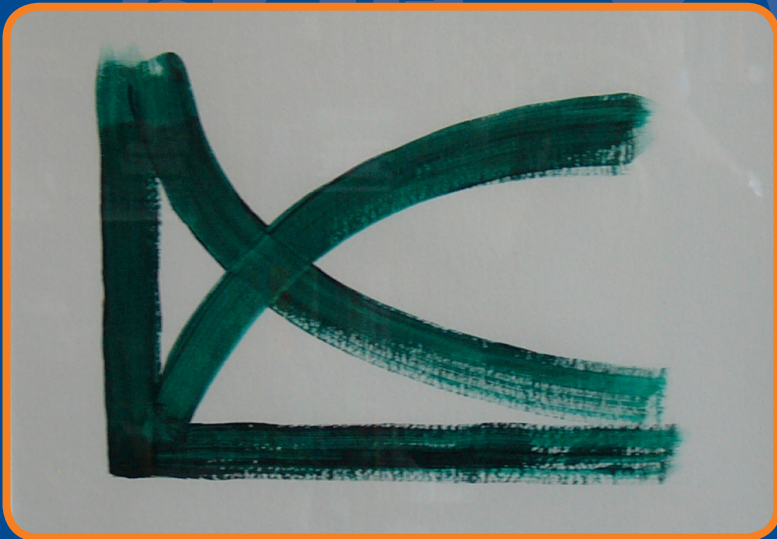

LEIDEN UNIVERSITY PRESS

CHANGING CHOICES  
Psychological Relativity Theory



**Leiden University Press**

Leiden University Press is an imprint of AmstenJam University Press

Cover illustration:

"I>K·PD" logo of: *D.D. Breimer Research Foundation*,  
designed by Jos van den Bmek, Leiden

Cover design: Randy Lemaire, Utrecht

ISBN 978 90 8728 018 5

NUR 770

© Leiden University Press, 2007

All rights reserved. Without limiting the rights under copyright reserved above, no part of this book may be reproduced, stored in or introduced into a retrieval system, or transmitted, in any form or by any means (electronic, mechanical, photocopying, recording or otherwise) without the written permission of both the copyright owner and the author of the book.

CHANGING CHOICES

Psychological Relativity Theory

**A mathematical theory and the multidimensional analyses of  
judgment, preference, risk behaviour, and choice dynamics**

Matthijs J. Koornstra



CONTENTS	page
PREFACE	vii
I. THE FOUNDATION OF CHOICE THEORY	1
1.1. Hedonistic roots of choice theory	3
1.2. Expected utility theory and level of aspiration	6
1.3. Foundations of Berlyne and Coombs revisited	14
1.4. Adaptation-level theory and properties for choice theory	20
1.5. Learning theory and properties for choice theory	28
1.6. Hedonic properties and function types of sensation scales	36
2. PSYCHOPHYSICAL RESPONSE AND VALENCE THEORY	47
2.1. Psychophysical scaling and response theory	49
2.2. Metric response and monotone valence functions	70
2.3. Metric single-peaked valence functions	78
2.4. Dynamics of judgment and choice	86
3. THE GEOMETRIES OF STIMULUS AND SENSATION SPACES	93
3.1. Metric psychological spaces and the stimulus geometry	95
3.2. The relationship between sensation and stimulus geometries	101
3.3. Stevens' psychophysics and Bower's stimulus coding theory	114
4. THE GEOMETRIES AND ANALYSES OF RESPONSE SPACES	129
4.1. Geometric relationships between sensation and response spaces	131
4.2. The involution geometries of open response spaces	141
4.3. Common object and individual response spaces	152
5. VALENCE SPACE GEOMETRIES AND PREFERENCE ANALYSES	169
5.1. Weighted involution geometries of monotone valence spaces	172
5.2. Open-hyperbolic or -Finsler geometries of single-peaked valence spaces	185
5.3. Open Finsler geometries of mixed valence spaces	200
5.4. Appropriate multidimensional analyses of preferences	203
6. MEASUREMENT-THEORETIC IMPLICATIONS	225
6.1. The significance of measurement theory	227
6.2. Measurement by isomorphic stimulus space transformations	275
7. PSYCHOLOGICAL RELATIVITY AND CHOICE DYNAMICS	301
7.1. Dynamic relativity in perception, cognition, and preference	303
7.2. Perception research and dynamic similarity relativity	325
7.3. Cognition research and dynamic similarity relativity	359
7.4. Preference research and dynamic preference relativity	371
8. CHOICE CONFLICTS AND DYNAMICS	399
8.1. Individual ambivalence and choice conflict dynamics	401
8.2. Time-dependent developments and collective adaptation	418
8.3. General theory of technological evolution and adaptation	437
RETROSPECTIVE SUMMARY	449
REFERENCES	457
AUTHOR INDEX	483
SUBJECT INDEX	489

*"And just as with food he does not seek simply the larger share and nothing else, but rather the most pleasant, so he seeks to enjoy not the longest period of time, but the most pleasant." .....*

*"For we recognize pleasure as the first good innate in us, and from pleasure we begin every act of choice and avoidance, and to pleasure we return again, using the feeling as the standard by which we judge every good. And since pleasure is the first good and natural to us, for this very reason we do not choose every pleasure, but sometimes we pass over many pleasures, when greater discomfort accrues to us as the result of them; and similarly we think many pains better than pleasures." .....*

*"Every pleasure then because of its natural kinship to us is a good, yet not every pleasure is to be chosen: even as every pain is an evil, yet not all are always of a nature to be avoided. Yet by a scale of comparison and by consideration of advantages and disadvantages we must form our judgement on all these matters. "*

Epicurus (341-270 BC). Letter to Menoeceus.

Citations from translation in: C. Bailey. ([ 926), *Epicurus. The Extant Remains*. Oxford Univ. Press. Oxford.

## PREFACE

The title "*Changing Choices*" of this monograph refers on the one hand to changed choices of geometries for the multidimensional analyses of judgmental and preferential choice data and on the other hand to dynamics of judgmental and preferential choice. The monograph contains a coherent theory of judgment, preference, risk decision, choice conflict, and their dynamics. As retrospectively discussed, the theory might potentially unify diverse domain theories in psychology, despite the specific and remote origin of the theory. Its origin lies in the analysis and modelling of road-user risks. In order to explain individual traffic-risk behaviour, we conceptually formulated the frame of reference theory of road-user risk in 1990. Now it is mathematically reformulated as the risk-adaptation theory in chapter 8. This traffic-risk theory is based on Helson's adaptation-level theory and on conflicting, single-peaked preference functions for traffic risks, whereby it describes an adaptively shifting indifference midrange of risks and increasingly negative risk evaluations below and above that indifference range. The mathematical formulation of that theory with a zero-valued risk-indifference range requires a grounded, metric specification of judgmental and preferential functions of stimulus dimensions with dynamic function parameters, because individual traffic behaviour is just an example of human perception, judgment, and behavioural choice dynamics. Motivated by the search for their metric foundation we have been able to derive these metric function and parameter specifications from an integration of existing theories in psychophysical, mathematical, and experimental psychology as well as learning, motivation, and preference theories.

In chapter 1 the historical background of choice theory in philosophy, psychology, and econometrics is discussed and further analysed in search of function properties that may specify a metric choice theory. The qualitative function requirements and some metric properties are mainly derived from adaptation-level theory and learning theory. As outlined in chapter 2, these function properties and some basics of psychophysics and response theory yield the necessary and sufficient conditions for a metric theory of unidimensional judgment and preference. In that chapter we specify the metric functions that transform stimulus scales to comparable sensation scales and comparable sensation scales to response scales for magnitude judgment and dissimilarity evaluation or to valence scales for (monotone or single-peaked) preference evaluation. In chapter 2, based on Bower's stimulus coding theory and Teghtsoonian's analyses of the relationships between Stevens' power exponent, the Weber fraction, and employed stimulus range, we derive weighted and translated Fechnerian sensation dimensions of intensity-comparable sensations that are invariant under linear transformation of their underlying Fechner dimensions. Their dimensional weighing and translation depend both on the adaptation level of Helson's adaptation-level theory, while the weighing and translation for valence-comparable sensations depend also on the ideal point of Coombs' unfolding theory. Exponential transformations of comparable sensations define distinctly power-raised stimulus fraction dimensions, whereby Stevens' power exponents of subjective stimulus magnitudes equal the weights of intensity-comparable sensation dimensions.



The multidimensional exposition is given in chapters 3, 4 and 5. In chapter 3 we determine the geometric relationship between stimulus and sensation spaces, where hyperbolic spaces of comparable sensations correspond to power-raised, Euclidean stimulus fraction spaces and flat spaces of comparable sensations to power-raised, non-Euclidean stimulus fraction spaces. Other stimulus geometries than Euclidean or non-Euclidean geometries are to be excluded by physical theory. It implies that Fechner's and Stevens' psychophysics are not contradictory, but only other geometric representations of the same. The derived response and valence functions of comparable sensation dimensions define metric space transformations of sensation spaces to response or valence spaces, whereby their permissible geometries also are determined. In chapter 4 it is shown that individual response spaces are open involution geometries of power-raised, Euclidean or non-Euclidean stimulus fraction geometries. Chapter 5 demonstrates that monotone valences are defined by an ideal axis in individual response spaces, while single-peaked valence spaces are open-hyperbolic, if the stimulus space is Euclidean, or are open Finsler geometries, if the stimulus geometry is non-Euclidean. The alternative transformations of stimulus or object-attribute spaces to response or valence spaces depend on the three alternative stimulus geometries (Euclidean, hyperbolic, or double-elliptic) and individual parameters, but all individual evaluation spaces yield (conditionally) rotation-invariant, open geometries. The distance metric of each open response geometry is the same as for the corresponding stimulus geometry, but only the open-hyperbolic geometry of single-peaked valences exhibits the same distance metric as their corresponding hyperbolic sensation spaces (if the stimulus space is Euclidean). The other two single-peaked valence spaces are open Finsler geometries that have absolute curvatures that decrease with increased distances to the ideal point, while they correspond to flat sensation spaces (if the stimulus space is non-Euclidean). The space transformations with individual parameters of the common object space to individually different, open response or valence spaces have far reaching consequences for the multidimensional analyses of (dis)similarities or preferences and for cognition and preference theory, because the existing multidimensional analyses generally assume an infinite and flat (Euclidean or Minkowskian) geometry. The psychological evaluation spaces of the common object space are open spaces that differ individually by finite projection transformations of individually weighted sensation spaces from individually different perspectives. Open response geometries also differ from the open geometries for single-peaked preferences. These open evaluation spaces are characterised on the one hand by common transformation types of a common object space, specifying the mathematical theory of human cognition and preference, and on the other hand by individual parameters for these transformations. Individual parameters represent meaningful individual differences and are solvable by inverse transformations of evaluation spaces from several individuals to a common Euclidean object space that is either the stimulus space or the logarithmic-transformed, non-Euclidean stimulus space as a Fechnerian sensation space. New methods for the multidimensional analyses of individual dissimilarity or preference data for each of the permissible response or valence geometries are described in chapters 4 and 5.

The reader may skip chapter 6 without loss of understanding, because in that chapter we only discuss as by-product of our theory the measurement-theoretical implications. It is shown that recent developments in axiomatic measurement theory (homogeneous measurement between singular points) are in line with the open measurement spaces of responses and valences. We compare axiomatic measurement theory with our substantive theory of metric-isomorphic stimulus space transformations that specify distinctly transformed-extensive measurements for subjective stimulus magnitudes, comparable sensations, responses, monotone valences, and single-peaked valences. It is argued that comparable sensation spaces exhibit a kind of dimensional invariance that is comparable to the dimensional invariance of physics, where the exponential transformations of comparable sensation spaces define distinctly power-raised stimulus fraction spaces (for subjective stimulus magnitudes) with rotational power-exponents. The metric transformations of comparable sensation spaces to open response or valence spaces specify metrically isomorphic response or valence measurements between a singular or distinct maximum and a singular minimum, which enables the meaningful formulation of quantitative theory for judgment and choice, in contrast to the interval scale measurement of multidimensional scaling or unfolding analyses of (dis)similarity and preference data.

In chapter 7 we describe the consequences of the adaptation-level dependence of perception, cognition, preference in order to specify the dynamic aspects of the presented theory and also compare our theory predictions with some empirical results in the psychological research literature. Our theory provides an insightful explanation and integrative theory of the differences between the optical and visual spaces by the dimensional adaptation-level dependence of the three-dimensional involution of the Euclidean optical space to the open-Euclidean response space of visual perception. Also the dynamic aspects of judgment and preference are caused by the dependence of individual adaptation levels on previous and ongoing stimulation and/or by the task- and context-dependent selection of cognitive reference levels from memory. The judgmental and preferential choice dynamics are mathematically specified and their predictions are compared with empirical research on: 1) multidimensional scaling (MDS) analyses of (dis)similarity data, 2) MDS-based models of confusion or categorisation probabilities, and 3) risky choice probability models. We show that intransitive and/or asymmetric (dis)similarities and intransitive preferences are explained and consistently predicted by stimulus- and/or task-dependent shifts of adaptation level. It specifies a dynamic relativity theory for perception, judgment, and preference. Also some empirical results from existing MDS-analyses in perception and cognition as well as several issues in perception and cognitive theory are shown to be blurred by methodological artifacts of existing MDS-analysis methods.

In chapter 8 intra-individual choice conflicts and dilemma behaviour are described as special cases of the general theory, while also some developmental and cultural phenomena are tentatively modelled by the psychophysical response and valence theory. It is predicted that actual preferences in reality are often not choices for cognitively most preferred objects, but will be choices for objects located between the adaptation point (representing what already is or can be easily realised) and the ideal point (representing what is cognitively most-preferred). Behavioural preferences in real

life are often of an intra-individually conflicting nature, where the ambivalence is caused by negative, monotone valences for costs and efforts of choice realisations and positive, single-peaked valences of cognitively preferred choices. Choice dilemmas from conflicting, single-peaked valences may also arise, if the attribute dimensions of choices are strongly dependent. An example of such conflicting, single-peaked valences is presented by the risk-adaptation theory of road user risks, wherein the combination of oppositely oriented, single-peaked valence functions derives from the stimulus environment of road users by the completely negative dependence between aversive sensations of crash, injury, and traffic-fine threats and satisfying sensations of arousal need, driving fun, and travel utility. It describes the dynamic risk behaviour of individual road users by a dynamically shifting indifference midrange of risks and increasingly negative risk valences outside that range. The risk-adaptation theory integrates three existing theories of traffic risks, while several observed traffic risk aspects and the exponential decay of collective traffic risks over time are only well explained and predicted by risk-adaptation theory. Moreover, models for the analysis of progressively changing choices over time, - according to our theory caused by time-dependent stimulus-exposure changes -, are presented and partially verified by the decay of collective traffic risks as function of time-dependent traffic growth. Lastly, based on a generalisation of the inherent dependence between traffic growth and adaptive decay of traffic risks and emission rates, we describe a general theory of technological evolution and adaptation in this chapter. The predicted long term developments of industrial growth and environmental pollution by that general theory markedly differ from the doom predictions by the politically influential, but questionable system models for world developments of industrial growth and environmental pollution.

It is tried to write this monograph for readers with a psychological, or econometric, or social science background. Some understanding of multidimensional scaling analysis methods and limited knowledge of mathematics is assumed, but no advanced knowledge of modern geometry. What the reader needs most is theoretical interest. The text would be considerably shortened by a theory exposition in mathematical propositions and theorems and by using differential geometry and advanced mathematics. But this monograph aims to be readable for other persons than mathematical psychologists. Therefore, most mathematics are given in segregated subsections that can be skipped without loss of understanding, since their main results are explained in the text and illustrated by graphics. Also the mathematical subsections are kept as simple as possible by only using hyperbolic, trigonometric, and simple functional expressions and some usual matrix algebra, asking for no more than undergraduate understanding of mathematics. Only some new or essential proofs are given, other relevant proofs are referenced. Literature references mainly are to authors of original research and theory contributions with significance for our theory. Since the reference list is already long, we refer not to related, empirical research that has no added value for our theory. Apart from some historically relevant, old references and several recent ones to handsome overviews and handbooks, the referenced literature predominately is from the second half of the 20<sup>th</sup> century, because only few recently published articles or books have additional relevance for our theory.

The basic theory chapters 1 to 5 were drafted between 1991 and 1995, Their first revision and draft chapter 6 on measurement-theoretical implications of the theory date respectively from 1996/97 and 1998/99. I have very much appreciated that everyone at SWOV (Institute for Road Safety Research, The Netherlands) was so kind to endure a somewhat absent-minded director during periods wherein I wrote these draft chapters. Draft chapters 7 and 8 on choice dynamics and theory applications were written between 2000 and 2003. I gratefully thank the Ministry of Transport in The Netherlands for financing the anticipatory research funds of SWAV, whereby also my earlier research for parts of chapter 8 (the modelling and data analyses of individual traffic risks, traffic growth, and national traffic risk developments) was financed. A first revision of the whole monograph was completed by July 2005 and its final revision by Dec. 2006. I thankfully recognise that many improvements are due to invaluable suggestions and inspiring-critical comments from R. Duncan Luce, University of California at Irvine, Jürgen Helber at the University of Tübingen, and three friends at Leiden University: Willem Albert Wilgenaar, John Michon, and last but not least Willem Heiser, who also suggested several mathematical improvements. Nonetheless, theoretical flaws and mathematical errors that might be still present are fully my responsibility. There are two persons to whom I am especially indebted. Firstly, without the lasting impact of John Van de Geer, by teaching me as student and coaching me as researcher at his Department of Data Theory of Leiden University, this monograph would not exist. His data-analytic research approach and critical attitude to psychological theory, motivated me - somewhat against the grain - to search for theoretically justified, metric transformations of stimulus spaces to psychological spaces that specify dimensional-invariant measurements and, thereby, allow the formulation of meaningful, quantitative theory in psychology. In the end it not only might provide a potentially unifying theory of psychophysics, judgment, and preference, but also a theoretical basis for the non-Euclidean similarity analysis that was initiated by John Van de Geer in the beginning seventies of the last century. Secondly, I am obliged to my research colleague and dear friend Siem Oppe, who encouraged the writing of this monograph by our discussions on psychological theory and traffic safety science. Thereby, he also triggered my formulations of the risk-adaptation theory and the general theory of technological evolution and adaptation.

Dec. 2006, Roelofarendsveen, The Netherlands

Matthijs J. Koornstra.



CHAPTER I  
THE FOUNDATION OF CHOICE THEORY

*"... where there is pleasure and pain there is necessarily also desire..."*

Aristotle. *De Anima*, [423b].

*"Pains are the correlatives of actions injurious to the organism, while pleasures are the correlatives of actions conducive to its welfare."*

Spencer, H. (1870). *Principles of psychology*. Vol. I. (p. 279). William and Norgate, London.

## CONTENT DETAILS CHAPTER I

	page
<b>1.1. Hedonistic roots of choice theory</b>	3
1.1.1. Ancient hedonism	3
1.1.2. Western revival of hedonism	4
1.1.3. Emerging scientific hedonism	4
<b>1.2. Expected utility theory and level of aspiration</b>	6
1.2.1. Econometric utility theory	6
1.2.2. Psychological valence and level of aspiration	7
1.2.3. Expected utility and level of aspiration	9
1.2.4. Single-peaked preference curves	12
<b>1.3. Foundations of Berlyne and Coombs revisited</b>	14
1.3.1. Berlyne's foundation	14
1.3.2. Coombs' foundation	16
1.3.3. The quest for grounded properties	19
<b>1.4. Adaptation-level theory and properties for choice theory</b>	20
1.4.1. Relativity of sensations	20
1.4.2. Ubiquity of adaptation level	22
1.4.3. Time frames of adaptation	24
1.4.4. Hedonic value properties from adaptation-level theory	26
<b>1.5. Learning theory and properties for choice theory</b>	28
1.5.1. Contiguity and reinforcement	29
1.5.2. Pleasantness and unpleasantness and two-process learning theory	32
1.5.3. Hedonic value properties from learning theory	34
<b>1.6. Hedonic properties and function types of sensation scales</b>	36
1.6.1. Congenital adaptation and saturation or deprivation	36
1.6.2. Cognitive saturation and deprivation	41
1.6.3. Sensation dimensions and their hedonic value functions	44

## 1.1. Hedonistic roots of choice theory

Actions of man can be seen as approach or avoidance behaviour, based on judgmental and preferential choices for action. These actions are conceived as responses to external stimuli and/or internally produced sensations. But without the necessary and sufficient principles that describe and explain the differences between individual behaviours in identical stimulus situations no theory in psychology can predict behaviour. Such a theory asks at least that gaps between behaviour and cognition theories in psychology are bridged. This study attempts to provide that bridge by the psychophysical response and valence theory of this monograph. Psychophysics, adaptation-level theory, learning and behaviour theory, utility and subjective expected utility theories, response theory, and unfolding theory provide the cornerstones for this integrated theory of judgmental and preferential choice, but its roots are found in ancient hedonistic philosophy and in the psychology of pleasantness and unpleasantness from before World War II.

### 1.1.1. *Ancient hedonism*

The Greek philosopher Aristippos of Cyrene, pupil of Socrates and founder of the Cyrenic school (about 435 to 270 BC), is the oldest source referring to pleasantness as the aim of life. According to Aristippos, perception and knowledge can be misleading; the only thing we can be sure of are our own feelings. Therefore, the mind must guide us to find optimal pleasantness as the only real value in life (Mannebach, 1961). Cyrenic philosophy is the forerunner of the more refined hedonistic ethics of Epicurean philosophy. The Epicurean school, founded by Epicurus (341-270 BC), existed into the 1<sup>st</sup> century BC with Lucretius, writer of 'De rerum natura', as its last philosopher. In Epicurean philosophy the maintenance of personal well being and mental tranquillity, based on lasting effects of pleasantness ('hedone') and above all the avoidance of pain and fear, is the only and highest goal in life. A healthy way of life, the fulfilment of primary needs, close friendships, and the avoidance of pain and threats will serve that goal (Baily, 1926; Leopold, 1976). Epicurean hedonism distinguishes between limited and unlimited desires. In their natural origin all desires are limited and based on perceptual and bodily sensations, but vain imagination of fear and irrational anxiety can cause unlimited desires, such as greed and accumulation of wealth and power. Aristotle (Politics 1.9) distinguishes exchangeable and nonexchangeable values, where exchangeable values are the basis of unlimited desire, while nonexchangeable values are (over)saturating in their prolonged acquisition and, thereby, specify limited desires. He reasons that the desire for money is unlimited, due to its exchange value independent of specific natural needs (Politics, 1.8: 13-15). Aristotle, gives no further explanation, but Epicurean ethics explain unlimited desires by anticipatory due to avoidance and postponement of death. Against the threat of death men also seek material security, which according to Epicurean philosophy is vain and irrational, since death can't be sensed (Konstan, 1973). Only pains and harm that can be sensed must be avoided, but not all if a greater pleasure follows from them, Not short term pleasures, but lasting feelings of well being must be obtained by weighing out advantages and disadvantages of acts. Epicurean philosophy faded away under the influence of Christianity, but was reconsidered after the medieval period and revived as psychological philosophy in the second half of the 18<sup>th</sup> century.



### 1.1.2. Western revival of hedonism

Epicurean hedonism influenced Hobbes and Hume, but Hartley, the founder of psychological doctrine of associationism, more explicitly formulated a philosophical psychology of emotions as internally produced sensations of pleasures and pain that become associated with perceptual sensations (Hartley, 1749). In psychological associationism, behaviour is based on associations between matofic responses and aggregates of perceptual and affective sensations; approach behaviour results from positive, and avoidance behaviour from negative affects. Epicurean hedonism became a utilitarian principle by Bentham, who according to Boring (1950) got his hedonism from Hume and his associationism from Hartley. Bentham (1779) stated that *"nothing can act of itself as a motive but the ideas of pleasure and pain"* and that action is self-interested, but also optimised by *"the greatest good to the greatest number"*, whereby hedonism also became a political doctrine. Spencer (1870) linked evolution theory with hedonism by stating that survival of organisms is correlated with avoidance of pain and attainment of pleasure. Spencer and Bentham regard these behaviours as the basic correlatives of human and societal misery and welfare. Aristotle's and Epicurus' views that all natural desires are limited in origin are similar to the modern psychological notion of single-peaked pleasantness of sensation intensity. This single-peakedness seems for the first time explicitly formulated by Joseph Priestly (1775), the discoverer of oxygen and writer on Hartley's theory of mind. Priestly formulated for temperature:

*"moderate degree of warmth is pleasant, and the pleasure increases with the heat to a certain degree, at which it begins to be painful; and beyond this the pain increases with the degree of heat, just as the pleasure had done before."*

### 1.1.3. Emerging scientific hedonism

Experimental research on sensations and preference goes back to Fechner (1871, 1876) in his study on aesthetics. Many efforts in German introspective-experimental research concerned hedonic tone as the relationship between stimuli and the attribute of pleasantness and unpleasantness. A curve that relates hedonic tone to stimulus intensity is first pictured in a textbook by Wundt (1874), as represented by figure 1 below.

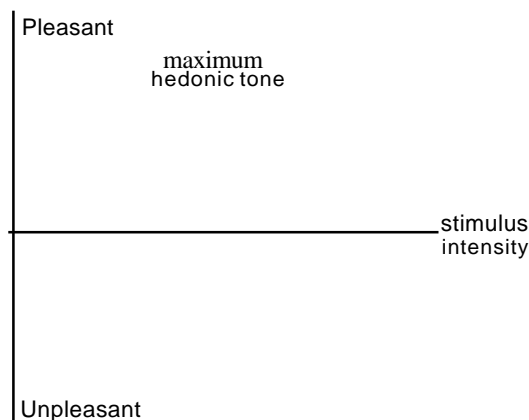

Figure 1. Wundt's single-peaked preference curve.

In this figure of the schematic Wundt curve the pleasantness increases with stimulus intensity up to some point and then decreases toward the point where the intensity becomes unpleasant, while the unpleasantness increases with higher intensities. Wundt did not derive his graphic description as a result of experimental observations, but as a qualitative curve from general knowledge and self-introspection. After Fechner and Wundt, the experimental study of pleasantness and unpleasantness came into being (Beebe-Center, 1932). Single-peaked curves that describe the data obtained from experimental research on pleasantness for intensity of many different stimulus modalities are given in numerous reports (Beebe-Center, 1951; Pfaffmann, 1960; Berlyne, 1960, 1971; Berlyne and Madsen, 1973; Zuckerman, 1979a,b). The following description of results shows the range of stimulus modalities with single-peaked preference. An early experimental report of Lehmann (1892) quantitatively describes that fingers of human subjects feel most pleasant in water heated between 35° and 40° Celsius, begin to feel definitely unpleasant in water of above 45° to 50° Celsius, and cause pain in higher heated water. Animals and humans prefer saccharine solutions in water when the concentration is somewhat above the sensation threshold, but the preference wanes and turns into aversion if the sweetness of the solution is raised. The reactions to salty solutions yield similar results, as did the taste judgments of humans for water with increasing concentrations of bitter and sour substances (Engel, 1928; Pfaffmann, 1960). Moderate intensities of illumination are pleasant and promote investigatory behaviour, but very intense light is aversive (Berlyne, 1960). The amount of exploratory behaviour is shown to be related to complexity of stimulus situations with a certain level of complexity where below and above the amount of exploratory behaviour falls off (Dember and Earl, 1957). Also puzzles and musical compositions have shown to yield a single-peaked curve for pleasantness of complexity (Walker, 1973). In general also the preference for the intensity of risk sensations is shown to be single-peaked (Zuckerman, 1979a, b).

Up to the first World War hedonistic theories, including Freud's highly hypothetical brand from his "pleasure principle" and "reality principle" (Freud, 1911), are characterised by the circular reasoning that preference behaviour strives for pleasure. At the edge of the behaviouristic revolution, McDougall (1926) called this reasoning a teleological fallacy, but acknowledged the role of pleasure and pain in learning by asserting (McDougall, 1908, p.43):

*"pleasure and pain are not in themselves springs of action <> they serve rather to modify instinctive processes, pleasure tending to sustain and prolong any mode of action, pain to cut it short".*

Later this became the essence of modern neurophysiological explanation of reinforcement in learning theory, as shown in section 1.5. Under the influence of behaviouristic psychology as well as operationalism and logical empiricism in philosophy of science:

*"the hedonistic delta in psychology branches in the behaviour-theory stream and the scaling-theory stream",*

according to a description by Berlyne and Madsen (1973). The early approaches of the scaling stream for preferential choice not only is found in different psychological theories, but also in econometric utility theory. Both are followed up first in the next

two sections, where also Siegel's (1957) approach to an integration of qualitative achievement theory and econometric utility theory is discussed. In the last two subsections of this section we discuss aspects of the behaviour-theory stream in order to investigate the answers to open questions from the scaling-theory stream (about slope, level, and origin of functions that may specify some kind of Wundt curve). In chapter 2 the analytic-mathematical integration of the results from both streams leads to our metric functions for the transformation of stimulus to sensation intensities and of sensation scales to response- and preference-strength scales.

## 1.2. Expected utility theory and level of aspiration

Utility theory, originally advocated by Bernoulli in 1738 (translation in Sommer, 1954), discussed by Ramsay (1931), and fully formalised by Von Neumann and Morgenstern (1947) and Savage (1954) is a mathematical theory for the maximisation of expected utility for decisions with uncertain outcomes. According to this theory a rational individual ought by his decisions to maximise (the sum of) the product of the probability associated with the outcome of choice alternatives and the subjective outcome values as utility. This classical, expected utility theory has been modified (Adams, 1960) by stochastic utility and subjective probability. In order to describe choice behaviour, subjective probability and imperfect discrimination of utility differences have been introduced in a probabilistic theory of subjective expected utility. In this choice theory, originally formulated by Luce (1959b) and Marschak (1960), subjective outcome probabilities and stochastic properties of monotone utility transformations of values modify the normative to a descriptive theory (Luce and Suppes, 1965). The qualitative psychological theory on the level of aspiration (Lewin et al., 1944), a popular topic in German psychology before World War II and extensively studied during and after that war in the USA, has been related to expected utility theory by Siegel (1957). Here below we discuss with regard to a metric foundation of the Wundt curve some relevant aspects of econometric utility theory, aspiration-level theory, and their integration by Siegel and co-researchers, while a more complete overview of the diverse models for preferential choices between alternatives with uncertain outcomes is given in subsection 7.4.2.

### 1.2.1. Econometric utility theory

In econometric theory utility of goods is a monotone function of their monetary values. Since every obtained good can be exchanged against money, the utility of more goods does not decrease. So under equal outcome probability the choice alternative with the highest monetary value should be chosen and if alternatives of different amounts of the same good are equally probable then also the alternative with a highest amount should be chosen on rational grounds. Only if higher amounts are less probable to obtain, a choice for more probable, lower amounts would be rational, since then the expected utility (product of probability and monotonic transformed value) for higher amounts can become lower. As mentioned in section 1.1.1., Aristotle already noticed that exchange value is the basis for unlimited desire. In the economic world, where anything is exchangeable against money, more of anything that can be sold is to be preferred.

The effects of satiation (diminishing increases of hedonic value for equal added amounts) are well acknowledged in econometric theory, but saturation (decreasing pleasantness) and oversaturation (increasing unpleasantness) for more of the same is excluded from econometric choice theory. From an economic point of view, excess of goods can always be sold on an unsaturated market and with that money other desired goods could be bought. Because money can't oversaturate in economic theory, economists don't need utility functions that decrease after some optimal amount. Although the financial position as neutral reference level of an individual (financial "status quo") may influence the utility of money as well as satiation for money may reduce the utility increases for added same amounts of money, more money always means more utility. A dependence of utility functions on an individual reference parameter is found in Kapteyn's (1977) theory of preference formation. Figure 2 shows how Kapteyn's utility functions depend on individual spending level of income {normal probability function of  $\ln(x_i)$  with mean  $\ln(x)$  and standard deviation  $s$ }.

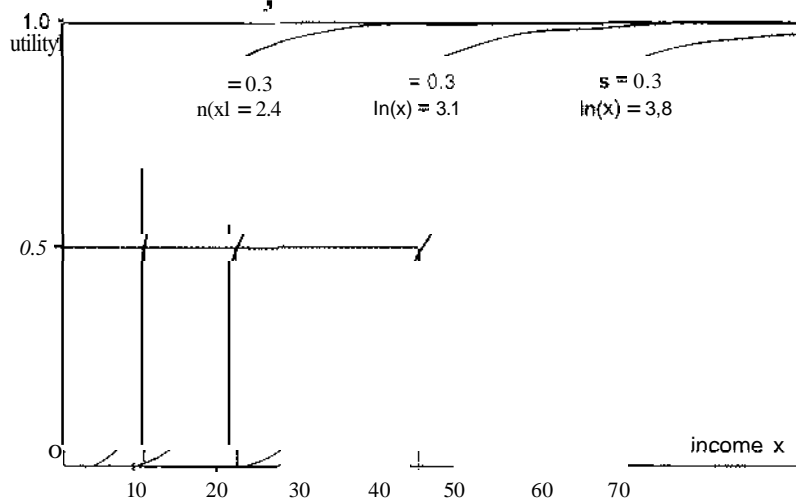

Figure 2. Individual utility functions a/money for different individual parameters. (adapted/mm Kapteyn, 1977, p. 51).

In Kapteyn's theory individual utility is described by a cumulative log-normal probability function of monetary value that is located at the financial "status quo" as the usually affordable spending level of the individual income. Utility satiation becomes expressed by the logarithmic transformation of money. Kapteyn's preference-formation theory implies choice dynamics that are depend on changes of the financial status quo, which choice dynamics are similar to our metric preference theory that will be derived from theory-grounded properties of adaptation-level theory, learning theory, and response theory in this and the next chapter.

### 1.2.2. Psychological valence and level of aspiration

Many aspects of life concern preferences with attributes that have nonexchangeable values, while application of utility theory to all kinds of preferences contradicts psychological research on the single-peakedness of pleasantness for more of the same

attribute. Achievement aspirations of individuals are also shown to be limited. Achievement tasks not only show **satiation** of aspirations, but after its maximum level the aspiration for higher achievements declines to lower strengths as a saturation phenomenon. An optimal level of aspiration for the achievement of tasks with varying difficulty seems first to be researched by Yerkes and DodsoD (1908) and is called the Yerkes-Dodson law in a review by Broadhurst (1959). The concept of aspiration level for which individuals settle was introduced by Dembo (1931) and has extensively been researched around World War II. A review is given by Frank (1941) and two articles on the theoretical concept are from Festinger (1942) and Lewin, Dembo, Festinger and Sears (Lewin et al. 1944). They describe the aspiration level as a function of (1) 'the seeking of success', (2) 'the avoiding of failure', and (3) 'the factors of their probability judgements'. For tasks from a range of difficulties Festinger (1942) distinguished valences of success ( $V_s$ ) and failure ( $V_f$ ) and expected probabilities of success ( $P_s$ ) and failure ( $P_f = 1 - P_s$ ). Assuming relationships with difficulty to be ogival for valences and linear for probabilities (figure 3a), Festinger derived a "force function" ( $J$ ) to achieve a difficulty level ( $L$ ), as illustrated in figure 3b.

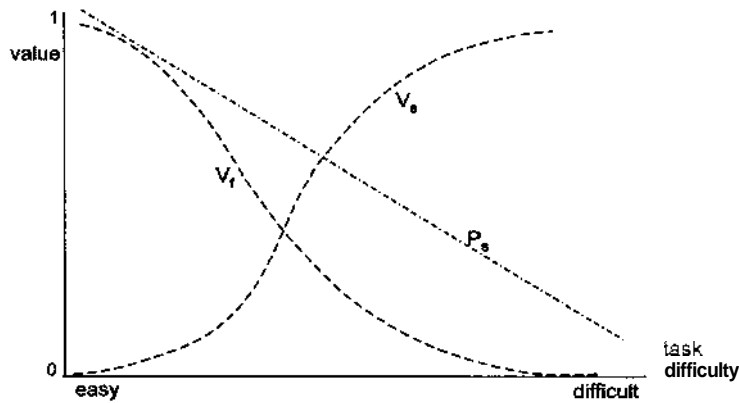

Figure 3a. The set of valence and probability curves of Festinger.

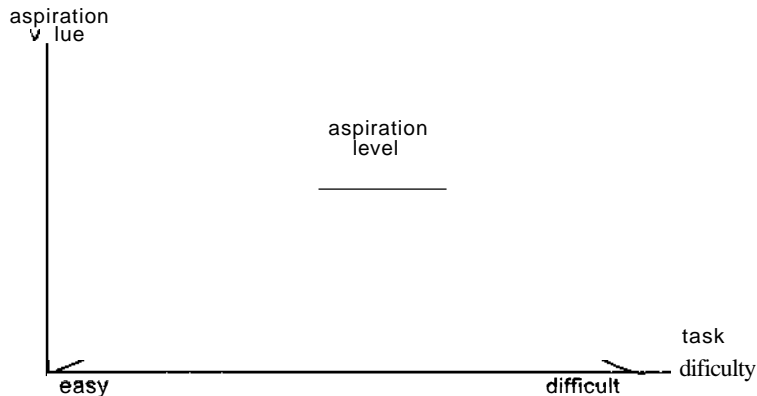

Figure 3b. The resultant force from figure 3a (Festinger, 1942, p. 24 J).

In quasi-algebraic terms Festinger (1942, p. 239) writes:

$$f_L = p_{s,L} \cdot v_{s,L} - p_{f,L} \cdot v_{f,L} \quad (1)$$

with level of aspiration as  $\max\{I_L\}$ . Festinger did not give explicit mathematical terms for his ogival valence functions.

Festinger (1942) wrote:

*"Changes in position of the valence curves along the abscissa and changes in the slope will affect the point at which the resultant curve reaches its maximum. <> Such changes in the position and magnitudes of the various curves can and do take place during a succession of trials, e.g., by learning, better acquaintance, etc. Such changes can also be induced by arbitrarily setting the positions of the valence curves for the individual by making him compare himself with other individuals (p.242). <> When the individual is told what others have scored <> he has two sets of standards before him: his own, which up to this time he has been using, and those of the group. The more potent (relative weight) the group standards are, the greater should be the magnitude of the shifts (p.247)."*

Festinger's experiments concerned changes of valence curve locations and slopes. He showed well fitting predictions from different levels of aspiration induced by influences of previous tasks and reference groups. The influence of reference groups is nowadays the heart of the attitude theory of reasoned action (Ajzen and Fishbein, 1980). Child and Whiting (1954) draw five conclusions from the research on level of aspiration:

- Success generally leads to a raised level of aspiration and failure to a lowered one.
- The stronger the success, the greater the probability of a raised level of aspiration and the stronger the failure, the greater the probability of a lowered one.

Shifts in level of aspiration partially depend on changes in ability to attain goals.

Failure more likely than success leads to avoidance of setting a level of aspiration.

Effects of failure on the level of aspiration are more varied than those of success.

### 1.2.3. Expected utility and level of aspiration

Siegel (1957) tried to unify the qualitative theory of aspiration level and the formal theory of expected utility. He showed that concepts in the level of aspiration theory are equivalent to concepts in the theory of subjective expected utility (Davidson, Siegel, and Suppes, 1957). Siegel firstly equated, somewhat implicitly, zero subjective utility with the present position of a person choosing new alternatives. Secondly, he rendered the subjective probability of successful outcomes and the expected success judgement as equal. Thirdly the valences of success and failure are seen as equivalent to the positive and negative subjective utilities of choice outcomes. Lastly he defined the level of aspiration as a position on the objective difficulty scale for which holds that (1) its lower position bound is neutral subjective utility (where below subjective utility is negative) and (2) its upper position bound is associated with the largest distance of positive expected utilities between equally spaced difficulty of tasks. Siegel's analysis implies that subjective utility and success probabilities are determined by oppositely oriented, monotone S-shaped functions of task difficulty, as shown in figure 4a.

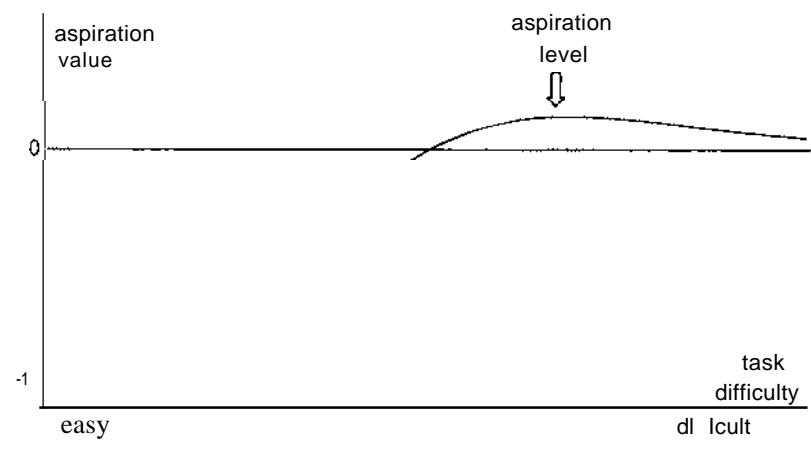
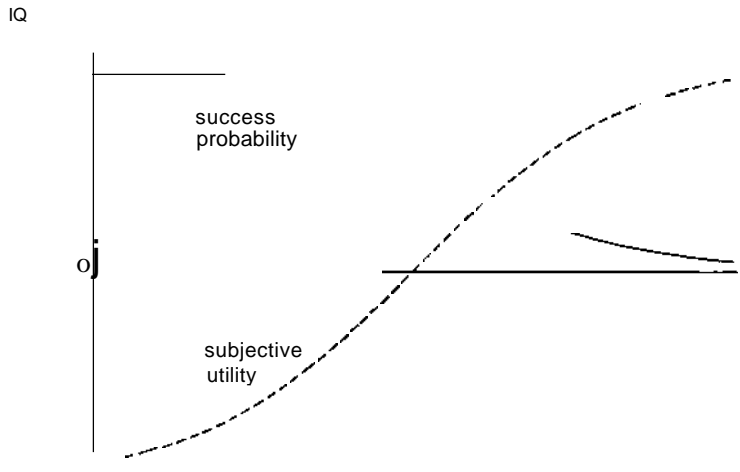

Figure 4b. Subjective expected utility as aspiration curve resulting from figure 4a. (an idealisation based on Siegel, 1957)

The idealised version of Siegel's analysis in figures 4a and 4b is mathematically described by logistic success probability

$$p_i = \frac{e^{-(x_i - x_0)}}{1 + e^{-(x_i - x_0)}} \quad (2a)$$

Here  $p_i$  is the probability of a success outcome  $i$  with some objective difficulty value  $x_i$  and where the moderately easy task difficulty  $x_0$  has a subjective utility value of zero. Siegel's subjective utility scale, denoted by  $u_i$ , has negative and positive values. The idealisation of Siegel's (1957) utility function has a negative, linear relation with success probability, while also  $U_i = 0$  for  $x_i = x_0$ . With the arbitrary normalisation for subjective utility to  $-1$  and  $+1$ , this leads to

$$u_i = 1 - 2 \left[ \frac{e^{-(x_i - x_0)}}{1 + e^{-(x_i - x_0)}} \right] = 1 - 2p_i \quad (2b)$$

The resulting preference or subjective expected utility curve as an achievement aspiration function becomes

$$V_i = p_i \cdot u_i = p_i (1 - 2p_i) \quad (2c)$$

The level of aspiration has a maximum of 0.125 at a success probability of 0.25. Since here the probability of 0.50 corresponds again with neutral subjective utility, where the increase of the subjective utility is also maximal, we see for equally spaced alternatives on difficulty scales that the largest neighbouring distance with positive subjective utility indeed tends to coincide with the aspiration level as maximum level of subjective expected utility.

The merit of Siegel's (1957) analysis is threefold. Firstly, the attempt to formalise and operationalise the level of aspiration theory. Secondly, the notion of zero subjective utility as the neutral value of the attained present position on the task difficulty scale. Lastly, the notion of level of aspiration as optimal preference point on the evaluation scale at some determined positive expected utility difference from zero expected utility. The notion of bipolar utility with a determined zero point is absent in the classical measurement approach of utility as a semi-definite positive scale (Luce and Suppes, 1965), but the failure to describe gambling behaviour (Luce, 1992) has led to the rank- and sign-dependent measurement model of utility (Luce, 2000) with a distinct zero point and larger utility losses than utility gains for equal objective loss and gain values. It axiomatises the utility measurement in the (cumulative) prospect theory (Kahneman and Tversky, 1979; Tversky and Kahneman, 1992) that is further discussed in section 6.1.3. Especially the last two notions of Siegel bring the dynamics of choice behaviour into the picture. Festinger (1942) referred to learning of tasks and better task acquaintance as changes in present positions and argued that such changes cause a shift in level of aspiration. Also Siegel noted such dynamics and referred to Simon's so-called 'satisficing' principle (Simon, 1955) stating that an individual does not choose after the exhaustive evaluation of all alternatives, but chooses the first satisfactory choice alternative at hand. Siegel (1957, p. 261) noticed that 'satisficing' choices yield shifts in level of aspiration by writing that:



*"such changes would tend to guarantee the existence of satisfactory solutions to the choice situation. Or failure to discover initially satisfying alternatives would depress the level of aspiration and thereby bring satisfactory solutions into existence".*

What is important from level of aspiration research is that choice behaviour is dynamic and relative. The momentary attained level by realised choices and habituation to experiences of that attained level play an important role in new preferences. Before the late seventies of the last century the notion of these dynamics in preference formation has been largely absent in psychological and econometric preference theory. However, dynamics are acknowledged in the preference-formation theory (Kapteyn, 1977), the prospect theory (Kahneman and Tversky 1979; Tversky and Kahneman, 1992), and implicitly in the rank- and sign-dependent utility theory of Luce (2000).

#### *1.2.4. Single-peaked preference curves*

Although the aspiration curve of Siegel's (1957) analysis yields a single-peaked preference curve, the missing issue in utility theory and Siegel's interpretation of level of aspiration is that the pleasantness of sensation intensities (without any outcome uncertainty) generally is single-peaked. If inherently single-peaked valences had been taken into account, it would have been natural to equate maximum hedonic value for that scale with level of aspiration at the ideal scale point. In the absence of single-peaked preference functions in econometric theory, it must handle phenomena of oversaturation by pairs of opposing utility functions, as implicitly Siegel seems to have done. An example is the single-peaked preference for hours work per day in jobs, which can be treated as a combined result of strict monotone utility functions for earnings (increasing with hours) and for physical labour (decreasing with hours). In multi-attribute utility theory single-peaked dimensions have to be represented by a combination of two such perfectly negative correlated attributes. In view of the existence of inherently single-peaked valence functions for attribute scales, it may be conjectured that the use of mixtures of additive and multiplicative utilities in multi-attribute utility analysis for preferences of complex alternatives (Keeny and Raiffa, 1976) contains a redundancy of perfectly negative correlated attributes.

According to Coombs and Avrunin (1977), there have been two barriers for research progress on preferences. One is the preference variability found across individuals (they don't like same things), in contrast to individual magnitude judgements that are often similar. Yet individuals are almost as consistent in their preference evaluations as in their magnitude judgements. The other barrier is that preferences are generally judged by order of alternatives for which no unit of measurement and no distinct zero point are present. Only after the theory of unfolding analysis was developed by Coombs (1950, 1964), the analysis and measurement of variables underlying preferential choice could make real progress. The basic assumptions of unfolding analysis are twofold. Firstly, alternatives of choice objects are assumed to have common scale values on attribute dimensions. Secondly individuals are assumed to have different imaginary ideal object locations on these attribute dimensions as dimensional points with maximum valence of single-peaked valence functions for these dimensions. The individual single-peaked functions may be differently shaped, but if symmetrically decreasing on both sides of the peak at the ideal object then the preference rank order of unidimensional choice objects has to be the

order of the objects after folding that scale at the individual ideal point where the single-peaked preference function has its maximum. If individuals have stable ideal points that are differently located on a scale for the choice objects then the individual preference rank orders are different and consistent. Unfolding these rank orders, assuming individuals have the same underlying scale of alternatives, not only yields rank order locations of their ideal points, but also reveals rank order relations between scale distances for enveloping pairs of alternatives on the scale. Diagram 1 gives a simple unidimensional illustration of unfolding analysis for four alternatives (A to D) and three individuals (I, J and K).

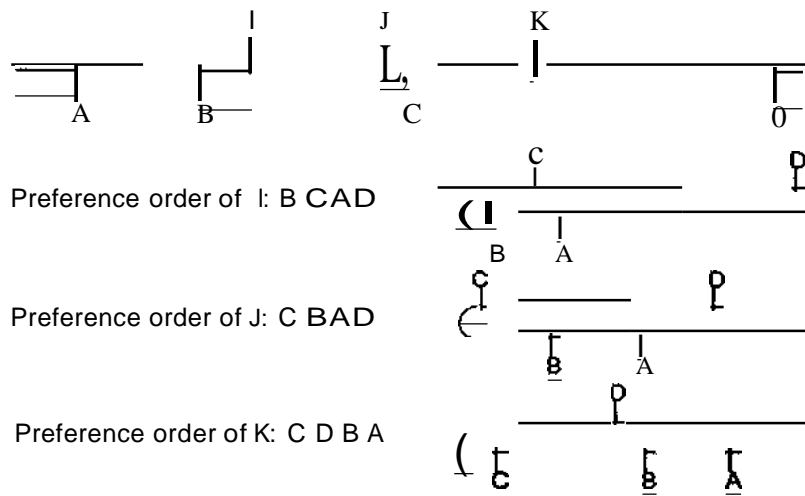

Diagram 1. Illustration of unidimensional preference unfolding

Rank order relations between distances of alternatives enable one to determine rather narrow ranges for the locations of alternatives on the underlying attribute dimensions. Such hyper-ordered distance scales are semi-metric scales that may approximate the precision of interval scales. The preference rank orders of me, J and K can only yield the unfolded scale order A, B, C, D, while distance AB must be smaller than distance CD, because the preference rank orders of I, J, and K also imply that the midpoint of BC precedes the midpoint of AD. For more alternatives and enough different preference orders of individuals, the richness of the order information on midpoints in the unfolding analysis leads to a scaling with fairly precise scale locations of ideal points and alternatives. Such dense hyper-orders of scale distance yields a so-called semi-metric ordered or hyper-ordinal scale that approximates the measurement level of an interval scale, although only rank order is the characteristic of the data. If all ideal points would be located outside the range of the alternatives then, clearly, the preference function needs not to be single-peaked, but can be monotonically increasing or decreasing. Unfolding analysis has been extended to more dimensions (Coombs, 1964). Multidimensional unfolding methods for independent attribute dimensions with non-metric single-peaked preference functions have been developed, all related to the original ideas of Shepard (1962a,b) for the multidimensional space representation of ordered distances. Different algorithms and criteria for optimisation of solutions have

resulted in several analysis methods of multidimensional scaling (MDS) or unfolding, such as developed by Kruskal (1964a,b), Guttman (1968), Lingoes (1973), Carroll and Chang (1970), Takane. et al (1977), De Leeuw and Heiser (1977, 1980, 1982), Heiser (1981, 1995), Heiser and De Leeuw (1981), and Groenen (1993). Already for some decades MDS and unfolding analysis are usual research tools in psychology and other domains (Shepard et al. 1972), including consumer preference (Green and Raai, 1972). Most varieties of multidimensional scaling and unfolding techniques are now described in study books (Cox and Cox, 1994; Borg and Groenen, 1997). They seem more parsimonious than multi-attribute utility models (Keeny and Raiffa, 1976) that have to use multiplicative interactions between negative and positive utility dimensions in order to describe single-peaked functions of dimensions. In chapters 4 and 5 the validity of existing MDS and unfolding methods is further discussed and questioned, while appropriate multidimensional analysis methods, also for spaces with mixed monotone and single-peaked functions, are described.

### 1.3. Foundations of Berlyne and Coombs revisited

Although many research is based on single-peakedness of preference functions, only few studies concern the foundation of single-peakedness itself. Festinger's (1942) qualitative analysis of level of aspiration and Siegel's (1957) integration with expected utility can be seen as first studies that contain a more fundamental account of single-peakedness and preference dynamics. However, without an intervening probability function and if both underlying valence ogives of Festinger are conceived as bipolar functions with a certain distance between their origins, then their multiplication also yields a single-peaked preference curve with negative valences on both sides of a range with a maximum valence in between. Multiplicativity of two underlying, oppositely oriented, bipolar, ogival functions with a distance between their origin locations is sufficient, but this construction of the single-peaked valence function requires theoretical justification. In the sequel and the next chapter that justification is given, based on a critical analysis of empirical evidence in psychological theory and research.

#### 1.3.1. Berlyne's foundation

A general account on the ubiquity of single-peakedness is presented by Berlyne (1960; 1971, ch. 8) in his theoretical foundation for single-peakedness by the arousal potential activation as a Wundt curve of hedonic value. Berlyne (1973, p.18, 20) writes:

*".. students of brain functions, of animal behaviour, and of human behaviour have been led to postulate two mutually counteracting systems, one productive of rewarding and pleasurable effects, approach movements, and positive feedback, whereas the other acts in the opposite directions. <> One can make a few plausible assumptions about the way these two systems work, especially the assumption for which a fair amount of evidence can be cited, that it takes more arousal potential to activate the **negative** or aversion system than the positive or reward system (bold face letters are ours). These assumptions enable one to represent the degrees of activation of the two systems as functions of arousal potential by the two ogival curves in Fig. 1-2 (below copied as figure 5). <> If we subtract the ordinates of the*

*aversion-system curve from the ordinate virile reward-system curve, we obtain the curve <> which has precisely the shape a/the curve introduced by Wundt in 1874 (here figure 1 on p.4), <> this interpretation a/the Wundtcurve relates hedonic value to 'arousal potential', which, it will be remembered, means something like 'stimulus strength' defined in terms of specifiable stimulus properties."*

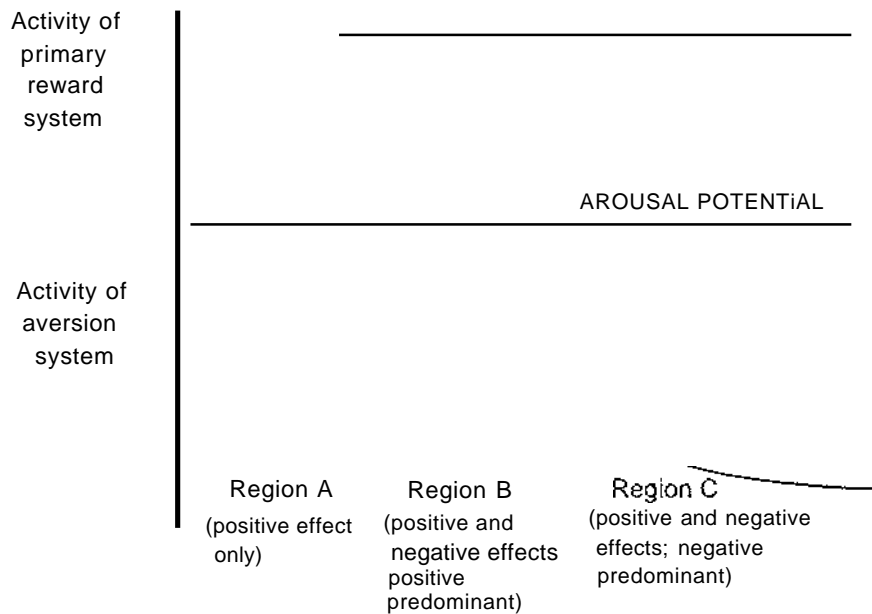

*Figure 5. Activation of reward and aversion systems as functions of stimulus intensity (adapted from Berlyne and Madsen, 1973 p. 19).*

It will be noted that the Wundt curve only results if the assumption of ogival curves with different location and different asymptotic levels hold. Evidence from nine studies up to 1971 for the assumption of difference in location, referred in the bold printed part of the above citation, is presented by Berlyne (1971, ch. 8). Although the evidence for different scale locations of reward-system and aversion-system curves is convincing, while also ogival shaped curves very well can be deduced by the nonnal distribution reasoning of Berlyne, there remain other questionable, but crucial aspects of the underlying curves. The first question concerns Berlyne's reference (1973, notes p.18 and p. 20) to an inverted-U shaped curve with negative hedonic value at both extremes of Wundt's curve. An inverted-U shaped curve has been hypothesised by Hebb (1955) and Eysenck (1967). Although Berlyne acknowledged that deprivation of stimulation can be unpleasant, it is not generated by his assumptions. The second questionable aspect is that negative hedonic value at high stimulus levels can only arise if the asymptotic level of the reward system is lower than the absolute value of the asymptotic negative level of the aversion system. Berlyne (1971, p. 89) remarked that there is no direct evidence for this assumption, but that it seems plausible. However, Berlyne's derivation fails to explain a negative hedonic tone for oversaturating stimulus intensity.

A third question may concern the slopes for the two curves. If the level of the aversion-system curve is not higher, then a single-peaked curve still is possible if the slope of the reward-system curve is steeper than the slope of the decreasing aversion-system curve. Since slope and level are not empirically justified, the derivation of Berlyne remains questionable. The fourth and last question to be answered is whether the sum of reward and aversion system outcomes determines the single-peaked curve or some other combination principle.

Mathematically the Wundt curve seems to be based by Berlyne (1971, p.87) on underlying curves of figure 5 as the sum of positively and negatively weighted normal probability functions with different means and weights and equal variances. The difference in sign and mean seem empirically sustained, but not the higher weight for the negative function, nor the equal variances. Equivalently, the difference of two weighted logistic probability functions could be used, which writes as

$$v_i = \beta_r (1 + e^{-(s_i - \mu_r)/\alpha_r})^{-1} - \beta_a (1 + e^{-(s_i - \mu_a)/\alpha_a})^{-1} \quad (3)$$

for  $v_i$  as valence and  $s_i$  as sensation intensity. Berlyne's assumptions can be specified by parameter restrictions for the slope by weights  $1/\alpha$ , levels  $\beta$ , and locations  $\mu$  (with index  $r$  for the reward system and index  $a$  for the aversion system) that satisfy:

	rank order of levels	$\beta_r < \beta_a$	condition (4a)
and	rank order of locations	$\mu_r < \mu_a$	condition (4b)
and	equality of slopes	$\alpha_r = \alpha_a$	condition (4c)

while  $v_i$  is a sum of a positive reward and negative aversion function of  $\exp(-s_i/\alpha)$  as stimulus intensity, Condition 4b seems empirically justified, but additivity and conditions 4a and 4c not, Condition 4c in Berlyne's derivation is too strong, since  $\alpha_r > \alpha_a$  also yields a single-peaked wundt curve. If  $\alpha_r > \alpha_a$  then  $\mu_r = \mu_a$  would suffice to generate a wundt curve, but the latter equality contradicts Berlyne's assumptions.

A single-peaked wundt curve only asks for condition (4a) and

$$\text{rank order of ratios} \quad \mu_r/\alpha_r < \mu_a/\alpha_a \quad \text{condition (5)}$$

Notice that the additive formula (3) resembles formula (1) of Festinger for logistic functions as opposite, ogival valence curves in figure 3, Festinger's interpretation of shifts in level of aspiration can be based on changes of  $\mu_r/\alpha_r$  and/or  $\mu_a/\alpha_a$ . For logistic valence curves in (1) of Festinger's formula, condition 5 and changes of its curve midpoints can explain shifts. Success probabilities need to decrease with increased scale values in formula (1) and are replaced by parameters  $\beta$  in formula (3), but then would not satisfy condition (4a).

### 1.3.2. Coombs' foundation

A second theoretical foundation for single-peakedness is from Coombs and Avrunin (1977). They present mathematical conditions whereby two opposite functions describe a single-peaked function. They derive a single-peaked Wundt curve from their assumption that "good things satiate and bad things escalate" with more of the same

attribute. They implicitly assume an identical origin for both functions and ground their Wundt curve only on difference in shape of functions for 'good and bad things' of an attribute. Coombs and Avrunin illustrate their derivation by the example of the duration of vacation. The longer the vacation the less its satisfaction (a function of time which levels off), while longer vacations not only cost more, but also have increasingly negative effects of being away from home, friends and business. These negative effects, although small at first, become more and more serious (as ever increasing, ooo-saturating function of time). With regard to the difference in concave and convex shape of underlying curves, Coombs and Avrunin (1977) noticed that one may adapt to the underlying unpleasantness of more exposure to the same stimuli, whereby the escalation of aversion may turn into a diminishingly negative function. They simply state that single-peakedness is guaranteed if **adaptation** to the bad is slower than the **satiation** to the good. Their single-peaked curves generate from escalation of the bad and satiation of the good by assuming slower adaptation to the increased bad than satiation to the increased good with identical origins for these underlying process curves, which is illustrated by figure 6 below.

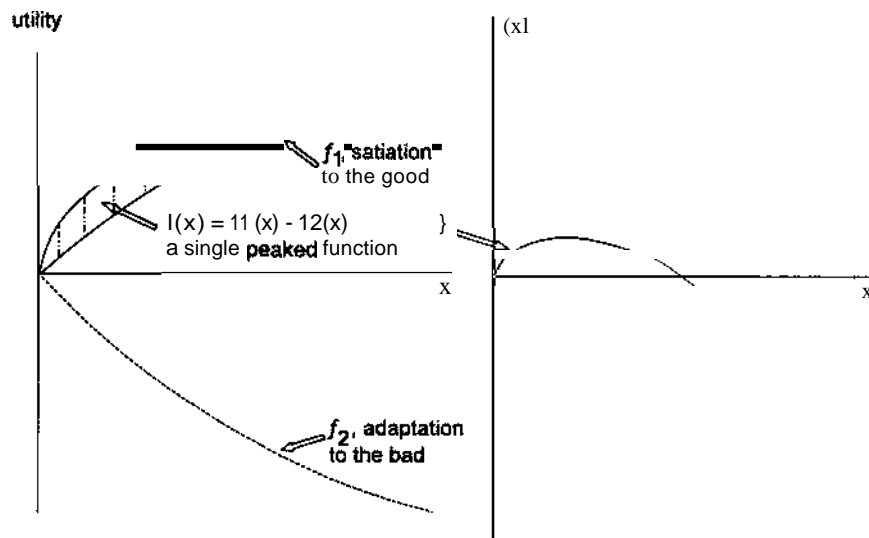

Figure. 6. Single-peakedness from satiation and adaptation ( $t = \text{time}$ ).  
(adapted from Coombs and Avrunin, 1977)

The curves of figure 6 could be described by

$$v_i = \beta_r (1 - e^{-x_i/\alpha_r}) - \beta_a (1 - e^{-x_i/\alpha_a}) \quad (7)$$

where symbols have identical meaning as in formula (3), but in terms of Coombs and Avrunin the index  $r$  refers to the 'good things' function and index  $a$  to the 'bad things' function. The mathematical description for a single-peaked function from two such functions by Coombs and Avrunin (1977) allow for other functions than the ones in formula (7), which is only one possibility for the curves of figure 6. The authors give

several possible metric functions of  $\kappa$ , as examples. Also formula (3) under condition 4a and 5 with  $\mu_r = \mu_a$  will fall in the class of functions that satisfy here.

Formula (7) contains no location parameters, while the origin of  $v$ , as single-peaked function with identical origins for the two underlying functions is the origin of scale  $\kappa$ . In order to define a single-peaked function as Wundt curve, formula (7) must satisfy:

$$\text{rank order of levels} \quad \beta_r < \beta_a \quad \text{condition (8)}$$

$$\text{rank order of slopes} \quad \alpha_r > \alpha_a \quad \text{condition (9)}$$

With regard to the identical origin of the underlying curves in figure 6, one may refer to the contradictory evidence of Berlyne (1971) who examined nine studies with higher stimulus intensity locations for the aversion-system curve origin than for the reward system. Coombs and Avrunin (1977) don't touch the question of curve origins or location parameters of the underlying antagonistic curves for individual preference. In their theory extension for preference bargains between individuals (Coombs and Avrunin, 1988) a parameter for the origin difference in preference comparison between individuals is introduced, but no account of their individual origin location is given. The slope difference of underlying curves is questioned by the authors themselves, but the question on which evidence one may assume a slower adaptation to the bad than satiation to the good, remains open. The shape of curves in figure 6 could be justified by the questionable functions of Hull's (1943) habit strength learning or the derivation may fit the exponential learning functions from the linear-operator theory of learning (Bush and Mosteller, 1955). These exponential curves, however, differ from Berlyne's assumption of underlying ogival curves. The study of learning curves remains open with respect to exponential or ogival learning functions (Sternberg, 1963 p. 37), but neurophysiological results (Olds, 1973) and connectionistic models (Gluck, 1992) support ogival functions. With respect to slope differences of underlying curves in figure 6, Coombs and Avrunin (1977) only state that less adaptation to the bad than satiation to the good guarantees single peakedness. They give a reference to Miller's (1959) theoretical treatment of approach-avoidance conflicts, which could be seen as an implicit reference for difference in adaptation to the bad and satiation to the good. Miller's conflict theory is based on a difference in generalisation gradients for avoidance and approach responses, where the decline of the gradient for avoidance is steeper. A difference in these gradients may resemble differences in habituation, but Miller's conflict theory only says that anticipated punishment dominates over anticipated rewards. It does not explain a difference between adaptation and satiation as concepts for habituation to good and bad things. Cognitive objects become good or bad by learning, but adaptation and satiation are primarily psychophysical and not learning phenomena, as shown in the sequel. Adaptation as affective habituation is discussed in the next section, where it is shown that adaptation is a (neurophysiological) desensitisation phenomenon for repeated exposure to same stimulus intensities. In the next following section we derive from learning theory the antagonistic function properties for expected good and bad of stimulus intensities.

### *1.3.3. The quest for grounded properties*

In order to obtain a single-peaked curve, differences in slopes and asymptotic levels of two underlying monotone functions are assumed by Berlyne and by Coombs and Avrunin, but there seems to be no evidence for such differences in slopes and levels, as Berlyne already noticed. Professional sportsmen show that they can shift their limit levels for fatigue, exhaustion, and pain far beyond the nonnal levels by training. Thus, depending on the exposures to intensity levels the limit levels can shift. Also individuals, who are exposed to extremely harmful circumstances that can't be avoided, have shown that adaptation to bad things need not to be less than habituation to good things. Such rare occasions can be found in history. For example, the heroic endurance of extreme tortures or the endurance of life-threatening circumstances in concentration camps in World War n. The example of the soldier who amputated his own leg on the Napoleon battle field in Russia even demonstrates that the prospective prevention of death can lead to a purposive action with temporary almost unlimited pain intensity. The rarity of such forced exposures to the intensely bad, in contrast to the frequent exposure to the mildly good, must not be confused with a difference between limits for punishment aversion and reward satisfaction of stimulus intensities.

Although oppositely oriented, monotone functions for underlying antagonistic processes, such as those from Festinger, or Berlyne, or Coombs and Avrunin, are quite acceptable, their construction of a single-peaked function seems not well grounded. The questions on asymptotic level, shape or slope for the underlying processes functions are not answered by the theoretical foundations of Festinger, or Berlyne, or Coombs and Avrunin. Only the opposition of underlying function curves and Berlyne's difference between their origin locations seem to be empirically justified. Difference between origin locations contradicts the derivation of Coombs and Avrunin, but also parts of Berlyne's derivation remain questionable. Moreover, the actual existence of a single-peaked preference curve with two-sided negative hedonic values, as Hebb (1955) and Eysenck (1967) for sensory underdeprivation and oversaturation have described, can't be explained by the derivations of Berlyne or Coombs and Avrunin. The basic question is whether it is possible to derive a single-peaked valence function from antagonistic process functions without assuming matters for which there is no empirical evidence. In the next section the nature of adaptation is investigated. Adaptation turns out to be no aspect of underlying curve slopes, as Coombs and Avrunin have assumed, but of dynamic reference level as the average sensation intensity of previous stimulation that also detennines a location of hedonic-neutral value for a preference curve (habitual level of affective stimulation). It is shown that stimuli below adaptation level give rise to responses with hedonic aspects that are opposite to stimuli above adaptation level, which for antagonistic underlying functions with different origins may induce a single-peaked (inverted-U shaped) preference curve with two-sided negative valences.

In the next following, learning-theoretical section it is argued that the two underlying processes for reward and punishment are specified by opposite and synunetric process functions with an intensity distance for their activation, but that there is no evidence for a difference in their slope or level. On the basis of properties for the underlying process functions, as derived from experimentally and neurophysiologically sustained theories of adaptation-level theory and modern learning



theory (subsequently discussed in the next sections of this chapter), and some metric properties from psychophysics and response theory (discussed in the next chapter), it indeed will be shown that a metric single-peaked preference curve can almost uniquely be derived. Its mathematical derivation is given in the next chapter, but firstly we discuss the fundamental properties for that derivation by examining research results and theories that are relevant for the foundation of valence functions in preferential choice

#### 1.4. Adaptation-level theory and properties for choice theory

Phenomena of adaptation and its dynamic consequences in perception, affection and behaviour are studied in many experiments. Early theoretical descriptions are found in Wertheimer (1912) and Beebe-Center (1929). Wertheimer discussed spatio-temporal adaptation in 'Gestalt'-theoretical research, which he called 'spatial level adaptation'. Beebe-Center studied sequential adaptation to affective qualities and she gave it the somewhat misleading name of 'the law of affective equilibrium'. The more quantitative theory is formulated by Helson (1964), who called it 'adaptation-level theory'. His accidental observation of a green-red reversal under adaptation to red light (Helson, 1938) was the origin for the theory and numerous experiments in many behavioural domains have verified Helson's theory. Nowadays the concept of adaptation level seems almost disappeared in psychology, but it was extensively researched in the sixties and early seventies of the last century. Nonetheless, its application can still be found in psychology and in social system theory (Hanken, 1981, Hanken and Reuver, 1981).

##### 1.4.1. *Relativity of sensations*

We all are aware of perceptual adaptation, such as adaptation to darkness. Adaptation to light takes time and extends over an amazingly wide intensity range of illumination. The brightness intensity of the sunlight-adapted eye compared with the dark-adapted one is about 100,000 times higher (Hecht, 1938). The concept of adaptation is, however, much richer than adaptive desensitising to increased stimulus intensity on one dimension. Adaptation not only can sensitise, as the example of adaptation to red shows by its increased sensitivity for green, but is also a simultaneous process for perceptual, affective and cognitive sensation dimensions. In order to explain this and to show the evidence for adaptation-level theory, since its first theoretical formulation (Helson, 1948), we cite Helson (1964) himself:

*"The level of adaptation is the pooled effect of three classes of stimuli: 1) focal stimuli; 2) background or contextual stimuli; and 3) residual stimuli (p. 58). Adaptation level is defined as a weighted geometric mean of all stimuli impinging upon the organism from within and all stimuli affecting behaviour from within (p. 59). Action (and enjoyment) comes not from situations giving rise to neutral states of the organism but rather from disparity between stimulation and prevailing adaptation level. Magnitude of response depends upon this difference from level, not only in perceptual phenomena but in emotional and motivational states as well (p. 49). The division into three classes (focal, background and residual) is largely a matter of convenience and depends upon the 'sense' of the experimental situation (p. 59). The weighted logarithmic mean  $\langle \rangle$  is affected by both range and density of a*

set of values  $\langle \rangle$  increases less rapidly  $\langle \rangle$  incorporates the law of diminishing return  $\langle \rangle$  is a good approximation to the relation between stimulus intensity and magnitude of sensation or response (Fechner's law)  $\langle \rangle$  an easy and convenient base with which to start (p. 60). Adaptation level as a weighted mean immediately implies that every stimulus displaces level more or less in its own direction, providing that counteracting residuals are not operative. If a stimulus is above level, the level is displaced upward; if below level downward; and if it coincides, it does not change level.  $\langle \rangle$  especially repeated stimulation, negates itself to some degree by reducing its distance from level. The fact that adaptation level is a weighted mean of external and internal stimuli implies that influence of one class of stimuli may be counteracted by sufficient emphasis on other classes of stimuli (p. 61). Organisms are space-time averaging mechanisms in which all dimensions of objects and events contribute differentially to the formation of levels. Among the more obvious and important weighing factors are area, intensity, frequency, nearness, recency, order of stimulation, and affective quality. Less obvious but often important in fixing levels are task, instructions, self-instructions, organic states, cognitive systems, and genetic factors. Cognitive acts, senso-motoric responses, skills, and learning are differentially affected by focal, background, and residual stimuli and hence are functions of prevailing level no less than perception and judgement. Similar considerations apply to affective and emotional behaviour. Just as individual levels are established with respect to prevailing conditions, so group levels, conceived as weighted means of individual levels, are established (p.63).  $\langle \rangle$  internal sources of stimulation are often more important than external sources in determining adaptation levels  $\langle \rangle$  pre-existing affective levels and cognitive systems have greater weight than do stimulus dimensions in the determination of many responses  $\langle \rangle$  usually they are neither manipulated as independent variables nor evaluated as dependent variables (p. 93)."

The central aspect of adaptation-level theory is that all sensations are relative, i.e. based on the difference between sensation intensity of stimuli and the existing adaptation level from previous stimuli. Consequently, sensation intensities are dependent on previous spatial-temporal stimulus configurations and, therefore, the sequential order of stimulation has effects on perception and evaluation. Stimuli coinciding with the existing adaptation level are neutral or ineffective; stimuli above that level elicit one kind of response, and stimuli below level elicit an opposite kind of response.

Mathematically formulated, adaptation level (a) is the geometric mean of three stimulus classes: focal stimuli x, contextual stimuli r, and residual or motivational stimuli m. Helson, 1964, pp. 58-61 and 200-203) defined

$$b = x^p \cdot c^q \cdot m^r \quad (10a)$$

$$\text{or} \quad a = \ln(b) = p \cdot \ln(x) + q \cdot \ln(c) + r \cdot \ln(m) \quad (10b)$$

$$\text{where} \quad p + q + r = 1 \quad (10c)$$

$$\text{and} \quad \ln(x) = \sum_{i=1}^n w_i \cdot \ln(x_i) \quad \left| \quad \sum_{i=1}^n w_i = 1 \right. \quad (10d)$$

which makes (10d) a weighted geometric mean, where  $w_i$  may be an exponential decay function of  $i$  as serial time order<sup>1</sup> of  $x_i$ .

#### 1.4.2. Ubiquity of adaptation level

Adaptation-level theory has been very useful in psychophysics. It simplified the explanation of complicating results on Fechner's law and on Stevens' power law in psychophysics (Carso, 1971). It explains many other matters, like assimilation and contrast effects that were first differently conceived, reciprocity of frequency and magnitude, as well as serial effects of stimulus-presentation order in judgement (Helson, 1964; Appley, 1971). Serial effects in magnitude estimation nicely illustrate the concept and dynamics of adaptation level. For example, a weight of 500 grams, lifted in random series of 300, 400, and 500 grams, is judged to be heavier than in random series of 500, 600, and 700 grams. In the study of perception adaptation-level theory explains phenomena of aftereffects, colour conversion, size and form distortions, illusions, figure ground reversals, over- and underestimation in perception of distance or duration (Helson, 1964; Appley, 1971), and velocity or motion (Drosler, 1978). It also explains parts of selective perception in hearing and vision by the sensitising aspect for stimulus intensities that neighbour the adaptation level (Eimas and Miller, 1978). Cross-modality matching, stimulus identification, and correction of distorted stimuli can be explained by similarity of differences from adaptation level (Bower, 1971; Capehart et al., 1969; Howard, 1978). Also some aspects in the formation of Gestalt properties are explained by adaptation-level theory, as Restle (1978) ingeniously showed by the relativity of organisation in visual judgment experiments. Bevan and Gaylord (1978) have argued that adaptation-level phenomena are sufficiently explained by perceptual processes of the passive perceiver and that adaptation-level theory is not a cognitive theory. However, adaptation-level theory concerns judgment responses to stimuli and as such relates to properties of judgement and perception. Broadbent (1971) convincingly showed that adaptation can't fully be explained by adaptive filtering of incoming stimuli alone, but must be also explained by adaptive changes in the so-called 'pigeonholing' process of assigning available response categories to stimuli. Broadbent's approach brings cognitive theory in line with adaptation-level theory, whereby errors in vigilance tasks are explained by Broadbent's processes of filtering and pigeonholing (Broadbent, 1971). Also the vigilance studies of Bevan (Bevan et al., 1967; Hardesty and Bevan, 1965) are modelled by adaptation-level theory for anticipation and arousal in vigilance tasks.

The application of adaptation-level theory to judgement, preferential choice, and risk behaviour, asks for the validity of that theory for cognitive processes or processes based on covert responses and internally produced mediating sensations. Imagination as a complex of covert response sensations is a common concept in learning theoretical approaches to cognitive psychology, but explicit reference to adaptation-level theory is not always apparent in that context. We therefore examine the evidence for the applicability of adaptation-level theory in the context of learning and judgment theories more closely, which is also necessary in order to understand the dynamics of preferential and judgmental behaviour. Puzzling phenomena in stimulus generalisation, transposition and reversal of learned responses, effectiveness of reinforcers, and cross-dimensional response transfer are successfully explained by adaptation-level theory. Already in the 1966-edition of the classical textbook "Theories of Learning" Hilgard and Bower conclude that adaptation-level theory:

*"implies a relativistic view of reinforcement <> is a conception that makes contact also with the economists' notion of utility and even more obviously with the cognitive theorists' notion of expectancy. The effect on behaviour of a given outcome is seen as dependent upon its relation to an internal norm derived via a pooling process from series of prior outcomes encountered in a given situation (p. 418) <> may be applied to both positive and negative reinforcement (p. 518)."*

Adaptation-level theory also applies to habituation in motivation and social theory (Nuttin, 1980; Berlyne and Madsen, 1973). McClelland and co-researchers (McClelland et al., 1953) have formulated an adaptation-level theory of motivation. Anderson's (1981) theory of information integration is a multidimensional adaptation-level theory of attitude change by consistent and repeated information supply. Adaptation-level theory in the study of affective values is reviewed by Helson (1973). The relevance of adaptation-level theory for societal values is discussed by Brickman and Campbell (1971). In studies on choice or judgment under uncertainty the concept of adaptation level is often unmentioned, but many described types of bias. Anchoring or framing for judgment under uncertainty are adaptation-level effects. Bias by anchoring adjustments can directly be described as adaptation-level effects. For instance, a presentation of 3 red and 7 white balls from an urn before a draw of 7 red and 3 white balls yields a systematic underestimation of the 50% red balls in the urn. Bias from availability can also be explained by adaptation-level effects on self-produced internal sensations as cognitive stimulation. For example, the question whether there are more English words with a 'k' in third position than beginning with a 'k' is incorrectly answered with a beginning 'k'. This incorrect judgment is explained if a difference in frequency level is thought to be formed by response sensations of relevant words searched in memory. The framing by the status quo in the prospect theory of Kahneman and Tversky (1979) on subjective expected utility clearly is a phenomenon that is predicted by adaptation-level theory. The related ambiguity theory of Einhorn and Hogarth (1985) of decisions under uncertainty is based on a cognitive adaptation level. Hogarth (1987, p.99-101) formulates:

*"First, people are assumed to encode outcomes as deviations from a reference point. <> a person's status quo often provides a natural reference point. <> The second characteristic of the value function is that its shape captures the intuition that people are more sensitive to differences between outcomes the closer they are to the reference point. <> The third characteristic of the value function is that it is steeper for losses than for gains...people are assumed to assess ambiguous probabilities by first anchoring on some value of the probability and then adjusting this figure by mentally simulating or imagining other values the probability could take. The net effect of this simulation process is then aggregated with the anchor to reach an estimate".*

It will be clear that this psychology of decision making implies adaptation-level theory as cognitive judgements based on sensations with respect to reference levels.

Relevant for preference and risk behaviour also is the evidence Helson (1964) gathered from many studies that unperceived stimulus changes can shift the adaptation level also, albeit less than perceived changes. Conscious perceptibility is not a criterion for the application of adaptation-level theory, because unperceived changes in stimulus intensity and repeated stimulus intensities below perception threshold can also

influence the formation of adaptation levels that underlie judgements. Effects of unperceived stimulus intensities and intensity changes will depend on their frequency and their integration over time according to Bloch's (1885) law. Prolonged unperceived stimulus intensity changes will in the long run have an effect on adaptation levels of sensation scales for judgmental and preferential choice. For example, a small gradual decrease in very low accident probability of road users will be not consciously perceived, but it reduces the risk-adaptation level and, thereby, the same traffic situations are judged as relatively safer or riskier than before (Koomstra, 1990).

#### 1.4.3. Time frames of adaptation

Two important, sometimes misconceived aspects of adaptation-level theory, need to be discussed. The first misconception leads to the erroneous insight that adaptation level can be equated with equilibrium level in homeostatic processes. The attainment of stable levels must not be confused with the theory of adaptation-level formation. Adaptation levels are dynamic reference levels, due to the ongoing changing nature of the give-and-take of responses to and stimuli from the environment and from affective response sensations within the individual. As Helson (1964, p. 54) remarked:

*"adaptation-level theory differs from the principle of homeostasis because it stresses changing levels."*

The second misconception is that adaptation levels are conceived as momentary levels. This need not be so. Watchmakers feel weights heavier than weight lifters (Anderson, 1975, p. 94). Actors attribute causes of actions less to dispositions of persons than watchers of plays (Appley, 1971). Individuals are consistently judged taller by short people than by tall, or older by young people than by old (Hinckley and Rethlingshafer, 1951; Rethlingshafer and Hinckley, 1963). Long-lasting effects of induced adaptation levels are also obtained in sensory deprivation studies (Solomon et al., 1961).

No fully clear picture of the neurophysiological processes that explain the diversity of adaptation-level phenomena is available. However, it is well established that intensity of signal transduction in receptor and nerve systems is not based on the absolute stimulus intensities, but on their sensation intensity difference from the (changing) adaptation-level, due to signal transduction in synaptic nerve systems that desensitise for constant excitation levels by the biochemical processes in these cell systems (Hebb, 1949; Eccles, 1966; Powers, 1974; Bolis, et al. 1984; Grossberg, 1982; Bryne, 1987; Groves and Rebec, 1988). As Foss (1989) concluded:

*"Adaptation by feedback loops prevents receptor saturation, reduces distortion, stabilizes gain and makes the system sensitive to change, not to level of signal."*

Already an overview of Posner (1975) on adaptive processes in the central nerve system points to long term changes of adaptation level, related to midbrain processes for slow tonic shifts in thresholds, and short-term effects of adaptation-level changes, related to thalamic processes for phasic shifts in thresholds. Nowadays these phenomena are experimentally observed and neurophysiologically well described by short-term synaptic potentiation (Zucker, 1989) and long-term synaptic potentiation (Teyler and Di Scenna, 1987; Linden and Routtenberg, 1989; Malenka et al. 1989). Referring to the psychological experiments and analyses of Broadbent (1971) one may distinguish three time-scales for adaptation-level shifts that correspond to the processes of 'categorisation', 'pigeon holing' and 'filtering' in respectively cortical, subcortical

or thalamic, and peripheral processing of signals. Changes in each process operate on different time scales. Firstly, rather *lasting adaptation levels* derive from the cumulative effects from long term stable stimuli in the personal environment and may be conceived to be related to 'categorisation' as a slow process requiring long term experience and learning. These processes are most likely located in a 'structural tracing' of the cortex. Guilford (1959 p. 44) equated lasting effects of the residual component in Helson's definition of adaptation level with traits in personality theory. Secondly, according to Broadbent's view, temporary shifts in the nervous system state would produce changes in 'pigeonholing'. A process by which changes in motivational states as well as temporary stable changes from the stimulus environment may be coupled to *temporary shifts in adaptation level*. These processes seem to be of a subcortical nature, but act upon association and senso-motoric units in the cortex. Lastly, *momentary fluctuating adaptation levels* from ever-changing peripheral stimuli seem mainly based on 'filtering' and partially on 'pigeonholing' in Broadbent's (1971) information process theory. Inhibition and facilitation of excitation in peripheral and thalamic nerve systems may relate to 'filtering' and in subcortical systems to 'pigeonholing'. How these processes are neurophysiologically described is not important, but important is that changing adaptation-levels apply to:

- developmental changes in neural processes for learning, cognition, and motivation as well as long term consistent changes in external stimuli with effects on developmentally *lasting frames* for judgement and preference;
- temporary changes in day- or task-related stimulus contexts and motivational states with effects on *temporary frames* for judgement and preference;
- momentary ongoing changes of stimulus intensities and associated incentives with effects on *momentary frames* for judgement and preference.

Focal perceptual and affective sensations change conditionally to semi-stable contextual and motivational states, while the internal focal affective sensations also partially can depend on intensities of focal perceptual stimuli as a focal complex of internal response sensations. Conditionally to its temporary stable level, the adaptation level for focal external and affective internal stimuli will shift by the flow of focal stimuli itself. Long term developmental changes in contextual or motivational states may also shift the conditional adaptation level in the long run. Progressive changes in momentary levels of external and affective stimulation evidently contribute also to progressive changes in adaptation level. In order to express these differences in time scales for multidimensional shifts in adaptation levels the averaging formulation of Helson may be adjusted somewhat. Momentary adaptation levels are to be seen as conditional to context and motivation with other change time-scales. Affective sensations also depend on sensory stimuli, because affective adaptation levels regard sensory dimensions to which the affective dimensions are conditioned.

It is more appropriate to adjust the formulation of Helson given in formula (10a) to (1ad) somewhat, by

$$a_{kl}(c,m) = \ln[b_{kl}(c,m)] = r_{kl} \ln[x_{ikl}(c,m)] \quad (1ad)$$

where  $a_{kl}$  is a conditional adaptation level on a dimension  $k$  of focal external stimulus intensities  $x_{ik}$  under constant conditions  $(c,m)$  for

context and motivational states. The weights  $W_k$  are subject to the same constraints as in (10d).

Generally affective stimuli  $x_{ih}$  on affection dimension  $h$  can depend on intensity levels of focal sensory stimulation  $x_{jk}$ . This is expressed by the conditional adaptation level  $a_h$  for affection as

$$a_h(c, m, a_k) = \sum_{i=1}^{i_{\max}} w_i \cdot \ln[x_{ih}(c, m, a_k)] \quad (11b)$$

where the ever changing sensations on affection dimension  $h$  are to be distinguished from the temporary or developmentally changing, but momentary stable, motivational states  $m$ . In the same way the sensory dimension  $k$  is to be distinguished from temporary stable states of sensory context  $c$ , but  $a$  can quickly shift by changes in  $a$  if affective dimension  $h$  is conditioned to sensation dimension  $k$ .

#### 1.4.4. Hedonic value properties from adaptation-level theory

Based on the general applicability of adaptation-level theory and its relevance for perception, judgment and affect, there is no doubt about the justification of its application in a theory of judgement, preference, and risk. Adaptation-level theory implies two general properties of sensation scales and corresponding hedonic properties of affective sensation scales. *First bipolarity* of sensations, because sensations are only effective by their positive or negative deviation from adaptation level. *Second dynamic relativity* of sensations, because the adaptation level changes with the stimulus exposure. Bipolarity and dynamic relativity of sensations for a sensation dimension explain how past perceptions influence the perception of next perceptions. Identical properties of affective habituation for sensations on hedonic dimensions explain also how experienced affections influence the hedonic value of new emerging affections. A theoretical foundation of preference, therefore, has to incorporate the bipolarity and dynamic relativity properties of sensations in order to explain how acts of judgmental or preferential choice influence the evaluation of next choices and how experiences of risks influence the riskiness of new risks.

Hedonic sensations for reward and aversion expectancies can become associated to perceptual sensations. Negative hedonic value not only is observed for aversive stimuli, but also from less reward than usually obtained or expected. On the basis of dynamic relativity of sensory and hedonic sensations, the mean sensation level of previously obtained external stimuli and the mean of their associated hedonic sensations constitute an adaptation level in the two-dimensional plane of sensation intensities for sensory sensations of perceptual stimulus intensities and for hedonic sensations associated to these perceptual stimuli. Thus, one sensation intensity level that also defines a turning point of negative to positive hedonic value is the adaptation level for sensory stimuli. But there may exist other levels than the adaptation level around which higher or lower stimulus intensities turns the associated hedonic value from positive to negative. They are called hedonic reference levels, because of their neutral hedonic value. Some relatively high stimulus intensity may become oversaturating and relatively low stimulus intensity may become characterised by underdeprivation, where both are experienced as unpleasant, while stimulus intensities lower than saturating level and higher than deprivation level become pleasant. These

high or low stimulus intensities where the hedonic value turns from positive to negative define also hedonic-neutral levels. Such hedonic-neutral saturation or deprivation levels generally coincide not with the adaptation level, but will be located at more or less extremely high or low levels of stimulus intensity scales. Saturation or deprivation levels will not be influenced by the usual variety of focal stimulation and, therefore, are viewed as rather stable, acquired or innate levels. Under which conditions their stability may hold is further discussed in section 1.6., where it is also argued that no other hedonic-neutral levels are to be observed on stimulus or attribute dimensions. For the moment it will be evident that there always is a hedonic-neutral adaptation level, while there may additionally apply hedonic-neutral saturation or deprivation levels. On a dimension with adaptation and saturation levels pleasantness above adaptation level increases with sensation intensity until maximum hedonic value is reached, while further increased sensation intensity reduces the pleasantness until intensities above saturation level create unpleasantness.

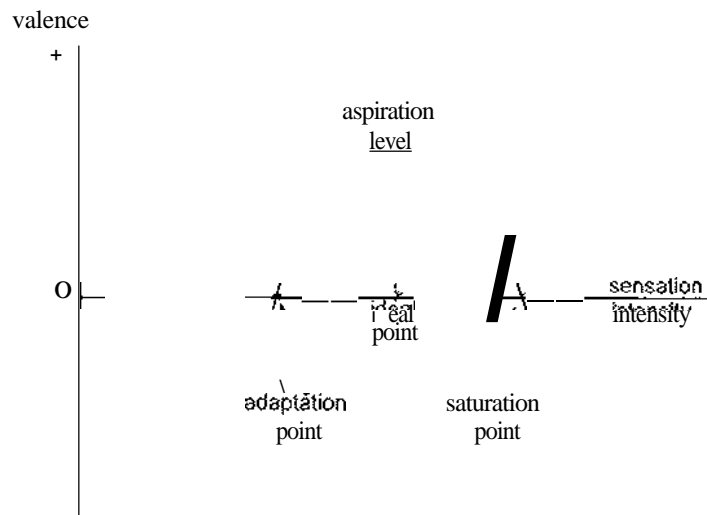

Figure 7. Schematic single-peakedness with negative valences at both sides

Following the terminology of Festinger and Coombs, maximum valence of the single-peaked preference curve could be called the 'level of aspiration' and its position on the underlying sensation scale the 'ideal point'. In the analysis of preferences that are based on single-peakedness of hedonic value curves, as in Coombs' (1964) unfolding analysis, it is assumed that the individually different ideal points are static or have static central distribution values. However, relativity of sensations implies that the adaptation level of sensory and hedonic sensations as well as its contextual and motivational conditions will change individually. Individually changed stimulus intensities and/or changed conditions cause shifts in individual adaptation levels, but generally not in the sensation-scale location of the saturation or deprivation level with zero hedonic value. A changed adaptation level in a metric single-peaked valence function with another fixed hedonic-neutral value also implies a smaller change of the sensation level with



maximum valence. Therefore, changes of adaptation level also imply that the ideal point changes somewhat, whereby non-random presentations of choice alternatives moves the ideal point, because such stimuli change the adaptation level. Individual dynamics of adaptation level cause individual dynamics in choice behaviour and aspirations. Due to their dependent effects, changes in adaptation level and in level of aspiration or ideal point are sometimes merged (Payne et al., 1980; Hogarth, 1987, p. 99-100). Referring to research on acceptance of errors in task performance by Payne and Hauty (1955a,b) and himself, Helson (1949, p.118) states:

*"The concept of par or tolerance for error has certain points in common with the concept of level of aspiration. In so far as explicitly formulated standards are concerned, the concepts seem to be identical. But in addition we stress implicit standards that are established more or less automatically... Level of aspiration according to this view goes into the pool of factors affecting behaviour and, in turn, is affected by prevailing adaptations."*

In order to describe how a given change in adaptation level causes how much shift of the ideal point, one needs more than a rank-order level of measurement for the single-peaked function. The schematic curve of figure 7 has, besides rank order information, two zero-hedonic scale values at adaptation and saturation levels on the underlying sensation scale with the ideal point in between. We need to search additional properties for an empirically sustained construction of a metric single-peaked preference curve, which properties can be found in learning theory.

### 1.5. Learning theory and properties for choice theory

The concept of reinforcement in learning theory goes back to Thorndike's (1903, 1932) trial-and-error learning from the beginning of the 20th century. Thorndike's first formulation of his "law of effect" is most succinct (Thorndike, 1903, p. 203):

*"Any act which in a given situation produces satisfaction becomes associated with that situation, so that, when the situation recurs, the act is more likely than before to recur"*.

Also in Pavlov's (1928) classical conditioning reinforcement applies to kinds of stimuli that promote the learning of responses on which the stimuli are consequent. In both types of learning (instrumental conditioning of elicited responses to provided stimuli and operant conditioning of emitted responses to accidental or provided stimuli), the responses become associated by contiguous reward (Hilgard and Bower, 1966). The longer the time elapsing between response and reward, the less the probability that stimuli elicit the responses that are aimed to be rewarded. On the one hand rewards that are contiguous to a specific response given on varying intensities of stimulus dimensions contribute to the occurrence of that specific response over the multidimensional intensity range of these stimuli (generalisation learning). On the other hand rewards contiguous to a specific response in the presence of specific stimuli and not rewarding that specific response in the presence of similar but different stimuli, restricts the recurrence of that specific response to a narrow stimulus intensity range (discrimination learning). Differential reinforcement strategies, aimed at selected types or selected chains of responses to specified stimulus ranges, have shown to be effective for the mastering of behaviour patterns by discrimination and generalisation learning.

Punishment is a negative reinforcer with opposite effects of reward. Punishments of responses on specific stimuli result in decreased probability of such responses to these stimuli. Comparable generalisation and discrimination effects as for rewards apply to negative reinforcements of punishment. Their main difference is that rewards specify which links between responses and stimuli are strengthened, while punishments only specify which links are weakened. Rewards elicit and punishments block behaviours.

#### *1.5.1. Contiguity and reinforcement*

In contiguity theories of learning, like Talman's sign learning (Talman, 1938) and Guthrie's contiguity learning (Guthrie, 1935), association is the primary principle and reinforcement a derived principle. In these theories not rewards and punishments, but the occurrence frequency of external stimuli and contingent responses strengthen the respective responses. This view is in contrast to the theories in which strength of drives and amount of need satisfaction from consequences of responses reinforce the association between stimuli and responses (Hull, 1943; Spence, 1951, Miller, 1951). In Mowrer's (1960a) two-factor theory and Gray's (1975) two-process theory of learning this controversy between the primacy of the contiguity or the reinforcement principle is resolved in the sense that rewards and punishment are linked respectively with facilitation and inhibition of nerve signal transduction, which influences the contiguous association probability of sensations and responses. In modern learning theory rewards promote and punishments deter the internal contiguity of signals by central brain processes of signal facilitation and inhibition, similar to Berlyne's reward and aversion systems. The facts (1) that withholding of regularly obtained reward or punishment shows opposite effects of their previous effects and (2) that intermitted reinforcement shows more stable and lasting learning results, have led to the view that learned behaviour is governed by expectations. In this neo-behaviouristic view the response activity depends on what consequences a person expects and on how consequences are valued. The term "incentive value" is the designation for the "utility evaluation", which links learning theory to the theories of choice and decisions. In incentive theories of learning (Logan, 1960) response strength is determined by a combined level of response-produced sensations of positive and negative utilities of response outcomes. These utility expectations of response outcomes are internally mediating sensations that occur prior to overt responses, as learned linkages between sensations of external stimuli and internally anticipated response sensations (Mowrer, 1960a). Anticipatory response sensations can elicit mediating affection signals which in turn can amplify or suppress overt responses. The learned chain from external stimulus S with sensation s to overt response R with outcome O becomes mediated by internal anticipation of a conditioned response R, denoted by r, that may elicit an anticipatory outcome sensation, denoted by s' where s' in turn may elicit an anticipated reward or punishment response of outcome O on R. This is shown in diagram 2, wherein Estes' (1969) stimulus sampling theory in S-R-O learning and Mowrer's (1960a) learning theory of mediating response sensations for anticipated affective and cognitive responses are combined.

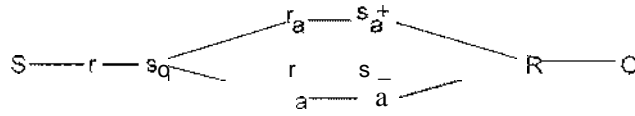

Diagram 2. Intervening anticipatory response sensations in S-R-O learning

Anticipatory outcome sensation  $s_o$  can generate affective responses and sensations, denoted by  $r_a$  and  $s_a$ , which become learned, mediating chain elements to external response R. Notice that mediating, affective response sensations with positive or negative hedonic value respectively facilitate or inhibit the signal transduction. For example the external stimuli with sensations S may elicit positive response sensations  $r_a \sim s_a(+)$  and the internal responses r with anticipated outcome sensations  $s_o$  also may elicit negative response sensations  $r_a \sim s_a(-)$ . The occurrence of an overt response R to external stimulus S requires a combined throughput of positive  $s_a(+)$  and negative  $s_a(-)$  affections that is still sufficiently positive to elicit the overt response R. These learning-theoretical accounts are incorporated in Grossberg's neural network theory of learning (Grossberg, 1969, 1982). Figure 8 shows Grossberg's minimal neural network of anticipatory response sensations in learning.

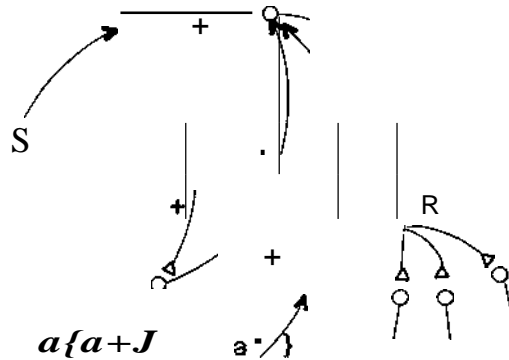

Figure 8. A minimal neural network with antagonistic affection effects (adapted from Grossberg, 1972, p.56).

The neural network diagram of figure 8 simulates that the release of an overt response is facilitated or suppressed, depending on the relative strengths of positive and negative affection signals from mediating response sensations that are conditioned to an external stimulus. Grossberg's theory extends that theory and the neurophysiological behaviour theory of Hebb (1949) by his mathematical theory of signed neural networks (Grossberg, 1969, 1971, 1982). Moreover, self-produced chains of perceptual sensations from one's own overt responses and internal response sensations with a connotative nature, like verbal stimuli and imaginative sensations, interact with loops of perceptual and affective sensations. The internal signal representations are anticipatory response sensations of a perceptual, connotative or affective nature or combinations of such response sensations. They act as covertly mediating connotative and affective signals in intervening signal chains for the response production of

learned, complex behaviour. In modern learning theory cybernetic scanning loops, sampling of stimuli, and overt responses are linked with positive and negative reinforcements as accompaniments that respectively promote and inhibit cognitive and overt response patterns (Bower, 1976; Estes, 1982). Information processing theory (Miller et al, 1960) and learning theory (Bower and Hilgard, 1981) are combined in the learning of complex verbal behaviour (Mowrer, 1960b; Staats and Staats, 1963; Staats 1968) and social behaviour (Bandura, 1976, 1978).

Nowadays neural network theory (Arbib, 2003), connectionist theory of learning (Healy et al 1992), and computational theory of parallel distributed processing (Rummelhart and McClelland, 1986; McClelland and Rummelhart, 1986) are highly interrelated. Computational connection theory of learning goes back to Steinbuch's learning matrixes (Steinbuch, 1959, 1961a,b), Widrow's adaptive switching circuits (Widrow and Hoff, 1960; Widrow, 1960), Rosenblatt-Minsky Perceptrons (Minsky and Papert, 1969), and early learning-simulation models (Koornstra, 1969), but is enriched by Grossberg's (1982) neural network theory and advances in neuroscience (Adelman and Smith, 2004; Arbib, 2003). The parallel processing of signals in so-called hidden layers with adaptive connections of contiguous signals and feedback from the output buffer, corresponds to mediated response sensations in learning theory. A multilayer learning system with so-called 'back-propagation of errors' is sufficient for the learning in connotative perception. In the computational and neural network theories of learning external stimuli (input) and overt responses (output) are related by layers with connection nodes that have sigmoidal functions for the connection strength (Hopfield, 1984). This is consistent with mathematical theories of response and learning functions (Luce, 1959b; Sternberg, 1963), as further discussed in chapter 2. Computational networks (Hopfield and Tank, 1985) learn unknown relations between input and desired output signals by externally controlled feedback from differences between generated and desired output. Adaptive network models of learning (Gluck and Bower, 1988a,b; Gluck, 1992; Grossberg and Carpenter, 2002) in connectionist theory can predict categorisation, pattern recognition, and probability learning, but don't model the single-peaked preferences of affective behaviour. Computational network models, in partial contrast to Grossberg's neural network theory, are restricted to recognition and connotation. Although the computational network extension to the decision field theory (Busemeyer and Townsend, 1993; Busemeyer, and Diederich, 2002) can describe affective choice dynamics by input-dependent and stochastic weight changes in a Markovian diffusion process for the signal input and throughput to the network output, but contains no intrinsic single-peakedness of valences. In animals and man internal needs generate drive-related reinforcements that also influence the signal processing in their nerve systems by facilitation and/or inhibition of the signal transduction, which differs from the externally provided feedback or context effects in connectionist theory. All human signal processing is influenced by affective signal facilitation or inhibition (Olds and Gids, 1965; Berlyne, 1971; Olds, 1973; Olst et al., 1980, Grossberg et al. 1999) dependent on the positive or negative response reinforcements that are associated to stimulus intensities. Facilitation or inhibition not only increases or respectively reduces the internal contiguity association of signals, but their sequential occurrence also causes single-peakedness of preference strength for stimulus intensity.

### 1.5.2. *Pleasantness and unpleasantness and two-process learning theory*

Basic to learning theory remains reinforcement that facilitates or inhibits responses to certain stimulus intensities. Gray's two-process learning theory (Gray, 1975) and the referenced neurophysiological research show evidence for two opposite mechanisms. One facilitating mechanism for signals associated with pleasantness and one inhibitory mechanism for signals associated with unpleasantness. Expected reward or punishment associated to stimulus intensities activates these mechanisms respectively. On the one hand stimulus-response patterns that produce expected reward are strengthened by the evoked facilitation mechanism, because such facilitation increases the simultaneous occurrence probability of their signal patterns in the nervous system. On the other hand stimulus-response patterns that produce expected punishment are weakened by the evoked inhibition mechanism, because reducing the simultaneous occurrence probability of these signal patterns. The adaptive states of the two mechanisms depend on internal conditions of need satisfaction, but the learning of stimulus-response relations is only based on the principle of contiguity in the covert signal processing within the nervous system. Contiguity of stimuli and responses, as in Guthrie's learning theory (Guthrie, 1935), is a necessary, but not a sufficient learning principle. Also reinforcement, as a principle that additionally determines the internal contiguous association of sensations and responses, has to be taken into account. In terms of neural network theory, reinforcement amplifies or reduces the association between internally contiguous signals and, thereby, determines the signal processing to responses. The higher the reward expectancy from overt responses the more connected these responses become with sensations that initially have evoked these responses and subsequently evoke their anticipatory reward-outcome sensations, where activation of the central signal facilitation process is relative to reward expectancy. Opposite effects hold for activation of the inhibition mechanism relative to the degree of expected punishment from responses. This means not that individuals always consciously seek reward and avoid punishment, because often autonomously generated after a stimulus-response pattern is (over)learned. In real life such unconscious stimulus-response patterns are more common than generally is assumed.

In the course of learning any signal processing from perceptual sensations to motoric responses becomes influenced by the facilitation or inhibition mechanisms. The reward mechanism provides "go" signals and the punishment mechanism "stop" signals, while their interaction determines the response strength, as Gray (1975) shows in his two-process learning theory. The "go" and "stop" processes are symmetrically opposite processes, where the conditioned reward and punishment expectancy subsequently activates the respective response facilitation and inhibition. As an example of the "go" and "stop" processes that by their sequential activation operate in a delayed way simultaneously, one may take the drinking response of thirsty animals to water supply. The drinking response intensity depends on anticipatory reward stimulation from the thirst senses of the mouth and on anticipatory punishment stimulation from the saturation senses in the stomach. The thirst signals from the mouth activate the 'go' process and the saturation signals from the stomach the 'stop' process. The underlying flow structure of Gray's two-process learning theory is copied in figure 9.

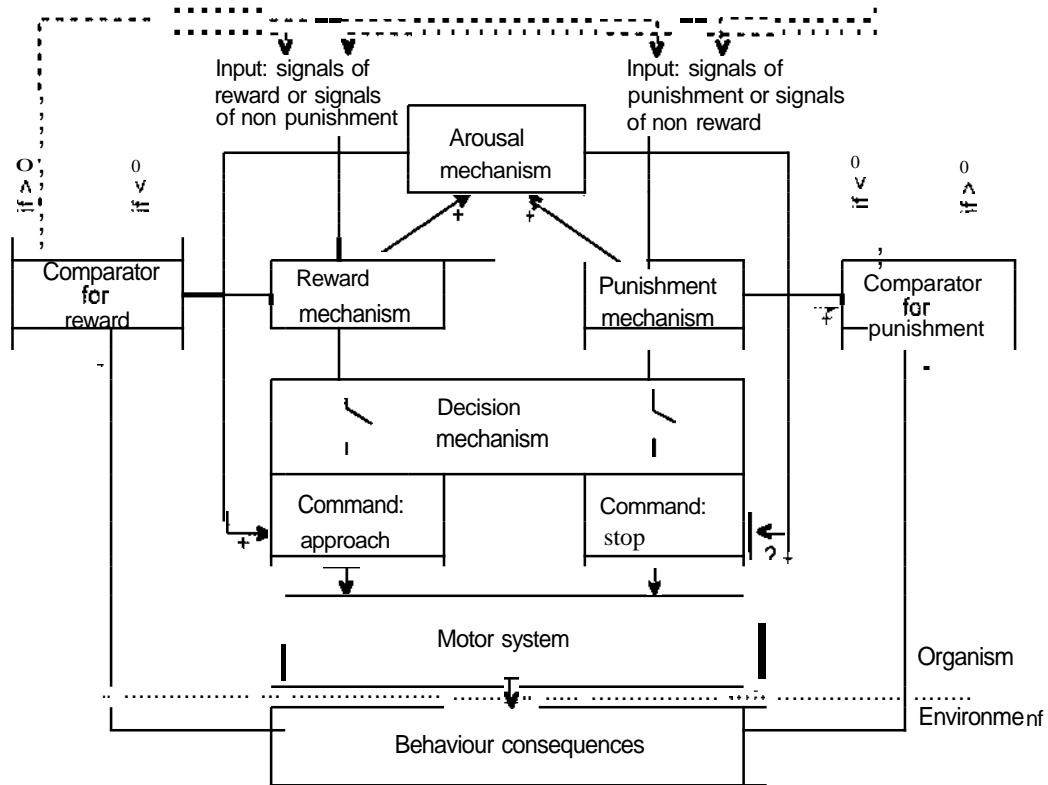

Figure. 9. Gray's two-process model: inputs  $t+1$  at state  $t$  (Gray, 1975, p. 347).

Pfaffmann (1960) already suggested independent activation of reward and aversion mechanisms, when he discussed preference for concentrations of sucrose or salt solutions. Although the afferent discharges of signals increased with concentration, higher concentration inverted the preference to subsequent aversion for high concentrations. Pfaffmann hypothesised an intervening "stop-system" that operates in such a way that initially elicited, efferent responses are blocked by the "stop-system" at high stimulus intensity. The two-process learning theory of Gray (1975) describes a conditioning of 'stop' signals to response sensations that dominate over the ongoing activation of 'go' signals. Biofeedback (Bakker, 1978) of separate activation and subsequent simultaneity of facilitation and inhibition processes at different sensation intensities with dominance of inhibition over facilitation, explains instrumental response conditioning (Miller, 1969; Obrist et al., 1974). Berlyne (1971, p. 84) writes:

*"The evidence shows that the aversion system, when active, inhibits the <...> reward system and diminishes the effects on behaviour that are attributed to that system. BUT there is no evidence that the activity in the <...> reward system inhibits the aversion system."*

or citing Zuckerman (1979b, p. 192), who refers to Olds and Olds (1965):

*"stimulation in the negative reinforcement area blocks response in the positive reinforcement area, but the converse is not found."*

These quotations concern the one way dominance in hippocampal brain circuits, but the same dominance is observed for sympathetic over parasympathetic circuits. The neurotransmitter from the sympathetic to the parasympathetic systems is noradrenaline, while within each system the transmission is based on acetylcholine. Only sympathetic postganglion ends connect with parasympathetic ganglia and there the noradrenaline inhibits the eliciting acetylcholine activity in spinal and peripheral parasympathetic neurons (Shade and Ford, 1965), while the reverse is absent. This is illustrated by next diagram 3 (adapted from Schade, 1967).

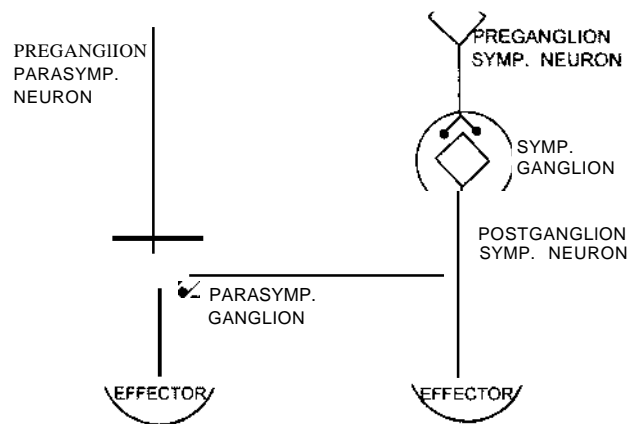

Diagram 3. Sympathetic inhibition on parasympathetic transmission

The notion that parasympathetic responses arouse feelings of pleasantness and sympathetic responses feelings of unpleasantness, is an old one and is not tagged with any particular name (Morgan and Stellar, 1950 p. 255). It seems that Landis (1934) was the first who experimentally tested this hypothesis and systematically reviewed its evidence. Although the evidence is mainly affirmative, it is not unanimously so. Affective inhibition can be a sympathetic inhibition of parasympathetic responses, but such affective facilitation exists not, while both affective inhibition and facilitation of signal processing exist in the hippocampal brain. In view of the inhibition effects of expected punishment and facilitation effects of expected reward, generalised reward and punishment expectancies and their neural effects are covered by the connotations of pleasantness and unpleasantness. Therefore, affective inhibition and facilitation are accompanied or generated by feelings of unpleasantness and pleasantness.

### 1.5.3. Hedonic value properties from learning theory

Choice behaviour is also based on learned behaviour and learned responses are generated by stimulation and facilitation and/or inhibition of neural transmission. Facilitation is activated by expected reward and, therefore, is associated with pleasantness, while expected punishment activates inhibition and is associated with unpleasantness. The hedonic aspects of these two processes will be called hedonic processes, which are expressed by hedonic response sensations as opposite, hedonic value functions of sensation intensity. The implications of modern learning theory for

the foundation of a preference theory are manifold. Firstly, it requires *bipolarity* of sensations and hedonic values. Secondly, the two oppositely oriented, ogival functions that transform sensation intensities with respect to different reference levels as origins describe a function *reflection* and also define that the underlying, forward and backward oriented, hedonic value functions have *opposite effects symmetry*. Thirdly, the function reflection and symmetry define an *anti-symmetry* of the two underlying hedonic value functions. Fourthly, there is a *distance* between the sensation reference levels that define the hedonic neutral origins of the two hedonic value functions. Fifthly, it describes a subsequent activation and partial activation *simultaneity* of the two hedonic processes. Lastly, the negative hedonic values of one function show a *dominance* over the positive hedonic values of the other function, if simultaneously activated. Given the bipolarity of the anti-symmetric hedonic value functions around hedonic neutral sensation levels at some distance, the properties of simultaneity and dominance can only be consistently combined to one metric hedonic function for the whole range of sensation intensities if the two underlying hedonic functions combine in a multiplicative way, because negative times positive values are always negative, where negative plus positive values can be positive, while negative times negative values don't exist by the anti-symmetry and origin distance of the underlying, hedonic value functions. Moreover, multiplicative function effects are empirically sustained, because if responses to the same stimuli are positively and negatively reinforced in a random way then the effect is reciprocal suppression (Grossberg, 1972a, p. 44; Berlyne, 1971, p. 84; Zuckennan, 1979b, p. 192) and not the additive effect from oppositely reinforced drive strengths, as supposed in Hull's (1943) learning theory. Hence, we derive a symmetrically single-peaked preference function from the intra-dimensional *multiplicativity* of two underlying, bipolar, oppositely oriented, symmetric ogival, hedonic value functions with a *distance* between their origin locations.

Summarised: the learning theoretical properties of hedonic value functions that transform a unidimensional sensation scale to single-peaked hedonic values are anti-symmetry, distance, and multiplicativity for the underlying, ogival functions of sensation intensity. The combination of these properties with the scale properties of bipolarity and relativity from adaptation-level theory (section 1.4.4.) implies that the single-peaked preference function is symmetric and has negative hedonic extremes on both sides, as Hebb (1955) already assumed. Modern adaptive network theory of learning with ogival connection-strength functions may satisfy bipolarity and relativity, because reinforcement establishes learned adjustments of expected values (Gluck, 1992), but single-peakedness for expected values is impossible in adaptive network theory by the absence of multiplicativity of oppositely oriented, ogival functions. Referring to the schematic single-peaked curve of figure 7, it follows that the sensation intensity at the ideal point defines a positive valence maximum for the sensation midpoint of the adaptation and saturation or deprivation level. At the low and high extremes of sensation intensity the hedonic value becomes diminishingly reduced to equal negative minima. Thus, that schematic single-peaked curve must become specified by a combination of two bipolar ogival functions that satisfy the properties of anti-symmetry, distance between function origins, and multiplicativity.



These properties from adaptation-level and learning theories don't sustain the derivations of the single-peaked preference curve by Berlyne or Coombs and Avrunin. The anti-symmetry and distance properties violate the foundation of the single-peaked preference curve by Coombs and Avrunin (1977), because they assumed asymmetry (different slopes) of opposing hedonic value functions with the same origin. Moreover, their additive combination also violates the multiplicativity property. A distance between sensation scale origins of two opposing ogival functions is incorporated in the derivation of Berlyne, but Berlyne's (1971, Berlyne and Madsen, 1973) derivation recognises not the intrinsic bipolarity of each ogival function, nor fully incorporates their anti-symmetry, and violates their multiplicativity by the additive combination. As will be shown in chapter 2, hedonic bipolarity around two hedonic-neutral reference levels and the hedonic function properties of anti-symmetry, distance and multiplicativity, as well as some basics of mathematical psychophysics and response theory almost uniquely determine the metric formulation of the single-peaked function. Dynamics of judgement and preference from adaptation-level shifts also are discussed in that chapter (section 2.3.). Firstly, however, the nature of sensation scales that exhibit hedonic values is investigated in order to understand the natural constraints for the response function and the types of hedonic value functions.

## 1.6. Hedonic properties and function types of sensation scales

Evolution provided mankind with congenital aversion for perceptual stimuli that have intensities either above some saturation or below some deprivation level, respectively at a rather high or rather low level of stimulus intensity, as aversion for oversaturation or underdeprivation. Some modalities seem congenitally aversive for any stimulus intensity. Stimuli that show such congenital aversion probably are only kinds of stimuli that influence nerve potentials by direct electric or chemical contact, which always produce sensations of pain, nausea or repulsion. As such it are stimulus modalities that are to be conceived as stimulus dimensions without a deprivation level. Apart from these modalities most other physical stimulus intensities show aversion above or below some congenital saturation or respectively deprivation level. This holds for all modalities with an energetic intensity, but no congenitally determined aversion applies to stimuli that are characterised by extensiveness, such as optical length, depth and height. The research evidence supports a congenital reward system that not only can be triggered by sensations that satisfy primary needs for food, warmth, stimulus arousal, etc., but also by sensations of relief from pain, nausea, and oversaturation or underdeprivation of energetic stimulus intensities.

### 1.6.1. *Congenital adaptation and saturation or deprivation*

Lasting underdeprivation or oversaturation of sensory stimuli congenitally deteriorates human perception. Lasting lack of sensory stimuli (lasting arousal underdeprivation) or lasting exposure to extremely high stimulus intensities (lasting arousal oversaturation) cause malfunction or eventually death. This not only is a general aspect of the nervous system (Berlyne, 1971) for arousal by any stimulus intensity in the non-damaging range between adaptation and saturation or deprivation levels, but also for

specific stimulus modalities within a non-damaging intensity range. General absence of nerve stimulation reduces the growth of connections (and deteriorates existing connections) between nerve dendrites (Bok, 1961), while specific sensory deprivations can cause lasting damages in specific perception and motoric responses (Solomon et al., 1961). Absence of neural stimulation prohibits nerves to regenerate after nerve lesions, while the energy of a too high stimulus intensity destroys the functioning of nerve cells and sensory receptors. The sensory nerve systems for specific modalities may show nerve potentials in different receptors for low and high intensities (Morgan and Stellar, 1950), which signalise these aversive intensity levels. Sometimes this is organised within the same sense organ (e.g. the ear), but this is no necessity. For example, thirst deprivation is signalised by senses in the mouth and saturating liquid supply is sensed in the stomach. A similar but somewhat more complicated dual perception system is observed for temperature stimuli. It is known for a long time (Bernhard and Granit, 1946) that maximum high local potentials are shown around 16°C for cooling of the skin and around 37°C for warming of the inside body in humans, while baseline potentials between 20° and 30°C are observed along the temperature gradient from skin to inside body. The survival value of internal homeostasis process for temperature is apparent, because internally or overtly eliciting compensatory responses that keep the organism away from damaging temperatures.

Every sensation scale of stimuli with energy as intensity measure is characterised by congenital aversion above or below some intensity level, probably with the exception for direct electric or chemical modalities with pain, nausea and repulsive olfaction sensations that have no deprivation level. Oversaturation or underdeprivation is unpleasant, while moderate intensities either above deprivation or below saturation level is pleasant. In case of intrinsic aversion stimuli (pain, nausea, repulsive olfaction), a decreasing sensation intensity is pleasant. Hence one must assume that neutral hedonic levels congenitally exist either at the upper or lower boundary of a range of pleasant sensations with the adaptation level as the only other boundary limit, where the lower boundary may coincide with just noticeable level of stimulus intensity (absence or zero sensations). For sensations with a negative ambience a neutral hedonic level is the deprivation level at a low stimulus intensity and for sensations with a positive ambience such a neutral hedonic level is the saturation level at a high stimulus intensity. The maximum hedonic value is reached at the ideal point that is located at the midpoint of the saturation or deprivation and the adaptation levels. It will be noticed that not all sensory stimulus modalities are determined by energy magnitudes as intensity measure. In the same way as spatial stimuli also colour and pitch receptors as wavelength-specialised senses enrich perception and behaviour with connotative capabilities. Spatial and wavelength stimulus aspects can be transmitted with equal energy levels of stimuli, due to the specialisation of their receptors with a pattern-dependent signal processing. The stimulation of receptor fields for such modalities, therefore, is independent of its energy measure and no congenital deprivation or saturation is apparent for these modalities, but adaptation to these kinds of sensations is present. For other stimuli, such as luminosity of light or decibels of sound with energetic intensity measures, not only the universal adaptation phenomenon applies, but also the phenomena of saturation or deprivation.

Aversion phenomena for energetic intensity modalities seem congenitally produced by innate responses to sensation intensities outside the range of normal sensory stimulation. These aversive sensation intensities monotonically increase with the intensity deviation from the congenitally determined neutral level at either a low or high intensity. Thirst and hunger are examples for two-sided sensation aversion for too much and too few. The same holds for sensations from energetic stimuli of light or sound, although their aversive stimulation on very low intensity becomes only aversive after long term deprivation. Some kinds of electric and chemical stimuli don't have specialised receptors, but their direct nerve contact influences nerve potentials and then only aversion for non-zero and increasing intensities of stimuli is present. However, apart from stimuli with direct nerve contact, intensity levels of stimuli from the natural environment can be classified in three hedonic categories: (1) aversion below some relatively low (deprivation or adaptation) level of sensation intensity, (2) aversion above some much higher (adaptation or saturation) level of sensation intensity, and (3) appreciation of sensation intensities between the adaptation level and the deprivation or saturation level with maximum appreciation at their sensation midpoint. From this congenitally hedonic nature of energetic and bodily stimuli we obtain unidimensional sensation scales with locally monotone, hedonic value functions that have oppositely positive and negative ambiances around hedonic-neutral levels and with positive hedonic values in between. If stimuli from the natural environment or internal body provide aversive sensations below a relatively low stimulus intensity then some self-produced responses may provide increased stimulus intensities. Such response-produced higher intensities have positive survival value. In animals and man internal cybernetic feedback systems emerged in the course of evolution, which autonomously provide such internal reactivity or instinctive behaviour patterns. For higher vertebrates and man overt responses can produce sensory intensities that are positively reinforcing, where learned behaviour will provide such rewarding sensation levels. By adaptation to higher intensity levels the deprivation level becomes latent and the adaptation level at a somewhat higher intensity level takes over the neutral hedonic role of the deprivation level, while the saturation level remains stable on a much higher sensation level. In this way a sensation scale with positive ambience emerges, where sensations below adaptation level are unpleasant and somewhat above adaptation level pleasant, but large sensation increases above the ideal sensation level create less pleasantness than sensations around ideal level, while further increased sensations above the saturation level become more and more unpleasant. This hedonic scale type with a single peak and positive ambience is denoted as type +11. Numerous examples of congenitally hedonic phenomena are of this type. Sensations for concentrations of many substances in liquids and foods, such as salt, sucrose, etc. as well as for gaseous concentrations of perfumes clearly are such positive ambience scales with an optimal pleasantness at an ideal level between their adaptation and saturation levels, as also are sound or light sensations, although less obvious due to their relatively high congenital saturation level. So type +11 scales are congenital scales of many stimulus modalities.

If stimulus intensities become aversive sensations above some intensity level then some self-produced responses may decrease the sensation intensities of their otherwise highly or increasingly aversive sensation intensities. Such response-produced

lower sensation intensities are positively reinforcing sensations. Apart from evolutionary developed feedback systems of innate internal responses and instinctive behaviour patterns, also overt behaviours are learned that provide a lower level of sensation than the natural level of aversive stimulus intensity from the environment or body would provide otherwise. Thereby, the role of the saturation level becomes latent by adaptation to the lower self-produced stimulus intensity levels and the downward shifted adaptation level replaces its function. Sensations above adaptation level then become aversive, while in case there also exists aversion below a relatively much lower level the congenital deprivation level remains stable on that much lower sensation level than the adaptation level. In this way a sensation scale with negative ambience develops as a scale for which sensations above adaptation level are unpleasant and somewhat below that level pleasant. But the initially increasing pleasantness from sensations below adaptation level inverts to less pleasantness if the lowering of sensation intensity passes the ideal point, while further decreased sensation intensities below the deprivation level become increasingly unpleasant. It is classified as a type -II scale, because it is a reflected type +II scale. Scale type -II evolves probably seldom from a congenital process for stimuli of a purely sensory nature. However, it is observed in antagonistic, congenital processes for temperature stimuli. The pleasantness of cooling sensations on the outside skin in a hot summer is a scale type -II by its pleasantness of cooling sensations below adaptation level. Its pleasantness can be counteracted by the type +II unpleasantness from cooling sensations below adaptation level for the inside body warmth, while also unpleasantness for warming above the saturation level of the inside body exists. A congenital inversion of pleasantness from decreasing sensation intensities to unpleasant sensations seems absent without such antagonistic processes, but by learned association such type -II scales may hold for many sensation scales of cognitive attributes.

If for a negative ambience scale no deprivation level is present then decreasing sensations below adaptation level are always more pleasant and increasing sensations above adaptation level are more and more unpleasant. Such sensation scales are classified as scale type -I and their reflected scales as scale type +I. Examples of congenital type -I sensation scales for stimuli of a sensory nature are found in intensities of electric shock, many chemical stimuli and most types of pinching pressure stimuli, because they always produce pain or nausea above some relatively very low adaptation level where below sensations are pleasant, while deprivation levels are absent. Also some response-produced, internal body sensations may generate congenitally negative ambience scales of type -I without deprivation levels, such as fatigue. The reflected type +I without saturation level and with pleasant sensations above adaptation level seems not to exist congenitally for energetic stimuli. Learned associations between sensations of energetic stimulus dimensions and other sensory or cognitive sensation dimensions lead to similar hedonic functions of type I or type II for sensory sensations with non-energetic stimuli or for cognitive sensation dimensions. Thereby, cognitive sensations that become negatively associated with type -I scales can establish learned type +I scales. Before we further discuss these matters, we summarise the types of hedonic functions in the table below.

type	shape of hedonic value curve with zero reference levels as function of increasing sensation intensities	existence of deprivation level	saturation level	hedonic stimulation	examples
				in- ac- in- ex- na- quir- ter- ter- te ed nal nal	
-I	reflected symmetric ogival function: positive below and negative above adaptation level	absent	latent	+ - + - - + + - + - - + - + - +	pain anxiety nausea phobic fear
+I	symmetric ogival function: negative below and positive above adaptation level	latent	absent	+ - + - - + + - + - - + - + - +	response sensations response sensations exist not income, welfare
-II	symmetric single-peaked function: positive below adaptation and above deprivation level, else negative	yes	latent	+ - + - - + + - + - - + - + - +	(?) stress (?) loneliness, danger
+II	symmetric single-peaked function: positive above adaptation and below saturation level, else negative	latent	yes	+ - + - - + + - + - - + - + - +	general arousal cognitive affects perfumes, tastes friendship
III	additive combinations of types I and II ----- additive combinations of types - II and +II	yes latent yes	latent yes yes yes	+ - - + + - - + + - - +	asymmetric types - II and +II ----- temperature road traffic risk

Table J. Hedonic function types of sensation scales

In the course of evolution there emerged in some cases different receptors for different intensities of the same energetic stimulus scale, where each receptor field has a different intensity range for pleasant sensations with increasing aversion below its own lower and above its own upper level. An example is already given for the outside-skin and inside-body receptors for temperature stimuli with different, ideal temperature sensations (relatively cool for the skin and relatively warm for the body). On such a sensation scale with antagonistic type II sensations the adaptation level is located between two underlying ideal points of each receptor field for the same stimulus modality. In the example of temperature stimuli the antagonistic sensation functions apply to the outside skin and the inside body temperature, each with a single-peaked maximum for optimal temperature and where the outside-skin has a deprivation level and the inside-body a saturation level of thermal sensation intensity. The fact that temperatures at relatively high levels for the skin also mean relatively low temperature levels for the body can be seen as a perfect negative correlation between two sensation dimensions as opposite deviations from the adapted level for that thermal sensation dimension. Such complete dependence of underlying sensations with oppositely single-peaked ambiances for a single stimulus dimension constitutes the general case of two ideal points, one above and one below adaptation level. It may give rise to choice dilemmas by its intra-individual ambivalence or to a preference indifference range

around the adaptation level. Scales that are characterised by dimensional combinations of different scale types are classified as type III scales. The congenital case for temperature with an ambivalent indifference range for temperature sensations derives from dependent dimensions of type -II and type +II, but a sensation scale more often will be a dimensional combination of type II (either type -II or +II) and type I (either type +I or type -I), where such a scale will generally show an asymmetrically single-peaked function for its hedonic values. Dimensional combinations of types +I and -I sensation scales define again sensation scales of type +I or type -I, depending on which underlying type dominates or becomes a hedonic indifference scale by an equally weighted addition of their oppositely signed hedonic values.

### *1.6.2. Cognitive saturation and deprivation*

Sensations from stimulus dimensions with a non-energetic extensiveness measure, such as colour, pitch and spatial sensations, can get by conditioning to sensations of energetic stimulus dimensions an acquired positive or negative ambience, apart from the general arousal aspect of all kinds of stimulus modalities as a congenitally determined dimension of type II (Berlyne, 1971). Examples are the individually different appreciations of colours, pitch of sounds or music, shapes, and wide or narrow space sensations. Cognitive attributes can also acquire positive or negative ambiances for their sensation scales by learned association with dimensional complexes of sensory stimuli. Cognitive attributes that become positively associated with congenitally positive ambience scales acquire also the aspects of positive ambience. If positively associated with a sensory type +II dimension then also the cognitive attribute gets dimensional sensations that are pleasant above adaptation level and below saturation level with an ideal point between these levels, while decreasing sensation intensities for cognitive attributes below adaptation level or increasing sensation intensities above saturation level become more and more unpleasant. Cognitive attribute sensations that are negatively associated with congenitally positive ambience scales become negative ambience dimensions. Thus in case of a negative association with a sensory type +II dimension we have a cognitive sensation dimension with an ideal point that is located at the midpoint of the adaptation and the 'reversed saturation level'. Such a 'reversely conditioned' or reflected saturation level becomes a deprivation level on a negative ambience scale of such cognitive attributes. A cognitively acquired deprivation level will generally be located at a very low sensation level, because the reflection of the saturation level is with respect to the adaptation level on the sensation scale to which the cognitive attribute is negatively associated by learning. Its deprivation level might even be located on a subliminal sensation level.

Effects of sensory deprivation for type +I sensation scales (monotonic, positive ambience) must be distinguished from effects of deprivation for type -II sensation scales (single-peaked, negative ambience). In sensory deprivation experiments (Solomon et al., 1961) the unpleasantness is a hedonic negative response sensation to sensation intensities far below the adaptation level. The longer the sensory deprivation lasts the more the adaptation level moves to the absolute sensation threshold as just noticeable level on type +I scales, while still increased unpleasantness is observed in prolonged sensory deprivation. This provides evidence for the here described nature of type +I scales with a latent congenital deprivation level where below the adaptation

can't shift. For cognitive attribute sensations of type -IT (negative ambience with ideal points below adaptation level) we may have questions about (1) the existence of a noticeably low deprivation level and (2) the possibility of unpleasant sensations below deprivation level at such scales. Deprivation of sensations for cognitive type -II sensation scales (single-peaked, negative ambience), such as mental stress, danger, loneliness, fear, seems hardly unpleasant, but can it be excluded that just noticeable sensations become less pleasant than some very low, but still noticeable level of sensations? Can absence or unnoticeably low levels of cognitive sensations with such a negative ambience be experienced as a qualitatively negative absence of affective sensations? Generally one hardly has any reduced pleasantness, nor unpleasant experiences from extremely low sensations for such cognitive attributes of type -II, whereby they may reduce to type -I (no ideal and no deprivation points and, thus, no less pleasantness or unpleasantness below any point). But introspection can be misleading, therefore, an objective reasoning is needed.

Negative conditioning of response sensations to sensory scales of type +II may hold for sensations of danger, specific fears, mental stress, and the like. If such conditioning takes place then the pattern of response sensations also must contain a conditioned reversal of associated hedonic sensations that accompany the unconditioned sensation intensities. This implies a reflection of the associated hedonic sensation intensities with respect to the adaptation level. Thereby, one obtains that the saturation level at a high sensation intensity on the unconditioned sensation scale with positive ambience becomes a reflected, neutral hedonic level at a low intensity level on the conditioned sensation scale with negative ambience. Comparable pleasantness and unpleasantness as around the unconditioned saturation level are then reversely expected around a low intensity level on a conditioned scale with negative ambience, which turning point from positive to negative affections rightly constitutes a deprivation level. According to this line of reasoning a deprivation level on a cognitive attribute scale with negative ambience is quite well conceivable. If it is established by generalisation learning then it could be that conditioned deprivation level may even be located below the just-noticeable level on the cognitive sensation scale, because the corresponding saturation level on the sensory sensation scale with positive ambience will generally be far above adaptation level. The reflection of the saturation level with respect to the adaptation level as a conditioned deprivation level on a cognitively associated type-II sensation scale will be located far below adaptation level. Thereby, a conditioned deprivation level can even be located on a subliminal level, but never below the absolute threshold, while the ideal point may still be located between the adaptation and just noticeable sensation level on such a negative ambience scale. Therefore, decreasing pleasantness from a low noticeable ideal to a just unnoticeable level is acceptable for such negative ambience scales, while the implied unpleasantness at unnoticeably low sensation levels can't be experienced. So, although there may not exist congenital type -II scales, there may exist cognitive attribute scales of type -II.

The actual existence of such learned, cognitive type -II scales may be illustrated by the appealing example of danger. Danger sensations generally have a negative ambience and, since absence of danger is usually not experienced as unpleasant, one may be inclined to classify danger as a type -I scale. However, this would be incorrect,

because individuals with high scores on the sensation seeking trait do experience low and extremely high danger levels as unpleasant in several contexts (Zuckerman, 1979a). Therefore, the negative ambience of danger must be a single-peaked type -II scale. The absence of unpleasantness at low danger levels for most individuals only means that their ideal danger level is close to the just noticeable sensation level of danger, while individuals with high sensation seeking scores have their ideal danger level far above the just noticeable danger level. If rewards become regularly associated with extremely high danger sensations, as for example applies to stunt men, then the danger adaptation level becomes located below the ideal danger level, whereby danger sensations then even acquire a type +II nature (single-peaked, positive ambience). It illustrates that the positive or negative reinforcement expectations of response sensations determine the positive or negative ambiances of single-peaked, cognitive attribute sensations. In laboratory experiments more than two hedonic neutral levels may become conditioned to the one sensation scale by reinforcement schedules with respect to multiple intensity levels. In contrast to the discussed example of skin and body temperature sensations with a neutral adaptation gradient between a neutral deprivation level for skin temperature and a neutral saturation level for body temperature, here we mean more than two hedonic neutral levels for the same receptor field. For example, in experiments of shock avoidance learning, wherein two experimenter-controlled levels of shock intensities are used for warning signals of shock relief, also two different, neutral saturation levels for shocks could be established. However, we assume it to be almost impossible that such multiple saturation (or deprivation) levels are established by reinforced stimuli in natural environments. If they would be established in specific environments then they would generate response inconsistency that has negative survival value and, thereby, would have been eliminated in the course of evolution. Only evolutionary selected combinations of different receptor fields with positive and negative ambiances for the same sensation dimension have emerged (e.g.: skin and body temperature) and then give rise to homeostatic ambivalence. Specific contexts may impose a situational dependence of generally independent positive and negative ambience dimensions and then cause a conflicting ambivalence for the combination of dimensions with opposite ambiances. Only such a combination of type -II and type +II dimensions can produce a sensation midrange with hedonic-neutral values and increasingly negative, hedonic values outside that range.

Single-peakedness of hedonic values, however, needs not to hold for every kind of cognitive sensation intensity that is conditioned to sensory sensations. There not only exists congenital type -I sensation scales (monotonic negative ambience, no single-peakedness), but also cognitive ones. A cognitive type -I scale may be acquired by positive conditioning of a cognitive attribute to sensations with a congenital type -I scale, such as pain or nausea. Moreover, a cognitive type -I attribute can also result from secondary conditioning to cognitive type -I sensations. For example, anxiety, as general fear without an object, can generate from the secondary conditioning of generalised response sensations that accompany experiences of unpleasantness sensations of fear and threat for various objects and situations, whereby anxiety becomes independent from the specific sensory modalities that originally cause the associated fears or threats. Since reduced intensities of anxiety remain unpleasant, the



cognitive attribute of anxiety constitutes a type -I sensation scale. By association learning also cognitive scales with a positive ambience without a saturation level (no single-peakedness) can exist. Such type +I scales can derive from the negative conditioning to congenital or cognitive type -I sensations or by a secondary positive conditioning to other, already learned, cognitive type +I sensations, despite the general absence of congenital type +I sensations for sensory modalities. As discussed in section 1.1.1, already ancient philosophers mention that objects with exchangeable values have cognitive attributes of type +I, such as monetary value or control power over other individuals. Increases of such attributes are always pleasant, either by the positive reinforcement from their use in the suppression of type -I sensations or by the positive reinforcement from their use in the attainment of pleasant type +I or type +II sensations. Due to the exchange values of attributes that contribute to the attainment of pleasantness from other sensations, such attributes have no saturation level. Thus, although type +I scales seem not to exist for sensory modalities, they are possible for attributes with socially or economically exchangeable values. Nonetheless, internal response sensations of type +I exist, but only in combination with counteracting response sensations of type -I and operating together they constitute the type +II or type -II scales for the sensation modality that elicit these opposite response-sensations. For example, the type +I response sensation from water supply in the thirsty mouth and the type -I response sensations from water supply to the saturating stomach describe a congenital type +II scale for sensations from drinking of water. For other sensation dimensions similar matters arise by an antagonistic combination of internally produced response sensations from different receptor fields for the same stimulus modality. This internal antagonism for the same stimulus scale and the derived property of intra-dimensional multiplicativity leads to the conjecture that the single-peaked hedonic value function for sensations scales of type +II must be derived from the multiplication of differently located, ogival functions for underlying type +I and type -I response sensations from the same stimulus dimension. Its underlying type +I function is located at the adaptation level and its underlying type -I function at a higher located saturation level on the same sensation scale, which then satisfies the earlier derived bipolarity, **anti-symmetry** and distance properties. Examples for congenital type -II scales are hard to imagine and may not exist, as also congenital sensations of type +I seem not to exist. However, cognitive type -II scales do exist by the multiplicative combination of a cognitive type +I function located at a relatively low deprivation and a cognitive type -I function at a higher located adaptation level on the cognitive sensation scale. We conjecture that intra-dimensional multiplication of two underlying hedonic functions located at different sensation intensities, as symmetrically ogival functions of type +I and type -I with different origins, describe symmetrically single-peaked, hedonic value functions of type +II or type -II for sensation dimensions with ideal points as midpoints of the underlying function origins.

### *1.6.3. Sensation dimensions and hedonic value functions*

Combinations of type I and/or type II scales are denoted as type III scales. Mixtures of hedonic function types I and II are obtained for rotated dimensions in a sensation plane with a type I and a type II dimension. In chapters 5, 7 and 8 we discuss asymmetric single-peaked functions that derive from weighted mixtures of type I and II functions

and in chapter 7 we apply such mixtures in the modelling of gamble preferences. In chapter 8 we also discuss sensation dimensions with opposite hedonic value functions of type II, where special attention is given to the interesting case of situations wherein usually independent sensation dimensions with type +II and type -II hedonic values become strongly dependent. The latter combination constitutes an ambivalent sensation dimension with an intra-dimensional preference conflict, because there are two underlying ideal points, one below and one above the adaptation level. As later discussed in chapter 8, the underlying type -II and type +II dimensions for such type III scales define equal distances between the adaptation level and each of the two underlying ideal points, whereby the underlying, oppositely oriented, symmetrically single-peaked valence functions yield by their valence additivity a hedonic indifference interval and increasingly negative hedonic values outside that zero-valued indifference interval. In chapter 8 this type III scale is applied in the analysis of road traffic risks. Metric properties, such as rotationally weighted combination of hedonic functions of sensation dimensions and zero-valued indifference intervals from combinations of antagonistic, hedonic value functions, can only be derived after we have specified:

1. the metric function for the transformation of stimulus to sensation intensities,
  2. metric functions for the hedonic value of unidimensional sensations,
  3. the geometries of stimulus or sensation spaces,
  4. and, thereby, the geometries of response or preference spaces,
- which are the subjects of the next chapters 2 to 6.

For the moment we conclude that sensory or cognitive, unidimensional sensations are characterised by congenital or learned hedonic value functions with a positive or negative ambience, while many sensation scales have single-peaked hedonic value functions with a maximum hedonic value at the ideal point as midpoint of the adaptation and saturation or deprivation levels, due to the derived symmetry property of the single-peaked function. Some sensation dimensions show a monotone function for their hedonic values. Such monotone functions with a negative ambience (no deprivation level) can be seen as hedonic value functions of sensation scales with an ideal point at an infinitely low sensation level, as pain or anxiety might illustrate. Also monotone functions with a positive ambience (no saturation level) can be seen as hedonic value functions of sensation scales with the ideal point at an infinitely high sensation level. As referred in the first subsection of this chapter, Greek philosophers already noticed that there are limited and unlimited desires. Unlimited desires are based on sensation scales with a monotone, hedonic value function that has only one neutral value point at the adaptation level, while limited desires are based on sensation scales with a symmetrically single-peaked, hedonic value function with two neutral values: one at the adaptation level and the other at the saturation or deprivation level. We derived from adaptation-level and learning theories the properties that any single-peaked preference function has to satisfy, as discussed in sections 1A and 1.5. According to the derived multiplicativity property, a single-peaked preference function is to be obtained by the multiplication of their underlying, symmetric ogival, hedonic value functions. How a metric formulation of symmetric single-peaked preference functions can be constructed from the mathematical psychology of psychophysics and response theory is shown in the next chapter.



CHAPTER 2  
PSYCHOPHYSICAL RESPONSE AND VALENCE THEORY

*"The introduction of cognitive and perceptual factors into decision theory may lead to the construction of more complicated choice models. At the same time such models are likely to provide a more adequate account of human decision processes."*

C.H. Coombs, et al. (1970). *Mathematical Psychology*. (p. 164). Prentice-Hall, Englewood Cliffs, **NI**

## CONTENT DETAILS CHAPTER 2

	page
2.1. Psychophysical scaling and response theory	49
2.1.1. Stimulus and sensation intensity scales	49
2.1.2. Comparable sensations and subjective stimulus magnitudes	55
2.1.3. Comparable sensations and responses	66
2.2. Metric response and monotone valence functions	70
2.2.1. The response and monotone valence function	70
2.2.2. The generalised monotone valence function	74
2.3. Metric single-peaked valence functions	78
2.3.1. Metric single-peakedness derived from basic principles	78
2.3.2. The single-peaked valence function	80
2.4. Dynamics of judgment and choice	86
2.4.1. Dynamics from adaptation-level shifts	86
2.4.2. Behavioural control and preference	89

## 2.1. Psychophysical scaling **and** response theory

In this chapter the derivations of almost **unique**, metric expressions for judgmental and preferential responses are formulated, as respectively magnitude and hedonic value functions of sensation intensity. On the one hand these derivations are based on the function properties derived in chapter 1, notably the properties from adaptation-level theory and learning theory, where from it follows in summary that:

- physical stimuli give rise to sensations intensities that are relative with respect to individually neutral reference levels;
- in the neural throughput from stimulus receptor fields to overt responses, relative sensations become conditioned to congenital or learned overt responses and to their anticipatory response sensations. The anticipatory response sensations are connotative sensations for judgmental responses or affective sensations for the pleasantness or unpleasantness of respectively anticipated reward or punishment, where the preference strength is expressed by the hedonic value function for pleasantness or unpleasantness of sensations;

judgmental response and monotonic preference strengths are symmetric ogival functions of sensation differences from individual adaptation levels. The single-peaked preference strength of sensations is a hedonic function that derives from multiplication of oppositely oriented, bipolar, and symmetric-ogival functions with the adaptation level as origin for one ogival function and the deprivation or saturation level as origin for the other ogival function. The reflected orientation, bipolarity, symmetry, and origin distance of the underlying ogival functions defines a single-peaked preference function that is symmetric with positive maximum at the ideal point as midpoint of the adaptation and saturation or deprivation levels, while sensations below deprivation and above adaptation level or above saturation and below adaptation level have diminishingly negative-increasing, hedonic values.

On the other hand metric expressions of the symmetric-ogival functions are to be determined by the relationships between stimulus and sensation intensities and between sensation intensities and judgmental magnitude responses or monotonic preference strengths. The higher the hedonic value of sensations is the stronger becomes the preference or approach behaviour and the lower their hedonic value is the stronger becomes the dislike or avoidance behaviour. Referring to Lewin's (1938, 1942) field theory of valences for actions, the hedonic values will be called valences in the sequel.

### 2.1.1. Stimulus and sensation intensity scales

According to Fechner's (1860) law (Guilford, 1954, ch.2; Luce and Galanter, 1963a, ch..2; Boring, 1950, ch. 14) sensation intensity is measured by logarithmic stimulus intensity. Citing Fechner (1851), as translated by Scheerer (1987, p. 203):

*"If the strength of the physical activity .. is measured by its energy  $\beta$  .. and if its change, assuming an infinitely small part, is named  $d\beta$ , then the accompanying change in the intensity of the mental activity .. is not proportional to the energy change  $d\beta$ , but to the relative change  $d\beta/\beta$  .. by corresponding summation of the accompanying relative increments, i.e., by means of the integral  $\int d\beta/\beta$  .., where the mental energy of the initial element must be known, ... the required mental intensity  $y$  .. will be  $y = \log(\beta/b)$ , where  $b$  denotes the value of  $\beta$  for which  $y = D$ ."*

Fechner defined the sensation scale origin  $y_0 = \ln(x_0/\mu) = 0$  to correspond to the absolute just noticeable stimulus threshold  $x_0/\mu = 1$ , whereby  $y_0 = 0$  for  $x_0/\mu < x_0/\mu$ . Fechner also assumed just noticeable sensation differences (jnd) to be constant for all jnd's above  $y_0$  as  $\text{jnd}(j>i) = \ln[(x_j + \Delta x_j)/x_i] = \alpha$ , where Fechner took  $\alpha$  as scale unit for his sensation scales with origin  $y_0$ . As evidence for the constancy of jnd's over the whole range of sensations, Fechner (1860) referred to Weber's (1834) finding (see also: Boring, 1950, ch 14) that a just noticeable increment  $\Delta x_j/\mu$  of stimulus intensity  $x_j/\mu$  is a constant fraction  $\kappa = \Delta x_j/x_j$ , which is called Weber's law. In the psychophysical literature the reference to Weber's law as evidence for Fechner's law has been criticised (Luce and Edwards, 1958; Pfanzagl, 1962; Krantz, 1971; Falmagne, 1985; Laming, 1997). Firstly, the transition from sensation jnd's to stimulus differentials is questionable or even unfounded (Dzhafarov and Colonius, 1999, p. 245). A just noticeable increment may not be deterministic, but a stochastic increment with a certain discrimination probability. For the first time Pfanzagl (1962) proved that the differential stimulus derivation of Fechner's jnd holds for the integration of the discrimination probability function over a just noticeable sensation increment. Thereby, Weber's law implies not Fechner's law, as already argued by Elsass (1886). Secondly, the sensation origin as absolute just-noticeable sensation and also the sensation jnd's can vary, because both are shown to depend on the stimulus adaptation level of the stimulus range, as noticed already by Aubert (1865). However, if we take Fechner's jnd as the just noticeable sensation difference from adaptation level then Fechner's jnd corresponds to the discrimination probability between  $p_1 = 1/2$  for stimulus  $x_1/\mu$  and discrimination probability  $p_2 > 1/2$  for its just-noticeably increased stimulus intensity as  $x_2/\mu = (1 + \kappa_{j1}) \cdot x_1/\mu$ . For the logistic discrimination probability as function of Fechner's logarithmic stimuli (Luce, 1959b; Luce and Galanter, 1963a, sec. 3.2) we obtain

$$P_j = 1/[1 + \exp(y_j - y_0)] = 1/[1 + \exp(\alpha)] =: 1/[1 + \exp(\alpha)] = 1/[1 + (1 + \kappa_{j1})],$$

whereby  $\alpha = \ln(1 + \kappa_{j1})$ . Writing stimuli as exponential function of Fechner sensations  $\exp[\alpha(y_j - y_0)]$ , we see that the differential stimulus, as derivative  $d(x_j/\mu)$  divided by level  $x_j/\mu$ , equals  $\alpha$ . Thereby, if stimulus  $x_j/\mu = (1 + \kappa_{j1}) \cdot (x_1/\mu)$  is the just-noticeably increased stimulus of  $x_1/\mu$  then  $\ln(x_j/x_1) = \ln(1 + \kappa_{j1}) = \text{jnd}(y_j - y_0) = \alpha$ . If Fechner's jnd  $\alpha$  is constant then  $\kappa_{j1} = \kappa$ , also independently from any discrimination probability function. Thus, in contrast to Cobb's (1932) conjecture that Weber and Fechner's laws are independent laws, Fechner's constant jnd  $\alpha$  for sensations as logarithmic stimuli implies Weber's constant fraction  $\kappa_{j1} = \kappa$ , although Weber's law implies not Fechner's law. Whether Fechner's law for stochastic Weber fractions uniquely implies the logistic discrimination probability function will be discussed later in chapter 4, where it is shown that the Cauchy probability function (Wilks, 1962, p. 130) can be the only other function that satisfies a constant jnd for the integration of the discrimination probability function over a just noticeable sensation increment, but in the sequel we only use Luce's (1959b) logistic discrimination probabilities as function of Fechnerian sensation differences from an adapted reference level.

Since the value of the just noticeable stimulus depends on the adaptation level while also Weber fractions are only constant for stimulus intensities fairly above the just noticeable and fairly below the saturating stimulus intensity, also Fechner's scale

unit and/or origin may vary if the momentary stimulus context changes or concerns just noticeable differences at extremely low or high stimulus intensities. Thus, Fechner sensations may only conditionally define an interval-scale measurement. Since the Fechner scale unit is modality-dependent (Weber's fraction differs for different modalities) and can also be location-dependent (the just-noticeable sensation differences are not constant), each dimensional Fechner scale would become a variably curved dimension (Dzharfarov and Calonius, 1999). Such dimensional scales define a so-called Finsler space (Busemann, 1942; Rund, 1959; Asanov, 1985; Matsumoto, 1986) that has variable curvatures in contrast to flat or non-Euclidean spaces. Nonetheless, for midrange-stimulus contexts Fechner sensations as logarithmically transformed ratio scales of stimulus intensities define interval scales with fixed origins and scale units that remain, however, arbitrarily defined, unless theoretically justified and uniquely solvable unit and origin parameters in the logarithmic transformation of stimulus ratio-scales define sensation scales that are invariant under linear transformations of Fechner's logarithmic stimulus scales. In the sequel we derive such parameter specifications for unidimensional sensation scales as logarithmically transformed stimulus dimensions that nicely describe the satiation phenomena, whereby stimulus differences above adaptation level are judged smaller than the same stimulus differences below that level. For example, the sensation difference  $\ln(7) - \ln(6)$  equals almost half the sensation difference  $\ln(4) - \ln(3)$ .

Weber (1834, 1835) found by cutaneous sensitivity experiments that

$$\text{Jnd}(x_{jk} - x_{ik}) = K_k \cdot x_{ik} \quad (K_k = \text{constant}) \quad (12a)$$

where  $x_{ik}$  is a stimulus intensity  $i$  for modality  $k$  and  $K_k$  the constant Weber fraction of just noticeable stimulus increments. Fechner's (1851) invention was firstly that sensations are measurable by some function of stimulus intensities and secondly that a constant Weber fraction is implied if sensations are inversely transformed to stimuli by exponents and jnd's of sensations are constant. Since the differential of function  $f[(y, - a)/\alpha]$  is only constant for the exponential function, Fechner defined stimuli as exponentially transformed sensations (Fechner was a panpsychistic philosopher, who believed that mind and matter are two faces of the same). We write Fechner's inverse law as

$$x_{ik}/u_k = e^{(y_{ik} - a_k)/\alpha_k}, \quad \text{whereby } \partial(x_k)/x_k = 1/\alpha_k \quad (12b)$$

Here  $u_k$  as constant-assumed sensation jnd defines Fechner's sensation scale unit, while Fechner (1860) also took the stimulus-scale unit  $u_k$  as threshold by taking  $a_k = \ln(x_{ik}/u_k) = 0$  as absolute just-noticeable sensation. Thereby, Fechner derived seemingly without loss of generality

$$y_{ik} = \ln(x_{ik}/x_{ok}). \quad (12c)$$

If the sensation origin is not constant, which empirically is the case for shifting adaptation levels, then the sensation scale can't be defined in Fechner's way. We take the sensation scale of (12b) as an interval scale with yet undefined scale unit  $u_k$  and origin  $a_k$ . We write its interval-scale sensations as



$$S_{ik} = (Y_{ik} - a_k) / \alpha_k = \ln(x_{ik} / \mu_k) / \alpha_k. \quad (12d)$$

The sensation scale with  $\alpha_k = 1$  and  $a_k = \ln(x_{ok} / \mu_k) = 0$  as absolutely just-noticeable level will be called a Fechner sensation scale.

There exists an alternative psychophysical function that is often favoured above Fechner's logarithmic function of the ratio scale for stimuli, whereby Fechner's law defines an interval-scale measurement of sensations. That alternative is Stevens' (1957, 1960, 1961, 1975) powerlaw. Stevens' psychophysical law states that a power function of the ratio scale for stimulus intensity is proportional to its subjective magnitude, whereby the subjective stimulus magnitude becomes  $z = (x/\mu)^\tau$ . Stevens formulated his law on the basis of fraction judgments for stimulus magnitudes with respect to target stimuli, where the fraction judgments fit a power function of stimulus intensities for many different modalities (Stevens, 1957; Stevens and Galanter, 1957).

Stevens' psychophysical law states that subjective intensity is a power-raised stimulus intensity, written as

$$z_{ik} = (x_{ik} / \mu_k)^\tau. \quad (13a)$$

Stevens' power law (13a) and Fechner's log law (12c,d) are also related. This is evident by taking the logarithm of (13a)

$$Y_{ik} = \ln(z_{ik}) = \tau \cdot \ln(x_{ik} / \mu_k). \quad (13b)$$

So Fechner's sensations are log-linear transformations of the power-raised stimuli of Stevens' law, but the inverse of the power exponent  $1/\tau \neq \alpha_k = \ln(1 + k)$  differs from Fechner's jnd as modified Weber fraction  $k$ , while the stimulus-scale unit  $\mu_k \neq 1 = x_k$  needs also not to equal Fechner's absolute stimulus threshold. 0

Stevens claimed that Fechner's law has to be repealed (Stevens, 1961) and the controversy has not been resolved. There exist extensive bodies of different experimental data, whereof each kind only supports one of the two laws and further empirical research analyses seem useless for the termination of the debate. The experimental evidence for Fechner's law, apart from mean category ratings with equal appearing intervals, concerns just noticeable differences. For Stevens' law the data are gathered by methods for the subjective estimation of apparent magnitudes or fractions of stimuli with relatively large intensity differences. Apart from the critique that logarithmic and power functions of stimulus scales are hardly distinguishable for many modalities (Treisman, 1964a,b; Wagenaar, 1975), each body of experimental data can be considered as convincing. Therefore, one should not ask which transformation function is correct, but whether there exists an explanation for the difference of functions by the difference in experimental methods. This would ask for an explanation either by Stevens' power law for the logarithmic function of data from the studies based on small stimulus differences and on mean category scaling or by Fechner's logarithmic law for the power function of data from studies based on apparent fraction estimation. Since the data in support of Fechner's law, apart from data for mean category scaling, concern the perception of equality or difference for pairs of neighbouring stimuli

without any intervening judgment of subjective stimulus magnitudes, it seems implausible that Fechner's logarithmic function is influenced by an intervening effect of the method. The data in support of Stevens' power function require the cognitive operation of fraction judgment, whereby the reverse may hold. One method of apparent magnitude judgment consists of an adjustment of a stimulus intensity to an apparent numerical ratio of another presented stimulus intensity (for example: manipulate a light dimmer until a light has twice or half the apparent brightness of a presented light). In the other method of so-called direct scaling the judgment consists of numerical value assignments to apparent magnitudes of randomly presented stimuli with intensities in a range between two standard stimuli with given numerical values (for example: a low intensity is given the magnitude of 10 and a high intensity the magnitude of 100 and stimulus intensities in between have to be given magnitude numbers with respect to the prior assigned values for the extreme stimuli). Subjects in these experiments need a cognitive process of metric magnitude assignment for their fraction judgments, as Wagenaar (1975) has argued. Apparent magnitudes of stimulus intensities with arbitrary scale units, such as weights in grammes or kilograms, length in centimetres or yards, illumination in lumen or microlux, etc., must be viewed as the result of a matching between cognitive magnitude sensations and the sensations of the evaluated stimulus intensities that are both a psychophysical function of respectively the objective numerical scale values and stimulus intensities. If Fechner's law applies and individuals learn to attach metric values to cognitive magnitude sensations that are logarithmic to a numerical scale then the metric values for apparent magnitude responses to stimulus intensities are the learned numerical values that correspond to cognitive magnitude sensations. Thereby, cognitive magnitude sensations as logarithmic number scale are matched with the logarithmic stimulus intensity by their weighted sensation equality and expressed by the assignments of metric values that correspond to cognitive magnitude sensations. This is supported by the linear function between apparent 'numerousness' or magnitude of spot patterns and the logarithm of the objective number of spots in the patterns by Guilford's (1954, p. 204) scaling method of equal appearing category intervals. One may assume that this is also the reason why the diameters of money coins are purposelessly designed according to the logarithm of the objective coin values. It also may be the reason why laymen make wrong inferences from magnitude scales of sound volumes and earth quakes, since laymen don't realise that decibels and Richter's scale are already logarithmic scales of physical intensity. As Wagenaar (1975) suggested implicitly, fraction judgment can be seen as a matching of a particular sensation modality with cognitive (learned and generalised) sensations of magnitude. Such a matching between a magnitude sensation scale as the logarithm of a metric ratio scale and a sensation intensity scale as logarithm of a ratio scale for stimulus intensities gives an equality matching by weighing of their logarithmic scales. The weighted equality between logarithmically transformed ratio scales implies a power function for the relationship between their original ratio scales with arbitrary scale units. Thus, it follows that Stevens' power law for fractionation data can be derived from Fechner's law. This is noticed earlier by Ekman (1964) and for cross-modality matching by Luce and Galanter (1963b, sec. 4.3.), where Stevens' power and Fechner's logarithmic functions both give a power function for matched stimulus scales.

A logarithmic transposition of metric magnitudes to magnitude sensations explains also why Fechner's law fits the means of ordered categories in the scaling by so-called equal appearing category intervals. This scaling procedure is a questionable methodology from a measurement-theoretical point of view, because it relates averaged rank order values of category intervals to sensation intensity. Still it shows stable interval-scale results as linear transpositions of logarithmic stimulus intensities, independent of instructions and labels of categories, number of categories, and distribution of stimulus intensities (Luce and Galanter, 1963b, sec 3.2. ) as long as the subjects are asked to make the ordered category intervals subjectively equal by instruction. It can be conceived as a successive ordering of approximately equal intervals on a scale for matched magnitude sensation of subjects who randomly differ only in precision of location and constancy of interval widths. Under these conditions the mean of rank numbers assigned by the experimenter to the equal appearing successive categories of subjects will become a rather precise interval scale for the logarithmic sensation scale. If this is the case and Fechner's law holds, then the means of ordered numbers for successive categories must show a quite good linear relation with the logarithm of the stimulus intensity scale, despite the questionable methodology of that method. Formulated in another way: if Fechner's law applies then (1) an average equality of intervals for magnitudes of sensations with its arithmetic number assignment by the experimenter in the mean category scaling method yields a logarithmic stimulus scale and (2) the matching of logarithmic transposed number and stimulus scales for the methods of fractionation and direct scaling defines a power-raised numerical scale for the subjective stimulus magnitudes. These hypotheses are in accordance with the suggestion of Torgerson (1961) that individuals use "exponential series for fraction estimation and arithmetic series for difference estimation", although our theoretical explanation differs from Torgerson's ad hoc assumption.

Suppose numerical magnitudes  $n_i/\mu$  relate by generalised leaning to Fechner magnitude sensations  $m_i$ , where according to formula (12d):

$$m_i = \ln(n_i/\mu)/\alpha = [\ln(n_i) - a]/\alpha \quad \text{with } \ln(1) = a \quad (\text{Uc})$$

We conjecture that subjects cognitively match sensations  $m_i$  to sensation intensities of a stimulus modality. Stevens, however, takes responses  $n_i/\mu$  for sensation intensity as subjective magnitude. So by (13a), according to Stevens (1957, 1960), we have

$$\begin{aligned} \text{or} \quad n_i/\mu &= (x_{ik}/\mu_k)^{\tau_k} && \text{Stevens' direct hypothesis: } n_i = Y_{ik} \quad (\text{Ud}) \\ \ln(n_i) - a &= \tau_k [\ln(x_{ik}) - a_k] && \quad (\text{Ue}) \end{aligned}$$

According to the above conjecture, subjects learn a generalised scale of magnitude sensations that is matched with sensation scale  $s_{ik}$ , whereby  $m_i = s_{ik}$  and applying Fechner's law also to scale  $k$  of stimuli  $x_{ik}$ , one writes, combining (Uc) and (12d) for a matching of the cognitive magnitude sensations with sensations  $s_{ik}$  of stimulus intensities  $x_{ik}$ ,

$$[\ln(n_i) - a]/\alpha = [\ln(x_{ik}) - a_k]/\alpha_k \quad \text{Fechnerian matching hypothesis: } n_i = Y_{ik} \quad (\text{13f})$$

We see that the equivalence of (13f) and (De) defines

$$\tau_k \cdot [\ln(x_{ik}) - a_k] = \alpha [\ln(x_{ik}) - a_k] / \alpha_k. \quad (139)$$

So, Stevens' power law derives from Fechner's law, if an intervening matching with cognitive magnitude sensations guides the method of fractionation judgments, where  $\alpha/\alpha_k = \tau_k$  defines that the power exponents of Stevens are proportional to the inverse matching weight  $\alpha_k$ .

The power exponent for the matching function in cross-modality matching ought to be identical to the ratio of the power exponents from separately obtained power exponents by Stevens' fraction judgment or direct scaling methods. This has empirically been proved to be correct (Stevens, 1959), but the power parameter for the matching function in its derivation from Fechner's law is only a still unspecified matching weight for the equivalence of two sensation scales. Therefore, Luce and Galanter (1963b, p. 280) favoured Stevens' power function as the psychophysical law. However, since each law is sustained by experimental data with different methodologies, the hypothesis of an intervening Fechnerian matching of perceptual and cognitive magnitude sensations - whereby fractionation scaling yields Stevens' power law as result of Fechner's logarithmic law - presents a consistent explanation of all the evidence.

- Firstly, 'yes-no' difference responses to almost just noticeable differences without magnitude judgments have supported almost constant Weber fractions ever after Weber's first experiments in 1834, which constancy is implied by Fechner's law.
- Secondly, Steven's direct scaling can be regarded as matching of perceptual sensations with cognitive magnitude sensations, whereby Stevens' power function follows from Fechner's law, as demonstrated in the above mathematical section.
- Thirdly, scaling by equal appearing category intervals can be regarded as a cognitive process of subjective equal interval estimation on a Fechnerian sensation scale of cognitive magnitudes, whereby logarithmic stimulus intensity and scaling by equal appearing category intervals define linearly related scales.

Therefore, Stevens' power law derives from Fechner's law as a matching law of sensory sensations with cognitive magnitude sensations, whereby Stevens's subjective stimulus magnitudes express in power-raised stimulus terms what Fechner's psychophysics describes by weighted sensation terms. As discussed in chapter 3, we may conclude that Stevens and Fechner express the same in spaces with different geometries, where Stevens by the implied matching of Fechnerian magnitude and perceptual sensations has honoured Fechner in implicitly repeating and not repealing Fechner's law.

### 2.1.2. Comparable sensations and subjective stimulus magnitudes

Up to now the unit and scale origin of sensation measurements in the derivations are not psychologically meaningful and distinct parameters. The integration of Helson's adaptation-level theory and Fechnerian psychophysics partially changes that situation. According to Helson's (1964) adaptation-level theory, discussed in section 1.4, sensations are sensation differences from adaptation level. The order of presented stimuli may influence that adaptation level, because the adaptation level is defined by a geometric averaging of previous stimuli on the physical scale or by an arithmetic averaging of previous sensations on a Fechner scale. Since adaptation is an averaging

process on the sensation scale, the same physical intensity difference from the adapted level on low levels of physical intensity scales are sensed larger than those on high levels. That is why adaptation to the dark lasts longer than adaptation to bright light. However, we will not discuss response-time research, because it would unnecessarily complicate our psychophysical response theory. Michels and Helson (1949) have argued that adaptation-level theory implies a significant change of the interpretation of Fechner's law. They state that the actual sensations are proportional to the logarithm of the ratio of the presented stimulus intensity and the stimulus adaptation level. Thus, where Fechner (1851, 1860) defined sensations for modality  $k$  by

$$s_{ik} = \ln(x_{ik}/x_{ok})/\alpha_k$$

for stimuli  $x_{ik}$  with absolute stimulus threshold  $x_{ok}$  and  $u_k$  as just noticeable sensation difference, there Helson takes

$$s_{ik} = T_k \cdot \ln(x_{ik}/b_k) = (Y_{ik} \cdot a_k)/(u_k/u)$$

for stimuli  $x_{ik}$  with stimulus adaptation level  $b_k$  and stimulus- and context-dependent weight  $\tau_k = (a/u_k)$ . But we derived Stevens' power exponent  $\tau_k = (a/U_k)$  as ratio of matching weights  $1/a$  for cognitive magnitude sensations and  $1/u_k$  for sensations of modality  $k$ , as shown in the last mathematical section. Thus, Helson replaces Fechner's stimulus threshold  $x_{ok}/\mu_k$  by the stimulus adaptation level  $b_k/\mu_k$ , both with arbitrary scale unit  $\mu_k$ . In the sequel we will define the adaptation level  $a_k = \ln(Cb_k/x_{ok})$  as a conditionally constant distance on a Fechnerian scale  $y_{ik} = \ln(x_{ik}/x_{ok})$  where  $x_{ok}/\mu_k$  is not Fechner's absolute stimulus threshold, but a just noticeable stimulus level that depends on the adaptation level. Here distance  $a_k$  is assumed to be constant if the presented stimuli are randomly selected from a known stimulus set and stimulus context is stable. Stimulus threshold  $x_{ok} \geq x_{ok}$  for just noticeable sensation  $\ln(x_{ok}/x_{ok}) = 0$  may vary with employed stimulus range, because its sensation distance from adaptation level equals the distance to the sensation-range midpoint. Here this is immaterial, because without loss of generality

$$s_{ik} = \tau_k \cdot [\ln(x_{ik}/x_{ok}) - \ln(b_k/x_{ok})] = (Y_{ik} \cdot a_k)/(a_k/a).$$

This expresses the bipolarity and relativity of sensations, because the actual sensations  $s_{ik}$  are then proportional to the difference between the Fechnerian sensation  $y_{ik}$  and existing adaptation level  $a_k$  on sensation dimension  $k$ . The individual or Fechner-Helson sensation is used for this Fechnerian sensation difference, if constant adaptation levels are individually different. Also individually different weights for sensation scales may apply, which individual weights become distinctly defined, constant scale unit parameters, as shown in the sequel. By their exponential transonnations the subjective stimulus magnitudes  $z_{ik} = \exp(s_{ik})$  become equivalently expressed by a power function of the ratio of stimulus intensity and the adaptation level as

$$z_{ik} = \exp(s_{ik}) = \exp[(Y_{ik} - a_k)C/a_k] = (x_{ik}/b_k)^{\tau_k}.$$

We may view subjective stimulus magnitudes  $z_{ik}$  as a power function of the so-called rectangular Euclidean co-ordinate  $x_{ik}/b_k$  of a hyperbolic sensation co-ordinate  $s_{ik}$  with origin  $Y_{ik} - a_k = 0$  that corresponds to  $z_{ik} = x_{ik}/b_k = 1$ . So Stevens did not describe

sensation dimensions, but power-raised stimulus dimensions as subjective stimulus magnitudes that represent sensation dimensions in another geometry. Although both measures represent the same, they are representations in different geometries. This is further discussed in chapter 3, where we demonstrate that either a power-raised Euclidean stimulus space corresponds to a weighted hyperbolic sensation space or a power-raised non-Euclidean stimulus space to a weighted Euclidean sensation space.

Notice that Fechner-Helson sensations no longer depend on the unit of the ratio scale of stimulus intensity, but depend on the individual adaptation level as the sensation scale value of the geometric average of randomly presented stimuli or for cognitive objects as stimuli the Fechner-Helson sensations depend on average of memorised sensations of previously experienced, similar objects. Thus, there are no objective sensations, but individual sensations as relative values defined by differences between logarithmically transformed stimulus intensities and the individual adaptation level, which individual sensations without a defined scale unit are called Fechner-Helson sensations. The individual adaptation levels, however, can be common and constant for sensations from an identical stimulus context. In Stevens' (1957,1960) studies the stimulus set is constant and randomly presented stimuli are compared with an anchor stimulus or anchor stimuli at the stimulus range bounds of the stimulus set. Thereby, the adaptation level of individuals will approximately be the same as Fechner sensation of the geometric average of repeated anchor and presented stimuli, where that average mainly depends on the anchor stimulus or anchor stimulus pair (Guilford. 1954, p.333). In studies wherein a stimulus set is shown prior to the evaluation of its randomly presented stimuli without any anchor stimulus the adaptation level will equal the average sensation of the stimuli. Although the adaptation level of randomly presented stimuli may vary somewhat by the influence of the most recently presented stimuli. averaged over individuals the adaptation level of randomly presented perceptual stimuli will be the average sensation level of the stimuli. Helson (1964) verified this by using Guilford's (1954, p.204-205) category scaling of subjective numerosness for spot patterns on card squares of 2.5 x 2.5 inches with a number  $n_i$  of spots that ranged from  $n_1 = 15$  to  $n_9 = 75$ . Guilford found

$$c_i = 9.41 \cdot \log_{10}(n_i) - 9.36$$

where  $c_i$  is the median of assigned order numbers of the equal appearing categories for stimulus  $i$ , where Guilford numbered the ordered, equal appearing categories from 1 to 9. The log-linear relationship with correlation  $r = .998$  is almost perfect. Guilford took Fechner's law as

$$c_i = A \cdot \log_{10}(n_i / n_0)$$

with  $n_0$  as perception threshold of spot number, where  $\log_{10}(n_0) = .936/9.41 = 0.995$ . Since this gives  $n_0 = 9.9$ , Guilford (1954, p. 206) wondered how a almost 10 spots could be the perception threshold. However, according to the Fechner-Helson psychophysical function, sensations are deviations from the average Fechner sensation of the stimuli. Since Helson's modification defines that the average sensation to correspond to the median category number 5, while scale  $c_i$  is linearly undetermined, Guilford's log-linear relationship becomes written as

$$[c, - 5]/9.41 = \log_{10}(n_j) - (9.36 + 5)/9.41 = \log_{10}(n_j) - 1.526,$$

which is written in Napierian logarithms as

$$[c, - 5]/4.09 = \ln(n_j) - 3.51.$$

For  $m_i = [c, - 5]/a_n$  and weighted sensations  $[10(0_j) - a_n]/a_n$  it rewrites as

$$m_i = [\ln(n_j) - a_n] / a_n = [10(0_j) - 3.51] / 0.244$$

whereby

$$a_n / \alpha_c \approx 0.244 \quad \text{and} \quad a_n = 3.51.$$

If Helson's modification of Fechner's law is correct, then  $a_n$  should be the logarithm of the geometric mean of spot numbers. Since the spot numbers range from 15 to 74, the logarithm of the geometric average is  $\sqrt{2} \ln(15 \cdot 74) = 3.506$ . Rounded of to 3.51 this indeed equals  $a_n = \ln(b_n)$  for geometric average spot number  $b_n = \exp(3.506) = 33.315$ . Thus, Guilford's log-linear relationship verifies the Fechner-Helson psychophysical function. Moreover, since

$$m_{\min} = \ln(n_{\min} / b_n) / (a_n / \alpha_c) \quad \text{and} \quad m_{\max} = \ln(n_{\max} / b_n) / (a_n / \alpha_c),$$

we obtain

$$a_n / \alpha_c = \ln(n_{\max} / n_{\min}) / (m_{\max} - m_{\min}).$$

Thus, if the log-linear relationship fits well then Helson's modification of Fechner's law also implies that the factor  $a_n / \alpha_c \approx 0.244$  must approximate the ratio of range bounds for Fechner-Helson sensations  $\ln(n_j / b_n)$  and means  $m_i$  of the equal appearing categories that were arbitrary numbered from 1 to 9. The two lowest and highest spot numbers (15, 16) and (74, 69) have mean category numbers of respectively 1.84 and 8.21 in Guilford's (1954, p.203) study, whereby category range  $(m_{\max} - m_{\min}) = 6.37$ . The range of logarithmic spot numbers  $\ln(n_{\max} / n_{\min}) = \ln(71.5/15.5) = 1.53$ . Thereby, we see that their range ratio  $1.53/6.37 \approx 0.240$  indeed closely approximates  $a_n / \alpha_c = 0.244$ . Since the category range  $(m_{\max} - m_{\min})$  varies with the arbitrary numbering of the categories, the value  $a_n / \alpha_c \approx 0.244$  is not a meaningful parameter in contrast to  $a_n$ . We conclude that this reformulated analysis of Guilford's study confirms the Fechner-Helson psychophysical function, because the fitted and theoretically expected parameters are almost identical, despite the questionable scaling method by mean rank order numbers of equal appearing category intervals.

For sensations  $s_{ik}^k$  of stimuli  $x_{ik}^k$  for modality  $k$  with  $b_k$  as geometric stimulus average or  $\ln(b_k) = a_k$  as arithmetic average of  $\ln(x_{ik}^k)$ , the Fechner-Helson function writes as

$$s_{ik}^k = (y_{ik}^k - a_k) / \alpha_k = [\ln(x_{ik}^k / \mu_k) - \ln(b_k / \mu_k)] / \alpha_k = \ln(x_{ik}^k / b_k) / \alpha_k.$$

The Fechner-Helson sensations as logarithmic ratios of the stimulus intensities and stimulus adaptation level depend not on the measurement unit  $\mu_k$  of stimulus scale  $k$ . Stevens' power function for magnitude evaluations of compared sensory sensations not only requires a magnitude evaluation of the sensation deviations from a common adaptation level, but also a weighing of sensation differences for the equality matching with magnitude sensation differences. The comparability weighing of Fechner-Helson sensations defines intensity-comparable sensations by the weighted matching with cognitive magnitude sensations, where according to our derivations the matching

weight equals the almost constant value of Stevens' power exponent for each modality. Poulton (1967, 1968) argued that the different sizes of power exponents for different modalities "are merely a function of the experimental conditions under which they were determined". According to Poulton, the most important condition is the ratio of maximum and minimum intensities of the stimuli employed in the studies. The size of the power exponent would then seem a 'procedural artifact', which is supported by the reported high rank correlation between power exponent size and the ratio of the stimulus range values (Poulton, 1967; lanes and Woskow, 1962) for different modalities in many studies of Stevens and co-researchers. Teghtsoonian (1971) analysis shows a curved relationship between power exponents and ratio of range values for employed stimulus intensities with Pearson correlation  $r=0.935$  between predicted and observed power exponents for 24 different modalities with different ranges and power exponents. Different employed ranges for the same modality show (Teghtsoonian, 1973) that the power exponents only are weakly influenced by stimulus range. Since inter- and intra-modal power exponents are quite differently influenced by different ranges, the power exponents are not 'procedural artifacts' of employed ranges. Notice that logarithm of the ratio for two subjective stimulus magnitudes in Stevens power exponent expression yields

$$\ln(z_k/z_j) = s_{jk} - \tau_k \ln(x_{jk}/x_{jk}')$$

Teghtsoonian (1971) takes  $x'_{jk} = x_{k+}$  as the maximum and  $x_{jk} = x_{k-}$  as the minimum intensity of the employed stimulus range for his relationship between power exponent and employed stimulus range. Rewritten for range values  $z_k = z_{k+}$  and  $z'_k = z_{k-}$  it defines the power exponent by

$$\tau_k = \ln(z_k/z_{k-}) / \ln(x_{k+}/x_{k-}),$$

where  $\ln(z_k/z_{k-})$  is a modality-specific parameter. However, Teghtsoonian showed that  $\ln(z_k/z_{k-}) = \log_{10}(z_{k+}/z_{k-}) = 1.53$  is virtually constant and, thus, a modality-independent parameter in the relationship

$$\tau_k = 1.53 / \log_{10}(x_{k+}/x_{k-}),$$

with correlation  $r = .935$  between experimentally obtained and predicted power exponents of 24 different modalities. Thus, although the ratios of employed stimulus-range bounds varied from 1.15 for electric shock to 13.82 for brightness, the subjective stimulus magnitude range is almost constant as  $\log_{10}(z_{k+}/z_{k-}) = 1.53 \pm 0.04$ . Since the power exponent  $\tau_k$  equals the weight factor of intensity-comparable sensations, the comparability weight is proportional to the inverse of the employed sensation range. The range of perceptual modalities differs naturally in upper and lower intensity limits. Also their just noticeable stimulus levels markedly differ in energetic level, although diminishingly decreasing by gradual adaptation to the lower range bound of employed stimuli (Hecht, et al., 1937; Bartley, 1951; Licklider, 1951; Pfaffmann, 1951). Most studies used a fairly wide stimulus-intensity range, but Teghtsoonian (1971, p.74) remarked that maximum ranges from absolute threshold stimulus  $x_{k,min}$  to just not-damaging stimulus  $x_{k,max}$  are likely not used. He reasoned, based on diminishingly decreasing power exponents for higher located stimulus ranges of the same modality, that the maximum power exponent is better expressed by  $\tau_k = 1.53 / \log_{10}(x_{k+}/x_{k-})$  plus



a range-dependent factor. But, since ratio  $r_m = [\log_{10}(x_{k,max}/x_{k,min})/\log_{10}(z_+/z_-)]/\ln(z_+/z_-)$  varies with the cognitive magnitude ranges as ratio  $r_m = \log_{10}(z_+/z_-)/\ln(z_+/z_-)$ , we rather define that change of their corresponding power exponents by a proportional factor  $r_m < 1$ . Expressed in Napierian logarithm

$$\ln(z_+/z_-) = \ln(10) \cdot \log_{10}(z_+/z_-) / r_m = 2.30 - 1.53 / r_m = 3.52(r_m),$$

whereby the relation between power exponent and stimulus range is written by  $r_m < 1$  as

$$\tau_k = 3.52 / [r_m \cdot \ln(x_{k,max}/x_{k,min})],$$

where  $\ln(x_{k,max}/x_{k,min})$  is the maximum sensation range that corresponds with the maximum range  $\ln(z_+/z_-)$  of cognitive magnitude sensations. Assuming that the maximum sensation range has the same midpoint as employed sensation ranges with the adaptation point as midpoint, it follows that we may write

$$a_k = \ln(x_{k,max}/x_{k,min}) = \sqrt{2} \ln(x_{k,max}/x_{k,min}).$$

Steven's power exponent  $\tau_k$  equals  $a/\alpha_k$  as the weight factor of intensity-comparable sensations  $\ln(x_{k,max}/x_{k,min})/a_k$  that cognitively match with magnitude sensations  $\ln(n/b)/\alpha$ , whereby

$$\tau_k \cdot r_m = (\alpha \cdot r_m) / \alpha_k = 3.52 / (2 \cdot a_k) =: 1.76 / a_k,$$

$$\alpha_k = (a \cdot r_m / 1.76) \cdot a_k,$$

where  $1/\alpha$  is the Stevens power exponent for magnitude estimation of metric magnitude. Attneave (1962) and Rule (1969, 1971) found power exponents with an average of .40 and a range between .50 and .33 for apparent magnitude estimates of metric quantity. Power exponents of .33 to .5 for metric quantity may imply that the sensations of cognitive quantity are a mixture of volume and area sensations, because volume raised to power  $1/3$  and area raised to power  $1/2$  is length, where sensations of length may correspond to the cognitive magnitude sensations for the matching in fraction estimates. Generalised cognitive quantity as mixture of area and volume is in line with the findings of Piaget (1963) that conservation of quantity in varying three-dimensional forms is difficult for youngsters and too difficult below the age of 12 years. The cognitive magnitude sensations of metric magnitudes then should be equal to the sensations of length or distance. This is sustained by the average power exponent of unity for magnitude estimation of lengths and distances, where the power exponents reduce from 1.12 to .88 for ranges of small line lengths to very large distances, as reported in studies of Stevens and Galanter (1957); Ono (1967), Mashhour and Hosman (1968), and Teghtsoonian (1973). Since  $\tau_m = 1$  defines a matching of cognitive magnitude sensations  $m$ , with averaged length and distance sensations, cognitive magnitudes equal averaged length and distance sensations with  $\alpha = 1$ . The power exponent of length for stimulus ranges  $\ln(\text{length}_{max}/\text{length}_{min}) > 4$  decreases to its limit  $\tau_m \cdot r_m = .88$  (Teghtsoonian, 1973), whereby  $r_m = .88$  is the factor for the maximum range of cognitive magnitudes. The meaning of  $\alpha = 1$  and  $r_m = .88$  is important, because it defines the inverse weight for intensity-comparable sensations as:

$$\alpha_k = (\alpha \cdot r_m / 1.76) \cdot a_k = (.88 / 1.76) \cdot a_k = 1/2 a_k = 1/\tau_k.$$

Thereby Stevens' power exponents equal twice the inverse value of the adaptation level on the Fechnerian sensation scale. The weighted Fechner-Helson sensations become intensity-comparable sensation magnitudes that are defined by

$$s_{ik} = [\ln(x_{ik}/b_k)]/\alpha_k = 2[Y_{ik} - a_k]a_k \dots 2[Y_{ik}/a_k - 1]$$

for  $\alpha_k = 1/2a_k$  and rewritten for  $a_k = \ln(b_k/x_{uk})$  by

$$s_{ik} = 2[\ln(x_{ik}/x_{uk}) - \ln(b_k/x_{uk})]/\ln(b_k/x_{uk}) = 2[Y_{ik}/a_k - 1]$$

for Fechnerian sensation  $Y_{ik} = \ln(x_{ik}/x_{uk})$  with adaptation level  $a_k = \ln(b_k/x_{uk})$ , where  $x_{uk}$  is the just noticeable stimulus level for the sensation threshold  $\ln(x_{uk}/x_{uk}) = 0$ . Notice that the comparably weighted Fechner-Helson sensations are expressed by the ratio of differences and a fixed distance on the Fechner scale  $Y_{ik} = \ln(x_{ik}/x_{uk})$  whereby intensity-comparable sensations are *invariant under linear transformations of the underlying Fechner scale*. The significance of this invariance for measurement in psychology is further discussed in chapter 6, but it may already be clear that the measurement of intensity-comparable sensations  $s_{ik}$  is invariant under changes of scale unit and origin of the underlying interval scale of Fechner sensations.

The relationship between estimated power exponents and employed stimulus ranges in the magnitude estimation of Stevens and co-researchers holds across different stimulus modalities, despite the marked differences in the physical intensity ranges of the different modalities. Thus, the judgmental range of subjective stimulus magnitudes of all modalities appears to be approximately constant, as Teghtsoonian (1971) concluded. However, we add that this must be due to the implicit matching with a common range of cognitive magnitude sensations in the studies of Stevens and co-workers. Teghtsoonian (1973) also showed that intra-modal changes of the geometric range of the employed physical stimulus intensities only has a minor effect on the estimated size of the power exponent. Although the power exponent of Stevens decreases somewhat with increases of the range for presented stimulus intensities of the same modality in experiments using fractionation or direct magnitude estimation, these experiments yield almost stable power exponents. For  $\alpha = 1$  and  $u_k = 1/2a_k$  we have

$$\tau_k = \alpha/\alpha_k = 2/a_k = 2/\ln(b_k/x_{uk})'$$

whereby a rather stable value of power exponents in Stevens magnitude estimations implies that the distance between adaptation level  $\ln(b_k/\mu_k)$  and the just noticeable sensation level  $\ln(x_{uk}/\mu_k) = 0$  has to remain also rather stable. It means that the just noticeable stimulus intensity  $x_{uk}/\mu_k$  changes its position on stimulus scale  $k$  approximately as much as the geometric average stimulus intensity  $b_k$  for shifted stimulus ranges. This may very well hold for the usually employed stimulus ranges well above the absolute stimulus threshold of perception. However, since the just noticeable level  $\ln(x_{uk}/\mu_k)$  can't shift below the absolute sensation threshold  $\ln(x_k/\mu_k)$ , it is also to be expected from the reciprocal relationship between power exponent and adaptation level that the size of the power exponent increases somewhat if the intra-modal stimulus range decreases and the more so the closer the upper range level becomes to the absolute stimulus threshold  $x_{ok}$ . This is also empirically shown to be the case. Already Stevens and Poulton (1956) obtained by the magnitude estimations of 1000 Hz

tones of 40, 20, 10, and 6 db above absolute threshold with respect to a standard of 100 db that the four estimated power exponents increased respectively from .46, .52, .60 to .67, while Teghtsoonian (1973) reported power exponent sizes of .88, .90, .91, and .97 for apparent distance of objective distances that range respectively from 5 to 480, 10 to 450, 5 to 110 and 5 to 37 ft in outdoor setting. Similar matters hold for somewhat shifting power exponents of loudness and apparent length (Teghtsoonian, 1973). The variation of average power exponents between different modalities ranges from 2.5 for electric shock to 0.30 for monocular brightness. Due to the neurophysiologically differing ranges of perception organs for different stimulus modalities the variation of power exponents within modalities can indeed be small compared to the variation of power exponents between different modalities.

For  $z_k$  as subjective stimulus magnitudes we derive from

$$\text{and } z_k = \exp(s_k) \cdot (x_k b_k)^{\tau_k}$$

$$z_k + \delta(z_k) = \exp[s_k + o(s_k)] \cdot [x_k b_k + o(x_k b_k)]^{\tau_k},$$

that the ratio of these expressions defines

$$1 + o(z_k)/z_k = \exp[o(s_k)] = (1 + \delta(x_k)/x_k)^{\tau_k}.$$

Here  $o(x_k)/x_k$  is Weber's (834) fraction and  $\tau_k$  Stevens' power exponent, while Teghtsoonian (1971, 1974) also derived from the relationship between Weber fractions and Stevens power exponents in nine pairs of studies with similar stimulus conditions that  $\delta(z_k)/z_k = 0.03$  is constant within rounding off errors  $< 1.0041$ . The modality-independent constancy of magnitude fraction  $\delta(z_k)/z_k = o(z_k)/z_k$  has been an implicit assumption of Brentano (1874) who described perception of stimuli not as sensation intensity, but as a mental act that immanently relates to physical objects (Boring, 1950, p.356-361, Stevens, 1975, p. 234; Staddon, 1978). The constancy of  $o(z_k)/z_k$  has been seen by Teghtsoonian (1974) as more evidence for Stevens power function than for Fechner's logarithmic function. However, according to our derivation of weighted, intensity-comparable Fechner-Helson sensations, Stevens' reference to Brentano's constant fraction is just an analog of a constant interval  $\delta_m$  as the just noticeable difference (jnd) of cognitive magnitude sensations that equals the jnd of intensity-comparable sensations as well as the product of Stevens' power exponent and the modified Weber fraction of stimulus intensities of each modality, because the logarithm of the last expression above yields

$$\delta_m = o(s_k) = \tau_k \cdot \ln(1 + \kappa_k) = \ln[1 + o(z_k)/z_k] = \ln[1 + .03] = .0296$$

for all modalities  $k$  with  $\delta(s_k) = o[2(y_k - a_k)/a_k]$  for different weights  $2/a_k$  of intensity-comparable sensation intensities. Constancy of  $\delta(z_k)/z_k = .03$  in magnitude estimations for all modalities is not surprising at all, because deriving from the matching with cognitive magnitude with jnd  $\delta_m = .0296$  that remains equal for any modality  $k$  that is matched with cognitive magnitude. Constant jnd  $\delta_m = .0296$  for magnitude sensations and the fraction constancy of  $\delta z_k/z_k$  of numerical assigned values, thus, only mean constant just noticeable differences for cognitive magnitude sensations that are matched with sensation jnd's of modalities in the magnitude estimation of these modalities. For

ratio  $a_h/a_k$  of two modalities we obtain

$$a_h/a_k = \tau_k/\tau_h = \ln[1 + \kappa_h]/\ln[1 + \kappa_k] = \ln(x_h/x_{h-})/\ln(x_k/x_{k-})$$

If  $x'_h$  is the metric magnitude  $x'_h = z_h = \exp(m_h)$  for  $m_h$  as cognitive magnitude sensations then  $\tau_h = 1$ ,  $\delta_m = \ln[1 + \kappa_h]$ , and  $\ln(x_h/x_{h-}) = \ln(z_h/z_{h-}) = m_h - m_{h-}$ , whereby

$$\tau_k = \delta_m / \ln[1 + \kappa_k] = 0.296/10[1 + \kappa_k] = \ln(z/z_-)/\ln(x_k/x_{k-}),$$

or

$$\ln(x_k/x_{k-})/\delta_m = (m_k - m_{k-})/\delta_m = \ln(x_k/x_{k-})/\ln[1 + \kappa_k]$$

It says that magnitude estimation of stimulus intensities is defined by a matching of a number of jnd's  $\delta_m$  for cognitive magnitude sensations with an equal number of jnd's  $\ln[1 + \kappa_k]$  for sensations of a stimulus modality  $k$  with respect to  $m_k = a_k$  and  $x_{k-} = b_k$ . Moreover, from the estimates  $\delta_m = 0.296$  and  $\ln(z/z_-) = 3.52$  we obtain

$$\delta_m = 0.296 \quad \text{and} \quad z/z_- = \exp(3.52) = 33.784$$

So from Teghtsoonian's (1971, 1974) analyses we see that the constant jnd  $\delta_m$  also determines the ratio of metric magnitude-range values  $z/z_-$ . Summarising the empirically sustained integration of Helson's (1964) adaptation-level theory and Fechnerian psychophysics, we regard Teghtsoonian's findings of constant  $\delta_m = 0.296$  and  $\ln(z/z_-) = 3.52$  as firm evidence for the hypothesis that the subjective magnitudes of Stevens' psychophysics are based on matching of weighted Fechner-Helson sensations with cognitive magnitude sensations as generalised sensations of line lengths and distances. Thereby, Stevens' power exponents equal twice the inverse value of the adaptation level for randomly presented stimuli.

Referring to formula (III) and taking  $b_k$  as momentarily static, geometric mean of the stimuli  $x_{ik}$  on scale  $k$  up to time  $t$  and  $a_k$  as corresponding adaptation level on sensation scale  $y_{ik}$  one obtains the adaptation level as:

$$a_k = \frac{\sum_{i=1}^{n_t} y_{ik}}{n_t} = \ln(b_k) = \frac{\sum_{i=1}^{n_t} \ln(x_{ik})}{n_t} \quad (14)$$

where  $n_t$  denotes the number of successive stimuli  $x_{ik}$  on scale  $k$  in time interval  $t$ . For simplicity of presentation we assumed that stimuli are randomly sampled from a stimulus set with a geometric stimulus mean that defines an arithmetic sensation mean. We also assume that a prior existing adaptation level is irrelevant, emitting individual indexes, the sensation  $s'_k$  of stimulus intensity  $x'_k$  becomes according to adaptation-level theory

$$\text{or} \quad 2(Y_{ik} - a_k)/a_k = 2\ln(x_{ik}/b_k) \quad (15a)$$

$$\left(\frac{x_{ik}}{b_k}\right)^{2/a_k} = e^{2(y_{ik} - a_k)/a_k} = s_{ik} \quad (15b)$$

where the weight is determined by  $1/a_k$  for  $a_k$  as adaptation level of intensity-comparable sensation scales  $s_{ik}$  on scale  $k$ .

Sensations as weighted differences from adaptation level specifies two types of invariance. One with respect to the unit of the physically measured stimulus scale, as (ISb) shows. The other invariance is with respect to linear transformations of their Fechner sensation scales. Suppose  $Y_{ik}$  is linear transformed as  $w \cdot y_{ik} + U$ , then an intensity-comparable sensation scale becomes:

$$2[(w_k \cdot Y_{ik} + U) - (w_k \cdot a_k + U)] / (w_k \cdot a_k) = 2(Y_{ik} - a_k) / a_k \quad (15c)$$

where the transformation parameters  $w_k$  and  $U$  cancel out. Intensity-comparable sensations of (15c2) show a third invariance. Oppositely signed sensations of stimulus fractions with respect to  $x_{ik}/b_k = 1$  can only be the sensations for an inverse stimulus fraction. This follows from (15c) as

$$(b_k/x_{ik})^{2/a_k} = e^{-2(y_{ik} - a_k)/a_k} = e^{-5} \quad (15d)$$

Hereby, the absolute magnitude of individual sensations as sensation distances to individual adaptation levels remain the same whether a stimulus is represented by magnitudes of an aspect or by magnitudes of the opposite aspect as its inverse values, which does not hold for the power function of Stevens. Since these kinds of invariance are based on the integration of Helson's adaptation-level theory and Fechner's psychophysics, we call (ISa) or (ISb) the Fechner-Helson psychophysical function, whereof inverse stimulus values also correspond to reflected sensations with the individual adaptation level  $a_k = 0$  as origin.

Using (ISa) and (ISb) we obtain

$$s_{ik} = (y_{ik} - a_k) / a_k = \frac{\ln(x_{ik}/b_k)}{\ln(b_k/u_k)} = \frac{\ln(x_{ik}/u_k)}{\ln(b_k/u_k)} - 1 \quad (15e)$$

where independently of measurement unit  $\mu$  the value of  $u_k$  is defined by  $u_k/\mu$  as just noticeable stimulus level that depends on  $b_k/\mu$  as adaptation level of an individual. It defines again the invariance under linear transformation of  $Y_k = \ln(x_k/\mu)$ , due to its ratio of differences  $\ln(x_k/\mu) - \ln(b_k/\mu)$  and distance  $\ln(b_k/\mu) - \ln(u_k/\mu)$ . Thus, any stimulus ratio scale may apply to (15e), while the unit of sensation scales equals half the interval between adaptation level  $\ln(b_k/\mu)$  and just noticeable level  $\ln(u_k/\mu) = 0$ . Although akin to Fechner's assumption, we only take  $\mu = u_k$ , but don't assume that  $u_k$  is constant by defining  $\ln(u_k/\mu) = 0$  as varying, just noticeable sensation level, where  $\ln(b_k/u_k) > \ln(u_k/\mu) = 0$ .

Notice also that Stevens' power exponent equals  $-k = 2/a_k$ , whereby the power-raised stimulus scale of (15c) is then written as

$$(x_{ik}/b_k)^{2/a_k} = e^{2(y_{ik} - a_k)/a_k} = e^{s_{ik}} \quad (ISf)$$

Suppose we take the psychophysical function as Stevens' power function (13a) and assume that adaptation-level theory applies then we obtain

$$[(x_{ik}/\mu)^k] / [(b_k/\mu)^k] = (x_{ik}/b_k)^k \quad (ISg)$$

Thus, Stevens' psychophysics and adaptation-level theory are compatible.

Stimulus-produced changes in adaptation level may explain the observed distortions from Fechner's function (12b) or from Stevens' function (Ba) in the magnitude estimations by fractionation, due to order and spacing effects of stimulus presentations or to anchoring effects of standard stimuli (Corso, 1971). Since adaptation level can't decrease below the absolute just-noticeable level, the so-called bias parameter in psychophysical scaling becomes defined by changes of adaptation level  $b_k/u_k$  for different stimulus selections.

However, (159) differs from threshold corrections as subtraction factor, suggested by Luce and Galanter (1963b, p.281). Moreover, a subtraction correction for Stevens' power function in (159) gives inconsistencies, if applied to psychophysical generalisation (Luce and Galanter, 1963b, sec. 4.5). The conclusion is that (15b) with  $\tau = 2ja$  for Stevens' power function and (15a) for Fechner's logarithmic function give the only consistent integration of psychophysics and adaptation-level theory.

The exponential transformation of intensity-comparable sensations defines a power-raised stimulus fraction scale that has its adaptation level as unit of the stimulus scale, whereby intensity-comparable sensation scales don't depend on the measurement unit of the stimulus scales. Luce (1959a) has proven that a psychophysical function can only be the power function, if both scales are ratio scales with dependent parameters. But our derivations imply that the power exponent and the scale unit of stimuli are both defined by the Fechner scale value of adaptation level, because defining also the origin and scale unit of comparable sensations. Moreover, due to the integration of Fechner's psychophysical function and Helson's adaptation-level theory, the inverse stimulus and the stimulus itself have equal absolute sensation values and reversed signs, because the stimulus intensity of the adaptation level is by definition unity for the stimulus fraction scale  $x.k/b_k$ . This psychologically required invariance and sign reflection of sensation intensities for reciprocal stimuli, -for example attribute  $\ln(x./b)$  as complexity and  $\ln(b/x.) = -\ln(x./b)$  as simplicity of the same object-, derive not from Stevens' power function. So adaptation-level theory and the invariance for stimulus-scale unit as well as the invariance of absolute sensations for mutually reciprocal stimuli are only consistent with the Fechner-Helson function. Intensity-comparable sensations become weighted by twice the inverse of the adaptation level distance to the just noticeable sensation. This ratio of variable Fechnerian sensation differences and fixed Fechnerian distance is invariant under linear transformations of the underlying Fechner scale and, thereby, enables cross-modality matching. Since for the first time Bower (1971) described a stimulus coding theory, remotely akin to the Krantz-Shepard relation theory of cross-modality matching (Krantz, 1972; Shepard, 1978, 1981), wherein Bower postulated that stimulus comparability is based on an equality of weighted sensation differences from adaptation level, we will denote the comparably weighted Fechner-Helson sensations as Bower sensations. Without the adaptation level as common reference point and without a weighing to intensity-comparable sensations, cross-modality matching could never yield consistent results. Arbitrarily scaled interval measurements of Fechner sensations and their cross-modality matching would define an arbitrary power function for the matched stimulus scales. For this reason Luce and

Galanter (1963b, p. 280) favoured Stevens' power law. However, for comparable sensations the translation and weighing are not arbitrary, because translated to distinct adaptation levels of individuals and meaningfully weighted by twice the inverse of the distance between adaptation and just noticeable levels for each modality, as discussed before and in the mathematical section above. For stimulus scales that are matched with metric magnitude it yields a constant matching power exponent as twice the inverse of the logarithm of the ratio of the adaptation and just noticeable stimulus levels for each modality. Since Stevens and his co-workers find rather constant power exponents for their fractionation method of magnitude scaling for employed stimulus range that are not close to the absolute thresholds of modalities, we also have rather constant ratios of adaptation and just noticeable stimulus levels. However, changing target stimuli and non-random sequential stimulus presentations inevitably has to change the adaptation level, which yields a basis for psychophysical dynamics by Helson's adaptation-level theory. Sensations as changing differences from a shifting adaptation level for identical stimuli, explain several controversial disparities (Luce and Galanter, 1963a, 1963b) from Fechner's or Stevens' law. So-called distortions by bias of Stevens' power function are shown to be effects of adaptation-level shifts produced by the stimuli themselves (Corso, 1971). For example, adjusting a stimulus to half the intensity of a target yields a higher intensity than matching a stimulus to a target stimulus with half the intensity of the former target stimulus.

### 2.1.3. *Comparable sensations and responses*

According to the discussion of section 1.5. and the integration of adaptation-level theory and learning theory, all learned evaluation responses, -thus, also the magnitude judgment response -, have to be a function of intensity-comparable sensations. Therefore, response theory has to be integrated with Helson's adaptation-level theory, which requires that the response function concerns a transformation of comparable sensation differences from adaptation level. Capehart and co-authors (Capehart et al., 1969) have formulated and verified such an integration in their stimulus equivalence theory based on a generalisation function of compared sensation differences from adaptation level that may shift in a stimulus-dependent way.

In Thurstone's comparative judgment (Thurstone, 1927a, 1959) the normal probability function of logarithmic stimuli determines the probability of judging a stimulus larger than a reference stimulus. For discrimination with equal-assumed standard deviations of sensations it constitutes a model that is called Thurstone's case V model. In the alternative response theory of Luce (1959b), based on his choice axiom. the logistic probability function of a sensation difference with respect to the sensation of the reference stimulus defines the discrimination probability. Logistic response probability function has been shown to apply to detection and recognition (Luce, 1963), discrimination (Luce and Galanter, 1963a), and psychophysical scaling (Luce and Galanter, 1963b), which function is also used in learning theory (Sternberg, 1963) and utility theory (Luce and Suppes, 1965). In view of error in response data Thurstone's normal probability function (case V) is hardly distinguishable from the logistic probability function (Luce and Galanter, 1963a, p. 221). The normal probability function for logarithmic transformed stimulus intensities equals the

cumulative log-normal distribution function that is used by Kapteyn (1977) for the utility curves of figure 2 in chapter 1. The integration of the normal distribution function, however, defines no explicit response function. Therefore, and for reasons of the geometric representation of multidimensional responses as transformed sensation spaces, discussed in chapter 4, we use the logistic probability function of Luce's response theory. Figure 10 shows the logistic probability function for discrimination responses with respect to a reference stimulus at  $p = 50$ .

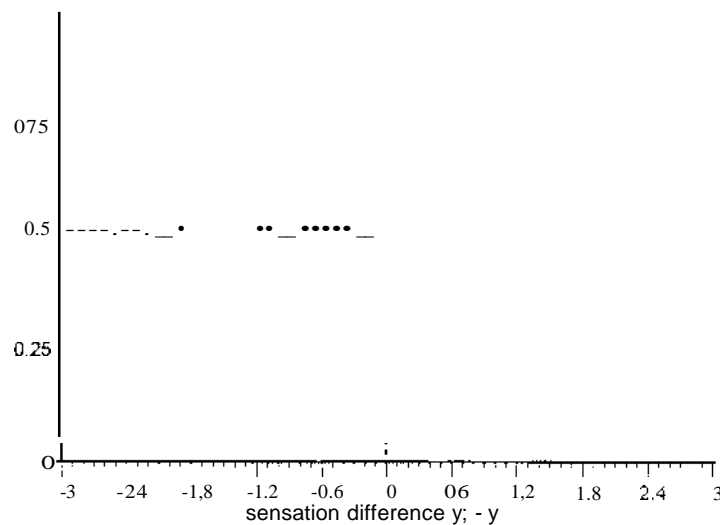

Figure 10. The logistic response probability for discrimination

Also in the beta-model of learning (Luce, 1959b) the frequency of learned responses is a logistic function of the frequency of learning trials (Sternberg, 1963). This function applies also to neural measurements of peripheral and brain reactions on stimuli relative to adaptation (Pribram, 1971) and underlying brain processes in learning (Olds, 1973). In the studies of Logan (1960) and Premack (1971) on the relationship between amount of reinforcement and stimulus intensity in learning trials have shown that learned stimulus-response patterns relate stimulus intensities and response strength in the same way as correct response probabilities are related to frequency of learning trials. The application of cumulative normal or logistic probability function in learning, however, can be questioned because other response models without an inflexion of the learning curve equally well describe many learning results (Sternberg, 1963 p. 37). This may be due to generalisation from earlier learning, whereby the first part of the learning curve generally remains unobserved.

According to Shepard (1958a) generalisation depends on the reinforcement schedule. Many results verify this (Staddon, 1983). One-sided logistic generalisation, as shown in figure 11, is to be observed if reward, non-reward and punishment are in that order obtained for increasingly deviating sensation intensity (Shepard, 1958a)



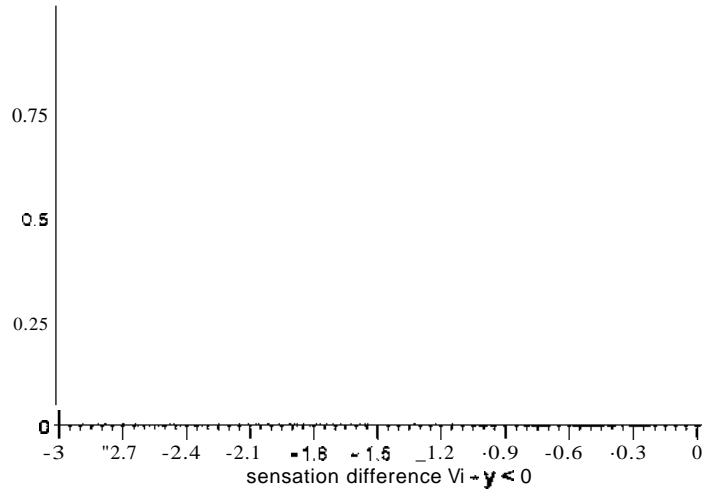

Figure 11. Logistic response curve/or unilaterally reinforced generalisation.

The function curves of figures 10 and 11 are translated curves, where here the probability of equivalence responses with respect to the reference stimulus approaches unity instead of half. The choice axiom and the logistic function for discrimination and generalisation as well as their scaling implications are treated by Luce and Galanter (Luce, 1959; Luce, 1963, sec. 1.2.; Luce and Galanter, 1963a, sec 3.2. and 4.2.; Luce and Galanter, 1963b, sec. 4.5.), but are also discussed in chapter 7 of this monograph.

The logistic response probability function of figures 10 and 11 for a reference level of sensation  $y_k$  and response probabilities  $P_{ik}$  to the relative sensation value  $y_{ik} - y_k$  is expressed by

$$P_{ik} | y_k = [1 + e^{-(y_{ik} - y_k)}]^{-1} \tag{16a}$$

For a scale unit of dimension  $k$  of unity we unify the expressions for discrimination responses of figure 10 with  $P_{ik} | (y_{ik} = y_k) = 0.5$  and generalisation responses of figure 11 with  $P_{ik} | (y_{ik} \leq y_k) \leq 1$ . In terms of (15d) with  $a_k$  and  $b_k$  replaced by  $Y_k$  and  $x_{ik}$ , it becomes written by

$$P_{ik} | x_k = 1 / [1 + (x_k / x_{ik})] \tag{16b}$$

Exponential generalisation applies if generalisation learning is restricted to positively reinforced stimuli above a reference level. Exponential generalisation (Shepard, 1958b; 1987) is described by an exponential decay function of the sensation distance from the reference sensation. If stimuli above some reference level become rewarded, then the probability of expected reward responses becomes the complement of the exponential generalisation curve for intensities above a reference level, as shown in figure 12.

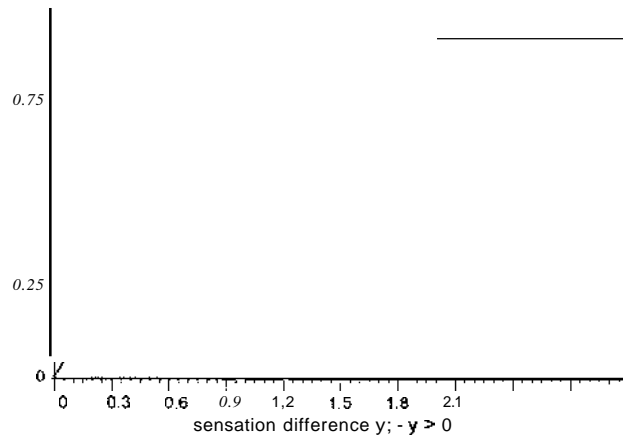

Figure 12. Expected reward response curve for rewards above target sensation  $y$

Anticipatory responses of expected reward for sensations become also associated with positive hedonic sensations. The vertical axis of figure 12, therefore, also expresses standardised hedonic response-sensation values that are associated to perceptual sensations. If punishments are increasingly given below a particular intensity level, then the expected aversion response curve is reversely derived as shown in figure 13.

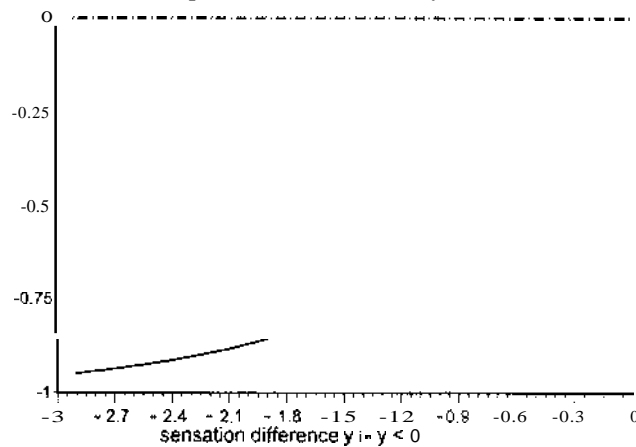

Fig. 13. Expected aversion-response curve for punishments below target sensation  $y$

By weight  $1/w_k$  for strength of associated reinforcement the curve for reward expectancy responses of figure 12 becomes written as

$$vikl(y_{ik} > Y_k) = 1 - e^{-\frac{(Y_{ik} - Y_k)l}{w_k}} \quad (17a)$$

and curve for aversion expectancy responses of figure 13 as

$$vikl(y_{ik} < Y_k) = -1 + e^{-\frac{(Y_k - y_{ik})l}{w_k}} \quad (17b)$$

The monotone functions of figure 12 and 13 resemble the functions of Luce (2000) in his axiomatic measurement of rank- and sign-dependent utility for gains or losses. Luce's utility measurement is relative to a status quo level with zero utility, which is our neutral adaptation level. The differences are that Luce replaces our relative sensations by objective gain or loss values that are evaluated with respect to the 'status-quo' and introduces for subjectively smaller gains than losses of equal value amounts a smaller limit for positive gain utilities than for negative loss utilities. We further discuss Luce's utility measurement in section 6.1.3., but already remark that if relative value sensations, instead of objective gain or loss values, would be used then no smaller utility limit for gains than losses is needed, because the utility for gains becomes already smaller than the negative utility for equal losses by the logarithm of objective values and translation to value-sensation differences from adaptation level.

## 2.2. Metric response and monotone valence functions

### 2.2.1. The response and monotone valence function

A single valence function for expected reward or punishment with a logistic shape can be derived from the exponential curves for expected reward or punishment. We may assume some generalisation for rewards and punishments that are more or less consistently conditioned respectively to sensations above and below a reference level, whereby some symmetrically diminishing expectancy of punishment above and reward below reference level occurs. The curves of figures 12 and 13 under such diminishing generalisation around their connection points as reference level become combined to the hyperbolic tangent function with the reference level as origin. In accordance with Shepard's (1958a) generalisation functions and our ogival symmetry and bipolarity for reward and punishment expectancy, the hyperbolic tangent function equals the logistic probability function that is multiplied by 2 and translated by -1, as shown by figure 14.

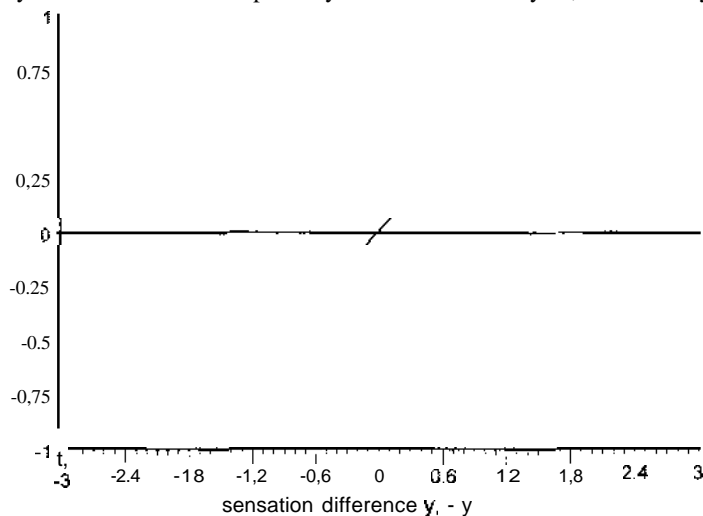

Figure 14. The hyperbolic tangent as response or monotone valence junction

This hyperbolic tangent function is called the forward monotone valence function of preferential responses. Since it equals the linear transformed logistic probability function of figure 10, it also describes the judgmental response function.

The hyperbolic tangent function for positive values above and negative values of responses or monotone valence below level  $a_k$  of an intensity-comparable sensation dimension is written (Courant, 1960, p.184) by

$$v_{ik} = \tanh\{(y_{ik} - a_k)/a_k\} = \frac{1 - e^{-2(y_{ik} - a_k)/a_k}}{1 + e^{-2(y_{ik} - a_k)/a_k}}. \quad (1Ba)$$

Since (1Ba) and (16a) are related by

$$v_{ik} = 2P_{ik} - 1, \quad (1ab)$$

it defines the hyperbolic tangent function as the linear transformed logistic probability function for discrimination responses. Taking  $r_{ik}$  for  $v_{ik}$  we also have the evaluative response  $r_{ik}$  for sensations with respect to adaptation level. Expression (1Ba) is thus the evaluative response function and the preference function for monotone valences. For  $b_k = \exp\{a_k\}$  and substituting (16b) in (18b) we rewrite the response function  $r_{ik}$  also as function of stimuli with power exponent  $\tau = 2/a_k$  for sensation dimension  $k$  with adaptation level  $a_k$ .

$$\begin{aligned} 1 + (b_k/x_{ik})^{\tau} &= 1 + (x_{ik}/b_k)^{\tau} \\ 1 + (b_k/x_{ik})^{\tau} &= 1 + (x_{ik}/b_k)^{\tau} \end{aligned} \quad (19)$$

where we see that individual responses to stimuli may only differ by the influence of the location of the stimulus adaptation level  $b_k$ .

In projective geometry (Busemann and Kelly, 1953; Coxeter, 1957) a point  $r$  is a projectivity of a point  $x$  if  $r$  is a linear fraction of  $x$ ,

$$r = \frac{c \cdot x + d}{a \cdot x + b} \quad (20)$$

For  $r = r_{ik}$  and  $x = (b_k/x_{ik})^{\tau}$  in (20) it becomes identical to (19) if  $a = b = c = -d = 1$ . Expression (20) for  $b = c$  and  $a = -d$  describes a hyperbolic involution. By its unit parameters this linear fraction function describes a projectivity of a line onto itself with respect to unit point  $x_{ik}/b_k = 1$ , whereby responses are hyperbolic involutions of stimuli with respect to the stimulus adaptation point  $x_{ik}/b_k = 1$  that corresponds to  $r_{ik} = 0$ .

Formula (20) with  $-r = r_{ik}$  and  $x = (b_k/x_{ik})^{\tau}$  for  $b = -c$  and  $a = d$  gives an elliptic projectivity. Whether an elliptic projectivity could also apply to judgement or preference responses is discussed in chapter 4.

In order to obtain figure 14 from figure 10 one multiplies the vertical axis by two and translate it by minus unity. This linear transformation of the logistic response probabilities in figures 10 is the hyperbolic tangent function of sensation intensity. The

same applies to figure 11, but there the reference level is then shifted to the midpoint of the generalisation response curve. The midpoint is the inflexion point where its derivative turns from negative to positive, while it also is the point where below expected punishment or non-reward dominates over expected reward for responses and where above the reverse applies. Thus, the midpoint also represents the neutral valence of balanced punishment and reward expectancy from sensations below and above the sensation level with zero valence. As such it corresponds to the adaptation level as the average sensation of the presented stimuli and as level of sensation intensity that, by affective adaptation becomes also a neutral valence point. Therefore, the hyperbolic tangent function applies as well to the evaluative responses as to preference responses for a sensation scale with a forward monotone valence function around adaptation level. The only difference between evaluative response and monotone valence functions for the same sensation dimension may be expressed by a weight for preference relevance of responses. We discuss this further in section 5.1, where we specify the preference weights by projection cosines with the ideal axis in response spaces.

A monotone valence function can be interpreted in two consistent ways. Firstly, valences follow from the evaluation of the hedonic sensation expectancies. Here, the vertical axis of figure 14 becomes the hedonic value of the primary sensation intensities on the horizontal axis. Secondly with respect to responses, valences are the hedonic values of affective response sensations that by learning are associated to the primary sensations of responses that were reinforced by reward or punishment. The negative hedonic values then become associated with responses to sensations that below adaptation level are not rewarded and/or punished and positive hedonic values with the responses to sensations that above adaptation level are rewarded and/or not punished, whereby the hedonic values of sensations become proportional to the evaluative response curve. These interpretations illustrate that it is immaterial whether one views reward and aversion expectancy as aspects of responses or as aspects of sensations, as this is also irrelevant for generalisation (Luce and Galanter, 1963b, p. 284) where generalisation can be formulated as response as well as sensation generalisation.

In case of an evaluative response function for the magnitude judgment of stimuli, we see no justification for the inverse response function of responses as objective scales of response magnitudes, as it is supposed to be in the classical Bradley-Terry-Luce response theory. Firstly, response as well as sensation scales are relative scales with respect to individually different adaptation levels, whereby both are thus relative and subjectively different and not objective scales. Secondly, such an inverse response function should return the individual sensation scale (if it concerns the inverse transformation of responses to sensation values) or a power-raised stimulus fraction scale of subjective stimulus magnitudes (if it concerns the inverse of the transformation of responses to stimulus values). The hyperbolic tangent function specifies a response function with individual parameters for the subjective evaluation responses of stimulus intensities and also becomes the bipolar utility function with zero utility at adaptation level (sections 1.2. to 1.4.) as an individual function for monotone valences of monetary values. Therefore, we describe judgmental responses and preferential responses for objects with monotone valences by the same hyperbolic tangent function of individual sensations, where the evaluation is with respect to the adaptation level as

individual scale origin in accordance with adaptation-level theory. The individual evaluations of stimuli not only are dependent on the individual adaptation level, but the slope of the evaluation function is also steepest at the adaptation level as function midpoint and origin. Thereby, the adaptation level expresses on the one hand assimilation effects of responses by its pooling of previous sensations and on the other hand also sensitisation effects of responses for sensations around adaptation level.

The hyperbolic tangent function nicely illustrates how individual differences in the evaluation of distances between positions on a sensation scale are caused by differences in individual adaptation levels. For example, suppose we have some sensation scale with equal distances between successive alternatives A (=1.0), B(=1.75), C(=2.5), D(=3.25), and E(=4.0). Our psychophysical response theory postulates that the Fechnerian sensation scale is transformed to a subjective evaluation-response scale by a hyperbolic tangent function with the adaptation level as origin. An individual adapted to a position between B and the midpoint of B and C (say at 2.0) evaluates the distances by rank order  $BC > AB > CD > DE$ . An individual adapted to a position between D and the midpoint of C and D (say at 3.0) shows an evaluation wherein the distance rank order becomes quite different:  $CD > DE > BC > AB$ . Such adaptation level-dependent distances were found in a study (unpublished) on dissimilarities between academic positions judged by individuals with different academic positions at Leiden University in the mid sixties of the 20<sup>th</sup> century. The dissimilarity between the own and next lower position was judged larger than between the own and next higher position and both larger than all other adjacent position dissimilarities. This invalidates the assumption of a common evaluation scale. The common Fechner sensation scale of academic positions is translated to adaptation level of the own academic position and then monotonically different-transformed around the adaptation level of each individual to evaluation-response scales. Therefore, unless individuals have common adaptation levels, evaluation-response scales of individuals are different. Although sensation transformations by hyperbolic tangent functions with different adaptation levels as origin influence not the rank order of response values, they do change the rank order of judged distances between scale positions. The example of dissimilarities between academic positions demonstrates that the rank order of judged object distances generally is not shared by individuals, only the rank order of judged objects themselves on an unidimensional scale is the same for individuals, due to the monotone transformation with individually different origins.

In multidimensional scaling (MDS) analyses of (dis)similarities, where dissimilarities are represented by distances between objects in dimensionally scaled spaces, the object distances are often assumed to be identical for different individuals. The dependence of the monotone evaluation functions on the individual adaptation levels, however, violates a common rank order of distances between pairs of evaluated objects in the solved space by MDS, unless individual adaptation levels are the same. In the proposed integration of response theory and adaptation-level theory the differences in individual adaptation levels systematically predict violations of common rank order of evaluated scale or space distances. A MDS-analysis that is based on minimised violations of dissimilarity rank orders by the rank order of common object distances must assume that the individual adaptation levels for the dissimilarity

judgments are identical (which could hold for experiments wherein perceptual stimuli from a prior-known stimulus set are randomly presented) or must assume that the judgment spaces are common spaces. The last alternative is a fallacy, because dissimilarities are represented by individually different response space distances, if adaptation levels are different. Also monotone preference strength is not described by common sensation scales, but by individual different scales of ideal response axes. The consequences for preference analysis of objects with monotone valence functions are similar to those for response analyses. Less serious, but comparable consequences follow for multidimensional unfolding analyses of preferences for objects with single-peaked valence functions, as discussed in section 2.3. and chapter 5.

### 2.2.2. The generalised monotone valence function

According to the hedonic typology of sensation scales, discussed in section 1.6. and in contrast to the response function, hedonic value magnitudes can be expressed by valence functions for sensations around different reference levels and not only around the adaptation level of a presented stimulus set in a preference evaluation task. As described in section 1.6., zero valence values not only are observed at adaptation level, but also at the sensation intensity of saturation or deprivation levels. The hyperbolic tangent function of figure 14 not only describes a metric relationship between sensations and valences around adaptation level, but may also describe the local valences around other hedonic-neutral reference levels of sensations. A forward monotone valence function describes pleasantness of sensations above the reference level and unpleasantness below that level. This holds for the valence evaluation of sensations around the adaptation level on a positive ambience scale, but also if sensations are evaluated with respect to a deprivation level on the positive ambience scale, because in both cases stimulus intensities below reference level become unpleasant and stimulus intensities somewhat above pleasant. Hence two reference levels for relative sensations with a locally forward oriented monotone valence function can be identified: either an adaptation or a deprivation level. The slopes of valence functions at adaptation or deprivation level are assumed to be identical, because we have no justification for locally different sensation scale units. The forward monotone valence function is displayed by the function curve of figure 14 with asymptotic limits nonnormalised to  $-I$  and  $+I$  and a neutral midpoint that corresponds to adaptation or deprivation level on the sensation dimension.

For some deprivation level  $d_k$  on the sensation scale and deprivation level  $f_k$  on stimulus intensity scale of modality  $k$ , their relationship is given by Fechner's logarithmic function as

$$d_k = \ln(f_k), \quad (21a)$$

while  $d_k \leq a_k$  holds by definition.

The general monotone valence function is by (19) for (17d) written as

$$v_{ik}(y_{ik} = d_k, a_k) = \tanh[(y_{ik} - y_k)/a_k] = \tanh(y_{ik}/a_k) \quad (21b)$$

If level  $y_{ik}$  is changed to deprivation level  $d_k$  then for  $Y_{ik} > d_k$  also  $v_{ik}(d_k, a_k) > 0$ , where we here have forward monotone valence function for sensations  $s_{ik} = 2(Y_{ik} - d_k)/a_k$ .

In section 1.6., where we discussed the hedonic value typology of sensation scales, zero valences not only are conceived at adaptation and saturation levels, but also at adaptation and deprivation levels as hedonic-neutral reference levels, where either the deprivation or saturation level can become latent, dependent on the ambience of the sensation scale. Monotone valence functions for sensations with a negative ambience define sensations to be pleasant above and pleasant below reference level. This means a reflection of the monotone valences for the sensation scale, which reverses the orientation of the valence function of figure 14, as shown in figure 15.

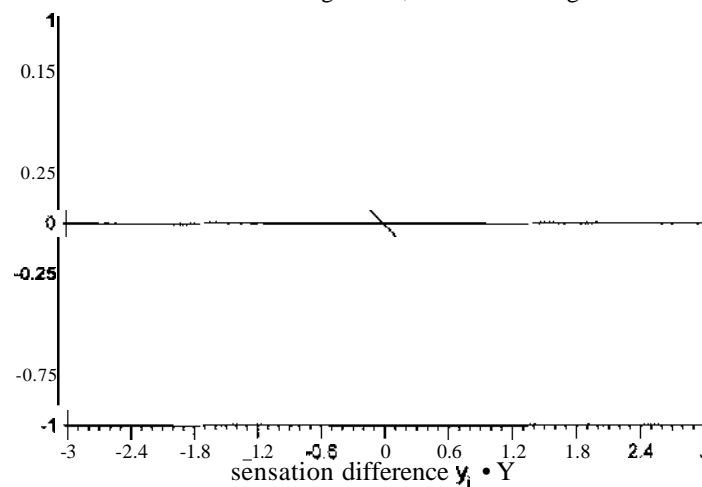

Figure 15. The backward monotone valence function.

Forward or backward monotone valence functions (figures 14 and 15) are mathematically described below by respectively a positive or negative hyperbolic tangent function of the same sensations with respect to a reference level as an individual translation parameter for Fechner sensation scales.

For a saturation level  $s_k$  on the sensation scale  $k$  and saturation level  $z_k$  on the stimulus intensity scale, the relationship between physical and psychological saturation level, according to Fechner's law, yields

$$s_k = \ln(z_k) \quad (22a)$$

The response function as backward monotone valence function for stimuli below saturation level  $Y_k = s_k$  becomes the negative expression of (18b) as

$$v_{ik}(y_k = s_k) = 1 - 2 \cdot p_{ik} \cdot \frac{s_k}{k} \quad (22b)$$

The backward monotone valence function with respect to saturation level  $s_k$  is obtained analogous to (21) as:

$$v_{ik}(y_k = s_k) = -\tanh\left[\frac{y_{ik} - s_k}{a_{ik}}\right] \quad (23b)$$

where  $Y_k = s_k$  is the reference level on a scale with negative ambience.

Similar to (19) we can express forward and backward monotone valence



functions in stimulus terms. We obtain for  $\tau_k = 1$  the forward valence function in stimulus terms as

$$V_{kl} [X_k = b_k, f_k] = 1 + \frac{X_k - X_{ik}}{X_k - X_{ik}} = 1 + \frac{X_k / X_k - X_{ik} / X_k}{X_k / X_k - X_{ik} / X_k} \quad (24a)$$

where  $X_k = b_k$  is the stimulus representation of the hedonic adaptation level of  $X_k = f_k$  the stimulus value of a deprivation level.

Correspondingly we may obtain the backward monotone valence function for  $X_k = b_k$  as the stimulus value of the hedonic adaptation level or as stimulus value of a saturation level, which is written by

$$-V_{kl} [X_k = b_k, Z_k] = -1 + \frac{X_k - X_{ik}}{X_k - X_{ik}} = -1 + \frac{X_k / X_k - X_{ik} / X_k}{X_k / X_k - X_{ik} / X_k} = X_{ik} / X_k + 1 \quad (24b)$$

The sign difference in (24a) and (24b) defines different orientations. The monotone preference function of (24a) and the response functions of (19) only differ by the kind of reference level. For responses it is the adaptation level on a perceptual or cognitive sensation scale  $k$ , and for monotone valences it is the hedonic adaptation level on an affective sensation scale associated to perceptual or cognitive sensation scales.

Moreover, as discussed further in sections 4.2. and 5.2 the expressions (24a), (24b) and (19) show that monotone valence axes and evaluative response dimensions are projective involutions of stimulus dimensions on its own dimensions, since (24a, b) as well as (19) are expressions for a geometric projectivity of a line onto itself as hyperbolic involutions of a line with respect to a unit point (Busemann and Kelly, 1953).

The hyperbolic tangent functions with individual adaptation levels as origin may represent dynamically changing valences for sensation scales with changing adaptation levels. In the theory of economic preference formation of Kapteyn (1977), the metric utility function for money is taken to be the log-normal cumulative distribution function. The location parameter in his cumulative log-normal function for utility is determined by the achieved financial position of an individual and serves as the cognitive reference level for comparison. This dynamic location parameter as achieved status quo is comparable to the shifting adaptation level. Also the logarithm in the log-normal function for utility of money is consistent with Fechner's law. This consistency is not accidentally, since Fechner's 19<sup>th</sup> century contribution to psychophysics (Fechner, 1851, 1860) and aesthetics as preferential psychophysics (Fechner, 1871, 1876) was also inspired by Bemoulli who in his famous 18<sup>th</sup> century contribution to utility theory (Bemoulli, 1738) transformed money by the logarithmic function in order to express the relatively diminishing utility for increasing money as his solution for the St. Petersburg paradox. In Kapteyn's theory (1977) the log-normal function is characterised by two parameters: a dynamic location parameter on the scale for the utility function and a standard deviation as the measurement unit of scale that determines the slope of the utility function. Similar to Kapteyn's analysis, dynamic changing valences are obtained by the location and weight parameters in our monotone valence function with a location parameter for the shifting adaptation level on the

sensation scale and a level-dependent weight parameter for the sensation differences from adaptation level. The log-normal utility functions used by Kapteyn (1977) in his dynamic *theory* of preference formation are pictured in figure 2. Since the logistic and cumulative normal probability functions are very similar, also the hyperbolic tangent function of figure 14 for monotone valences and the vertically displaced, cumulative normal probability function of logarithmic income scales of figure 2 are so similar that it is not possible to determine by empirical data with some error which of these curves fits better. However, the integral of the normal distribution has the disadvantage that it can't be written as an explicit function. For reasons of geometric transformation of sensation spaces to evaluative response or monotone valence spaces with transitive distance orders, discussed later in chapters 4, 5, and 6, we need an explicit function that also is geometric projection function to space dimensions with a constant or zero curvature. Since the hyperbolic tangent function is such a geometric projection function, it is a suitable function for the projective space transformation of sensations to response space dimensions and to monotone valence space axes. As demonstrated in chapter 4 the arctangent function is the only other alternative for a response function that also is a geometric projection function to space dimensions with a constant curvature and a linear transformation of another (the Cauchy) probability function for discrimination responses. In chapters 4 and 6 we also show that the hyperbolic tangent and arctangent are the only two permissible projection functions that can transform sensation spaces to response spaces. Therefore, the hyperbolic tangent is one of the two unique alternatives of the response or monotone valence function.

These judgmental response or monotone valence functions are metric functions of sensation scales and by the inverse of the weighted Fechner-Helson function for stimuli also metric functions of power-raised stimulus-fraction scales (power exponent  $\tau = 2/\ln(b/u)$  for fraction scale  $x_i/b$  with  $x_i/b = 1$  as individually scaled adaptation-level stimulus). The functions are **monotonic**, since the functions are strictly increasing functions (or strictly decreasing functions, if reflected for backward monotone valence functions) of the sensation or stimulus scale. Due to the logarithmic stimulus transformation, the forward monotone valences and responses diminishingly increase the less the higher the stimulus intensity becomes and, thereby, exhibits the so-called satiation phenomenon. Also due to the logarithmic stimulus transformation the forward monotone valence function (figure 14) as utility function for a monetary value scale is steeper for losses below reference level than for gains above reference level. It shows the asymmetric satiation effects of utility theory, referred in sections 1.2 to 1.4. These effects are obviously reversed for the backward oriented, monotone valence function curve of figure 15. If the sensation scales are such that no preferential oversaturation or underdeprivation exists, then the forward or backward valence functions are symmetrically monotonic with respect to their zero valence at adaptation level and apply to the whole range of sensation intensities. If preferential oversaturation or underdeprivation is present then the valence function is single-peaked, where the single-peaked valence function is to be derived from the multiplication of two oppositely oriented, monotone valence functions that are located at the deprivation and adaptation levels or at the adaptation and saturation levels, as indicated in chapter I and analytically specified in the next section.

### 2.3. Metric single-peaked valence functions

If preference function is characterised by single-peakedness and neutral valence at adaptation level and saturation or deprivation levels then oppositely oriented monotone valence functions may apply to ranges around the adaptation level and saturation or deprivation level. Yet the forward and backward monotone valence functions around differently located reference levels as such don't until now describe single-peaked functions with a maximum valence at the ideal sensation point and decreasing valences for lower and higher sensation intensities. As indicated earlier the single-peaked valence curve ought to be derived from a multiplicative relation between two opposing monotone valence functions either on a scale with positive or negative ambience. In the ordinal preference unfolding function of Coombs (1964) the ideal point at the maximum of a single-peaked, ordinal preference function is the only essential reference point. In section 1.3 it was shown how Coombs conceived the single-peakedness as a result of slower aversion adaptation than reward satiation. However, we have shown that satiation is a phenomenon of the logarithmic sensation scale, while adaptation is a different phenomenon that concerns the pooling of previous sensations as reference point for the bipolarity of sensations. Contrary to the derivation of single-peakedness by Coombs, satiation and adaptation processes both apply to expected reward and punishment sensations. In the later formulated extension of Coombs' preference theory to a theory of interpersonal conflict (Coombs and Avrunin, 1988) the status quo (e.g. an adaptation level with zero valence) and the ideal points are both fundamental reference points in the ordinal analysis of interpersonal choice conflicts. but in Coombs' ordinal data analysis of individual preferences zero valence points have no meaning. Ordinal functions, although weaker in assumptions, are also weaker in predictive power compared to a metrically formulated function that can become violated more easily. But, as shown in chapter 5. individual preference rank orders as rank order of distances between choice objects and individual ideal points in individually different, single-peaked valence spaces can be represented by monotonic transformed distances in individually weighted spaces of a Fechner sensation space.

#### 2.3.1. Metric single-peakedness derived from basic principles

As indicated by the citation on the front page of this chapter and as Coombs once remarked: "*knowledge is bought by assumptions*" (in 1966 at the Nuffic summer-course on psychological measurement, see: Coombs, 1966). Additional assumptions above rank order for a theoretically sustained, metric function for single-peaked valences could bring such a gain in knowledge on preference behaviour. Such additional assumptions are already made for the forward and backward, metric valence functions. These assumptions are based on principles from adaptation-level theory, learning theory, psychophysics and response theory. In the derivation of single-peaked valence function the same principles and the learning theoretical principles of symmetry and opposition as well as distance in location and multiplicativity of underlying bipolar monotone functions, derived in section 1.5, are taken into account. The metric single-peaked valence function follows from the multiplication of the symmetric, opposing and differently located, bipolar monotone valence functions. This metric single-peaked valence function becomes specified by the learning-theoretical properties of partial

simultaneity and independence of process activation and dominance of the aversion-over the reward-system processes. As discussed in section 1.5, simultaneity, independence and dominance for two bipolar, symmetric, and oppositely oriented system functions are only well expressed by a multiplicative operation between these two functions with a distance between their function origins. The dominance of expected aversion over expected reward only is a necessary result of the function multiplication, because only the multiplicative combination of positive and negative function values yield always a negative result. Therefore, the multiplication of two opposing monotone valence functions located at two distinct reference levels on a sensation scale must be the appropriate single-peaked valence function for the whole range of sensation scales. Indeed the multiplication of a forward monotone valence function at adaptation level and a backward monotone valence function at saturation level or the multiplication of a backward monotone valence function at adaptation level and a forward monotone valence function at deprivation level yield that single-peaked preference function of type +11 or type -11, both with negative valences at both function extremes. It determines a maximum valence at the ideal point, where the anti-symmetry of the underlying monotone functions defines the ideal sensation point to be the midpoint of the two reference levels with zero valence. These two reference levels with zero valence are as fundamental as the ideal point for preference analyses and especially for analyses of preference dynamics, as shown in the sequel.

The single-peaked preference curve can also be explained in another, perhaps more appealing way. As discussed for the two-process theory of learning (section 1.5.2.), positive and negative valences correspond to inhibition and facilitation processes from the central nerve systems for aversion or reward, where these processes are congenitally activated or by learned anticipation of reward or aversion. If the preference curve is single-peaked, then the reward process is maximal activated by sensations at the ideal scale point. The reward expectancy is generalised to sensations on both sides of that ideal point. According to the description of scale type 11, the aversion process is maximal activated at the low and high intensity extremes of the sensation scale, where the valences become maximal negative. Due to the symmetry of the reward and aversion system, the hedonic reward generalisations in both directions from the ideal point are symmetrically decreasing in a S-shaped way. At the sensation levels where the reward and aversion expectancy are balanced the valences are zero and thus constitute the defined, hedonic neutral reference levels of the preference function for scale type 11. These hedonic generalisations with zero valences at two reference levels are described by the product of forward and backward monotone valence functions located respectively at the lower and higher reference level. This construction of single-peaked valence curves defines a metric transformation of a sensation scale and by the exponential transformation of sensations also of a stimulus scale.

A different metric construction of a single-peaked valence function would violate parts of validated theories in mathematical psychology (psychophysics and response theory) and/or behaviour theory (adaptation-level theory and learning theory). One could replace the underlying logistic probability function by the almost identical nonnal probability function. However, for a geometric transformation of sensation spaces to response or valence spaces, discussed in chapters 4 and 5, we need an explicit

function expression for such an underlying probability function. Since the normal probability function is only described by the cumulative addition of finitely small intervals of the normal distribution and not by an explicit function, it satisfies not our requirement. Moreover, a bipolar-transformed normal probability function as response function of sensation dimensions would not specify response dimensions with a constant or zero curvature, as needed for response spaces with transitivity of ordered distances. The logistic probability function defines by its linear transformation the hyperbolic tangent function as the bipolar response or monotone valence function, which function describes by its geometric projection property a known mapping of sensation spaces to response spaces with transitive distance rank orders. In chapter 4 we investigate, as theoretical alternative for the logistic probability function, the Cauchy probability function that corresponds after a similar linear transformation to the arctangent function as bipolar response or monotone valence function, which function by its inverse radial projection property also defines a known geometric mapping of sensation spaces to response spaces with transitive distance rank orders. The single-peaked valence function as product of two hyperbolic tangent or two arctangent functions satisfies the required properties that are derived from adaptation-level theory and learning theory, while underlying hyperbolic tangent functions are based on the mathematical psychology of psychophysics and response theory. Thus, the qualitative scheme of the single-peaked function of figure 7 (section 1.4) becomes metrically defined by the product of hyperbolic tangent functions. As shown in chapter 5, the product of two arctangent functions is the only other consistent alternative. The proposed response and valence functions derive from an integration of psychophysics, adaptation-level, learning, utility, and response theories into a mathematical theory of judgmental and preferential choice.

### 2.3.2. *The single-peaked valence function*

The product of oppositely oriented, monotone valence functions at adaptation and saturation levels for sensation scales with a positive ambience or at deprivation and adaptation levels for sensation scales with a negative ambience yield a theoretically sustained and mathematically defined, metric single-peaked valence function for scale type H. Below in figure 16 we picture the single-peaked valence function for sensation scale with a positive ambience, where the hyperbolic tangent function of the forward curve in figure 14 at adaptation level is multiplied by the hyperbolic tangent function of the backward curve in figure 15 at saturation level with a distance between adaptation and saturation levels of five sensation-scale units. Due to the function symmetry, the ideal point with a maximum valence is located at the midpoint of the adaptation and saturation levels. For an enlarged distance between the adaptation and saturation points the maximum valence at the ideal point approaches unity. For reduced distances the maximum valence at the ideal point decreases until it becomes a similar shaped curve with a maximum valence of zero at the ideal point for zero distance. Thus, for different distances between the adaptation and saturation points figure 16 becomes a flexible valence function with a maximum valence between unity and zero at the ideal point and with valences that symmetrically decrease towards minus unity for infinitely remote sensations on both sides from the ideal point. For sensation scales with a positive ambience they are denoted as forward single-peaked valence functions.

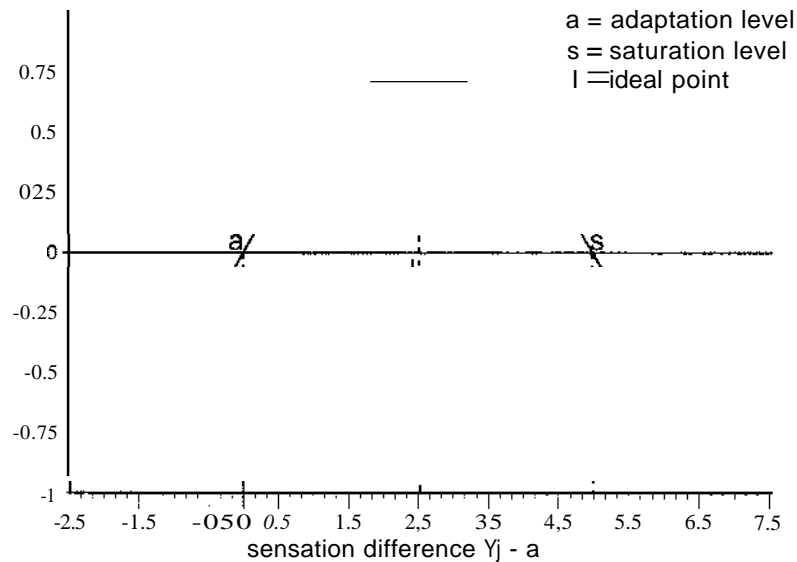

Figure 16. The forward single-peaked preference function

If the saturation point would be infinite then also ideal point moves towards infinity. In that case the forward single-peaked valence function equals the forward monotone valence function of figure 14, where the maximum valence is approached towards the positive infinity of sensation intensity. It then becomes the monotone valence function for an unlimited preference for some attribute without a congenital or learned basis for saturation, like economic theory assumes for utility of valued goods. However, for finite distances between adaptation and saturation point the valence curve is single-peaked. Its symmetric shape with respect to the ideal point as midpoint of the distance between the reference levels with zero valence follow from the learning theoretical properties of anti-symmetry, distance, and multiplicativity of the underlying monotone functions for signal-facilitating reward and signal-inhibiting aversion processes. Symmetry of the single-peaked valence function must hold, because the underlying, opposite, monotone valence functions with different origin locations concern reflected functions of the same sensation scale. For unidimensional sensations we need not to determine the scale unit or dimensional weight, but for comparison of single-peaked valence dimensions it will be clear that we need a valence-comparable weighing of sensation dimensions. As discussed in chapter 5, their valence comparability is achieved by dimensional weights that nonnalise the sensation distances between dimensional adaptation and ideal points to unity. Moreover, if the deprivation and just noticeable sensation levels coincide then the dimensional weighing for valence-comparable sensations by  $1/d$  as inverse distance between adaptation and ideal levels equals the dimensional weighing for intensity-comparable sensations by  $2/a$  as twice the inverse of the adaptation level, because the distance between adaptation level and the zero-valued deprivation level then satisfies  $d = 1/2a$ , whereby intensity- and valence-comparable sensation scales have equal scale units.

Let  $k$  be a sensation scale with positive ambience. Then the metric single-peaked valence  $v_{ik}$  for stimulus  $i$  on a sensation scale  $k$  with positive ambience, hence  $a_k < s_k$ , is defined by the product of the positive and negative hyperbolic tangent functions for weighted sensations. Hence the product of the expressions of (20) with  $Y_k = a_k$  and of (23) with  $y_k = s_k$ . The expression for the forward single-peaked valence function becomes:

$$v_{ik} = \tanh[\frac{1}{2}(y_{ik} - a_k)/d_k] \cdot \tanh[-\frac{1}{2}(y_{ik} - s_k)/d_k]. \quad (25a)$$

Here  $d_k$  represents the distance between ideal and adaptation points on sensation scale  $y_{ik}$ . Its multiplication clearly expresses the symmetry of the preference curve. Formula (25a) is fully written as

$$\frac{1}{1 + e^{-(Y_{ik} - a_k)/d_k}} \cdot \frac{1 - e^{-(Y_{ik} - s_k)/d_k}}{1 + e^{-(Y_{ik} - s_k)/d_k}} \quad (25b)$$

After the same substitution as for (24) and its analogous expression for stimulus saturation level  $z_k$  and a sign reversal  $\sigma_k$ , obtains for  $d_k = 1$  the expression as function of a stimulus scale  $k$

$$\frac{(x_{ik}/b_k) - 1}{(x_{ik}/b_k) + 1} \cdot \frac{(x_{ik}/z_k) - 1}{(x_{ik}/z_k) + 1} \quad (26)$$

The expression for the maximum valence follows by  $y_{ik} = g_k$  as ideal sensation point in (25b) and is written as

$$v_k = \max(v_{ik}) = \left[ \frac{1 - e^{-(g_k - a_k)/d_k}}{1 + e^{-(g_k - a_k)/d_k}} \cdot \frac{1 - e^{-(s_k - g_k)/d_k}}{1 + e^{-(s_k - g_k)/d_k}} \right] \quad (27)$$

and since

$$d_k = (g_k - a_k) = (s_k - g_k) = \frac{1}{2}(s_k - a_k) \quad (28a)$$

we have

$$g_k = \frac{1}{2}(s_k + a_k) = \frac{1}{2} \ln(z_k \cdot b_k) \quad (28b)$$

as the ideal point on a sensation scale with a positive ambience.

Rewriting (27) for  $d_k$  and  $g_k$  defined by (28a) and (28b) one obtains the maximum valence at forward ideal point  $g_k$  as  $v_{\max} = \max\{v_{ik}\}$  by

$$v_{\max} = \frac{1 - e^{-\frac{1}{2}}}{1 + e^{-\frac{1}{2}}} = \tanh^2\left[\frac{1}{4}\right] \quad (28c)$$

In econometric utility theory, based on strict monotonic increasing and positive valued utilities, single-peakedness can only be conceived as a composition of utilities for two completely negative-correlated attributes of choice objects. Using an earlier discussed example, single-peakedness of preference for jobs with varying work hours per day arises by a multiplicative composition of utility functions for two completely dependent attributes: one monotonic increasing utility function of income for hours of work per day and another monotonic decreasing utility function of fatigue or loss of free time from excessive work hours per day. By iso-preference curves and value tradeoffs in the multi-attribute utility methodology (Keeny and Raiffa, 1976), one can obtain in such

a complicated way a recovery of single-peaked preference structure by representations with redundant attributes, such as by the multiplicative job utility and disutility in the example. A single-peaked preference function seems much simpler and more justified. Moreover the single-peaked function of figure 16 satisfies all the properties of preference from adaptation-level theory and learning theory and, therefore, constitutes a genuine valence function for sensations as a theoretically sustained preference function for preferential choice and approach/avoidance behaviour.

In case of a scale with negative ambience the adaptation level is located above the ideal point. On such type -II scales the sensations above adaptation level are unpleasant and below pleasant, while sensations below the ideal point reduce again the pleasantness. The construction of a single-peaked valence function on such a type-II scale results from the multiplication of a backward monotone valence function at adaptation level and a forward monotone valence function at the lower deprivation level. It yields the horizontally reflected valence function of figure 16, where the reflection point is the adaptation point. This reversed single-peaked function is called the backward single-peaked valence function, but is identical to figure 16 with the adaptation point replaced by the saturation point and the deprivation point by the adaptation point. It is conceivable for scales with negative ambience that the deprivation level coincides with the just noticeable level, but stimulus intensities at levels towards the just-noticeable level are experienced as less pleasant than somewhat higher stimulus intensities, while prolonged absence of stimuli may be experienced as unpleasant underdeprivation. A deprivation level at zero stimulus level would mean that the deprivation level is located at an infinitely negative sensation level, whereby the ideal point as midpoint of deprivation and adaptation level would become infinitely negative displaced. Its valence function would then reduce to a backward monotone valence function. Therefore, we assume that a single-peaked valence function with a negative ambience has a deprivation level that coincides with the just noticeable level. Since the saturation level is the reflected deprivation level, it then also follows that the saturation level corresponds with inverse of the just noticeable stimulus intensity.

The corresponding expression for a backward directed, single-peaked preference function of sensations  $i$  on dimension  $I$  with a negative ambience, becomes the backward single-peaked valence function as the product of (21) for  $Y_I = u_I$  and (23) for  $Y_I = aI'$  while clearly  $u_I < aI'$

Hence one obtains comparably to (25)

$$v_{iI} = \tanh[-\frac{1}{2}(y_{iI} - a_I)/d_I] \cdot \tanh[\frac{1}{2}(y_{iI} - u_I)/d_I] \quad (29a)$$

$$v_{iI} = \frac{e^{(Y_{iI} - a_I)/d_I} - 1}{e^{(Y_{iI} - a_I)/d_I} + 1} \cdot \frac{e^{-(y_{iI} - u_I)/d_I} - 1}{e^{-(y_{iI} - u_I)/d_I} + 1} \quad (29b)$$

After substitution of (15b) also for the analogous stimulus expression with respect to deprivation level and a sign reversal, we get comparable to (26), but for  $f_I = \exp(u_I)$  as stimulus deprivation point and  $d_I = 1$

$$\frac{x_{iI}/b_I - 1}{X_{iI}/b_I + 1} = \frac{x_{iI}/f_I - 1}{X_{iI}/f_I + 1} \quad (30a)$$



where the forward valence function of (26) writes as

$$\frac{X_{ik}/b_k - 1}{X_{ik}/b_k + 1} = \frac{x_{ik}/z_k - 1}{x_{ik}/z_k + 1} \quad (30b)$$

since (30a) and (30b) are mathematically the same, only the value of  $z_k$  or  $i_k = l/z_k$  determines what the ambience of the curve is.

For the ideal point on a sensation scale with negative ambience one obtains by rewriting (29b) for  $Y_{i1} = g_1$

$$\left[ \frac{1 - e^{-(a_1 - g_1)/d_1}}{1 + e^{-(a_1 - g_1)/d_1}} \quad \frac{1 - e^{-(g_1 - u_1)/d_1}}{1 + e^{-(g_1 - u_1)/d_1}} \right] \quad (31a)$$

which defines for backward located ideal point

$$g_1 = (u_1 + a_1)/2 = \frac{1}{2} \ln \left( \frac{f_1 b_1}{1} \right) \quad (31b)$$

that the maximum valence at  $g_1$  is also written by  $v_{\max} = \tanh' \left[ \frac{1}{2} \right]$ .

In case there is a reducing valence below the ideal point on a scale with negative ambience, it implies the existence of a deprivation level below adaptation level. As discussed in section 1.6., the deprivation level on scales of type -II will generally be at a very low level of stimulus intensity and probably at the just noticeable level of perception. Although there is in many cases an evident absence of unpleasantness on extreme low values on scales with a learned negative ambience, such as mental stress, danger, or fear arousal, absence or extremely low stimulus intensity may become less pleasant than rather low levels of stimulus intensity in some contexts. In the conditioning interpretation it is argued that the affective sensations around the high sensation intensity of saturation level of type +II scales become reversed conditioned around a low intensity level on the conditioned sensation scales of type -II. The deprivation level on the stimulus intensity scale in this interpretation is at the inverse value of the stimulus intensity for the saturation level and, thus, located above the zero stimulus level. By this line of reasoning the negative conditioning and generalisation of type +II scales establishes a deprivation level on learned type -II scales that may locate the deprivation level on the just noticeable level, but not at the negative infinity of the individual sensation scale.

In view of the sign reversed relation between the terms of (25b) and (29b) one may assume that conditioning of sensations with a positive ambience on scale  $k$  to sensations with a negative ambience on scale 1 leads to

$$(Y_{ik} - a_k/d_k) = - (Y_{i1} - a_1/d_1)$$

where  $w = d_1/d_k$  represents the strength of the negative conditioning. Thus

$$w(Y_{ik} - a_k) = - (Y_{i1} - a_1) \quad (32a)$$

and for saturation level  $s_k$  and deprivation level  $u_1$  one obtains

$$W(Y_{ik} - s_k) = - (Y_H - u_1) \quad (32b)$$

Although this is somewhat hypothetical, in view of the established fact that some sensations with a negative ambience are learned, self-produced sensation responses to other sensations with a positive ambience the distance of  $y_{i1}$  with respect to  $a_1$  and  $u_1$  very well may be negatively related with the distance of  $y_{ik}$  to  $a_1$  and  $s_k$  indeed. For  $k = 1$  it implies by  $w = 1$  a reflection of sensation scales. So if 1 is reflected dimension  $k$  then stimulus levels  $\exp(8_{ik})$  and  $\exp(u_1)$  are mutually inverse scale representations of each other with the adaptation point at unity on a stimulus scale that is associated with positive and negative ambience sensations. Therefore, we may define deprivation and saturation levels as mutual inverse levels on a stimulus scale with associated positive and negative, affective sensation dimensions.

From the mathematical description above it seems safe to assume that on a scale with negative ambience, either a deprivation level does not exist (which would violate the existence of type -11 scale in section 1.6.), or is located at the perception threshold of the stimulus scale, since higher locations would have given clearer evidence for unpleasantness at low levels of sensations with negative ambience. Since the deprivation level is a learned level on type -11 scales, it seems impossible that the just noticeable level can be above the deprivation level on the logarithmic stimulus scale. If we assume that the deprivation level generally coincides with the just noticeable sensation level then it explains why unpleasantness from sensation absence for type -11 scales is generally not experienced. The ideal point on such type -11 scales is located at the sensation midpoint of the adaptation and just noticeable levels. Sensations below that ideal point and above subliminal level must then be less pleasant than at ideal point sensation, which justifies the existence of type -11 scales for sensation scales without experiences of a deprivation level and underdeprivation.

We summarise: if there is a finite deprivation or finite saturation level then there is a finite ideal point and a single-peaked valence function for the sensation scale. The ideal point with maximum valence is located at the sensation midpoint of the adaptation and deprivation or saturation level. In the psychophysical valence theory the qualitative concept of level of aspiration becomes the metrically defined maximum valence of the ideal point by the metric single-peaked valence function. Judgmental and preferential responses in this psychophysical response and valence theory are based on psychophysics, response theory, adaptation-level theory and learning theory. As such psychophysical response and valence theory constitutes a theory that potentially contributes to the integration of psychophysics, choice theory, and cognitive theory in psychology. The controversy between Stevens' and Fechner's psychophysical laws (Stevens, 1961) can't be resolved without the cognitive concepts of generalised magnitude sensations and sensation matching, while cognition needs a psychophysical basis of judgment and preference.

## 2.4. Dynamics of judgment and choice

Changed stimulus intensities and changes in contextual conditions cause a change in adaptation level. For unidimensional sensations we illustrate and normally determine the effects of changing average levels of stimulus intensities for the dynamics of judgment and preference in this section. Their generalisation to multidimensional spaces is discussed later in chapter 7. Neo-behaviouristic theory describes how human actions are shaped by innate structures and by learning of stimulus-response chains that are facilitated by reward and inhibited by punishment, also for self-reinforcing, purposeful actions. In theory actions are thought to lead to the obtainment of expected reward and the avoidance of expected non-reward or punishment. In psychological reality many expectations concern conflicting expectancies for action outcomes and with different time frames for the actualisation of the outcomes. Abnormal behaviour may result from distortions in the evaluation of conflicts and time frames. For example some kinds of neurotic behaviour might be explained by a higher impact of direct reward expectancy and a smaller impact of delayed punishment expectancy than in normal behaviour. In the sequel individual differences are stressed, but abnormality in judgment and preference are out of the scope of this monograph.

### 2.4.1. Dynamics from *adaptation-level shifts*

For the moment it is assumed that contextual and motivational conditions are not altered and that only behaviour and sensations with regard to a single scale of sensation intensity are of concern. If one is able to perform behaviour that produces sensation intensities that are associated with more pleasantness or higher reward expectancy than obtained in the past then newly obtained sensations are closer to the ideal point than the older sensations. This must shift the adaptation level toward that ideal point. Changed stimulus intensities by external sources will also change the adaptation level and ideal point. For the response function and the monotone valence function it is clear that judgmental and preferential responses for the same stimuli will change by shifted adaptation levels. Previous positive evaluations of individual sensations can by adaptation level shifts become negative evaluations of the same stimuli. Changed adaptation levels produce changes of judgmental responses and may also cause that preferred matters may become disliked ones. It is obvious that evaluative responses and monotone valences increase or decrease in magnitude by a shifted adaptation level. Their unidimensional dynamics are defined by the shifted origin locations of the evaluation response or monotone valence function, which needs no further explanation. For the single-peaked valence function we have conjectured that the saturation or deprivation levels on affective sensation scales are mainly derived by learned association to congenital sensations with fixed deprivation or saturation levels, because these congenital levels are innate. Thereby, also conditioned deprivation or saturation levels tend to remain stable while the adaptation level may change. Nonetheless, this may not always be the case. Cognitive saturation or deprivation levels may change by habituation to sensations at extreme levels, but such habituation to extreme stimulus intensities can only happen if also the adaptation level approaches the saturation or deprivation level. For example, professional sportsmen may acquire higher tolerance levels for muscular pain than their originally innate saturation level for muscular pain.

Besides such unusual conditions we assume stable deprivation and saturation levels, because they don't change in nonnal conditions.

One's own behaviour may strive to obtain more stimuli in the range of the ideal point, but also external stimuli may change over time in the direction of the ideal stimulus, whereby the adaptation point shifts towards the ideal stimulus. After a shift in adaptation level towards the initial ideal point the location of the new ideal point is again the midpoint between the new adaptation and fixed saturation levels. Since the saturation or deprivation level is not changed by stimuli between adaptation and ideal points, the ideal point moves in the direction of the saturation level by half the amount of the adaptation level shift. This is illustrated next by figures 17a to 17c.

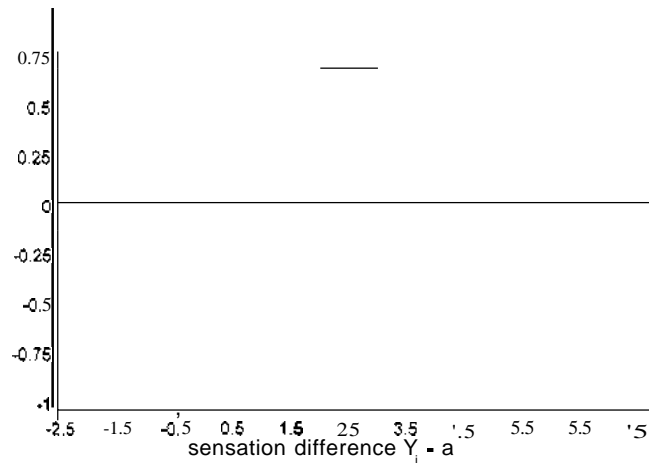

Figure 17a. Existing valence curve.

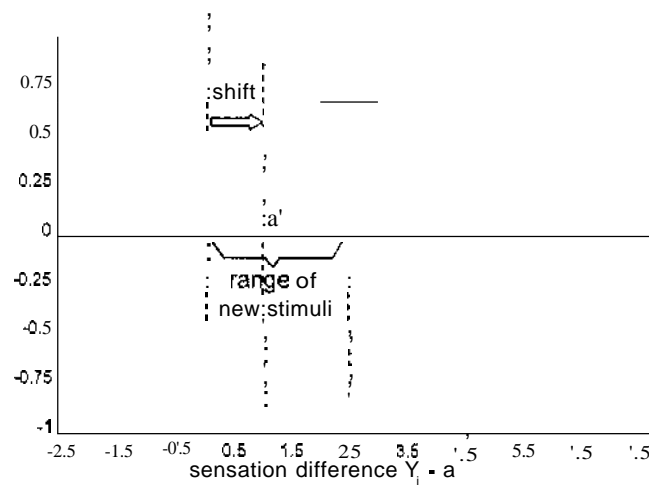

Figure 17b. Changing adaptation level by more satisfying sensations.

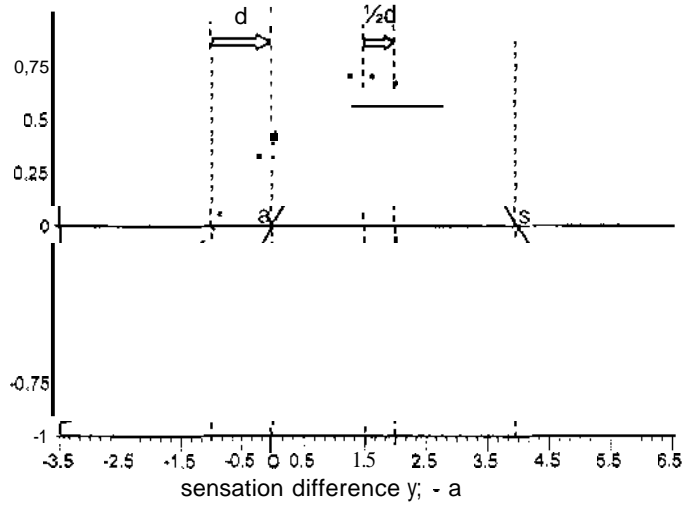

Figure 17c. Changed valence curve after shift of adaptation level.

Repeated shifts of adaptation level towards the ideal point will move the ideal point in the direction of a fixed saturation level by half the shifts of the adaptation level, while the maximum valence level successively becomes further reduced, which in turn reduces the tendency strength to obtain more ideal stimuli. Thus, repeated changing positions in the direction of the saturation point makes that newly added desired sensations will shift the adaptation level and the ideal point in an adaptive way to the saturation level with decreasing speed. This not only occurs directly by achievements that produce stimuli in the neighbourhood of the ideal point from the realisation of desired choice opportunities, but also indirectly by behaviour that changes the circumstances in order to facilitate the exposure to more ideal stimuli. Clearly an equivalent description is possible for choice behaviour dynamics for a scale with negative ambience and single-peaked valences. The picture then simply becomes the horizontal reflection of figures 17a to 17c, wherein the reflected saturation level becomes the deprivation level.

Repeating the definition of adaptation level from formula (14) for  $n_{t-1}$  events of stimulation up to time  $t-1$  and for  $n_t$  events of stimulation up to time  $t$  for which holds that  $n_t > n_{t-1}$ , one writes

$$a_{k,t-1} = \left[ \sum_{i=1}^{i=n(t-1)} y_{ik} \right] / n_{t-1} \quad \text{and} \quad a_{k,t} = \left[ \sum_{i=1}^{i=n(t)} y_{ik} \right] / n_t \quad (33a)$$

We define

$$\delta = a_{k,t} - a_{k,t-1} \quad (33b)$$

and for saturation level  $s_k$  also

$$\sigma = s_{k,t} - s_{k,t-1} \quad (33c)$$

but for a fixed saturation level  $\sigma = 0$ . It follows from (28) that

$$g_{k,t} - g_{k,t-1} = (\delta + \sigma) / 2 \quad (33d)$$

but under a stable saturation level  $\sigma = 0$  and thus

$$g_{k,t} - g_{k,t-1} = \frac{1}{2} \delta \quad (33e)$$

Hence, a change in adaptation level under a fixed-assumed saturation level, yields a decreased distance between the changed adaptation level and changed ideal point in such a way that the change of adaptation level causes half such a change of the ideal point.

It will be noticed that changes in the sensation values by external sources, such as more or less forced exposure to other stimulus intensities, also changes the adaptation level. Such changes in adaptation level can cause the same type of shift in ideal points. External causes of exposure to changed stimulus intensities, however, may as well change the adaptation level in an opposite direction away from the ideal point. Under the assumption of a fixed deprivation or saturation level an adverse shift in adaptation level will also result in half such a shift of the ideal point in the same direction as the shifting adaptation level. It increases the distance between ideal point and adaptation level and thus also increases the maximum valence level at the ideal point. Such frustrating dynamics may be counteracted by cognitive down playing of the importance of the dimension with respect to other sensation dimension. Comparison of preferences can be represented by a preferential weighting of its sensation scale by a factor that equals the inverse of the sensation distance between adaptation and ideal points. In the case of a single dimension a changed preferential weight influences not the individual choice dynamics, but in multidimensional analyses of preferences such changing preferential weights of dimensions become meaningful and important parameters for choice dynamics. By such preferential weight changes for sensation dimensions the location of the ideal point in the multidimensional space of preferential choice is altered, which can influence the preferences. Adaptively changing valence functions can be regarded as basic functions for the adaptive dynamics in cognitive-affective system of individuals, but also for the collective appearances of cognitive-affective dynamics of human behaviour that is based on choices and decisions without or little social interaction (Hanken and Reuver, 1981; Hanken. 1981).

#### 2.4.2. *Behavioural control and preference*

If sensations can be completely controlled by self-produced stimuli of realised choices, then the adaptation level is brought closer toward the desired sensation intensity of the ideal point. For monotone valence functions this would go on forever, which expresses the unlimited desire for such attributes. For single-peaked valence functions it means that also the ideal point adaptively moves toward the saturation or deprivation level. The closer the adaptation level is to the ideal point (and thus the ideal point to the saturation or deprivation level) the lower the maximum valence becomes. which reduces the behavioural tendency for the obtainment of new ideal sensations. Therefore, under complete self-controllable stimuli the speed of change will be the slower the lower the maximum magnitude of the positive valence at the ideal point is and, thus, also the smaller the distance between the adaptation level and ideal point (or equivalently between the adaptation and the saturation or deprivation levels) is. However, this tendency remains positive as long as there is a distance between ideal point and adaptation level. The response-produced stimuli with ideal intensities

adaptively locates the dynamic adaptation level at asymptotically merging levels of ideal point and saturation or deprivation level, which both then also must coincide with the ideal level. Figure 18 shows the valence curve for such coinciding reference levels.

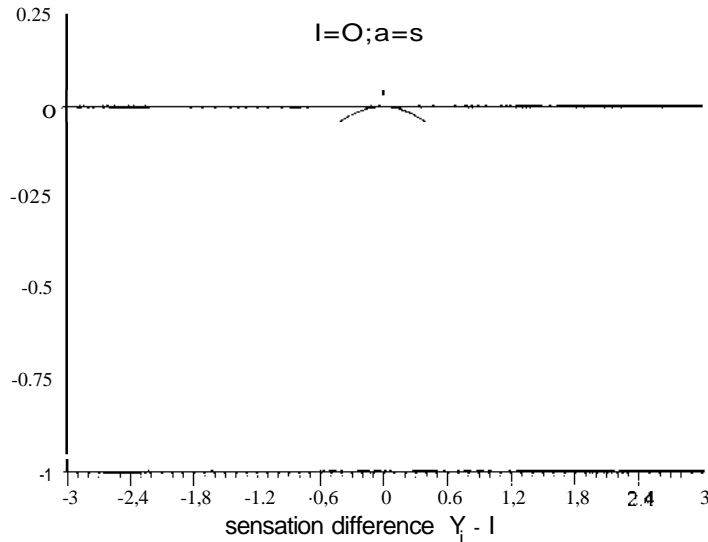

Figure 18. Single-peaked valence curve/or coinciding levels.

In figure 18 is described for  $s_k = a_k = g_k$  by (25) or for  $u_k = a_k = g_k$  by (29), whereby the single-peaked valence function with coinciding levels becomes the controlled valence function as

$$v_{ik}(a_k = g_k) = \frac{r}{1 + e^{\frac{-(y_{ik} - g_k)/d_k}{p_k}}} = -\tanh^2 \left[ \frac{1}{2} \frac{(y_{ik} - g_k)/d_k}{p_k} \right] \quad (34a)$$

or with  $\exp(g_k) = P_k$  and  $d_k = 1$

$$v_{ik}(b_k = Z_k, f_k) = -\left\{ \frac{[x_{ik}/P_k - 1]}{[x_{ik}/P_k + 1]} \right\}^2 \quad (34b)$$

At  $y_{ik} = g_k$  and  $x_{ik} = P_k$  the controlled valence function reaches its zero maximum, while it is negative for higher and lower values  $y_{ik}$  and  $x_{ik}$ .

A simple example of such a preference curve with coinciding levels is a man's preference function for belts that are identical in all respects but for length. Clearly the valence function for belt length is single-peaked, but the valence is completely controlled by optimally suited length and by adaptation to the usual wearing is not positive nor negative, while longer or shorter belts have negative valences. There are obvious examples of a more psychophysical dynamic nature for valence functions with a neutral maximum valence, where behavioural controlled sensations establish coinciding levels. One such an example is the air pressure balance in the ear. A lower

or higher air pressure outside than inside the ear is unpleasant and matched pressures are neutral, where external changes of air pressure are controlled by dynamical matching of inside and outside air pressure. The description of the choice behaviour on sensation scales with negative ambience under complete behavioural control is also illustrated by the curve of figure 18. The ambience difference only defines a different location for the merged levels as either at the deprivation or at the saturation level.

This completes the description of the dynamics in choice behaviour for unidimensional sensation scales. It constitutes a theory for dynamical judgment, preference, and actions in the field of ongoing stimulation. Therefore, referring to Lewin's valences in his field theory of actions (Lewin, 1938, 1942), we call our theory the psychophysical response and valence theory. The dynamics of responses and preferences are further discussed in chapter 7 after we have explored in chapters 3 to 6 what our multidimensional theory implies for stimuli with constant adaptations levels.





## CHAPTER 3

### THE GEOMETRIES OF STIMULUS AND SENSATION SPACES

*"Although several authors <> have suggested that non-Euclidean spaces may be appropriate, little research has been reported on anything other than Euclidean embeddings. There are dangers in limiting ourselves to this familiar space. <> a good deal of judgment is involved in deciding whether a particular embedding is appropriate. But, because our judgments are likely to be influenced by our presystematic intuitions about the nature of the space and the arrangement of the stimuli in it, there is some fear that we are simply perpetuating the errors of naive Euclidean intuition."*

Luce, R.D. and Galanter, E. Psychophysical Scaling. Ch. 5, p. 303 in: Luce, R.D.; Bush, R.R. & Galanter, E. (Eds.) (1963). *Handbook of mathematical psychology*. Vol. 1. Wiley, New York.

## CONTENT DETAILS CHAPTER 3

	page
3.1. Metric psychological spaces and the stimulus geometry	95
3.1.1. The Minkowski geometry for psychological spaces	97
3.1.2. Psychological relevance of non-Euclidean and Finsler geometries	99
3.2. The relationship between sensation and stimulus geometries	101
3.2.1. Flat sensation and non-Euclidean stimulus spaces	101
3.2.2. Euclidean stimulus and hyperbolic sensation spaces	106
3.2.3. Hyperbolic surfaces in terms of Euclidean co-ordinates	110
3.3. Stevens' psychophysics and Bower's stimulus coding theory	113
3.3.1. Stevens' psychophysics and Euclidean stimulus spaces	114
3.3.2. Stevens' psychophysics and flat sensation spaces	123

### 3.1. Metric psychological spaces and the stimulus geometry

The metric response or monotone valence functions and the metric single-peaked valence functions of comparable sensations yield a basis for the appropriate judgment or preference analyses in a multidimensional object-attribute space. A multidimensional scaling method of judgmental or preferential responses should reveal the psychological response or valence spaces of individuals as functions of the sensation dimensions for stimuli or cognitive objects (assuming that an objective attribute space of cognitive objects is shared by individuals). Every analysis of rank order data by some multidimensional method asks for the solution of the co-ordinate parameters for the locations of objects or stimuli, individual adaptation levels and, where relevant, also individual ideal points as well as individual weights for dimensions, but also needs to determine the geometry and dimensionality for the representation of individual data. The judgmental responses are determined by monotone response functions of individually translated, weighted, and oriented sensation dimensions. Also preferences are determined by monotone and/or single-peaked valence functions of individually translated, weighted and oriented sensation dimensions. But firstly, the geometry of the stimulus space (or attribute space of cognitive objects) is transformed by weighted Fechner-Helson psychophysical function to individually different sensation spaces with a common geometry that differs from the stimulus geometry. The transformation of a stimulus space to individually translated and weighted spaces of comparable sensations is a logarithmic transformation with individual parameters that are defined by the adaptation and just noticeable or ideal points. Given the geometry for the stimulus space (physical intensities and/or extensities) or the assumed-common attribute space of cognitive objects, Fechner's logarithmic transformation of stimulus or attribute dimensions determines the geometry of the sensation space, while individual adaptation levels determine the individual translations and dimensional weights in that geometry as their intensity-comparable sensation spaces. For cognitive objects a common attribute space with the same geometry as the stimulus spaces is assumed to exist, which space then derives from the inverse transformation of individual sensation spaces of cognitive objects. Thus, given a geometry for the common object or stimulus space, the geometry of the sensation space is determined by the psychophysical transformation function. The geometry of the sensation space determines also the geometries of the response or preference space by our metric response or valence functions, derived in chapter 2. The geometry defines the distance metric of the space, while dissimilarities are represented by distances between objects in individual response spaces and preferential choices of individuals by distances between objects and an ideal point in valence spaces. Therefore, given a geometry for the stimulus space, the metric response or valence functions of chapter 2 yield the foundation of the permissible geometries for the semi-metric multidimensional analysis of (dis)similarity judgments or preferences.

This theoretical approach differs from data-analytic driven, non-metric analyses by multidimensional scaling (MDS) of (dis)similarities (Kruskal, 1964a,b; Shephard et al. 1972; De Leeuw and Heiser, 1982; Meulman, 1986; Heiser, 1988; Cox and Cox, 1994; Borg and Groenen, 1997) or by multidimensional unfolding of preferences (Coombs, 1964; Heiser, 1981, Heiser and De Leeuw, 1981, Heiser, 1989). This contrast also applies to modern probabilistic versions (Ashby, 1992a) of these scaling methods.

All existing MDS methods acknowledge not the different geometries of the common object space, the individual sensation spaces, and the individual response or preference spaces. In the relevant spaces the configurations of stimuli or objects are represented as points or vectors in a metric multidimensional co-ordinate system. The angles between and lengths of vectors describe the space configuration of objects by the endpoints of vectors from a space origin. The geometry of a multidimensional space specifies the distance metric between space points and the projective decomposition of vectors in co-ordinate values with some arbitrarily or meaningfully defined origin and scale units. In a metric space with a particular distance function the object representation generally is given in terms of independent object co-ordinate values by some geometry-dependent projection function of object vectors.

Generally a flat and infinite geometry (thus Euclidean or Minkowskian) is assumed for psychological spaces, but there is no a priori justification for an infinite and flat nature of response or valence space geometries as the relevant psychological spaces for the analysis of dissimilarities or preference rank orders. On the one hand one may assume that the stimulus space for the range of the stimulus intensities and extensities in human perception is Euclidean, although physics after Einstein tells us that the physical geometry is non-Euclidean. On the other hand one could argue that human perception is characterised by sensations of a seemingly Euclidean nature. It certainly is convenient to represent analysis results in a Euclidean space (rather than in not rotation-invariant Minkowski spaces) and not only for mathematical reasons, but also for the understanding of analysis results. However, such representations require that either the stimulus or the sensation space is Euclidean, because both spaces cannot have the same geometry.

As shown in the next sections of this chapter, if the sensation space is Euclidean or Minkowskian then the stimulus space is non-Euclidean or if the stimulus space is Euclidean then the sensation space is hyperbolic. Since either Newtonian or possibly relativistic physics determine the objective measurement of stimuli, other stimulus geometries than Euclidean or non-Euclidean ones must be excluded. In this chapter it is shown that the corresponding sensation space can only be either flat (Euclidean or Minkowskian) or hyperbolic, while in the next following two chapters it is also shown that open (finite) geometries of individual response or valence spaces derive from the response or valence transformations of infinite and flat or hyperbolic sensation spaces. Since not sensations, but responses or preferences are observed, we have to analyse dissimilarities or preferences as individual response or valence space distances. The geometrically appropriate multidimensional analyses are to be based on data representations (e.g. transitively ordered dissimilarities by distances or transitive preference rank orders by conditional object distances to ideal points) in individual response or valence spaces with individual parameters that are solved from inverse transformations of individual response or valence spaces to either a common Euclidean stimulus or sensation space (only hyperbolic or Euclidean and no Minkowskian sensation spaces can be derived from these inverse transformations), which topics are discussed respectively in chapters 4 and 5.

### 3.1.1. The Minkowski geometry for psychological spaces

The Minkowski geometry defines a  $r$ -metric for distances in flat spaces and has gained considerable attention in psychology (Shepard, 1964, Roskam, 1968, Bezembinder, 1970, Coombs et al. 1970). The  $r$ -metric for distances  $a$  and  $b$  on independent dimension defines space distance  $c$  in a plane to be given by  $a^r + b^r = c^r$ . For  $r = 2$  it is the Pythagorean expression for the Euclidean geometry, wherein the square root of the sum of squared distances on independent dimensions specifies the spacedistances. If the Minkowski parameter  $r = 1$  then it defines the city-block geometry of a space, wherein distances are the simple sum of the dimensional distances. If  $r = \infty$  then a space distance equals the largest dimensional distance. In textbooks on psychological data analysis the contours of space points with equal distances to the origin in Minkowski spaces with different  $r$ -metrics ranging from  $r = 1$  to  $r = \infty$  are generally illustrated by an iso-distant square for  $r = 1$  surrounded by an iso-distant circle for  $r = 2$  that is contained in the iso-distant square for  $r = \infty$  with  $90^\circ$  rotated orientation with respect to the iso-distant square for  $r = 1$ . Also iso-distant contours for  $r$ -metrics with  $r < 1$  are possible and have the shape of asteroids with the sharper angular points and the more concave curved sides the closer the value  $r$  is to zero, but such iso-distant contours are seldom pictured. Only iso-distant contours with a fixed  $r$ -metric are generally assumed for a Minkowskian space, but in figure 19 we picture the iso-distant contours for  $r = 1, 1.35, 2, 4, \infty$  as ordered contours with the larger shapes for the smaller  $r$ -metrics.

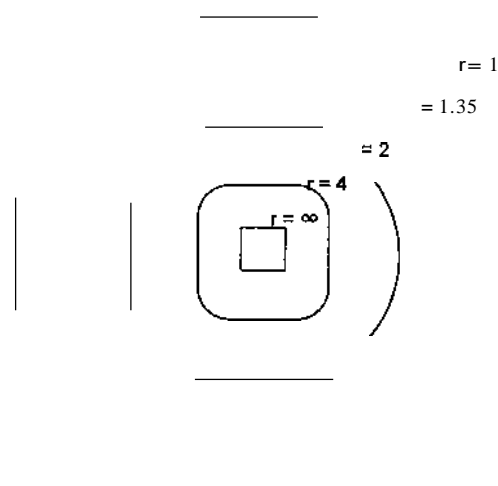

Figure 19. Minkowskian iso-distant contours with distance-dependent  $r$ -metrics.

The order for the shapes of varying r-metric contours in figure 19 have a special reason that will become clear in chapter 5, where Minkowskian iso-distant contours with a variable r-metric are shown to apply if individual iso-preference circles in a hyperbolic sensation space are incorrectly represented in a flat space, whereby the iso-preference circles become represented as iso-distant contours with variable r-metrics that range from 1 to about 2, depending on the object distances and the distance between the adaptation and ideal points of an individual.

Minkowski r-metrics for  $r \geq 1$  satisfy the axiomatic conditions for distances (non-negativity, symmetry and triangular inequality) allowing (1) a geometric representation of dissimilarities between objects as distances between points that represent the object configuration or (2) a geometric representation of preferences for objects as distances of object points to ideal object points of individuals. Generally the data for dissimilarities or preferences are on a rank order level of measurement, while their analyses as distances in a space solve the configuration of object points with distances that optimally fit the observed rank order. The axiomatic conditions for metric distance representations are extensively treated by Krantz, Beals and Tversky (Beals et al. 1968; Tversky and Krantz, 1970). In Minkowskian geometry the distances are not rotation invariant, unless the r-metric for  $r = 2$  specifies a Euclidean space. Distances in Minkowski spaces are only invariant under translation and reflection of its co-ordinates, while distances in Euclidean and non-Euclidean (hyperbolic or elliptic) spaces are invariant under translation and rotation of its co-ordinates. A data representation by some multidimensional analysis as space distances is often characterised as meaningful if the distances are invariant under rotation and translation of the space co-ordinates (Van de Geer, 1970; Suppes, et al. 1989, ch 12). If individuals evaluate objects or object pairs by geometric transformations of object-attribute spaces with individual parameters then invariance under translation may be lost, but conditional rotation invariance and meaningfulness can still be present. In chapter 6 we further extensively discuss the geometric foundation and meaningfulness of psychological measurement. For individual evaluations of objects or object pairs one may conceive personal evaluation spaces that have individually different object configurations, whereby there exists no common evaluation space, but only a common evaluation geometry. A common evaluation geometry with individually different object configurations may derive from individually different projections of a common object or stimulus space, where these projections depend on individual adaptation-level parameters for their projection origins and dimensional comparability weights. Rotation and translation invariance of personal evaluation spaces should preferably hold, because otherwise psychological measurement may become meaningless by a varying dependence on rotations and/or translations. We assume that individuals share a common stimulus or object space and have common types of geometric space transformations that characterise human perception, cognition, and preference. Given that individual parameters in such common types of geometric transformations of a common object or stimulus space determine personal evaluation spaces, we may apply the inverse of these geometric transformations to data representations in individual evaluation spaces in order to resolve the common object or stimulus space and the individual parameters.

### 3.1.2. Psychological relevance of non-Euclidean and Finsler geometries

Non-Euclidean geometries (Busemann, 1950a, 1955; Struik, 1950; Coxeter, 1957; Dubrovnik, et al. 1992) describe space points and distances on elliptic or hyperbolic surfaces, which are also respectively called Riemannian or Lobachevskian spaces. The term "non-Euclidean" has another meaning than not-Euclidean. Non-Euclidean spaces define infinitely small distances to be Euclidean and are thus differentially Euclidean geometries. Non-Euclidean geometries also satisfy the triangular distance inequality  $d(a,b) + d(b,c) \geq d(a,c)$  and the invariance of distances under translation and rotation. However, non-Euclidean geometries have hardly gained attention in psychology. These geometries describe hyperbolic or spherical surfaces that have a constant curvature, while all variably curved surfaces define spaces with a Finsler geometry, so-called after Finsler (1918) who first explored the complexities of geometries that are not constantly curved, and where Finsler distances need not to satisfy the triangular distance inequality. The (pseudo-)radius of a constantly curved space surface specifies by its inverse value a scale factor for its scaling to a non-Euclidean space with a unit radius, which scale factor is called the curvature of the space. Thus, the curvature of distances with a constant curvature scales such distances to distances on spheres or hyperbolic pseudo-spheres with a (pseudo-)radius of unity. Distances on spheres or hyperbolic surfaces with a unit (pseudo-)radius are measured by their arc lengths as respectively cosines of elliptic distances or hyperbolic cosines of hyperbolic distances. With few exceptions non-Euclidean geometries are not applied in the analysis of psychological spaces. The earliest exception for elliptic geometry as relevant for psychology seems Helmholtz (1891) who described just noticeable colour differences by spherical Weber fractions, which is amended by Schnüderger (1920) to another spherical colour metric. The earliest exception for hyperbolic geometry as relevant for psychology seems Luneburg's research and theory on the hyperbolic nature of binocular vision (Luneburg, 1947). A more general application exception is found in the data-analytic approach of Van de Geer (1970), who discussed the geometric properties and algebraic space solution of dissimilarity distances in elliptic and hyperbolic spaces and applied these non-Euclidean geometries in psychological data analysis. Van de Geer analysed several sets of metric (dis)similarity data as distances in an elliptic or hyperbolic geometry with a lower dimensionality than the representations urge in Euclidean spaces. Indow (1974) extended the multidimensional scaling technique to elliptic and hyperbolic metrics for empirical analyses of visual perception data (Indow, 1982) and colour perception data (Indow, 1993). Apart from these and few other exceptions (Ekman, 1965; Lindman and Caelli, 1978; Drosler, 1979), non-Euclidean geometry seems not to be significant for psychological research and theory. Even in the geometric approach to fundamental measurement theory (Suppes et al. 1989, ch. 12 to 14), non-Euclidean geometry is mainly discussed as relevant for relativistic physics and Luneburg's visual space theory or only as a theoretical alternative for distance models. It contains an axiomatic description of non-Euclidean and projective geometries for the representation of binary relation data as distances in hyperbolic, or elliptic, or open geometries with a constant or zero curvature, but no theoretical basis for rational distance metrics of non-Euclidean or its projective, open geometries for analysis or measurement in psychology. Only recently Finsler geometry has become relevant for psychology by the theory of



Fechnerian distance metrics for multidimensional stimulus spaces, developed by Dzhafarov and Colonius (1999, 2001), who define Fechnerian distances in Finsler spaces. Finsler geometries (Busemann, 1942, 1950b; Rund, 1959, Asanov, 1985; Matsumoto, 1986) define spaces wherein differently curved, shortest line lengths between points specify Finsler distance metrics that are direction- and location-dependent. Tensor algebra (Gerretsen, 1962; Sokolnikoff, 1964; Dubrovin et al., 1992) for co-ordinate transformations of space locations and covariant transformations of local curvatures is the generalised matrix algebra for a Finsler geometry.

In Newtonian physics the stimulus space is Euclidean and in Einsteinian physics non-Euclidean, where one might be inclined to assume that stimulus measurements for human perception are well described by Newton's Euclidean space, but in the sequel we don't exclude the possibility of hyperbolic or elliptic stimulus geometries as consistent alternatives. In the sequel it is shown that non-Euclidean geometry is relevant either for the geometry of sensation spaces that derive from a Euclidean stimulus space or for the geometry of stimulus spaces that correspond to flat (Euclidean or Minkowskian) sensation spaces. Without using differential geometry expressions it is proved that if the stimulus space itself is Euclidean that then the sensation space is hyperbolic or that if the sensation space is flat (Minkowskian or Euclidean) that then the stimulus space is non-Euclidean (elliptic or hyperbolic). Due to the logarithmic Fechner-Helson transformation of a stimulus space to a sensation space, weighted and translated sensation spaces define by inverse (thus exponential) transformations power-raised stimulus fraction spaces. Although stimuli are specified by Euclidean, or hyperbolic, or elliptic spaces, their respective, power-raised fraction spaces are Finsler spaces of subjective stimulus magnitudes that correspond to the exponential transformation of individually weighted and translated spaces of comparable sensations. Ratio's of the dimensional values of binary space points in power-raised stimulus fraction spaces correspond to dimensional distances in individual sensation spaces, but distances of these binary space points may become location- and direction-dependent distances, in accordance with the Finsler distance metric in the Fechnerian scaling theory of Dzhafarov and Colonius (1999, 2001). However, in the sequel we demonstrate that the location and direction dependence of distances in power-raised stimulus fraction spaces is much more restricted than in Fechnerian scaling theory. Firstly, the power exponents are only direction-dependent, because determined by rotational parameters. Secondly, the location dependence reduces to a space scaling that is defined by the stimulus fraction space with the (psychophysical-common) adaptation point as dimensional unit points. Since power-raised stimulus fraction spaces are defined by the exponential transformation of translated and weighted Fechner sensation spaces of individuals, their matched space configurations define a common Fechner sensation space that corresponds to the stimulus space, where that matched Fechner sensation space or its stimulus space is the common Euclidean object space.

As further shown in chapter 4, projective geometries (Busemann and Kelly, 1953) of open spaces with a Euclidean, or hyperbolic, or elliptic distance metric are relevant for the analysis of dissimilarity representation by space distances, due to the individual projection transformations of infinite and flat or hyperbolic sensation spaces to open judgmental response spaces by the response function, either the hyperbolic

tangent function, derived in section 2.2, or the arctangent function, derived as unique alternative in the next chapter. As one may expect from the identity of response and monotone valence functions, similar matters hold for analyses of preferences for objects with monotone valences, where projectively weighted response functions transform comparable sensation spaces to ideal axes in open response spaces, as demonstrated in chapter 5. In that chapter we also show that the permissible geometries of valence spaces for objects with single-peaked valences are either open Finsler geometries (if the sensation space is flat) or open-hyperbolic geometries (if the sensation space is hyperbolic). Fortunately, open Finsler geometries of single-peaked valence spaces are specified by curvatures that are determined by metric functions of individually weighted sensation space distances to the ideal point. Due to their distance-dependent curvature, these open Finsler geometries are projectively flat Finsler spaces (Matsumoto, 1991), whereby the tensor-algebraic complexities of such single-peaked valence spaces can be avoided. Based on individually different transformations of a common object space to individual response or preference spaces, we will later describe iterative solutions for the analyses of dissimilarities (chapters 4 and 7) and preferences with monotone, or single-peaked, or mixed valences (chapters 5 and 7). The solutions are based on inverse transformations of open response spaces or open single-peaked valence spaces to a common Euclidean object space.

### 3.2. **The relationship** between sensation **and** stimulus geometries

Researchers in psychology generally assume that psychological spaces can be described by Euclidean or Minkowskian geometry. However, one may question whether psychological spaces, as individual response or preference spaces, are indeed Euclidean or Minkowskian. In the next section we first investigate what Minkowskian sensation spaces and their transformation by the inverse **Fechner-Helson** psychophysical function imply for the geometry of the stimulus space. Secondly, assuming a Euclidean space of stimuli that are transformed by the Fechner-Helson function, the geometry of sensation spaces is determined. In the last section of this chapter, we discuss the relationship between geometries of stimulus and sensation spaces in view of the alternative psychophysical function of Stevens' power transformation of stimulus to subjective stimulus magnitude dimensions.

#### 3.2.1. *Flat sensation and non-Euclidean stimulus spaces*

A dimension of a flat sensation space becomes exponentially transformed by the inverse Fechner-Helson psychophysical function to a constantly curved stimulus fraction dimension. Since non-Euclidean spaces are constantly curved, we see that a sensation space with a Minkowski  $r$ -metric corresponds to a non-Euclidean stimulus geometry with a constant curvature. In the next mathematical section we prove that if:

- a) Minkowskian geometry holds for sensation spaces;
  - b) sensations are defined by Fechner-Helson functions of stimuli;
  - c) independent sensation dimensions imply independent stimulus dimensions;
- or replacing c) by the weaker alternative that
- d) a stimulus space is rotation-invariant;

then the geometry of the stimulus space (or objectively measured attribute space of cognitive objects) is non-Euclidean (hyperbolic or elliptic). The  $r$ -metric for independent sensation dimensions implies exponential tenns for the embedding Euclidean co-ordinates of the corresponding non-Euclidean stimulus space, whereby the Euclidean Pythagorean expression defines exponential tenns that are power-raised by  $r$  as  $r$ -metric parameter of the corresponding sensation dimensions. Thereby, parameter  $r/2$  functions as weight of the stimulus values in the squared, exponential co-ordinate tenns. This weight is the scale factor or space curvature that equals the inverse of the (pseudo-)radius of the non-Euclidean stimulus space. Thus, the curvature of the non-Euclidean stimulus space equals half the  $r$ -metric of the sensation space, where curvature  $\zeta_r = -r/2$ , if the stimulus space is hyperbolic, or  $\zeta_r = r/2$ , if elliptic. After scaling to unit curvature the non-Euclidean stimulus space corresponds to a Euclidean Fechner-sensation space, while individually oriented, weighted, and translated dimensions of an intensity-comparable Minkowski sensation space correspond to individually oriented, power-raised stimulus-fraction dimensions as subjective stimulus-magnitude dimensions of a rotation- and translation-invariant, non-Euclidean stimulus space with curvature  $\zeta_r = \pm r/2$ .

The reverse formulation of the result may be more relevant from a psychological point of view: a non-Euclidean stimulus geometry and the Fechner-Helson psychophysical function specify a Euclidean or Minkowskian geometry for sensation spaces. The remarkable aspect is that the non-Euclidean stimulus space itself is rotation-invariant, but corresponding individual sensation spaces with  $r$ -metrics other than  $r = 2$  are *not* invariant under rotation and describe different space distances for individuals with differently oriented sensation dimensions of the same space configuration. Two-dimensional stimuli at equal distances from individual stimulus adaptation points define circles on their non-Euclidean stimulus surface, but on corresponding sensation planes with a Minkowski  $r$ -metric the iso-distant contours of sensations to the adaptation point are individually oriented, non-circular contours (except for  $r = 2$ ), as shown in figure 19. For example in a city-block geometry ( $r = 1$ ) the iso-distant contours are squares that have differently located adaptation points as centres and individually oriented corners, if individuals have different adaptation points and different evaluation-relevant sensation dimensions. Similar things hold for individual iso-distant contours with other  $r$ -metrics, but in the corresponding non-Euclidean stimulus fraction space all iso-distant contours are represented by circles. In comparable sensation spaces the dimensions are individually weighted by weights that equal twice the inverse of dimensional distances between the just noticeable and adaptation levels. In comparable sensation spaces the individual iso-distant contours are symmetric, but in a common Fechnerian sensation space their shapes are asymmetric, where comparable sensation dimensions correspond to power-raised stimulus fraction dimensions with their adaptation point as unit point and Fechner sensation dimensions to stimulus dimensions with their stimulus threshold as unit point.

Referring to expressions (15a) to (15f) for an individual sensation dimension and (12d) for a Fechnerian sensation dimension, we see that individual sensation spaces are translated Fechnerian sensation spaces. If Fechner spaces are Minkowskian, also individual sensation spaces are

Euclidean or Minkowskian, because invariant under translations. For two independent sensation dimensions  $l$  and  $k$  a sensation  $s_i$  in a Minkowskian (or Euclidean) sensation plane  $\{l, k\}$  with  $r$  as the  $r$ -metric writes as,

$$|s_{il}|^r + |s_{ik}|^r = |s_i|^r, \quad (35a)$$

Now substituting in (35a)  $s_i = \ln(x_i/b_i)$ , as the Fechner-Helson function for  $x_i/b_i$  of (15a), we look for a function  $I\{x_i/b_i\}$  in a stimulus space, where an appropriate Pythagorean theorem holds for its geometry. Since we assume dimensional independence to be preserved, we write this as

$$I\{\ln(x_{i1}/b_{i1})\}^r + I\{\ln(x_{ik}/b_{ik})\}^r = I\{\ln(x_i/b_i)\}^r, \quad (35b)$$

where  $b_{i1}$  and  $b_{ik}$  are the projections of stimulus adaptation point  $b$  provided  $I(x) \geq 1$  we can drop the restriction to absolute terms, while for  $0 \leq I(x) \leq 1$  where we have to take reciprocal function terms, and by also taking exponents on both sides we obtain

$$\text{and} \quad \begin{aligned} (f\{x_{i1}/b_{i1}\})^r \cdot (f\{x_{ik}/b_{ik}\})^r &= (f\{x_i/b_i\})^r & I(x) \geq 1 \\ (f\{x_{i1}/b_{i1}\})^{-r} \cdot (f\{x_{ik}/b_{ik}\})^{-r} &= (f\{x_i/b_i\})^{-r} & 0 \leq f(x) \leq 1 \end{aligned} \quad (36a)$$

For  $r=1$ , the city block model of sensation distances, (36a) reduces to

$$\begin{aligned} f\{x_{i1}/b_{i1}\} \cdot f\{x_{ik}/b_{ik}\} &= f\{x_i/b_i\} & I(x) \geq 1 \\ [1/f\{x_{i1}/b_{i1}\}] \cdot [1/f\{x_{ik}/b_{ik}\}] &= 1/f\{x_i/b_i\} & 0 \leq I(x) \leq 1 \end{aligned} \quad (36b)$$

Easily one sees that (36b) specifies a non-Euclidean stimulus geometry. For any triangle ABC with a  $90^\circ$  angle at C opposite side  $c$  and legs  $a$  and  $b$  in a non-Euclidean geometry with curvature  $\zeta$  (Busemann, 1950a), the theorem of Pythagoras is written for an elliptic geometry as

$$\cos(\zeta \cdot a) \cdot \cos(\zeta \cdot b) = \cos(\zeta \cdot c), \quad \{\text{elliptic geometry}\} \quad (37a)$$

or the hyperbolic theorem of Pythagoras as

$$\cosh(\zeta \cdot a) \cdot \cosh(\zeta \cdot b) = \cosh(\zeta \cdot c), \quad \{\text{hyperbolic geometry}\} \quad (37b)$$

Since (37a) or (37b) apply to all right-angled triangles in subspaces of a non-Euclidean geometry of any dimensionality, we obtain for  $r=1$  that (36b) specifies the stimulus geometry to be either double-elliptic by  $I\{f(x)\} = \cos(\zeta \cdot x)$  or  $I\{f(x)\} = \cosh(\zeta \cdot x)$ , where  $\zeta$  is the curvature for  $r=1$ , or  $I\{f(x)\} = \cosh(\zeta \cdot x)$  then this function  $I(x)$  for stimulus values satisfies (36b), since  $\cosh[\zeta \cdot x] \geq 1$ , where that hyperbolic stimulus geometry has a negative curvature  $\zeta$ , but also that  $\cosh[-\zeta \cdot x] = \cosh[\zeta \cdot x]$  for the unlimited values of stimuli  $x$  on hyperbolic surfaces. Alternative (37a) asks that cosine functions satisfy  $0 \leq I(x) \leq 1$ , which requires that stimulus values  $x$  in  $\cos(\zeta \cdot x)$  satisfy  $0 \leq \zeta \cdot x \leq \frac{1}{2}\pi$ , where elliptic curvatures  $\zeta$  are positive. The stimuli  $x$  then have the finite values on semi-definitely positive orthant of double-elliptic spaces.

For a Minkowski sensation space of any  $r$  the possibility of a hyperbolic stimulus geometry follows directly by taking function  $I$  in (35b) as  $I(x) = \exp[\exp(x)] \geq 1$ , whereby  $\ln[I(x)] = \exp(x) \geq 0$  and (35b) rewrites

$$\text{as} \quad e^{i l l} + e^{i k k} = e^{i} \quad (38a)$$

Taking the in (38a) as squared co-ordinates and introducing a factor of a half for a reason that will become clear in the sequel, we define

$$x_{i1}^2 = \frac{1}{2} \cdot \{\ln[f(x_{i1}/b_1)]\} / T = \frac{1}{2} \cdot \exp(T \cdot x_{i1}/b_1) \tag{38b1}$$

as also  $x_{ik}^2 = \frac{1}{2} \cdot \{\ln[f(x_{ik}/b_k)]\} / T = \frac{1}{2} \cdot \exp(r \cdot x_{ik}/b_k)$

$$x_{ih}^2 = \frac{1}{2} \cdot \{\ln[f(x_i/b)]\}^{-r} = \frac{1}{2} \cdot \exp(-r \cdot x_i/b) \tag{38b2}$$

After multiplication by 2 we obtain at once the Euclidean co-ordinate expression for hyperbolic vectors  $i$  for (38a) as

$$\sqrt{x_{i1}^2 + x_{ik}^2} = x_{i1} = \sqrt{\frac{1}{2} \cdot \exp(\frac{1}{2} r \cdot x_i/b)} \tag{38b3}$$

whereby  $x_i^{h'} = \sqrt{\frac{1}{2} \cdot \{\ln[f(x_i/b)]\}^{-\frac{1}{2}r}} = \sqrt{\frac{1}{2} \cdot \exp(-\frac{1}{2} r \cdot x_i/b)}$

$$x_{i1} \cdot x_{ih} = \frac{1}{2} \tag{39a}$$

defines stimuli  $x_i/b$  to be located on rectangular hyperbola that jointly constitute a hyperbolic surface for  $(k', l', h')$  with pseudo-radius  $p=1$  for any  $r$ -metric, which has been the reason for the scaling by factor  $\frac{1}{2}$ . The hyperbolic surface is thus described by Euclidean co-ordinates that are asymptotic to its surface by

$$x_{ik}^2 + x_{i1}^2 - x_{ih}^2 = -1. \tag{39b}$$

Given that the surface of  $x_i/b$  for any  $r$  is hyperbolic we have  $f'(x_i/b)$  as a projection function for points  $(x_i/b)$  on a Euclidean plane  $(k', l')$  (bold indices denote Euclidean values that corresponds to hyperbolic dimensions  $k, l$ , where a third Euclidean co-ordinate  $h'$  is needed in order to represent the hyperbolic surface by Euclidean co-ordinates. Planes that are orthogonal to  $(k', l')$  intersect the hyperbolic surfaces by rectangular hyperbola, but  $45^\circ$  rotated co-ordinates with respect to  $h'$  have planes parallel to a  $45^\circ$  rotated plane  $\{k, l\}$  which intersect the hyperbolic surface by circles. Projections of the points  $x_i/b$  on the  $45^\circ$  rotated dimension  $h$ , orthogonal to plane  $(k, l)$ , as the projections  $x_{ih}$ , describe the centres of the intersection circles by the planes parallel to  $(k, l)$ . For dimensions  $x_{i1}$  and  $x_{ih}$  the equation for a hyperbolic surface writes again as

$$x_{ih}^2 - (x_{ik}^2 + x_{i1}^2) = 1, \tag{39c}$$

where the positive solution for the expression is used to construct the hyperbolic surface in a Euclidean space as one of the sheets of a so-called two-sheeted revolution hyperboloid. In this presentation the revolution of one dimension  $l$  (or  $k$ ) around dimension  $h$  defines a two-dimensional hyperbolic space and revolutions of  $l$  and  $k$  around  $h$  define a three dimensional hyperbolic space that is represented by four Euclidean co-ordinates and so on for more dimensional hyperbolic spaces. Here,  $p=1$  is a pseudo-radius of the hyperboloid. Euclidean co-ordinates in (39) are related to the two hyperbolic curved dimensions of surface  $(k, l)$  with a curvature parameter  $\zeta_r$  that corrects its radius to  $|p|=1$  for a corresponding sensation plane  $(k, l)$  with a  $r$ -metric of any  $r$  by

$$\begin{array}{l} \sinh(\zeta_r \cdot x_{i1}/b) \\ \sinh(\zeta_r \cdot x_{ik}/b) \\ \text{COsh}(Y_r, x_i/b) \end{array} \begin{array}{l} x_{i1} \\ x_{ik} \\ x_{ih} \end{array} \left| \zeta_r \right. \quad (40a)$$

Here the co-ordinate  $h$  is orthogonal to the hyperbolic surface and the projection of hyperbolic vectors  $x_i/b$  on plane  $(k, l)$  with co-ordinates that correspond to hyperbolic dimensions  $k$  and  $l$  is defined by

$$\sinh(\zeta_r \cdot x_i/b) = x_{i1} \quad (40b)$$

The stimulus origin becomes in any sensation space a unique infinity direction, but on the hyperbolic stimulus surface it remains the point  $x_i/b=0$  that is defined by  $x_{i1}=1$  and  $x_{ik}=x_{il}=0$ . Notice that a hyperbolic stimulus space is no longer a positive orthant space if one translates the hyperbolic stimulus space to the individual adaptation point  $x_i/b=0$ . Hyperbolic spaces are rotation and translation invariant spaces. The rigidly rotated Euclidean co-ordinate system by  $-45^\circ$  with respect to dimension  $h$  of (40a) brings the co-ordinates to a position where the so rotated co-ordinates  $h'$ ,  $k'$  and  $l'$  are orthogonal asymptotes of the hyperbolic surface. The rigid rotation of co-ordinates  $k$ ,  $l$  and  $h$  by  $-45^\circ$  with respect to  $h$ , then describe hyperbolic vectors  $x_i/b$  in terms of the already defined asymptotic co-ordinate system as rotation of (40a) with its pseudo-radius scaled to  $p=1$  by  $\zeta_r$  for any  $r$  by

$$\begin{array}{l} \text{and} \\ \text{as also} \end{array} \begin{array}{l} X_{ih'} = (x_{ih} + x_{i1})/\sqrt{2} \\ X_{il'} = \{x_{ih} \quad x_{il}\}/\sqrt{2}, \\ X_{ik'} = \{X_{ih} \quad X_{ik}\}/\sqrt{2}, \end{array} \quad (40c)$$

or by terms of (40a,b) as

$$x_{i,h'} = \{\cosh(\zeta_r \cdot x_i/b) + \sinh(\zeta_r \cdot x_i/b)\}/\sqrt{2} = \sqrt{2} e^{\zeta_r \cdot x_i/b} \quad (40d1)$$

where on co-ordinate  $h'$  the hyperbolic dimensions  $k$  and  $l$  are projected as

$$X_{ih'lk} = \sqrt{2} \cdot e^{-\zeta_r \cdot x_i/b} \quad (40d2)$$

$$x_{ih' ll} = \sqrt{2} \cdot e^{-\zeta_r \cdot x_i/b} \quad (40dJ)$$

while vector  $X_{i1}$  on co-ordinate  $h'$  becomes

$$x_{ih'} = [\cosh(\zeta_r \cdot x_i/b) - \sinh(\zeta_r \cdot x_i/b)]/\sqrt{2} = \sqrt{2} e^{-\zeta_r \cdot x_i/b} \quad (40e1)$$

with projections of  $x_{i1}$  in plane  $(k', l')$  on  $k'$  and  $l'$  as

$$x_{ik'} = \sqrt{2} \cdot e^{\zeta_r \cdot x_i/b} \quad (40e2)$$

$$\sqrt{2} \cdot e^{\zeta_r \cdot x_i/b} \quad (40e3)$$

We rotate these Euclidean co-ordinates backward by  $45^\circ$  in order to obtain again

and 
$$(X_{ih'1l} - x_{i1} \cdot l/\sqrt{2} - X_{il} \sinh(\zeta_r \cdot x_{i1}/b_1))$$
 as well as 
$$(x_{ih'1k} - x_{ik})/\sqrt{2} - x_{ik} \sinh(\zeta_r \cdot x_{ik}/b_k) \tag{41a1}$$

while also 
$$(x_{i1} + x_{jh'})/\sqrt{2} - x_{i1} \cosh(\zeta_r \cdot x_{i1}/b_1),$$
 
$$(x_{i11} + x_{ih'1})/\sqrt{2} - x_{ih11} \cosh(\zeta_r \cdot x_{i1}/b_1) \tag{41a2}$$
 
$$(x_{ik1} + x_{ih'1k})/\sqrt{2} = x_{ih1k} \cosh(\zeta_r \cdot x_{ik}/b_k)$$

By the hyperbolic cosine terms of (41a1) and (41a2) we obtain for any r the hyperbolic, Pythagorean expression of (37b) by

$$\cosh[\zeta_r \cdot x_{ik}/b_k] - \cosh[\zeta_r \cdot x_{i1}/b_1] = \cosh[\zeta_r \cdot x_i/b]. \tag{41b}$$

The equivalence of (3sb) and (40e) defines by  $\cosh(\pm \zeta_r \cdot x) = \cosh(\frac{1}{2} \zeta_r \cdot x)$  the negative hyperbolic curvatures

$$\zeta_r = -\frac{1}{2} \zeta_r. \tag{41e}$$

Thus, flat sensation spaces with any r-metric may derive from hyperbolic stimulus spaces with pseudo-radius  $p_r = 1/\zeta_r = -2fr$ . Rotation invariance of the stimulus space follows from the transformations of Minkowskian sensation spaces by the Fechner-Helson function to stimulus surfaces with constant curvature. A constant curvature for the stimulus space specifies its rotation invariance and its transformation to sensation spaces yields a flat space with corresponding independent dimensions, but no rotational invariance for any Minkowski r-metric, except for r=2. Translating the hyperbolic stimulus space to the space adaptation point  $x_i/b = 1$  that corresponds with origin  $\ln(x_i/b) = 0$  of the Fechner-Helson sensation space, we obtain (41b) as

$$\cosh[\zeta_r (x_{ik}/b - 1)] \cdot \cosh[\zeta_r (x_{i1}/b - 1)] = \cosh[\zeta_r (x_i/b - 1)]. \tag{42}$$

This stimulus space with hyperbolic curvature  $\zeta_r = -\frac{1}{2} \zeta_r$  is an individually weighted and translated space. Its stimulus origin becomes the unique point at the distance of unity from the origin in (41b), where the space origin corresponds to a negative infinity in a unique direction of the Minkowskian sensation space.

So if a sensation space has a Minkowski r-metric then the geometry of a corresponding stimulus space may be hyperbolic and has a unit pseudo-radius provided that we scale the stimulus space by curvature  $\zeta_r = -\frac{1}{2} \zeta_r$ . Notice that we have in (42c) also the stimulus space translated to the space adaptation point that also is the Minkowskian space origin. However, we have not excluded or disproved a possibility of an elliptic stimulus geometry. If for (35b) we define  $f(x) = \exp[\exp(i'x)] \leq 1$  with  $1 = (-1)$  the function satisfies the condition that its value range is between zero and unity. We then redefine (40d) and (40e) by defining  $\frac{1}{2} \cdot \ln\{f(x)\}^{\frac{1}{2}} = \frac{1}{2} \cdot \exp[r \cdot i \cdot x]$  as tangential Euclidean co-ordinates  $x_{iki}$  and  $x_{ih'i}$ , with  $x_{ih'i} = \frac{1}{2} \cdot \exp[-r \cdot i \cdot x]$  as third Euclidean co-ordinate of a spherical stimulus surface. After a rigid rotation of  $45^\circ$  to co-ordinates  $x_{ik} \cdot x_{i1}$ , and  $x_{ih}$ , and a translation by  $1 - (x_{ih})$  we obtain the usual central co-ordinates of that spherical stimulus space, where

its elliptic curvature is positive and defined by

$$\zeta_r = \frac{1}{2}r. \quad (43a)$$

Co-ordinate system  $\mathbf{k}'$ ,  $\mathbf{l}'$  and  $\mathbf{h}'$  in analogy to (40d) and (40e) where the stimulus terms  $x/b$  are replaced by  $i \cdot x_j / b$  are defined by tangential Euclidean co-ordinates of a sphere as

$$x_{ih'} = \frac{1}{\sqrt{2}} \cdot e^{-i \cdot \zeta_r} \cdot \frac{x_i}{b} \quad (43b1)$$

as well as

$$x_{ih'|k} = \frac{1}{\sqrt{2}} \cdot e^{-i \cdot \zeta_r} \cdot \frac{x_{ik}}{b_k} \quad (43b2)$$

$$x_{ih'|l} = \frac{1}{\sqrt{2}} \cdot e^{-i \cdot \zeta_r} \cdot \frac{x_{il}}{b_l}, \quad (43b3)$$

while vector  $x_i$  is defined by

$$x_i = \frac{1}{\sqrt{2}} \cdot e^{i \cdot \zeta_r} \cdot x_i / b \quad (43c1)$$

with projections on  $\mathbf{k}'$  and  $\mathbf{l}'$  as

$$x_{ik'} = \frac{1}{\sqrt{2}} \cdot e^{i \cdot \zeta_r} \cdot \frac{x_{ik}}{b_k} \quad (43c2)$$

$$x_{il'} = \frac{1}{\sqrt{2}} \cdot e^{i \cdot \zeta_r} \cdot \frac{x_{il}}{b_l} \quad (43c3)$$

From expressions (43b) to (43c) the usual Euclidean co-ordinates for a sphere with unit radius follow by a rigid  $45^\circ$  rotation to  $\mathbf{k}$ ,  $\mathbf{l}$  and  $\mathbf{h}$  with respect to  $\mathbf{h}'$  and its translation to the sphere centre as

$$\begin{aligned} \sqrt{\{1 - [x_i + x_{ih'}]_l\} / 2} &= \sin(\zeta_r \cdot x_i / b) = x_{ih} \\ [x_{il'} + x_{ih'}]_l / \sqrt{2} &= \cos(\zeta_r \cdot x_{il} / b_l) = x_{il} \end{aligned} \quad (44a)$$

as well as

$$[x_{ik'} + x_{ih'}]_k / \sqrt{2} = \cos(\zeta_r \cdot x_{ik} / b_k) = x_{ik}$$

with  $x_{ik}^2 + x_{il}^2 = x_i^2$  and  $x_{ih}^2 + x_{il}^2 = 1$ , which describes by dimensions  $h$ ,  $l$  and  $k$  a sphere. Thus these co-ordinates are Euclidean co-ordinates for rotation-invariant, elliptic stimuli.

Condition  $0 \leq f(x) \leq 1$  is satisfied, but its space uniqueness requires that  $\frac{1}{2}r \cdot x_i / b$  is restricted to  $\frac{1}{2}r \cdot x_i / b \leq \pi$  for the positive orthant of the double-elliptic geometry of stimuli  $\zeta_r(x/b)$  expressed in radian values. Its distances are defined by the elliptic Pythagorean expression as

$$\cos[\zeta_r \cdot x_{ik} / b_k] \cdot \cos[\zeta_r \cdot x_{il} / b_l] = \cos[\zeta_r \cdot x_i / b], \quad (44b)$$

or in decimal terms with adaptation space point  $x_i / b = 1$  as space origin with points  $x_{ih} = \pm 1$  and  $x_{il} = x_{ik} = 0$  as polar space points as

$$\cos[\zeta_r \cdot (x_{ik} / b - 1)] \cdot \cos[\zeta_r \cdot (x_{il} / b - 1)] = \cos[\zeta_r \cdot (x_i / b - 1)] \quad (44c)$$

A non-Euclidean geometry for stimuli may be seen as compatible with physics, where space-time events are characterised by the field of real



numbers and when measured relative to an inertial space-time frame are described by hyperbolic geometry. In physics the optical object space is elliptic and expanding with radius  $c \cdot t'$  for  $t$  as time and  $c$  as velocity of light. However, the (pseudo-)radius of the physical space is so extremely large that stimulus intensities in the range of human perception become to exhibit a Euclidean geometry, while they are also not influenced by the space-time relativity of physics. If the stimulus geometry is Euclidean then this is incompatible with a flat (Minkowskian or Euclidean) geometry of sensation spaces.

Above we proved that flat (Euclidean or Minkowskian) sensation spaces correspond to a non-Euclidean (hyperbolic or double-elliptic) stimulus geometry and that the absolute curvature  $|\zeta|$  of the non-Euclidean stimulus geometry equals  $V_u$  as half the r-metric of the flat sensation space. A hyperbolic stimulus geometry is compatible with the non-Euclidean geometry of modern physics, where the hyperbolic geometry describes the measurement relativity of the four-dimensional space-time universe, while the three-dimensional elliptic space applies to the optical subspace of the expanding hyperbolic universe (Robb, 1921). A non-Euclidean stimulus fraction space with the adaptation point as unit space point could have a unit curvature, if its fraction space would reduce the extremely large radius of the non-Euclidean physical space to unity, which seems unlikely, but would imply that the sensation space is Euclidean. On the one hand the extremely large (pseudo-)radius of the physical space itself would imply that the sensation space is Minkowskian with a r-metric that approaches  $r = 0$ , which is not acceptable since it would imply that largest dimensional sensation dominates the evaluation of stimuli. On the other hand a flat sensation space implies that the stimulus space must be non-Euclidean with a finite curvature  $|\zeta| = 1/p = 1/2r < \infty$ , because if the r-metric of the sensation space would approach infinity/then the stimulus space reduces to a point by its radius  $p = 0$ , which is also not acceptable. Since the (pseudo-)radius of the non-Euclidean physical space is extremely large, it seems questionable that the sensation space is flat and the stimulus space non-Euclidean. But the non-Euclidean space of physics defines by its very large (pseudo-)radius that stimuli in the range of human perception are well described by Newton's Euclidean space and if stimuli are Euclidean then the sensation space must be hyperbolic, as shown next.

### 3.2.2. Euclidean stimulus and hyperbolic sensation spaces

Exponentially transformed sensation dimensions define by the inverse Fechner-Helson function Euclidean stimulus dimensions. Since exponential dimension terms are Euclidean co-ordinates for the embedding of a hyperbolic space, the sensation space must be hyperbolic, if the stimulus space is Euclidean. A hyperbolic sensation geometry derives mathematically from the following assumptions:

- a) Euclidean geometry holds for the stimulus space;
  - b) Fechner-Helson transformation of stimuli define sensations;
  - c) independent stimuli dimensions imply independent sensation dimensions;
- or again replacing c) by alternative,
- d) rotational invariance holds for individual sensation spaces.

For two stimulus dimensions with a Euclidean geometry we explore in a reversed, but similar, way by the appropriate Pythagorean expression the geometry of sensation spaces that follows from the Fedmer-Helson transformation of a Euclidean stimulus space. In a Euclidean stimulus geometry the Pythagorean expression, for stimulus  $x$ , in a plane with dimensions  $k$  and  $l$  and adaptation point  $b$ , reads as

$$(x_{il}/b_l)^2 + (x_{ik}/b_k)^2 = (x/b)^2 \quad (45a)$$

Using the inverse Fechner-Helson psychophysical function we obtain

$$e^{2(y_{il} - a_l)} = e^{2(Y_{ik} - a_k)} = e^{2(y_{il} - a)} \quad (45b)$$

where  $a_l$ ,  $a_k$  and  $a$  are the projections of the space adaptation point  $a'$  as the point on the exponential curved vector  $y'$  through the adaptation point with value  $y' = a'$ . The exponential terms of real values directly implies a hyperbolic sensation geometry, because the square root of the terms in expression (45b) as  $v_{il}$ ,  $v_{ik}$  and  $v_i$  as well as  $v_{ih} = 1/v_{il}$  define rectangular hyperbola for  $i$ , as shown for hyperbolic stimulus planes. Writing  $s_i = y_i - a$ ,  $s_{il} = y_{il} - a$  and  $s_{ik} = y_{ik} - a$  we obtain by the terms of (45b) a hyperbolic sensation space with negative unit curvature by defining Euclidean co-ordinates  $v_h$ ,  $v_k$  and  $v_l$

$$v_i = \sqrt{\frac{1}{2}} \cdot e^{-s_i}, \quad v_{il} = \sqrt{\frac{1}{2}} \cdot e^{-s_{il}}, \quad v_{ik} = \sqrt{\frac{1}{2}} \cdot e^{-s_{ik}}, \quad (46a)$$

and

$$v_{ih} = \sqrt{\frac{1}{2}} \cdot e^{s_{il}}, \quad v_{ihl} = \sqrt{\frac{1}{2}} \cdot e^{s_{il}}, \quad v_{ihk} = \sqrt{\frac{1}{2}} \cdot e^{s_{ik}}, \quad (46a2)$$

where  $v_{ih}^2 + v_{il}^2 = v_i^2$  for curvature  $\zeta = -1$  equals after multiplication by 2 expression of (45b). The usual Euclidean co-ordinate description of a hyperbolic sensation surface is obtained by a rigid  $45^\circ$  rotation of Euclidean co-ordinates  $v_h$ ,  $v_k$  and  $v_l$  to co-ordinates  $s_h$ ,  $s_k$  and  $s_l$  of the negative unit curvature space as

$$\begin{bmatrix} v_{ihl} & v_{il} \end{bmatrix} \sqrt{2} = \begin{bmatrix} \sinh(s_h) & s_{il} \end{bmatrix}$$

and

$$\begin{bmatrix} v_{ihk} & v_{ik} \end{bmatrix} \sqrt{2} = \begin{bmatrix} \sinh(s_k) & s_{ik} \end{bmatrix} \quad (46b)$$

as well as

$$\begin{bmatrix} v_{ih} + v_{il}/2 \end{bmatrix} = \cosh\{s_l\} \quad s_l$$

Since also

$$\begin{bmatrix} v_{ihk} + v_{ik}/2 \end{bmatrix} = \cosh(s_k) \quad (46b2)$$

and

$$\begin{bmatrix} v_{ihl} + v_{il} \end{bmatrix} / \sqrt{2} = \cosh(s_l) \quad (46b3)$$

these cosine terms define the hyperbolic Pythagorean expression as

$$\cosh[s_{il}] \cdot \cosh[s_{ik}] = \cosh[s_l] \quad (47a)$$

From the definition of a two-sheeted revolution hyperboloid with a pseudo-radius of unity and Euclidean co-ordinates  $k$ ,  $l$  and  $h$  we have

$$s_{ih}^2 - (s_{il}^2 + s_{ik}^2) = 1 \quad (47b)$$

Notice that we applied no scale factors for sensations  $s_i$  and its hyperbolic dimensions. For the hyperbolic sensation surface with unit curvature and dimensional weights for the sensation dimensions

$S_{ik} = 2(Y_{ik} - a_k) / a_k$  of comparable sensations  
 $S_{ik} = 2(y_{ik} - ar/a_k)$ , the hyperbolic Pythagorean expression is written as

$$\text{COSH}[2(Y_{ik}/a_k - 1)] \cdot \cosh[2(y_{ik}/a_k - 1)J] = \cosh[2(y_{ik}/a_k - 1)]. \quad (47c)$$

The space origin for  $y_{ik}/a_k = 1$  for all  $k$  is an individually to unity weighted, dimensional adaptation point. Since curvature  $\zeta = -1$  of this weighted hyperbolic sensation space it has a pseudo-radius of  $W_{ik}$ , while the individual weights make weighted sensations  $s_{ik} = 2(y_{ik}/a_k - 1)$  individually comparable sensation differences from the adaptation point. Sensations can't be elliptic, because if it would be then the terms of (45b) ought to be expressed by terms  $\sqrt{\frac{1}{2}} \{ \exp[i \cdot (y_{ik} - a_k) J] \}$ , which by the inverse Fechner-Helson function  $x/b = \exp[y_{ik} - a_k]$  would imply that the quadratic terms in (45a) have power exponents 1.2 for  $\frac{1}{2}(x/b)^{1.2}$ . But this incompatible with a Euclidean geometry of stimuli. Hence it is proved that, if the Fechner-Helson function transforms Euclidean stimuli to sensations, the sensation space only can have the rotation-invariant, hyperbolic geometry wherein orthogonal hyperbolic sensation dimensions correspond with independent Euclidean stimulus dimensions.

In summary we conclude that the assumption of a Euclidean stimulus geometry implies the sensation geometry to be hyperbolic. That Euclidean stimuli define the sensation space to be hyperbolic follows from the inverse of the Fechner-Helson psychophysical function that specifies a Euclidean stimulus space to be described by exponentially transformed sensation dimensions, which exponential co-ordinate terms define a hyperbolic sensation surface. Its space curvature is minus unity and, thus, needs no scaling to a unit (pseudo-)radius for the application of the hyperbolic trigonometric functions. Weights that scale sensation dimensions by twice the inverse of its dimensional adaptation points  $a_k = \ln(b_k)$ , define the space adaptation point as origin for intensity-comparable sensation dimensions  $2(y_{ik}/a_k - 1)$ . The comparability is due to individual weights that standardise the units for sensation differences from the adaptation point as individually meaningful origin for the hyperbolic space of their comparable sensations. It also will be noticed that the exponential transformation of the hyperbolic space of comparable sensations specifies a power-raised Euclidean space of subjective stimulus fractions  $(x/b)T^k = \exp[2(Y_{ik}/a_k - 1)J]$ , where power exponents  $T_k = 2/a_k = 2/\ln(b_k)$  are rotational parameters as determined by dimensional projections of the adaptation point in the hyperbolic Fechner-sensation space.

### 3.2.3. Hyperbolic surfaces in terms of Euclidean co-ordinates

For the understanding of the above results and several matters in next chapters by readers with little knowledge of non-Euclidean geometry it might be helpful to discuss the nature of the hyperbolic geometry. Similarly to a three-dimensional Euclidean description of the two-dimensional surface of a sphere, we can describe a hyperbolic surface by three Euclidean dimensions. Taking a hyperbolic sensation surface that corresponds to a Euclidean stimulus plane, we notice that sensations of stimuli  $x/b$  and  $b/x$  are reflected sensations with respect to  $x/b = 1$ . Since  $\ln(1) = 0$ , it are oppositely signed sensations on a curve through the zero origin on a hyperbolic sensation surface. Revolutions of a hyperbolic sensation curve around its zero origin (here around the

zero-valued adaptation point  $\ln(x/b) = y - a = 0$  in the hyperbolic Fechner-Helson space of sensations) define the **surface** of one of the sheets from a so-called two-sheeted hyperboloid of revolution. The two sheets are identical and each can be viewed as a pseudo-hemisphere in the same way as two reflected hemispheres of a sphere. We illustrate this by figure 20 below, where three Euclidean co-ordinates (X, Y, Z) describe the surfaces of two partial sheets of a hyperboloid of revolution.

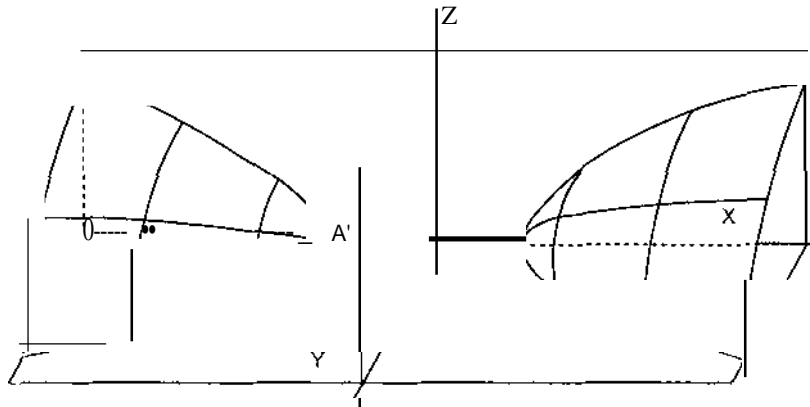

Figure 20. The partial sensation surface as sheets of a two-sheeted hyperboloid

Similar to the equation  $x^2/a^2 + y^2/b^2 + z^2/c^2 = 1$  for a sphere with unit radius, three Euclidean co-ordinates X, Y, and Z describe by equation  $x^2/a^2 - y^2/b^2 - z^2/c^2 = 1$  the two hyperbolic surfaces with unit pseudo-radius that are defined by the positive and negative solutions for values of x. The curved surfaces in figure 20 are formed by partial revolutions of two opposite, hyperbolic curves that are related to a rotated vector in the positive orthant of the pictured YZ-plane. The YZ-plane can be viewed as a positively valued stimulus plane, where from the two equivalent hyperbolic surfaces are derived. The two pictured hyperbolic surfaces are defined by the negative and positive solution of the x values on the Euclidean co-ordinate X and the positive co-ordinates Y and Z. The points A and A' in figure 20 represent the adaptation point on each of the hyperbolic sensation surfaces and are also defined by the intersection of all asymptotes to the opposite hyperbolic surfaces. Corresponding centre point 0 represents the adaptation point in the stimulus space. The constant of unity in  $x^2/a^2 - y^2/b^2 - z^2/c^2 = 1$  is the pseudo-radius  $p = 1$  of the hyperboloid, in analogy to the radius of spheres, and derives from the nonnormalised distance between OA and OA' by the dimensional weights of values x, y, and z on dimensions X, Y and Z. Multiplying the dimensions by factor a will change the pseudo-radius to  $p = a$  and scales the distances on the hyperbolic surface by that factor a. By defining  $bla = r$ , and  $cia = q$  the equation becomes written in its general form  $-x^2 + y^2/r^2 + z^2/q^2 = -p^2$ , where the negative square of the radius determines the peculiar nature of the hyperbolic geometry, that has troubled the discovery of non-Euclidean geometry (Gray, 1979). The distance between origin 0 and the intersections of the X-axis with the hyperbolic surfaces as points A and A' defines the pseudo-radius  $-p^2$  of hyperbolic surfaces. Since the pseudo-radius determines the scale of the surface, we may correct the scale by the curvature  $-c = lip$  in order to

restore the surface scale to surfaces with a pseudo-radius of 1. The equation for the scaled surface then writes as  $\zeta^2(x^2 - y^2/r^2 - z^2/q^2) = 1$ , where the positive and negative solutions of its quadratic terms yield the two hyperbolic surfaces with unit curvature. Distances between points on a hyperbolic surface with unit pseudo-radius are described by the curved line length between two points on the surface, just as distances on a sphere are described by the arc length between points on a sphere with unit radius. For a hemisphere these distances are expressed by the cosines of the angles between the lines from the sphere centre to two points on its hemisphere and for hyperbolic surfaces as the hyperbolic cosine of the angles between the lines from centre  $O$  to two points on the hyperbolic surface. The hyperbolic cosine corresponds to the distance between the projection of the two surface points on axis  $X$ , provided that the surface scale is defined by distance  $OA = OA' = 1$ . The origin is the midpoint of surface intersection points  $A$  or  $A'$  with axis  $X$ , while the intersection point of all asymptotes to hyperbolic surfaces defines  $A$  or  $A'$  on the opposite surface. The larger the pseudo-radius the smaller the hyperbolic curvature of the surface is and if the pseudo-radius approaches infinity then the surface approaches the flatness of a Euclidean plane with curvature  $\zeta = -1/\infty = 0$ .

Each curved surface of figure 20 represents a hyperbolic sensation surface that, as shown in section 3.2.2., is derived from a Euclidean stimulus plane by the Fechner-Helson psychophysical function. Here plane  $YZ$  is a stimulus plane that corresponds to the hyperbolic surface as two-dimensional sensation space. The central  $X$ -axis is only needed in order to describe a two-dimensional, hyperbolically curved surface by three Euclidean co-ordinates. Origin  $O$  is the adaptation point on the  $YZ$ -plane of stimuli. The intersection of the central  $X$ -axis and the hyperbolic surface represents the adaptation point on the sensation surface. Since different individuals may have differently located adaptation points, the hyperbolic sensation surfaces of different individuals may represent different sensations, because if individuals have different adaptation points then this is represented by individually different projections of stimulus plane  $YZ$  from different projection perspective points  $O$  as different stimulus adaptation points to different hyperbolic sensation surfaces with different adaptation points  $A$  or  $A'$ . Thus, if the stimulus space is Euclidean and Fechner-Helson psychophysics apply then the assumption of the existence of a common Euclidean sensation space is incorrect, because we have shown in section 3.2.2. that a Euclidean stimulus plane corresponds to an individually translated hyperbolic sensation surface with distance  $OA = |p| = 1$  or curvature  $\zeta = -1$ . One can't describe stimuli and sensations by the same geometry and also apply Fechnerian psychophysics, while applications of the Fechner-Helson function may define hyperbolic sensations for the same stimuli to be different for different individuals, because individuals may have different adaptation points. Different adaptation points also imply different comparability weights for sensation dimensions, whereby hyperbolic sensation distances are defined by products of dimensional distance terms  $\cosh [2(y'_{ik} - y'_{jk})/a_{jk}]$ . Therefore, the dissimilarity between the same Euclidean stimuli may correspond to individually different hyperbolic sensation distances.

Notice that figure 20 could also represent the reverse of a flat sensation plane (with a Minkowski  $r$ -metric or, if  $r = 2$ , with a Euclidean metric) and a hyperbolic stimulus surface. As shown in subsection 3.2.1., if the exponential transformation, as

inverse function of the Fechner-Helson function, transforms a flat (Euclidean or Minkowskian) sensation space to a stimulus space then the stimulus space can be hyperbolic, where then the curvature depends on the Minkowski  $r$ -metric of the sensation space by  $\zeta_r = -r/2$ , while a hyperbolic space is rotation invariant and a Minkowskian space not (except for  $r = 2$ ). It also is demonstrated in section 3.2.1. that an elliptic stimulus geometry can apply, if the sensation space is Minkowskian. Elliptic geometry needs no further illustration, due to the familiarity of the spherical surface of the globe as elliptic geometry. Some other aspects of non-Euclidean geometry may be helpful for the understanding of matters discussed in the following chapters. The triangular distance inequality (the sum of two sides is larger than the other side) also holds for triangles on surfaces with an elliptic or hyperbolic geometry, whereby transitive dissimilarity orders could also be represented by the transitive distances of non-Euclidean spaces. The sum of the angles for elliptic triangles are larger and for hyperbolic triangles smaller than  $180^\circ$ , while in both geometries the lengths of the curved triangle sides are determined by their opposite angles and the space curvature. Other differences from Euclidean geometry are also relevant. The elliptic geometries of spheres and hemispheres describe finite surfaces that have no parallels. In order to distinguish the difference in finiteness between spheres and hemispheres, the geometry of spheres is characterised by the so-called double-elliptic geometry (limited by the opposite polar points) and the geometry of hemispheres by the so-called single-elliptic geometry (limited by its equator). Hyperbolic geometry describes infinite surfaces and has parallels that have only one asymptotically common infinity point. Hyperbolic parallels are thus 'diverging' from one infinity direction. A hyperbolic line orthogonal to all diverging parallels from some infinity is a circle, while its circle radius is infinite by the infinite origin of its orthogonal parallels. It is called a horocycle, because a circle segment on a circle with an infinite radius becomes a straight line segment, but its infinitely extended straight line segment still is a circle on the hyperbolic surface. The revolution of a horocycle in a three-dimensional hyperbolic space is a two-dimensional surface that has a common infinity for all parallels that are perpendicular to its surface and similarly is called a horosphere. The noticeable aspect is that the hyperbolic subspace of a horosphere exhibits the Euclidean geometry by the infinite radius of the horosphere. Hyperbolic geometry is the most general geometry, because it contains (hyper-)horospheres as subspaces with a Euclidean geometry, while a Euclidean space contains a subspace with an elliptic geometry by revolutions of circles. Elliptic geometry contains no hyperbolic or Euclidean subspace.

### 3.3. Stevens' psychophysics and Bower's stimulus coding theory

Up to now we discussed the geometries for stimulus and sensation spaces under the assumption that the Fechner-Helson psychophysical function applies. It might be questioned whether the power function of Stevens' psychophysics (1957, 1960, 1961, 1975) yield rotation and translation invariant geometries for the stimulus or sensation space, if one space is flat. A transformation by Stevens' power functions of a Euclidean or non-Euclidean stimulus space to a subjective stimulus magnitude space defines a so-called Finsler geometry with dimensionally varying space curvatures, where then here

the dimensional space curvature would vary with the power exponent of the space dimensions. However, without further restrictions such Finsler spaces are not rotation- and translation invariant spaces, in contrast to non-Euclidean or Euclidean spaces. It yields a strong theoretical argument for the earlier discussed conjecture (section 2.1) that Stevens' power function derives from a stimulus-space representation of comparable sensations as weighted sensations that equal cognitive magnitude sensations both with respect to adaptation level, whereby a Finsler space of subjective stimulus magnitudes is defined by the exponential transformation of the flat or hyperbolic space of comparably weighted Fechner-Helson sensations. In the next subsection we demonstrate this in more detail, where we also show that dimensional power exponents  $\tau_k$  of Stevens' power-raised stimuli are required to be rotational parameters. This requirement follows from the derived power exponent  $\tau_k = 2/\ln(b_k/u_k)$  in section 2.1.2., because  $b_k$  are dimensional projection values of the adaptation space point in a Euclidean or non-Euclidean stimulus space with the threshold stimulus as unit point. It yields a verifiable condition for the conjecture that Stevens' power law derives from matching of weighted Fechner-Helson sensations with cognitive magnitude sensations. These theoretical and verifiable grounds support the earlier argument presented in section 2.1., where Stevens' power exponents are described as the result from matching with cognitive magnitude sensations.

### 3.3.1. Stevens' psychophysics and Euclidean stimulus spaces

In the next mathematical part of this section we prove that if a) the stimulus space is Euclidean, b) Stevens' power function transforms stimuli to subjective stimulus magnitudes, and c) subjective stimulus magnitude spaces correspond to a rotation-invariant space, then the subjective stimulus magnitude space can only be an exponential transformation of a weighted hyperbolic Fechner sensation space. It requires that Stevens' power exponents equal the rotational weight parameters of the hyperbolic space of comparable sensations, which is satisfied for weights as function of projection values of a space point on rotated dimensions of the underlying Euclidean stimulus. Nothing in Stevens' theory of unidimensional psychophysics tells us that this rotational condition for power exponents must hold, while multidimensional psychophysics that confirm or disprove this restriction seems to be absent. If it holds, it asks for a theoretical explanation that is given by Stevens' power function as based on matching of sensory and magnitude sensations, because then Stevens' power function derives from Fechner-Helson psychophysics and the stimulus coding theory of Bower (1971). Magnitude matching of sensations asks for a meaningful origin for dimensional differences from that origin that are matched with cognitive magnitude-sensation differences by dimensional weights. As theorised by Bower that meaningful origin is the individual space adaptation point and that comparability of sensations is obtained by an equivalence weighing of dimensional sensation differences to that origin. Stevens' method of stimulus magnitude estimation then can be seen as derived from the underlying matching of weighted sensations for a modality with cognitive magnitude sensations that derive from a learned generalisation of length and distance sensations to magnitude sensations with a power exponent of unity for the associated numerical magnitudes, where twice the inverse of the adaptation level specifies the sensation weight for the magnitude matching and equals Stevens' power exponent, as

argued in section 2.1.2. The power exponents that correspond to the weights of Fechner-Helson sensations define the rotation restriction for the power exponents to be satisfied, because defined by projection values of a space point in a rotation-invariant space. The conjecture that magnitude scaling by Stevens's fractionation procedure underlies a matching between sensations of stimulus modalities and cognitive magnitude sensations only holds if the dimensional power exponents of Stevens' subjective stimulus-magnitude space are rotational parameters. In accordance with the stimulus-coding assumptions by Bower (1971) a magnitude-comparable weighing of sensation dimensions is achieved by our weights that equal twice the inverse value of the dimensional distance between the just noticeable and adaptation points in the Fechner sensation space. The comparably weighted Fechner space has the just noticeable sensation as origin, while the dimensional adaptation points are individually scaled to dimensional values of 2. If we also translate the individually weighted Fechner space to the individually defined adaptation space points, we obtain a Bower space of intensity-comparable sensations that are invariant under linear transformation of the underlying Fechner sensation scales.

We may specify four differently defined (hyperbolic or flat) sensation spaces. Firstly, we already defined *the Fechner space* as the logarithmically transformed space of stimulus intensities. *The Fechner space is a space with dimensionally just-noticeable sensations as space origin and undefined, non-comparable sensation scale units.* Secondly, here we define the comparably weighted Fechner space as a *Stevens space* that corresponds to a logarithmic transformation of the power-raised stimulus space of subjective stimulus magnitudes, whereby dimensional sensation weights equal the dimensional power exponents as twice the inverse values of individual sensation-dimension distances between the just noticeable and adaptation points, due to an underlying matching with magnitude sensations. Thus, *the Stevens sensation space is a space with the dimensionally just noticeable sensations as space origin and individually comparable sensation scale units.* Thirdly, we have the already defined *Fechner-Helson space* as the logarithmically transformed stimulus fraction space to a distinctly translated Fechner space with  $\ln(x/kfbk) = y_{ik} - a_k = 0$  as meaningful dimension origins at individual adaptation points  $Y_{ik} :: a_k$ . *The Fechner-Helson space is a space with individually meaningful space origins and arbitrary sensation scale units.* Lastly, the *Bower space* is defined as an individually translated and weighted Fechner space or an individually weighted Fechner-Helson space or an individually translated Stevens space. Comparability of weighted sensation differences from the adaptation level is originally hypothesised by Bower (1971) in his stimulus coding theory and, therefore, their space is called here the Bower sensation space, The Bower space is individually translated to the adaptation point in the Fechner sensation space, while the Bower space also weighs the Fechner sensation dimensions by twice the inverse values of the dimensional adaptation points in the Fechner space. *The Bower sensation space is a space with individually meaningful space origins and individually comparable sensation scale units.*

The Bower and Stevens sensation spaces have a weighing of sensation dimensions with weights that equal twice the inverse values of the projected adaptation points on its sensation dimensions. In the next mathematical section, we also prove that



power exponents of Stevens must be rotational parameters, which is satisfied if defined by projections of a space point on sensation dimensions of a rotation-invariant Stevens sensation space of a Euclidean stimulus space. Since the only meaningful weights for the comparability of sensation dimensions are given by their weighing to equal dimensional distances between just-noticeable and adaptation points, we argue the ratio of Stevens' power exponents in cross-modality matching must become proportional to the inverse ratios of the adaptation point values for the modalities in the Fechner space. According to Bower's (1971) stimulus coding theory, matching of modalities imply an individual weighing of sensations to equivalence of sensation differences from the adaptation point. Based on our further analysis of Teghtsoonian's analysis results (discussed in subsection 2.1.2.) we described cross-modality matching of modalities  $k$  and  $h$  by sensations  $s_{ik} = 2(Y_{ik} - a_k)/a_k$  and  $s_{ih} = 2(Y_{ih} - a_h)/a_h$  that have equally weighted sensation differences from their dimensional adaptation levels  $a_k$  and  $a_h$ . Expressed in stimulus terms  $\exp(s.k) = (x.k/b_k)^{\tau_k}$  and  $\exp(s.h) = (x.h/b_h)^{\tau_h}$  that cross-modality matching is specified by

$$x_{ih}b_h = (x_{ik}/b_k)^{\tau_k/\tau_h} \quad \text{with} \quad \tau_k/\tau_h = a_h/a_k$$

Taking subjective magnitudes of stimulus modality  $k$  as based on the matching with magnitude sensations as dimension  $h$  then sensation dimension  $h$  equals generalised distance and length sensations with a power exponent  $\tau_h = 2/a_h = 1$  for their subjective magnitudes, as derived from our further analysis of Teghtsoonian's results in subsection 2.1.2. Thereby, the subjective stimulus magnitudes of modality  $k$  are defined by power exponent  $\tau_k = 2/a_k$  of power-raised stimulus-fraction scales  $(x.k/b_k)^{\tau_k}$ , where  $a_k = \ln(b_k/u_k)$  is the dimensional adaptation point in the Fechner sensation space with dimensional origins  $\ln(u_k/\mu_k) = 0$ . It is indeed hard to imagine how cross-modality matching and subjective stimulus magnitudes can yield consistent results if it would not be based on a cognitive process that enables a magnitude comparability of weighted dimensional sensation differences from a common reference point.

Stevens' power exponents  $\tau_k$  of subjective stimulus-magnitude dimensions are only compatible with a Euclidean stimulus space, if dimensional power exponents correspond to projection values of a space point in a hyperbolic sensation space. We demonstrate this in more detail in the next mathematical section, where it is shown that if the stimulus space is Euclidean then the exponential transformation of a hyperbolic space of comparably weighted Fechner sensations defines a power-raised Euclidean stimulus space. It defines a Finsler geometry for the space of Stevens' subjective stimulus magnitudes with curvatures that depend on rotational parameters as dimensional power exponents. Thereby, the Finsler space of subjective stimulus magnitudes only has direction-dependent curvatures for rotated dimensions with respect to the stimulus adaptation point as rotation centre and unit stimulus space point. Thus, the controversy between Fechner's and Stevens' psychophysical laws (Stevens, 1961) is resolved by taking comparable sensations as comparably weighted vectors in a hyperbolic sensation space with the adaptation point as origin and by taking subjective stimulus magnitudes as power-raised stimulus vectors of Euclidean stimulus space (as discussed in the next subsection the same holds reversely for flat sensation spaces and non-Euclidean stimulus spaces). Thereby, Fechnerian and Stevens' psychophysics

express the same in different geometries, because a hyperbolic Fechner sensation space is defined by the logarithmic transformation of a Euclidean stimulus space (and a flat Fechner sensation space by the logarithmic transformation of a non-Euclidean stimulus space), whereby also the weights of the comparably weighted sensation space define the power exponents that equal twice the inverse of the adaptation point values in the not-weighted Fechner space. For Stevens' fractionation method, applied to random stimuli and constant reference stimuli, the assumption of individually identical power exponents as common weights defined by identical adaptation points holds, due to identical adaptation points from the exposure to the same set of stimuli with the same target stimuli for the reference magnitudes. The adaptation to average of randomly presented perceptual stimuli and a repeated stimulus or stimulus pair with assigned metric magnitude as reference level(s) for the cognitive magnitude sensations will induce the same adaptation point for all individuals. Hence, under these conditions individually identical Stevens' power exponents arise from modality matching with cognitive magnitude sensations in the magnitude scaling procedure of Stevens. Generally Stevens used randomly selected stimuli from a fixed set with constant reference stimuli of an assigned magnitude and also used the average of magnitude judgments often persons for the scaling. Although rather constant power exponents are then derived, it has been shown that selective stimulus presentations cause consistent deviations from a constant Stevens' power exponent (Corso, 1971), while we earlier discussed in section 2.1.2. the variability of intra-modal power exponents from varying stimulus-intensity ranges.

If Stevens' power function  $s_i = (x_i/\mu)^\tau$  is the psychophysical function for Euclidean stimuli  $x_i/\mu$ , where  $\mu$  is an arbitrary scale factor for the ratio scale of stimuli, then we look for a function  $f$  that satisfies

$$f(y_i + \beta) = x_i/\mu \quad (48a)$$

$$f((y_i + \beta)/\alpha) = (x_i/\mu)^\tau \quad \{ \text{Xi Euclidean} (48b) \}$$

where if such a function  $f$  exists, it may determine a rotation- and translation geometry of  $y_i$ , if function  $f$  specifies a geometric mapping onto a space with constant curvature.

Function  $f = \exp$  for  $\exp[(y_i + g)/\alpha] = (X_i/\mu)^\tau$  is the only function that fits (48b), where  $\alpha = 1/\tau$ ,  $y_i = \ln(x_i)$ , and  $\beta = -\ln(\mu)$ . As shown in section 3.2.2., a Euclidean stimulus space is an exponential transformation of a hyperbolic sensation space. Thereby,  $f = \exp$  only can transform a hyperbolic sensation space to a Euclidean stimulus space, whereby the Stevens' subjective stimulus magnitudes are defined by the exponential transformation a weighted hyperbolic sensation space that indeed is rotation- and translation-invariant. Function  $f$  as exponential function is the inverse Fechner function for weighted sensations. Therefore, a similar Euclidean co-ordinate system  $v_k$ ,  $v_l$  and  $v_m$  as in (46a) applies to weighted hyperbolic sensations  $t.y.$  with its hyperbolic sensation dimensions  $1/y_{ik}$  and  $1/y_{il}$  with asymptotic Euclidean co-ordinates, which by a rotation, as defined for (46b), yields the hyperbolic Pythagorean expression with  $\alpha = 1/\tau$ ,  $U_k = 1/\tau_k$  and  $\alpha_l = 1/\tau_l$ , written as

$$\text{COSh}[Y_{i1}^{11}] \text{CoSh}[Y_{ik}^{k1}] = \cosh[Y_{i1}^1] \quad (49a)$$

This is the Pythagorean expression of weighted hyperbolic Fechner spaces for a Euclidean stimulus space, where a hyperbolic space that derives from a Euclidean space has a curvature of unity. If stimuli are Euclidean and sensations hyperbolic, then the controversy between Fechner's and Stevens' psychophysical function is resolved, provided that sensation weights are individually identical. However, the validity of (49a) as a rotationally invariant space requires a rather strong restriction on the admissible power exponents  $\tau_1$  and  $\tau_k$ . It requires that the dimensional power exponents are rotational parameters of some specific projected space point (in the same way as  $a_k$  and  $a_1$  are dimensional projections of the space adaptation point) that for identical power exponents should be the same point for all individuals. Nothing in Stevens' psychophysics urges its power exponents to satisfy this rotation condition, while any empirical evidence is lacking due to lack of relevant multidimensional psychophysics. However, if Stevens' power function is not the psychophysical function, but a Fechner-Helson-Bower based matching function of perceptual sensations with cognitive sensations of magnitude then the rotation condition is satisfied by  $\tau = 2/a$ , as derived in section 2.1.2. If power exponents are projection parameters of a space point, then we may translate vectors  $Y_{ik}$  to point  $1/a$ . We see that (49a) then yields a hyperbolic Pythagorean expression that mathematically is identical to the weighted Fechner-Helson space of (47d2), because for  $\tau = 1$  and  $2/a = \tau$  it is also written as

$$\cosh[y_{i1}^{\tau_1} - 2] \cdot \cosh[y_{ik}^{\tau_k} - 2] = \cosh[y_i^{\tau} - 2] \quad (49b)$$

But nothing in Stevens' psychophysics says that power exponents should satisfy the rotation condition as the dimensional parameters of a point. However, if Stevens' power function derives from a Bower-based matching function of perceptual sensations with cognitive sensations of magnitude (as argued in chapter 2,1.2) then the rotation condition is satisfied by the identity of (49b) and (47d2) as given by  $\tau = 2/a$ ,

Cross-modality matching of modalities  $k$  and  $l$  in the hyperbolic space of intensity-comparable sensations yields equivalence

$$\text{COSh}[2(Y_{ik}/a_k - 1)] = \cosh[2(Y_{il}/a_l - 1)] \quad (\text{SOa1})$$

and thus of  $y_{ik}^1/a_k = Y_{il}/a_l$  or by the inverse of Fechner's function

$$\text{or} \quad (x_{ik}/b_k)^{2/a_k} = (x_{il}/b_l)^{2/a_l} \quad (\text{SOa2})$$

$$x_{ik}^1/a_k = x_{il}^1/a_l \quad (\text{SOa3})$$

A power exponent  $a_k/a_l$  follows thus from cross-modality matching that is based on Bower's stimulus coding theory (Bower, 1971) and the Fechner-Helson psychophysical function.

According to Stevens' psychophysics in the direct or fractionation scaling one relates a metric magnitude scale  $n_i$  to stimuli  $x_{ik}$  or  $X_{i1}$  by

$$(x_{ik}/\mu_k)^{\tau_k} = n_i \quad (x_{i1}/\mu_1)^{\tau_1} = n_i \quad (SOb1)$$

This magnitude equivalence also yields a power function for cross-modality matching with the ratio  $\tau_1/\tau_k$  as power exponent for

$$(x_{ik}/\mu_k) = (x_{i1}/\mu_1)^{\tau_1/\tau_k} \quad (50b2)$$

Stevens (1959, p. 207) verified matching power exponents to be the ratio of separately determined power exponents  $\tau_1$  and  $\tau_k$  from independent fractionation scaling of  $k$  and  $1$ .

Let  $\ln(n_i/b_k) = a_k$  be a cognitive sensation of generalised magnitude (as in section 2.1.1. for metric scale  $n$  and its sensation scale as cognitive magnitude  $q$ ) for the matching of sensation modality  $k$  with cognitive magnitude sensation. Here  $b_k$  is the adaptation stimulus with  $a_k = \ln(b_k)$  as adaptation point for sensation modality  $k$ , while the assigned, metric reference magnitude  $b_n$  defines  $a_n = \ln(b_n)$  as cognitive reference magnitude. The matching of perceptual sensations  $y_{ik}$  with sensations of cognitive magnitude  $q$ , with reference magnitude  $a_n$  means by (SOa2) and (SOa3) that

$$(x_{ik}/\mu_k)^{a_k} = n_i \quad (SOc1)$$

and by (SOb1)

$$(x_{ik}/\mu_k)^{\tau_k} = n_i \quad (SOc2)$$

Since  $\mu_k$  usually is an arbitrary scale unit, we should actually express (SOc1) and (SOc2) in terms of unit-invariant fraction scales with respect to reference magnitude  $b_n$  and reference stimulus  $b_k$  as

$$(x_{ik}/b_k)^{\tau_k} = n_i/b_n \quad (SOc3)$$

and derive that the unit-correction factor  $\alpha_k$  in Stevens' magnitude scaling depends on  $b_n = \exp(a_n)$ ,  $b_k = \exp(a_k)$ , and  $\mu_k$  by

$$\alpha_k = [(\mu_k/b_k)^{\tau_k}]/b_n \quad \text{with} \quad \tau_k = a_k/a_n \quad (SOc4)$$

Provided that individuals have same adaptation points, power exponent  $\tau_k$  of modality  $k$  is identical for each individual. Since adaptation to perceptual stimuli occurs in relatively very short time the adaptation points are likely not stable, but we define  $a_k = \ln(b_k/\mu_k)$  for  $u_k/\mu_k$  as the just noticeable level of perception. However, a more or less constant interval between  $b_k/\mu_k$  and  $u_k/\mu_k$  for each modality must hold, where  $u_k/\mu_k$  then depends on  $b_k/\mu_k$  and  $u_k/\mu_k$  equals not Fechner's absolute just noticeable level, because magnitude scaling yields a more or less constant power exponent, although the interval may be varying somewhat for different individuals. It guarantees that adaptation points  $a_k$  are identical for the average of individuals, provided that stimuli are randomly presented with permanent anchor stimuli of sets of stimuli with

similar or **symmetrically** varying intensity ranges. The relationship between adaptation levels in (47d2) and power exponents in (49b) is given by  $a_q^{-2}$  as  $\tau_k = 2/a_k$ , according to section 2.1.2

$$\tau_k = 2/a_k, \quad \tau_1 = 2/a_1, \quad \tau = 2/a \quad (\text{SacS})$$

The Bower space is a translated and weighted Fechner space, where the Stevens space is only weighted by power parameters as proportional to the inverse values of adaptation point parameters in the Fechner space. The Stevens space is a weighted Fechner space and both have their origin at the just noticeable point  $\ln(x/J-1) = 0$  of an arbitrary ratio scale value of stimulus intensity, while the sensation space representation of the stimulus space origin is a negative infinity  $\ln(x=0) = -\infty$ . No other infinity corresponds to the origin of the semi-positive stimulus space. From that *unique* infinity all sensation vectors as logarithmic stimulus vectors must originate (as if it concerns a hyperbolic sensation space with a translated origin towards that infinity). Sensation vectors originating from that **common** negative infinity in a hyperbolic space are hyperbolic parallels. As weighted sensation vectors they share that infinity as circle centre of adaptation points that have equal values of  $2a_k/a_k = 2$  on these weighted sensation parallels. Thus, it is a so-called horocycle of equal-valued points with its centre at infinity, whereby the sensation vectors become orthogonal to the horocycle of adaptation points.

In order to **understand** the nature of hyperbolic spaces we remark that parallels in hyperbolic spaces only have one common infinity, in contrast to Euclidean spaces with opposite infinities of parallels or in contrast to elliptic spaces that have no parallels. Moreover, hyperbolic triangles have sums of angles  $\leq 180^\circ$  that determine also the area of its triangles. Therefore, the curve of orthogonal projections for the space adaptation point on two sensation parallels originating from a **common** infinity constitute a limiting triangle with  $180^\circ$  for the sum of its angles and an infinite area, defined by its two  $90^\circ$  angles between the projection horocycle and the sensation parallels that have  $0^\circ$  angles, but still are diverging from their **common** infinity onwards.

In the Euclidean stimulus fraction plane of  $x/b$  vectorial adaptation points are located on the unit circle that corresponds the horocycle of projected adaptation points on the parallel sensation vectors that share the infinity of the stimulus origin in the hyperbolic sensation space. In a stimulus fraction space with origin  $x/b = 0$  the angle  $x_{kn}$  between some stimulus vector  $k$  and the quasi-stimulus vector  $n$  for cognitive magnitude, defined by  $n/b = \exp\{q_i - a_i\}$  for cognitive magnitude  $q_i$ , equals angle  $x_{kn}$  in the hyperbolic Fechner space of  $y_i = \ln(x_i/b_i)$  and  $q_i$ . Angle  $x_{kn}$  is related to distance  $d_{kq}$  between adaptation points  $k$  and  $q$  of sensation parallels  $k$  and  $q$  on the horocycle of projected adaptation points in the  $-\infty$  to infinity  $\ln(x=0)$  - translated Fechner space. As is illustrated in figure 21 below, the hyperbolic distance  $d_{kq}$  is firstly defined by the so-called parallel angle (Busemann, 1950a) for hyperbolic parallels by  $\tan(\frac{1}{2}x_{kn}) = \exp(-d_{kq})$ . Secondly the angle  $x_{kq}$  is related to

the parallel angle and thus to distance  $d_{kq}$  by a prism that is formed by three parallels (Gray, 1979, p.103-105). The vectors  $a_k = OK$  and  $a_q = OQ$  with origin 0 for  $\ln(x=1) = 0$  become in the translated (towards the negative infinity of the stimulus space origin) and not-weighted Fechner space the hyperbolic parallels  $k$  and  $q$  in figure 21, where parallel 0 contains the original Fechner space origin  $o$ .

$k, q,$  and  $0$  hyperbolic parallels  
 Triangle  $KO'Q$  on horosphere  
 Triangle  $KOQ$  on hyperbolic Fechner plane  
 $0, q,$  and  $Q, O',$  and  $O,$  and  $\beta_{kq}$  fixed  
 $k, K, a_k'$  and  $d_{kq}$  variable

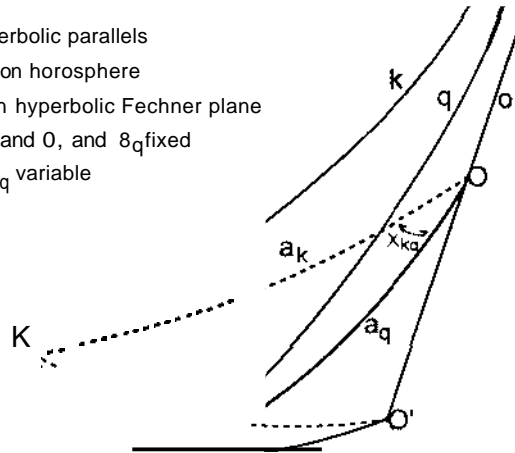

Figure 21. Hyperbolic sensation parallels in the Fechner space

The pairs of parallels  $(q,o)$ ,  $(o,k)$  and  $(q,k)$  constitute the sides of a prism and where the adaptation points  $K$  and  $Q$  on the parallels define the horocycle segment  $KQ = d_{kq}$  on the horosphere for the triangle  $KQO'$ . The parallels  $q$  and  $k$  have adaptation points  $Q$  and  $K$  on the horocycle and point  $0$  on parallel  $0$  is the original origin  $\ln(x=1) = 0$  of the Fechner sensation space. Hyperbolic triangle  $OQK$  has hyperbolic sides of lengths  $OQ = a_q$ ,  $OK = a_k$ , and horocycle segment  $QK = d_{kq}$  and angle  $QOK = x_{kq}$ . For fixed parallels  $q$  and  $0$  and fixed point  $0$ , length  $OQ = a_q$  is constant and an increased length  $OK = a_k$ , as the figure demonstrates clearly, corresponds with an enlargement of length  $d_{kq}$  of horocycle segment  $QK$  and thus decreases the parallel angle  $\beta_{kq}$  and also increases angle  $x_{kq}$  between original hyperbolic vectors  $OQ$  and  $OK$  in the Fechner space  $kq$  with origin  $o$ . It follows by  $t_k = a_k / a_q$  for modality  $k$  and cognitive magnitude  $q$  that the power exponent  $t_k$  is the smaller the larger the angle  $x_{kq}$  between sensation vectors of magnitude and modality  $k$  is.

We conclude that in the Stevens space different distances on sensation vectors become comparable by standardised sensations scales that are weighted by twice the inverse of the dimensional adaptation point values in the Fechner space. The weighted Fechner-Helson space of (47d2) and the translated Stevens space of (49b), both with space adaptation point as origin, then are identical spaces for comparable sensation differences with respect to the adaptation point. In accordance with Bower (1971), modality matching concerns the equivalence weighing to

comparable sensation differences of modalities with respect to their adaptation points, as discussed in section 2.1. Therefore, the weighted hyperbolic Fechner-Helson spaces, defined in (47d2) or in (49b), are hyperbolic Bower spaces of comparable sensations.

Stevens' power exponents must be regarded as matching parameters for matching of perceptual sensations with cognitive magnitude sensations, due to following reasons:

1) *The methodological reason*

The power exponents of Stevens' function are obtained by Stevens' fractionation method, which asks for certain cognitive operations for the fraction comparisons. It can be seen as a matching of sensations for a modality with cognitive magnitude sensations as generalised sensations of lengths and distances. As already discussed in section 2.1. and in the mathematical section here above, a power function of stimuli for subjective stimulus magnitudes derives from the weighted Fechner-Helson psychophysical function, whereby dimensional sensations are matched with cognitive magnitude sensations by weights that standardise distance  $a_k = \ln(b_k f_{u_k})$  between the dimensional adaptation and just noticeable level to distance  $2 \cdot \ln(b_k f_{u_k}) / a_k = 2$  on magnitude-evaluated sensation dimensions and whereby the dimensional sensation weight equals Stevens' power exponent  $\tau_k = 2/a_k$ .

2) *The theoretical reason*

If the stimulus and sensation spaces are rotation invariant spaces, then Stevens' power exponents of the power-raised stimulus-fraction space for subjective stimulus magnitudes must be rotational parameters as function of the projection values of the space adaptation point on rotated Fechner space dimensions, as shown in the above mathematical section. Stevens' psychophysics imply not that his power exponents are rotational parameters of a meaningful space point, but Bower' (1971) stimulus coding theory and the Fechner-Helson psychophysical function define that space point as the adaptation point, while Teghtsoonian's relationship between range and power exponent with the adaptation point as sensation range midpoint defines that Stevens' power exponents equal twice the inverse of the value of dimensional adaptation points. Constant power exponents for modalities can occur if adaptation points are fixed, which is guaranteed by random presentation of stimuli from a fixed stimulus set and a constant reference stimulus or stimulus pair with metric values in Stevens' magnitude scaling. For fixed sets of stimuli that are randomly presented the sensory adaptation level is measured by the distance between the just noticeable sensation and the average sensation levels of the stimuli, which distance between logarithmic stimulus values is independent of the scale unit of stimulus scale.

3) *The empirical reasons.*

If stimuli are not randomly presented in Stevens' method of magnitude scaling then variations in power exponents are observed, where these variations are explained by the dependence of power exponents on varying adaptation points (Corso, (971). Moreover, if the power exponents of Stevens derive from the matching of perceptual sensations with magnitude sensations then the power exponents are defined by twice the inverse of the sensation distance between the adaptation and just noticeable levels. Thereby, it follows that the power exponent must be the larger the smaller the sensation distance between the adaptation and just noticeable

levels for a modality is, while then also the sooner the sense organ for that modality will become saturated by increased stimulus intensity and, thus, the stronger its association with magnitude sensations will be. This prediction follows from the analysis of weighted hyperbolic sensation spaces that represent a power-raised Euclidean stimulus space, the hypothesised matching explanation of subjective stimulus magnitude estimation, and the graphically shown analysis in the preceding mathematical subsection. The values of Stevens' power exponents for different modalities confirm these predictions. The hyperbolic sensation dimension of modality  $k$  and the hyperbolic sensation dimension  $q$  for cognitive magnitude are the more correlated the smaller the value of the adaptation level  $a_k$  is on the Fechner sensation dimension  $k$ . Since power exponent  $r_k = 2/a_k$ , it is predicted that the smaller the power parameter  $r_k$  is, the larger the angle between stimulus vectors  $k$  and quasi-stimulus vector for magnitude sensations  $q$  is. According to the overview of the power exponent  $r_k$  for modalities from Stevens (1961), the value  $r_k$  varies for modalities from 0.33 to 3.50. Binaural loudness of 1000-cps tones and brightness for dark-adapted eyes show the lowest power exponents of about 0.33. For 60-cps electroshock intensities at wet finger tips the largest power exponent of 3.50 is reported. It says that the association between sensory sensations and magnitude sensations should be the strongest for electroshock, while small electroshock increases indeed are soon judged as too much. Loudness and brightness would then be the least associated with magnitude sensation and they indeed are only judged as too much at extremely high intensities. The power exponent values thus fit the a priori expectations that are based on geometric analysis and twice the inverse values of the adaptation levels as power exponents. Additionally to the evidence from the analyses of Teghtsoonian, discussed in section 2.1.2, it confirms that Stevens' power exponents are indeed matching parameters of sensations with respect to sensations of cognitive magnitude.

All three arguments imply that Stevens' power function derives from Bower's comparability weighing of Fechner-Helson sensation dimensions. Thus Stevens' claim (Stevens, 1961) that Fechner's law has to be repealed is unjustified. The last reason also indicates that the *stimulus space is Euclidean and the sensation space hyperbolic*, because the geometrically predicted relationship between power exponents of modalities and their association between magnitude sensations follows from the diverging hyperbolic parallels that originate from the negative sensation infinity that corresponds to zero stimulus intensities. This relationship follows not for flat sensation spaces with corresponding non-Euclidean stimulus spaces, although the power-raised spaces of the latter also correspond to weighted flat sensation spaces, as discussed in the following subsection.

### 3.3.2. Stevens' psychophysics *and flat* sensation spaces

As alternative for the above subsection we investigate the nature of a rotation and translation invariant geometry for a stimulus space derived from a sensation space with a Minkowski  $r$ -metric, while the psychophysical power function of Stevens applies. It is mathematically shown in the sequel of this section that if a) the sensation space is Euclidean or Minkowskian, b) Stevens' power function transforms stimulus intensities to subjective stimulus magnitudes, and c) rotation and translation invariance applies to



the stimulus space, then the stimulus space can only be non-Euclidean (hyperbolic or double-elliptic). The curvature of the non-Euclidean stimulus space can be positive, specifying a double-elliptic stimulus space, or negative, specifying a hyperbolic stimulus space, where the absolute curvature is again dependent on the r-metric for the sensation space. Its curvature can't approach zero as approximately Euclidean space, because the r-metric of the sensation space approaches not infinity (evaluations are not determined by the largest dimensional sensations). Stevens' power exponents are also defined by the dimensional projection values of the space adaptation point, but Minkowskian sensation spaces are not rotationally invariant. However, the adaptation point is also a point in the rotation-invariant non-Euclidean stimulus space with the threshold stimulus as unit point, wherein Stevens' power exponents are rotational parameters that are defined by twice the inverse of the logarithmically transformed values of the dimensional adaptation points. Clearly the power-raised **non-Euclidean** stimulus space of subjective stimulus magnitudes is not rotation-invariant, although rotational power exponents transform a rotated, **non-Euclidean** stimulus space to its subjective magnitude space.

Next we investigate the reversed problem: the nature of the geometry for a stimulus space derived from Stevens' power function for a sensation space with a Minkowski r-metric. Here we ask for sensations  $s_i$  with a Minkowski r-metric and  $s_i = (y_i + \beta)/\alpha$  as weighing and translation of  $y_i$  in a Minkowskian space, that a transformation function  $f$  satisfies

$$f\left[\frac{(x_i/\mu)^{\tau}}{\alpha} + \beta\right] = y_i \quad \text{Minkowskian (51a)}$$

where, if possible, function  $f(x_i/\mu)$  should specify a rotation- and translation-invariant stimulus geometry. A rotation invariant geometry for  $x_i$  requires that function  $f$  maps a space with constant curvature on a space with zero curvature. Thus function  $f$  corresponds to an inverse function that transforms a Euclidean (or Minkowskian) sensation space to a non-Euclidean stimulus space. Non-Euclidean stimuli specify by the Fechner-Helson function Minkowskian sensation spaces (section 3.2.1.).

According to (51a)  $f\left[\frac{(x_i/\mu)^{\tau}}{\alpha} + \beta\right] = y_i$ , whereby  $f$  can only be a logarithmic function with  $\beta = -\ln(\mu)$ ,  $\alpha = 1/\tau$ , and  $\ln(x_i) = y_i$ . The logarithmic transformation of a non-Euclidean space defines a flat space, as derived in section 3.2.1. We obtain for  $f$  as logarithmic function of non-Euclidean stimuli and Stevens' magnitude scaling that  $\ln(x_i) = \tau \cdot y_i = \ln(n_i) = g_i$  for metric measurements  $n_i$ . It means the matching of sensation  $y_i$  with cognitive magnitude sensation  $q_i$ . But, due to the arbitrary scale factor of stimuli the equivalence depends on arbitrary origins for  $y_i$  and  $q_i$  and thus constitutes no meaningful matching equivalence, unless we define Stevens' magnitude scaling for stimulus fractions with respect to a distinctly defined unit point. We define for the weighted Fechner-Helson function  $\tau \cdot \ln(x_i/b) = \tau \cdot (y_i - a)$  that is matched with cognitive magnitude sensations  $\ln(n_i/b_n) = (g_i - la_q)$ .

For a sensation space with a r-metric the matching yields equivalences of weighted sensation distances that are comparable to matching in the hyperbolic sensation space. Although here the translated and weighted space distances are defined by the r-metric of the sensation space, the ratio of dimensional adaptation points  $a_i/a_q$  for the magnitude matching with sensations remains the same. Expressed in the terms of non Euclidean stimulus fractions we write for the two dimensions of a vector for power-raised stimuli the corresponding sensations as

$$\begin{aligned} \text{and} \quad & \varepsilon[(X_i/b_i)^{\tau_i}] = T \ln(x_i/b_i) \quad (y_i - a_i)/(a_i/a_q) \\ \text{and} \quad & \varepsilon[(x_{i1}/b_{i1})^{\tau_i}] = T \ln\{x_{i1}/b_{i1}\} \quad (Y_{i1} - a_{i1})/(a_{i1}/a_q) \quad (S1b) \\ & \varepsilon[(x_{ik}/b_{ik})^{\tau_k}] = T \ln\{x_{ik}/b_{ik}\} = (Y_{ik} - a_k)/(a_k/a_q) \end{aligned}$$

So we again have, for  $a = 2$  as the reference sensation for magnitudes  $n_i/b_i$  with  $b_i = \exp(a_i) = \exp(2)$ , that  $\tau_i = 2/a_i$ ,  $\tau_k = 2/a_k$  and  $\tau = 2/a$ , whereby the dimensional power exponents become defined by projections of the adaptation point in the stimulus space as values  $\tau_i = 2/\ln(b_{i1})$ . Here, as in section 3.2.1.,  $E(x) = \ln(x)$  for stimuli with Euclidean of Minkowskian sensations define stimulus spaces to be non-Euclidean. Referring to terms that are defined by (42b) or (43b) and (43c) with  $\cdot$  as double exponential function of non-Euclidean stimulus values, we define the same asymptotic Euclidean co-ordinates for the space of not power-raised stimuli, which space is then scaled by constant curvature parameter  $|\zeta| = r/2$  with  $r$  as the r-metric parameter of a Minkowskian sensation space. Again we define asymptotic Euclidean co-ordinates by terms  $\exp[\pm \zeta \cdot x_i/b_i]$  in case of a hyperbolic stimulus space or for an elliptic stimulus space tangential Euclidean co-ordinates defined by terms  $\exp[\pm i \cdot \zeta \cdot x_i]$ , which after a 45° rotation (and a translation to the centre in case of a sphere) define the usual co-ordinates that are defined by hyperbolic cosine and sine terms or cosine and sine terms of hyperbolic or elliptic spaces, as in (40a) or (44a), for stimuli  $x_i/\mu$  or stimulus fractions  $x_i/b_i$ .

Power exponents are defined by rotational parameters, if power exponents correspond to weighing parameters in the sensation space, which weights are twice the inverse of the dimensional projection values of the adaptation space point. It then also specifies a rotation-invariant, non-Euclidean geometry for stimuli, while its rotational power exponent parameters as projections of a common space point are defined by (S1b2). Since Minkowskian sensation spaces correspond to non-Euclidean stimulus spaces, also weighted Minkowskian sensation spaces of (S1b1) correspond to non-Euclidean stimulus spaces, that become power-raised spaces with power exponents as matching parameters. The spaces of power-raised stimuli clearly are not rotation-invariant, because power exponents and thus also its dimensional curvatures change under rotations. But the underlying non-Euclidean stimulus space is rotationally invariant and defines power exponents by projections of point  $lib = \exp(-a) = \exp(-2/\tau)$  on the Euclidean co-ordinates of the non-Euclidean space of stimulus fractions  $x_i/b_i$  that is correspondingly rotated at the unit-valued stimulus-adaptation point as translated rotation centre, whereby  $lib$  is the dimensional stimulus threshold. It follows from the exponential co-ordinate terms of parameter  $l = a$  on the asymptotic or tangential

Euclidean co-ordinates  $k$  and  $l$  of the rotation-invariant, hyperbolic surface with curvature  $\pm\varphi = r/2$ , as defined by (38) or (43), that for  $h_k$  and  $h_l$  as dimensional rotation weights to dimension 9

$$\text{or } h_k \cdot \exp[\varphi(1/b_k - 1)] + h_l \cdot \exp[y(1/b_l - 1)] = \exp[r(2/\tau_9 + 1)/2] \quad (\text{Slc1})$$

$$h_k \cdot \exp[i \cdot \varphi(1/b_k - 1)] + h_l \cdot \exp[i \cdot y(1/b_l - 1)] = \exp[i \cdot r(-2/\tau_9 - 1)/2] \quad (\text{Slc2})$$

The power-raised stimulus terms must then be conceived as the result of a cognitive operation in the sensation space, induced by the task of magnitude scaling as matching with magnitude sensations, but power-raised stimulus terms have no meaning for the objective stimulus space.

In conclusion Stevens' power function contradicts not Fechner's psychophysical function, if the stimulus space is non-Euclidean (hyperbolic or double-elliptic) and the sensation space flat (Minkowskian or Euclidean) or if the stimulus space Euclidean and the sensation space hyperbolic. It specifies that Stevens' power exponents for stimulus modalities are defined by rotational parameters of dimensional projection values of a sensation space point. This condition is satisfied if Stevens' power exponents are matching parameters for the matching of perceptual sensations with cognitive sensations of magnitude, because then its power exponents equal twice the inverse values of the dimensional projections of the space adaptation point in the sensation space. The power exponents have no meaning for the stimulus or objectively measured object space. But, if the stimulus space is Euclidean then a rotation invariant sensation space that represents the space of power-raised stimuli is a hyperbolic space with dimensional weights that equal twice the inverse of dimensional adaptation point values, while if that space of power-raised stimuli is represented by a weighted Euclidean or Minkowskian sensation space then the rotation invariant stimulus space must be non-Euclidean. Thus, Fechnerian psychophysics and implicit matching apply and mean that subjective stimulus magnitudes are power-raised dimensions of Euclidean or non-Euclidean stimulus spaces, but it only describes a stimulus space representation of comparably weighted Fechner-Helson sensations, which follows from the Fechnerian matching that underlies Stevens' power functions.

Since the space of subjective stimulus magnitudes is a dimensionally power-raised Euclidean or non-Euclidean stimulus fraction space, its space curvatures vary with the dimensional directions. Thereby, its space points or distances become direction-dependent values or distances in a Finsler space. Its Finsler geometry is much more specified than in the Fechnerian scaling theory of Dzhamalov and Colonius (1999, 2001), who specified not the underlying geometry of the objective stimuli, nor discussed the rotational requirement for the dimensional power exponents that define the varying curvatures of subjective stimulus-magnitude space. However, in the corresponding hyperbolic or Euclidean sensation spaces the corresponding vectorial values are rotation-invariant and the corresponding distances rotation- and translation-invariant, whereby the analyses of evaluated stimulus or object-attribute spaces become much simpler by representations in correspondingly weighted sensation spaces. Evaluated stimulus or object-attribute spaces yield multidimensional magnitude judgments or dissimilarities as evaluative responses to compared sensations. Thus, the

analyses of magnitude judgments or dissimilarities concern values or distances in individual response spaces as metric transformations of flat (Euclidean or Minkowskian) or hyperbolic Bower spaces of comparably weighted and translated Fechner sensations. Metric response transformations of the hyperbolic or flat Bower spaces determine correspondingly different geometries for response spaces. The derived geometries for the response space then in turn determine geometrically appropriate multidimensional analyses of individual dissimilarities or comparative magnitude judgements. The analyses of comparative magnitude judgements as response space differences with respect to the adaptation point as origin or the analysis of (dis)similarities as response space distances in the derived geometries of individual response spaces yield the representation of corresponding stimulus or object configurations in a common Euclidean **object** space, either as stimulus or sensation space by their inverse response transformation and also solves individual adaptation points. It will be clear that a common Euclidean sensation space is a Fechner space that becomes individually translated and weighted for its individual transformation to response spaces, while the common Euclidean stimulus space corresponds to a common hyperbolic Fechner space that in the same way is individually transformed to response spaces. The topics of the next chapter concern the permissible alternatives for the geometry of response spaces and geometrically appropriate dissimilarity analyses that solve a common Euclidean object space and the individual transformation parameters from the inverse transformations of solved, individual response spaces with one of the permissible geometries.



## CHAPTER 4

### THE GEOMETRIES AND ANALYSES OF RESPONSE SPACES

"<> so ging alien Naturforschern ein Licht auf. Sie begriffen dass die Vernunft nur das einsieht, was sie selbst /ach ihrem Entwüifen hervorbn'ngt, doss sie mit Prinzipien ihTer Urteile /ach bestiindigen Gesetzen vorangehen und die NatuT notigen müsse auf ihre Fragen zu antworten, nicht abeT sich van ihr allein gleichsam am Leitbande gängeln lassen müsse; denn sons! hiingen zufällige, nach keinen vorher entworfenen Plane gemachte Beobachtungen gar nicht in einem /otwendigen Gesetze zusammen, welches dock die Vemunft sucht und bedarf".

Kant, I. (1787). *Kritik deT reinen Vernunft. (Critique of pure reason)*. **The** citation is from Kant's foreword in his 2<sup>nd</sup> edition (copied from p. 26 of the annotated 10<sup>th</sup> Gennan reprint by Valentiner, Th. (1913). Verlag Felix Meiner, Leipzig.)

## CONTENT DETAILS CHAPTER 4

	page
<b>4.1. Geometric relationships between sensation and response spaces</b>	<b>131</b>
4.1.1. Dissimilarities as individual response space distances	131
4.1.2. Projective geometries of individual response spaces	133
<b>4.2. The involution geometries of open response spaces</b>	<b>141</b>
4.2.1. The possibility of single-elliptic response spaces	142
4.2.2. Three pennissible involution geometries of the response space	147
<b>4.3. Common object and individual response spaces</b>	<b>152</b>
4.3.1. The applicability of existing MDS-analyses	154
4.3.2. Common object space from open individual response spaces	156
4.3.2.1. Analysis of single-elliptic response spaces	157
4.3.2.2. Analyses of open-Euclidean and open-hyperbolic response spaces	162

#### 4.1. Geometric relationships between sensation and response spaces

It is generally assumed that ordered objects dissimilarities can be represented by rank orders of object distances that are common to all individuals. Dissimilarity inequalities are viewed as order evaluations of compared distances between pairs of objects in a common Euclidean (or Minkowskian) object space. The usual analyses represent rank-ordered (dis)similarities as Euclidean distances between objects that satisfy in some optimal way that rank order by multidimensional scaling (MDS) techniques originated by Shepard (1962a,b) and for the first time solved by Kruskal (1964a,b). In more general models for (dis)similarity analyses, it is assumed that individuals evaluate that common object space by individually weighted dimensions. If individuals weigh dimensions of the common reference space of objects differently then the (dis)similarities between objects become represented by individually weighted dimensional distances between objects, which is analysed by the so-called mOSCAL procedure (Carroll and Chang, 1972). The reader is referred to overviews by Shepard et al. (1972), Roskam (1968), Krzanowski, (1988); Cox and Cox (1994), and Borg and Groenen (1997), wherein also the mathematical properties of the different solution procedures for these and related models and their psychological interpretations are discussed. Modern probabilistic MDS (Ashby and Perrin, 1988; Ashby, 1992a) solves similarities as overlap of differently located and shaped object distributions. However, in all these analyses the object configuration (as deterministic points or as centres of object distributions) is either identical for each individual or only modified by individually different dimension weights. However, dissimilarities are to be represented by distances in individually different response spaces. In the sequel we demonstrate that individual response spaces are *not* infinite spaces and contain *not* identical nor only individually weighted object configurations, but are open projection spaces from individually different perspectives of individually weighted sensation spaces, where the distance metric of open response spaces is either Euclidean, or hyperbolic, or elliptic.

##### 4.1.1. *Dissimilarities as individual response space distances*

In chapter 2 we identified judgmental responses as hyperbolic tangent transformations of sensation differences to individual adaptation levels. In this chapter we also consider the arctangent function as the unique alternative for the transformation of sensations to responses, because the multidimensional generalisation of sensation space transformations to individual response spaces shows that no other response function than these two functions can specify a response space with transitivity of ordered space distances. In chapter 3 it was shown that spaces of intensity-comparable sensations are individually translated and weighted spaces. Therefore, dissimilarities of stimuli are response distances in spaces that should be described by hyperbolic tangent or arctangent transformations of the sensation space with individually different translation and translation-dependent weight parameters. Any multidimensional analysis of (dis)similarity data has to take this into account. Dissimilarities as distances between responses to pairs of intensity-comparable sensations are then distances between hyperbolic tangent or arctangent transformations of individually different-weighted, hyperbolic or flat spaces of intensity-comparable sensations. Existing MDS-analyses assume that transitive dissimilarities correspond to object distances in Euclidean or



Minkowskian spaces and that individuals have an identical object configuration after weighing (eventually after weighing by individual dimension weights). Our analysis of dissimilarities as response space distances questions these assumptions,

Let  $d$  denote a distance function,  $\mathcal{E}$  a transformation function, and  $r_i$  a response to sensation  $s_i$  then it is mostly assumed that

$$d[r_i, r_j] = \mathcal{E}\{d(s_i, s_j)\}. \quad (52a)$$

function  $\mathcal{E}$  is some order preserving function for perceived to judged dissimilarity, while  $d$  and  $\mathcal{E}$  are identical for individuals. In Carroll and Chao (1970) the distance function is individualised by individual weights for common object dimensions, whereby we have for individual  $J$

$$d_J[r_i, r_j] = f\{d_J(s_i, s_j)\}. \quad (52b)$$

In the general recognition theory of (dis)similarity the sensation distance can become also individualised if distributions of sensation points are determined by individually different covariance matrices (Ashby and Perrin, 1988), such that

$$d_J[r_i, r_j] = -\ln\{P_J\{s_i, s_j\}\}, \quad (52c)$$

where  $P_J(s_i, s_j)$  is the similarity probability of confusing  $i$  and  $j$  by individual  $J$  due to distributions of stimuli  $j$  and  $i$  with common mean location points and individual perception variances. It will be noted for probabilistic sensations that confusion probability  $P_i$  depends on other stimuli and that discrimination boundaries become dependent on the selection of other stimuli than stimuli  $i$  and  $j$ . An increase of the distance between centres of the distribution as well as a decrease in their variances will decrease the confusion of stimuli. The general recognition theory of (dis)similarity, therefore, can explain some individual and context dependencies as well as some violations of the triangular inequality of response distances, but the centres of  $i$  and  $j$  are not assumed to be individually different. Moreover, in all these models no geometric distinction is made between individual sensation or response spaces or the common stimulus space. Since in the existing analysis models the reference space is assumed to be a Euclidean or Minkowskian space with a common object configuration, this common space must be the Euclidean stimulus space or the flat sensation space. But (dis)similarities are response distances that are individually different distances by their adaptation-point dependency of monotone response functions of individually weighted sensations from a common stimulus space. It can cause that response distances have not the same rank order as individually weighted sensation distances. Individually different sensation transformations of common stimuli  $x_i$  and  $x_j$  are defined by sensation function  $f$  as individually weighted sensation distances

$$d(s_i, s_j) = d[f_J(x_i), f_J(x_j)],$$

Response function  $f$  is also individually different, due to different projection perspective of the response function for the individual projection transformation of sensations to responses. Dissimilarity are

to be represented by distances between monotonic transformed projections of individually weighted sensations from individually different origins, whereby same individual sensation distances can become individually different response distances. So we have in contrast to existing models

$$\text{where } d[r_{Ji}, r_{Jj}] = d[f_J\{s_{Ji}\} - f_J\{s_{Jj}\}] \quad (52d1)$$

$$f_J\{d[(s_{Ji}, s_{Jj})]\} \neq d[r_{Ji}, r_{Jj}], \quad (52d2)$$

For individual  $J$  the sensation function  $f_J$  defines differently located adaptation points  $a_{Jk}$  in the Fechner sensation space, while response function  $f_J$  of sensations depends on individual weights ( $2/a_{Jk}$ ) of sensation dimensions and on individual projection origins ( $a_{Jk}$ ). The important difference with existing models is not that  $f_J$  and  $f_I$  are monotone transformations, but that the inequality of (52d2) may cause that the rank order of pairs  $d(s_{Ji}, s_{Jj})$  and pairs  $d[r_{Ji}, r_{Jj}]$  become different and that (52d1) also may specify different rank orders for pairs of  $d[r_{Ji}, r_{Jj}]$  and  $d[r_{Ii}, r_{Ij}]$  for individuals  $J$  and  $I$ .

Response space distances are distances between points in projective transformed spaces of individually weighted, intensity-comparable sensation spaces with individual adaptation points as projection origin. The rank order of response space distances need not to be the same for corresponding distances in individually weighted sensation spaces, as discussed in section 2.1.3. for a single scale. Only response and weighted sensation distances from the adaptation point are monotonically related for each individual, but dissimilarities between objects are not represented by distances to an adaptation point. It means that an analysis that represents transitive dissimilarity rank orders as ordered distances in an individually weighted Euclidean space, as performed by individual difference MDS-analysis (Carroll and Chang, 1970, 1972), may not correctly recover the object configuration, even if the sensation space is Euclidean. However, if all objects are in the proximity of individual adaptation points, then response and individually weighted sensation space distances tend to approximate the same rank order, whereby individual difference MDS-analysis of dissimilarities could almost correctly recover the object configuration in a common Euclidean sensation space, if the sensation space is not hyperbolic. It also means that analyses of aggregated dissimilarities of individuals must run into inconsistencies, unless individuals have identical adaptation points, but as shown in sections 4.2. and 4.3. then the solved Euclidean space is a common, open-Euclidean response space.

#### 4.1.2. Projective geometries of individual response spaces

In figure 22 below we represent the iso-distant response contours in an individually scaled, Euclidean stimulus-fraction plane. In this plane of stimulus fractions the dimensional adaptation points  $b_{11}$  and  $b_{12}$  define the unit space point and the zero origin of the individual sensation and response spaces. The presented asymmetric contours derive from concentric iso-distant circles with equal distances in the individual response spaces. The asymmetry of iso-distant response contours in the Euclidean stimulus plane are caused by the exponential transformation of the hyperbolic sensation space. On hyperbolic surfaces of comparable sensations the equidistant iso-distant response contours are also concentric circles with individually located adaptation points

as centre, but the sensation distances between its equidistant iso-distant response circles are different and the larger the more eccentric they are.

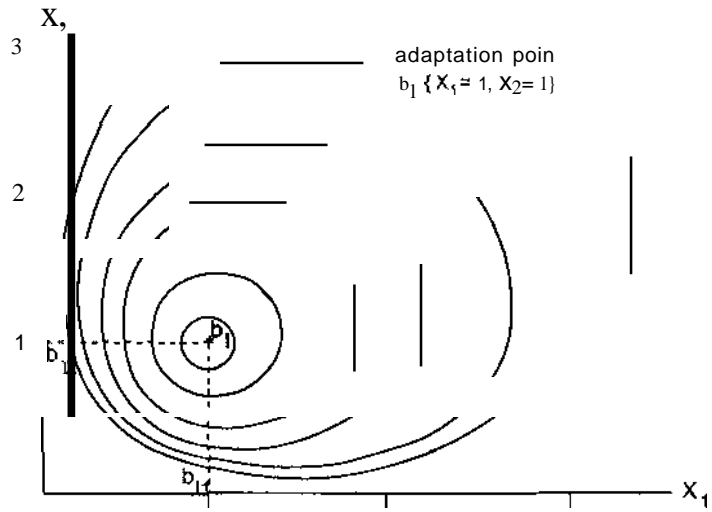

Figure 22. Iso-distant response contours in a stimulus fraction plane/or an individual.

In order to avoid the asymmetry of iso-distant response contours and their representations on hyperbolic sensation surfaces. we show in figure 23 the iso-distant response contours of two individuals in a Euclidean sensation plane.

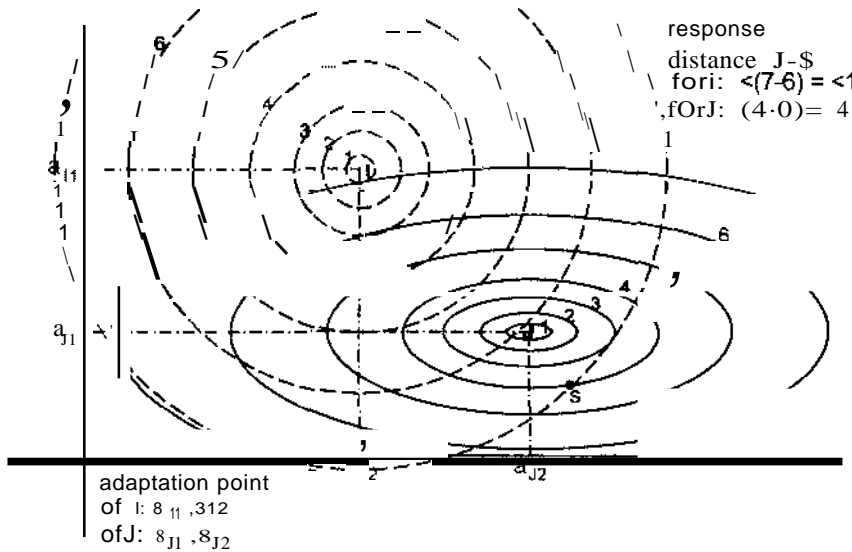

Figure 23. Two sets of equidistant iso-distant response circles in a Fechner plane.

Figure 23 only is an improper presentation if the sensation space is hyperbolic, because then it is a somewhat distorted representation (in a similar way as the projection of half a globe on a plane distorts the globe distances). The ellipses of the iso-distant response contours become concentric circles with expanding distances between its circles in individually weighted and translated Euclidean sensation spaces, where the individual translations are to the adaptation points as centres of the individual, iso-distant response contours that in their dimensionally weighted sensation spaces are circles. Without the individual translations to the adaptation points and corresponding dimensional weights these iso-distant response contours, as plotted in figure 23, are differently oriented ellipses with differently located adaptation points as ellipse centres in a common Euclidean object plane of Fechner sensations. Figure 23 illustrates how the distances between the weighted iso-distant response circles for each individual become increasingly larger the more remote the weighted circular contours are from the individual adaptation points as centres in the Fechnerplane. Each individual differently transforms object distances in the sensation plane to response space distances, due to their different adaptation point locations circles and different dimensional weights that equal twice the inverse values of the dimensional adaptation points. The differences between response distances to the adaptation point for two identical objects of individual I and J are dependent on the locations of their adaptation points and their inversely location-dependent dimension weights. If two relatively close objects are on opposite locations of the individual adaptation point then such objects are experienced as familiar and rather dissimilar by the individual. If for another individual the same objects are both located far remote from the individual adaptation point in the same direction then that other individual judges the objects as unfamiliar and rather similar. For example, Europeans find it difficult to see differences between the outlook of Asians in contrast to differences between Europeans, but the reverse holds for Asians with regard to Europeans. By the individual weighing of the Euclidean sensation dimension the iso-distant response contours become circles with respect to their adaptation point as centre. However, since equal distances between iso-distant response circles represent different sensation distances, also the MDS-analysis of (dis)similarities by the so-called IDIOSCAL method (Carroll and Chang, 1972) that individually weighs dimensions may yield no correct object configuration in the corresponding common Euclidean reference space. The assumption of the IDIOSCAL solution that the rank orders of response distances and weighted sensation distances are equal is incorrect, as in figure 23 shown by the different distances between the ellipses of the iso-distant response circles with equal circle distances in the response space. Moreover, if (dis)similarity rank orders between objects for different individuals are aggregated and analysed by multidimensional scaling methods the solutions must be quite unsatisfactory, because existing MDS-analysis methods don't allow individuals to have locally different transformations of the common object space.

The iso-distant response circles in the individually weighted sensation space of figure 23 could be seen as similar to radial projections of latitudes on half a globe. The half globe would then represent an individual response surface with the adaptation points as polar centre for the projections on a Euclidean sensation plane. This analogy for a Euclidean sensation plane as radial projection of a hemispherical response

surface, is useful and not only because of the familiarity to us. It asks a response space to be generated from a Euclidean or Minkowskian sensation space by the arctangent (inverse tangent as inverse radial projection) function of its sensations in flat space, which is investigated in the sequel. The projection of a straight line on a half circle by the arctangent function is shown in figure 24

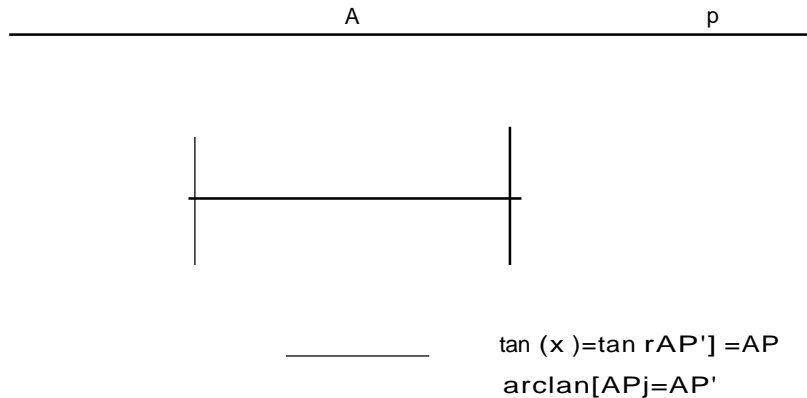

Figure 24. Arctangent transformation of a line points to points on a halfcircle.

By the arctangent transformation of one sensation dimension to a response dimension, the responses become points on a half circle (the intersections of the circle and the radial projection lines). A revolution of this half circle and of the tangential sensation dimension at the polar point then would define a hemisphere and a Euclidean plane with a hemispherical pole as common point. What this analogy with a hemisphere illustrates is the individual dependence of the response representations on the location of adaptation point A in the Euclidean sensation plane. **If** we compare such hemispheres for differently located adaptation points as different polar points then each individual represents the same Euclidean sensation plane by a different response hemisphere. Latitude circles on the respectively different response hemispheres are to be seen as iso-distant response circles for each individual. The radial projection of the latitude circles for two individual response hemispheres would correspond with the two sets of iso-distant circles on the individually weighted sensation plane. However, notice also that equal distances between these circles on the response hemispheres are not equal distances between the iso-distant circles on the weighted sensation plane. Similar to the hyperbolic tangent transformation of sensations, equal distances between response space circles (as latitudes) become increasingly larger distances between corresponding circles in the weighted sensation space the more eccentric the response circles are. The personal response equator of an individual would represent the limiting response space boundary for objects on infinite distances from the adaptation point in the sensation plane. Circular response distances on that hemispherical response equator represent the direction differences of infinities in the sensation plane. Relative large sensation distances for object points far away from the centre as adaptation point, but in the same direction, would become almost zero distances between corresponding projection points close to a point on the equator of the response hemisphere. Finally,

the analogy illustrates that the response space is a circular open space, where the open hemispherical space describes a so-called, single-elliptic geometry. This analogy of the radial projection of a hemisphere to a Euclidean plane would imply that the common Euclidean object space is a Fechnerian sensation space. According to section 3.2.1, the sensation space is flat (Euclidean or Minkowskian), if the stimulus space is non-Euclidean. If the arctangent function could serve as a transformation function of a flat sensation space to a response space, then the response space could indeed be a single-elliptic space that would correspond to a spherical stimulus space that geometrically is called a double-elliptic space. A conformal distance metric for responses and stimuli seems a prerequisite, otherwise responses can hardly be rather adequate, behavioural actions in the physical world.

The arctangent function differs from the originally derived hyperbolic tangent function (section 2.2) for transformations of sensations to responses, but it is a similar sigmoid transformation. The above analogy is also helpful for the understanding of how a hyperbolic or a flat (Minkowskian or Euclidean) sensation space is transformed by the hyperbolic tangent function to response spaces with a different geometry. It will not be surprising that we have another geometric relationship between an open response space and the infinite sensation space by the hyperbolic tangent transformation of hyperbolic sensation spaces to open response spaces. This is easily understood by the stereographic projection of a hyperbolic curve as the geometric equivalent of the hyperbolic tangent function (Courant, 1960; Dubrovin et al., 1992). How the hyperbolic tangent of hyperbolic curve points does similar things as the arctangent of straight line points is illustrated in figure 25.

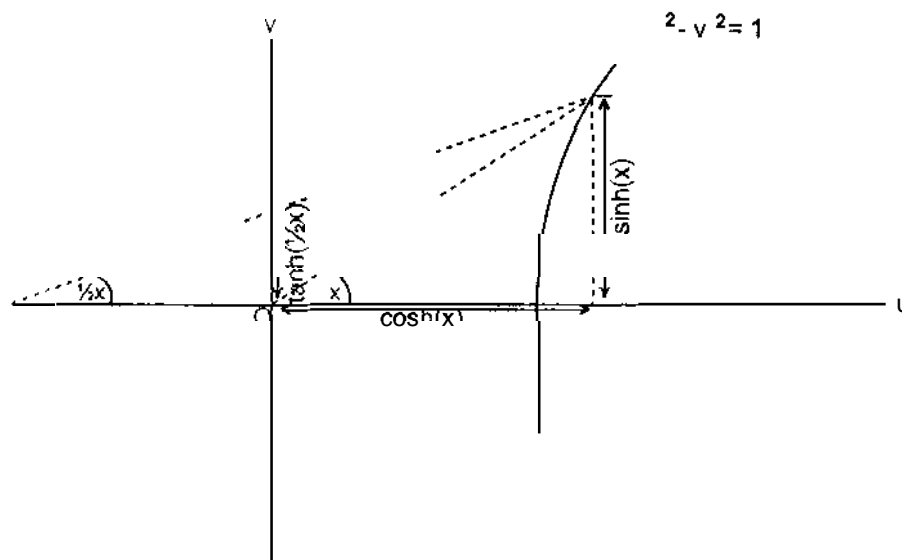

Figure 25. The hyperbolic tangent transformation of a hyperbolic curve.

As discussed in the sequel, the hyperbolic tangent transformation of an infinite sensation space is a so-called hyperbolic involution of the infinite Euclidean or hyperbolic stimulus space to an open response space that has the same distance metric

as the stimulus space. Thus, also here the open response geometry has a distance metric that is conformal to the distance metric of the corresponding stimulus space geometry, where the hyperbolic tangent transformation of a hyperbolic or flat sensation space yields indeed respectively an open-Euclidean or open-hyperbolic response space. Due to the similarity between the arctangent and hyperbolic tangent functions there are close similarities between response hemispheres and the other response spaces with distance metrics that are conformal to their stimulus spaces. Comparison of figures 24 and 25 shows that what the arctangent function (inverse radial projection) does for points on an infinite Euclidean space, is also done by the hyperbolic tangent function (stereographic projection from the opposite located pole of the corresponding circle) for points on an infinite hyperbolic surface. The hyperbolic tangent function transforms infinite hyperbolic curves (negative unit curvature described by  $v^2 - u^2 = -1$  for Euclidean co-ordinates  $u$  and  $v$ ) to a limited line segment by its stereographic projection on its co-ordinate  $v$  at unit distance from the curve intersection point with the other orthogonal co-ordinate  $u$  that intersects the hyperbolic curve at its origin. The origin of the Euclidean co-ordinates  $u$  and  $v$  also is the origin the projected line segment within the corresponding circle for  $v^2 + u^2 = 1$  with a radius of unity. The tangential asymptotes for the hyperbolic curve infinities meet in the opposite pole of the unit circle, which circle thus defines the limits of the projection line segment. How the arctangent function defines a length of a hemispherical line segment was illustrated by figure 24. That figure gives a finite representation on a half circle of an infinite line, where figure 25 represents an infinite hyperbolic curve and the hyperbolic tangent function of that infinite hyperbolic curve as a finite line segment (stereographic projection). From the revolution (rotation around the centre) of the line segment and corresponding revolution of the hyperbolic curve in figure 25, we obtain a circularly open flat disc as two-dimensional response space for a two dimensional hyperbolic sensation surface. This response space is flat and rotation- and translation-invariant and, thus, has indeed a Euclidean distance metric, conformal to the Euclidean stimulus space that corresponds to a hyperbolic sensation space.

Its geometry is comparable to the alternative geometry of hemispherical response spaces that derive from the arctangent transformation of a Euclidean or Minkowskian sensation space. Each function - on the one hand the hyperbolic tangent (stereographic projection of hyperbolic curves) and on the other hand the arctangent (inverse radial projection of straight lines) transforms infinite spaces into circular open spaces. Both projections represent the finite response transformation of an infinite sensation space. Both projections also have comparable properties such as that circles on the curved surfaces with the surface origin as projection centre remain circles respectively in their radial or stereographic projections on a Euclidean plane, while also only lines through the origin on the curved surfaces remain projection lines on a Euclidean plane. The important difference between the response spaces from the arctangent transformation of flat sensation spaces and from hyperbolic tangent transformation of hyperbolic sensation spaces is that the open response space itself is single-elliptic in the former case and open-Euclidean in the latter case. It also must be noticed that the stereographic projection of the hyperbolic curve  $u^2 - v^2 = 1$  in figure 25 is defined as curve projections from origin  $u = -1$  at opposite projection centre  $u = 1$  on

to dimension  $v$  within the open interval of  $v = 1$  and  $v = -1$ . This differs from the arctangent function as inverse radial projection of a straight line on half circles, where it concerns a projection from the centre of circle  $v^2 + u^2 = 1$ . The corresponding angle for a hyperbolic tangent in figure 25 is half the angle of the tangential projection of the half circle in figure 24. If a circle would be stereographically projected from the opposite polar centre  $u = -1$  then it would project the whole circle onto a Euclidean dimension  $v$  through the circle centre. Thus a stereographic projection of points  $p$  on the whole circle describes by  $\tan(Y2p)$  an infinite dimension  $v$ , while the stereographic projection of points  $p$  on the upper half circle describes by  $\tan(Y2p) = v$  only a line segment  $-\frac{1}{2}\pi \leq v \leq \frac{1}{2}\pi$  and on translated dimension  $v$  through the circle centre a line segment  $-1 \leq v \leq 1$ , where its segment is limited by the unit circle. Thus the stereographic projections of points  $p$  on a half circle by  $\tan(I/2p)$  and point  $s$  on an infinite hyperbolic curve by  $\tanh(1/2s)$  concern both projections onto the same central line segment  $-1 \leq v \leq 1$ . This geometric identity is illustrated in figure 26.

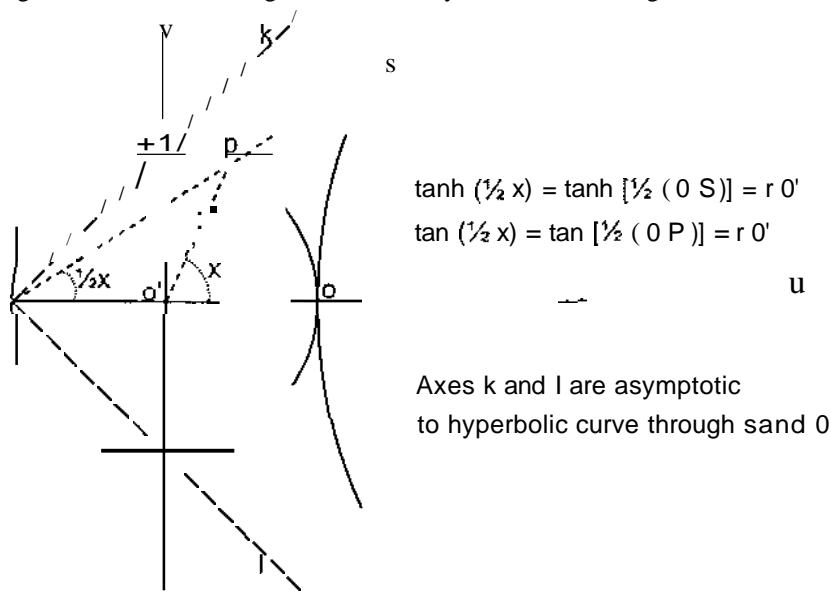

Figure 26. Identity of stereographic projections of a half circle and hyperbolic curve.

Here the projection of a half circle with unit radius is not radial (from the centre), but stereographic (from the anti-polar point). It is the stereographic projection that would extend the projection of a full circle to infinity on both sides of the projection line, as described by the tangent of half the angles of points on a circle. In figure 26 the line segment  $o'-r$  is a stereographic projection of hyperbolic distance  $(o-s)$  as well as of circular (elliptic) distance  $(o-p)$ . The half circle is projected on an open line segment between plus and minus unity. The revolution of the half circle in figure 26 yields a hemisphere and the corresponding rotation of the line segment yields an open circular disc that is identical to the open-Euclidean disc from the rotated line segment of stereographic projected hyperbolic curve in figure 25. This disc is both a stereographic



projection of a hemisphere and stereographic projection of a hyperbolic surface, where the last alternative is the so-called Poincare-model for a hyperbolic surface. More formally we denote:

$$-1 \leq \mathbf{r} | \mathbf{Poin} \leq 1$$

for open-Euclidean responses  $r = \tanh(1/2s)$  for hyperbolic sensations  $s$  (figure 25) and

$$1/2\pi \leq \zeta \cdot \mathbf{r} | \mathbf{Hemi} \leq 1/2\pi$$

for hemispherical (single-elliptic) response dimension  $r$  with radius  $p=1/\zeta$ , where  $\tan(\zeta \cdot \mathbf{r}) \equiv s$  for sensation  $s$  in a Euclidean or Minkowskian space. We further define

$$\zeta \cdot \mathbf{s} | \mathbf{Hyp}$$

for a sensation  $s$  in a hyperbolic space, where the constant curvature  $\zeta$  is the scale factor for correction to unit (pseudo)-radius, while for Euclidean sensations  $s$  we define

$$s | \mathbf{Eucl}$$

Then, according the projection of figure 24, we have:

$$\tan[\zeta(\mathbf{r} | \mathbf{Hemi})] = s | \mathbf{Eucl} \quad (\text{radial projection})$$

and according the projection of figure 26 also

$$\tan[1/2\zeta(\mathbf{r} | \mathbf{Hemi})] = \mathbf{r} | \mathbf{Poin} \quad (\text{stereographic projection})$$

while according the projection of figure 25

$$\tanh[1/2\zeta(\mathbf{s} | \mathbf{Hyp})] = \mathbf{r} | \mathbf{Poin} \quad (\text{stereographic projection})$$

It summarises the relationships between  $\zeta \cdot \mathbf{r} | \mathbf{Hemi}$ ,  $\mathbf{r} | \mathbf{Poin}$ ,  $\zeta \cdot \mathbf{s} | \mathbf{Hyp}$  and  $s | \mathbf{Eucl}$ . Due to the undetermined curvature or space scale parameter  $\zeta$ , the two relations for  $\mathbf{r} | \mathbf{Poin}$  in the last two expressions as well as the two tangent transformations of  $\mathbf{r} | \mathbf{Hemi}$  in the first two expressions might give rise to confusion in analyses and interpretations.

In figure 26 the stereographic projection of the whole circle (from the polar point onto the central line orthogonal to the polar axis) gives an infinite straight line as the representation a circle and by its revolution an infinite flat plane that represents a complete sphere. This stereographic projection of a *complete sphere* that has a so-called *double-elliptic geometry* (weighted spherical dimensions) defines an infinite plane, while the radial projection of a *hemisphere* that has a so-called *single-elliptic geometry* (weighted hemispherical dimensions) also defines an infinite plane. The arctangent functions of half the vectors from that origin in the infinite plane define the representation of that plane on complete spheres and tangent functions of these vectors themselves define the representation of that same plane on a hemisphere. On the hemisphere the infinite vector values become the limit circle of unit radius of the hemisphere, while infinite vector values become a single point on the complete sphere as the opposite pole of the pole that corresponds with the plane origin. Responses to very intense sensations for different modalities are very different, which implies that responses to almost infinite sensation intensities for different dimensions are not to be represented by the same response point as opposite pole point of the polar adaptation point in a response space with a double-elliptic geometry. Therefore, if the arctangent function is a permissible response function for Euclidean or Minkowskian sensations, it can only define a single-elliptic response geometry with radius  $2r$  for a Minkowski  $r$ -metric of the sensation space. However, the tangent function of responses as inversely radial projection of single-elliptic response spaces only applies to unit radius spaces, which by curvature correction  $\zeta_r = r/2$  can only determine by  $\tan(\zeta_r \cdot \mathbf{r}_j) = s$  a Euclidean sensation space, even if it the response space would be generated from a Minkowskian sensation space with  $r \neq 2$ . We remind that the circular projection disc is a

representation of the opposite hemispheres as well as a representation of a hyperbolic surface. The stereographic projection of a complete sphere represents one of its hemispheres by the interior of a circular disc and the other hemisphere by a infinite plane without that circular disc. Since the circular disc is also the stereographic projection of a hyperbolic surface as the so-called Poincare model for a hyperbolic surface, while the plane without the circular disc is a polar projection of the mirror hemisphere, the projection plane with an 'empty' circular disc can equivalently represent a hyperbolic surface. The latter representation is the so-called Klein-model for hyperbolic surfaces. but we only use Poincare's model for discussion in section 4.2.2.

#### 4.2. The involution geometries of open response spaces

Whether a single-elliptic geometry for response spaces may be conceived, depends on the assumption of the geometry for the sensation space and the arctangent function as a valid alternative for the response function. If the arctangent function is a valid alternative then it would be a consistent response function for a single-elliptic response space, provided that the sensation space is flat (Euclidean or Minkowskian) and derived by the Fechner-Helson function from a double-elliptic stimulus space. It yields a conformal distance metric as elliptic distances in stimulus and response spaces. The originally derived hyperbolic tangent function, as the response function for a hyperbolic sensation space that is generated from a Euclidean stimulus space. may be seen as the more valid combination. It not only yields a consistent response geometry with a conformal Euclidean distance metric for stimulus and response spaces, but the hyperbolic tangent function also is based on the experimentally confirmed logistic function for stimulus discrimination. If the arctangent function is a valid alternative response function then we would in theory have four combinations from two possible response functions (hyperbolic tangent or arctangent function) and two possible geometries of sensation spaces (flat or hyperbolic). However, the possibility of the arctangent as the response function for hyperbolic sensations specifies no consistent distance metric for response and stimulus spaces. Therefore, this combination is not further considered. but the possibility of the hyperbolic tangent as response function for Euclidean or Minkowskian sensations will be considered further in section 4.2.2, because it yields a consistent geometric projectivity of a hyperbolic stimulus space to an open response space that also has a hyperbolic distance metric. Its two-dimensional response geometry is described by the interior of a circularly open and hyperbolically curved disc (instead of an open Poincare disc with a Euclidean metric). We first investigate whether the arctangent can be indeed a valid response function for Euclidean or Minkowskian sensation spaces. The next section shows that the answer to that question will be positive. Therefore, we have three permissible combinations for two response functions and two sensation geometries that yield three alternative geometries for response spaces with distance metrics that are conformal to the distance metric of the stimulus space with a Euclidean, or double-elliptic or hyperbolic geometry. In the sequel we discuss these three response geometries and describe techniques for appropriate multidimensional analysis of (dis)similarities as distances in one of the three alternative response geometries.

#### 4.2.1. *The possibility of single-elliptic response spaces*

In chapter 3 we proved that sensation space can be a flat space (Euclidean or Minkowskian), if deriving from a non-Euclidean stimulus geometry by the Fechner-Helson psychophysical function, while a flat space of comparable sensations inversely defines the power-raised, non-Euclidean stimulus fraction space for the subjective stimulus magnitudes of Stevens' magnitude scaling. Only if the arctangent function is a theoretically and empirically acceptable response function for Euclidean or Minkowskian sensations, then a single-elliptic response geometry can be an alternative for the hyperbolic tangent as response function. Referring to the next mathematical section, the arctangent function is a linear transformation (multiplication by  $1/\pi$  and subtraction of  $1/2$ ) of the Cauchy probability function, similar to the linear relationship between the hyperbolic tangent function and the logistic probability function (multiplication by 2 and subtraction of 1, see subsection 2.2.1.). Therefore, if the response probability function can be the Cauchy probability function then - analogously to the logistic probability function for discrimination responses - it could justify the arctangent function for the transformation of a flat sensation space to single-elliptic response spaces (scaled to values between  $-1/2$  and  $1/2$ ). So the question becomes the justification of the cumulative Cauchy distribution as a response probability function.

In Thurstone's model for comparative judgement (Thurstone, 1959; reprints of Thurstone, 1927a and 1927b) the discrimination probability function is the cumulative normal probability function of the difference of two normal-distributed scale values of objects. Thurstone took these scale values to be logarithmic stimulus values as sensation scale values. Since difference distributions of two independent (or constantly correlated) and normal-distributed variables (with equal variances in case V of Thurstone's model) have a normal distribution, Thurstone arrived at the cumulative normal distribution as the response probability function for the judgement of sensation differences. In terms of Thurstone's model our response function would become based on the cumulative normal distribution for the difference of the logarithmic transformed stimulus and adaptation-level values, since in Thurstone's model it is supposed that the stimulus values have log-normal distributions. In contrast to the difference, the ratio of two independent variables with normal distributions  $N(O, I)$  defines a Cauchy distribution (Kendall and Stuart, 1952). For logarithmic stimulus values the assumption of  $N(O, I)$  distributions is reasonable, because random ratio-scale variables generally show constant coefficients of variation that are stabilised to uniform variances by the logarithmic transformation of the Fechnerian psychophysics. If we assume the same, but in contrast to Thurstone's model, assume that the response probability function is based on a ratio of logarithmic stimulus fractions (instead of the logarithm of the ratio of stimuli as the sensation difference of Thurstone's model), then indeed we obtain the cumulative Cauchy distribution as a possible response probability function, as shown in the mathematical section below. Since the Cauchy probability function can be an alternative for the response probability function, the arctangent function can be a theoretically justified alternative for the bipolar response function.

In figure 27 below we plot the Cauchy probability function and the logistic probability function (Luce's response probabilities from which the hyperbolic tangent function is derived in section 2.2.L) as well as the normal probability function

(Thurstone's response probabilities), As mentioned in chapter 2, due to the similarity between the normal and logistic probabilities one could as well replace the normal by the logistic probability function for discrimination response data (Luce and Galanter, 1963a, p. 221.). In the plot of these probability functions the common reference sensation is at probability 0.50, while the sensations are scaled in such a way that their probability functions have common anchor points at probabilities 0.20 and 0.80 (by specifying the free variance parameter in the three symmetric probability functions).

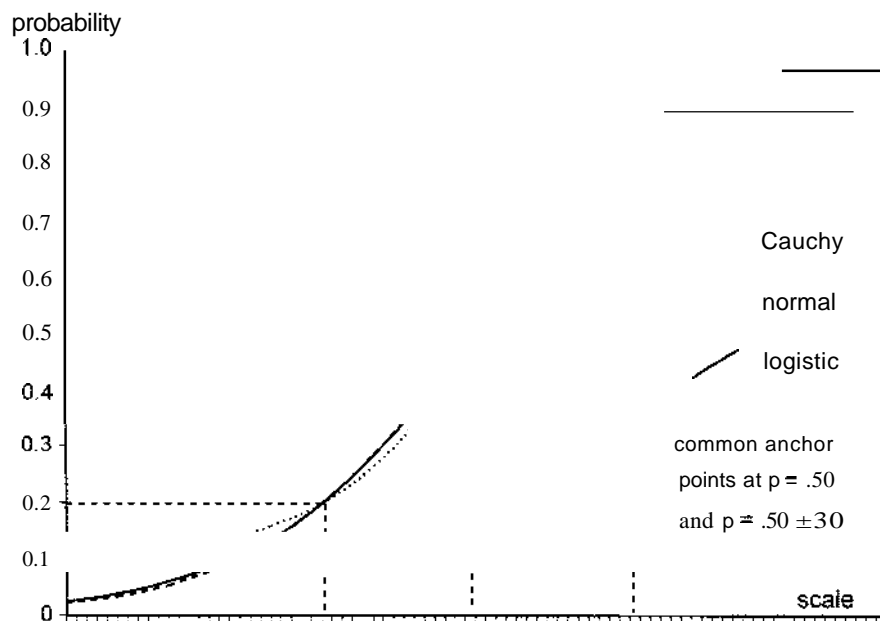

Figure 27. The Cauchy, normal, and logistic probability functions

Figure 27 demonstrates that the Cauchy probability function shows only marked differences from the hardly differing, normal and logistic probability functions for high or low probabilities. Apart from the fact that the error in experimental data of discrimination probabilities is often larger than the differences between these probability functions, extreme discrimination probabilities are seldom reported and when reported they refer by definition to the rare occasions wherein rather different stimuli are judged to be the same. Extreme discrimination probabilities are thus unreliably determined, due to their relatively large error variance. Thus whether a Cauchy probability function is a suitable alternative for the logistic or normal probability function as response probability function is difficult to assess by experimental tests. In the literature we only found one set of ten discrimination probabilities between 0.975 and 0.025 that are reliably assessed, since based on 105 observations per scale interval (for loudness discrimination, Luce and Galanter, 1963a, p. 196, fig. D). These data seem to fit the Cauchy probability function less well than the normal or logistic probability function, but it concerns unpublished data that only are graphically displayed, whereby we don't know whether its fit by the Cauchy probability function is significantly worse.

The Cauchy distribution function of random variable  $z$  is written as (Wilks, 1962, p. 130 and pp. 255-256)

$$f(z) = 1/\{n[1 + \{(z - p)/g\}^2]^{3/2}\}. \quad (53a)$$

Function  $f(x_i)$  is a distribution function for discrimination responses to stimuli  $x_i$  around adaptation level  $b/u$  as log-normal distributed random variable with mean  $b/u$  and  $u$  as perception threshold for a stimulus dimension  $x$ , if  $z$  in (53a) becomes the ratio of equal normal-distributed variables (Kendall and Stuart, 1952; p. 268, 273). Hence we take  $z = \ln(x_i/u) / \ln(b/u)$ , while the variance stabilising effect of the logarithm of ratio scales allows scaling to  $q = 1/2$  and by definition  $\mu = \ln(b/u) / \ln(b/u) = 1$ . The Cauchy distribution is then rewritten as

$$f\{x_i\} = 1/\{n[1 + (2 \ln(x_i/u) / \ln(b/u) - 1)^2]^{3/2}\}. \quad (53b)$$

Integration of  $f\{x_i\}$  gives the arctangent (inverse tangent) function. So instead of the comparably transformed logistic probabilities this is an alternative response function for corresponding deterministic values of stimuli and individual adaptation levels, which by subtraction of  $1/2$  as constant of integration and multiplication by  $n$ , writes as

$$r_i = n \arctan\{2 \ln(x_i/u) / \ln(b/u) - 1\}. \quad (53c)$$

By the Fechner-Helson function  $\ln(x_i/b) - a$ , we obtain

$$\frac{2 \ln(x_i/u)}{\ln(b/u)} - 1 = \frac{2 \ln(x_i/b)}{\ln(b/u)} - 2 \ln(y_i - a) = s_i \quad (53d)$$

with  $a = \ln(b/u)$ . If  $u$  would be an arbitrary parameter then we would have arbitrary parameter  $a$ , but for comparable sensations we define  $a = \ln(b/u)$  for  $u = 1$  as the just noticeable stimulus level and  $b$  as stimulus adaptation level. Here again  $s_i = \ln(y_i - a) - \ln(y_i - 1)$ . For Euclidean sensations (53c) writes as

$$r_i = n \arctan(s_i) = (n/2) \ln \left| \frac{1 + i s_i}{1 - i s_i} \right| \quad (53e)$$

where we see that (53c) is the arctangent for individual sensations. It yields by the inverse of (53e)

$$\tan[r_i/n] = \frac{1 - e^{-i 2 r_i/n}}{i(1 + e^{-i 2 r_i/n})} \quad \text{for } -\pi/2 < r_i/n < \pi/2, \quad (53f)$$

where we see that for  $r_i = 0$  we have  $s_i = 0$ , while unique values of  $s_i$  range from  $-\infty$  to  $\infty$  for  $-\pi/2 < r_i/n < \pi/2$

If sensations are Euclidean or Minkowskian then (53e) specifies single-elliptic response spaces. With reference to (43) and (44) we define

$$u_i = \sqrt{1/2} e^{i \cdot \phi \cdot r_i/n}; \quad u_{ih} = \sqrt{1/2} e^{i \cdot \phi \cdot r_{ih}/n}; \quad u_{ik} = \sqrt{1/2} e^{i \cdot \phi \cdot r_{ik}/n} \quad (54a1)$$

$$u_{ih} = \sqrt{1/2} e^{-i \cdot \phi \cdot r_i/n}; \quad u_{ih|l} = \sqrt{1/2} e^{-i \cdot \phi \cdot r_{ih}/n}; \quad u_{ih|k} = \sqrt{1/2} e^{-i \cdot \phi \cdot r_{ik}/n} \quad (54a2)$$

as Euclidean co-ordinates for a hemispherical response space and obtain by rotation of  $45^\circ$  with respect to  $h$  and a translation to its hemisphere the usual Euclidean co-ordinates of response  $r_{\perp}$  with

$$[(u_{ih} + U_i)/J_2]^2 - 1 = \cos^2(\zeta \cdot r_{\perp}) - 1$$

$$\sqrt{[\cos^2(\zeta \cdot r_{\perp}) - 1]} = \pm \sin(\zeta \cdot r_{\perp}) = r_{ih}$$

$$[liik + U_{ih}]/J_2 = \cos(\zeta \cdot r_{ik}) = r_{ik}, \quad (54b)$$

and

$$[U_{i1} + U_{ih}]/J_2 = \cos(\zeta \cdot r_{i1}) = r_{i1}$$

The elliptic Pythagorean expression with  $-\pi/2 \leq \zeta \cdot r_{\perp} \leq \pi/2$  becomes

$$\cos[\zeta \cdot r_{i1}] \cdot \cos[\zeta \cdot r_{ik}] = \cos[\zeta \cdot r_{\perp}]. \quad (54c)$$

For Euclidean or Minkowskian sensations we may have a double-elliptic geometry for stimuli  $x_i/b$  with curvature  $\zeta = r/2$ , whereby stimuli then satisfy in terms of radian values  $-\pi \leq [\zeta \cdot x_i/b - \eta] \leq \pi$ . Since the condition  $-\pi/2 \leq \zeta \cdot r_{\perp} \leq \pi/2$  applies to single-elliptic responses, we see that the curvature of single-elliptic response space is also defined by the  $r$ -metric of the sensation space as  $\zeta = r/2$ , where the relationship between  $r_{\perp}$  and  $x_i/b$  is defined by

$$\tan[(r/2) \cdot r_{\perp}] = s_i = 2(Y_i - a) = \ln[(x_i/b) - 1]. \quad (54d)$$

and  $s_i = 2(Y_i - a)$  defines a Euclidean space of comparable sensations.

If the data would fit different response functions equally well then a choice for a response function can only be based on the theoretical arguments. A linear transformation of the integrated nonnal distribution yields no explicit function and also defines no projective geometry with a constant curvature. Therefore, we are only left with the logistic and Cauchy probability functions as unique alternatives for the response probability function, because after their linear transformation to a bipolar response function only these two probability functions define a geometric projection function of infinite sensation scales to finite response lines or curves with a constant curvature. The cumulative Cauchy distribution as an alternative response probability function for discrimination responses defines by the linearly transformed Cauchy probability function (multiplication by  $\pi$  and subtraction by  $1/2\pi$ ) the arctangent function, which function is the only geometrically consistent alternative for the hyperbolic tangent as response function. The Cauchy probability function is defined by a ratio of logarithmic stimuli for responses to double-elliptic stimuli with respect to the adaptation-level stimulus. Thus also the arctangent function can apply to weighted Fechner-Helson sensations with the adaptation level as a meaningful translation point and twice the inverse of the adaptation-level value as dimensional sensation weight, which again defines a flat Bower space of comparable sensations. So the arctangent function for transformations of comparable sensations to responses describes a deterministic transformation of a comparable Euclidean or Minkowskian sensation space to a single-elliptic response space.

In section 3.2.1. we proved that a flat sensation space is consistent with a double-elliptic geometry for the stimulus space, where its elliptic curvature depends on the r-metric of the flat sensation space, where its curvature is defined by  $\zeta = r/2$ . If the response probability function is the cumulative Cauchy probability function then the arctangent function transforms the same flat sensation space to a single-elliptic response space, whereby it also defines a quasi-elliptic space involution of double-elliptic stimulus space to a single-elliptic response space. It means that also the curvature of the single-elliptic response space is determined by curvature  $\zeta = r/2$  for r as r-metric of the sensation space. As the projection analogy of latitudes on half the globe for figure 23 by the projection function of figure 24 indicates for flat sensation planes, circular iso-distant response contours also are obtained by its tangent transformation as the radial projection of a hemispherical response space onto a Euclidean sensation plane, provided that the arctangent is the response function for a flat sensation plane. If a sensation plane is Minkowskian then radius p of the corresponding response hemisphere and, thus, its elliptic curvature  $\zeta$  depends on the r-metric of the sensation space by  $\zeta = 2/r$ , as shown in chapter 3 for their projective relationship. However, the inverse transformation by the tangent function of single-elliptic response spaces only applies to curvature-corrected response spaces with a unit radius, which then specifies a Euclidean sensation space also if the single-elliptic response space would generate from a Minkowskian sensation space.

If the response space is a single-elliptic space then it also is an individual elliptic projectivity of a double-elliptic stimulus surface onto itself. The elliptic projectivity from stimuli to responses (as logarithmic transformed, double-elliptic stimuli to a flat sensation plane and from arc tangent-transformed sensations to single-elliptic responses) is with respect the individual adaptation point as a polar reference point in the stimulus and response spaces. The elliptic projectivity of points on circles of the double-elliptic stimulus surface with respect to a polar unit point onto the half circles of its single-elliptic response surface can be regarded as a quasi-elliptic space involution (noelliptic involution exists mathematically). That quasi-elliptic space involution is exactly what is implied by the Fechner-Helson function for the transformation of double-elliptic stimulus to flat sensation spaces and the arc tangent transformation of these sensation spaces to single-elliptic response spaces. The multidimensional dissimilarity analysis by elliptic distances as dissimilarities, described for the first time by Van de Geer (1970), could indeed be an appropriate analysis method of single-elliptic response spaces. Although Van de Geer distinguished not between response and sensation spaces, the solved elliptic space from dissimilarities as cosines of scaled distances should be identified as an individual, single-elliptic response space. Generally individual response spaces contain different object representations, because open response spaces are individually different transformations of the common Euclidean object space if their adaptation points are different. The common Euclidean object space is to be derived from individually translated and weighted sensation spaces that are obtained from inverse response transformations of solved individual response spaces by an appropriate data analysis.

#### 4.2.2. Three permissible involutions geometries of the response space

Besides the theoretical possibility of arctangent transformations of flat sensation spaces to single-elliptic response spaces, we originally derived the hyperbolic tangent function for the transformation of sensations to responses in section 2.2.1. With reference to chapter 3 it may concern the hyperbolic tangent transformation of a hyperbolic or a flat (Euclidean or Minkowskian) sensation space. Firstly, we discuss the hyperbolic tangent transformation of a hyperbolic sensation space that derives from a Euclidean stimulus space (section 3.2.2). The revolution of hyperbolic curves in figure 25 or 26 constitutes a hyperbolic surface that by the hyperbolic tangent transformation becomes stereographically projected on a circularly limited flat disc. Since the rotation invariance of the hyperbolic surface also holds for its projection, the interior of the open projection disc has a Euclidean distance metric. The central axis of the Euclidean co-ordinate system for the hyperbolic sensation surface is perpendicular to its open projection disc and intersects the hyperbolic surface at its origin as adaptation point that also corresponds to the origin of the circular-open response disc. It will be noticed that the asymptotes of hyperbolic curves define the limit circle for the open projection disc. That circle thus represents infinities of the hyperbolic sensation surface. The interior of the circularly open-Euclidean disc describes the so-called Poincaré model of the hyperbolic surface, wherein points or distances in the response disc are projections of points or curved line segments as hyperbolic distances on the hyperbolic sensation surfaces. Infinite curvilinear lines on a hyperbolic surface are represented by straight chords of the circle for the Poincaré model, where the boundary circle corresponds to infinities of the hyperbolic surface. In the Poincaré model a distance between points on a hyperbolic surface becomes a function of a line segment on the chord of projected points within the disc. The Poincaré model is illustrated in figure 28 by chord endpoints P and Q on a circle for a chord through some interior points A and B.

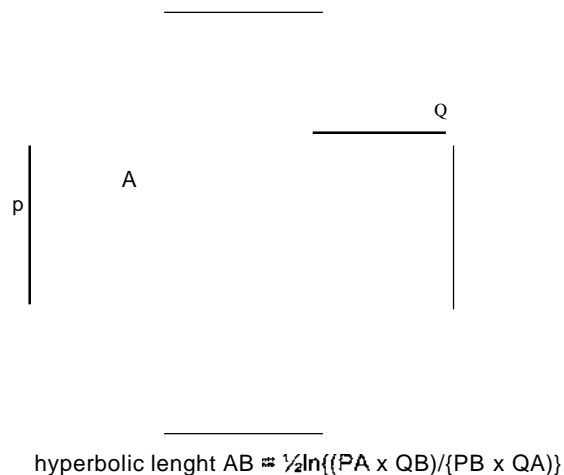

Figure 28. The Poincaré model for the interior of a circular response disc.



The distance between A and B corresponds to a hyperbolic distance **AB** (that is the length of the shortest curved line between corresponding points A and B on a hyperbolic surface), which hyperbolic distance becomes a function of the length of the four line segments PA, PB, QA, and QB on chord PQ. The distance **AB** on the hyperbolic surface with unit curvature is given by  $\frac{1}{2} \ln \left\{ \frac{PA \cdot QB}{PB \cdot QA} \right\}$ . If we take points A and B on a chord through the centre of the circle with unit radius, then we have for points A and B at equal distances r from the centre the distances PA = QB = I - r and PB = QA = I + r. Half the length of AB as distance to the centre corresponds to a hyperbolic distance from its origin, which hyperbolic distance is then expressed by

$$\frac{1}{4} \ln \left[ \frac{(1-r)^2}{(1+r)^2} \right] = \frac{1}{2} \ln \left\{ \frac{(1-r)}{(1+r)} \right\}.$$

Equal distances of points from the centre in the disc of figure 28 are circles and so they are correspondingly on the hyperbolic surface. The above expression defines the negative value for inverse hyperbolic tangent function of r. Taking a hyperbolic length  $\frac{1}{2} s$  from its origin, we have

$$-\frac{1}{2} s = \frac{1}{2} \ln \left[ \frac{(1+r)}{(1-r)} \right] = \operatorname{ar} \tanh(r)$$

This definition of the inverse hyperbolic tangent function as  $-\frac{1}{2} s = \operatorname{ar} \tanh(r)$  shows that hyperbolic projectivities are reflections. So the hyperbolic tangent function of distances  $\frac{1}{2} s$  from the centre in the hyperbolic sensation space creates the Poincaré model of the response space and the inverse hyperbolic tangent function of Euclidean distances in the Poincaré response space specifies the hyperbolic geometry of the sensation space. Moreover, if we take a sensation vector value  $-\frac{1}{2} s$  then by the Fechnerian psychophysical function it represents half the logarithmic stimulus value  $I/x$  and by substitution we obtain

$$-\frac{1}{2} s = \frac{1}{2} \ln(I/x) = \frac{1}{2} \ln \left\{ \frac{(1+r)}{(1-r)} \right\} = \operatorname{ar} \tanh(r)$$

and thus

$$x = \frac{(1-r)}{(1+r)} \text{ for } -1 < r < 1$$

or

$$r = \frac{(1-x)}{(1+x)} \text{ for } x \geq 0.$$

*This is the involution expression of stimulus intensity x with respect to the stimulus intensity of unity for the judgmental response r.*

This involution transformation from the Euclidean stimulus plane to the interior of the circular response disc constitutes a geometric projectivity of the stimulus plane onto itself with respect to the unit point in the Euclidean stimulus plane. Its finite projection disc with a limiting boundary, here with  $|r| < 1$ , is a so-called open geometry. From the generalisation to more dimensions we see that open response spaces are involutions of infinite stimulus spaces with respect to individual unit points as projection centre. The inverse transformation  $x = \frac{(1-r)}{(1+r)}$  for solved response space values  $-1 < r < 1$  of individuals (from analyses of data representations in individual response spaces), directly transforms the open response space into an infinite, positive stimulus space. If the sensation space is hyperbolic and the stimulus space Euclidean then the involution  $r = \frac{(1-x)}{(1+x)}$  transforms Euclidean stimulus vectors with respect to a unit point to other points on these Euclidean stimulus vectors themselves as its open response vectors (and vice versa for the inverse transformation).

Mathematically it is a hyperbolic involution of a Euclidean space, but we will call this transformation a Euclidean space involution. For stimulus fraction  $x/b$  with adaptation point  $x/b = 1$ , instead of unit-dependent stimulus ratio scale  $x/\mu$ , it will be clear from the Euclidean space involution of stimulus fraction plane that there correspond:

- a zero response to the stimulus adaptation-level  $x/b = 1$ ;
- one response point  $r = 1$  to zero intensity of the stimulus space origin;
- an opposite half response circle with points  $r = -1$  to infinite stimulus intensities of the positive stimulus plane.

So the Euclidean space involution, as hyperbolic transformation, defines a reflection.

In the multidimensional Euclidean stimulus fraction spaces we take the adaptation space point as rotation and transformation centre for the stimulus dimensions  $x_k/b_k$  that have unity-valued points as dimensional adaptation points that define the central origin of open-Euclidean response spaces. It not only is the origin of the individual response space and the individual reference point for the Euclidean involution of the stimulus fraction space, but also corresponds to the adaptation point as origin of its hyperbolic sensation space. If the sensation space is flat, instead of hyperbolic, then the hyperbolic tangent transformation of sensation spaces implies the hyperbolic involution of hyperbolic stimulus vectors to open-hyperbolic response vectors with respect to a defined unit stimulus space point. It then constitutes an involution of an infinite hyperbolic stimulus space onto itself as an open-hyperbolic response space (instead of the open-Euclidean space as Poincare model for hyperbolic sensations). We call this involution a hyperbolic space involution. For this hyperbolic space involution also  $\tanh(1/2 s_i) = r_i$  applies and, thus, also  $1/2 s_i = 1/2 \ln[(1 - r_i)/(1 + r_i)]$  holds, but here  $s_i$  are Euclidean (or Minkowskian) sensations that are generated from a hyperbolic stimulus space of stimuli  $x_i/b_i$ , as discussed in section 3.2.1. Since the Fechner-Helson function  $s_i = \ln(x_i/b_i)$  applies to

$$\begin{aligned} s_i^{\text{hyperbolic}} &= \ln[x_i/b_i]_{\text{Euclidean}} \\ \text{as well as to } s_i^{\text{Euclidean}} &= \ln[x_i/b_i]_{\text{hyperbolic}}, \end{aligned}$$

the hyperbolic space involution  $r_i = (1 - x_i/b_i)/(1 + x_i/b_i)$  for the last case must be a mapping of open-hyperbolic response vectors onto hyperbolic stimulus vectors themselves. Consequently the geometry of its response space must indeed be the open-hyperbolic geometry (instead of open-Euclidean, as it is for the former case). If we want to represent the common object space of hyperbolic stimulus space as a Euclidean space, then here we have to take it as a common Fechner sensation space, because open-hyperbolic response spaces with negative unit curvature are hyperbolic tangent transformations of comparable, Euclidean sensation spaces.

Combining the above two possibilities and the one of the preceding section, there are three permissible stimulus geometries (hyperbolic, double-elliptic, and Euclidean) with three theoretically possible space involutions to response spaces with corresponding, open geometries (open-hyperbolic, single-elliptic, and open-Euclidean):

- I: we have a common Euclidean space of stimuli  $x_i/\mu_i$  with individually translated and weighted, hyperbolic spaces of comparable sensations  $s_i = 2(y_i/a_i - 1) = 2[\ln(x_i/b_i)]/a_i$  and an individual space for responses  $r_i$  as the response space with an 'open-Euclidean geometry. Its *Euclidean space involution* is summarised by:

$$\begin{aligned} & r_i(\text{open-Euclidean}) = [1 - (x_i/b)^{2/a}] / [1 + (x_i/b)^{2/a}] \quad x(\text{Euclidean}) \\ \text{based on } & \left. \begin{aligned} & s_i = 2(y_i - a)/a, \tanh[1/2s_i] = r_i, \text{ and } \ln(x_i/b) = y_i - a \end{aligned} \right\} \begin{aligned} & |r_i| < 1 \\ & y(\text{hyperbolic}) \end{aligned} \end{aligned}$$

whereby  $\tanh(\dots) = 1/2s_i$  defines hyperbolic sensations for scaled responses of an open-Euclidean response space with unit boundary

II: we have (referring to the mathematical section in the preceding section) a theoretically possible double-elliptic space of finite stimulus values  $x/b$  with a space of comparable sensations  $s_i = 2(y_i - a)/a$  as an individually translated and weighted space of the common Euclidean (or Minkowskian) object space of Fechner sensations  $y_i$  and an individual single-elliptic space of responses  $r_i$ . This transformation from double- to single-elliptic spaces is an elliptic projectivity of a double-elliptic space onto its own single-elliptic part with respect to the common pole as a quasi-elliptic space involution (no elliptic involution exists). This *quasi-elliptic space involution* is described by:

$$\begin{aligned} & r_i(\text{single-elliptic}) = \arctan [2\ln(x_i/b)/a] \quad \left. \begin{aligned} & x(\text{double-elliptic}) \\ & |r_i| < 1/2\pi \end{aligned} \right\} \\ \text{based on } & \left. \begin{aligned} & s_i = 2(y_i - a)/a, \arctan[s_i] = r_i, \text{ and } \ln(x_i/b) = y_i - a \end{aligned} \right\} \begin{aligned} & y(\text{Minkowskian}) \end{aligned} \end{aligned}$$

where  $\tan(r_i) = s_i$  for scaled responses with unit curvatures defines the metric of the sensation space to be Euclidean.

III: we have a hyperbolic space of stimuli  $x/b$  (hyperbolic) with again an individual space of sensations  $2(y_i - a)/a$  as an individually translated and weighted space of the common Euclidean (or Minkowskian) object space of Fechner sensations  $y_i$  and an individual response space of responses  $r_i$  with an open-hyperbolic geometry. The *hyperbolic space involution* is defined by:

$$\begin{aligned} & r_i(\text{open-hyperbolic}) = [1 - (x_i/b)^{2/a}] / [1 + (x_i/b)^{2/a}] \quad x(\text{hyperbolic}) \\ \text{based on } & \left. \begin{aligned} & s_i = 2(y_i - a)/a, \tanh[-1/2s_i] = r_i, \text{ and } \ln(x_i/b) = y_i - a \end{aligned} \right\} \begin{aligned} & |r_i| < 1 \\ & y(\text{Minkowskian}) \end{aligned} \end{aligned}$$

where  $\tanh(-r_i) = 1/2s_i$  defines Euclidean sensations for scaled responses of an open response space with negative unit curvature.

The three involution geometries of the open response spaces have distance metrics that are conformal to the distance metric of their corresponding stimulus space. In the common Fechner sensation plane of figure 23, the iso-distant response contours show how these involutions describe an "egocentric" contraction of sensation vectors with the individual adaptation point as contraction centre. Figure 22, wherein individual iso-distant response contours are represented in the Euclidean stimulus space, illustrates how the concentric iso-distant response circles in the hyperbolic Bower space with the adaptation point as origin become asymmetrically transformed in the Euclidean stimulus plane. Stimulus intensities  $x/b \geq 1$  are transformed to responses  $-1 < r_i \leq 0$  (in open-hyperbolic or open-Euclidean response spaces) or to responses  $0 \leq r_i < 1/2\pi$  (in single-elliptic response spaces) and intensities  $0 < x/b \leq 1$  to responses  $0 \leq r_i < 1$  (in open-hyperbolic or open-Euclidean response spaces) or to responses  $-1/2\pi < r_i \leq 0$  (in single-elliptic response spaces).

For an infinite Euclidean stimulus plane the individual response plane is not an infinite Euclidean plane, but a circularly open projection disc by Euclidean space involutions of that infinite Euclidean plane with respect to the unity-valued adaptation point. Similar matters hold for the space involutions of non-Euclidean stimulus surfaces, where a circularly open-hyperbolic or single-elliptic surface represents the response surface. The multidimensional generalisation to involution spaces defines open response spaces that are limited to the interior of a (hyper)sphere as outer boundary of the open response spaces with a Euclidean, or hyperbolic, or elliptic distance metric for its interior. Although hard to imagine for more space dimensions, this Euclidean or non-Euclidean interior can be of any dimensionality and has the same dimensionality as the Euclidean, or hyperbolic, or double-elliptic stimulus space. All possible responses are located inside the (hyper-)spherical boundaries of open response spaces with a Euclidean or non-Euclidean distance metric. That boundary represents the limiting points corresponding to infinite hyperbolic or flat sensations. Its centres represent the zero response to individual adaptation points and its response interior the responses to weighted sensations with dimensional weights as twice the inverse of the dimensional distances of the projected adaptation point  $\ln(b/u)=a$  to  $\ln(u/\mu)=0$  as just noticeable sensation and origin in the Fechner sensation space. If the stimulus space is non-Euclidean then the common Euclidean object space is a Fechner sensation space that is transformed by individually different translations and dimensional dilations to individual spaces of intensity-comparable sensations, else the common Euclidean object space is the stimulus space that becomes individually transformed to subjective stimulus fraction spaces by dimensional power exponents as twice the inverse values of the dimensional adaptation points in the hyperbolic Fechner sensation space.

For a common Euclidean stimulus plane with different individual adaptation points the individual hyperbolic sensations are different, because defined by differences from their adaptation points in the hyperbolic sensation space that is also dimensionally weighted by twice the inverse of dimensional values of these adaptation points. The stereographic projection of individual hyperbolic surfaces onto individual Poincare response discs or interiors of open-Euclidean response spaces represents the distance between the same objective stimuli as individually different distances between responses in the interior of different open-Euclidean response spaces. These open-Euclidean response spaces are individually different involutions with respect to differently located individual adaptation points in the common Euclidean stimulus space. From the comparison of figures 23 and 22, it is seen that the iso-distant response contours in the Euclidean stimulus space (or the objective attribute space for the Euclidean representations of cognitive objects) are asymmetrical contours with respect to the adaptation point, but in the corresponding hyperbolic space of comparable sensations as well as in the open-Euclidean involution space of responses these iso-distant contours are circles. In stimulus fraction spaces with individual unit points the iso-distant response space circles become asymmetrically reflected contours with respect to the unit space point as adaptation point, where the asymmetry derives from the exponential transformation of the iso-distant circles in the weighted hyperbolic sensation space, while these circles are stereographic projected as iso-distant circles in an open-Euclidean response space. Similar matters hold for the corresponding

transformations of non-Euclidean stimulus surfaces with flat sensation spaces into circular open response surfaces with an open-hyperbolic or single-elliptic geometry. In these latter cases the derivable, common Euclidean object space is the Fechner sensation space as matched space configurations of individually translated, weighted, and rotated Euclidean spaces that derive from the inverse response transformation of solved, individual response spaces that are scaled to unit curvature spaces. Each individual response space is a different transformation of the same stimulus space, because every individual transforms the objective stimulus space (Euclidean or open-Euclidean) differently into circularly open, "ego-centred" response spaces with the corresponding distance metric of its stimulus space.

The dimensionality of the stimulus space, the sensation space, and the involution space of responses remains the same. Only a Euclidean co-ordinate embedding of non-Euclidean spaces asks for one additional dimension. Lines that don't contain the adaptation point in non-Euclidean (lines on elliptic- or hyperbolic-curved surfaces) or Euclidean stimulus spaces not only become curves on the respectively flat or hyperbolic sensation surface, but also are curve segments on corresponding involution surfaces of open response spaces. Only stimulus space lines through the adaptation point are straight lines on the hyperbolic sensation surfaces or in flat sensation spaces and remain straight line segments on the hyperbolic, or elliptic, or flat involution surfaces of the open response space. Therefore, the line segments of non-dimensional response space distances become represented in sensation and stimulus spaces by curve segments, while the rank order of response space distances differs in a non-monotone way from the rank order of corresponding distances in sensation and stimulus spaces. Dissimilarity judgements should not be identified as distances in the sensation or stimulus space, but as distances in open response spaces. Since observed dissimilarity rank orders are represented by rank orders of distances in individually different open involution spaces, we can't analyse these dissimilarities directly as sensation or stimulus space distances. Distances in open-Euclidean, open-hyperbolic, or single-elliptic spaces satisfy the axiomatic conditions of non-negativity, symmetry and triangular inequality (Busemann, 1950a) that are required for representations of transitively ordered dissimilarities as space distances. In the sequel we derive from sets of individual dissimilarities as distances in individually different response spaces with a given involution geometry, the underlying common Euclidean object space with location parameters of individual adaptation points that determine individual sensation space origins and the dimensional weights of intensity-comparable sensation spaces.

#### 4.3. Common object **and individual** response spaces

Although single-elliptic or open-hyperbolic response spaces with a curvature that is not unity are generated from sensation spaces with a Minkowski  $r$ -metric of  $r \neq 1$ , the dissimilarity distances in these response spaces must always be scaled to distances in open response spaces with unit curvature in order to transform them by their inverse response function to comparable sensation spaces. Therefore, their response-derived, comparable sensation spaces are always Euclidean. The inverse hyperbolic tangent function (according to section 2.1.3.) of scaled responses transforms open-Euclidean

open-hyperbolic response spaces to respectively hyperbolic spaces with a curvature of minus unity or Euclidean spaces of comparable sensations, while the tangent function (according to section 4.2.1) of scaled responses transforms single-elliptic response spaces to Euclidean spaces of comparable sensations. Thus the underlying common Euclidean object space is a sensation reference space that derives from the so-called Procrustes matching (Gower, 1975) of individual Bower spaces with Euclidean spaces  $s_{jk} = y_{jk}/a_{jk} - 1$  by individual rotation, weighing, and translation of dimensions. The underlying common Euclidean object space is the stimulus reference space if the individual Bower sensation spaces are hyperbolic, where the exponential transformation of a common hyperbolic Fechner sensation space (derived from similarly matched, hyperbolic Bower spaces of individuals) defines the Euclidean stimulus reference space. Each individual response configuration is an individually different transformation of the object configuration in the common Euclidean object space, due to individually different, adaptation-level-dependent, translation and weight parameters in the transformation. These individual parameters derive from the space matching of the intensity-comparable sensation spaces to a common Euclidean or hyperbolic space of Fechner sensations. Crucial for the analysis is the geometry of the open response space and the acknowledgement that dissimilarities are distances between responses to comparable sensations in the Bower spaces of individually weighted and translated Fechner sensation dimensions  $s_{jk} = 2(y_{jk} - a_{jk})/a_{jk}$ , assuming here no individually shifting adaptation levels. The geometry of the open response defines how response distances must be analysed and what kind of transformation of solved response spaces is needed in order to solve the individual parameters and the common Euclidean object space as stimulus or Fechner sensation space,

The geometric correspondence between Euclidean representations of elliptic and hyperbolic spaces leads to an analysis of dissimilarities as scaled hyperbolic distances in open-hyperbolic spaces that is similar to the analyses of dissimilarities as scaled elliptic distances in single-elliptic response spaces. But their dissimilarities analyses differ from existing Euclidean MDS-analyses. Only the object configuration in an open-Euclidean response space of an individual may be correctly solved by an existing Euclidean MDS-analysis of dissimilarities. The individually different response spaces (either as quasi-elliptic or hyperbolic or Euclidean space involutions of respectively different stimulus space geometries) are related by their corresponding inverse involution transformations to a common Euclidean or non-Euclidean stimulus or object space. We assume that such a common reference space for cognitive objects exists, although this can be questioned for individuals from cultures with differently learned connotations of cognitive objects. If different individual response spaces are related to a common Euclidean object space then we can solve the individual parameters from the Procrustes matching (Gower, 1975) of individually different, comparable sensation spaces. In case of (quasi-)space involutions of double-elliptic or hyperbolic object spaces to open response spaces, the common Euclidean object space is a Fechnerian sensation space. If the stimulus space is Euclidean then its Euclidean space involution defines that a Euclidean distance metric applies to their open response spaces, while then also the common Euclidean object space is the stimulus reference space or the attribute space of cognitive objects.

#### 4.3.1. *The applicability of existing MDS-analyses*

The existing non-metric analysis of (dis)similarity rank orders by multidimensional scaling (MDS) techniques (see overview books: Shepard et al. 1972; Krzanowski, 1988, Cox and Cox, 1994; Borg and Groenen, 1997) or by modern stochastic MDS-versions (Ashby, 1992a), allow not that the transformations of object configurations in stimulus or sensation spaces to response space configurations are individually different projection transformations. These methods also generally assume Euclidean or Minkowskian spaces of evaluated objects that have identical object configurations for individuals. Only dissimilarity analyses by individual difference MDS (originally developed as the IDIOSCAL method by Carroll and Chang, 1972) allow for object distances in an individually weighted Euclidean spaces. Although individual dimension weights then define individually different sensation spaces, it is not recognised that individually different translations to their adaptation points define different projection origins for their transformation to individually different, open response spaces. Individual difference MDS-analyses correctly assume individually modified object configurations by individually weighted sensation dimensions, but incorrectly assume identical rank orders of response space distances and weighted sensation space distances. However, relatively small response distances that are remote from the response space origin correspond to relatively large distances in weighted sensation spaces, while the rank order of response space distances in the proximity of the response space becomes hardly changed for corresponding distances in weighted sensation spaces. Thus, even if the sensation space is not hyperbolic then also individual difference MDS-analyses may not recover the correct object configuration in a common Euclidean sensation space.

The dissimilarity analyses as non-Euclidean space distances by Van de Geer (1970), Lindman and Caelli, (1978), Drösler (1979), and Indow (1982), as well as the spherical distance model for similarities as mutual Euclidean vector projections relative to vector length (Ekman, 1965; Eisler and Roskam, 1977), are rare exceptions with respect to the usual Euclidean or Minkowskian MDS-analyses. Besides their possibly correct identification of an elliptic or hyperbolic distance metric for response space distances as dissimilarity representations, also these methods assume that the object configuration in the analysed, non-Euclidean space is common to all individuals. However, dissimilarities as evaluations of comparable sensations of object pairs are individually different response space distances that can have different rank orders than the distances between corresponding points in their individually weighted sensation spaces. If the individual adaptation points are different, then the corresponding weighing and translations define individually different response transformations of the object configuration to individually different, open response spaces. Any open response space (with an open-Euclidean, or open-hyperbolic, or a single-elliptic geometry) represents an individually different transformation of the common Euclidean object space as stimulus or as sensation space. The common object space can only be solved by inverse transformations of the response spaces if we also solve the individually dimensional rotations and weights (defining also their translations) for comparable sensation spaces that are transformed to individual response spaces with different object configurations. This should govern the construction of the proper MDS-analysis

of individual (dis)similarities and its interpretation. Response spaces that are inversely transformed to Euclidean or hyperbolic sensation spaces imply individual sensation spaces with different dimension weights that equal twice the inverse of dimensional adaptation point values in the common Euclidean or hyperbolic sensation space that can be solved from the matching of individual sensation spaces under rotations, dimensional dilations, and translations to a common reference sensation space, where the dimensional weights also define the translations to adaptation points.

If Euclidean space involutions describe the individual response spaces then there is nothing wrong with a Euclidean MDS-analysis of individual dissimilarities as response distances with a Euclidean metric. What is wrong is the assumption of an infinite Euclidean space for distances as dissimilarities. Without the inverse response transformations of individual, open-Euclidean response spaces to a common Euclidean object space (in this case the inverse involutions with respect to individual adaptation points of open-Euclidean response spaces to the Euclidean stimulus space) wrong inferences may be made, even for the data analysis of one individual. The analysis of individual sets of (dis)similarities as elliptic or hyperbolic distances (Van de Geer, 1970; Lindman and Caelli, 1978; Dröslér, 1979; Indow, 1982) of the appropriately scaled proximity matrix (the cosine or hyperbolic cosine of distances that in rank order terms optimally correspond to the set of (dis)similarity judgements) may also not avoid such partially wrong interpretations, if the response space is single-elliptic or open-hyperbolic. If individuals have fixed, but different adaptation points then the application of Euclidean or non-Euclidean multidimensional scaling techniques to aggregated (dis)similarities obtained from several individuals simultaneously always is inappropriate for any response geometry. Analyses of aggregated dissimilarities acknowledge not the locally different transformations of the common object distances in each type of response space for different individuals. Each of the permissible response geometries (either single-elliptic, or open-hyperbolic, or open-Euclidean) is an individually different projective transformation from individually different projection origins of differently weighted sensation spaces. It generally causes the dissimilarity rank order as ordered response space distances between objects to be different for different individuals, unless individuals have the same space adaptation point. Thus, if aggregated (dis)similarities from different individuals are analysed by MDS-analysis techniques one may run into problems. The individual differences of response distances between identical objects depend on the differences in location parameters of the individual adaptation points, because comparable sensation dimensions of the Bower space not only are weighted by twice the inverse of dimensional adaptation point values of individuals, but also the projections of their Bower spaces to the response spaces depend on the adaptation points as projection origins. Although individually different space origins cancel out in the expressions of weighted sensation distances, distances in weighted sensation spaces and corresponding distances in response spaces have different rank orders, while differently weighted and translated sensation spaces also yield different response spaces.

Optimal scaling (Gifi, 1990) of individually ordered dissimilarities is a prerequisite for the analysis of individual dissimilarities. But such optimally scaled, individual dissimilarities still represent response space distances as scaled distances in



individually weighted sensation spaces, wherein the distance rank orders generally differ from individual response space distances. Since response distances are distances between individually different projection points of sensations that depend on individual projection origins and corresponding weight parameters of the common space of Fechner sensations, the optimal scaling must be based on predicted response distances in individually different response spaces and not on distances in a common or individually weighted sensation space. Problems may arise for any analysis of aggregated data of several individuals. An analysis of aggregated dissimilarities from several individuals must assume common distances in individual response spaces, which is not the case unless individuals have common adaptation points. Only inverse transformations of individually resolved different response spaces with unit radius to a common Euclidean sensation or stimulus space, may yield a common object space and the individual transformation parameters. For objects of a physical nature it will be accepted that a common object space exists. For objects of a cognitive nature such a common object space may not exist if the learning process in different subcultures of individuals leads to different concept formations. If so we may have serious solution problems, because we can only solve individual parameters by inverse transformations of response spaces to a common Euclidean object space.

#### *4.3.2. Common object space from individual open response spaces*

Appropriate analyses that solve the metric response co-ordinates for one of the alternative geometries from a set of ordered (dis)similarities per individual, describe individual response spaces. If for several individuals the (dis)similarities are individually analysed and their response space configurations solved for one of the three permissible geometries, then these response space configurations must be related to the common Euclidean object space in order to estimate the individual space transformation parameters. An appropriate analysis of (dis)similarities solves a coordinate system for objects in the response space for each individual. However, for their inverse response transformations to the common Euclidean object space we need the individual transformation parameters for the dimensional sensation weights and translations that are both determined by the dimensional adaptation point parameters. These adaptation point parameters can be iteratively solved from the initial solutions of individual object configurations in (single-elliptic, or open-Euclidean, or open-hyperbolic) response spaces of several individuals by inverse transformations of each individual response space to individually weighted and translated (hyperbolic or Euclidean) sensation spaces. Since individual response spaces may be described by co-ordinates that correspond to differently rotated space dimensions, we also need to determine individual rotation parameters for the matching of individual sensation spaces to a reference co-ordinate system for the common sensation space. By each of the proposed solution methods for either the single-elliptic geometry (mathematical subsections of section 4.3.2.1.) or the open-Euclidean or open-hyperbolic geometry (mathematical subsection of section 4.3.2.2.) of individual response spaces the common object space and these individual parameters are resolved. For optimally scaled dissimilarities the solution defines an appropriate MDS-analysis of the best fitting, common object space for all individual response spaces with one geometry of the three permissible response geometries. The proposed iteration procedure includes an

alternation of solution and scaling procedures. The co-ordinates of individual response spaces are solved from response distances that are initially approximated by scaled square-root transformations of dissimilarity rank orders that satisfy the maximum distance for the open geometry of the response space with unit radius. Secondly, the dimensional weight and rotation parameters (specifying also dimensional translations) of an individual are iteratively solved by matching of inversely transformed response spaces to a co-ordinate system for the common Euclidean object space. Thirdly, the initially scaled dissimilarity distances are optimally adjusted within the rank order constraints of the dissimilarities in such a way that individually predicted response space distances are minimally changed to distances that fit the rank order of individual dissimilarities. The three solution phases are repeated until convergence is obtained.

#### 4.3.2.1. Analysis of single-elliptic response spaces

If a response space has a single-elliptic geometry, then consequently the analysis of (dis)similarity responses has to be an analysis of distances on a single-elliptic surface. Distances on elliptic surfaces are measured by their length of arcs on the (hyper)spherical surface. Distances on spheres change proportional with their radius and scaled distances by the curvature as reciprocal radius define distances on a sphere with unit radius. The arc length between points on a hemisphere with unit radius as cosine of scaled response distances allow the representation of dissimilarities as elliptic distances and their corresponding object points on hemispheres to be described by so called homogeneous co-ordinate systems (Coxeter, 1957; Van de Geer, 1970) as the Euclidean embedding of hemispheres with their centres as Euclidean co-ordinate origins. This Euclidean embedding is  $(m+1)$ -dimensional, whereof  $m$  dimensions correspond to sine transformation of  $m$  (hyper-)hemispherical dimensions. The extra dimension is the cosine transformation of curved space vectors and has no other function than to represent the curved surface of the hemisphere. The principal component analysis of a matrix with cosines of response distances on a single-elliptic surface as scaled dissimilarities solves such a homogeneous co-ordinate system for that single-elliptic surface (Van de Geer, 1970). For distances between  $n$  object points that are exactly located on a  $m$ -dimensional single-elliptic surface the principal component analysis yields  $m+1$  positive and  $n-m+1$  zero eigenvalues (no negative eigenvalues). The comparable Euclidean sensation space that corresponds to the single-elliptic response space with unit radius is obtained by its radially projected response points to the  $m$ -dimensional Euclidean space. We iteratively derive by dilations of Euclidean vectors the dimensional weights for each individual from the analyses of several individual response spaces. We also determine their rotations to a common Euclidean object space of Fechner sensations by the so-called Procrustes procedure (Gower, 1975) for matching of Euclidean spaces. In the next mathematical section it is shown how that common Euclidean object space can iteratively be solved from optimally scaled dissimilarities as single-elliptic response distances of several individuals.

Following Van de Geer (1970) and referring to the relationship between a Euclidean sensation space and single-elliptic responses  $r$ , constraint to  $-r/2 < r_1 < r/2$ , we notice that by definition

$$\tan(|r_i - r_j|) = 1 + \frac{\tan[r_i] - \tan[r_j]}{\tan[r_i] \tan[r_j]} \quad (55a)$$

We always may scale the dissimilarity distances in such a way that its the response space differences satisfy  $-\frac{1}{2}\pi < [r_i - r_j] < \frac{1}{2}\pi$ , while according to (53f)  $\tan [r_i - r_j] = 2(y_i - y_j) / (1 + y_i y_j)$  for weighted sensation scales by  $2/a$  where individual adaptation points are defined by  $y_i = a$ . We can only use (55a) if a curvature factor  $\varphi = r/2$  for  $r$  as Minkowski metric of the sensation space corrects the radius  $p = 2/r$  the single-elliptic response space to a unit radius. Therefore, a scaled, curvature-corrected response space corresponds to a Euclidean sensation space, whereby

$$\tan(r_i - r_j) = \frac{s_i - s_j}{1 + s_i s_j} \quad (55b)$$

while for elliptic response distance  $\delta_{ij} = |r_i - r_j|$  we have

$$\cos(\delta_{ij}) = (1 + \tan^2\{[r_i - r_j]\})^{-1/2}, \quad (55c)$$

where we obtain by substitution of (55b) in (55c)

$$\cos(\delta_{ij}) = \frac{1 + s_i s_j}{\{(1 + s_i^2)(1 + s_j^2)\}^{1/2}} \quad (55d)$$

By generalising (55d) to distances from homogeneous co-ordinates  $1$  and  $k$  for points  $i$  and  $j$ , while adding a dimension with unit values (55d) is rewritten for initially scaled dissimilarity distances  $\delta_{ij} < \pi$  in terms of three Euclidean co-ordinates  $z_{ih} = 1$  and  $z_{il}$  and  $z_{ik}$  as co-ordinate projections of  $s_i = 2(y_i - a)$  on co-ordinates  $1$  and  $k$  by

$$\cos(\delta_{ij}) = \frac{z_{ih} z_{jh} + z_{il} z_{jl} + z_{ik} z_{jk}}{\{(Z_{ih} + Z_{il} + Z_{ik})(Z_{jh} + Z_{jl} + Z_{jk})\}^{1/2}} \quad (55e)$$

Let  $\delta_{ij} < \pi$  be scaled distances that fit the dissimilarity rank orders of individual  $J$  in order to represent the single-elliptic distances  $\delta_{ij}$  on hemispherical spaces with unit radius. Since the chosen scale factor defines the radius to be unity, such response spaces always correspond to Euclidean sensation spaces. Writing row vectors of co-ordinates point  $i$  for individual  $J$  as  $\mathbf{z}'_{jI} = (z_{ih} \quad z_{il} \quad z_{ik})$  we obtain in vector notation

$$\cos(e_{jIJ}) = (\mathbf{z}'_{jI} \mathbf{z}'_{jJ}) / \{(\mathbf{z}'_{jI} \mathbf{z}'_{jI}) \cdot (\mathbf{z}'_{jJ} \mathbf{z}'_{jJ})\}^{1/2} \quad (55f1)$$

Let  $C_J$  be the symmetric  $n \cdot n$  matrix of elements  $\cos(e_{jIJ})$  then we obtain by the  $m+1$  eigenvectors and eigenvalues of eigenvector matrix  $F$  and diagonal eigenvalue matrix  $\Omega_J^2$  of  $J$

$$C_J = F_J \Omega_J^2 F_J' \quad (55f2)$$

the principal components  $F_J \Omega_J$  as the Euclidean co-ordinates of the  $m$ -dimensional single-elliptic response space of individual  $J$ . By some rotation matrix  $G_J$  of these principal components corresponds to

$$F_J \Omega_J G_J = \mathbf{w}_J^{-1} \mathbf{z}_J \quad (55E3)$$

for matrix  $Z_J$  of rows  $z_{Ji}$  and diagonal matrix  $W_J^2$  with elements  $z_{Ji}' z_{Ji}$  or  $w_{Ji} = \sqrt{1 + s_{Ji}^2} = 1/\cos(r_{Ji})$ . As initial estimate we assume  $G_{Ji} = I_{Ji}$ , whereby the first principal component would contain (analogously to 44a) elements  $\sin(r_{Ji})$ . Thereby, initial values  $w_{Ji} = 1/\sqrt{1 - \sin^2(r_{Ji})}$  are obtained. Let  $S_J$  be the nom matrix of m sensation dimensions  $z_{Ji}$  (thus without  $z_{Jn}$  of the additional dimension with elements  $z_{Jn} = 1$ ),  $U_J$  the n-n matrix of unit elements and  $W_J$  the n-diagonal matrix with the initially estimated elements  $w_{Ji}$  then we rewrite  $C = W_J^{-1} U_J W_J^{-1}$  for initially given  $W_J$  as

$$W_J^{-1} U_J W_J^{-1} = W_J^{-1} S_J S_J' W_J^{-1} = K_J \Lambda_J^2 X_J' + E_J E_J' \quad (55g1)$$

where

$$W_J^2 = I + \text{diag}(S_J S_J') \quad (5592)$$

for  $K_J$  as eigenvector matrix with  $\Lambda_J^2$  as diagonal matrix of eigenvalues. The distinctively positive eigenvalues determine the dimensionality  $m$ . The rotated matrix  $S_J = W_J R_J H_J$  of the m principal components  $R_J = K_J \Lambda_J$  for iteratively to improve diagonal dilation matrix  $W_J$  determines by  $J$  solvable rotation matrix  $H_J$  an individually weighted, translated, and rotated common Euclidean sensation space  $Y$ . Thus, for diagonal matrix  $A_J$  with elements  $a_{Jk}$  of dimensional adaptation points  $a_{Jk}$  and a n-m matrix  $V$  with elements  $v_{Jik} = 2(y_{Jik}/a_{Jk} - 1)$  in matrix terms

$$Y A_J^{-1} = W_J R_J H_J + V \quad (56a1)$$

where  $Y$  is the common m-dimensional Fechner sensation space for a set of n objects and  $H_J$  an individual rotation matrix to a common co-ordinate system for that common Euclidean Fechner sensation space  $Y$ . By

$$\text{diag}\{s_{Ji} S_{Ji}'\} = W_J^2 - I \quad (56a2)$$

while

$$s_{Ji} = Y A_J^{-1} - V \quad (56a3)$$

we see that the matrices  $W_J$  and  $A_J$  determine each other when  $Y$  becomes solved. We iteratively solve  $H_J$  and  $A_J$ , and, thus, also improve  $W_J$  by a Procrustes matching of rotated spaces under dilation and translation. Taking the space of an arbitrary individual  $L$  as the reference space, where we take  $H_L = I$  and  $A_L = I$  for  $a_{Lk} = 1$ , it simplifies (56a1) for  $L$  to

$$Y = W_L R_L + Y \quad (56b1)$$

Combining (56a1) and (56b1) we have

$$W_L R_L + Y = W_J R_J H_J A_J + V A_J + E_J \quad (56b2)$$

The iterative solution of matrices  $H_J, A_J$  and  $W_J$  as  $H_{J,x}, A_{J,x}$ , and  $W_{J,x}$  (for  $H_L = I$  and  $A_L = I$ ) are obtained by defining

$$Q_{LJ,x} = [R_J' R_{J,x} R_J W_{J,x}^{-1} [W_{L,x} R_L + Y(I - A_{J,x})]] = H_{J,x+1} A_{J,x+1} \quad (56c1)$$

and taking for  $x = 0$  also  $A_{J,0} = I$ , while  $W_{L,0} = W_L$  and  $W_{J,0} = W_J$  as obtained for (55g1) and initially from (53f3) for  $G_J = I$ , we have

$$Q_{W,O} = [R' R J]^{-1} R' W^{-1} W_{J,O} R_L H_{J,A,J,1} + E_{J,1'} \quad (56c2)$$

whereby the eigenvector and eigenvalues of

$$Q_{LJ,x} Q'_{W,x} = H_{J,x+1} A_{J,x+1}^2 H'_{J,x+1} + E_{J,x} E'_{J,x} \quad (56c3)$$

solve  $H_{J,x+1}$  and  $A_{J,x+1}$  under minimised trace  $(E_{J,x} E'_{J,x})$ .

From (56b2) we next calculate

$$\text{where } S_{W,x} = (W_{L,x} R_L + V(I - A_{J,x+1})) A_{J,x+1}^{-1} \quad (56d1)$$

$$\dots_{J,x+1}^2 = \text{diag}\{S_{LJ,x} S'_{LJ,x}\} + I. \quad (56d2)$$

By (56b2) we also obtain

$$\text{where } S_{JL,x} = W_{J,x+1} R_H A_{J,x+1} + V(I + A_{J,x+1}) \quad (56d3)$$

$$\dots_{L,x+1}^2 = \text{diag}\{S_{JL,x} S'_{JL,x}\} + I \quad (56d4)$$

Repeating the iteration cycles of (56d1) to (56d4) until convergence of  $W_{J,x+1}$  and  $W_{L,x+1}$  and thereafter also of (56c1) and (56c3) for  $x=x+1$  until approximate convergence of  $W_J$ ,  $W_L$  and  $A_J$  we solve for each J the rotation matrix H for the matching to individual L under dependent dimensional dilations and translations with N-1 estimates of W. We take the average of these  $W_L$  matrices for each matching as  $W_L$  for subject L. Since we have taken the sensation space of individual L as the reference space with  $A_L = I$ , while each imperfectly matched space of the other individuals J are as relevant as reference space, we define after an approximate converge of the matched individual spaces the average of the matched spaces as reference space. With respect to this reference space  $Y_t$  defined for  $t=x$  by solved  $A_{J,t}$ ,  $W_{J,t}$ , and  $H_{J,t}$  as

$$Y_t = \left\{ \sum_{J=1}^{J=N} (W_{J,t} R_{J,t} H_{J,t} + V) A_{J,t} \right\} J/N, \quad (56e)$$

we restart the iteration by minimising trace  $\{E_{J,t} E'_{J,t}\}$  also for  $J=L$  with respect to  $Y_t$  in stead of  $Y$  in (56b1) for  $t=t+1$  until convergence, where  $W_t$  and  $A_t$  are the average diagonal matrices of  $W_{J,t}$  and  $A_{J,t}$ .

By the again solved matrices  $W_J$  we have first improved matrices  $W_L$  for the solutions of (5591), whereby the whole sequence from (56a) to (56e) is again repeated and so on until convergence of  $W_J$  becomes achieved. This solves the individual parameters that relate individual response spaces to the common Euclidean sensation space, provided that we have optimal scaled response distances as observed individual dissimilarities with values  $\delta_{Ji}$  in  $\cos(\delta_{Ji})$  of (55f) for elements of  $C_J$  in (55g1). Since observed dissimilarities of each individual J are only determined up to their rank order, the scaling of  $\delta_{Ji}$  can be optimised within that rank order constraint. This is achieved by computing

$$S_J = Y A_J^{-1} V, \quad (56f1)$$

and

$$W_J^{-1} (\hat{S}_J S'_J + U) W_J^{-1} = \hat{C}_J, \quad (56f2)$$

where elements  $c_{Jij}$  of matrix  $\hat{C}_J$  define by

$$\arccos [c_{Jij}^{\wedge}] = \hat{\delta}_{Jij} \tag{56f3}$$

individual elliptic response distances that perfectly fit the estimated common Euclidean sensation space. We then obtain by minimal changes of the estimated distances by (560) that fit the individual rank order of observed dissimilarities an improved scaling of distances  $OJ_{ij}$  in (55g1).

Repeating again the analyses from (5591) to (560) until no improved fit of response distances is obtained, determines the complete iteration procedure for an optimal scaling of the non-metric dissimilarities as distances in single-elliptic response spaces and individual iso-distant response contours in the solved, common Euclidean sensation space Y. If the stimulus values of independent object dimensions are known, then their logarithmic transformed stimulus dimensions define the Fechner space, which should be equal to the solved space Y after a translation, and rotation, because we arbitrarily took matrix  $A_L = I$  and  $Y_t = Y$ .

However, there is an ambiguity in the above described analysis. On the one hand we have for single-elliptic responses with unit curvature

$$\tan \left[ \frac{1}{2} (r_i - r_j) \right] = \frac{\tan \left( \frac{1}{2} r_i \right) - \tan \left( \frac{1}{2} r_j \right)}{1 + \tan \left( \frac{1}{2} r_i \right) \cdot \tan \left( \frac{1}{2} r_j \right)} = \frac{r_i - r_j}{1 + r_i \cdot r_j} \tag{57}$$

where  $r_i$  equal responses of the open-Euclidean response space that would be derived from a hyperbolic space of comparable sensations. But for a hyperbolic sensation space the proper response distances are given by  $\delta_{ij} = |r_i - r_j|$ , due to their open-Euclidean involution space. If  $\delta_{ij}$  is the proper response space distance then it could easily be mistaken for single-elliptic distance  $\delta_{ij}$  where  $\cos(\delta_{ij}) = \delta_{ij} \cdot \text{Eut} \cos(\delta_{ij})$  as improper elements of  $C_{ij}$  in (55f2) can yield for  $C_{ij}$  of (55g1) markedly negative eigenvalues.

If the sensation space is flat then we would correctly have for distances  $0 < r_i < 2$  of an open-hyperbolic response space that by  $i \cdot z_i = \tanh(r_i)$  and  $i \cdot z_i = \tanh(r_i)$  for  $i = \sqrt{-1}$  defines

$$\tanh(ij) = \tanh[ri - r_j] = \frac{\tanh(r_i) - \tanh(r_j)}{1 - \tanh(r_i) \cdot \tanh(r_j)} = \frac{i \cdot z_i - i \cdot z_j}{1 - z_i \cdot z_j} \tag{58a1}$$

By  $\cosh(\delta_{ij}) = 1/\sqrt{1 - \tanh^2(\delta_{ij})}$ , instead of (55c), we obtain for the hyperbolic response space distances

$$\cosh(ij) = \frac{1 + z_i z_j}{\{(1 - z_i^2)(1 - z_j^2)\}^{1/2}} \tag{58a2}$$

Expanding (58a2) as hyperbolic distances by its three-dimensional Euclidean co-ordinates  $z_{ih}, z_{il}, z_{ik}$  under addition of co-ordinate  $z_{ih} = 1$ , one obtains the same expression as for (55e) with the only difference that we have negative squared values, except for elements  $z_{ih} = z_{il} = 1$ , which is written as

$$\cosh(ij) = \frac{z_{ih} z_{jh} + z_{il} z_{jl} + z_{ik} z_{jk}}{\{(z_{ih}^2 - z_{il}^2 - z_{ik}^2)(z_{jh}^2 - z_{jl}^2 - z_{jk}^2)\}^{1/2}} \tag{58b}$$

Replacing  $\cos(\delta_{ij})$  by  $\cosh(\delta_{ij})$  as elements of  $C_j$  in (55f2) would solve a hyperbolic surface (Van de Geer, 1970). Only one eigenvalue then ought to be positive and all other eigenvalues negative or zero for proper scaled hyperbolic response distances  $\delta_{ij} < 2$ .

Thereby, the proper response geometries and distance scaling might be obtained by the inspection of eigenvalues. If a scaling of  $\delta_{ij} < \pi$  in  $\cos(\delta_{ij}) - \cos(r_{ij}) \cos(r'_{ij})$  as elements of (55g1) only yields markedly positive and almost zero eigenvalues, while about half smaller scaling yields significantly negative eigenvalues by (5591), then the former may concern a scaling of single-elliptic response distances. If still markedly negative eigenvalues follow from (5591) for relatively large scale factors of  $\delta_{ij}$ , then the response space is likely open-Euclidean or open-hyperbolic. If some scaling to  $\delta_{ij} < 2$  in  $\cosh(\delta_{ij})$  as elements of  $C_j$  in (55f2) yields one positive and markedly negative or almost zero eigenvalues then the response space may be open-hyperbolic.

In the mathematical section above we have shown how an iterative principal component analysis of matrices with elements  $\cos(\delta_{ij}) - \cos(r_{ij})\cos(r'_{ij})$  for scaled elliptic distances  $\delta_{ij} < \pi$  as dissimilarity representations in individual, single-elliptic response spaces with unit curvature solves by matching of individually weighted and translated spaces their common Euclidean sensation space from the dissimilarities of several individuals. The single-elliptic response space curvature must always be scaled to unity in order to enable the analysis, whereby only a Euclidean sensation space can be solved, even if its response spaces would derive from a Minkowskian sensation space with metric  $r \neq 2$ . The analysis with half the proper scale factor for scaled dissimilarity distances mistakes the stereographic projection to the open-Euclidean space for its single-elliptic response space, as illustrated by figure 26 and discussed at the end of section 4.1. The question is firstly whether the geometry of the derivable sensation space is Euclidean or hyperbolic and secondly, if Euclidean, what the correct scaling to unit curvature of the open response spaces is. These questions might be answered by the eigenvalue signs of the principal components in the proposed analyses of matrices with elements  $\cos(\delta_{ij}) - \cos(r_{ij})\cos(r'_{ij})$  for dissimilarity distances  $\delta_{ij} < \pi$  with different scaling factors. If all eigenvalues are markedly positive or almost zero and half that scaling to  $\delta_{ij} < \frac{1}{2}\pi$  causes markedly negative eigenvalues then the response space probably is single-elliptic. If markedly negative eigenvalues are obtained for relatively large scaling factors then the response space likely is not single-elliptic, but open-hyperbolic or open-Euclidean. It might explain why Van de Geer (1970), who analysed dissimilarity distances in the positive orthant of an elliptic space by scaling to  $\delta_{ij} < \frac{1}{2}\pi$  (instead to  $\delta_{ij} < \pi$ ), found mixtures of negative and positive eigenvalues for several object sets. It may indicate the response space is not single-elliptic.

#### 4.3.2.2. Analyses of open-Euclidean and open-hyperbolic response spaces

If the response space is open-Euclidean then the analysis solution starts with the metric Euclidean MDS-analyses (Torgerson, 1958) of initially scaled dissimilarity distances of individuals. By inverse response involutions the object locations in the common Euclidean stimulus space and the individual parameters are derived iteratively from the metric Euclidean MDS-analysis of several individual response spaces. If the response

space is open-hyperbolic then the stimulus space is hyperbolic and we solve a common Euclidean sensation space and individual parameters from open-hyperbolic response spaces of several individuals by an iterative principal component solution that is similar to the solution for single-elliptic response spaces, where then  $\cos(\delta_{Jij})$  is replaced by  $\cosh(d_{ij})$  for  $\delta_{Jij} < 2$  as open-hyperbolic response space distances.

We again define:  $m$  dimensions by indices  $\{1..h,k,l, ..m\}$

$N$  individuals by indices  $\{1..I,J, ..N\}$

$n$  stimuli or objects by indices  $\{1..i,j ..n\}$

Firstly, we consider the open-Euclidean space involution for responses, where the dimensional response co-ordinates are hyperbolic tangent transformations of the hyperbolic sensation dimensions in the Bower space of intensity-comparable sensations, where dimensional responses

$$r_{Jik} = \tanh\left(\frac{x_{ik}}{b_{Jk}}\right) = \tanh\left[\frac{y_{ik} - a_{Jk}}{a_{Jk}}\right] \quad (59a1)$$

defines by the inverse involution function of  $r$

$$z_{Jik} = \frac{x_{ik}/b_{Jk}}{1 - r_{Jik}} = \frac{y_{ik} - a_{Jk}}{a_{Jk}(1 - r_{Jik})} \quad (59a2)$$

since

$$r_{Jik} = [1 - z_{Jik}]/[1 + z_{Jik}] \quad (59a3)$$

describes dimensional responses as involution of Euclidean stimulus-fraction dimensions  $x_{ik}/b_{Jk}$  with power exponents  $2/a_{Jk}$ .

Let distances  $\delta_{Jij}$  be some distances that fit the dissimilarity rank-orders of individual  $J$  and satisfy  $0 < \delta_{Jij} < 2$ . then their metric Euclidean MOS-analysis (Torgerson, 1958, p. 258) in open-Euclidean response spaces derives from the principal component analysis of scalar products of object vectors from the centroid of object points for individual  $J$ , which product is written in Euclidean distance terms by

$$c_{Jij} = \frac{1}{2} \{ \delta_{Jj}^2 + \delta_{Ji}^2 - \delta_{Jj}^2 - \delta_{Jij}^2 \}, \quad (59b1)$$

for

$$\delta_{Jj}^2 = (1/n) \sum_{i=1}^{i=n} \delta_{Jif}^2 \quad (59b2)$$

and

$$\delta_{Ji}^2 = (1/n) \sum_{j=1}^{j=n} \delta_{Jij}^2, \quad (59b3)$$

where

$$\delta_{Jj}^2 = (1/n^2) \sum_{i=1}^{i=n} \sum_{f=1}^{f=n} \delta_{Jif}^2. \quad (59b4)$$

Let symmetric matrix  $C_J$  contain the elements  $c_{Jij}$  then its principal components  $Q_J = K_J \Delta_J$  from eigenvectors  $K_J$  and eigenvalues  $\Delta_J$  for

$$C_J = K_J \Delta_J^2 K_J', \quad (59c)$$

describe the response space by  $Q_J$  with a space centre at a location that probably is not the origin of the response space. The solution of the actual co-ordinate values  $r_{Jik}$  depends on an unknown co-ordinate values  $\lambda_{Jk}$  for the translated origin and on an unknown scale factor  $\eta_J$  that guarantees  $(q_{Jk} + \lambda_{Jk})/\eta_J$  to be a Euclidean involution space. It defines



$$(q_{Jik} + \lambda_{Jk})/\eta_{Jk} = r_{Jik} \tag{59d1}$$

We write for initial solved values  $q_{Jik}$  from (59c) and the iteratively to solve unknowns  $r_{Jik,x}, \lambda_{Jk,x}$  indexed for iteration index  $x$ , the next expressions that are derived from estimated  $r_{Jik}$  values by

$$q_{Jik} = r_{Jik,x} \eta_{J,x} + \lambda_{Jk,x} \tag{59d2}$$

$$r_{Jik,x} = (q_{Jik} + \lambda_{Jk,x})/\eta_{J,x} \tag{59d3}$$

where by (59a5) also

$$z_{Jik,x} = [1 - r_{Jik,x}] / [1 + r_{Jik,x}] \tag{59d4}$$

and by (59a4)

$$t_{Jik,x} = z_{Jik,x} \lambda_{Jk,x} = x_{ik,x} \lambda_{Jk,x} = \sum_{i=1}^{i=n} h_{Jil,x} x_{il,x} / b_{Jl,x} \tag{59d5}$$

for  $h_{Jil,x}$  as individual rotation parameters for stimulus dimensions  $l$ . A solution  $J_{il,x}$  is iteratively obtained by a multi-phased solution procedure. The procedure starts with  $q_{Jik} = r_{Jik}$  from (59c) for  $x=0$ , whereby  $z_{Jik,x} = [1 - q_{Jik}] / [1 + q_{Jik}]$ . These  $z_{Jik,x}$  values are by (59d5) used for the computation of the first estimated matrix  $T_{J,x} = X H_{J,x} B^{-1}$  for an individual rotation matrix  $H_{J,x}$ , an individual diagonal matrix  $B_{J,x}$  of elements  $b_{Jk,x}$ , and the common Euclidean stimulus space matrix  $X_{J,x}$ . In order to start iteration cycle  $x$  a second iteration cycle indexed by  $t$  solves  $H_{J,x,t}$  and  $B_{J,x,t}$  by taking for an arbitrarily individual  $l$   $b_{Jl,x} = \exp(2)$  or  $\lambda_{Jk,x} = 1$  and  $H = I$  as initial reference space, as well as by taking initially  $\lambda_{Jk,x} = 1$ , whereby  $T_{L,x} = Z_{L,x}$  and  $T_{J,x,0} = Z_{J,x}$ . So starting for  $t=0$  we have

$$X_{L,x} = T_{L,x} B_{L,x} \tag{60a1}$$

which should become equal to

$$X_{J,x,t} = T_{J,x,t} B_{J,x,t} H_{J,x,t} \tag{60a2}$$

We solve iteratively matrix  $B_{J,x,t}$  first with respect to the initial reference of individual  $L$  and solve simultaneously the rotation matrix  $H_{J,x,t}$  with respect to  $L$  from the expression that follows by combining (60a1) and (60a2) in defining

$$Q_{LJ,x,t} = [T_{J,x,t}^{-1} T_{L,x}^{-1} T_{J,x,t} T_{L,x}] \tag{603a}$$

we solve by the  $D$  eigenvectors and eigenvalues of

$$Q_{LJ,x,t} Q'_{LJ,x,t} = H_{J,x,t+1} B_{J,x,t+1}^2 H'_{J,x,t+1} \tag{60a4}$$

the matrices  $H_{J,x,t+1}$  and  $B_{J,x,t+1}$ . We continue the iteration by  $T_{J,x,t+1}$  of elements with improved exponent  $\lambda_{Jk,x,t+1} = \lambda_{Jk,x,t} \ln(b_{Jk,x,t})$  as

$$t_{Jik,x,t+1} = z_{Jik,x,t} \lambda_{Jk,x,t+1} \tag{60a5}$$

and repeat for  $t=t+1$  (60a3) to (60a5) until convergence. This analysis is performed for each individual except for reference individual  $L$ . Next we compute the average matrix  $X_x$  as

$$X_x = [(1/N) \sum_{J=1}^{J=N} \{T_{J,x} H_{J,x} B_{J,x}^{-1}\}] \tag{60b}$$

whereby estimated values of  $r_{Jik,x+1}$  for  $x+1=1$  are obtained from

$$\hat{r}_{Jik,x+1} = [1 - (\hat{x}_{ik,x} / b_{Jk,x})^{2/a} J_{J,x}] / [1 + (\hat{x}_{ik,x} / b_{Jk,x})^{2/a} J_{J,x}] \quad (60c)$$

With  $\hat{r}_{Jik,x+1}$  from (60c) and  $\hat{a}_{Jik}$  in (59f) the values of  $n_{J,x+1}$  and  $\lambda_{Jk,x+1}$  are solved by linear regression and by using them in (59d3) we obtain improved values  $r_{Jik,x+1}$  that by (59d4) then yields  $z_{Jik,x+1}$ . These improved values  $z_{Jik,x+1}$  are used for the computation of a further improved matrix  $X_{Jik,x+1}$  by the iterations from (60a) to (60b), which then gives again by (60c) and the here above described procedure improved values  $z_{Jik,x}$  for  $x=2$ . These sequences are repeated until convergence.

We may improve the fit of the solution by maximising the monotone regression between initially observed and predicted distances, where predicted distance are obtained from converged  $r_{Jik}$ -values in (60c) as

$$\hat{\delta}_{Jij}^2 = \sum_{k=1}^{k=m} [r_{Jik} - \hat{r}_{Jik}]^2 \quad (60d)$$

After this adjustment and renewed computation of (59c) to (60d) defines the last iteration cycle. Repeating the whole sequence of computations until convergence completes the solution. This multi-phased iteration procedure yields an optimal scaling for the analysis of non-metric dissimilarities as distances in individual response spaces with an open Euclidean geometry, solves the common Euclidean stimulus space with its individual power and scale parameters given by also solved values  $a_{Jk}$ .

In case of open-hyperbolic response spaces from hyperbolic stimuli we solve a common Euclidean sensation space with dimensional adaptation points that specify individual translation and weight parameters for the individually rotated dimensions. These individually translated, weighted and oriented dimensions of a Euclidean sensation space then relate to response distances in an open-hyperbolic involution space of individual responses. The solution starts with hyperbolic response distances  $\delta_{Jij}$  that are scaled to  $\delta_{Jij} < 2$  as scaled dissimilarity rank orders for each individual  $J$ . The open-hyperbolic response space of each individual  $J$ , as discussed at the mathematical subsection end of section 4.3.2.1., are solved by the principal components of matrices  $C_J$  with elements

$$\cosh(6_{Jij}) = 1/\sqrt{1 - \tanh^2(6_{Jij})} \quad c_{Jij}, \quad (61a)$$

as

$$C_J = F_J \Omega_J^2 F_J', \quad (61a2)$$

where

$$F_J \Omega_J G_J = T_J + E_J, \quad (61a3)$$

specifies here a rotation matrix  $G_J$  to the  $m+1$  dimensions with the elements  $t_{Ji1} = \cosh(r_{Ji1})$  for  $k=1$  and elements  $t_{Jik} = \sinh(r_{Ji1})$  for  $k>1$ . We start by taking initially  $G_J = I$  and obtain for  $k > 1$   $Jik$

$$\begin{aligned} \text{and} \quad \arcsinh\{t_{Jik}\} &= \ln[t_{Ji1}^k + \sqrt{t_{Ji1}^2 - 1}] = r_{Ji1}^k \\ 2[\arcsinh\{r_{Ji1}^k\}] &= \ln[(1 + r_{Ji1}^k)/1 - r_{Ji1}^k] = 2s_{Ji1}^k \end{aligned} \quad (61b)$$

as elements of matrices

$$S_{JJ} = Y A_J^{-1} - V \tag{61b2}$$

where diagonal matrix  $A_J$  and matrix  $V$  have the same definitions as for (56a) and where  $H_J$  is a rotation matrix that corresponds to  $G$ . By taking for an individual  $J$  initially  $A_L = I$  and  $H_L = I$  we have

$$S_L = Y - V \tag{61b3}$$

whereby

$$Q_{W,X} = C S_J^{-1} S_J^{-1} \{s_L + v[r - A_{J,X}]\} = s_{J,x+1} A_{J,x+1} \tag{61b4}$$

where for  $x = 0$  we take again  $A_{J,0} = I$  and solve by eigenvectors/values of

$$Q_{LJ,x} Q_{LJ,x} = H_{J,x+1} A_{J,x+1}^2 H_{J,x+1}' + E_{J,x} E_{J,x}' \tag{61b5}$$

$H_{J,x+1}$  and  $A_{J,x+1}$  underminimised trace  $(E_{J,x} E_{J,x}')$ . Repeating (61b4) and (61b5) for  $x+1$  leads to convergence of  $H_{J,x}$  and  $A_{J,x}$ . Doing so for all other individuals with respect to  $L$  and again averaging  $Y = S_L + V$  and  $Y$  for each other individual as  $Y = [S_H + V]A$  to  $y$ , we repeat the also for  $J = L$  the matching with  $Y$ , where by for each individual again matrices  $B$  and  $A$  are obtained.  $t$

Next we obtain  $S = [Y A - v] H_J$  and compute from  $\tanh(\frac{1}{2} s_{Jik}) = r_{Jik}$  the values  $\sinh(r_{Jik}) = t_{Jik}$  and obtain  $t_{Ji1} = \cosh(r_{Ji1})$  for  $k = 1$  by

$$t_{Ji1} = \sqrt{1 + \sum_{k=2}^{k=m} t_{Jik}^2} \tag{61c1}$$

and gathered as elements of matrix  $T_J$  we obtain the first improvement of rotation matrix  $G_J$  for (61a3) from  $F_J$  of (61a2) by the eigenvectors of

$$F_J' T_J T_J F_J = G_{J,02} G_J \tag{61c2}$$

and redefine  $T_J$  by  $F_J G_J$  from (61a2) as

$$F_J G_J = T_J \tag{61c3}$$

Repeating the process from (61b1) to (61c3) until convergence allows a more optimal dissimilarity scaling by minimal changes of the predicted values that fit the dissimilarity rank: orders, where predicted values are obtained for  $d_{Jij} = 1 + |t_{Ji1} - t_{Jj1}|$ , as

$$\hat{\delta}_{1J} = \arccosh(d_{Jij}^2) = \ln[d_{Jij} + \sqrt{d_{Jij}^2 - 1}] \tag{61d}$$

where after the whole process from (61a1) to (61d) is repeated until also the optimal scaling converges.

The above described Euclidean analyses are based on dissimilarity representations as individual response-space distances, either as  $\cosh(r_i'' - r_j'')$ , if the response space is open-hyperbolic, or as  $|r_i'' - r_j''|$ , if the response space is open-Euclidean, for response function  $\tanh(Y/2S) = r_i''$  of comparable sensations  $s_i'' = 2(y_i/a - 1)$ . Configurations in open-Euclidean response spaces of each individual can be solved by metric MDS-analysis (Torgerson, 1958) of scaled dissimilarity distances  $0 < |r_{Ji} - r_{Jj}| < 2$ , while principal component analyses of matrices with elements  $1 < \cosh(r_{Ji} - r_{Jj}) < \cosh(2)$

solve the open-hyperbolic response configurations of individuals. The iterative solution procedures solve the relationships between open-Euclidean response configurations and the common Euclidean stimulus space or between open-hyperbolic response configurations and a common Euclidean sensation space of hyperbolic stimuli.

If dissimilarity responses would have been defined by  $\tanh[\frac{1}{2}(s_{ji} - s_{ji}')] / (s_{ji} + s_{ji}')$  or  $\arctan[\frac{s_{ji} - s_{ji}'}{s_{ji} + s_{ji}'}]$  then response and sensation distances would be **monotonically related**. This **monotonic** relationship holds not for individual response distances in open response spaces that are defined by  $\tanh(\frac{1}{2}sr) = r_{ji}$  or  $\arctan(sr) = r_{ji}$  for comparable, hyperbolic or Euclidean sensations  $sr$ . **Open-Euclidean** response spaces might apply, because the stimulus space for human perception most likely is Euclidean, which also could follow from the evidence of:

- 1) Euclidean MDS-analyses of dissimilarities that consistently show **sub-additivity** of segmental distances, which has led to the so-called monotonic bounded response (BMR) model (Schonemann, 1983; Borg and Groenen, 1997, pp. 295-296), while monotonic bounded responses are inherent to open response space distances;
- 2) Minkowskian MDS-analysis of dissimilarities by Groenen, Mathar, and Heiser (1995) who found better fits for  $r = 1.33$  and  $r = 1.66$  than for  $r = 1$  and  $r = 2$ , which is expected for open-Euclidean response space distances, because relatively larger the closer they are to the space origin, which is approximated by Minkowskian distances with a  $r$ -metric  $1 < r < 2$  or as we expect to fit best with geometric midpoint  $r = \sqrt{2}$  as optimal  $r$ -metric.

Moreover, Dzhafarov and Colonius (1999, 2001) proved that multidimensional Fechnerian scaling in stimulus spaces requires a partial integration over a discrimination probability function between the probabilities that corresponds to the stimuli of each pair. They derived that Fechnerian distances are location- and direction-dependent distances in a Finsler space of power-raised stimuli. However, we hypothesised that only the logistic or Cauchy discrimination probability function applies, where partial integrations over these probability functions correspond to response distances in open spaces with a constant or zero curvature, wherein distances are not location- and direction-dependent. In contrast to Dzhafarov and Colonius, we distinguish between dissimilarity representations in response, sensation, and stimulus spaces, wherein corresponding distances differ, dependent on the remoteness of the response distances from their space origin. Only in power-raised stimulus spaces the Fechnerian distances become Finsler space distances. However, the power-raised stimulus fraction spaces have curvatures that are only direction-dependent, due to the rotational parameters of dimensional power exponents, as discussed in chapter 3.

For the here above described solutions with a particular dimensionality we need the data of rank ordered (dis)similarities between the object pairs of several individuals. The set of objects must contain the more objects the higher the dimensionality of the solution is, but the higher the number of individuals is the smaller the required number of objects can be for a determined solution. For  $N$  individuals,  $n$  objects and  $m$  dimensions it must at least satisfy:

$$\sqrt{m(n-1)N} > m(m-1)(N-1) + m(N-1) + n \cdot m$$

(dissimilarities)      (rotation)      weight      location      parameters)

and, not disregarding the loss of at least  $n$  degrees of freedom for the optimal scaling

of dissimilarities for each individual, it requires approximately.

$$Ym(n - 3)N > m^2(N - 1) + nom,$$

whereby

$$n > 2m + 3 \text{ and } N \geq 1$$

is needed, but a sufficiently overdetermined solution of the common Euclidean object space requires  $N > n$ .

We assumed complete sets of individual dissimilarities for all object pairs. In incomplete sets missing values can initially be filled in with arbitrary distance values, where the quasi-complete set is then analysed as distances in an open response geometry with a Euclidean or hyperbolic or elliptic distance metric. Assigned values to missing values are then iteratively improved by replacement of their predicted distance values until convergence occurs for assigned and predicted values of the missing values. However, it requires more objects and/or individuals than required above. Even the most efficient triad method for (dis)similarity comparisons asks already  $\frac{1}{2}n(n-1)(n-2)$  pair comparisons per individual, which stimulus sets larger than 7 are hardly feasible to obtain. Moreover, triads of pair comparisons may induce adaptation level shifts, which violates the assumed constancy of adaptation level in our analyses. For relatively large stimulus or object numbers complete dissimilarities with negligible adaptation level shifts might be obtained by dissimilarity ratings of all object pairs from a known object set, where firstly the least and most dissimilar pair of objects are to be selected by an individual and quantified as reference magnitudes of dissimilarity, say as I and 100. Secondly, the dissimilarities for the  $\frac{1}{2}n(n-1) - 2$  object pairs are then directly rated by the individual as numbers between I and 100. Scaling of such rated dissimilarities (or preferably their logarithm or square root) to between zero and the maximum-allowed response space distance then gives the initial response distances for the above described dissimilarity analysis methods.

Alternative solution procedures could be derived by Newton-Raphson or steepest descent algorithms (Everitt, 1987) for improvements of an initial, common Euclidean object configuration that after convergence of its geometric response transformations may optimally fit the dissimilarities as individually different response space distances. Such solution procedures are used in individual difference MDS-analyses (Carroll and Chang, 1972) and also in most existing other MDS-programmes (Cox and Cox, 1994) or they use a majorisation algorithm that is for the first time applied in the so-called SMACOF-analyses by Heiser (1981) and later in several other MDS-programmes (Groenen, 1993; Heiser, 1995; Borg and Groenen, 1997). Apart from inappropriate sensation space solutions, these analysis techniques can have the problem of local minimum solutions, although unlikely if the tunnelling technique of the majorisation algorithm is applied (Heiser, 1995; Borg and Groenen, 1997, ch. 13). Local minimum solutions are avoided by our semi-metric solutions that use no initial object configurations, but Procrustes matching of metrically transformed spaces from metric space analyses of initially and in the end optimally scaled dissimilarities as response space distances. However, our main concern is not the solution procedure, but the differing geometries of stimulus, sensation, and response spaces in our multidimensional psychophysical response theory as well as the demonstration that solutions for individual parameters and the common Euclidean object space exist.

## CHAPTERS

### VALENCE SPACE GEOMETRIES AND PREFERENCE ANALYSES

*"The objective of this approach <construction of prior theory for geometric representations by rational distance functions> is to build theory for the underlying process which will eventuate in necessary and sufficient conditions for metric representations to exist in the first place and then for particular distance functions. This approach is in a somewhat different direction from that which seeks a geometrical representation directly for purposes of data reduction and appears very promising. The power of mathematical methods in psychology will not be substantially utilized without their use in the development of theory in just this manner."*

Clyde H. Coombs. (1966). *Scaling and Data theory*.

Remark: the citation is from the last page of a draft text "*Scaling and Data theory*" by Clyde H. Coombs, distributed at the Nuffic International Summer Courses in Science, The Hague. 1966. Later it is published as chapter 3 in: Coombs, C.H., Dawes, R.M., and Tversky, A. (1970). *Mathematical Psychology*. Prentice-Hall, Englewood Cliffs, NJ. The draft text is altered in the book, where sentences at the ends of chapters 2 and 3 cover the main content of the citation.

## CONTENT DETAILS CHAPTER 5

	page
<b>5.0. Introduction</b>	171
<b>5.1. Weighted involution geometries of monotone valence spaces</b>	172
5.1.1. Monotone valence spaces as weighted response spaces	172
5.1.2. Iso-valent contours of monotone valences	179
<b>5.2. Open-hyperbolic or Finsler geometries of single-peaked valence spaces</b>	185
5.2.1. Single-peaked valence spaces as transformed response spaces	186
5.2.2. Iso-valent contours of single-peaked valences	196
<b>5.3. Open Finsler geometries of mixed valence spaces</b>	200
5.3.1. Iso-valent contours of mixed valences	201
<b>5.4. Appropriate multidimensional analyses of preferences</b>	203
5.4.1. Applicability of existing preference analysis methods	203
5.4.2. Analysis methods for monotone valence spaces	207
5.4.3. Analysis methods for single-peaked valence spaces	213
5.4.4. Analysis methods for mixed valence spaces	220

## 5.0. Introduction

Sections 5.1 to 5.3 of this chapter describe the open valence space geometries that derive from individual transformations of sensation spaces by the respectively discussed monotone, single-peaked, or mixed valence functions. In section 5.4 we derive a common Euclidean object space as reference space for the metric analysis of optimally scaled preference rank order data. In order to be able to analyse the preference data as metric transformations with individual parameters of the common Euclidean object space, the gathered preference data not only must yield individual preference rank orders of objects, but also which objects are not appreciated. The rank order numbers that are translated to negative values for disliked objects specify the gathered bipolar preference data that under preservation of sign become optimally scaled within the range of the negative and positive limits of the open valence geometries. The individually scaled object valences of several individuals define by their inverse valence transformation and individual parameters a derivable, common Euclidean or hyperbolic sensation space. Even if valence spaces would be transformations of Minkowskian or hyperbolic sensation spaces with other  $r$ -metrics than  $r = 2$  or respectively other curvatures than  $\kappa = -1$ , we can only apply inverse valence transformations to scaled valences that correspond to Euclidean or hyperbolic unit-curvature spaces of comparable sensations. Therefore, only Euclidean or hyperbolic unit-curvature spaces of sensations are derivable from valence spaces. Since sensations can't be observed, we take in the sequel flat sensation spaces as Euclidean and hyperbolic sensation spaces as unit-curvature spaces, where the latter spaces correspond to a common Euclidean stimulus space. Thus, the common Euclidean object space is either the stimulus or a Fechnerian sensation space.

We primarily consider valence functions that are hyperbolic tangent functions for sensations with monotone valences or are products of two hyperbolic tangent functions for sensations with single-peaked valences, as derived in chapter 2. Since the sensation space is either Euclidean or hyperbolic, these finite transformation functions define four different, open valence space geometries - two for monotone and two for single-peaked valences. Referring to the arctangent function for single-elliptic response spaces, described in section 4.2.1, we also consider the theoretically consistent alternatives of the arctangent function as monotone valence function or the product of arctangent functions as single-peaked valence function. Due to the geometric relationships between response and sensation spaces, the arctangent-based valence functions can only apply to individual valence transformations of Euclidean sensations that then define additionally two other, open valence space geometries, - one for monotone and one for single-peaked valences. The six different geometries of open valence spaces determine correspondingly different multidimensional analysis methods for preference data. These preference analyses are described in section 5.4. after questions on applicability of existing preference analysis methods are discussed. In the next sections we discuss and illustrate the general aspects of the different valence space geometries. Although arctangent-based valence function may hold, we only present illustrations obtained by hyperbolic tangent functions for monotone valences or by products of hyperbolic tangent functions for single-peaked valences.



## 5.1. Weighted involution geometries of monotone valence spaces

### 5.1.1. *Monotone valence spaces as weighted response spaces*

The response or monotone valence functions that transform sensations to responses or valences are identical functions as shown in section 2.2. of chapter 2. A monotone valence dimension is a weighted response space dimension that has the higher weight or more preference relevance the smaller its angle is with the ideal response axis that contains the ideal point as limiting response space point for the ideal sensation space infinity. This preference relevance is expressed by weights as cosines of angles with that ideal response axis, since cosines have the larger values for the smaller angles. Monotone valence spaces, therefore, are defined by weighted response spaces, wherein preferences for objects with monotone valences are represented by response vectors that are weighted by the cosine of the angle between their response vectors and the ideal response axis. It defines, thereby, the ideal valence axis in monotone valence spaces to be identical to an ideal response axis in response spaces. The angles between object vectors and the ideal axis in response and monotone valence spaces are identical to the corresponding angles between object vectors and the ideal axis in the sensation or stimulus space with the adaptation point as origin, due to their projective relationships. Projections of response vectors on the ideal axis in the open response spaces are equal to the object valences, because their projection cosines are the vectorial weights for the preference relevance of response vectors.

Since monotone valence spaces equal weighted response spaces, a monotone valence space is rotationally invariant and an open space with either a non-Euclidean or Euclidean distance metric, according to chapter 4. Thus, correspondingly weighted open geometries apply to monotone valence spaces, where the limit boundaries are defined by the weighted limit boundary of its corresponding response space. The weights are positive or negative cosines of angles between the ideal axis and response vectors, whereby the limited boundary is defined by positive and negative circular (or hyper-spherical) subspace boundaries of two reflected circularly (or hyper-spherically) open subspaces that only share the adaptation point and together constitute the monotone valence space. Since circular valence vector projection on the ideal axis define iso-valent contours (contours of equally preferred objects, also called iso-crests), these iso-valent contours are reflected parts of circles (or parts of hyper-spheres) within the circular (or hyper-spherical) subspaces that are defined by the weighted limit boundary of the open response space. The corresponding iso-valent contours in the response space are described by straight response projection lines perpendicular to the ideal axis (in the open-Euclidean response space or on the non-Euclidean response surface within the circular limit boundary). However, iso-valent response contours as open lines orthogonal to the ideal axis become curves in the common Euclidean object spaces, except for the ideal and indifference axes, due to the projective relationship between open response spaces and infinite Euclidean object spaces.

If monotone valences are defined by weighted hyperbolic tangent functions of hyperbolic sensations, then the corresponding monotone valence space has a Euclidean distance metric, because monotone valence spaces then are weighted response spaces with Euclidean involution geometries. Maximum and minimum valences correspond to the positive and negative limit value of the ideal and anti-ideal points on the

corresponding ideal axis and limit boundary of the response space. The cosines of the vectorial angles with the ideal axis determine weights for the circular boundary of an open-Euclidean (Poincare) response disc and thus define the weighted limit boundary of two-dimensional valence spaces for monotone valences with a Euclidean metric (thus also for such two-dimensional subspaces). That limit boundary of the weighted response disc becomes a so-called lemniscate (that looks like circular butterfly wings) with the zero-valence adaptation point as origin (the connecting point for the positive and negative valued wings of the valence lemniscate) in the two-dimensional monotone valence space. The ideal axis contains the anti-ideal point (with valence  $-I$ ), the ideal point (with valence  $+I$ ), the negative and positive subspace centre points (with valences  $-\frac{1}{2}$  and  $+\frac{1}{2}$ ) as loci of the circular lemniscate wings, and the adaptation as the zero-valence space point. Any dimension orthogonal to the ideal axis corresponds to zero-valence sensations and is called an indifference axis. As figure 29 below shows, the interior of the valence lemniscate with a Euclidean metric corresponds to a weighted Euclidean involution disc for responses, wherein objects with equal valences are points located on positive and negative parts of iso-valent circles within the circular wings of the valence lemniscate. Its iso-valent contours in the corresponding open-Euclidean response space are straight lines perpendicular to the ideal axis with indifference axes as perpendicular lines of zero-valence responses through the adaptation point as origin. In an open response or its corresponding valence space with a Euclidean metric the object valences are thus equal to Euclidean projections of response vectors on the ideal axis or respectively to circular projections of valence vectors on the ideal axis, as illustrated below.

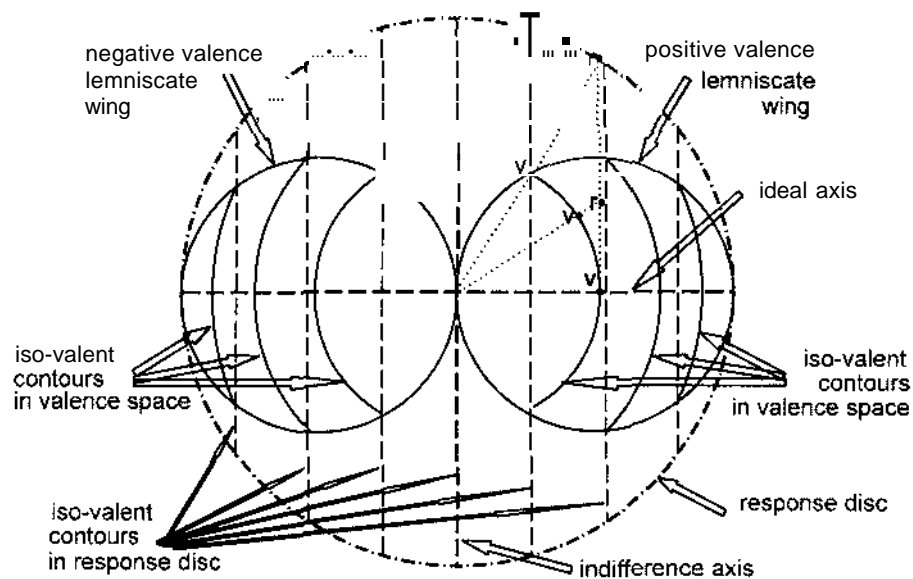

Figure 29. Iso-valent contours as partial circles in the circular valence lemniscate and as straight lines in the open-Euclidean response disc (Poincare disc)

The negative and positive valued wings of the valence lemniscate may not have a Euclidean metric, since that only holds for weighted hyperbolic tangent transformations of hyperbolic sensation surfaces. The monotone valence transformation by weighted arctangent functions of Euclidean sensations yields a weighted single-elliptic response space as monotone valence space. Here weights for the preference relevance are the cosines of angles between elliptic vectors and the ideal axis with the adaptation point as origin of its single-elliptic response space. Thus, its monotone valences define also oppositely signed valence lemniscate wings that have an elliptic metric. Similar matters hold for weighted open-hyperbolic response spaces with a hyperbolic metric for their valence lemniscates of oppositely signed valence wings, where weighted hyperbolic tangent functions are then the monotone valence functions for the transformation of a Euclidean space of comparable sensations. Each of the three geometries for monotone valence spaces has an open, rotation- and translation-invariant geometry, because each corresponding, weighted response space has a rotation- and translation-invariant, open-Euclidean, open-hyperbolic, or single-elliptic geometry as involution space of the (Euclidean or non-Euclidean) stimulus space. The object valences in all valence geometries are equal to the orthogonal projections of the corresponding response vectors of objects on the ideal axis in the response space. For each of the three open involution geometries of the response space this holds, because a Euclidean, hyperbolic or single-elliptic vector that is weighted by its cosine of the angle with a dimension is equal to its orthogonal projection on that dimension. Since the ideal response axis represents the object valences in monotone valence spaces, they are also expressed by circular projections of the valence object vectors on the ideal valence axis, which defines the iso-valent contours to be opposite parts of circles within the positive and negative wings of open lemniscate subspaces for the monotone valence space. It is **demonstrated** in the next mathematical section that individual preferences from the rotationally invariant space of monotone valences are represented by the response projections on the ideal response axis that by its inverse response transformation corresponds to an individually oriented and located ideal axis in the corresponding Euclidean or hyperbolic Bower spaces of comparably weighted sensations.

We define again:  $m$  dimensions by indices  $\{1..,k,I, m\}$   
 $N$  individuals by indices  $\{1..,I,J, N\}$   
 $n$  choice objects by indices  $\{1..,i,j, n\}$

The dimensional valences of individual  $J$  for object  $i$  on dimension  $k$  are denoted by  $v_{Jik}$ , defined by (24) for monotone valence dimensions, while the finite dimensional maximum valences and the maximum space valence are denoted by respectively  $v_{Jk}$  and  $v_{Ji}$ . The object valences for an individual are denoted by  $v_{Ji}$  and its dimensional valences by  $v_{Jik}$ .

On the one hand we may assume that  $v_{Ji}$  can be defined by the monotone valence function for the sensation vector of object  $i$  which function then is identical to its weighted response function. Its weights are weights for the preference relevance of that vector direction as the cosine of the projection angle of the object vector on the ideal axis as the dimension that is directed to the ideal point. This definition implies that monotone valence spaces correspond to weighted response

spaces, whereby these valence spaces have the same rotational invariance as its corresponding response geometry.

on the other hand one may assume that the object valences are described by the sum of its comparable dimensional valences as some individually oriented sensation dimensions that are transformed by their monotone valence function. It is proved here below that the simple addition of rotated dimensional object valences yields identical preference values, provided that the monotone valence functions for the corresponding dimensional sensations are dimensional response functions that are weighted by the cosine of the projection angle with the ideal axis.

Let dimension  $v_{Ji1}$  be the valences on ideal axis 1 and  $\mu_{Ji1}$  the angle of valence vector  $v_{Ji}$  with the ideal axis for individual  $J_i$ , then for a rotational invariant monotone valence space as a weighted response space with response vectors  $r_{Ji}$  and cosines of angles  $\mu_{Ji1}$  with ideal axis as weights for the preference relevance of response vectors we have

$$\cos(\mu_{Ji1}) \cdot r_{Ji} = v_{Ji1} \quad (62a)$$

Now let in a two-dimensional valence space the orthogonal dimensions  $k$  and  $h$  have angles  $\beta_{k1}$  and  $\beta_{h1} = 90^\circ - \beta_{k1}$  with the ideal axis, then the composite object valence  $v_{Ji}$  is additively defined by

$$\text{because } v_{Jih} + v_{Jik} = v_{Ji} \quad (62b1)$$

$$\begin{aligned} & \cos(90^\circ - \beta_{k1}) \cdot r_{Jih} = v_{Jih} \\ \text{whereby } & \cos(90^\circ - [\beta_{k1} + \mu_{Ji1}]) \cdot r_{Ji} \\ & \sin(\beta_{k1}) \cdot \sin(\beta_{k1} + \mu_{Ji1}) \cdot r_{Ji} \end{aligned} \quad (62b2)$$

$$\begin{aligned} \text{whereby } & \cos(\beta_{k1}) \cdot r_{Jik} = v_{Jik} \\ & \cos(\beta_{k1}) \cdot \cos(\beta_{k1} + \mu_{Ji1}) \cdot r_{Ji} = v_{Jik} \end{aligned} \quad (62b3)$$

Substitution of (62b2) and (62b3) in (62b1) gives

$$[\cos(\beta_{k1}) - \cos(\beta_{k1} + \mu_{Ji1}) + \sin(\beta_{k1}) \cdot \sin(\beta_{k1} + \mu_{Ji1})] \cdot r_{Ji} = v_{Ji} \quad (62b4)$$

$$\text{whereby } \cos(\beta_{k1} - [\beta_{k1} + \mu_{Ji1}]) \cdot r_{Ji} = \cos(\mu_{Ji1}) \cdot r_{Ji} = v_{Ji1} = v_{Ji} \quad (62b5)$$

Moreover combining (62b2) and (62b3) as the summation of dimensional responses  $h$  and  $k$  to the ideal response axis, we have

$$\begin{aligned} \text{and thus } & \cos(90^\circ - \beta_{k1}) \cdot r_{Jih} + \cos(\beta_{k1}) \cdot r_{Jik} \\ & v_{Jih} + v_{Jik} = r_{Ji1} = v_{Ji1} = v_{Ji} \end{aligned} \quad (62c)$$

Since this holds for any two-dimensional subspace (62b5) and equalities (62a) and (62c) uniquely define the monotone valence space of any dimensionality to be a weighted response space with weights as cosines of vectorial or dimensional angles to the ideal axis and the adaptation point as origin for dimensions and object vectors. The preference for an object is equivalently expressed by 1) the simple sum of its dimensional

valences, 2) the weighted sum of its dimensional responses, 3) the (possibly curved) vectorial object valence, and 4) the object value on the ideal response or valence axis, because the weights for response vectors or dimensions are rotation weights to the ideal axis.

Let the weighted sum of response dimensions define the object valence, then the geometric appropriate valence distance of an object with its valence  $v_{Ji}$  to maximum space valence  $v_J$  in the monotone valence space of an individual is written as function of dimensional responses  $r_{Jik}$  by

$$d(v_J - v_{Ji}) = d\left\{v_J - \sum_{k=1}^{k=m} h_{Jk} \cdot r_{Jik}\right\} \quad (63a)$$

The additive dimensional valences define in the appropriate rotational invariant response spaces the weights  $h_{Jk}$  as the rotation cosines of angles between dimensions  $k$  and the ideal axis for individual  $J$ , where the rotation angle values  $h_{Jk}$  are by definition normalised to unity.

If the stimulus space is Euclidean then its hyperbolic sensation space is transformed to monotone valence spaces by weighted hyperbolic tangent functions. Thus its valence geometry is the weighted geometry of an open Euclidean response space. Since a Euclidean metric applies the required rotational invariance is guaranteed, while maximum space valence  $v_J = 1$ .

For arctangent functions as monotone valence functions the dimensional valences are weighted elliptic response dimensions from flat sensation dimensions and thus has the rotational invariant, open geometry of a single-elliptic space. Its rotational invariance allows rotation weights to the ideal axis for the additive valence dimensions as weighted sums of single-elliptic response dimensions with rotation weights  $h_{Jk}$ . Here the maximum space valence  $v_J = n/2$ , while the normalised sum of unity for the dimensional rotation weights to the ideal axis also define the object valences by the sum of its dimensional valences.

For hyperbolic tangent functions as monotone valence functions of flat sensations, the valences define an open geometry with a hyperbolic curvature and distance metric. In the rotation invariant open-hyperbolic response space the weights also are defined as the rotation cosines to the ideal axis with rotation weights that are normalised to unity and where again the maximum space valence  $v_J=1$ .

The monotone valence spaces for (63a) define weighted response spaces of  $v_{Ji} = \sum_{k=1}^{k=m} h_{Jk} \cdot r_{Jik}$  with rotation cosines  $h_{Jk}$  as weights for preference relevance of the response dimension  $k$  for individual  $J$ . Thus as (63a) this is written respectively for the three rotational invariant cases by rotation cosines  $h_{Jk}$  for response dimensions  $k$  to the individual ideal axis of individual  $J$  with object preferences  $v_{Ji}$  as

$$v_{Ji} = \sum_{k=1}^{k=m} h_{Jk} \cdot r_{Jik} = r_{Ji}, \quad (63b1)$$

which by the corresponding angles in a derivable Euclidean sensation space from open-hyperbolic response spaces writes as

$$\arctanh(-v_{Ji}) = \sum_{k=1}^{k=m} h_{Jk} \{y_i - a_{Jk} / a_{Jk} - 1/a_{Jk} = y_i/a_{Jk} - 1\}, \quad (63b2)$$

and for a Euclidean stimulus space with open-Euclidean response spaces

$$\frac{v_{J_i}}{1 + v_{J_i}} = (x_{J_i}/b_J)^{2/a} = \left[ \sum_{k=1}^{k=m} h_{Jk} (x_{Jk}/b_{Jk}) \right]^{2/a} \quad (63b3)$$

For the derivable Euclidean sensation space from single-elliptic response spaces it writes as

$$\tan(v_{J_i}) = B_{J_i} = \sum_{k=1}^{k=m} h_{Jk} \cdot 2(y_{Jk} - a_{Jk})/a_{Jk} = 2(y_{J_i}/a_J - 1) \quad (63b4)$$

We see directly that the object valences in (63b) give a rank order (from low to high values) of  $v_{J_i} = r_{J_i}$  that is the reversed rank order (from low to high values) of distances to maximum space valence or stronger that these metric distances and their object valences are reflected translations of each other.

The limiting boundary of these open valence spaces is determined by the weighted response vectors with weights  $w_{J_i} = \cos(\mu_{J_i})$  for angle  $\mu_{J_i}$  as the angle between the ideal axis and the response (or valence) vector of the objects  $i$ , which weight represents the preference relevance of the response vector. Thus object valences also are projections of response space vectors  $r_{J_i}$  on the ideal axis, which projections define the signed preference with negative values for disliked objects.

In case of hyperbolic sensation spaces the object valences or distances to the maximum valence point are directly expressed by the hyperbolic tangent of sensation projections on the hyperbolic ideal sensation axis as

$$v_{J_i} = r_{J_i} = \tanh(-\frac{1}{2} s_{J_i}) \quad \begin{array}{l} \text{Valences as ideal axis in} \\ \text{open-Euclidean response and (63c)} \\ \text{hyperbolic sensation spaces} \end{array}$$

or by its Euclidean distance to maximum valence as  $1 - v_{J_i}$ . This also can directly be expressed by the hyperbolic involution of the ideal stimulus axis in the Euclidean stimulus space as

$$v_{J_i} = r_{J_i} = \frac{[1 - (x_{J_i}/b_J)^{2/a}]^{2/a}}{[1 + (x_{J_i}/b_J)^{2/a}]^{2/a}} \quad (63c2)$$

The geometry for any two-dimensional, monotone valence subspace of (63c) is described by positive or negative partial iso-valent circles within a lemniscate with polar co-ordinates  $(v_{J_i})^2 - \frac{1}{2} = \frac{1}{2} \cos(2\mu_{J_i})$  for  $-\frac{1}{2}$  and  $+\frac{1}{2}$  as loci of centres on the ideal axis (Courant, 1960; p. 172), whereby its lemniscate wings become circular. The adaptation point with zero valence is the centre of the valence lemniscate that is located within its Poincare response disc, where the circular projections on the ideal response axis also represent the object valences.

As (63b) shows the object valences become in the Euclidean stimulus space an individually weighted, power-raised, and oriented axis, that corresponds to the inverse involution of the ideal response axis. The individual preferences on individually located, rotated, and power-raised ideal axis in the Euclidean stimulus space imply that contours of equally preferred objects in the common stimulus space are different-curved iso-valent curves that are orthogonal to individually different-located ideal stimulus space axes.

The individual ideal axes in a single-elliptic response space define

$$v_{J_i} = r_{J_i} = \arctan(s_{J_i}) \quad \begin{array}{l} \text{Ivalences as ideal axis in} \\ \text{single-elliptic response} \\ \text{and flat sensation spaces} \end{array} \quad (63c3)$$

where distances to maximum valence are elliptic arc lengths  $(\frac{1}{2}\pi - v_{J_i})$ . Here the valence weighing transforms a hemispherical response surface with unit radius to an elliptic curved lemniscate  $\frac{1}{2}\cos(2\mu_{J_i})$  for the angles  $\mu_{J_i}$  of elliptic object vector  $i$  with the ideal axis as half a circle and a zero valence adaptation point as centre of the valence lemniscate on the single-elliptic response sphere. The ideal axis in that response space again represents the individual valences of objects. In a flat sensation space the valences are thus represented by the tangent transformation of that ideal valence axis as half a circle. It corresponds to an individually rotated, located, and weighted axis in a derived common Euclidean sensation space. Individually equal preferences correspond in this Euclidean sensation space also to differently curved iso-valent curves that are orthogonal and symmetric to the ideal axis.

Alternatively the individual ideal axes in open-hyperbolic response spaces define

$$v_{J_i} = r_{J_i} = \tanh(\frac{1}{2}s_{J_i}) \quad \begin{array}{l} \text{Ivalences as ideal axis in} \\ \text{open-hyperbolic response} \\ \text{and flat sensation spaces} \end{array} \quad (62c4)$$

where distances to maximum valence are hyperbolic arc lengths  $(1 - v_{J_i})$ . Here the valence weighing transforms the open-hyperbolic response space with a unit radius to a hyperbolic curved lemniscate surface.

In the above mathematical subsection it is shown that object preferences with monotone valences can equivalently be expressed by valence distances of objects to the ideal valence space point and by the object valences, which are reflected translations of each other. Moreover, it is proved that the object valences as weighted responses are equal to the sum of their dimensional valences, defined by rotationally weighted dimensional responses, because the weights for the preference relevance of responses are their rotation cosines to the ideal axis. It defines the object valences to be identical to the object values on the ideal axis in the response space and iso-valent contours in a two-dimensional monotone valence space as parts of circles within the circular valence lemniscate as limit boundary of its open, two-dimensional valence space. It also means that the preferences of objects with monotone valences are equivalently evaluated by their sum of the independent valence dimensions and by the circularly projected valence vectors or orthogonal response vector projections on the ideal response axis. The preference of objects then is a compensatory additive composite of the dimensional valences from independent monotone valence dimensions. For example, the preference for jobs could be evaluated by the monotone valences for two independent sensation dimensions as the monetary aspect of the job salary and the ethical aspect of the job work, where each sensation dimension is assumed to have an infinity as ideal. The monotone valence space then yields valence dimensions that are equal to its weighted response dimensions that are weighted by their rotation weights to the ideal response axis. The preference evaluation then becomes the sum of the weighted dimensional response dimensions. Since the response dimensions are weighted by the cosine of their

angle with the ideal axis, then preferences are equivalently defined by (1) the sum of the weighted response dimensions, (2) the circular valence vector projections on the ideal valence axis, and (3) the object values on the ideal response axis. Preferential weights as cosines of angles to the ideal response axis can equivalently be seen as preferential weights of objects in the comparable Bower space, because vector angles in response and Bower spaces are equal and the ideal response axes are response-transformed ideal sensation axes.

By weighted sums of the signed dimensional responses, the monotone valence values of objects become compensatory additive values of individually oriented and weighted dimensions of open-Euclidean, or open-hyperbolic or single-elliptic response spaces. Valence dimensions orthogonal to the ideal axis are indifference axes with zero valence. Objects with zero valences need not to represent sensations with a psychologically neutral valence, as holds for objects on the indifference axis with zero preference-relevance, because valences may also derive from a balance of conflicting positive and negative object valences. An internal conflict between balancing positive and negative underlying dimensional valences becomes resolved in ambivalent indifference. Since such individual cognitive conflicts are a psychological reality for individuals in forced choice situations, the compensatory additive (of positive and negative valued) valence dimensions describe the actual underlying cognitive process of preference evaluation. The zero valence of ambivalent choice indifference derives not from a preference irrelevance, but from a zero sum of positive and negative dimensional valences of choice objects. Only objects with dimensional zero valences are preferentially neutral objects, but these objects then coincide with the adaptation point in the monotone valence space or are located in subspaces of indifference axes in open response and infinite sensation spaces. In this chapter we only consider the zero valences of valence-neutral indifference, while the zero valences of ambivalent indifference from a conflicting balance between positive and negative valence dimensions are further discussed in chapter 7

### 5.1.2. *Iso-valent contours of monotone valences*

We investigate the preference structure by iso-valent contours in the common Euclidean object plane that can be derived from two-dimensional monotone valence spaces of several individuals. Since the ideal response axes of individuals must be scaled to axes in response spaces with a radius of unity for their transformation by inverse hyperbolic tangent or tangent functions to individually oriented ideal axes in individually weighted and translated sensation spaces, the derived sensation space from open-hyperbolic or single-elliptic ideal response axes of individuals is Euclidean. This also holds if the monotone valences of objects would be generated from Minkowskian sensation spaces that correspond to response spaces with curvature  $|c| = r/2$  as the relation between  $r$ -metrics of flat spaces and curvatures of non-Euclidean spaces (see: chapters 3 and 4). If objects only have monotone valence attributes, such as monetary value and societal esteem (positive ambience, no saturation level), or environmental pollution, pain, and anxiety threat (negative ambience, no deprivation level), then monotone valence spaces apply to the preference evaluation of its multidimensional objects. It is already shown that individual preference evaluations of objects then reduce to individual valence values of objects on the ideal axis in their response space, wherein iso-valent contours



are defined by orthogonal projections on the ideal response axis. However, the circle parts of the iso-valent contours in the monotone valence space (figure 29) become oppositely symmetric-curved contours with respect to the indifference axis in the Bower spaces of comparable sensations. Figure 30 illustrates the iso-valent contours of an individual in a Euclidean Bower plane of comparably weighted and individually translated Fechner sensations. This illustration derives from the inverse hyperbolic tangent transformation of an open-hyperbolic response surface with straight iso-valent lines on its surface to a Euclidean Bower plane of comparable sensations. The orthogonal ideal and indifference axes in two-dimensional response spaces become represented as individually oriented straight axes that remain orthogonal to each other in the corresponding Euclidean Bower plane. However, the straight iso-valent lines on the hyperbolic response surfaces become oppositely oriented curves in Euclidean Bower planes, because the inverse response functions projectively transform open response spaces with respect to the individual adaptation points as projection centre to infinite Euclidean Bower planes.

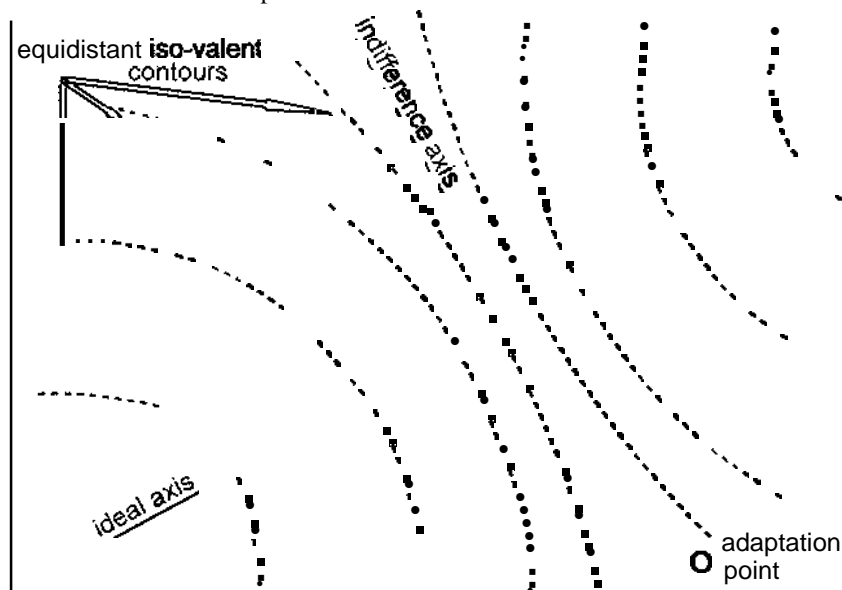

Figure 30. Iso-valent contours for monotone valences in a Euclidean Bower plane

This figure shows that iso-valent sensation curves are oppositely curved lines on the positive and negative side of the indifference axis in the Bower plane of individually weighted and translated Euclidean sensations, where the curvature of these iso-valent curves increases with their distance to the indifference axis. If weighted hyperbolic tangent functions are the monotone valence functions that transform a hyperbolic Bower surface of comparable sensations the representation of figure 30 is slightly improper, but orthogonal ideal and indifference axes and oppositely symmetric iso-valent curves yield a similar representation on the corresponding hyperbolic Bower surface. The increasing curvature of iso-valent curves in the Euclidean plane or

increasing distances between iso-valent curves on the hyperbolic Bower surface is the result of the inverse stereographic projection of the straight iso-valent lines in the respectively open-Euclidean or open-hyperbolic response space. Here the inverse stereographic projection corresponds to the inverse hyperbolic tangent transformation of the response vectors, whereby straight iso-valent lines in response spaces with unit (pseudo-)radius become oppositely symmetric iso-valent curves in the Euclidean or hyperbolic Bower plane of individually translated and weighted sensations. The individual ideal and anti-ideal points in the Euclidean or hyperbolic sensation plane (an anti-ideal point represents the sensation of the most repulsive imaginary object for an individual) are infinitely far away on the extended positive and negative side of the ideal sensation axes and are thus positive and negative infinities in opposite directions. However, for both infinite sensations the valence is limited to the singular maximum or minimum value of the response transformation of the ideal sensation axes. The representation of the iso-valent curves in the common Euclidean object space of Fechner sensations spoils the orthogonality of the ideal and indifference axes and the opposite symmetry of iso-valent curves, because derived from Bower planes with individually different dimension weights by their inverse weights as half the dimensional value of individual adaptation points that also define different origin locations for oblique ideal and indifference axes of individuals in the common Euclidean object space of Fechner sensations.

If weighted arctangent functions are the monotone valence function then the corresponding indifference and ideal axes in the single-elliptic response space become elliptic axes, comparable to orthogonal meridians of a hemispherical globe with the adaptation point as pole and the equator as limit boundary of the response space. The iso-valent lines on a hemispherical response surface are orthogonal projection lines onto the ideal axis as hemispherical globe latitudes parallel to the equator, which analogy was also used for latitudes as iso-distant response circles in single-elliptic response spaces. In the corresponding Euclidean Bowerplane these iso-valent response projection lines become again oppositely curved lines with respect to the indifference axis by their implied radial projection (with respect to the zero-valued adaptation points as polar projection centre). Thereby, also the curvatures of the oppositely concave iso-valent curves increase with their distance to the indifference axis in the corresponding Euclidean Bower sensation plane. Thus, similar to figure 30, the oppositely oriented, convex iso-valent circle parts within the valence lens become also oppositely concave-curved lines with respect to the indifference axis in the Bowerplane of individually weighted and translated sensations.

The orthogonal object projections on the ideal sensation axis in the Euclidean Bower space of comparable sensations deviate with respect to the adaptation point by symmetrically monotone transformations from the curvilinear object projections along the iso-valent curves that correspond to straight projection lines on the ideal axis of single-elliptic and open-hyperbolic response surfaces. Therefore, the individual preference rank orders of objects with monotone valences are identically represented by the orthogonal projections of the objects on the ideal axis in the Euclidean Bower plane of individually translated and weighted Fechner sensations. However, different individuals generally not only have differently located adaptation points and differently

oriented ideal axes, but also differently located and oriented curvilinear iso-valent projections of objects on their ideal axes. Thus the object valences are not presented by the orthogonal object projections on ideal axes with individual orientations, but the object configuration in the common Euclidean sensation space can be derived from the equivalent rank order of preferences and Euclidean object projections on individually rotated ideal axes in the Euclidean Bower space. Translations of individual ideal axes to a common Euclidean space origin don't change its Euclidean object projections, but they change by the individually different dimension weights in the transformation of individual Bower sensation spaces to a common Euclidean sensation space. Thus, the correct object configuration and the rank order of individual preferences can only be derived by the Euclidean projection of objects on individually oriented ideal axes in a common Euclidean object space, if its dimensions are individually weighted. Since the individual weights for the comparable sensation dimensions with monotone valences are defined by twice the inverse of their dimensional adaptation point values, these weights also determine the individual adaptation points. Thereby, also the individually located and rotated ideal axes in the common Euclidean sensation space can be determined, but then only if the preference analysis takes individual dimension weights into account. The individual preference rank orders in the preference analysis by the so-called linear vector model without individual dimension weights (Tucker, 1960) are defined by rank orders of orthogonal object projections on individually rotated dimensions in a common Euclidean object space, which thus demonstrates that linear vector model without individual dimension weights, may only correctly recover the object locations in the common Euclidean sensation space, if the adaptation points of individuals are identical. Identical adaptation points may hold for randomly presented choice objects, but if the assumption of a common adaptation point is violated then the linear vector model cannot resolve the actual object locations, nor the location and rotation of individual indifference and ideal axes (unless individual dimension weights are also taken into account and where then these weights equal twice the inverse of the translation parameters to the adaptation point as individual space origin).

If the sensation space is not Euclidean then the sensation space is hyperbolic and derives from a positive Euclidean stimulus space that is an exponential transformation of the hyperbolic Fechner sensation space. However, their monotone valence spaces derive from weighted hyperbolic tangent transformations of weighted and translated, hyperbolic Fechner spaces as comparable sensation spaces, where the dimensional sensation weights are different for individuals with correspondingly different adaptation points that also determine individual translations. Thus, the corresponding stimulus space is a dimensionally power-raised Euclidean stimulus-fraction space with dimensional unit points for the adaptation point and with dimensional power exponents that equal the individual sensation dimension weights, whereby their power-raised Euclidean stimulus-fraction spaces generally will also be individually different. Since individuals generally have different adaptation points for cognitive object attributes with monotone valences, the straight iso-valent lines and indifference axes in the open-Euclidean response spaces of individuals become differently transformed to asymmetric iso-valent curves with varying curvatures and hyperbolic curved indifference axes in their differently power-raised and scaled

Euclidean stimulus-fraction planes. due to the exponential transformation of the correspondingly different hyperbolic spaces of their comparable sensations. Nonetheless, the ideal stimulus axes of individuals remain straight axes in individually scaled stimulus-fraction spaces, due to inversely power-raised axes of the inverse involutions of their ideal response axes with the same rotation cosines for their orientation in response and stimulus-fraction spaces, provided that the adaptation point is the individual rotation centre. Therefore, also in the common Euclidean stimulus space the ideal axes of individuals remain individually oriented, straight lines that all originate from the stimulus space origin if we assume that the stimulus space origin is the ideal or anti-ideal stimulus point for each individual. An example of asymmetric curved iso-valent contours in the common Euclidean stimulus plane is shown in figure 31 below, where the representation derives from the inverse power and scale transformations of the exponentially transformed, hyperbolic space of comparable sensations with oppositely symmetric iso-valent curves and dimensional weights that also define the dimensional power exponents of stimulus-fraction spaces.

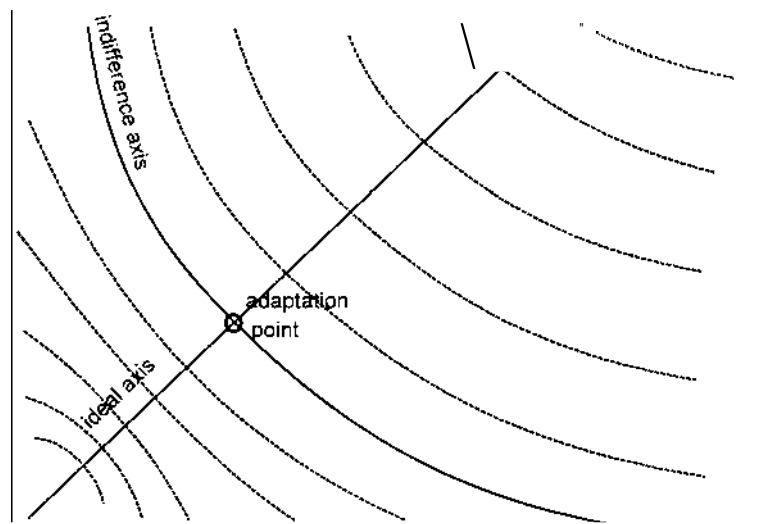

Fig. 31. Iso-valent curves of *mOltone* valences in a common Euclidean stimulus plane.

The inverse hyperbolic involutions of ideal response axes yield differently oriented ideal axes in the individually scaled (by the inverse of the dimensional adaptation points) and power-raised (by twice the inverse value of the logarithmic distance between the dimensional adaptation and just noticeable points) Euclidean stimulus space. Due to the involution transformation of the ideal axes the object rank order on the ideal stimulus space axis is reversed with respect to the ideal response axis. In individually weighted spaces of the common Euclidean stimulus space the Euclidean object projections on individually oriented ideal axes are monotonic transformed values of their ideal response axes, because the response transformations of object projections to ideal stimulus axes are monotone transformations. However, the rank order of object

projections on ideal axes in the common Euclidean stimulus space may be different. Thereby, Euclidean object projections on individually oriented ideal axes in the common Euclidean stimulus spaces only yields a monotone transformation of its monotone valence values if the common Euclidean stimulus space dimensions are individually weighted. Thus, the preference analysis by the linear vector model without individual dimension weights of the common Euclidean stimulus space represents not the preference rank orders of individuals by the rank order of the orthogonal object projections on individually oriented ideal axes, unless individuals would have identical adaptation levels. If we assume identical adaptation points for all individuals and a Euclidean stimulus space, then all individual response spaces are identical, whereby their monotone valences could only differ by individually rotated ideal axes. The linear vector model then could as well solve the open-Euclidean response space, because the orthogonal object projections on the individually rotated ideal response axes define the object valences in a then common assumed open response space with a Euclidean distance metric. However, monotone valences for stimulus dimensions define that the stimulus space origin must correspond to the ideal or anti-ideal point of all individuals, because all stimulus dimensions originate from the stimulus space origin that becomes a common and unique point on the limit boundary of the open response space. It would then mean that the orientation of ideal axes in a common-assumed response space is identical for all individuals, because the ideal response axes of individuals then not only share the response space origin as common adaptation point, but also the unique limit boundary point that represents the stimulus space origin. Thereby, also all ideal axes would be identical if individuals have identical adaptation points.

If individuals have no common adaptation point then their ideal axes still share the stimulus space origin, which implies that the ideal axes of individuals share a unique negative sensation infinity in the common hyperbolic or Euclidean Fechner sensation space. Thus, if the sensation space is the common Euclidean object space then this would mean that ideal sensation axes of all individuals are parallel axes in the common Euclidean sensation space. In hyperbolic spaces parallels diverge from some common infinity. Thus, if the sensation space is hyperbolic then ideal axes of individuals are diverging axes from a common infinity, whereby also individual ideal axes in the common Euclidean stimulus space have different orientations. Since the ideal axes of individuals are not restricted to parallels in the common Euclidean object space, we seem to have another *strong theoretical argument for the hyperbolic geometry of sensation spaces and the Euclidean geometry of the stimulus space*. However, stimulus spaces that have a physically defined common origin generally have no monotone valences, but single-peaked valences (e.g. intensities of temperature, pressure, loudness and pitch of sound, brightness and hue of light, etc.), except bodily pain that may be seen as a physical stimulus dimension with monotone valences. Other object attributes with monotone valences, such as the valences of monetary value, esteem, threats, social power, unreliability etc., seem all cognitive attributes. One may question the validity of a common, stimulus-like space with a common origin for objects with cognitive attributes. Firstly it is not well defined that such cognitive attribute spaces of objects have a commonly defined origin in the stimulus-like attribute space (although learning theory would imply a common stimulus-like space origin for

the individually learned complexes of mediating response-sensations as cognitive attribute sensations). Secondly, there is no guarantee that individual valence or response spaces for cognitive objects derive from individual transformations of a common object space (learning theory would suggest that this may only be the case if the learning history of cognitive meanings is shared by individuals). So it very well may be that cognitive attributes with monotone valences don't share a common negative sensation infillity that would correspond to a common origin of the stimulus-like space of cognitive objects. The above mentioned strong argument for the hyperbolic sensation and Euclidean stimulus spaces would then be misleading, because either the assumption of the existence of an underlying common object space for objects with monotone valences may be wrong or a common space origin might not exist for object attributes with monotone valences. In the latter case individual ideal axes may still have different orientations in a common response space, but if there is no underlying common object space then the fit of the solutions by the linear vector model must be rather poor. It also would mean that individual ideal axes need not to be parallel in the common Euclidean sensation space, but then the fit of the linear vector model must still be rather poor if adaptation points are different and/or no underlying common object space exists.

## 5.2. Open-hyperbolic or -Hnsler geometries of single-peaked valence spaces

Let a Euclidean sensation plane of objects with single-peaked valences be described by two orthogonal sensation dimensions that are weighted for their valence comparability to equal distances between the dimensional adaptation and ideal points and where the ideal point is the origin. Then the adaptation and saturation points on each of the dimensions correspond to four oppositely located sensation plane points  $(a_1, a_2)$ ,  $(s_1, s_2)$ ,  $(a_1, s_2)$  and  $(a_2, s_1)$  that have zero valences with the ideal point as centre. With maximum valence. The rotated dimension that contains the space adaptation point  $(a_1, a_2)$  and an opposite saturation point  $(s_1, s_2)$  as well as the ideal point as origin with maximum valence is an ideal sensation axis with single-peaked valences. However, the other orthogonal sensation dimension that originates from the maximum valence point also contains two opposite located sensation space points  $(a_1, s_2)$  and  $(a_2, s_1)$  with zero dimensional valences. So here the sensation dimension orthogonal to the ideal sensation axis corresponds not to an indifference axis, but its weighted sensation dimension also has a single-peaked valence function. In fact in comparably weighted sensation planes with ideal points as rotation centres all rotated sensation dimensions have single peaked valences and contain two points with zero valence at equal dimensional distances from the ideal point with a maximal valence. As shown in the sequel equally preferred objects are described by circular iso-valent contours with the ideal point as centre in such weighted Euclidean sensation planes. Sensation spaces with dimensional weights that equalise the dimensional distances between adaptation and ideal points make the valences for the weighted sensation dimensions comparable, while their corresponding valence dimensions have identical, symmetrically decreasing valences with respect to the maximum valence of the ideal point. Such weighted sensation spaces that are also translated to the ideal point are called valence-comparable Bower spaces in analogy to the intensity-comparable Bower spaces in chapter 4. The reflected saturation level with

respect to the adaptation point defines the deprivation level that generally coincides with the just noticeable sensation. Thereby, the dimensional sensation distance between the ideal and adaptation points generally equals half the dimensional distance of the adaptation point to the just noticeable sensation point as origin of the Fechner space. Thus, the weighing by weights  $2/a_{Jk}$  for intensity comparability generally equals the weighing for valence comparability by the inverse of dimensional distances between the adaptation and ideal points as weights  $1/d_{Jk} \approx 1/|a_{Jk}-g_{Jk}|$ , where

$$d_{Jk} \approx |a_{Jk} - g_{Jk}| \approx \sqrt{2} |a_{Jk} - s_{Jk}| \approx \sqrt{2} |a_{Jk} - u_{Jk}| = \sqrt{2} a_{Jk}$$

provided that the Fechner space origin defined by just noticeable sensations  $l_{Jk} \approx 0$  is also the deprivation space point defined by reflected saturation level  $s_{Jk}$  with respect to the adaptation point. Thus, for single-peaked valences with positive ambiances

$$s_{Jk} \approx 2a_{Jk} \quad \text{and} \quad g_{Jk} \approx \sqrt{2}(a_{Jk} + s_{Jk}) \approx 3a_{Jk}/2,$$

or for single-peaked valences with negative ambiances  $g_{Jk} \approx \sqrt{2}(a_{Jk} + u_{Jk}) \approx \sqrt{2} a_{Jk}$

Therefore, valence-comparable and intensity-comparable sensation spaces are differently translated and equally weighted Fechner spaces, if the dimensional deprivation levels coincide with the just noticeable sensation point as Fechner space origin. Clearly this may hold for Euclidean and hyperbolic sensation spaces.

### 5.2.1. Single-peaked valence spaces as transformed response spaces

In chapter 2 we defined single-peaked valences as the product of opposite response functions for sensation differences from respectively the adaptation and the saturation points or the adaptation and deprivation points. Thereby, single-peaked valence spaces become conveniently described in terms of metrically transformed response spaces. In the next mathematical subsection it is firstly shown that dimensional single-peaked valences can also be expressed by transformations of sensation distances  $d_{ji}$  between objects and the ideal point and distance  $d_j$  between the adaptation and ideal points, which for hyperbolic tangent-based, single-peaked valences give

$$\begin{aligned} v_{ji} &\approx \tanh[\frac{1}{2}(d_j - d_{ji})] \cdot \tanh[\frac{1}{2}(d_j + d_{ji})] \\ \text{whereby} \quad v_{ji} &= [\tanh^2(\frac{1}{2}d_j) - \tanh^2(\frac{1}{2}d_{ji})] / [1 - \tanh^2(\frac{1}{2}d_j) \cdot \tanh^2(\frac{1}{2}d_{ji})]. \end{aligned}$$

Defining quasi-responses  $t_{ji} \approx \tanh(\frac{1}{2}d_{ji})$  we see that hyperbolic tangent-based valences are defined by hyperbolic differences between squared responses  $t_{ji}^2$  with respect to the maximum valence  $v_{j, \max} \approx \tanh^2(\frac{1}{2}d_j)$  for  $d_{ji} = 0$ . The space of quasi-responses  $t_{ji}$  itself is either open-hyperbolic (if the sensation space is Euclidean and the stimulus space hyperbolic) or open-Euclidean (if the sensation space is hyperbolic and the stimulus space Euclidean). The single-peaked valences of Euclidean sensations can also derive from arctangent-based single-peaked valence functions if the stimulus space is double-elliptic, whereby their single-peaked valences are correspondingly written as

$$v_{ji} \approx \arctan[d_j - d_{ji}] \cdot \arctan[d_j + d_{ji}],$$

but this expression can't be rewritten in terms of elliptic difference of squared quasi-responses  $t_{ji}^2$  to a squared maximum quasi-response  $t_j^2$  of a single-elliptic quasi-response space.

Valence-comparable, Euclidean sensation spaces of hyperbolic stimuli define the dimensional distances to ideal points by  $dr_k/d_{J_k}$ . For  $m$ -dimensional Euclidean spaces of valence-comparable sensations the **single-peaked** valences are defined by

$$v_{J_i} = \tanh\left[\frac{1}{2}\left\{1 - \sqrt{\sum_{k=1}^{k=m} (d_{J_{ik}}/d_{J_k})^2}\right\}\right] \cdot \tanh\left[\frac{1}{2}\left\{1 + \sqrt{\sum_{k=1}^{k=m} (d_{J_{ik}}/d_{J_k})^2}\right\}\right]$$

with 
$$V_{J_j} = \tanh[V_2(1 - d_{J_i}/d_{J_j})] \cdot \tanh\left[\frac{1}{2}(1 + d_{J_i}/d_{J_j})\right]$$

where 
$$v_{\max} = \tanh^2(Yz) = 0.21355 \quad \text{and} \quad v_{\min} = -1,$$

and 
$$\zeta_{J_i} \cdot v_{J_i} = q_{J_i} = \tanh[-V_2(1 - d_{J_i}/d_{J_j})]$$

and 
$$\zeta_{J_i} = -1/\tanh\left[\frac{1}{2}(1 + d_{J_i}/d_{J_j})\right].$$

With reference to the theoretical possibility of single-elliptic response spaces from arctangent transformation of Euclidean sensations spaces, there also may exist single-peaked valence functions as products of arctangent functions of unity minus and plus the valence-comparable. Euclidean sensation distances with respect to individual ideal points. For a valence-comparable Euclidean sensation space that derives from a double-elliptic stimulus space we then analogously have

with 
$$v_{J_i} = \arctan[1 - d_{J_i}/d_{J_j}] \cdot \arctan[1 + d_{J_i}/d_{J_j}]$$

where 
$$v_{\max} = \arctan^2(1) = (\frac{1}{4}\pi)^2 = 0.61685 \quad \text{and} \quad v_{\min} = -\frac{1}{4}\pi^2 = -2.4674,$$

and 
$$\zeta_{J_i} \cdot v_{J_i} = q_{J_i} = [\arctan(1 - d_{J_i}/d_{J_j})]/(\frac{1}{2}\pi)$$

and 
$$\zeta_{J_i} = \frac{1}{2}\pi/\arctan[1 + d_{J_i}/d_{J_j}].$$

Since quasi-response spaces  $q_{J_i} = \zeta_{J_i} \cdot v_{J_i}$  are open-hyperbolic or single-elliptic spaces, single-peaked valence spaces  $v_{J_i}$  for valence-comparable Euclidean sensations are described by open spaces with variable curvatures  $\zeta_{J_i}$ , where its curvatures  $\zeta_{J_i}$  are defined by the inverse values of other quasi-response spaces. For the **arctangent-based** valences the factor  $\frac{1}{2}\pi$  is introduced in order to express the space curvatures in decimal values instead of radians. The spaces of single-peaked valences with curvatures  $\zeta_{J_i}$  define an open Finsler geometry with varying curvatures that in absolute value decrease with increasing distances to the ideal point. Equally preferred objects describe iso-valent circles or (hyper)spheres with the ideal point as centre in the open geometries of single-peaked valences for valence-comparable Euclidean sensations of objects with a non-Euclidean stimulus or attribute space. These circular iso-valent contours have different, but constant curvatures, because dependent on their radii as distances to the ideal point as circle centre. It defines the open Finsler geometry of single-peaked valence spaces to be conditionally rotation-invariant for the ideal point as rotation centre, since other rotation centres would change the point curvatures. Spaces with varying curvatures define a so-called Finsler geometry (Busemann, 1950b; Rund, 1959; Asanov, 1985; Matsumoto, 1986). The single-peaked valence spaces are described by open Finsler geometries with absolute curvatures that decrease with their valence distances to the ideal point (also with their valence-comparable, Euclidean sensation distances to the ideal point), whereby these spaces are very specific Finsler spaces.



In the next mathematical section we also show that hyperbolic-tangent-based single-peaked valences for valence-comparable Euclidean and hyperbolic sensations can also be written as

$$v_{Ji} = \tanh[-1/2 \ln(\cosh(d_{Ji}/d_J) / \cosh(1))].$$

Notice that here terms  $\cosh(d_{Ji}/d_J)$  express proper hyperbolic distances to the ideal point in hyperbolic spaces of valence-comparable sensations from Euclidean stimuli, while terms  $\cosh(d_{Ji}/d_J)$  for Euclidean sensation spaces are transformed distance terms. The inherently proper distance expression of valence-comparable hyperbolic sensation spaces can be regarded as a *strong theoretical argument for the hyperbolic nature of sensation spaces and the Euclidean nature of the stimulus space*. Independent dimensional distances  $\cosh(d_{Jik}/d_{Jk})$  multiply to space distance  $\cosh(d_{Ji}/d_J)$ , whereby open single-peaked valence spaces of hyperbolic sensation spaces have dimensional valences that are hyperbolically additive, which for two-dimensional spaces writes as

$$v_{Ji} = (v_{Jik} + v_{Jih}) / (1 + v_{Jik} \cdot v_{Jih})'$$

Single-peaked valence spaces for hyperbolic sensations also are projective transformations of flat spaces of  $d_{Ji} = \ln[\cosh(d_{Ji}/d_J)]$  with r-metric  $r=1$ , due to the city-block additivity of  $d_{Ji}$  that corresponds to the hyperbolic additivity of dimensional valences  $v_{Jik}$ . It defines single-peaked valence spaces of hyperbolic sensations to be open-hyperbolic spaces with a constant curvature  $\zeta = -\sqrt{2}$ , because  $\zeta = r/2$  specifies the relationship between curvatures of non-Euclidean spaces and r-metrics of corresponding flat spaces, as derived in section 3.1. The open-hyperbolic geometry of single-peaked valences for hyperbolic sensations also follows from the equality

$$\tanh^2(1/2 d_{Ji}/d_J) = (v_{max} - v_{Ji}) / (1 - v_{max} \cdot v_{Ji})$$

because  $(v_{max} - v_{Ji}) / (1 - v_{max} \cdot v_{Ji})$  equals a hyperbolic valence difference from the maximum valence point, which by  $\tanh^2(1/2 d_{Ji}/d_J)$  equals a parabolic distance as squared distance of open-Euclidean quasi-response spaces. The conformal distance metric of hyperbolic sensation spaces and their open-hyperbolic single-peaked valence spaces applies not for the flat sensation spaces with open Finsler geometries of their single-peaked valences, which is *another theoretical argument for the hyperbolic geometry of sensation spaces and the Euclidean geometry of stimulus spaces*.

In two-dimensional, single-peaked valence spaces and in corresponding hyperbolic or Euclidean spaces of valence-comparable sensations the iso-valent contours are circles, because single-peaked valences  $v_{Ji}$  are monotonic transformations of  $d_{Ji}/d_J$ . Notice further that the inverse function transformation of single-peaked valences  $v_{Ji} = \tanh[-\sqrt{2} \ln\{\cosh(d_{Ji}/d_J) / \cosh(1)\}]$  with an open-hyperbolic or open-Finsler geometry defines an explicit transformation to  $d_{Ji}/d_J$ , whereby the corresponding common Euclidean stimulus or sensation space can be solved from optimally scaled single-peaked valences of several individuals, as shown in section 5.4.3. A hyperbolic or elliptic additivity of dimensional valences holds not for open Finsler spaces of single-peaked valences that derive from valence-comparable Euclidean sensation spaces. However, its hyperbolic tangent-based valences define

$$\sqrt{2} d_{Ji}/d_J = \operatorname{artanh}[\{ (v_{max} - v_{Ji}) / (1 - v_{max} \cdot v_{Ji}) \}]$$

whereby it follows for m-dimensional, valence-comparable Euclidean sensation spaces of hyperbolic stimuli that

$$\left(\frac{v_i - v_1}{1 - v_i v_1}\right) / \left(\frac{v_j - v_1}{1 - v_j v_1}\right) = \tanh^2 \left( \sqrt{\sum_{k=1}^m \operatorname{arctanh}^2 \left[ \frac{v_k - v_1}{1 - v_k v_1} \right]} \right)$$

It is tempting to assume by analogy of the hyperbolic tangent function that also  $\operatorname{arctan}^2(d_i/d_j) = (v_i - v_1)/(1 - v_i v_1)$  holds for arctangent-based single-peaked valences of Euclidean sensations, but for  $v_i = \operatorname{arctan}[1 - d_i/d_j]$ , we could not prove that this holds. We can rewrite the latter product of arctangent functions by differences between squared arctangent functions of functions for  $d_i/d_j$ . However, it describes these single-peaked valences as differences between the squared values of two variable points in a single-elliptic space. Thereby, no direct solution of  $d_i/d_j$  by an explicit inverse function of  $v_i$  seems possible for arctangent-based single-peaked valences. But, since  $d_i/d_j = 1 - \operatorname{arctan}(\frac{1}{2}\pi - \zeta_{ji} - v_{ji})$  with their variable curvatures  $\zeta_{ji} = \operatorname{arctan}[1 + d_i/d_j]$  we can iteratively solve  $d_i/d_j$  by initial and successively improved values of  $\zeta_{ji}$  and optimally scaled bipolar preferences as  $v_{ji}$ . The observed bipolar preferences (negative and positive rank order values for respectively disliked liked objects or bipolar preference ratings) need to be scaled to values  $v_{ji}$  that allow the application of their inverse transformation  $d_i/d_j$  or  $\cosh(d_i/d_j)$ . It means that initial and iteratively optimal scaling of observed bipolar preference data must be between  $v = .21355$  and  $v = -1$  or  $v = .61685$  and  $v = -2.4674$  under preservation of  $v_{\max}$  signs. Consequently a solved bipolar preference space always is Euclidean (again) sensation spaces are not observable, but are derived spaces from response or valence spaces wherefrom Minkowskian sensation spaces can't be derived), while a solved hyperbolic sensation space corresponds to a Euclidean object or stimulus space. In the next mathematical section we derive the geometric aspects of the respectively different open spaces of single-peaked valences, as summarised above, from the metric valence transformations of a common Euclidean or hyperbolic sensation space.

We again define:  $m$  dimensions by indices  $\{1.., k, l, .., m\}$   
 $N$  individuals by indices  $\{1.., I, J, .., N\}$   
 $n$  choice objects by indices  $\{1.., i, j, .., n\}$

In case of single-peaked valence functions the valences are defined by (25a) as products of positively and negatively signed hyperbolic tangent functions of unidimensional sensations  $y_i$  with respect to individual adaptation and saturation points  $a_j$  and  $s_j$  on a sensation dimension. For individual ideal point  $g_j = \frac{1}{2}(s_j + a_j)$ , we obtain by (25a) single-peaked valences with a positive ambience as product of the next two hyperbolic tangent functions

$$\left. \begin{aligned} \text{and} \quad \tanh\left[\frac{1}{2}(y_i - a_j)J\right] &= \tanh\left[\frac{1}{2}\{(g_j - a_j) + (y_i - g_j)\}\right] \\ \tanh\left[-\frac{1}{2}(y_i - s_j)J\right] &= \tanh\left[\frac{1}{2}\{(g_j - a_j) - (y_i - g_j)\}\right]J, \end{aligned} \right\}$$

while for single-peaked valences with negative ambiances the sign of the first functions only interchanges, where in both cases the single-peaked valences  $v_{ji}$  are written by  $d_{ji} = \frac{1}{2}(a_j - g_j)$  and  $d_{ji} = \frac{1}{2}(y_i - g_j)$  as

$$V_{J_i} = \tanh[\frac{1}{2}(d_J - d_{J_i})] \cdot \tanh[\frac{1}{2}(d_J + d_{J_i})]. \quad (64a1)$$

Notice that (64a1) can be rewritten by the hyperbolic trigonometric expressions  $\tanh(a - b) = [\tanh(a) - \tanh(b)] / [1 - \tanh(a) \cdot \tanh(b)]$  and  $\tanh(a + b) = [\tanh(a) + \tanh(b)] / [1 + \tanh(a) \cdot \tanh(b)]$  as

$$\frac{\tanh^2[\frac{1}{2}d_J] - \tanh^2[\frac{1}{2}d_{J_i}]}{1 - \tanh^2[\frac{1}{2}d_J] \cdot \tanh^2[\frac{1}{2}d_{J_i}]} \quad (64a2)$$

We redefine valence-comparable Euclidean sensation distances that are weighted by  $Id$ , where valence- and intensity-comparable sensations are equal, if  $d_J = \frac{1}{2}a_J$ , which holds if the deprivation level equals the just noticeable sensation level. Rewriting (64a1) for dimensional terms of valence-comparable Euclidean sensation distances, we have

$$v_{J_{ik}} = \tanh[\frac{1}{2}(1 - d_{J_i} \cdot k/d_{Jk})] \cdot \tanh[\frac{1}{2}(1 + d_{J_i} \cdot k/d_{Jk})]. \quad (64a3)$$

whereby valence-comparable Euclidean distances in a  $m$ -dimensional space define

$$v_{J_i} = \tanh[\frac{1}{2}(1 - \sqrt{\sum_{k=1}^{k=m} (d_{J_{ik}} \cdot Id_{Jk})^2})] \cdot \tanh[\frac{1}{2}(1 + \sqrt{\sum_{k=1}^{k=m} (d_{J_{ik}} \cdot Id_{Jk})^2})] \quad (64a4)$$

or

$$v_{J_i} = \tanh[\frac{1}{2}(1 - d_{J_i}/d_J)] \cdot \tanh[\frac{1}{2}(1 + d_{J_i}/d_J)], \quad (64a5)$$

whereby the maximum space valence for  $d_{J_i} = 0$  is defined as

$$v_m = \tanh^2(\frac{1}{2}) = \tanh[\frac{1}{2} \ln(\cosh(1))]. \quad (64a6)$$

Defining

$$c_{J_i} = -1/\tanh[\frac{1}{2}(1 + d_{J_i}/d_J)] \quad (64a7)$$

$$c_{J_i} \cdot v_{J_i} = q_{J_i} = \tanh[-\frac{1}{2}(1 - d_{J_i}/d_J)] \quad (64a8)$$

we specify varying curvatures  $c_{J_i}$  of the single-peaked valence space for valence-comparably weighted, Euclidean sensation spaces. Its quasi-response space  $q_{J_i}$  is the curvature-corrected valence space with a curvature of  $-1$ . Thus, we have a single-peaked valence space with negative curvatures that in absolute value decrease with increasing distances to the ideal point if the stimulus space is hyperbolic. The single-peaked valences  $v_{J_i} > 0$  if  $d_{J_i} < d_{J_i}$  and else  $v_{J_i} \leq 0$ . For valence spaces from products of inverse tangent functions as single peaked valence function for Euclidean sensations we define, by the replacement of  $\arctan(x)$  functions for  $\tanh(-\frac{1}{2}x)$  functions in (64a4) to (64a7) in case of a double-elliptic stimulus geometry, analogously

$$v_{J_{ik}} = \arctan[1 - d_{J_{ik}} \cdot Id_{Jk}] \cdot \arctan[1 + d_{J_{ik}} \cdot Id_{Jk}], \quad (64b1)$$

whereby

$$v_{J_i} = \arctan[1 - \sqrt{\sum_{k=1}^{k=m} (d_{J_{ik}} \cdot Id_{Jk})^2}] \cdot \arctan[1 + \sqrt{\sum_{k=1}^{k=m} (d_{J_{ik}} \cdot Id_{Jk})^2}] \quad (64b2)$$

$$v_{J_i} = \arctan[1 - d_{J_i}/d_J] \cdot \arctan[1 + d_{J_i}/d_J]. \quad (64b3)$$

whereby the maximum space valence for  $d_{J_i} = 0$  is defined as

$$v_m = \arctan'(1) = (\frac{1}{2}\pi)^2 = 0.61685. \quad (64b4)$$

Here

$$c_{J_i} \cdot v_{J_i} = q_{J_i} = \arctan[1 - d_{J_i}/d_J] / (\frac{1}{2}\pi) \quad (64b5)$$

with

$$\zeta_{J_i} = \frac{1}{2}\pi / \{\arctan(1 + d_{J_i}/d_J)\}. \quad (64b6)$$

Here the scaling by  $\frac{1}{2}\pi$  is introduced in order to express the curvature parameter in decimal values instead of radians. From (64b6) we see that this single-peaked valence space has varying elliptic curvatures. Since the quasi-response space of  $q$ , is here an open single-elliptic space with unit curvature, also its single-peaked valence space has an open geometry with positive curvatures that decrease with the Euclidean sensation distance to the ideal point.

single-peaked valence spaces of valence-comparably weighted Euclidean sensation spaces are rotation-invariant, conditional to their ideal points as rotation centres, which follows from (64a) and (64b). Without the valence-comparable weighing of sensation dimensions, we would have different curvatures for equal dimensional valence distances to ideal points, which then would not define a conditional rotation invariance. For hyperbolic tangent-based valences of valence-comparable Euclidean sensations of hyperbolic stimuli it follows from (64a6) that the maximum curvature is obtained at the ideal point, where  $d_{J_i} = 0$ , as

$$\zeta_m = -1/\tanh(\frac{1}{2}) = 2.164 \quad \text{Id}_{J_i} = 0 \quad (64c1)$$

while the curvature at the zero valences of the indifference circle or (hyper) spheres becomes defined by  $d_{J_i} = d_J$  as

$$\zeta_o = -1/\tanh(1) = 1.313 \quad \text{Id}_{J_i} = d_J \quad (64c2)$$

For comparable valence dimensions from the product of two arctangent functions of weighted Euclidean sensation dimensions we similarly obtain the curvatures at the ideal point and for zero valences from (64b5) by respectively  $d_{J_i} = 0$  and  $d_{J_i} = d_J$  as

$$\text{and } \zeta_m = \frac{1}{2}\pi / [\arctan(1) + 1] = 2 \quad \text{Id}_{J_i} = 0 \quad (64d1)$$

$$\zeta_o = \frac{1}{2}\pi / [\arctan(2) + 1] = 1.419 \quad \text{Id}_{J_i} = d_J \quad (64d2)$$

For valences as products of response functions always  $|\zeta_{J_i}| < \zeta_m$ , where if  $d_{J_i}$  values approach infinity we see by (64a6) that the curvature  $\zeta_{J_i}$  approaches -1 as the negative minimum curvature of valences for the sensations that approach the negative or positive infinity. There also its valences thus approach -1. Similarly (64d4) yields positive values of curvatures that reach a maximum at the ideal point and decreases to 1 for  $\arctan[1 + d_{J_i}/d_J]$  approaching its maximum of  $\frac{1}{2}\pi$ .

In case the stimulus space is Euclidean and, thus, the sensation space hyperbolic then the sensation distances are measured by the hyperbolic cosine of hyperbolic distances. But hyperbolic sensation distances derive directly from dimensional expressions of (64a1), because again by

$$\tanh(s) \cdot \tanh(t) = \frac{2 \cdot \sinh(s) \cdot \sinh(t)}{2 \cdot \cosh(s) \cdot \cosh(t)} = \frac{\cosh(s+t) - \cosh(s-t)}{\cosh(s+t) + \cosh(s-t)}$$

we obtain for  $s = (d_{Jk} - d_{Jik})/d_{Jk}$  and  $t = (d_{Jk} + d_{Jik})/d_{Jk}$

$$\cosh(1) = \cosh(d_{Jik} Id_{Jk})$$

$$[\cosh(d_{Jik} Id_{Jk})]_J \cdot [\cosh(d_{Ji} Id_{Ji})] = \cosh(d_{JI} Id_{JI}),$$

whereby it follows from (64e3) for a m-dimensional valence space that

$$v_{JI} = \tanh\left[\sum_{k=1}^{k=m} \tanh(v_{Jik})\right] \quad (65a1)$$

It defines a relativistic additivity (Krantz, et al., 1971, pp.91-101) that as hyperbolic additivity of two valence dimensions writes as

$$v_{Ji} = (v_{Jik} + v_{Jih}) / (1 + v_{Jik} \cdot v_{Jih}) \quad (65a2)$$

For a m-dimensional hyperbolic sensation spaces (65a1) is written as

$$v_{JI} = \tanh\left[\sum_{k=1}^{k=m} \frac{1}{2} \ln\{\cosh(d_{Jik} Id_{Jk} / \cosh(1))\}\right], \quad (65a3)$$

where the addition of logarithmic terms define dimensional products of  $\text{COSH}(d_{Jik}/d_{Jk})$  that combine to  $\text{COSH}(d_J/d_{JI})$  as

$$v_{JI} = \tanh\left[\frac{1}{2} \ln\{\cosh(d_{JI} Id_{JI} / \cosh(1))\}\right]. \quad (65a4)$$

Thereby also the maximum space valence for  $d_{JI} = 0$  is defined as

$$v_m = \tanh^2(1/2) = \tanh[1/2 \ln\{\cosh(1)\}], \quad (65a5)$$

while  $v_{JI} > 0$  if  $d_{Ji} < d_J$  and  $v_{JI} \leq 0$  if  $d_{Ji} \geq d_J$ .

Defining

$$d_{Jik} = \ln[\cosh(d_{Ji} Id_{Ji} / d_{Jk})] \quad \text{and} \quad d = \cosh(1) = 1.5431$$

where  $d_{Jik}$  are dimensional distances to the ideal point in a Minkowski sensation space with  $r = 1$  of sensations from power-raised conjugate stimulus fraction midpoints (csfm) with respect to the ideal stimulus in a Euclidean stimulus space, defined by

$$\text{with} \quad d_{Jik} = \ln\left\{\frac{1}{2} \left[ \left(\frac{X_{ik}}{p_{J!<.:}}\right)^p + \left(\frac{p_{J!<.:}}{X_{ik}}\right)^p \right] \right\} \quad (65b1)$$

$$p_{J!<.:} = 1/d_{J!<.:} = 1/\ln\{b_{Jk}/p_{J!<.:}\}. \quad (65b2)$$

We rewrite (64e2) or (64e3) as

$$v_{Jik} = \frac{1 - \exp(d_{Jik} - d)}{1 + \exp(d_{Jik} - d)} = \tanh\left[-\frac{1}{2}(d_{Jik} - d)\right] \quad (65b3)$$

whereby (65a3) and (64a3) are here rewritten as

$$v_{Ji} = \tanh\left[\frac{1}{2} \sum_{k=1}^{k_{em}} (d_{Jik} - d)\right] = \tanh\left[-\frac{1}{2}(d_{Ji} - d)\right] \quad (65b4)$$

Thereby, we see that single-peaked valences for hyperbolic sensation spaces are described by open-hyperbolic spaces as quasi-response spaces to distance differences  $(d_{Ji} - d)$  in a flat csfm-sensation space with r-metric  $r = 1$  for power-raised csfm-stimulus spaces. Thus, single-peaked valence spaces of hyperbolic sensations are not open Finsler space geometries with variable, negative curvatures, but open-hyperbolic geometries with a constant curvature  $\zeta = -1/2$ , because  $|\zeta_{-1}| = r/2$  defines the relationship between the curvatures of non-Euclidean space and the r-metrics of corresponding flat spaces, as derived in section 3.1. The open-hyperbolic geometry with curvature  $\zeta = -1/2$  also follows from (64a21) with its arguments divided by  $d_{Ji}$ , whereby for  $v_m = \tanh'(1/2)$  as maximum valence (64a2) becomes rewritten as

$$\tanh^2\left(\frac{1}{2} \frac{d_{Ji}}{d_{Ji}}\right) = (v_m - v_{Ji}) / \{1 - v_m v_{Ji}\}, \quad (65b5)$$

where  $\tanh'(1/2)$  specifies a squared, parabolic distance of an open Euclidean quasi-response space that equals a hyperbolic valence distance to the maximum valence space point.

Here the open valence space is an involution space of valence-comparably weighted hyperbolic sensation distances with respect to the ideal point. It is equivalently described by quasi-response spaces of responses to differences between variable and a fixed distance to the ideal point in a csfm-sensation space with Minkowski metric  $r=1$ , because the logarithm of hyperbolic cosine for hyperbolic space distances transform these distances to distances in a space with a city-block metric. The negative hyperbolic tangent transformations of these city-block space distances minus a fixed space distance define the valence spaces as open spaces with a hyperbolically additive metric for independent valence dimensions of the open single-peaked valence space, wherein iso-valent contours are circles or (hyperspheres with the ideal point as centre. In valence-comparably weighted hyperbolic sensation spaces the iso-valent contours are also circles or (hyper)spheres, because values of  $v_{Ji}$  are monotonic transformations of  $\cosh(d_{Ji}/d_{Ji})$ , while iso-valent circles correspond to iso-distant squares in the city-block space of csfm-sensations for Euclidean stimuli.

The single-peaked valences as product of hyperbolic tangent functions of valence-comparable Euclidean sensation distances also define by

$$\tanh(s) - \tanh(t) = \frac{2 \cdot \sinh(s) \cdot \sinh(t)}{2 \cdot \cosh(s) \cdot \cosh(t)} = \frac{\cosh(s+t) - \cosh(s-t)}{\cosh(s+t) + \cosh(s-t)}$$

for  $d_{Ji} = 0$  or  $s = t = 1/2$  the maximum valence as

$$v_m = \tanh\left[\frac{1}{2} \ln\{\cosh(1)\}\right] = \tanh'(1/2) \quad (66a)$$

while single-peaked valence dimensions of (64a3) are rewritten as

$$v_{Jik} = \tanh\left[-\frac{1}{2} \ln\left\{\frac{\cosh(d_{Jik}/d_{Jk})}{\cosh(1)}\right\}\right] \quad (66a21)$$

where

$$\tanh[-\frac{1}{2} \ln \{ \cosh(\sqrt{\sum_{k=1}^{k=m} (d_{Ji,k}^2 / d_{Ji}^2)} \cosh(1)) \}] \tag{66a2}$$

or

$$\tanh[-\frac{1}{2} \ln \{ \cosh(d_{Ji} / d_{Ji} \cosh(1)) \}] \tag{66a3}$$

Since here the sensation distances  $d_{Ji} / d_{Ji}$  are Euclidean,  $\cosh(d_{Ji} / d_{Ji})$  defines no distances in weighted Euclidean sensation spaces. However, (64a3) with its arguments divided by  $d_{Ji}$  defines

$$v_{Ji} = [v_m - \tanh^2(\frac{1}{2} \ln \{ \cosh(d_{Ji} / d_{Ji} \cosh(1)) \})] / [1 - v_m \cdot \tanh^2(\frac{1}{2} \ln \{ \cosh(d_{Ji} / d_{Ji} \cosh(1)) \})] \tag{66a4}$$

where  $v_m = \tanh^2(\frac{1}{2})$  is a known constant, whereby we derive from  $v_{Ji}$

$$d_{Ji} Id_{Ji} = 2 \cdot \{ \arctan \{ [ \{ v_m - v_{Ji} \} / (1 - v_m \cdot v_{Ji}) ] \} \} \tag{66a5}$$

Thus, we could solve a common Euclidean sensation space by an individual difference unfolding analysis, but in section 5.4.3 we present a more robust solution method. Dimensional expressions of (66a5) also define

$$\tanh'(\frac{1}{2} \ln \{ \cosh(d_{Ji,k} / d_{Ji} \cosh(1)) \}) = t_{Ji}^2 \cdot k = (v_m - v_{Ji,k}) / (1 - v_m \cdot v_{Ji,k}) \tag{66a6}$$

Here  $(v_m - v_{Ji,k}) / (1 - v_m \cdot v_{Ji,k})$  is a squared hyperbolic distance from  $v_m$ , because  $t_{Ji}$  defines a hyperbolic distance in an open space of the quasT-responses  $t_{Ji}$  to valence-comparable Euclidean sensation distances from the ideal point. Since  $t_{Ji}$  is an open-hyperbolic space, the multiplication dimensional terms  $\cosh(t_{Ji} \cdot k)$  defines  $\cosh\{t_{Ji}\}$ , whereby here

$$\prod_{k=1}^{k=m} \cosh\{v\{ (v_m - v_{Ji,k}) / (1 - v_m \cdot v_{Ji,k}) \}\} = \cosh\{v\{ (v_m - v_{Ji}) / (1 - v_m \cdot v_{Ji}) \}\} \tag{66a7}$$

Moreover, since  $\arctan(t_{Ji} \cdot k)$  is a distance on Euclidean dimension we also have

$$\arctan(t_{Ji}) = \sum_{k=1}^{k=m} \arctan(t_{Ji,k})$$

whereby

$$(v_m - v_{Ji}) / (1 - v_m \cdot v_{Ji}) = \tanh^2 \{ \sum_{k=1}^{k=m} \arctan^2 [ v\{ (v_m - v_{Ji,k}) / (1 - v_m \cdot v_{Ji,k}) \} ] \} \tag{66a8}$$

For the arctangent-based valences of (64b) it is tempting to assume that similar expressions hold by analogy for an elliptically transformed difference between  $v_m$  and  $v_{Ji}$  under replacement of  $\tanh(-\frac{1}{2}x)$  by  $\arctan(x)$  or  $\arctan(-\frac{1}{2}x)$  by  $\tan(x)$ , but we could not prove that the analogy holds for single-peaked valences defined by (64b). We may rewrite (64b3) as a difference of squared arctangent functions by the trigonometric equality  $\arctan(x) - \arctan(z) = \arctan[(x - z) / (1 + x \cdot z)]$ , wherein the sum and difference operations interchange, which defines

$$\arctan(1 - d_{Ji} Id_{Ji}) + \arctan(1 + d_{Ji} Id_{Ji}) = \arctan[2 / (d_{Ji} Id_{Ji})^2] \tag{66b1}$$

$$\arctan(1 - d_{Ji} Id_{Ji}) - \arctan(1 + d_{Ji} Id_{Ji}) = \arctan[(2d_{Ji} Id_{Ji} / (2 - (d_{Ji} Id_{Ji})^2))] \tag{66b2}$$

whereby the product of the sum and difference of both expressions yields for (64b3) also

$$v_{Ji} = \frac{1}{2} [\arctan^2 [2 / (d_{Ji} Id_{Ji})^2] - \arctan^2 [(2d_{Ji} Id_{Ji} / (2 - (d_{Ji} Id_{Ji})^2))] ] \tag{66c1}$$

However, it are two squared arctangent functions without a constant argument for one of these functions, which is different from (66a5). Thus, here we have no explicit function transformation of  $v_{J_i}$  to  $d_{J_i} Id_J$ , which is in contrast to (66a4) or (66a6) and whereby thus no direct solution is possible. Nonetheless (66c1) shows that arctangent-based valences are differences between squared values of points in a single-elliptic space. However, it concerns two variable space points, instead of a variable distance with respect to a fixed maximum space point, which is why here we only can iteratively solve  $d_{J_i} Id_J$  from  $v_{J_i}$ . Using (64b4) and initial estimates  $\varphi_{J_i}$  that satisfy (64a) we obtain from

$$1 - \tan(\frac{\pi}{2} \cdot \varphi_{J_i} \cdot v_{J_i}) = d_{J_i} Id_J \quad (66c2)$$

initial estimates of  $d_{J_i}/d_J$  and, thereby, improved curvatures from

$$\varphi_{J_i} = (\frac{\pi}{2}) / \{\arctan(1 + dJ/d_J)\}, \quad (66c3)$$

where further alternated improvements converge to the solution of  $J/d_J$ .

Iso-valent contours are circles (or hyper-spheres) with the ideal point as centre in single-peaked valence spaces and in valence-comparable sensation spaces. For valence-comparable E'uclydean sensation spaces this follows from the monotonic radius transformations of sensation space circles with radius  $d_{J_i} Id_J$  to iso-valent circles with curvatures  $\varphi_{J_i}$  in their single-peaked valence spaces, as expressed by (64a) and (64b).

Summarising the mathematical section above it is demonstrated that the single-peaked valence spaces of valence-comparable sensations are equivalently described:

- by products of two response functions for valence-comparable sensation differences with respect to the adaptation and saturation points (positive ambiance) or to the deprivation and adaptation points (negative ambiance);
- in case of Euclidean sensation spaces by products of hyperbolic tangent or arctangent functions. one for the sum and the other for the difference of unity and the valence-comparable distances  $d_{J_i} Id_J$  between objects and the ideal point. The function for the mentioned sum defines the open-hyperbolic or single-elliptic quasi-response space of curvatures for the open Finsler space of single-peaked valences. while the function for the mentioned differences specify the corresponding quasi-response space of curvature-corrected single-peaked valences.
- in case of hyperbolic tangent-based, single-peaked valences we can write them by one hyperbolic tangent function of logarithmically transfonned. hyperbolic cosine function of valence-comparable sensation distances to the ideal point. For hyperbolic sensation spaces this valence expression concerns a hyperbolic transfonnation of distances  $\ln[\cosh(d_{J_i}/d_J)]$  in a city-block space. because the multiplication of dimensional distances define space distance  $\cosh(d_{J_i} Id_J)$  in hyperbolic spaces. Thereby it defines an open-hyperbolic space of single-peaked valences with curvature  $\varphi = -Yzand$  hyperbolic additivity of its valence dimensions.

A Fechner sensation space that is individually translated to ideal points and weighted to equal dimensional distances between the adaptation and ideal points and is individually translated to the ideal point is a valence-comparable Bower space. Its



corresponding single-peaked valence spaces are rotation-invariant spaces conditional to the ideal point as rotation centre, because their valences define iso-valent contours that are space circles with the ideal point as centre and constant curvatures. The curvature of single-peaked valence spaces is variable and positive, if the stimulus is double-elliptic, or variable and negative if the stimulus space is hyperbolic, but its curvature is constant  $-\frac{1}{2}$ , if the stimulus space is Euclidean. Hyperbolic tangent-based, single-peaked valence spaces of valence-comparable Euclidean sensation spaces imply that

$$\frac{1}{2} \frac{dJ_i}{dJ} = \arctanh \left\{ \sqrt{[(v_{\max} - v_{j_i}) / (v_{\max} - v_{j_i})]} \right\}.$$

Since  $v_{\max} = \tanh^2(V_2)$  is a known constant, Euclidean sensation distances  $dJ/dJ_i$  to ideal points with hyperbolic tangent-based valences can be solved from optimally scaled preference rank orders to values  $v_{j_i}$ . Single-peaked valence spaces of hyperbolic sensation spaces imply

$$\cosh(dJ/dJ_i) = \cosh C_i \cdot \exp[2 \{ \arctanh C - v_{j_i} \}]$$

whereby also the hyperbolic valence-comparable sensation distances  $\cosh C_i dJ/dJ_i$  can directly be solved from optimally scaled values of  $v_{j_i}$ . However, Euclidean sensation distances  $dJ/dJ_i$  can't directly be derived from arctangent-based single-peaked valences, but their iterative solutions can be obtained. In the sequel we describe methods for the analyses of preferences by their representation in a common Euclidean sensation or stimulus space, but first we illustrate how single-peaked preferences become represented by two-dimensional plots of iso-valent contours as contours of equally preferred objects in flat spaces.

### 5.2.2. Iso-valent contours of single-peaked valences

Since the absolute space curvatures of single-peaked valences for valence-comparable Euclidean sensations decrease with the valence distances to the ideal point, its iso-valent contours in a two-dimensional single-peaked valence space are circles with different, but constant curvatures and the ideal point as centre. Iso-valent contours are also circles on the hyperbolic surface with constant curvature  $-\frac{1}{2}$  for single-peaked valences of hyperbolic sensations. Therefore, also in the quasi-response spaces that correspond to curvature corrected single-peaked valence spaces the iso-valent contours are circles with the ideal point as centre. One of the iso-valent circles is the indifference circle, where iso-valent circles inside the indifference circle have positive valences and outside negative valences. Since the valence curvatures and curvature-corrected valences of single-peaked valence spaces are open-hyperbolic or single-elliptic quasi-response spaces with the ideal point as centre, their single-peaked valences also are defined by products of projected Euclidean sensation spaces. While open-hyperbolic, single-peaked valence spaces correspond to hyperbolic sensation spaces. A solved common sensation space is always a hyperbolic or Euclidean sensation space, even if in the fanner case the single-peaked valences would be generated from a Minkowskian sensation space. Below in figure 32 illustrates the iso-valent circles in the open-Euclidean space of quasi-responses for single-peaked valences of hyperbolic sensations.

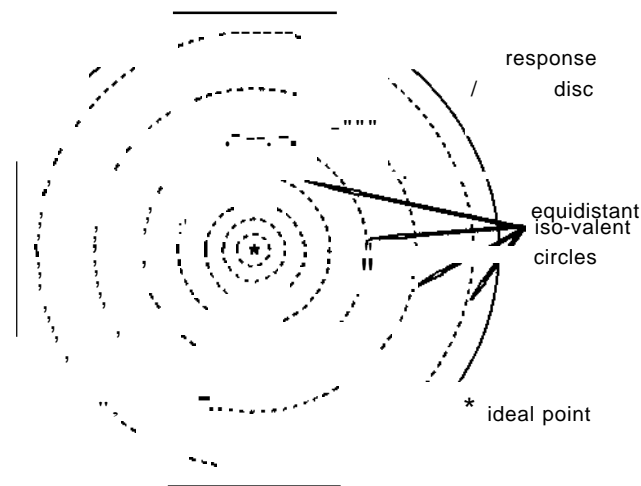

Figure 32. Iso-valent circles in an open-Euclidean quasi-response plane.

For objects from a non-Euclidean stimulus space the iso-valent contours are similar circles on hyperbolic or elliptically curved open surfaces for the quasi-response space of curvature-corrected, single-peaked valences. The derivable sensation spaces from single-peaked valence spaces are individually translated to the ideal point and weighted dimensionally by  $1/d_{Jk}$  for the valence-comparability of the dimensional sensations, where  $d_{Jk}$  is the distance between the dimensional adaptation and ideal points of individuals. If we assume that the dimensional deprivation levels coincide with their just noticeable level as Fechner space origin, then  $d_{Jk} = 1/2a_{Jk} = 1/2(a_{Jk} - u_{Jk})$  for  $u_{Jk} = 0$  as just noticeable dimensional sensation. Such individually weighted Euclidean sensation spaces are valence-comparable and are also called Euclidean Bower spaces in analogy to the intensity-comparable Euclidean Bower spaces that can only differ from each other by translations to individual adaptation and ideal space points, if  $d_{Jk} = 1/2a_{Jk}$ . Since hyperbolic space distances are measured by their hyperbolic cosine, the hyperbolic Bower space of valence-comparable sensations is similarly defined by  $\cosh(dr/d_{Jk})$ .

In Euclidean or hyperbolic Bower spaces iso-valent contours are also circles, but the sensation differences between these iso-valent circles represent not preference differences, because their differences equal not the valence differences between the iso-valent circles in their open single-peaked spaces. However, if a hyperbolic Bower surface is mistaken to be a Euclidean Bower plane then the iso-valent contours are no longer circular in a Bower plane that is incorrectly assumed to be Euclidean. Mistaking  $d_{Jk} \cosh(dr/d_{Jk})$ , the iso-valent contours of Euclidean Bower planes that actually are hyperbolic surfaces become represented as Minkowskian iso-distant contours with r-metrics that decrease with increases of their dimensional sensation distances to the ideal point. Due to the relationship between curvatures and r-metrics the Minkowskian

iso-distant contours with variable *r*-metrics  $r_{J_i}$  are defined for individually oriented dimensions *k* and *l* by

$$\{[d_{Jik}/d_{Jk}]^{r_{J_i}} + [d_{Jil}/d_{Jl}]^{r_{J_i}}\}^{1/r_{J_i}} = d_{j/c1} = \text{constant},$$

where for object *i* and individual *J* the *r*-metric is defined by

$$r_{J_i} = 1/\tanh[1/2(1 + d_{J_i}/d_J)]$$

Figure 33 below shows such iso-valent contours in a Euclidean Bower plane, where they actually are circles on a hyperbolic Bower surface.

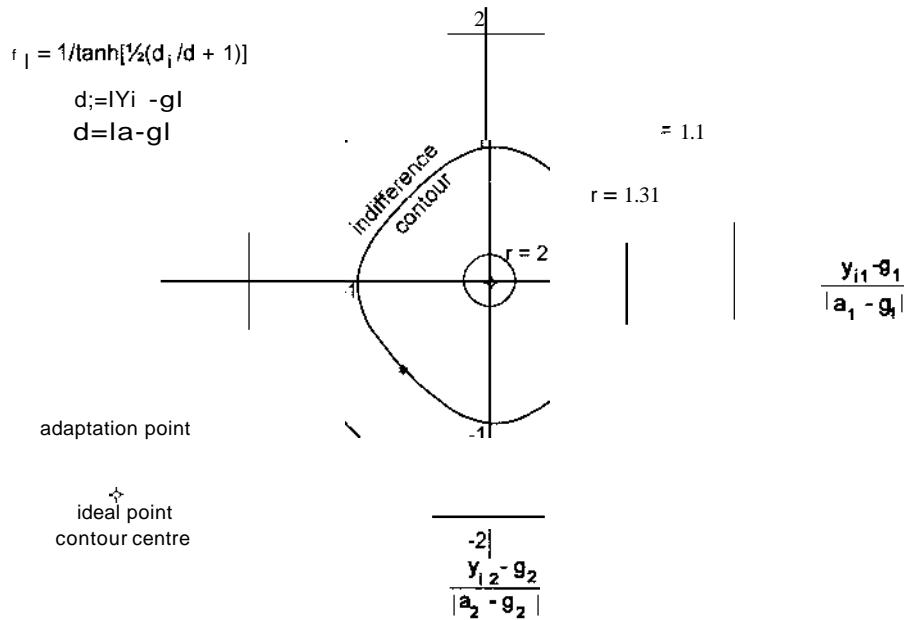

Figure 33. Iso-valent contours in a Euclidean Bowerplane that actually is hyperbolic

Here  $c_1$  are the incorrectly Euclidean distances between individual adaptation and ideal points, while distances  $c_2$  are the incorrectly Euclidean distances of sensation  $y_i$  to the individual ideal point  $g_i$ . An iso-valent sensation contour corresponds to the iso-distant contour with  $r_{J_i} = 1$  if  $\tanh[1/2(d_{J_i}/d_J + 1)] = 1$ , which then becomes the iso-distant square for sensations at infinite distances from the ideal point in Euclidean Bower planes that actually are hyperbolic Bower surfaces. The iso-valent, Minkowskian iso-distant contour for  $d_{J_i} = d_J$  is the indifference contour with  $r_{J_i} = 1/\tanh(1) = 1.313$ , while the maximum  $r_{J_i}$  metric for  $d_{J_i} = 0$  as contour that reduces to the ideal point is  $r_{J_i} = 1/\tanh(1/2) = 2.164$ . Only the iso-valent circle in the single-peaked valence space with such a distance  $d$ , in an incorrectly Euclidean Bower plane that yields a *r*-metric of  $r_{J_i} = 2$  remains an iso-valent circle, which is thus closely located around the ideal point with  $r_{J_i} = 2.164$ . The ideal points are the individual centres of individually

oriented, iso-valent Minkowskian contours in incorrectly Euclidean-assumed Bower planes. Thus, in a correspondingly mistaken Euclidean, common sensation plane the individual iso-valent contours become differently located, oriented, and asymmetrically skewed Minkowskian iso-distant contours, where their orientation and skewness depend on the orientation and the weights of the relevant dimensions for the individual preference evaluation. Single-peaked valence functions as products of arctangent functions also define iso-valent circles in a Euclidean Bowerplane, while no hyperbolic Bower space applies for arctangent based-valences, whereby no similarly incorrect iso-valent contours of figure 33 exist in this case.

If a Bower plane is hyperbolic then the iso-valent circles of its open-hyperbolic space of single-peaked valences are also circles on the hyperbolic Bower surface, but also their sensation radius differs from their valence radius. The single-peaked valences of hyperbolic sensations are mathematically expressed by inherently defined, hyperbolic sensation distances, as shown in the last mathematical section. These inherently defined, hyperbolic sensation distances and their conforal distance metric in hyperbolic sensation and open-hyperbolic valence spaces only hold for hyperbolic sensation spaces, which are two related, theoretical arguments for the hyperbolic geometry of sensations. On valence-comparable, hyperbolic sensation surfaces the iso-valent contours are circular, but they become asymmetrically transformed on the Euclidean stimulus plane, as shown in figure 34 below.

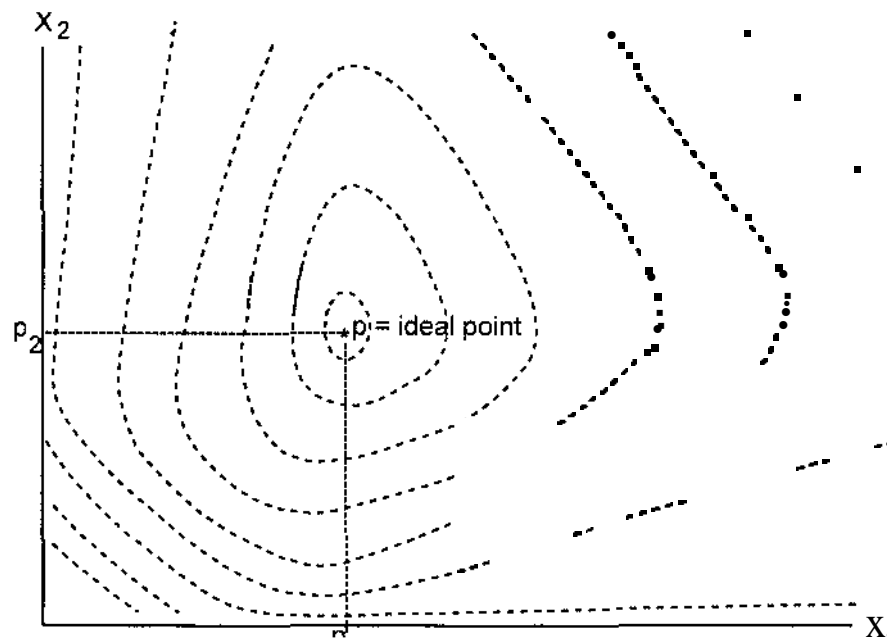

Figure 34. Iso-valent contours of single-peaked valences in a Euclidean stimulus space

5.3. Open Finsler geometries of mixed valence spaces

Valence spaces may arise from a mixture of monotone and single-peaked valence functions for the preference-relevant sensation dimensions of object attributes. Suppose we have a two-dimensional Euclidean sensation space wherein ideal axes of individuals have monotone valences and individual angles to a common sensation dimension with only single-peaked valences. The individually comparable Euclidean sensation plane with mixed valences is then defined by an ideal axis that is weighted by  $2/3 \cdot J_m$  and translated to adaptation point  $z_{J_i}$  and the sensation dimension with single-peaked valences that is weighted by  $1/3 \cdot J_m$  and translated to dimensional ideal point  $g_{J_i}$ . The mixed valences  $v_{J_i}$  of valence-comparable object sensations  $s_{J_i}$  for individual  $J$  are then determined by

1.  $w_{J_i} = \sin(\alpha_{J_i})$  for angle  $\alpha_{J_i}$  between the ideal sensation axis of  $J$  and the sensation dimension with single-peaked valences;
2.  $v_{J_i}^m$  sensations  $s_{J_i}^m$  of the ideal axis with monotone valences  $v_{J_i}^m$ ;
3.  $v_{J_i}^s$  sensation  $s_{J_i}^s$  of the sensation dimension with single-peaked valences  $v_{J_i}^s$

This then specifies

- a) angle  $\alpha_{J_i}$  between comparable sensation vector  $s_{J_i}$  and its dimensional projection  $s_{J_i}^m$  is then defined by  $\cos(\alpha_{J_i}) = |s_{J_i}^m|/|s_{J_i}|$ , and
- b) axis  $w_{J_i} \cdot s_{J_i}^m$  is orthogonal to axis  $s_{J_i}^s$ ,

whereby

$$s_{J_i} = \sin(\alpha_{J_i}) \cdot w_{J_i} \cdot s_{J_i}^m + \cos(\alpha_{J_i}) \cdot s_{J_i}^s$$

and

$$v_{J_i} = \sin(\alpha_{J_i}) \cdot w_{J_i} \cdot v_{J_i}^m + \cos(\alpha_{J_i}) \cdot v_{J_i}^s,$$

because angles in valence spaces equal corresponding angles in comparable sensation spaces with the same origin. If the comparable sensations are Euclidean then we scale the observed, bipolar, mixed preferences to  $c_{J_i}$  between  $+\pi/2$  and  $-\pi/2$  for arctangent-based valences or between  $+$  and  $-1$  for hyperbolic tangent-based valences and have

$$[c_{J_i} - \sin(\alpha_{J_i}) \cdot w_{J_i} \cdot v_{J_i}^m] / \cos(\alpha_{J_i}) = v_{J_i}^s$$

Residual  $v_{J_i}^m$  and  $v_{J_i}^s$  are differently scaled, because single-peaked and monotone valences have a different maximum valence

For a comparable, hyperbolic sensation surface similar matters holds, while for hyperbolic sensation space vectors  $s_{J_i}$  and hyperbolically additive valences  $v_{J_i}$  correspondingly holds that

$$\text{and } s_{J_i} = [\sin(\alpha_{J_i}) \cdot w_{J_i} \cdot s_{J_i}^m + \cos(\alpha_{J_i}) \cdot s_{J_i}^s] / [1 + \sin(\alpha_{J_i}) \cdot w_{J_i} \cdot v_{J_i}^m \cdot \cos(\alpha_{J_i}) \cdot v_{J_i}^s]$$

$$v_{J_i} = [\sin(\alpha_{J_i}) \cdot w_{J_i} \cdot v_{J_i}^m + \cos(\alpha_{J_i}) \cdot v_{J_i}^s] / [1 + \sin(\alpha_{J_i}) \cdot w_{J_i} \cdot v_{J_i}^m \cdot \cos(\alpha_{J_i}) \cdot v_{J_i}^s]$$

Here we replace  $v_{J_i}$  by values  $c_{J_i}$  of observed, mixed preferences that are scaled between  $-1$  and  $+1$  without scale difference of monotone and single-peaked valences, whereby

$$v_{J_i} = [c_{J_i} - \sin(\alpha_{J_i}) \cdot w_{J_i} \cdot v_{J_i}^m] / [1 - c_{J_i} \cdot \sin(\alpha_{J_i}) \cdot w_{J_i} \cdot v_{J_i}^m \cdot \cos(\alpha_{J_i}) \cdot v_{J_i}^s]$$

For a multidimensional mixed valence space there exists a common Euclidean object space with a subspace of  $m_1$  dimensions with monotone valences that contains the ideal sensation axes of the individuals and a complementary oblique subspace of  $m_2$

dimensions with single-peaked valences for the individuals. The mixed valence space of an individual only has one dimension more than the single-peaked valence subspace. The  $m_2$  dimensions with single-peaked valences constitute an open valence space of object valences  $v_{j_1}$  with varying curvatures (or with constant curvature  $-1/2$ , if the sensation space is hyperbolic), while the oblique ideal axis of the monotone valences  $v_{j_2}$  is an open dimension with an absolute curvature of unity or with zero curvature. Thus all  $(m_2 + 1)$ -dimensional, mixed valence spaces have an open Finsler geometry with varying space curvatures. However, mixed object valences  $v_{j_1}$  of individuals remain defined by the simple or hyperbolic addition of the orthogonally projected valences  $v_{j_1}$  of their ideal response axes and valences  $v_{j_2}$  in the  $m_2$ -dimensional single-peaked valence space. Here  $w_1 = \sin(u_{j_1})$  defines the projections of individual ideal response axes, which projections correspond to a  $m_1$ -dimensional sensation subspace with monotone valences that is orthogonal to the  $m_2$ -dimensional sensation subspace with single-peaked valences. In section 5.4.4 a preference analysis method is described for objects with mixtures of monotone and single-peaked valences. The analysis method solves iteratively the individual projection weights  $w_j$  the  $m_1$ -dimensional Euclidean sensation or stimulus subspace with monotone valences, individual rotations to ideal axis, and the  $m_2$ -dimensional Euclidean sensation or stimulus subspace with single-peaked valences.

### 5.3.1. Iso-valent contours of mixed valences

In figure 35 we illustrate the iso-valent contours of mixed valences in a Euclidean Bower plane. The vertical dimension corresponds to an open-hyperbolic ideal response axis of monotone valences and the horizontal dimension to a single-peaked valence dimension with varying curvatures, where these valence dimensions are derived by hyperbolic tangent-based valence functions of orthogonal, comparable Euclidean sensation dimensions.

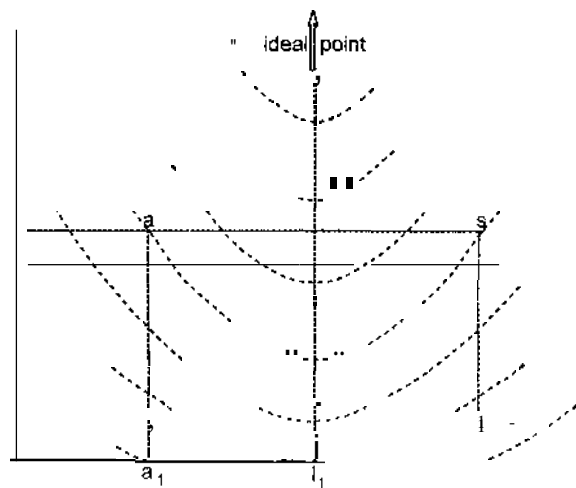
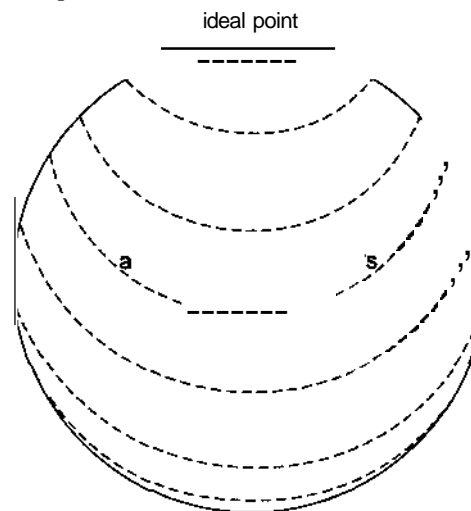

Figure 35. Iso-valent contours for monotone (vertical) and a single-peaked valence (horizontal) dimension in a Euclidean plane of comparable sensations

In a comparable Euclidean Bower plane the iso-valent contours of hyperbolic tangent-based valences are similar to hyperbolic curves. The indifference contour is the curve that contains of course the adaptation and saturation or deprivation points. In a common two-dimensional Euclidean sensation space the iso-valent contours for mixed valences of different individuals become asymmetric and differently oriented and located by individually different distances between the differently located adaptation and saturation points, because the Bower space dimensions are individually weighted and individuals will have differently directed ideal axes. Rotated comparable sensation dimensions with the adaptation point as origin have asymmetrically single-peaked valence functions as some rotational combination of monotone and single-peaked valence functions. The iso-valent contours are similar in a Euclidean Bower sensation plane with arctangent-based valences. If the sensation space is hyperbolic then the iso-valent contours are also infinite, parallel and symmetric curves on a hyperbolic sensation surface. In all cases iso-valent curves with equal valence differences have different sensation distances with the smaller sensation distances the closer the curves are to the indifference curve. In the common Euclidean stimulus space the iso-valent contours for comparable hyperbolic sensations not only become individually oriented, located and dimensionally weighted, but also exponentially transformed with respect to the zero sensation space point to asymmetric contours with respect to the **unit** stimulus space point. **If** we represent the iso-valent contours of curvature-corrected mixed valences in their open-Euclidean response disc, as shown in figure 36, then the iso-valent contours become circle parts, but on the mixed valence surface itself they are parallel open curve parts with symmetrically varying curvatures on both sides of the ideal axis. Clearly iso-valent contours on one side of the indifference contour have positive valences and on the other side negative valences in all representing spaces and their mixed valence spaces



*Figure 36. Iso-valent contours in an open quasi-response disc for curvature-corrected mixed valences of intensity- and valence-comparable sensations.*

#### 5.4. Appropriate multidimensional analyses of preferences

##### 5.4.1. *Applicability of existing preference analysis methods*

Existing methods of preference analysis specify not in which space (stimulus, sensation, response, or valence space) the objects are represented. These methods generally assume that individual preferences can be represented either as object distances to an individual ideal object or as object projections on an individual dimension in a common Euclidean object space. So this common Euclidean object space must then be either the Euclidean sensation space (in which case arctangent-based or hyperbolic tangent-based valence functions apply) or the Euclidean stimulus space (in which case hyperbolic tangent-based valence functions apply to hyperbolic sensation spaces). Some existing preference analysis methods weigh individually the common space dimensions and/or assume a common space with a constant Minkowski metric. However, no existing method considers different geometries between common object, individual sensation, response, or valence spaces, nor specifies the individual transformation from a common object space to individual preference evaluation spaces. The existing preference analysis methods are generally based on individual preference rank orders that describe either the rank order of object projection on individually oriented ideal axes or the rank order of object distances to the ideal points of individuals, which so far is identical to our approach. Since valence spaces are not common, the revealed spaces by the existing methods of preference analysis can never be a valence space, which in principle invalidates the interpretations of the analysis results of these methods. It must be recognised that preference evaluations are other cognitive tasks than comparative magnitude judgements or (dis)similarity responses and that each task transforms the respective common Euclidean object spaces in different ways and differently for each individual, due to possibly different adaptation points and in case of single-peaked valences also different ideal points. These different tasks with individually different transformations of a common object space ask for different analysis methods of data as distances or differences in different open geometries.

The so-called linear vector model (Tucker 1960; Roskam, 1968; Gifi, 1990) is an existing analysis model of preferences. It describes individual preferences as Euclidean projections of objects on individually oriented ideal axes in a common Euclidean object space. The linear vector model assumes that the preference rank order of individuals is equivalent to the rank order of the vectorial object projections on an individually different rotated dimension in a common Euclidean object space, where the dimension orientations depend on the direction of individual ideal space infinities. As demonstrated for monotone valences, the object valences are indeed equivalent to its corresponding response projections on the ideal response axis, but the rank order of projected objects on the ideal axis in the common Euclidean object space is only equal to the rank order of objects on the ideal response axis if individuals weigh the sensation dimensions equally (have the same adaptation point). The linear vector model is often accompanied by too strong other assumptions and interpretations. One generally assumes orthogonal projections of objects on an individually rotated ideal dimension with the same origin for individuals in a common Euclidean object space. But ideal response axes are monotone transformations of differently located and oriented ideal axes in the common Euclidean or hyperbolic Fechner sensation space. The individual



translation and monotone valence transformation of the individually oriented ideal axes change not the individual rank order of the objects on the ideal axes with respect to the orthogonal object projections on the ideal axes in individually weighted sensation spaces. Thus, a linear vector model that also weighs dimensions individually could recover correctly the common Euclidean sensation space, if preferences are described by monotone valences of Euclidean sensations. Due to the actual translation of individual ideal sensation axes to individually located adaptation points and the individual ideal axis direction to individual ideal infinities, the interpretation of ideal directions from a common origin in the common Euclidean sensation space is incorrect. Solved ideal axes by a linear vector model can be translated to any space point, but due to the absence of individually weighted dimensions the linear vector model may not recover the correct object configuration, even if the sensation space is Euclidean. Since the locations of the ideal axes and the dimensional weights should be different, it likely gives incorrect interpretations of the representations of the ideal space infinities. Moreover, the assumption of orthogonal object projections on individually oriented ideal axes in a common Euclidean space is also incorrect, due to the individually different, monotone valence transformations of ideal sensation axes in the individually weighted, Euclidean sensation space. Interpretations of ideal axis values as preference strengths and interpretations of the object configuration, therefore, are misleading. Any interpretation must be misleading, if the linear vector model solutions don't weigh the dimensions individually, because orthogonal object projections in weighted and not-weighted spaces generally have not the same rank order. **If** the common Euclidean object space is the stimulus space, then the assumption of orthogonal Euclidean projections on a straight ideal axis is also invalid, even for individually scaled stimulus fraction spaces, because dimensional power transformations correspond to the weights of hyperbolic sensation dimensions and transform the Euclidean stimulus space to individual Finsler spaces, whereby ideal axes and object projections are no longer straight, as shown by figure 31. The monotone valence functions of weighted Euclidean ideal sensation axes and the corresponding involutions of power-raised Euclidean ideal stimulus fraction axes don't change the rank order of the objects on the ideal axis, but changes the object locations on the ideal axis in individually different ways. The orthogonal iso-valent lines of objects with respect to the ideal axis in individual response spaces (figure 29) become asymmetrically and oppositely curved projection lines with respect to the straight, but also no longer orthogonal indifference axes in the common sensation space. If the common Euclidean object space is the stimulus space then corresponding opposite and asymmetric iso-valent projection lines can even be non-monotonically curved, which also may hold for the no longer straight ideal axis. However, the linear vector model specifies not whether the common Euclidean space is the sensation or stimulus space.

Existing, methods for multidimensional unfolding analyses of single-peaked preferences assume iso-valent circles with individually located ideal points as centre in a common Euclidean object space. Alternatively it is assumed that iso-valent contours are iso-distant Minkowskian contours and individual ideal points as centres, where the individual orientations of these iso-valent contours depend on the relevant co-ordinates of the otherwise common object configuration in the Minkowski space

with a fixed  $r$ -metric for object distances to ideal points as representations of preference strengths of individuals. These existing multidimensional unfolding methods assume, thereby, also that the rank order of object preferences correspond to the rank order of distances between common object point locations and individually located ideal points (Coombs, [964; Shepard et al. 1972, Heiser, 1981, Heiser and De Leeuw, 1981, Cox and Cox, 1994, Borg and Groenen, 1997), where some versions also weigh the underlying dimensional distance individually (Carroll and Chang, 1972, Carroll, (972). Probabilistic unfolding methods describe and analyse preferences by overlap of object distributions with ideal point distributions (PeITin, 1992) in a Eudidean object space, wherein the distribution overlap depends on the distances between the central locations of the objects and the ideal points as well as possibly on dimensionally different dispersions (similar to differently weighted dimensions). In all existing preference analysis methods the individual preference rank orders depend on the rank order of (individually weighted) space distances or (individually shaped) distribution overlaps between common object locations or common-located object distributions and individually different ideal point locations or individually different-located ideal-point distributions in a common flatspace. Since no distinction is made between preference, sensation, or stimulus spaces, these methods assume that individuals share a flat (Eudidean or Minkowskian) common object space for their preference evaluations, besides individually different weights for dimensions and individually different-oriented reference co-ordinates. According to our derivations iso-valent contours not only are circles in single-peaked valence spaces, but also in Euclidean or hyperbolic Bower spaces. Bower spaces with a Minkowski  $r$ -metric are not derivable from our semi-metric multidimensional analysis of preferences, because inverse valence transformations of optimally scaled preference rank orders as single-peaked valences transform the scaled valences of open Finsler spaces to valence-comparable Eudidean sensations. Thus, our semi-metric Euclidean analyses of preference data define object distances to ideal points in individually weighted and translated Euclidean sensation spaces, even if valences generate from sensation spaces with a Minkowski  $r$ -metric. However, if the sensation space is hyperbolic and is mistaken to be Euclidean then an unfolding analysis would require a representation in an individually weighted flat space with varying  $r$ -metrics that decrease with the distances to the individual ideal points, as shown in figure 33. **If** existing methods of non-metric unfolding analyses of preference data would show consistently that representations in a flat space with a fixed  $r$ -metric of  $r < 2$  fit better than in a Euclidean space then this could as well yield some empirical evidence for the hyperbolic nature of sensation spaces, because its incorrectly flat space representation with an average  $r$ -metric  $r < 2$  of the varying  $r$ -metrics would fit better than the Euclidean metric. For example, if choice objects are located within the indifference contours of individuals and the sensation space is hyperbolic then the  $r$ -metrics for the iso-valent contours in an incorrectly flat space vary from  $r_{\min} \approx 1.313$  to  $r_{\max} = 2.164$  with geometric average  $r_{\text{avg}} \approx 1.686$ . However, if the sensation space is hyperbolic then preferences concern individually weighted dimensions of a common hyperbolic sensation space, wherein iso-valent contours are elliptically shaped, while in its Euclidean stimulus space the iso-valent contours are no longer elliptical, but asymmetrically closed contours, as shown in figure 34.

Single-peaked valence functions with respect to individually different ideal and adaptation points transform in individually different ways the common Euclidean object space to individually different valence spaces with varying curvatures (if the sensation space is not hyperbolic) or with curvature  $-\frac{1}{2}$  (if the sensation space is hyperbolic). Individual object preferences are monotone transformation functions with individually different parameters of Euclidean or hyperbolic sensation distances between objects and individual ideal points, whereby individual iso-valent contours are circles or (hyper-)spheres in comparably weighted, hyperbolic or Euclidean Bower sensation spaces. Thus, also our derivations determine iso-valent contours to be individually located and oriented, concentric (hyper-)ellipses in a common sensation space. If the sensation space is not hyperbolic then this is consistent with the individual difference version of non-metric Euclidean unfolding methods of preference analyses. Such a Euclidean unfolding analysis may correctly recover the object configuration and the individual ideal point locations in an arbitrarily weighted and translated Euclidean reference space of sensations. However, the differences between individually weighted Euclidean sensation space distances to individual ideal points should not be interpreted as preference-strength differences. This interpretation is incorrect, because preference strengths are monotone transformations of valence-comparable Euclidean or hyperbolic sensation distances to ideal points, as defined for single-peaked valences by

$$v_{ji} = \tanh \{-\frac{1}{2} \ln \{ \cosh(dJ/d_j) / \cosh(D) \} + 1$$

$$v_{ji} = \arctan(1 - dJ_j/d_j) \cdot \arctan(1 + dJ/d_j).$$

Moreover, if the sensation space is hyperbolic then incorrectly flat sensation space representations yield distance-dependent Minkowski  $r$ -metrics of iso-valent contours in an individually weighted flat sensation space, while the correct Euclidean representation in a stimulus space yields even more complex shapes of asymmetric iso-valent contours. According to our derivations a preference data analysis by existing non-metric multidimensional Euclidean unfolding analysis is only justified if the sensation space is indeed Euclidean and if a common sensation space exists and is individually weighted, otherwise violations of individual preference rank orders are inherent to these existing preference analysis methods. However, due to the absence of a rational distance function for the multidimensional scaling of the object distances to ideal points, the conditionally valid (under individual weights and the assumption that the sensation space is not hyperbolic), existing Euclidean unfolding analysis of preferences reveals not the actual preference strength of objects for an individual.

The applicability of existing analysis methods for preferences of objects with a mixture of monotone and single-peaked valences is limited. Only one seemingly valid analysis method for Euclidean object spaces with such a valence mixture exists. It is the so-called PREFMAP-method for weighted Euclidean unfolding analysis (Carroll, 1972), wherein an individually weighted and oriented object dimension can have an almost infinite dimensional ideal point, which holds for independent Euclidean sensation subspaces with respectively monotone and single-peaked valences. However, this method assumes open circular iso-valent contours in the individually weighted Euclidean space, which is partially incorrect, even if the monotone valence subspace and the single-peaked valence subspace are orthogonal subspaces, as shown by the

non-circular, iso-valent curves in figure 35. Thus, Euclidean PREFMAP-analysis for mixed valences is partially invalid and not only if the sensation space is hyperbolic, while the method has the same interpretation problems with respect to individual preference strengths. Clearly all existing non-metric, unfolding methods for preference analysis of objects with single-peaked or mixed valences are invalid if the sensation space is hyperbolic. However, mixed valence spaces probably apply to the actual preference evaluations for most choice objects in real life, because generally also characterised by monotone valence or disutility of monetary costs for the choice realisation, while the sensation space may very well be not Euclidean, but hyperbolic. In section 5.4.4. we describe semi-metric preference analysis methods for objects with hyperbolic or Euclidean sensations and mixtures of monotone and single-peaked valences. These methods determine which individual mixtures of monotone and single-peaked valences specify individual object valences, whereby no a priori choice between analysis methods for either monotone or single-peaked valences is needed. Our analyses of mixed valence spaces assume no independence between the common Euclidean object subspaces of monotone and single-peaked valence attributes. These two subspaces are solved by our solution methods for Euclidean object spaces with only monotone valences and for Euclidean object space with only single-peaked valences, while the angles between ideal axes of individuals and their attribute subspace with single-peaked valences are solved iteratively by canonical analysis of their correlations and the correlations between co-ordinates of the common Euclidean object subspace for the individual ideal axes and the common Euclidean object subspace with single-peaked valences. Therefore, firstly we describe our semi-metric preference analysis methods for objects with monotone valences in the next section and secondly for objects with single-peaked valences in the following section. Each section contains three different preference analysis methods, because the method differs for each different geometry of the valence space:

- double-elliptic stimuli with arctangent-based valences of comparably weighted Euclidean sensations, represented in the common Euclidean sensation space;
- Euclidean stimuli with hyperbolic tangent-based valences of comparably weighted hyperbolic sensations. represented in the common Euclidean stimulus space;
- hyperbolic stimuli with hyperbolic tangent-based valences of comparably weighted Euclidean sensations, represented in the common Euclidean sensation space.

#### 5.4.2. Analysis methods for monotone valence spaces

The existing multidimensional scaling method for individual preference rank order data of objects with monotone valences is the linear vector model (Tucker 1960; Roskam. 1968), discussed above and earlier in section 5.1. The linear vector model for analyses of individual preference rank orders of objects in object spaces with monotone valences is efficiently solved by the so-called PRINCALS programme (Gifi, 1990). that also optimally scales the preference data within the rank order constraints for the maximum fit of the chosen solution dimensionality. It describes objects with monotone valences as Euclidean projections on individually oriented ideal axes in a common Euclidean space. The projections on the individually oriented ideal axes give the optimal metric fit for the observed rank order of the individual preferences for the chosen dimensionality of the solution. This indeed fits monotonic preference evaluations with

respect to ideal points at infinity directions of the space, provided that the common Euclidean sensation space dimensions are individually weighted, as argued in sections 5.1. and 5.4.1. and also is demonstrated in the next mathematical section.

In order to describe individually different preference strengths for objects with monotone valences and the configuration of choice objects in a common Euclidean object space we have to solve from different preference rank orders of individuals:

1. dimensional object parameters in the common Euclidean object space, either as Euclidean stimulus co-ordinates  $x_{jk}$  or as Euclidean sensation co-ordinates  $y_{jk}$
2. individual rotation parameters  $h_{jk}$  for the rotation of common Euclidean object co-ordinates to individual ideal axes, and
3. individually different dimensional weights, either as dimensional stimulus weights  $b_{jk}$  or as dimensional sensation weights  $a_{jk}$  of individuals, which weights determine their adaptation point locations  $b_{jk}$  or  $a_{jk}$  on the Euclidean co-ordinates of respectively the Euclidean stimulus or sensation space, while individual rotation cosine  $h_{jk}$  determine individual ideal axes that in the stimulus space have individual power exponents  $\tau_{jk} = 2/a_{jk} = 2/\ln[\sum_{k=1}^{k=m} (h_{jk} \cdot b_{jk})]$ .

For a well-determined solution we not only need the preference rank orders of several individuals (where the needed number of individuals depends on the number of objects and the object space dimensionality), but also whether the objects are liked or disliked. Without that information the actual adaptation point locations as origin of the ideal and indifference axes may not be fully determined. Although the individual dimension weights that also determine different translations to adaptation points could be solved without that preference bipolarity information, it would yield a less determined solution, because the solved individual dimension weights would be with respect to an arbitrarily weighted and translated reference space if the weight parameters would not be related to the individual sensation space translations. We need the ordering of preferences with negative rankings of disliked objects and positive rankings for liked objects with indifference as individual zero preference. We may obtain such preference data by asking individuals to rank order their preferences for objects (possibly with ties) that are simultaneously presented, while we also ask later which objects are disliked or liked and whether there is preference indifference for some objects. Negative rank order values are then assigned to disliked objects, the zero rank order to the indifference objects (if present), and positive rank order values to liked objects (with more than one object in the same rank order category if ties are present). These bipolar rank values yield initially scaled valences after division by the square root of their absolute values and scaling, either (1) as values between -0.9 and +0.9 that by their inverse hyperbolic tangent transformations define initial ideal axes in weighted Euclidean sensation spaces or by their inverse response involutions define initial ideal axes in weighted and power-raised Euclidean stimulus spaces or (2) as values between -0,45n and +0,45n that by their tangent transformation define initial ideal axes in weighted Euclidean sensation spaces. Alternatively individuals may be asked to express preferences on a rating scale with sufficient rank categories ranging from very disliked to indifference, and from indifference to very liked. These rated, bipolar preferences are then similarly scaled and inversely transformed to initial ideal axes. Gathered in the conditional data matrix with objects as columns and individuals as rows, the initially

scaled data matrix is then analysed as ideal axes in weighted and translated Euclidean sensation spaces or power-raised Euclidean stimulus fraction spaces, where predicted ideal axes are then subsequently used for a more optimal scaling of the preference data and repeatedly analysed until convergence is obtained for the solutions, as described in the next mathematical section.

As discussed in sections 5.1. and 5.4.1. the preferences of liked or disliked choice objects of individuals as scaled, bipolar rank order data only correspond to the sign and rank order of the Euclidean object projections on individually oriented ideal axes, if the common Euclidean sensation space dimensions are individually weighted and translated. We start the solution by a weighted linear vector model solution for the above described, initial data matrix of scaled, bipolar preference rank orders that are transformed by the inverse monotone valence function (the tangent or inverse hyperbolic tangent) to ideal Euclidean sensation axes or by the inverse response involution to power-raised ideal Euclidean stimulus axes with initial power exponents of unity. By a singular value decomposition of the initial data matrix we solve the object configuration in a common Euclidean reference space and its individual transformation parameters (individual rotation parameters and dimensional weights and weight-dependent power exponents or weight-dependent translations of respectively stimulus or sensation dimensions) for the configuration transformation to ideal axes. Next we successively improve the scaling of the data by the minimally changed values of the previously predicted ideal response axes to values with the same rank order and sign as the observed preference data of individuals under preservation of the response space limits. After inverse response transformation of each scaling to ideal axes of weighted Euclidean sensation values or power-raised Euclidean stimulus values the described analysis is repeated. By the converged solution we not only determine the object configuration and the individual ideal axis locations and orientations in the common Euclidean object space, but also the curvilinear iso-valent contours of individuals in the common Euclidean object space, whereby we determine the metrically different preference strengths of individuals for the objects in Euclidean object space. Thus, our semi-metric multidimensional preference analysis methods modify the linear vector model by individual dimensional weights and weight-dependent translations (if the sensation space is Euclidean) or by dimensional weights and weight-dependent power exponents (if the stimulus space is Euclidean) and by a response geometry-dependent, optimal scaling of observed preference data.

Let positive preference rank orders be denoted by the matrix  $Q$  with  $N$  rows of individual preference data for  $n$  objects, while a  $n \times m$  matrix  $Z$  are the principal components of the object space. The so-called singular value decomposition of  $Q$  (Eckart and Young, 1936; Good, 1969) is written as

$$Q = H \Lambda F' + E, \quad (67a1)$$

and solved by the  $m$  principal components of

$$QQ' = H \Lambda^2 H' + EE', \quad (67a2)$$

and

$$Q'Q = F \Lambda^2 F' + E'E. \quad (67a3)$$

Here

$\Lambda$  is the  $m \times m$  diagonal eigenvalue matrix,  
 $F$  the  $n \times m$  eigenvector matrix with  $F'F = I$ ,

and  $H$  the  $N \times m$  eigenvector matrix with  $H'H = I$ ,  
 whereby  $\text{trace}\{E'E\}$  is minimised. In (63a) one initially takes  
 $H = H$  as first approximation of ideal axis directions  
 1 in a Euclidean space of  $m$  dimensions,  
 $F A = z$  as first approximation of the object  
 1 configuration in that Euclidean space,  
 and  $Q = H Z'$  as least squares approximation of  $Q$  as the  
 1 1 1 initial ideal axes in the Euclidean space.

This linear vector model solution then is optimised for a scaling of  $Q$  by replacing for  $Q$  the minimal changed rows in  $Q_1$  that fits the rank-order constraints as its maximised monotone regressions with the rows in  $Q$  and then the analysis of (66a) is repeated for the successively scaled matrix  $Q$  until convergence of an optimally scaled matrix  $Q$  is obtained.

However, depending on whether the Euclidean space is the stimulus or sensation space and whether in the latter case the monotone valence function is the arctangent or the hyperbolic tangent function for sensations, the actual scaling of the preferences on the ideal axes and the analysis should be differently performed. Also individual dimension weights and the weight-dependent translations for Euclidean ideal axes are not taken into account by the vector model analysis of matrix  $Q$  that derives from positively scaled preference rank orders. The weighted sum of dimensional valences for object  $i$  as ideal response axis as preference  $v_{Ji}$  of objects  $i$  for individual  $J$  is written as

$$v_{Ji} = \sum_{k=1}^{k=m} v_{Jik} = \sum_{k=1}^{k=m} h_{Jk} \text{ or } J_{ik} = r_{Ji} \quad (67b1)$$

where  $h_{Jk}$  are the rotation weights of individual  $J$  for rotation of the response dimensions  $k$  to the ideal response axis of the individual.

If the response space is defined by inverse tangent transformations of a Euclidean Bower space from elliptic stimuli then (see: section 502.1.) the transformation from sensation to response space axes writes as

$$v_{Ji} = \arctan[2 (y_{Ji}/a_J - 1) / 1], \quad (67b2)$$

or replacing the expected  $v_{Ji}$  values by values  $c_{Ji}$  as observed bipolar preference data that are scaled between  $-1/2$  and  $1/2$ , we have inversely

$$q_{Ji} = \frac{1}{2} \tan[-c_{Ji} / 1 + 1 = Y_{Ji}/a_J]. \quad (67b3)$$

In case of a Euclidean Bower space from hyperbolic stimuli from we have

$$v_{Ji} = \tanh[-(y_{Ji}/a_J - 1)], \quad (67c1)$$

or

$$q_{Ji} = \arctanh[-c_{Ji} / 1 + 1 = Y_{Ji}/a_J], \quad (67c2)$$

where the  $c_{Ji}$  values are bipolar preference rank orders that are scaled between  $-1$  and  $+1$ . Rotation cosines  $h_{Jk}$  define ideal sensation axes, whereby

$$q_{Ji} = \sum_{k=1}^{k=m} h_{Jk} \cdot y_{ik}/a_J + e_{Ji} = Y_{Ji}/a_J + e_{Ji}, \quad (67c3)$$

with

$$\sum_{k=1}^{k=m} h_{Jk}^2 = 1, \quad \sum_{k=1}^{k=m} h_{Jk} \cdot a_{Jk} = a_J, \quad \text{and } e_{Ji} \text{ as error term} \quad (67c4)$$

In case hyperbolic tangent functions of hyperbolic sensations from the Euclidean stimulus space we modify (67c2) for stimuli to

$$t_{Ji} = \exp\{2 \cdot \arctanh[-c_{Ji}]\} = (1 - c_{Ji}) / (1 + c_{Ji}) = (x_{Ji} / b_J)^{2/a_J} \quad (67d1)$$

where we obtain for rotation weights  $h_{Jk}$  the ideal axes in the Euclidean stimulus fraction space with the translated adaptation point to the space origin as translated rotation centre by

$$q_{Ji} = t_{Ji}^{a_J/2} = \sum_{k=1}^{k=m} h_{Jk} \cdot x_{Jk} / b_J + e_{Ji} = x_{Ji} / b_J + e_{Ji} \quad (67d2)$$

with

$$1, \sum_{k=1}^{k=m} h_{Jk} \cdot b_{Jk} = b_J, \text{ and } e_{Ji} \text{ as error term.} \quad (67d3)$$

We need for  $q_{Ji}$  of (67d2) the still unknown values of  $h_{Jk}$ , which are initially here set to unity.

Writing (67c3) or (67d2) in matrix notation, where for elements  $q_{Ji}$  we define a  $N \times 1$  matrix  $Q$ , for elements  $h_{Jk}$  a  $N \times m$  matrix  $H$ , for elements  $y_{Jk}$  or  $x_{Jk}$  a  $n \times m$  matrix  $Z$ , for elements  $1/a_J$  or  $1/b_J$  a  $N \times N$  diagonal matrix  $W$ , we obtain for (67c3) and (67d2) an identical matrix expressions as

$$Q = WHZ' + E. \quad (68a)$$

Comparing (68a) and (66a) we see that we can't solve from (66a) the individual dimensional adaptation points, due to the absence of bipolar translation and limit scaling of preference rank order data. But we can solve from (68a) by the transformations of ideal response axes to ideal axes in the Euclidean object space, where firstly we have to solve  $H$ ,  $Z$ , and  $W$  from  $Q$  as defined for (67c3) or for (67d2). For a given matrix  $Q$  we solve matrices  $H$ ,  $W$  and  $Z$  via the eigenvector/value solutions of

$$Q'Q = GA^2G' + E'E \quad (68b1)$$

whereby  $\text{trace}\{E'E\}$  is *minimised* for  $m$  principal components

$$Z = GA, \quad (68b2)$$

while we obtain by  $EZ = 0$  from (68a) and (68b2)

$$QZ (Z'Z)^{-1} = QG H G' H^{-2} G = WH, \quad (68b3)$$

where

$$W = \text{diag} [W H H W]^{1/2} \quad (68b4)$$

Multiplication of (68b3) by the invers of (68b4) solves matrix  $H$ , while

$$Q = WHZ'. \quad (68b5)$$

However, here we need an iteration cycle if values  $q_{Ji}$  are defined by (67d2), because initially we took  $a_J = \ln(b_J) = 2$ , where now  $b_J = 1/w_J$  as solved by diagonal matrix  $W$ . By using  $\ln(1/w_J)/2 = a_J/2$  in (67d2) for improved elements of matrix  $Q$  and solving again (68b) we can here solve iteratively  $W$ ,  $H$ , and  $Z$  for  $z_{Jk} = x_{Jk}$  as Euclidean stimulus co-ordinates by repeated solutions of (68b) until convergence of  $W$ .

The dimensional adaptation point  $b_J$  or  $a_J$  are obtained by projections of space adaptation points  $b_{Jk}$  or  $a_{Jk}$  that are located on the ideal axes defined by the rotation weights  $h_{Jk} = \cos(\mu_{Jk})$ . Since a projection angle is  $90^\circ - \mu_{Jk}$  for rotation angle  $\mu_{Jk}$ , we obtain the dimensional projections



of  $b_J$  or  $a_J$  by weights defined as  $w_{Jk} = \sin \alpha_J \cos \{h_{Jk}\}_J$ , whereby

$$b_J \cdot w_{Jk} = b_{Jk} \quad \text{or} \quad a_J \cdot w_{Jk} = a_{Jk}. \quad (68h6)$$

We further derive from the solution of the expected values of  $q_{Ji}$  the expected ideal response axes values. In case of (67h2) by

$$v_{J1} = \arctan[2Q_{J1} - 2], \quad (68c1)$$

or in case of (67c2) by

$$\hat{v}_{J1} = \tanh[-(q_{J1} - \Pi)], \quad (68c2)$$

and case of (67d2) we use  $\hat{t}_{J1} = (\hat{x}_{J1}/\hat{b}_J)^{2/a_J}$  and derive

$$\hat{v}_{J1} = (1 - \hat{t}_{J1}) / (1 + \hat{t}_{J1}) \quad (6ae3)$$

with power exponent  $2/a_J = 2 \ln(b_J)$  from converged values  $b_J = I_j w_J$ . Next we obtain an improved scaling of the initial bipolar preference data  $C_{Ji}$  by minimally changed expected  $v_{Ji}$  values from (6ae) that fit the rank order and sign of the bipolar preference data and satisfy also the limits of their ideal response axes. The better scaled preference values are used for improved  $q_{Ji}$  values by (67b2), or (67c2), or via (67d1) also by (67d2) and then solved again by (68b). Repeated solutions by (68b) for further improved preference data scaling by (68c) and (67b2), or (67c2), or (67d2) until convergence occurs, optimally scales the preference data as observed ideal response axes and solves the rotation vectors in H, the Euclidean object space co-ordinates in Z, and the dimensional weights by solved adaptation points  $a_{Jk}$  or  $b_{Jk}$  under minimised trace  $\{E'E\}$ .

By also attaching per individual the expected valences  $v_{Ji}$  of (68c) to the objects in the Euclidean sensation or stimulus space  $J_i$  we can infer the curved iso-valent contours in the common Euclidean sensation or stimulus space as individually oriented and located iso-valent contours with individually oriented indifference sensation axes or indifference stimulus curves and ideal sensation or stimulus axes that intersect at their individual space adaptation points.

We have  $N$  bipolar rank order values  $c_{Ji}$  for  $n$  objects of  $N$  differing individuals, while we lose at least  $2N$  degrees of freedom by the optimal scaling of  $c_{Ji}$ . These scaled values have to determine the  $N(m-1)$  rotation cosines of  $H$ , the  $n \cdot m$  object locations on the Euclidean object space co-ordinates of  $X$  or  $Y$ , and  $N$  unknown adaptation points  $a_J$  or  $b_J$ . Therefore, the equations can only be solved if

$$N \ln 3! > N(m-1) + n'm + N \quad N'm + n'm, \quad (69d1)$$

$$\text{or} \quad N \ln (m-3) > n'm, \quad (69d2)$$

$$\text{whereby} \quad n > m + 3 \quad \text{and} \quad N > n'm, \quad (69d3)$$

must be simultaneously satisfied for  $N$  individuals with different bipolar preference rank orders and  $m$ -dimensional solutions. For  $m=2$  it requires that  $n \geq 6$  and  $N > 12$ , for  $m=3$  one needs  $n \geq 7$  and  $N > 21$ , while  $m=4$  requires that  $n \geq 8$  and  $N > 32$ , but for well-determined solutions number  $N$  with different preferences must be much higher than its minimum  $n \cdot m$ .

Above we described an iterative, semi-metric solution procedure for the dimensional object parameters and individual parameters on the one hand and the optimal scaling of individual bipolar preference rank orders on the other hand. There exist other solution techniques based on an initial object configuration that is iteratively improved to fit optimally an iteratively scaled data matrix. However, in contrast to such techniques the described analysis method exhibits not the danger of local minimum solutions, because based on metric, singular value decompositions of iteratively scaled data matrices without an initial object configuration. The solution for the common Euclidean object space and the individual rotation and adaptation-level parameters can only be determined if the numbers of  $m$  dimensions and  $N$  individuals with different bipolar preference rank orders for a set of  $n$  objects satisfy jointly:

$$n > m + 3 \quad \text{and} \quad N > n \cdot m.$$

The proposed solution method is an alternating iteration procedure that on the one hand optimises the scaling of the preference data and on the other hand solves metrically the least squares fit for the common Euclidean object space co-ordinates, the individual dimensional weight parameters that also determine the translations to individual adaptation points (or for stimulus spaces their dimensional weight and power parameters), and the direction angles for the individual ideal axes in common Euclidean object space. It thus gives the parameters for the individual transformation of the common Euclidean object space to individually different, open monotone valence space geometries with either a Euclidean, or hyperbolic, or elliptic distance metric. The theory of the presented analysis allows a richer interpretation than a weighted version of the linear vector model analysis as such, because it defines that the dimensional weights correspond to space adaptation points as individually different origins of the ideal axes and, thereby, also specify correctly the ideal infinity directions. These interpretations are based on our psychophysical response and valence theory that relates Euclidean stimulus or sensation spaces to open spaces for judgmental evaluations and preferential choice with different geometries. The relationships between stimuli, sensation, judgmental and preferential evaluations are lost if no grounded theory of rational distance metrics in these respective spaces, defined by their metric stimulus space transformations, guides the preference analysis.

#### 5.4.3. Analysis methods for single-peaked valence spaces

Single-peaked valence spaces that generate from the product of arctangent or hyperbolic tangent functions of comparable sensation distances to ideal points in Euclidean (or Minkowskian) sensation spaces have varying curvatures. Only single-peaked valences that generate from the product of hyperbolic tangent functions of hyperbolic sensation distances to ideal points have a constant curvature  $\zeta = -\sqrt{2}$ . The geometries for spaces with varying curvatures are so-called Finsler geometries (Rund, 1959; Asanov, 1985; Matsumoto, 1986). The general mathematical description of Finsler spaces is rather complex and their analyses are enabled by tensor algebra (Gerretsen, 1962; Sokolnikoff, 1967; Dubrovin et al., 1992) for the covariant transformations of co-ordinate values and space curvature parameters of these geometries. Fortunately, no further explication is needed of that "*impenetrable forest whose entire vegetation consists of tensors*", as Busemann (1950b) once called the

Finsler geometries for surfaces with continuously varying curvatures, because the open Finsler geometries for single-peaked valences of Euclidean sensations have curvatures and valences that both are determined by the valence-comparable sensation distances to ideal points, as demonstrated in the mathematical subsection of section 5.2.1. Thereby, we can bypass the tensor-algebraic analysis complexity of single-peaked valence spaces with varying curvatures. The open Finsler spaces of single-peaked valences become mathematically tractable by their formulation in terms of individually different, projective transformations of Euclidean sensation spaces, because open single-peaked valence spaces with variable curvatures are so-called projectively flat Finsler spaces (Matsumoto, 1991). The curvatures of the open Finsler spaces of single peaked-valences have absolute curvatures that decrease with the weighted sensation distances  $d_{J_i}/d_{J_i}$  to the ideal point, where  $d_{J_i}$  is the distance between the ideal point as sensation-space centre and the projected adaptation space point on the sensation vector. Thereby, their preference analyses can be simplified to the semi-metric analyses of individually weighted Euclidean sensation distances  $d_{r_i}/d_{J_i}$  from individual ideal points, if the stimulus space is hyperbolic, where then the Euclidean sensation distances  $d_{J_i}/d_{J_i}$  can iteratively be derived by the metric, inverse transformation of initially and in the end optimally scaled, single-peaked valences. If the sensation space is hyperbolic then single-peaked valences are defined by

$$v_{J_i} = \tanh[-\frac{1}{2} \ln \{ \cosh(d_{J_i}/d_{J_i}) / \cosh(I) \}],$$

where  $\cosh(d_{J_i}/d_{J_i}) = \cosh[\ln(x_{iPJ}) / \ln(b_{iPJ})]$  is a hyperbolic sensation space distance, whereby its single-peaked valences are response to sensations of power-raised, conjugate stimulus fraction midpoints (csfm's), defined by  $(x_{iPJ} + p_{iPJ})/2$  with respect to self-conjugate individual ideal points  $PJ$  in the Euclidean stimulus space. From scaled single-peaked valences we obtain

$$\cosh(I) \cdot \exp\{2[\arctanh(-v_{J_i})]\} = \cosh[\ln(x_{iPJ}) / \ln(b_{iPJ})],$$

whereby the stimulus or object configuration in the common Euclidean space with differently located, individual ideal stimulus space points  $PJ$  and possibly different individual stimulus adaptation points  $b_{J_i}$  can iteratively be solved. Our multidimensional analysis of preference rank orders as ordered distances to ideal points in Euclidean or hyperbolic sensation spaces resembles the Coombs' (1964) unfolding analysis, but also differs from Coombsian unfolding analysis due to our metric transformations of optimally scaled, bipolar preference rank orders of individuals to Euclidean stimulus or sensation space values. If the common Euclidean object space is the stimulus space then the preference analysis for single-peaked valences concerns the inverse transformation of single-peaked valences to individually power-raised, Euclidean stimulus fractions with respect to individual ideal points as unit space points, whereby the common Euclidean stimulus space can iteratively be solved from individually rotated, weighted, and power-raised dimensions. If the common Euclidean object space is the sensation space, then the preference analysis concerns the inverse transformation of single-peaked valences to valence-comparably weighted Euclidean sensations with respect to individual ideal points, whereby the common Euclidean sensation space can iteratively be solved from individually rotated, translated, and weighted spaces.

The solutions in the next mathematical section are based on successive deflations of the dimensional valences for each iteratively solved Euclidean stimulus or sensation dimension from valences that derive from the iteratively optimal-scaled values of observed bipolar preference rank orders of individuals, as specified earlier for monotone valences. The analysis of single-peaked valences for each solved dimension, besides the deflation procedure, is similar to the solution for ideal response axes in monotone valence spaces, described in section 5.4.2. However, the differences between the solutions for single-peaked and monotone valence spaces are threefold:

- 1) we don't rotate common Euclidean object space to one ideal response axis for each individual, but obtain its co-ordinates successively for maximal relevant, multiple axes with single-peaked valences by successive deflations of solved dimensional valences from space valences as optimally scaled, bipolar preference rank orders;
- 2) we don't weigh or power-raise rotated co-ordinates of the common Euclidean object space by twice the inverse of the dimensional distance of the adaptation point to the just noticeable point as Fechner space origin, as holds for monotone valences, but weigh or power-raise Euclidean co-ordinates by the inverse of the distances between their dimensional adaptation and ideal points in the Fechner-Helson space;
- 3) we don't translate the common Euclidean sensation space to individual adaptation points or don't scale the common Euclidean stimulus space to stimulus fractions with respect to stimulus adaptation levels, but translate individually the common Euclidean sensation space to ideal points or scale the Euclidean stimulus space to individual stimulus-fraction co-ordinates with respect to ideal stimulus points.

It also differs from existing methods of unfolding analysis in three ways:

- a) the space reference point not only is the ideal point as individual centre point, but also the adaptation point for hyperbolic or Euclidean sensation distance between the ideal and the adaptation point, where the dimensional weighing of sensation distances to the ideal point by the inverse of the distances between dimensional adaptation and ideal points defines the valence-comparable sensation dimensions;
- b) the preference analysis is based on metric deflations from space valences as initially scaled, bipolar preference rank orders by dimensional valences of successively solved sensation or stimulus space dimensions, while the bipolar preference data become optimally scaled by alternating the m-dimensional solution and the scaling;
- c) equal object preferences describe iso-valent circles in individually weighted and translated Euclidean sensation spaces, but in the Euclidean stimulus space they become exponentially transformed circles with respect to individual ideal points as unit point in the individually power-raised Euclidean stimulus fraction spaces.

In section 5.2.1. we have written the dimensional single-peaked valences for a hyperbolic or Euclidean sensation dimension  $k$  as the product of two hyperbolic tangent or arctangent functions of the variable and fixed dimensional sensation distance, defined by

$$d_{Jik} = I_{ik} \cdot g_{JkI} \quad \text{and} \quad d_{Jk} = I_{Jk} \cdot g_{JkI}, \quad (70a)$$

where  $I_{Jk}$  is dimensional ideal point and  $d_{Jk}$  the dimensional distance between the ideal and adaptation or saturation points of individual  $J$  on sensation dimension  $k$  with sensations  $y_{ik}$

The single-peaked valences as products of hyperbolic tangent functions for valence-comparable Euclidean sensation spaces of hyperbolic stimuli are given by

$$v_{J1k} = \tanh[-\frac{1}{2} \ln \{ \cosh \{ d_{J1k} / d_{JK} \} / \cosh(1) \}]. \quad (7Gb1)$$

By the Euclidean nature of dimensional distances  $d_{Jik} / d_{JK}$  we write

$$\hat{v}_{J1} = \tanh[-\frac{1}{2} \ln \{ \cosh [ \sqrt{\sum_{k=1}^{k=m}} \{ (y_{1k} - g_{JK}) / d_{JK} \}^2 ] / \cosh(1) \}]. \quad (70b2)$$

$$\hat{v}_{Ji} = \tanh[-\frac{1}{2} \ln \{ \cosh [ (y_i - g_J) / d_J ] / \cosh(1) \}]. \quad (70b3)$$

Expression (70b1) is a response transformation of the logarithm of the hyperbolic cosines for weighted Euclidean sensation distances between dimensional sensations and its ideal point with respect to  $u = \cosh(1)$ , because  $\cosh(y-g) = \cosh(g-y)$ , whereby the inverse of (70b1) yields

for  $k=h=1$ ,  $v_m = \tanh^2(\frac{1}{2})$ , and  $d_{J1h} = (y_{1h} - g_{Jh}) / d_{Jh}$

$$\hat{d}_{Jih} + e_{Jih} = 2 \operatorname{arctanh} [ J \{ \{ v_m - c_{Jih} \} / \{ 1 - v_m c_{Jih} \} \} ], \quad (70b41)$$

where

$$\sqrt{\sum_{k=2}^{k=m} d_{J1k}^2} + e_{J1h} = d_{J1h} + \hat{d}_{J1h} \quad (70b5)$$

for

$$d_{J1} = 2 \operatorname{arctanh} \{ \sqrt{\{ (v_m - c_{J1}) \} / \{ 1 - v_m c_{J1} \}} \} J \quad (70b6)$$

and where  $c_{Jih} = c_{Ji}$  for  $h = 1$  are the preference rank order values that are scaled between  $v_m = \tanh^2(\frac{1}{2})$  and -1 as first estimates of  $v_{Ji}$

If the product of arctangent functions is the valence function for the comparable Euclidean sensations of elliptic stimuli, we iteratively obtain  $d_{Jih}$  from bipolar preference rank orders that are now scaled to  $-\frac{1}{2}\pi^2 < c_{Ji} < (\frac{1}{2}\pi)^2$  as initial values  $v_{Ji}$  and taking  $c_{Jih} = c_{Ji}$  for  $h = 1$ . Since no direct solution of  $d_{Ji}$  is possible for the arctangent-based valences, we use initial curvature estimates that range between 2 and 1 by monotonic function of  $[(\frac{1}{2}\pi)^2 - c_{Ji}]$  for their initial estimates as

with

$$c_{Ji} = 2 \cdot [(\frac{1}{2}\pi)^2 - 16 \cdot c_{Ji}]^{1/3}, \quad (70c1)$$

$$d_{J1} = 1 + \tan(\frac{1}{2}\pi \cdot c_{J1} / c_{J1}), \quad (70c2)$$

as first estimate of  $d_{Ji}$  that is used to improve the estimate of  $c_{Ji}$  by

$$c_{J1} = \frac{1}{2}\pi / (\operatorname{arctan}(1 + d_{J1})), \quad (70c3)$$

where then (70c2) and (70c3) are applied repeatedly until convergence, while (70b5) is then also used for the estimation of  $d_{Jih}$  for  $h = 1$ .

Since each individual may have differently rotated dimensions, we have

$$d_{Jih} = \sqrt{\sum_{k=1}^{k=m} |y_{ik} - g_{JK}|^2} / \sqrt{\sum_{k=1}^{k=m} |y_{ik} / d_{Jh} - g_{Jh} / d_{Jh}|^2} \quad (70d1)$$

By require signs of  $h_{Jhk}$  that satisfy  $g_{Jh} > a_{Jh}$  we may initially take

$$g_{Jh} = a_{Jh} + d_{Jh} \quad 3d_{Jh}$$

whereby initially

$$t_{Jh} = 9Jh / d_{Jh} \quad 3$$

if dimensional deprivation levels coincide with the Fechner space origin of  $Y_i$ . Since  $d_{Jih} > 0$  and  $Y_{ih}/dJh > 0$  we define sign indicators

$$s_{ih} = 1 \text{ if } d_{Jih} - tJh > 0 \text{ and } s_{ih} = -1 \text{ if } d_{Jih} - tJh < 0 \quad (70d2)$$

whereby (70d1) leads to

$$q_{Jih} = s_{ih} \{d_{Jih} - tJh\} = q_{::,h} Jkh' Y_{ik} / dJh + e_{Jih} \quad (70dJ)$$

Writing  $Q_h$  as  $N \times n$  matrix of initial values  $q_{Jih} = s_{ih} (d_{Jih} - tJh)$  for  $h = 1$ , matrix  $H_h$  as  $N \times m$  matrix of elements  $h_{Jkh}$ ,  $Z$  as  $0_{111}$  matrix of  $Y_{ik}$  values,  $E_h$  as  $N \times n$  matrix of error terms  $e_{Jih}$ , and  $W_h$  as diagonal  $N \times N$  matrix of elements  $1/dJh$ , then (70d2) is written in matrix notation as

$$Q_h = W_h B_h Z' + E_h \quad (70d4)$$

The matrices  $W_h$ ,  $B_h$ , and  $Z$  are solved from the eigenvector/values of

$$Q_h' Q_h = F A^2 F' + E_h' E_h \quad (71a1)$$

and

$$Z = F h \quad (71a2)$$

$$W_h B_h = Q_h Z (Z' Z)^{-1} = Q_h A F' F h^{-2} F' \quad (71a3)$$

where

$$W_h = \text{diag}\{W_{h h} H_h' W_h\}^{1/2} \quad (71a4)$$

By multiplying (71a3) by the inverse  $W_h$  also matrix  $H_h$  is solved, whereby

$$\hat{Q}_h = W_h B_h Z' \quad (71a5)$$

and  $Z$ ,  $W_h$  and  $H_h$  are solved under minimum trace  $[E_h' E_h]$  for  $tJh = 9Jh/dJh = 3$ .

For solved values of  $Q_h$  and the estimated  $d_{Jih}$  values we also have by

$$t_{Jh} = g_{Jh} / d_{Jh} = \left( \sum_{i=1}^n (\hat{d}_{Jih} - s_{ih} \hat{q}_{Jih}) \right) / n \quad (71c1)$$

different values  $t_{Jh}$  that by renewed application of (70d) yield improved values

$$q_{Jih} = s_{ih} (d_{Jih} - t_{Jh}) \quad (71c2)$$

This iteration cycle for a solution by (71a) for improved  $q_{Jih}$  values and subsequent improvements of  $d_{Jih}$  for  $t_{Jh}$  by (71c1) and further improved values  $q_{Jih}$  by (71c2) is repeated until convergence is achieved,

Defining  $\hat{d}_{Jih} = \hat{s}_{ih} q_{Jih} + t_{Jh}$  we also obtain

$$\tanh\{-\frac{1}{2} \ln[\cosh(\hat{d}_{Jih}) / \text{COsh}(1)]\} = \hat{v}_{Jih} \quad (71b1)$$

or

$$\arctan(1 - \hat{d}_{Jih})' \arctan(1 + \hat{d}_{Jih}) = \hat{v}_{Jih} \quad (71b2)$$

Due to corresponding orthogonality of sensation and valence dimensions and writing  $d_{Ji} = d_{Ji(h-1)}$  for  $h = 1$ , we next can define

$$q_{Ji(h+1)} = s_{i(h+1)} [(d_{Ji(h-1)} - d_{Jih}) - t_{J(h+1)}] \quad (7Th3)$$

and repeat for  $h = 2$  to  $h = m$  the sequence of solutions from (71a3) to (71b3) for the solved matrix  $Z$  for  $h = 1$ . However, we rather solve successively for  $h = 1$  to  $h = m$  matrices  $Z_h$  by (71a1) and (71a2) and, then successively derive one best fitting matrix  $Z$  by the so-called Procrustes method (Gower, 1975), where then common matrix  $Z$  is used for each  $Q_h$  in (71a3) to (71b3). This completes the first phase for the iterative solution of the Euclidean sensation space for hyperbolic or double-elliptic stimuli.

By their previous solved Euclidean sensation dimensions we obtain

$$\tanh\left[-\frac{1}{2} \ln\left(\frac{\cosh\left(\sqrt{\sum_{i=1}^{J_h} d_{jih}^2}\right)}{\cosh(1)}\right)\right] \quad (72a1)$$

or

$$v_{ji} = \arctan\left[1 - \sqrt{\sum_{i=1}^{J_h} d_{jih}^2}\right] \cdot \arctan\left[1 + \sqrt{\sum_{i=1}^{J_h} d_{jih}^2}\right] \quad (72a2)$$

and more optimally scale the observed preferences  $c_{ji}$  by replacing  $c_{ji}$  by minimally changed values of estimated  $v_{ji}$  in (72a) that satisfy the rank order and sign of observed bipolar preferences. Repeating the calculations from (70b6) or (70c) to (72a) and improved scaling of  $c_{ji}$  under initial use of previous  $t_{jh}$  values, yield after convergence:

- (1) the optimal scaling of the preference data,
- (2) the common Euclidean Fechner sensation space  $Y$  of  $m$  dimensions,
- (3) locations of individual ideal and adaptation points  $g_{jh} = t_{jh} \cdot d_{jih}$  and  $a_{jh} = g_{jh} - d_{jih}$  on individually rotated axes, where  $J_h$  is the number of dimensions,
- (4) individual rotation matrices  $B_j$  given by the  $J_h$  rows of the matrices  $H_j$ , whereby  $Y = ZB_j$  defines individually rotated axes.

Individual iso-valent contours are deduced from attaching the predicted object valences  $v_{ji}$  for each individual to the object locations and their reflected locations with respect to the ideal point and from attaching also the predicted dimensional valences to the dimensional objects and their reflections with respect to the dimensional ideal points. The solution depends on the type of single-peaked valence function as product of hyperbolic or arctangent functions for the valence transformation of the solved common Euclidean sensation space.

In case the common Euclidean object space is the stimulus space we have hyperbolic sensation spaces, whereby

$$z_{ji} = \cosh\left[\frac{d_{jih}}{d_{jih}}\right] = \cosh(1) \cdot \left\{1 + \frac{\hat{v}_{ji}}{1 + v_{ji}}\right\} \quad (73a)$$

and

$$z_{jih} = \cosh\left[\frac{d_{jih}}{d_{jih}}\right] = \cosh(1) \cdot \frac{(1 - c_{jih})}{(1 + c_{jih})} \quad (73b)$$

where

$$\ln\left[\cosh\left\{\frac{z_{jih}}{d_{jih}}\right\} + \sinh\left\{\frac{z_{jih}}{d_{jih}}\right\}\right] = \frac{d_{jih}}{d_{jih}} \quad (73c)$$

and

$$d_{jih}/d_{jih} = \ln(X_{jih}/P_{jih}) / \ln(b_{jih}/P_{jih}) \quad (73d)$$

We scale again the observed preference rank orders to values  $c_{ji}$  between  $\tanh\left(\frac{1}{2}\right)$  and  $-1$  as initial estimates of  $v_{ji}$  while for  $h = 1$  we again take  $c_{ji} = c_{jih}$

By taking initially  $\ln(b_{jih}/P_{jih}) = 1$  the  $\text{Sgn} \ln(x_{jih}/P_{jih})$  can be solved by also taking initially  $\text{Sgn} \ln(P_{jih}) = 3$ , because then we have

$$d_{jih} - g_{jih} \quad |Y_{jih} - gh| - gh = \pm Y_{jih} \quad (73d2)$$

whereby

$$\begin{aligned} \text{and} \quad \exp(d_{Jih}) &= x_{ih}/PJh \quad \text{if } d_{Jih} \quad gJb \quad Y_{ih} > 0 \\ \exp(-d_{Jih}) &= X_{ih}/P_{Jh} \quad \text{if } d_{Jih} \quad gJb \quad -Y_{ih} < 0 \end{aligned} \quad (73d3)$$

because by definition  $y_{ih} > 0$ . For  $h_{Jih}$  as dimensional rotation cosines of the common Euclidean stimulus space for individual J to individually most relevant first axes  $h = 1$  we write

$$\hat{q}_{Jih} = x'_{ih}/PJb = \sum_{k=1}^{k=n} hJkh \cdot x_{ik}/PJb \quad (73b1)$$

Defining  $Q_h$  as matrix of  $q_{Jih}$ ,  $W_h$  as diagonal matrix of  $lip_{Jih}$ , and Z as matrix of the elements  $x_{Jih}$  and  $E^h$  for error terms  $e_{Jih}$ , we solve in the same way as before from  $ik \quad h \quad Jih$

$$Q_h = W_h H_h Z' + E^h \quad (74a1)$$

the matrices  $W_h$ ,  $H_h$ , and  $Z$  by (71a). Given the first solution for  $\hat{Q}_h$  for  $h = 1$  We find first iteratively improved values of  $d_{Jh} = \ln\{b_{Jh}/PJh\}$  by

$$\sum_{i=1}^{i=n} [|\ln(\hat{q}_{Jih})| / \ln\{\cosh(z_{Jih}) + \text{Sinh}(z_{Jih})\}] / n \quad d_{Jh} \quad (74a2)$$

Given the improved estimate of  $d_{Jh}$  we obtain by

$$[\ln\{\text{coSh}(Z_{Jih}) + \text{Sinh}\{Z_{Jih}\}\} / \hat{d}_{Jh}] = \ln(x_{ih} / Jp_{Jb}) \quad (74a3)$$

and the renewed application of (73d) new estimates of  $q_{Jih} = x_{ih}/PJh$

By repeating solutions (71a) of  $Q_h$  in (74a1) for also improved values  $d_{Jh}$  until convergence of  $Q_h$  is obtained, we have solved  $W_h, H_h, Z$ , from the converged  $q_{Jih}$  values for  $h=1$ . Next solutions for  $h=2$  to  $h=m$  are solved by replacing  $c_{Ji}(h_{+1})$  for  $c_{Ji}^h$  in (73c3), where  $c_{Ji}(h_{+1})$  is defined for

$$\begin{aligned} \text{by} \quad c_{Jih} &= \tanh\left\{\frac{1}{Z} \left[ \ln\left\{ \frac{\hat{q}_{Jih}}{\hat{d}_{Jh}} \right\} \text{Cosh}(1) \right] \right\} \\ c_{Ji(h+1)} &= \tanh\left[ \arctanh(c_{Ji}^h) + \sum_{k=1}^{k=n} \arctanh(c_{Jik}^h) \right], \end{aligned} \quad (74a4)$$

where Z from the solution for  $h = 1$  may be taken as fixed, but we rather successively match by the Procrustes procedure each solved  $Z_h$  for  $h = 1$  to  $h = m$  and adjust computations (71a3) to (71a) for matched matrix Z.

For a converged solution we have predicted preference values by

$$\hat{v}_{Ji} = \tanh\left[ \sum_{k=1}^{k=n} \arctanh(c_{Jik}^h) \right] \quad (74a5)$$

Thereby, we can improve the scaling of observed bipolar preference rank orders by using the minimally changed values of predicted values  $v_{Ji}$  that fit the sign and rank order of the observed bipolar preference rank order data. The scaled preferences are then again analysed by the iterative procedure from (73d) to (74a4), under initial use of the previously solved values for  $d_{Jh}$ . By repeating the improved scaling of the observed preference data and their solution until convergence, the optimally scaled preferences and their solutions in the common



Euclidean object space are both solved. Again the individual iso-valent contours are deduced from the predicted object valences and the predicted dimensional valences  $v_{j,h}$  of individually rotated dimensions. Here again rows for individual  $J_{jh}$  matrices  $K_h$  for  $h=1$  to  $h=m$  define individual rotations  $B_j$  by  $X_j = ZH_j$  to individual stimulus space co-ordinates with

$$PJ_h = 1/WJ_h \quad \text{and} \quad bJ_h = \exp(dJ_h) - wJ_h \quad (74a6)$$

as the dimensional ideal and adaptation points of the stimulus space. We have  $N \cdot n$  observed bipolar rank order values  $c_{ji}$  for  $N$  individuals with different bipolar rank orders, but also  $1 = \text{se}$  at least  $2N$  degrees of freedom by the optimal scaling of  $c_{ji}$ . These scaled values have to determine the  $N(m-1)$  rotation values of  $m$  matrices  $H_j$ , the  $\text{nom}$  object co-ordinate values of  $Z$  as common stimulus space  $X$  or common sensation space  $Y$ , the  $m \cdot N$  ideal points by  $m$  matrices  $W_h$  that also determine the adaptation points together with the  $m \cdot N$  values  $d$  of (74a2) or  $t$  of (71c2). Thus a solution asks

$$\text{or} \quad N(n - 3) > m(m - 1)N + \text{nom} + 2m \cdot N, \quad (74b1)$$

$$\text{It requires} \quad N[n - m(m + 1) - 3] > n \cdot m$$

$$n > m(m + 1) + 3 \quad \text{and} \quad N > n \cdot m \quad (74b2)$$

where it concerns  $N$  individuals that have different bipolar preference rank orders. For  $m = 1$  it requires  $n \geq 6$  and  $N > 6$ , for  $m = 2$  we have  $n \geq 10$  and  $N > 20$ , for  $m = 3$  we need  $n \geq 16$  and  $N > 48$ , while for  $m = 4$  we must have  $n \geq 24$  and  $N > 96$ , but for well-determined solutions higher than minimum numbers of  $N$  individuals are needed.

The mathematical section above describes iterative solution procedures for the analysis of preference data for objects with single-peaked valences. It solves the dimensional object parameters in the common Euclidean sensation or stimulus space, the individual ideal and adaptation points, and the individual rotation parameters to the common co-ordinates of the Euclidean object space. A determined solution for  $N$  individuals with different preference rank orders and  $n$  objects in a  $m$ -dimensional Euclidean object space requires that the following inequalities are both satisfied:

$$n > m(m+1)+3 \quad \text{and} \quad N > m \cdot n,$$

but for well-determined solutions higher than minimum numbers of  $N$  individuals with different preferences are needed.

#### 5.4.4. Analysis methods for mixed valence spaces

Individual mixed valences are described by one ideal response axis and a single-peaked valence subspace. The individual mixed valences generate from a  $m$ -dimensional common Euclidean object space with a  $m_1$ -dimensional subspace for the ideal axes of individuals and a  $m_2$ -dimensional subspace for the single peaked valences of individuals. These common Euclidean objects subspaces need not to be independent, but assuming  $m_1 \leq m_2$  may share partially a  $mJ$ -dimensional subspace. The partially shared subspace can be solved by canonical correlation analyses of Euclidean co-ordinates for the two subspaces with  $m_1$  and  $m_2$  dimensions (Van de Geer, 1971, pp 157-170). The common Euclidean object space is here the Euclidean sensation space or the Euclidean

stimulus space of the common hyperbolic sensation space. Both common sensation spaces have dimensionality  $m < m_1 + m_2$ , provided the canonical correlation analysis of its subspaces yields fewer than  $m_j$  non-zero eigenvalues (the squared correlations between corresponding canonical co-ordinates of the two subspaces), else  $m = m_1 + m_2$ . If all canonical correlations are unity then  $m = m_2$ . Its dimensionality is  $m = 1 + m_2$ , if  $m_j = 1$  (all individuals have the same ideal axis), where then the canonical analysis solves the correlation between that axis and  $m_1$ -dimensional subspace. Similarly individual mixed preferences are determined by individual ideal axes, the  $m_2$ -dimensional subspace with single-peaked valences, and the canonical correlations between the ideal axes of individuals and that  $m_2$ -dimensional subspace. The next mathematical subsection describes an iterative analysis procedure for the solution of the common Euclidean object space with its individual transformations to mixed valences that fit best the optimally scaled, observed preference data specified in section 5.4.2. In the procedure the solutions for a  $m_j$ -dimensional common Euclidean object subspace with monotone valences are alternated with solutions for a  $m_2$ -dimensional common Euclidean object subspace with single-peaked valences, where we use canonical analyses for the determinations of the dependencies between the two subspaces as well as between individual ideal sensation axes and Bowersubspaces with single-peaked valences. Predicted, mixed valences from previous solutions are used for the improved scaling of the observed preferences, where repeated alternations of the solution and improved scaling until convergence terminates the iterative solution for object preferences with mixed valences. In contrast to the classical non-metric preference analysis by the linear vector or unfolding model and in contrast to our semi-metric preference analyses by the method of section 5.4.2. or section 5.4.3., we need not to determine in advance whether preferences are characterised by monotone or single-peaked valences. The proposed solution for mixed valences determines itself by which valence functions the preferences are characterised. A determined solution asks for almost the same minimum of objects and individuals as needed for single-peaked valences with dimensionality  $m = m_j + m_2$ .

We here consider individual bipolar preferences  $c_{Ji}$  as initially scaled rank orders to mixed valences as defined earlier for monotone or single-peaked valences. For sensations  $s_{Ji}$ , we assume  $m$ -dimensional Euclidean comparable sensation subspaces with monotone valences and ideal axes  $S_{Ji}$ . We also define  $w_{Ji} = \sin(\alpha_{Ji})$  for angles  $\alpha_{Ji}$  between the individual ideal sensation axes and  $m_2$ -dimensional Euclidean subspaces of valence-comparable sensations  $s_{Ji}$  with single-peaked valences. We further define  $t_{Ji} = |(s_{Ji} \cdot s_{Ji}) / |s_{Ji}|$  as projection cosine of  $s_{Ji}$  on  $s_{Ji}$  while the projection cosine of  $w_{Ji} \cdot s_{Ji}$  on  $s_{Ji}$  is given by  $u_{Ji} = \sqrt{[1 - t_{Ji}^2]}$ . Thereby

$$s_{Ji} = u_{Ji} \cdot w_{Ji} \cdot s_{Ji} + t_{Ji} \cdot s_{Ji}$$

We denote the monotone valences of  $s_{Ji}$  as  $v_{Ji}$ , the single-peaked valences of  $s_{Ji}$  as  $v_{Ji}$ , and observed, bipolar preferences as  $c_{Ji}$  where  $c_{Ji}$  is scaled between -1 and +1 for hyperbolic tangent-based valences or between  $-\frac{1}{2}$  and  $+\frac{1}{2}$  for arctangent-based valences, whereby

$$[c_{Ji} - u_{Ji} \cdot w_{Ji} \cdot \hat{v}_{Ji}] / t_{Ji} = \hat{c}_{Ji} \cdot s_{Ji} + e_{Ji} \quad (75a)$$

or

$$[0_{J_i} - t_{J_i} \cdot c_{J_i} \cdot \hat{v}_{J_i} \cdot \hat{v}_{J_i} \cdot \hat{v}_{J_i} \cdot \hat{v}_{J_i}] / (u_{J_i} \cdot w_{J_i}) = v_{J_i} \hat{m} \quad (75a2)$$

because vector angles remain the same in valence spaces and corresponding comparable sensation or stimulus-fraction spaces. Thus, also projected ideal axis  $w_{J_i} \cdot v_{J_i} \cdot \hat{v}_{J_i} \cdot \hat{v}_{J_i} \cdot \hat{v}_{J_i} \cdot \hat{v}_{J_i}$  is orthogonal to the single-peaked valence subspace of  $J$ , while the residuals in (75a1) or (75a2) describe the monotone or single-peaked valences. For mixed valences of hyperbolic sensations and observed, bipolar preferences  $c_{J_i}$ , that are scaled between -1 and +1, we correspondingly have

$$[(c_{J_i} - u_{J_i} \cdot w_{J_i} \cdot \hat{v}_{J_i} \cdot \hat{v}_{J_i} \cdot \hat{v}_{J_i} \cdot \hat{v}_{J_i}) / (1 - c_{J_i} \cdot u_{J_i} \cdot w_{J_i} \cdot \hat{v}_{J_i} \cdot \hat{v}_{J_i} \cdot \hat{v}_{J_i} \cdot \hat{v}_{J_i})] / t_{J_i} = \hat{v}_{J_i} \cdot \hat{v}_{J_i} \cdot \hat{v}_{J_i} \cdot \hat{v}_{J_i} + e_{J_i} \quad (75a3)$$

$$[(c_{J_i} - t_{J_i} \cdot \hat{v}_{J_i} \cdot \hat{v}_{J_i} \cdot \hat{v}_{J_i} \cdot \hat{v}_{J_i}) / (1 - c_{J_i} \cdot t_{J_i} \cdot \hat{v}_{J_i} \cdot \hat{v}_{J_i} \cdot \hat{v}_{J_i} \cdot \hat{v}_{J_i})] / (u_{J_i} \cdot w_{J_i}) = \hat{v}_{J_i} \cdot \hat{v}_{J_i} \cdot \hat{v}_{J_i} \cdot \hat{v}_{J_i} + e_{J_i} \quad (75a4)$$

For the analyses of the single-peaked valence parts of sensation  $s_{J_i}$ , we must differently scale the residual valence part  $c_{J_i} \cdot \hat{v}_{J_i} \cdot \hat{v}_{J_i} \cdot \hat{v}_{J_i} \cdot \hat{v}_{J_i} + e_{J_i}$  to  $v_{J_i} \cdot \hat{v}_{J_i} \cdot \hat{v}_{J_i} \cdot \hat{v}_{J_i} \cdot \hat{v}_{J_i}$  as valence values between the appropriate limits of the respective single-peaked valence spaces, if the sensation space is Euclidean.

The iterative solution procedure starts by analysing  $c_{J_i}$ , as if it were only monotone or only single-peaked valences. We solve initially from  $c_{J_i}$  a  $m_1$ -dimensional common space  $Y$  or  $X$  with rotation vectors  $h_{J_i}$  to individual ideal axes and with dimensional adaptation point parameters  $a_{J_i}^{k}$  that specify the individual translations and the dimensional weight parameters  $2/a_{J_i}^{k}$  of  $Y$  or by  $\exp(a_{J_i}^{k}) = b_{J_i}^{k}$  the individual weight and powers  $\ln(b_{J_i}^{k})$  and  $2/\ln(b_{J_i}^{k})$  of  $X$ , as described in section 5.4.2.

Similarly we solve an initial  $m_2$ -dimensional common space  $Y$  or  $X$  from  $c_{J_i}$  as solely single-peaked valences obtained by the solution methods, described in section 5.4.3., where also ideal points  $g_{J_i}$ , distances  $d_{J_i}^{k}$ , and rotations  $B_{J_i}$  are solved. From initial matrices  $X_{J_i}$  and  $X$  or  $Y$  and  $Y_{J_i}$  the joint common Euclidean stimulus space  $X$  or sensation space  $Y$  is solved by the canonical analysis (Van de Geer, 1971, pp. 157-170) of matrix  $R$  with correlations between the subspace co-ordinates, where  $R$  for Euclidean sensation subspaces is defined by use of

$$V_m = \text{diag}\{Y_m, Y_m\} \quad (75b1)$$

$$V_s = \text{diag}\{Y_s, Y_s\} \quad (75b2)$$

$$R = V_m^{-1/2} Y_{mD} Y_{sS} V_s^{-1/2} \quad (75b3)$$

By the eigenvector and value solutions of

$$R R = C R C \quad (75b4)$$

$$R R = D R D, \quad (75b5)$$

where if  $m_2 < m_1$  we diagonally extended  $D$  to  $m_1$  as  $L = \begin{matrix} D & 0 \\ 0 & 1 \end{matrix}$  or if  $m_1 < m_2$   $C$  to  $m_2$  as  $K = \begin{matrix} C & 0 \\ 0 & 1 \end{matrix}$  and using diagonal matrix  $W$  with elements

$$w_k = \sqrt{(1 - \lambda_k^2)}, \quad (75c1)$$

and extended to  $\max(m_1, m_2)$  with  $w_k = 1$  for  $k > \min(m_1, m_2)$ , we define if  $m_1 \leq m_2$

$$Y_m L W = Y_m \quad Y_s K = Y_s, \quad (75c2)$$

or if  $m_2 < m_1$  redefine

$$Y_m L = Y_m \quad \text{and} \quad Y_B K W = Y_s, \quad (75c3)$$

where the independent co-ordinates of the m-dimensional sensation space are given as

$$Y = [Y_m : Y_s] \quad (75c4)$$

or similarly so the m-dimensional stimulus space  $X = [X_m : X_s]$  if we replace  $Y_m$  by  $X_m$  and  $Y_s$  by  $X_s$  in (75b) and (75c).

Next we solve initial angles of translated ideal axes in subspace  $Y$  with subspace  $Y$  by canonical correlation analysis for correlation  $\lambda_J$  between the ideal axis and subspace  $Y$ . From correlation row vector  $r_J$  of length  $m_2$  that is defined for solved vectors  $h_J$  and  $R$  in (75b3) by

$$r_J = h_J R^T R, \quad (75d1)$$

we derive by the eigenvector  $g_J$  of

$$r_J r_J^T = g_J \lambda_J^2 g_J^T \quad (75d2)$$

the projection value  $w_J$  from correlation  $\lambda_J$  as

$$w_J = \sqrt{1 - \lambda_J^2} \quad (75d3)$$

for the projected ideal response axis that is orthogonal to space  $Y_s$ .

From solved  $Y$  and  $H$  we derive initial estimates  $t_{Ji}$  by individual rotations of the individually translated and weighted common subspace. For matrix  $U$  of unit elements, diagonal matrix  $D_J$  of  $m_2$  elements  $d_{Jk}$ , and diagonal matrix  $G_J$  of  $m_2$  elements  $g_{Jk}$  in case the Fechner sensation space is Euclidean we obtain the valence-comparable Bower space of  $J$  by

$$[Y_B - V G_J] O - I K = S_{J_s} \quad (75e1)$$

and define  $\text{diag}\{s_{J_s}, s_{J_s}\} = V_{J_s}$  of  $n$ -elements, whereby absolute elements of

$$T_J = S_{J_s}^{1/2} V_{J_s} \quad (75e2)$$

solve the first estimates of  $t_{Ji} = I(s_{Ji} I_s) / s_{Ji} I$ , whereby we also obtain

$$u_{Ji} = \sqrt{1 - t_{Ji}^2}. \quad (75e3)$$

For a hyperbolic sensation space we replace  $Y$  by  $X$  and obtain for  $P_J$  as diagonal matrix of elements  $1/p_{Jk} = \exp(-g_{Jk})$  by  $X_{J_s} = [X P_J - u] K$  in the same way initial values  $t_{Ji}$  and  $u_{Ji}$  as corresponding vector angles in Euclidean stimulus-fraction spaces with individually scaled unit dimension points.

The initial solutions of  $Y$  and  $Y$  or  $X$  and  $X$  yields also the initial estimates  $v_{Ji}$  or  $c_{Ji}$ , while the simple of addition

$$c_{Ji} = u_{Ji} w_J v_{Ji} + t_{Ji} \hat{c}_{Ji}, \quad (75f1)$$

or the hyperbolic addition

$$\hat{c}_{J_i} = \frac{1}{m} \sum_{j=1}^m w_j \cdot \hat{v}_{J_i}^{(j)} + t_{J_i} \cdot \hat{v}_{J_i}^{(s)} \quad (75f2)$$

yields predicted mixed valences that are used for an improved scaling of observed bipolar preference data by minimal changes of predicted, mixed valences that fit the sign and rank order of the observed data. Improved  $c_{J_i}$  values and last solved values of  $t_{J_i}$ ,  $u_{J_i}$ , and  $w_j$  define improved residuals  $v_{J_i}^{(j)}$  and  $c_{J_i}$  as  $v_{J_i}^{(j)}$  plus error term by (75a).

We repeat the solution and scaling procedure, which whole procedure is repeated until convergence of solution and optimal scaling are obtained. By performing the described analysis if  $m_1 \leq m_2$  for  $m_1 = 1, m_1 = 2$  etc. and  $m_2 = m_1, m_2 = m_1 + 1, m_2 = m_1 + 2$  etc. or if  $m_2 < m_1$  reversely so, we may determine the optimal dimensionality of subspaces, while the (almost) zero elements  $w_j$  of (75c1) for (almost) unit canonical correlations between pairs of canonical axes determine the dimensionality  $m$  of space X or Y, where  $\max(m_1, m_2) \leq m \leq m_1 + m_2$ .

In the mathematical subsection above the common Euclidean object space is solved as well as its individual rotations to individual ideal axes in the  $m_1$ -dimensional subspace with monotone valences and to  $m_2$  dimensions of the common subspace with single-peaked valences, where individual ideal axes have oblique angles with the common  $m_2$ -dimensional subspace with single-peaked valences. Dependent on (1) the rotational weights, (2) the ideal axis angle with the subspace for single-peaked valences, (3) the ambiances of the monotone valence function of the ideal axes, and (4) the distances between ideal and adaptation points on dimensions with single-peaked valences, the mixed valence function for a particular dimension can have many shapes. Combinations of monotone and single-peaked valence functions with opposite ambiances describe ambivalent valence functions that vary from asymmetrically monotonic to asymmetrically single-peaked functions. Such asymmetric valence functions are covered by our analysis of mixed valences and, therefore, it can describe kinds of preference ambivalence that are not revealed by analyses for either monotone or single-peaked valences. We discuss this further in chapter 8, where we discuss also ambivalence in choice conflicts that derive from dependent dimensions with oppositely oriented, single-peaked valence functions.

Before closing this chapter, we remark that our semi-metric preference analysis for objects with mixed valences uses no initial object configuration for the start of its iterative solution, in contrast to existing (partially inappropriate) multidimensional unfolding methods. Therefore, and due the scaling of bipolar preference data of individuals with rather precisely located zero scale points, no degeneracy of solutions (Busing, Groenen, and Heiser, 2005), nor local minimum solutions are expected in our analysis method, except perhaps non-optimal solutions that are due to a converged, non-optimal data scaling of the bipolar preference rank orders. The last possibility seems unlikely, but is easily checked by starting the analysis again with some rather different, initial scaling of the bipolar preference rank orders within appropriate valence limits and under preservation of their sign.

## CHAPTER 6

### MEASUREMENT-THEORETICAL IMPLICATIONS

*"Additional general theory about nonhomogeneous outcomes, especially those that are homogeneous between singular outcomes, is needed as input to these more psychological applications."*

R. D. Luce. (1992). A path taken: Aspects of modern measurement theory. Chapter 3 (p .61) in: Healy, A.F. et al. (Eds.). *From learning theory to connectionist theory: Essays in honoy of William K. Estes*. Lawrence Erlbaum Ass" Hillsdale. N.J.

*"One might further argue that the discovery of the structural assumptions underlying the phenomena is the basic goal of science and that measurement is 'only' a consequence of these assumptions. In this sense measurement is a by-product of theory. "*

C. H. Coombs, et al. (1970). *Mathematical Psychology*, (p. 50). Prentice-Hall, Englewood Cliffs, NJ.

*"... there is measure in every thing and so dance our the answer. "*

Shakespeare. *Much ado about nothing* (Beatrice, Act 2, scene I, lines 72-73). *The Complete Works of William Shakespeare*. (1966). Cambridge Univ. Press, London.

## CONTENT DETAILS CHAPTER 6

	page
<b>6.1, The significance of measurement theory</b>	227
6.1.1. Introduction	227
6.1.2. Lack of meaningfulness for quantitative choice theory	232
6.1.3. Attempts to obtain meaningful choice measurements	240
6.1.4. Meaningfulness and axiomatic measurement theory	251
6.1.5. Meaningfulness by dimensional invariance	259
6.1.6. Permissible geometries of similarity and preference measurements	263
6.1.7. Dimensionally invariant response and valence measurements	270
<b>6.2. Measurement by isomorphic stimulus space transformations</b>	275
6.2.1. Isomorphic spaces and their measurement properties	275
6.2.2. Measurement as by-product of substantive theory	285
6.2.3. Measurement aspects of the psychophysical response function	291
6.2.4. Summary of transformed-extensive measurements	296

## 6.1. The significance of measurement theory

### 6.1.1. Introduction

Classical and modern measurement theories claim that only ratio scales, as mainly specified by extensive measurement in physical sciences, allow meaningful formulations of quantitative relationships between dimensional measurements. However, in psychology we almost exclusively have ordinal or interval-scale measurements. If ratio-scale measurement would be impossible in psychology, then it would exclude the possibility of meaningfulness for quantitative theory in the psychology. The three volumes of "*Foundations of Measurement*" (Krantz, et al., Vol. I, 1971; Suppes, et al., Vol. II, 1989; Luce, et al., Vol. III, 1990) and the books by Pfanzagl (1968), Roberts (1979), Narens (1985, 2002), and Niederée (1992) are the most important references to books on the axiomatic foundation of measurement. Suppes (2002) contains an easier readable overview with a wider scope on meaningfulness of quantitative theory in physical and nonphysical sciences. A diverging view on measurement, grounded on empirical validity, is given by Michell (1990). It is outside the scope of this monograph to discuss the roots of different streams for measurement representations by abstract set theory (since von Helmholtz), by philosophical logic (since Plato), and by geometric-substantive theory (since Pythagoras and Archimedes). Modern axiomatic approaches within the first two streams are similar and only seem to differ with respect to the nature of numerals, either as isomorphic-representational (Luce, Narens) or as intrinsic-constructive (Niederée) elements of scientific structures. Due to the highly set-theoretical basis of modern analytic geometry, the geometric-substantive measurement stream seems almost dried up after the so-called 'Erlanger program' (Klein, 1872), had paved the way for measurement in relativistic physics. The geometric-substantive approach not only has been essential for measurement in relativistic physics, but a geometric foundation of measurement is also indispensable for conjoint component and distance-based measurements in the psychology of judgment and preference, as demonstrated in the sequel. Only references to original authors of measurement-theoretical contributions are given and otherwise we reference chapters in the volumes of "*Foundations of Measurement*" by shortened notations, such as FoM (ch. 3). Chapters 1 to 10 in the first volume describe the axiomatic theory up to 1970. The second volume with chapters 11 to 17, published in 1989, contains a geometric approach and measurement representations of threshold and choice probability structures. The third volume with chapters 18 to 22 is published in 1990 and mainly updates volume I.

Narens (2002) distinguishes between 1) representational meaningfulness, 2) intrinsic lawfulness, 3) qualitative meaningfulness, and 4) empirical validity of measurements. Although one may distinguish these aspects, the empirically valid description in quantitative terms of qualitatively observed order and equivalence structures is the purpose of measurement in science. Therefore, meaningfulness of measurements not only concerns abstract definitions, but requires also that measurement assumptions are verifiable and that measurements are verified by order and equivalence structures of qualitative observations. The *verifiability requirement* for meaningfulness implies that measurements must not depend on arbitrary parameters, which requires that also units of ratio scales become distinctly defined. The *verification*



*requirement* for meaningfulness means that measurements must empirically represent the observed order (and/or equivalence) structure. Notice that meaningfulness is not guaranteed by quantified observations of measurement instruments, because instrument-based measurements only are meaningful if their measurements invariantly represent the observed order (and/or equivalence) structure for the attribute that the instrument is supposed to measure. Only if measurements invariantly represent the rank order and equivalence structures of qualitative observations then quantitative relationships can be meaningful, while their verifications or refutations contribute to progress in scientific theory. Measurement theory shows that ratio-scale measurement in psychology is troublesome, which would imply that the meaningfulness of quantitative theory in psychology is questionable. However, the meaningfulness of ratio-scale measurements of item difficulty and individual capacity by so-called Rasch models for analysis of intelligence sub-tests (Rasch, 1960, 1966a, Stene, 1968) are regrettably ignored in the above referenced books, although Rasch (1961, 1966b) gives a (non-axiomatic) measurement foundation. The recent books of Narens (2002) and Suppes (2002) contain also not the unprecedented axiomatisation result of Luce (1995) on a kind of extensive utility measurement. Luce's utility measurement derives from separately verifiable axioms for equivalence structures of jointly evaluated pairs of valued goods, while nowadays the axioms are to a large extent verified (Luce, 2000). Since its utility measurement only depends on one arbitrary parameter, while the associativity rule for combinations of pair elements is inferred from mainly verified axioms without an associativity axiom, we call it an inferred-extensive measurement. As further discussed in the sequel, inferred-extensive measurement differs from derived-extensive measurement in physics, whereby a ratio-scale measurement for conjoint component outcomes is derived from physical components that already are measured by ratio scales. Ratio-scales are obtained by measurement axioms, whereof the associativity axiom defines an addition of numerical units and is ostensibly verified by observable concatenations of physical units. Therefore, such ratio scales are here called ostensive-extensive measurements, which is the classical type of physical measurement that is axiomatised for the first time by von Helmholtz (1887). Luce (2002, 2004) modifies his axiom system of utility equivalences for an application to subjective stimulus-fraction equivalences in an attempt to obtain inferred-extensive measurement for psychophysics. Also Narens (1996, 2002) axiomatised an extensive measurement of subjective stimulus magnitudes, but Narens' axiomatisation presupposes an associativity axiom that can't be separately verified, whereby the axiomatisation might be questionable, as further shown in the sequel. We mainly discuss the significance of measurement theory for the meaningfulness of judgment and preference measurements and describe the measurement-theoretical implications of the psychophysical response and valence theory and compare our geometric-substantive theory of transformed-extensive measurement with Luce's axiomatic measurement theory of inferred-extensive utility and psychophysical measurements.

Transformations of scales under invariance of scale type describe the classical taxonomy of nominal, ordinal, interval, and ratio scale types (Stevens, 1946, 1951, 1959). These scale types plus the absolute and log-interval scale are regarded as exhaustive in FoM (ch. 20), but Roberts and Rosenbaum (1986) give a more detailed

taxonomy. The nominal type as categorisation can hardly be regarded as measurement, while addition of the hyper-ordinal scale type (Suppes, 2002, p.118), as defined by rank order of distances or first-order differences, seems accepted. In chapter 4 we discussed spatial representation of ordered dissimilarities by distances, but the dense hyper-order of dimensional distances ( $n$  objects and  $N$  individuals have  $\frac{1}{2}n(n-1)N$  distance inequalities) describes dimensions that are indistinguishable from interval scales with negligible measurement errors. We describe scale types by uniqueness properties in a notation that differs in form and meaning from the notation for measurement uniqueness in FoM (ch. 20). Therefore, we specify:

*Notation of scale uniqueness*

A scale is  $(n,m,p)$ -unique if its measurement depends on  $n$  arbitrary parameters and  $m+p$  distinct parameters with  $m$  dimensional and  $p$  dimensionless values.

The  $n$  arbitrary parameters can have any value (e.g.  $n \approx 2$  for linear transformations of interval scales), while the  $m$  parameters have distinctly solvable or prior-defined, dimensional values and the  $p$  parameters are prior-defined or singular and dimensionless. A prior-defined dimensional parameter applies to a physical ratio scale, if its arbitrary scale unit becomes replaced by a conventionally agreed measurement standard (e.g. the metre for the unit of length), whereby its measurement becomes a fraction scale with a distinct unit point (e.g.: length as fractions of the metre). Distinctly solvable, dimensional parameters apply to the comparable sensation scales in our psychophysical response and valence theory (e.g.: the related and distinctly solvable weight and translation parameters). We define a scale as a dimension in an infinite or open geometry. There are no dimensionless parameters ( $p = 0$ ) if the scale concerns unidimensional measurements in an infinite, Euclidean or hyperbolic measurement space. If a scale concerns values defined by a product (and/or ratio) of such infinite measurement dimensions then  $p \approx 1$ , where the dimensionless parameter is a power exponent that is defined by the number (and/or number ratio) of involved dimensions (e.g.: integer 3 as power exponent for volume as cubic length measurements), whereby its value is an integer (or a ratio of integers). If the scale is defined by unidimensional measurements in open spaces then also  $p \approx 1$ , as singular value of the space limit, (e.g. value  $\pm 1$  as limit of the hyperbolic tangent projection of an infinite hyperbolic space). Also  $p = 2$  is possible, if scales are defined by (ratios and/or) products of dimensions of open measurement spaces. In the sequel we encounter such scales for single-peaked valence measurements (but  $p = 2$  may also apply to scales in relativistic physics, if defined by the parameters for the constant of light velocity and a power exponent for the product and/or ratio of involved dimensions). We use Roman letters for scales and Roman or Greek letters for parameters, while cursive letters  $f, \xi, U$ , etc. are used for functions. We again use indices for scale values, where capital indices  $I$  and  $J$  concern individuals and indices  $f, g, i$ , and  $j$  scale values, while subsequent indices  $g, k$ , or  $h$  refer to space dimensions. We again use  $x_{ik}$  for dimensional stimuli,  $y_{ik}$  for their Fechner sensations with  $s_{rk}$  as comparable sensations of individual  $J$ ,  $r_{jik}$  for their response values, and  $v_{rk}$  for their valences. In functional equations we use letters without indices for data elements that are represented by scale values.

A ratio scale  $x_{ik} // \mu_k$  of a dimension  $k$  in an infinite stimulus space has one arbitrary parameter for its scale unit  $\mu_k$  and, thus, is defined as a (1,0,0)-unique scale. The logarithmic transformation of the ratio scales of stimulus dimensions define Fechnerian sensation dimensions  $(Y_{ik} - \beta_k)/\alpha_k$  of interval scales  $Y_{ik} \approx \ln(x_{ik})$  with arbitrary parameters  $\alpha_k$  for their scale units and  $\beta_k = \ln(\mu_k)$  for their translations. Unless their dimensional units and translations are distinctly solvable parameters, they are (2,0,0)-unique interval scales of Euclidean or hyperbolic sensation space dimensions, due to the geometric relationship with respectively non-Euclidean or Euclidean stimulus spaces, described in chapter 3. Measurement theory defines physical log-interval scales that can differ from the (2,0,0)-unique scale type if it is specified by the logarithmic transformation of a power-raised ratio scale  $(x_{ik}/\mu_k)^{\tau_k}$  with dimensionless power exponent  $\tau_k$  (as a-priori defined, distinct integer or ratio of integers, which holds for scales such as area that has  $\tau_k = 2$  for its product of length measurements). Its log-interval scale  $\tau_k[\ln(x_{ik}) - \ln(\mu_k)]$  has one arbitrary translation parameter  $\ln(\mu_k)$  and one distinctly defined, dimensionless parameter  $\tau_k$  that then determines its scale unit, whereby this type of log-interval scale is (1,0,1)-unique. Probabilities of events are defined by absolute measurements between zero and unity, where the universal event defines maximum probability  $p = 1$  and the null event the absolute probability  $p = 0$ . However, the maximum probability is no absolute value, but a limit parameter that conveniently is set to unity (Luce and Narens, 1978, p. 232-233) in the same way as the radius of a circle is scaled to unity before trigonometric functions are applied. Therefore, event probability measurement is (0,0,1)-unique by its singular maximum of unity for the limit boundary of the open probability space. In our notation random variable probabilities are (0,m,1)-unique, due to the singular maximum of unity and  $m$  dimensional parameters that characterise the probability distribution of a random variable. Symmetric probability distributions depend on distinct mean and dispersion parameters and in our notation then define (0,2,1)-unique probability measurements. Asymmetric probability distributions may have  $m = 1$  for one-parameter distribution, as for the Poisson distribution, but  $m = 3$  for asymmetric distributions with mean, dispersion, and skewness parameters. The axiomatisation of (ostensive-)extensive (FoM: ch. 3) or derived-extensive (FoM, ch. 10) measurement and measurements from difference or distance structures (FoM: ch. 4 and 9) as well as from additive or polynomial additive conjoint structures (FoM: ch. 6 and 7) describe fundamental measurement types. Ostensive- and derived-extensive measurements define the (1,0,0)-unique ratio scales of physical sciences, while the other measurement types yield (2,0,0)-unique interval scales that mainly apply to nonphysical sciences. Modern measurement theory generalises associative or additive measurement to non-associative or generalised-additive measurement of components with so-called positive concatenation structures (FoM: ch. 19), which enriched the theoretical uniqueness types of measurements (FoM: ch. 20). The definitions of measurement-theoretical uniqueness and our scale uniqueness differ, but these uniqueness types are related and both define whether meaningfulness of quantitative relationships holds (FoM: ch. 10 and 22). Meaningfulness of quantitative relationships holds for extensive measurements, provided that their scale units are specified, which in physics is done by conventional agreement on measurement unit standards (such as a length unit based on the

calibration standard for the metre kept at constant temperature in Paris). Meaningfulness holds not for interval scales that have unspecified scale units and origins, while these parameters for psychological interval scales can't be defined by agreements on observable standards. In the sequel we discuss attempts to obtain extensive measurement for psychophysics (Narens, 1996, 2002; Luce, 2002, 2004) and the inferred-extensive measurement for utility by Luce (1995, 2000) and investigate their validity and whether their uniqueness is sufficient for meaningful relationships.

We define (0, 1, 0)-unique fraction scales  $x_k/x_k$  for physical ratio scales  $x_k/\mu_k$  with a distinct, dimensional value  $x_k/x_k = 1$ , such as for length with  $x_k/\mu_k = 1$  as the metre. A (0, 1, 0)-unique fraction scale has no arbitrary parameter. A power-raised, physical fraction scale  $(x_k/x_k)^{\tau_k}$  also has no arbitrary parameter, if defined by a dimensionless power exponent (e.g.  $\tau_k = 3$  for volume) and a distinctly defined, dimensional unit point  $x_k/x_k = 1$  for its conventionally agreed measurement unit. Thereby, such power-raised, physical fraction scales are (0, 1, 1)-unique scales. Its log-transformed scale  $\tau_k \cdot \ln(x_k/x_k)$  also has no arbitrary dimensional parameters, but the dimensionless parameter is here the scale unit  $1/\tau_k$ , and the dimensional parameter the origin  $\ln(x_k/\mu_k) = 0$ . Thus, it also defines a (0, 1, 1)-unique scale that is essentially different from (2, 0, 0)-unique interval scales and from the (1, 0, 1)-unique log-interval scales  $\tau_k \cdot \ln(x_k/\mu_k)$  as log-transformed, physical ratio-scale  $(x_k/\mu_k)^{\tau_k}$  with dimensionless power exponent  $\tau_k$ , and an arbitrary scale unit  $\mu_k$ . A scale  $\tau_k \cdot \ln(x_k/b_k)$  may also have two distinct, dimensional values, if  $b_k/\mu_k$  and  $\tau_k$  are distinctly defined and/or solvable scale values and not arbitrary parameters. Notice that we derived such distinct values for  $\tau_k$  as Steven's power exponents of subjective stimulus magnitudes in chapters 2 and 3, where  $\tau_k = 2/\ln(b_k/u_k)$  is defined by the sensation distance between adaptation level  $\ln(b_k/\mu_k)$  and just noticeable level  $\ln(u_k/\mu_k)$ . Half this distance defines the scale unit of comparable sensation dimensions as

$$2 \cdot \ln(x_k/b_k) / \ln(b_k/u_k) = 2 [\ln(x_k/\mu_k) - \ln(b_k/\mu_k)] / [\ln(b_k/\mu_k) - \ln(u_k/\mu_k)].$$

Comparable sensation scales differ from interval scales, due to their invariance under linear transformations of their underlying Fechnerian interval scales  $\ln(x_k/\mu_k)/\alpha_k$ . Their exponentially transformed scales  $(x_k/b_k)^{\tau_k}$  are power-raised stimulus fraction scales that have distinct, dimensional parameters for distinctly solved scale units  $b_k/\mu_k$ , defined by adaptation level  $x_k/b_k = 1$ , and distinctly solved power exponents  $\tau_k = 2/\ln(b_k/u_k)$ , defined by the constant sensation distances  $\ln(b_k/u_k) >$  between dimensional adaptation and just noticeable levels for a stimulus range with  $b_k/u_k$  as geometric midpoint. Measurement theory defines no (0, 2, 0)-unique scales, but power-raised stimulus fraction scales with distinctly solvable power exponents and unit points and their logarithmic scales of comparable sensations define both (0, 2, 0)-unique scales. Moreover, as shown in chapter 3, these power exponents are rotational parameters, whereby a kind of dimensional invariance (FoM, ch. 10 and 20) also applies to multidimensional psychophysics. In the sequel we extensively discuss the importance of this dimensional invariance for the meaningfulness of our psychophysical response and valence theory.

### 6.1.2. Lack of meaningfulness for quantitative choice theory

The  $n$  arbitrary parameters of  $(n,m,p)$ -unique scales determine the permissible transformations by value changes of their arbitrary parameters. For  $(2,0,0)$ -unique interval scales the permissible transformation is a linear transformation and for  $(1,0,0)$ -unique ratio scales a proportional transformation, while  $(0,m,p)$ -unique scales have no permissible transformation. Meaningfulness of quantitative propositions requires at least that they are invariant under the permissible transformations of the concerned measurements. This meaningfulness concept is introduced by Stevens (1946) for meaningfulness of unidimensional statistic propositions. We firstly define

**Definition 1: measurement invariance**

Measurement invariance of a quantitative proposition is satisfied if the proposition is invariant under permissible transformations of its measurements.

For example, z-scores of an interval scale with a normal distribution are measurement-invariant under linear transformations of the interval scale. However, propositions on z-core relationships are only meaningful if they represent qualitative relationships between observations and if the assumption of their normal distributions holds. These two conditions are specific examples of reference and structure invariance, which are general invariance concepts in fundamental measurement theory (FoM: section 22.2.) that also concern meaningfulness of quantitative propositions. Reference and structure invariance are rather complex concepts, but we restrict and simplify these concepts by redefining in geometric terms reference invariance as

**Definition 2: reference invariance**

Reference invariance is satisfied if an observed (weak) rank order and/or qualitative equivalences of evaluated objects  $x$  or object pairs  $(x,y)$  are represented by an identical (weak) rank order and/or equivalents of measurements as space point values  $f(x)$  or binary space point values  $[f(x) \oplus f(y)]$ , where  $f$  is a strictly monotone (parameter-dependent) function for the evaluation of  $x$  and  $\oplus$  a function that together with  $f$  and associative or nonassociative operation  $\oplus$  represent the evaluation of pair  $(x,y)$  for  $x$  and  $y$  as binary space points in a given geometry with ratio-scale dimensions.

Strictly monotone function  $f$  means that if  $x > y$  then  $f(x) \geq f(y)$  and also if  $x = y$  then  $f(x) = f(y)$ . Here below and in the sequel we shorten by "space  $a = f(x)$ " or "space  $x$ " the expression for space points with vectorial values  $a \in f(x)$  or respectively with vectorial values  $x$  in a defined geometry. If an infinite and continuous geometry for space  $x$  is given then the strictly monotone function  $f$  also defines a continuous geometry for space  $f(x)$ , while if  $f(x)$  is bounded then the space  $f(x)$  has an open geometry. Due to the strict monotonicity and continuity of  $f(x) \in a$ , its inverse function  $f^{-1}(a) \in x$  exists, but if  $f(x) \in f(y)$  represents qualitative equivalence  $a \approx b$  then it is only implied for  $f^{-1}(a) = x$  and  $f^{-1}(b) = y$  that  $|x - y| < \delta$  as threshold, while  $x = y$  applies not. Operation  $\oplus$  can be associative (as difference, sum, or ratio, or product), or non-associative (such as averaging or hyperbolic additive operations), depending on the geometry of space  $f(x)$  and the geometry-dependent function  $f$  for the evaluation. For example, if a reference invariance concerns dissimilarities as function of binary

points in a hyperbolic space  $f(x)$  then  $\mathcal{L}\{f(x) \oplus f(y)\} = \cosh[f(x) - f(y)]$  is a hyperbolic distance that represents a dissimilarity or, as another example, if the reference invariance concerns a subjective midpoint evaluation of stimuli  $x$  and  $y$  and the space  $f(x)$  is Euclidean then  $f^{-1}\{\mathcal{L}\{f(x) + f(y)\}/2\}$  represents the subjective stimulus midpoint in the stimulus geometry and  $\mathcal{L}\{f(x) + f(y)\}/2$  in the Euclidean space  $f(x)$ . In chapter 4 we defined open response spaces by  $f(x) = \tanh[-VIT \cdot \ln(x/b)]$  or  $f(x) = \arctan[\cdot \ln(x/b)]$  as space involutions of power-raised stimulus fractions with respect to  $x/b = 1$  as individual adaptation points and with power exponents,  $= 2/\ln(b/u) > 0$ , whereby  $f(x)$  depends on two individually distinct parameters  $u/\mu$  and  $b/\mu > u/\mu$  with  $\mu$  as arbitrary, but function-independent scale unit. For dissimilarities it implies that the reference invariance is only represented by distances in response spaces. If an observed rank order is conditional with respect to a distinct (imaginary) point  $y$  then it is represented by a conditional rank order of binary point values  $\mathcal{L}\{f(x) \oplus f(y)\}$  with respect to space point  $f(y)$ . We then say that reference invariance of binary space points is conditional, as it is for preference rank orders that are represented by ordered distances to an imaginary ideal point with maximum preference in the geometry of space  $f(x)$ . In chapter 5 we defined preferences of objects with single-peaked valence attributes by products of two stimulus space involutions respectively with respect to individual unit points  $x/b = 1$  (adaptation level) and  $x/z = 1$  (saturation of deprivation level), which define single-peaked transformations of power-raised stimulus fraction spaces  $(x/p)^\sigma$  with ideal points  $p = \sqrt{(b \cdot z)}$  and power exponents  $\sigma = 1/\ln(b/p)!$ . Thereby, we restrict  $f(x)$  to the functions of our psychophysical response and valence theory as:

**Definition 3: judgment- and preference-relevant functions  $f(x)$**

Function  $f(x)$  for subjective stimulus magnitudes or comparable sensations is restricted to asymmetric - with respect to  $x/b = 1$  - and strictly monotone functions

$$f(x) :::: (x/b)^\tau \quad \text{and} \quad f(x) = \tau \cdot \ln(x/b) \quad \left| \tau = 2/\ln(b/u) > 0, \right.$$

or function  $f(x)$  for judgmental responses or monotone valences is restricted to bipolar, symmetric - with respect to  $\ln(x/b) :::: 0$  -, strictly monotone, and bounded

$$\text{function} \quad f(x) :::: \tanh[\frac{1}{2}\tau \cdot \ln(x/b)] = -[1 - (x/b)^\tau] / [1 + (x/b)^\tau]$$

or alternatively

$$f(x) = \arctan[\cdot \ln(x/b)],$$

or function product  $f(x) \cdot f(x')$  for single-peaked valences is restricted to a symmetric - with respect to  $\ln[xJ(b \cdot z)] = \ln(x/p)$  - product of bipolar, oppositely signed, strictly monotone, symmetric, and bounded functions  $f(x)$  and  $f(x')$ .

$$\begin{array}{l} \text{rewritten as} \\ \text{or alternatively} \end{array} \quad \left. \begin{array}{l} f(x) \cdot f(x') = \tanh[\frac{1}{2}\sigma \cdot \ln(x/b)] \cdot \tanh[-V2(J \cdot \ln(x/z))J] \\ f(x) \cdot f(x') = \tanh[-\frac{1}{2}\sigma \ln\{\cosh[cr \cdot \ln(x/p)] / \cosh(I)\}] \\ f(x) \cdot f(x') = \arctan[cr \cdot \ln(x/b)] \cdot \arctan[-cr \cdot \ln(x/z)], \end{array} \right| \sigma = 1/\ln(b/p)$$

Here we define  $f(x)$  as a parameter-dependent strictly monotone function of stimulus measurements  $x/\mu$  as ratio-scale values. The parameters  $u/\mu$  (just-noticeable level),  $b/\mu$  (adaptation level), and  $z/\mu$  (saturation or deprivation level) are distinct points in a ratio-scale space of vectors  $x/\mu$  with arbitrary measurement unit  $\mu$  (where  $\sigma = \tau$  if the deprivation level coincides with the just noticeable level). Here  $f(x)$  transforms  $x/b$  to

negative values if  $x/b < 1$ , except for  $!(x) = (x/b)!$ , while function product  $f(x) \cdot f(x')$  transforms  $x/\sqrt{(b \cdot z)} = x/p$  to negative values if  $x/p > z/p > b/p$  or  $x/p < b/p < z/p$  and if  $x/p < z/p < b/p$  or  $x/p > b/p > z/p$ . Similarly we restrict and redefine structure invariance in geometric terms:

**Definition 4: structure invariance**

structure invariance is satisfied if the geometry of the measurement representation of evaluated object pairs specify the reference invariance  $\mathbb{E}[a \oplus b]$  for binary point values  $a = f(x)$  and  $b = f(y)$  defined by function  $f$  as parameter-dependent, strictly monotone, metric function of ratio-scale values  $x$  and  $y$ .

If a rotation- and translation-invariant space  $a = f(x)$  is dimensionally transformed to a space  $g(a) = \alpha a + \beta$  then space  $g(a)$  is an *automorphism* of the space  $a = f(x)$ , where then  $\beta_k$  define dimensional translations and  $1/\alpha_k$  dimensional rotation weights. Automorphic spaces express the same structure invariance for distances. If  $f(x)$  defines a strictly monotone, metric transformation of space  $x$  then the space  $f(x)$  is an *isomorphism* of space  $x$ . All isomorphic spaces of space  $x$  express the same reference invariance for space point values. It defines that structure invariance for space point values is by definition satisfied in any space that is isomorphic to space  $a = f(x)$  and, thus, also in the ratio-scale space  $x$ , because space isomorphism implies, if  $x \geq y$  then  $f(x) \geq f(y)$ . If reference invariance for binary point values is conditional to a distinct space point then the structure invariance for binary point values is also conditional. Conditionally structure-invariant distances with respect to  $b = f(y)$  concern rank orders  $d(a,b) \geq d(c,b)$  for all points  $a$  and  $c$  with respect to fixed point  $b$ , whereby other conditionally isomorphic spaces  $[*(a)]$  may also yield  $d[f^*(a), f^*(b)] \geq d[f^*(c), f^*(b)]$ . For example if  $b = f^*(b) = 0$  holds and function  $[*$  satisfies symmetry  $f^*(-a) = -f^*(a)$  and strict monotonicity, then  $d(a,0) \geq d(c,0)$  implies  $|a| > |c|$  and  $|f^*(a)| > |f^*(c)|$ , whereby  $d[f^*(a),0] \geq d[f^*(c),0]$  also holds. However, if structure invariance unconditionally holds for distances  $\mathbb{E}[a \oplus b] = d(a,b)$  in space  $a = f(x)$  then that invariance needs not to hold for distances in isomorphic space  $f^{-1}(a)$  or  $f^*(a)$ , since  $d(a,b) \geq d(c,d)$  implies not  $d[f^*(a), f^*(b)] \geq d[f^*(c), f^*(d)]$  for all point pairs  $(a,b)$  and  $(c,d)$ . This conjecture is easily proved by the contra example of  $f^* = f^{-1} = \exp$  for distances between positive points  $a,b$  and negative points  $c,d$ , where  $d(a,b) < d(c,d)$  in space  $a = \ln(x)$  can correspond in space  $x = \exp(a)$  to

$$d\{x = f^{-1}(a) > 1; y = f^{-1}(b) > 1\} > d\{u = f^{-1}(c) < 1; v = f^{-1}(d) < 1\}.$$

Only one of the isomorphic spaces can be structure-invariant for unconditional distances as binary point values, but all isomorphic spaces express by definition the reference invariance for space point values. Thus, if structure invariance for conditional distances holds in a space then it may hold in conditionally isomorphic spaces, while only one isomorphic (not-automorphic) space can be structure-invariant for unconditional distances. For example, a hemispherical earth and its arctangent-projected map express the same rank order of conditional distances between locations and its projection centre, but the rank order of unconditional distances on the hemispherical globe and its flat projection map can be different.

Distances as binary space point values in some geometry are our main concern, because relevant for dissimilarity and preference representations. It is well known that geometries with a zero or constant curvature are the only spaces that unconditionally exhibit the required property of triangular distance inequalities (Busemann, 1950a, 1955), whereby their distance rank orders can represent transitive rank orders of dissimilarity or preference observations (but for zero curvature spaces with a Minkowski  $r$ -metric only if  $r \geq 1$ ). In conditionally structure-invariant spaces the distance inequalities concern transitively ordered distances to a distinct space point, which transitivity not only is satisfied in spaces with a zero or constant curvature, but also and only also in spaces with absolute space curvatures that decrease with increasing distances to that distinct space point, as shown in subsection 6.1.6.. Its geometry is then a continuously connected, relative order topology (Kelly, 1955) as a geometry with absolute curvatures that increase not with the relative distance. In chapter 5 of this monograph it is shown that open Finsler geometries with absolute curvatures that decrease with increased distances to an ideal space point apply for preferences of objects with single-peaked valences, if the sensation space is flat (Euclidean or Minkowskian with  $r$ -metrics  $r \geq 1$ ). Thereby, the conditional structure invariance holds for distances to ideal points in open Finsler spaces of single-peaked valences and in their Euclidean spaces of valence-comparable sensations. The corollary below summarises the permissible geometries that can exhibit structure invariance for distances as representations of the structure invariance for evaluated dissimilarities or for conditional distances as representations of the conditional structure invariance for ordered object preferences, while the implications of the corollary for psychological measurement are further discussed in subsections 6.1.6 and 6.2.1.:

Corollary 1. permissible structure-invariant distance geometries

If a structure invariance concerns unconditional distances then the permissible distance geometries have a zero or constant curvature, but if a structure invariance concerns conditional distances to a distinct point then the permissible geometries can also have absolute curvatures that decrease with the conditional distances.

Space distances are invariant under central space dilations, space translations, and rotations if the measurement space has a zero or constant curvature, but for rotations only if a zero curvature space is not Minkowskian, thus Euclidean. Therefore, if structure invariance is satisfied for distances in space  $x$  then all automorphic spaces of space  $x$  are structure-invariant for distances. Structure invariance for conditional distances may hold in isomorphic spaces if the space transformation has a common distance point as transformation centre and the isomorphic spaces have constant curvatures or absolute curvatures that decrease with the increased distances to that space centre. The latter curvatures define the only Finsler spaces that can satisfy structure invariance for conditional distances.

If a quantitative relationship concerns dimensional interval-scale measurements, then its permissible measurement transformations not only allow central dilations and translations, but also dimensional dilations, because interval scales have arbitrary measurement units. It means that *all quantitative relationship between dimensional values of interval-scale spaces are not meaningful*, because the permissible



transformation by arbitrary weighing and translations of its dimensions change the outcome of the quantitative relationship and/or the predicted rank order of their binary space point values. Even reference invariance for space points is not satisfied under dimensional dilations, whereby interval-scale geometries violate reference and measurement invariance. Notice that if a quantitative relationship concerns ratio scale measurements then also their arbitrary dimensional dilations are not permissible for meaningfulness of quantitative relationships (Suppes, 2002, p. 120-123), because then not measurement-invariant. Dimensional dilations in physics are allowed, but only as distinctly defined changes in measurement units of their ratio scales, whereby also a corresponding measurement standard change of the ratio scale for the relationship outcome is defined. This is why the measurement units for physical law outcomes are implicitly or explicitly specified by conventionally agreed measurement units.

**Definition 5: meaningfulness of quantitative relationships**

Quantitative relationships between dimensional measurements are only meaningful if the measurement space is measurement- and reference-invariant.

Reference- and measurement-invariant relationships are both needed for meaningfulness of quantitative relationships between dimensional values, because a meaningful relationship must be measurement-invariant under its permissible transformations and the permissible transformations of the measurement space must satisfy reference invariance, otherwise quantitative relationship outcomes and the reference invariance of the qualitatively observed outcomes may not describe the same rank order (and/or same equivalences). The requirements of reference and measurement invariance for quantitative relationships between dimensional measurements exclude meaningfulness of relationships between ordinal scales and between interval scales. Also meaningfulness of relationships between dimensional measurements of ratio-scale spaces with an absolute zero origin require the specification of their dimensional measurement units, because otherwise their quantitative relationships become arbitrarily changed by permissible measurement unit changes and then also can violate the needed reference invariance for space point values. However, if the quantitative relationships concern relationships between dimensional ratios of variable differences a distinct distance to a distinct point in interval-scale spaces, as holds for comparable sensations, then the relationship is dimensionally invariant under linear transformations of the underlying interval-scale dimensions, whereby it concerns  $(0,2,0)$ -unique scales that guarantee meaningfulness of such quantitative relationships. If reference invariance holds and no measurement transformation is permissible (no arbitrary scale parameters) then meaningfulness of quantitative relationship always holds evidently.

Only automorphic space transformations (central dilations and translations as well as rotations in rotation-invariant spaces) are reference-invariant for single and binary space point values. Isomorphic space transformations are only reference-invariant for single space point values and for conditional binary space point values if the common space point is the transformation centre. Some isomorphic space transformations transform an infinite space with zero or constant curvature to an open space with the same or mutually reversed curvatures (zero=constant or constant $\rightarrow$ zero) and are by definition space transformation with a corresponding reference invariance

for space point values. Only one isomorphic space can be the structure-invariant space for unconditional distances. For example, if  $\tanh(a)$  and  $\tanh(b)$  transform Euclidean space points then Euclidean distances  $|a - b|$  correspond to open-hyperbolic space distances  $\cosh[\tanh(a) - \tanh(b)]$ . But if the open-hyperbolic space is the geometry for the structure-invariant distances  $\cosh[\tanh(a) - \tanh(b)]$  then rank orders of Euclidean distances  $|a - b|$  express not the reference invariance for binary space points  $(a, b)$ , although rank orders of Euclidean distances are transitive. However, if a space for conditionally structure-invariant distances - thus a space with a zero or constant curvature or with absolute curvatures that reduce with distance to the distinct point - is isomorphic transformed with respect to the distinct point to a constant or zero curvature space then it also is a space with conditionally structure-invariant distances. In chapter 5 this is demonstrated for open single-peaked valence spaces and their isomorphic, Euclidean or hyperbolic spaces of comparable sensations, where the rank order of distances to the ideal point in single-peaked valence spaces and in their comparable sensation spaces expresses the same preference rank order by their monotonic differing distances to the ideal point.

Quantitative relationships between dimensionally invariant measurements are meaningful, which is proven to be satisfied (FoM: ch. 10) for ratio-scales with specified scale units and dimensionless power exponents (FoM: ch. 20). The requirements for dimensional invariance and meaningfulness of quantitative relationships are the same. Thus, we also define

**Definition 6: dimensional invariance**

dimensional invariance is satisfied if the measurement space is reference- and measurement-invariant.

We remark that outcomes of dimensionally invariant, quantitative relationships in physics are relationships between (dimensionless power-raised) fraction-scale measurements with respect to dimensional unit points that are defined by conventionally agreed measurement standards. As shown in the sequel a similar dimensional invariance also holds for fraction scales with scale units and rotational power exponents of dimensions, where both are defined by distinct space points in rotation-invariant stimulus spaces. A dimensionally invariant measurement space satisfies reference invariance for space point values, but its dimensional invariance may not uniquely specify the space geometry, in contrast to dimensionally invariant measurement spaces that satisfy unconditional structure invariance for binary space point values. The algebraic formulation of a relationship between dimensional point values might be different for each permissible, dimensionally invariant geometry, but different, dimensionally invariant geometries may also have an algebraically identical formulation for a quantitative relationship between dimensional point values. In chapter 4 we discussed dimensional responses  $r = \tanh[\ln(x/b)/\ln(b/u)]$  as hyperbolic tangent functions of comparable sensation dimensions in Euclidean or hyperbolic spaces, while the corresponding response spaces are respectively open-hyperbolic or open-Euclidean. Thus, if a quantitative response relationship is verified for dimensional point values, then the geometry of the space points needs not to be uniquely specified. Only if an algebraic formulation of a dimensionally invariant relationship is different for each

reference-invariant geometry we can by empirical evidence for one formulation (thus under falsification of all other formulations for permissible other geometries) determine uniquely the actual geometry. Therefore, we define as properties of dimensionally invariant spaces:

**Definition 7: metric invariance or uniqueness**

metric invariance of a dimensionally invariant, quantitative relationship is satisfied if its algebraic formulation is identical for different, permissible geometries and if its algebraic formulation is different for each permissible geometry then metric uniqueness holds.

**Definition 8: geometric uniqueness**

geometric uniqueness is satisfied if a dimensionally invariant, quantitative relationship is metrically unique and empirically verified, while all other algebraic formulations for other permissible geometries are falsified by empirical evidence.

It is conceivable that the same reference invariance holds for different algebraic formulations of a quantitative relationship between dimensional values, but it then can only mean that different geometries apply to the dimensional space points in each formulation. In chapter 2 we argued that Stevens' and Fechner's psychophysics describe the same reference invariance for dimensional points respectively by power-raised stimulus fraction scales as subjective stimulus magnitudes and by weighted, logarithmic stimulus fractions as intensity-comparable sensation scales. In chapter 3 we further proved that if Stevens' subjective stimulus magnitudes are power-raised scales of Euclidean stimuli then intensity-comparable sensations are hyperbolic, while if intensity-comparable sensations are Euclidean then Stevens' subjective stimulus magnitudes are power-raised scales of non-Euclidean stimuli. Thus, here we have isomorphic spaces and metric uniqueness, but no geometric uniqueness. It clarifies why Fechnerian and Stevens' psychophysics are not contradictorily, but represent the same by different metric expressions of scale values in different, isomorphic geometries.

Geometric uniqueness is a property that may seem to be proven in physics, where multiplicative laws are shown to be metrically unique and where the unique-assumed geometry is shown to be the hyperbolic *space-time* geometry with the optical space as an expanding, three-dimensional, elliptic subspace. The metric uniqueness in physics is obtained by defining conventionally agreed standards for the units of their ratio scales, whereby physical dimensions become fraction scales, while their power exponents are dimensionless integers, as for area or volume scales, or ratios of integers, as for density expressed by mass/volume. The empirical validity for multiplicativity of dimensionally invariant equations in physics and the exchange property of mass ( $m$ ) and energy ( $E$ ) by the constant velocity of light ( $c$ ) in  $E = m \cdot c^2$  seems to uniquely determine the hyperbolic space-time geometry of relativistic physics. Its optical subspace is an elliptic space with a very large (expanding) radius, whereby Euclidean geometry of Newtonian physics still holds for directly visible phenomena on earth and classical mechanics. However, the geometry of physics is only unique for multiplicative law equations. Logarithmic-transformed laws for logarithmic-transformed measurements in physics would equivalently express the physical laws by additive log-interval equations (FoM, ch 10, sub. 10.12). Such log-interval laws of physics would

even simplify their multiplicative law outcomes by the cancellations of the translations that correspond to their dimensional ratio-scale units. For example, in the law of kinetic energy  $K = \frac{1}{2}mv^2$  we must take care of dimensional units and is then explicitly written as  $K/\mu_k = \frac{1}{2}(m/\mu_m) \cdot (v/\mu_v)^2$  where  $\mu_k = \mu_m \cdot (\mu_v)^2$  must be specified, but transformed to  $\log(K) - \log(\mu_k) = -10(2) + \log(m) - \log(\mu_m) + 2\log(v) - 2\log(\mu_v)$  it follows from equality relation  $\log(\mu_k) = \log(\mu_m) + 2\log(\mu_v)$  that  $\log(K) = \log(m) + 2\log(v) - 10(2)$  depends not on dimensional scale units and similarly so for other multiplicative laws. Their log-interval scales have a common infinity that corresponds to the zero origin of the original ratio scales, while their zero points on the log-interval scales correspond to one unit of their ratio scales. Due to the Euclidean geometry of Newtonian physics, it has historically been convenient to express physical laws by multiplicative equations, but physical laws as additive equations of log-interval measurements would more conveniently specify a Euclidean space-time geometry for relativistic physics, while its Euclidean log-interval scales for stimulus modalities would resemble Fechnerian psychophysics.

Measurement-theoretical results are of importance, but have not provided dimensionally invariant measurement in nonphysical sciences, such as psychology. Therefore, meaningfulness of quantitative relationships in the nonphysical sciences remained a troublesome matter, also in psychology. Up today fundamental measurement theory has mainly shown that interval-scale measurements can be obtained from additive and generalised-associative conjoint component, or difference, or distance structures. Conjoint component structures of components that are already quantified by extensive measurement (FoM: ch. 3; ch. 10; ch. 22) may yield a (power-raised) ratio scale for the conjoint component outcomes and then may yield a so-called derived-extensive measurement for outcomes that are not directly measurable by the classical type of extensive measurement. The classical type of extensive measurement asks that uniform concatenations of observable (thus physical) units are validly represented by addition of numerical scale units, which representation defines a ratio scale for their measurements. Its axiomatisation requires the axioms of: associativity  $(x \oplus y) \oplus z = x \oplus (y \oplus z)$ , Archimedeaness  $n \cdot x = (n-1)x \oplus x$ , positiveness  $x \oplus y \geq x$ , and solvability as if  $n \cdot y \leq (n+1)x$  and  $n \cdot x \leq (n+1)y$  then  $x = y$  (FoM, sections 3.2. to 3.4.). This classical measurement type in physics has observable unit concatenations that correspond to numerical unit additions of the numerical scale and, therefore, is here earlier defined as ostensive-extensive measurement. It yields dimensional ratio scales, since the uniform units are represented by an arbitrary numerical unit value. Many laws in physics concern outcomes that can't be ostensively concatenated, but fit the rank order structure of conjoint outcomes by multiplication of (power-raised) ratio-scales for its law components, which yields a derived-extensive measurement of their physical outcomes. Derived-extensive measurement for conjoint outcomes of ostensive-extensive component measurements yields a positive ratio scale that may have a dimensionless power exponent in the physical laws of dimensional-invariant equations of relationships between physical components (FoM: ch. 10). Notice that ostensive-extensive measurements imply reference invariance for scale-point values, while reference invariance for derived-extensive measurement concerns binary space-point values in some geometry.

### 6.1.3. Attempts to obtain meaningful psychological measurements

In psychology we have no observable units that can be ostensively concatenated, whereby ostensive-extensive measurement is not possible in psychology. Thereby, also derived-extensive measurement from conjoint, difference, or distance structures is impossible in psychology, where we have a reference invariance for binary space point values as evaluated object pairs, such as dissimilarity rank orders that are represented by ordered space distances. However, in psychology the conjoint and difference or distance structures only yield interval-scale measurements for the components of conjoint structures or for the dimensions of multidimensional space representations of differences or distances (FoM, ch. 4, ch. 6, ch. 14 section 14.4, and ch. 20). Attempts to obtain ratio-scale measurements for psychological attributes are undertaken by a kind of derived-extensive measurements from empirically sustained axioms that relate psychological outcomes of conjoint structures to objective ratio scales of the underlying components. The study of Pollatsek and Tversky (1970) is one early example of trying to measure perceived gamble risk in a derived-extensive way by specifying a non-additive associativity axiom for risk outcomes as function of gamble probabilities and monetary values. However, as Roskam (1989) pointed out, the preference rank order of perceived gamble risks in their measurement model turns out to be dependent on the currency unit of the monetary values, which defines their perceived risk measurement to be not reference-invariant and thus also not meaningful. Narens (1966, 2002) axiomatised Stevens' subjective stimulus magnitudes by a variant of axioms for ostensive-extensive measurement, where he replaced the additivity axiom (in Newtonian physics corresponding to observable concatenation of multiple units) by multiplicative associativity  $f(a \otimes b) = f(a) \cdot f(b)$  of subjective stimulus magnitudes. What seems questionable is the validity of the multiplicative associativity axiom. For a concatenation unit  $u$  and integers  $n, m, b$ , and  $z$  we have for extensive stimulus measurements the values  $(n \cdot m) \cdot u$ ,  $n \cdot u$ ,  $m \cdot u$ , and  $b \cdot u$  as four stimulus intensities that expressed as fractions of a reference stimulus  $Z/u$  define four objective stimulus fractions as

$$q_{nm} = n \cdot m / z, \quad q_n = n / z, \quad q_m = m / z, \quad \text{and} \quad q_b = b / z$$

For corresponding subjective stimulus fractions by psychophysical function  $\psi(q) = q^\gamma$  we define

$$q_{nm} = \psi(q_{nm}), \quad q_n = \psi(q_n), \quad q_m = \psi(q_m), \quad \text{and} \quad q_b = \psi(q_b)$$

Narens axiom for multiplicative scales (Narens, 2002, axiom 5.8.9) implies invariance

$$q_{nm} / q_b = (q_n / q_b) \cdot (q_m / q_b)$$

Although Narens suggests that Stevens assumes multiplicative invariance, we could not find such an explicit statement in Stevens' publications. Stevens' power law  $\psi(q) = q^\gamma$  shows that multiplicativity conditionally holds for  $q_b = 1$  only, because we obtain,

$$q_{nm} / q_b = [(n \cdot m / z) / (b / z)]^\gamma = [(n / z) / (b / z)]^\gamma \cdot [(m / z) / (b / z)]^\gamma = (q_n / q_b)^\gamma \cdot (q_m / q_b)^\gamma$$

Multiplicative invariance is empirically falsified by Ellenneier and Faulhammer (2000), where

$$|\ln(q_{nm} / q_b)|^\gamma = |\ln(q_n / q_b)|^\gamma + |\ln(q_m / q_b)|^\gamma$$

seem to fit for subjective loudness fractions (Luce, 2002, p. 528). Ourevidence (section

2.1.2 and ch. 3) on Steven's power law as matching of cognitive magnitude sensations with comparable sensations of a modality implies for power exponent  $t$  and adaptation level  $q_b = blz$  on the objective fraction scale.

$$\tau \cdot \ln(q_o / Iqb) + t \cdot \ln(q_m / q_b) = \tau \cdot \ln(q_{om} / Iqb) - t \cdot \ln(q_b)$$

Thus, if  $q_b > 1$  then  $q_{nm} = (q_{nm} / Iq_b)^t < q_o \cdot q_m = (q_o / Iq_b)^\tau \cdot (q_m / Iq_b)^t$  and if  $q_b < 1$  then  $q_{nm} > q_o \cdot q_m$  is predicted to hold for subjective fractions  $q$  and objective fractions  $q$ . Only if the stimulus adaptation level  $b \cdot u$  of a modality coincides with the reference stimulus  $z'u$  then  $q_b = 1$ , whereby then  $q_{nm} = q_o \cdot q_m$  holds. Although Narens (2002, p. 265) proves that the multiplicative scale for behavioural fraction judgements only represents the cognitive magnitude scale if there is a unique unit element on scale  $q$  (Theorem 5.8.3), his axiomatisation of subjective stimulus magnitudes seems at least incomplete by not specifying an additional axiom for  $q_b = 1$  as stimulus reference level for the fraction evaluation. Such a cognitive evaluation axiom is sustained by the evidence from our further analysis (section 2.1.2) of Teghtsoonian's meta-analysis of many studies by Stevens and others. However, power-raised stimulus fraction scales only may approximately represent fraction judgements, because fraction judgements are numerical fraction responses to comparable sensations and, therefore, differ from power-raised stimulus fractions. The logarithmic values of power-raised stimulus fractions only approximate response values within a limited, but rather wide midrange of stimulus intensities, as demonstrated in subsection 6.2.3. Thereby, an axiomatisation of subjective stimulus magnitudes with a multiplicative associativity axiom for power-raised stimulus fractions can also be invalidated for extreme stimuli. Also utility is often axiomatised by variants of extensive measurement and even as unbounded and continuous ratio scales by Candeal et al. (1996) based on Holder's (1901) axioms for measurement in physics. Such attempts on axiomatisation of extensive measurement for psychological scales lack an empirically sustained reference invariance for their associativity axiom. Moreover, if reference invariance for scale point values would be satisfied then strictly monotone functions of the measurement scale satisfy also that reference invariance, but not the same associativity axiom. Any extensive measurement that is derived by an axiom system for psychological structures without reference invariance for its associativity axiom remains a mathematical exercise that may lack validity as well as metric and geometric uniqueness.

There exists one measurement-theoretical attempt to derive psychological measurement that comes close to a valid kind of extensive measurement. It concerns the axiomatisation by Luce (1995) of utility measurement for the cumulative prospect theory (Tversky and Kahneman, 1992) as the further developed model of rank- and sign-dependent linear utility (Luce, 1991; Luce and Fishburn, 1991). Its axiomatisation concerns the measurement representation of certainty equivalents between joint receipts of valued goods by Luce (1995), where a negative exponential function of the ratio scale for the values of valued goods fits the measurement representation of utility gains or losses. This sign- and rank-dependent utility describes utility of valued goods as relative to a status quo (denoted  $b\theta$ ) with utility  $U(\theta) = 0$ , while certainty equivalents  $(x,y) \sim (u,v)$  between valued good pairs  $(x,y)$  and  $(u,v)$  are split up with respect to joint receipt pairs for positive utility gains or negative utility losses. A segregation between

gains and losses is assumed to be needed, because utility losses  $U(x) < 0$  are empirically shown to be larger than utility gains  $V(x) > 0$  for objectively identical loss or gain values, while both are also shown to decrease or respectively to increase in a diminishing way with respect to equally increased, objective loss or gain values, which are two empirical aspects that are modelled by the cumulative prospect theory. Measurement equalities for certainty equivalences  $(x,y) \sim (u,v)$  allow a more unique measurement than order structures  $(x,y) > (u,v)$ , due to the utility equivalences that are represented by metric equalities with respect to the zero utility for status quo. Its axiomatisation by Luce (1995, 2000) yields an inferred-extensive measurement, because most underlying axioms are separately verified, where the axiomatisation contains no associativity axiom, but implies a generalised additivity for a bounded utility measurement (either **status-quo** axiom  $e \oplus x = x$  or a generalised associativity axiom is needed, but the weaker status-quo axiom is verified by  $V(e \oplus x) = Vex$ ). For utility gains with respect to  $V(e) = 0$  as status-quo it yields the functional equation

or

$$V(x \oplus y) \approx Vex + V(y) - V(x) \cdot V(y)/c > 0,$$

$$1 - V(x \oplus y)/c = [1 - V(x)/c][1 - V(y)/c] > 0,$$

satisfying

$$V(x) := c[1 - \exp(-V_g(x))] > 0 \quad \text{for } c > 0,$$

where  $V_g(x) \approx -\ln[1 - V(x)/c] > 0$  are values of goods that are assumed to satisfy

$$V_g(x + y) = V_g(x) + V_g(y).$$

For utility losses  $V(x) < 0$  Luce derives similarly

$$Vex) = k[-1 + \exp(V_l(x))] < 0 \quad \text{for } k > c$$

Using pie diagrams parts for the representation of  $x$  and  $y$  as objective values of valued goods, such as used in lottery experiments by Cho and Luce (1995) with certainty equivalents of joint lottery receipts for the verification of measurement axioms, Luce (1996,2000) takes for gains  $V_g(x) = x/\mu_g > 0$  and for losses  $V_l(x) = x/\mu_l < 0$ , whereby

$$Vex) = \begin{cases} c[1 - \exp(-x/\mu_g)] & x \geq 0 \text{ for gains} \\ k[-1 + \exp(x/\mu_l)] & x < 0 \text{ for losses} \end{cases}$$

Here  $V(x)$  defines separate measurements for utility gains and losses that are bounded respectively to maximum  $c$  and minimum  $-k < -c$ . We remark that  $Vex)$  depends on scale units  $\mu_g$  for positive  $x$ -values of gains and  $\mu_l$  for negative  $x$ -values of losses. But if  $x/\mu_g$  and  $-x/\mu_l$  are taken as a differently scaled, hyperbolic dimension with different pseudo-radii  $c$  and  $k$  then the utility gain and loss parts of  $Vex)$  are parts of open rectangular co-ordinates, whereby it follows that  $\mu_g = c/\mu$  and  $\mu_l = k/\mu$ . Scaling the utility gains and losses to  $U(x)/c > 0$  and  $V(x)/k < 0$  we obtain  $1 - U(x)/c := \exp(-x/\mu)$  and  $-1 - V(x)/k := -\exp(-x/\mu)$  as rectangular Euclidean co-ordinates  $\pm \exp(-x/\mu)$  of an open-hyperbolic curve. If we take dimension  $(x - b)/\mu$  as hyperbolic values  $x/\mu$  of valued goods that are translated to  $b/\mu$  as status-quo value, whereby  $V_g(x) = (x - b)/\mu$  for  $x > b$  and  $V_l(x) = (x - b)/\mu$  for  $x < b$  equivalently defines for  $k > c$

$$\pm [1 - \exp(-I(x-b)/\mu)] = \begin{cases} U(x)/c > 0 & x > b \text{ for gains} \\ 0 & x = b \text{ for status quo} \\ \{V(x)/k < 0 & x < b \text{ for losses} \end{cases}$$

If we assume hyperbolic gain or loss values that projectively combine independent values  $V(x)$  and  $V(y)$  to sub-additive good values  $V(x \oplus y) < V(x) + V(y)$ , then Luce's functional equation also derives from the hyperbolic Pythagorean expression

$$\cosh[V(x \oplus y)] = \cosh[V(x)] \cdot \cosh[V(y)]$$

where  $\cosh^2(z) = 1/[1 - \tanh^2(z)]$  defines

$$\tanh^2[V(x \oplus y)] = \tanh^2[V(x)] + \tanh^2[V(y)] - \tanh^2[V(x)] \cdot \tanh^2[V(y)]$$

By taking  $V(x \oplus y) = \tanh[V(x \oplus y)]/q$  and  $V(x) = \tanh[V(x)]/q$  for  $q > 1$  Luce's functional equations follow from signed solutions of (7) for  $q > 1$  and  $q = k < -1$  as

$$\tanh[V(x \oplus y)] = \tanh[V(x)] + \tanh[V(y)] - \tanh[V(x)] \cdot \tanh[V(y)]/k$$

for gains  $x > 0, y > 0$  and for losses  $x < 0, y < 0$  as

$$\tanh[V(x \oplus y)] = \tanh[V(x)] + \tanh[V(y)] - \tanh[V(x)] \cdot \tanh[V(y)]/k$$

However, if we assume  $V(x \oplus y) = \tanh(x + y)/q$ ,  $U(x) = \tanh(x)/q$ , and additive good values, as Luce specified by  $V(x + y) = V(x) + V(y) = x/\mu + y/\mu$  for Euclidean values, then

$$\tanh(x + y) = [\tanh(x) + \tanh(y)]/[1 - \tanh(x) \cdot \tanh(y)/q^2],$$

where

$$U(x \cdot y) = [U(x) + U(y)]/[1 - U(x) \cdot U(y)/q^2]$$

describes a hyperbolic additivity for utility that also holds for relativistic velocity, as a comparable example of non-additive measurement mentioned by Luce (1996, p.300). Thus, if  $U(x) = \tanh(x)/q$  then Luce's functional equation may hold for hyperbolic values of valued goods and the last functional equation for Euclidean values of valued goods. It illustrates that axiomatic measurement always implies a geometric assumption, as will be discussed further in the sequel. Since axioms for measurement representations of qualitative equivalences  $(x, y) \sim (u, v)$  are rather well verified (Luce, 2000), reference invariance seems as well satisfied for  $V(x)$  defined by Luce as for  $V(x)$  redefined above. However, if  $x \geq y \geq z$  then weak order  $V(x \oplus z) \geq V(y \oplus z)$  is sometimes violated (Bimbaum, 1992), while intransitive preference rank orders are sometimes consistently observed (Tversky, 1969). As discussed by Bimbaum (1992) and also is shown in chapter 7, this violation of monotonicity may be caused by the contextual effects of stimulus presentation in experimental studies, where stimulus-dependent shifts of adaptation level change subjective preference values. Such contextual effects with violations of monotonicity might be the reason why utility models have not revealed earlier a more clear utility measurement structure.

Only if a distinct representation for ratio-scale  $x/\mu$  of valued goods is used, such as representations by parts of a pie with a constant radius, then scale unit  $\mu$  is distinctly defined, whereby then scale  $1 > U(x)/c > 0$  for gains and scale  $-1 < V(x)/k < 0$  for losses would separately satisfy measurement invariance. However, utility measurement should not depend on the display of the value representation for valued goods, whether as pie parts or as rectangular parts of squares, but the ratio scale  $x/\mu$  differs for pie parts and rectangular parts of squares, whereby  $U(x)/c$  or  $V(x)/k$  is not measurement-invariant. Also if  $x/\mu$  is the monetary value itself then  $V(x)/c$  or  $V(x)/k$  is not measurement-invariant, because the metric utility then depends on the currency unit.



For example, if  $x/\mu$  is expressed in units of 100 US\$ and  $V(x)/c$  ranges from 0.1 to 0.9 then for  $x/\mu$  expressed in units of US\$ all values  $V(x)/c$  will be close to unity. Although the order of  $V(x)/c$  values is preserved for any unit  $\mu$  of  $x/\mu$ , measurement invariance is not satisfied for such utility measurements. Thus, quantitative relationships between Luce's utility measurements only are meaningful for gains or losses. If the values of goods could be represented by magnitudes that are independent of scale unit  $\mu$ . Moreover, the constant-assumed status-quo level can be individually different, whereby the meaningfulness of such quantitative relationships then would only hold for individual utility measurements and not for utility relationships between individuals, unless ratios  $clk$  of individual limit values and values  $e$  of individual status-quo levels can be identified as distinctly solvable parameters. Due to the unidentified ratio  $clk$  also no inferred-extensive measurement solution is yet developed for joint receipts of gain and loss mixtures. Therefore, Luce's inferred-extensive measurement for utility remains troublesome. Its utility scale is (I, I,I)-unique, because we have one arbitrary unit  $\mu$  of values  $x/\mu$ , while the individual status quo level  $b/\mu = e$  is a dimensional parameter and limit  $c$  or  $-k$  for the utility measurement is a dimensionless parameter. Moreover, due to unidentified ratio  $clk < I$  there is no intra-individual utility measurement for mixtures of loss and gain values and no inter-individual comparability of utility.

Notice that Luce's expression parts for utility gains and losses are similar to our expressions (17a) and (17b) in section 2.1.3. Our response expressions describe expected reward strength (pictured in figure 12) and expected aversion strength (pictured in figure 13) as functions of weighted and translated Fechner sensations, where they are specified by

$$v_{ik} ::= 1 - \exp[-(Y_{ik} - Y_k) / w_k] \quad (\text{figure 12: expected reward for } Y_{ik} > Y_k)$$

$$v_{ik} = -1 + \exp[(Y_{ik} - Y_k) / w_k] \quad (\text{figure 13: expected aversion for } Y_{ik} < Y_k)$$

We identified  $Y_k ::= a_k$  as the adaptation level in Helson's (1964) adaptation-level theory and weight  $w_k = 1/2 a_k^{\tau_k} = 1/\tau_k$  for  $\tau_k$  as Steven's power exponent. Equality  $\tau_k = 2/a_k$  is derived by our former analysis of results from Teghtsoonian's (1971, 1974) meta-analysis of many studies on subjective magnitudes of different stimulus modalities. Adaptation level  $a_k = \ln(b_k/u_k)$  is defined by  $u_k/\mu$  as threshold that depends on stimulus-adaptation level  $b_k/\mu$  as midpoint of the stimulus range on dimension  $k$ . For subjective value magnitudes of valued goods we assume  $w_k ::= 1/\tau_k = I$ . As discussed earlier (section 2.1.2), power exponent  $\tau_k = I$  holds for cognitive magnitudes that were shown to be equal to averaged length and distance sensations with an average power of unity (p. 55 in here). For perceived pie parts as Luce's representations of valued goods it may be that  $\tau_k = 1/2$  as approximately holds for subjective magnitudes of frontal area, but if evaluated by circle-length parts of pies with a constant radius then likely  $\tau_k = I$ . Anyhow taking cognitive magnitudes as value sensations with  $\tau_k = I$  we would obtain

$$v_{ik} ::= \begin{cases} 1 - \exp[-(Y_{ik} - a_k) / w_k] & \text{if } x_{ik} > b_k \\ -1 + \exp[(Y_{ik} - a_k) / w_k] & \text{if } x_{ik} < b_k \end{cases}$$

In section 2.2.1. we assumed some generalisation of gain and loss expectancy respectively below and above adaptation level, whereby both equation parts combine

to monotone valence expression  $v_{ik} = \tanh[y_2(Y'_{ik} - a_k)]$  as ideal response axis  $k$  with  $\tau_k = 1$ . Our monotone valences  $v_{ik}$  as utility measurements are not based on verified axioms, but derive from an integration of substantive theories: 1) Shepard's exponential decay function for generalisation, 2) Helson's adaptation level theory, 3) Fechnerian psychophysics, 4) Bower's stimulus coding theory for comparability of sensations, 5) Stevens' psychophysics as matching with cognitive magnitude sensations, and lastly 6) learning theory for generalised association positive and negative expectancy responses to perceptual sensations above and below adaptation level. In our learning-based, bipolar, monotone valences we have no different limits  $c$  and  $k$ , because punishments and rewards below and above adaptation level evoke expected reward and punishment with symmetrically reflected effects from positive and negative reinforcements with respect to adaptation level. Therefore, without loss of generality we may set  $c = k = 1$ , while identical absolute differences of values  $x_k/b_k$  from status-quo level  $x_k/b_k = 1$  define larger utility losses than gains by Fechner's asymmetric log-function of stimulus fractions as sensations  $\ln(x_k/b_k) = y'_k - a_k$ . Since perceived magnitudes of objective gains or losses are cognitive magnitude sensations, we have not  $V_g(x) = x/\mu > 0$ , nor  $V_l(x) = x/\mu < 0$ , but should take the perceived good values as comparable value sensations  $V_g(x) = 1 \cdot \ln(x./b) > 0$  and  $V_l(x) = t \cdot \ln(x./b) < 0$  with  $x./\mu$  as objective values of goods and  $x./b = 1$  as status quo with  $\ln(x./b) = 0$  as adaptation level, where for  $\tau = 1$

$$V_g(x) = V(x) = V(x./b) = \ln(x./b) \quad \text{with} \quad V(x./b =: 1) = 0,$$

depends not on scale unit  $\mu$  of values  $x/\mu$ . Notice that absolute values of perceived gains  $x_i > b$  and  $y_i > b$  or losses  $x_i < b$  and  $y_i < b$  not only are already larger for losses than equal gains, but also are subjectively additive and with respect to objective values sub-additive, since

$$|V(x + y)| = |\ln[(x_i + y_i)/b]| < |\ln(x_i/b)| + |\ln(y_i/b)| = |V(x) + V(y)|,$$

Substituting these terms in Luce's equation parts and combining them to monotone valences as utility with respect to status quo  $x./b = e = 1$ , utility for losses and gains is written without loss of generality for  $c = k = 1$  by one simple function as

$$U(x) = -(1 - x./b)/(1 + x./b) = \tanh[Wz \ln(x./b)]$$

which also holds for monotone valences and subjective stimulus magnitudes as responses to stimuli with a Stevens' power exponent  $\tau = 1$ . Utility is then defined by hyperbolic involution of Euclidean dimension values  $x./b$  with respect to  $x./b = e = 1$  that is assumed to be a different constant in the utility expression for each individual. Utilities become also individually comparable by solving  $[1 + U(x)]/[1 - U(x)] = x./b$  for different individuals as fraction values of common ratio-scale  $x./\mu$ . Notice that if  $x./b$  is Euclidean then  $V(x) = \tanh[\frac{1}{2} \ln(x./b)]$  is an open-Euclidean dimension and defines not two open-hyperbolic scales with different curvatures for  $-k < V(x) < 0$  and  $c > V(x) \geq 0$  with ratio  $clk < 1$ , as holds for Luce's utility functions and also for our exponential functions of Euclidean values  $(x_i - b)/\mu$ . However, if  $x./b$  is hyperbolic then  $U(x) = \tanh[Wz \ln(x./b)]$  is an open-hyperbolic dimension with a hyperbolic additivity of utility for gains, losses, and mixtures of losses and gains with  $k = c = 1$ , in contrast to an open-Euclidean utility dimension for hyperbolic sensations of Euclidean good values. It illustrates that a geometric measurement foundation is indispensable. Due to

the rank-order correspondence between the independently derived expressions by Luce and in here (draft chapters 1 to 5 were written before 1996), the evidence for most axioms of Luce's inferred-extensive utility and the evidence for the substantive theories that underlie our monotone valences with  $\tau = 1$  for utility measurements may both be seen as evidence for the validity of our transformed-extensive utility measurement. Notice that our utility scale is (0, I, I)-unique by the singular limit of the hyperbolic tangent and the solvable, dimensional parameter of the adaptation level (provided that magnitude sensations equal value sensations of valued goods, whereby  $\tau = 1$ ).

Luce (2000, 2002) applied similar measurement axioms for perceptual certainty equivalents of stimulus pairs in an attempt to obtain inferred-extensive, psychophysical measurement, where Luce (2004) recently adjusted the axioms for loudness equivalences by relating the bivariate loudness function for the left and right ear to the unidimensional loudness function of each ear. Based on Stevens' fraction estimation for subjective stimulus magnitudes, Luce axiomatised proportional equivalence structures for subjectively equal stimulus pairs with one common reference stimulus and replaced the status quo by the zero (or just noticeable) stimulus level. Luce's axioms differ from Narens' (1966, 2002) axioms for Stevens' subjective stimulus magnitudes, because a (generalised) associativity derives from Luce's axioms and need not to be a presupposed axiom (either the segregation axiom or a generalised additivity axiom is needed, see Luce, 2002, p. 524). Luce's axioms without an associativity axiom are in principle verifiable axioms, while research for their verification is still in progress. We don't repeat the axiom details, nor discuss the axiom verifications for equivalence structures of loudness stimuli, where loudness of tones at the left and right ears may show a left-right bias. Luce's (2004) axioms for joint presentations of loudness stimuli of conditional pairs  $(x, o)$  at the left ear and  $(o, v)$  at the right ear leads in simplified function notations for  $\psi(x) \equiv \psi(x, o)$  and  $\psi^*(v) \equiv \psi(o, v)$  to

$$\psi(x \oplus v) \equiv \psi(x) + \psi^*(v) + \delta \cdot \psi(x) \cdot \psi^*(v)$$

Luce's (2004) derivation for measurement-invariant representations of the expression implies that  $\delta = 0$  for a symmetrical representation  $\psi(x) = \psi^*(x)$  of the equivalences  $(x, o) \sim (o, x)$  and if asymmetrically represented by biased expression  $\psi(x) \equiv \gamma \cdot \psi^*(x)$  then  $\delta > 0$ . By assuming common zero scale origins for objective and evaluated stimulus magnitudes and by requiring a measurement-invariant representation of  $\psi(x)$  for  $\delta = 0$  and  $\delta > 0$ , Luce and Steingrímsson (see: Luce 2004, p. 449) derived

$$\psi(x \oplus v) = (x/\mu)^\beta + (v/\mu)^{\beta'}$$

where  $\psi(x) = (x/\mu)^\beta$  and  $\psi^*(v) = (v/\mu)^{\beta'}$  with  $\beta = \beta'$  in the unbiased case. The last additive expression is not uniformly verified, where Luce (2004, p. 449) refers to contradicting results by Falmagne (1976) and Gigerenzer and Strube (1983) as well as confirmative findings by Levelt et al. (1971) and Falmagne et al. (1979). In section 6.2.3. it will be shown that according to our derivations it holds approximately only for stimuli within a restricted midrange around the adaptation level. Luce's inferred-extensive measurement specifies not the power exponent  $\beta$ , but Stevens's subjective stimulus magnitudes are power-raised stimulus ratio scales with measurable power exponents that are constant for varying stimuli within a rather wide midrange of

stimulus intensities for each modality. Since Stevens' power exponent  $\tau$  is constant for a wide midrange of stimulus intensities, we notice that  $x'$  as some just-noticeably increased stimulus  $x$  also specifies for subjective stimulus magnitudes

$$\psi(x') = (x'/\mu)^\tau = (1 + K)^\tau \cdot \psi(x)$$

for  $\kappa$  as the Weber fraction of that modality. Asymmetry  $\psi(x) = \gamma \cdot \psi^*(x)$  as different loudness at the left and right ear for the same loudness stimulus  $x$  could then be caused by different Weber fractions for left and right ear loudness. More important is that power exponent  $\beta$  then becomes specified by  $\beta = \tau = 0.296/\ln(1 + K)$ , according to our results (section 2.1.2) from Teghtsoonian's meta-analysis on the relationship between Weber's fractions  $\kappa$  and Stevens' power exponents  $\tau$  for different modalities, but this relationship is not discussed by Luce. Luce's functional equations for utility of gains and for subjective stimulus fractions differ by replacing factor  $llc < 0$  in functional equation  $U(x \oplus y) = Vex) + U(y) - U(x) \cdot U(y)/c$  by factor  $\delta \geq 0$  as well as replacing functions  $Vex)$  by  $\psi(x)$  and  $V(y)$  by  $\psi^*(y)$ . Thereby, Luce's psychophysical measurement is an unbounded modification of his utility measurement for gains, where the replacement of the status quo by the zero or just unnoticeable level for positive fraction scale values requires  $\delta \geq 0$ . Luce (2000) proved that  $\delta < 0$  defines a bounded measurement for  $\psi(x)$  and  $\delta \geq 0$  an unbounded one, but also remarked (Luce, 2004, p.449) with respect to the unbounded measurement by restriction  $\delta \geq 0$  that

*"it would be desirable to overcome this restriction because a bounded psychophysical function has considerable intuitive appeal"*

Luce's restriction  $\delta \geq 0$  is required for subjective stimulus magnitudes that have the zero or just noticeable stimulus intensity as reference level. However, the overwhelming experimental evidence for Helson's (1964) adaptation-level theory, discussed in section 1.4., says that magnitudes of stimulus intensities are *not* evaluated with respect to a zero or just noticeable level, but with respect to adaptation level as geometric midpoint of the stimulus range, as also is demonstrated in section 2.1.2. by the re-analysis of Guilford's scaling of subjective numerosness of spots in spot patterns. If Luce had taken the adaptation level, instead of the zero or just noticeable stimulus level, as reference level in his axiomatisation of the psychophysical function  $\psi(x)$ , then the same axiomatisation as for utility would apply and would also have yield differently bounded positive or negative magnitude response scales as separated, subjective stimulus magnitude scales above and below adaptation level. Based on our further analysis of the mentioned meta-analysis by Teghtsoonian's (1971, 1974), we concluded that Stevens' power exponent not only is proportional to the inverse of the modified Weber fraction  $\ln(1 + \kappa_k)$ , but also to the inverse of the logarithmic stimulus range  $\ln(x_{k,max}/x_{k,min})$ , whereby we demonstrated (section 2.1.2.) that Steven's psychophysics is compatible with the Fechnerian psychophysics of sensation matching with cognitive magnitude sensations. This compatibility not only derives because the modified Weber fraction  $\ln(1 + \kappa_k)$  and the logarithmic stimulus range  $\ln(x_{k,max}/x_{k,min})$  follow both from Fechner's law (section 2.1.1.), but mainly because we also demonstrated (chapter 3) that the exponential transformation of a comparable sensation space defines a power-raised stimulus fraction space with the projected adaptation space point as dimensional unit points of the dimensional fraction scales  $x_{ik}/b_k$  and as

rotational parameter for dimensional power exponents  $\tau_k = 2/\ln(b_k/u_k)$  with  $x_k/u_k$  as re-scaled unit point of the dimensional fraction scales. Thereby, Steven's power-raised ratio scales for subjective stimulus magnitudes are dimensional stimulus representations of comparable sensation scales  $2(Y_k - a_k)/a_k = \tau_k \ln(x_k/b_k)$  where  $\tau_k = 2/a_k = 2/\ln(b_k/u_k)$  is defined by two distinct unit points  $x_k/u_k = 1$  as Just noticeable stimulus level and  $x_k/b_k = 1$  as adaptation level. Taking perceived stimulus magnitudes as comparable sensations, we apply the same reformulation as for  $V(x)$  and then obtain

$$\psi(x) = -[1 - (x/b)^{\tau}] / [1 + (x/b)^{\tau}] \propto \tanh[\frac{1}{2}\tau \ln(x/b)].$$

Of utility scale  $-1 < V(x) < 1$  is a subjective magnitude-response scale for value sensations of valued goods with values that are assumed to have subjective value magnitudes with a power exponent  $t = 1$ . Our bounded scale  $V(x)$  is not essentially different from a magnitude response  $-1 < r = \psi(x) < 1$  that may have different power exponents  $\tau$  for each modality. If  $x$  is Euclidean then our  $\psi(x)$  is open-Euclidean and if  $x$  is hyperbolic then our  $\psi(x)$  is open-hyperbolic as shown for response spaces in chapter 4, where we also derived that if  $x$  is double-elliptic then

$$\psi(x) = \arctan[\tau \ln(x/b)]$$

is the psychophysical response function for subjective stimulus magnitudes, where the response space is single-elliptic. Our three alternative stimulus geometries (Euclidean, or hyperbolic, or double-elliptic) have a distance metric that is conformal to the distance metric of their corresponding, open response spaces. We regard conformal distance metrics of the common stimulus space and individual response spaces as a prerequisite, because otherwise individual behaviour can hardly be adequate in the physical reality. Conformal distance metrics holds not for objective value and Luce's utility measurements. Moreover, as further discussed in the next following sections, our psychophysical response measurement is reference- and measurement-invariant and for dissimilarity responses also structure-invariant, whereby meaningfulness of quantitative relationships between dimensional measurements is in principle satisfied, also for inter-individual relationships if individually different adaptation levels are taken into account. We finally remark that it would be much easier to verify psychophysical measurement axioms for qualitative equivalences  $(x,y) \sim (u,v)$  of unconditional visual stimulus pairs, instead for loudness stimulus pairs  $(x,D)$  at the left ear and  $(0,v)$  at the right ear, because not influenced by perceptual sensitivity differences between left and right ears and not restricted to conditional stimulus pairs  $(x,D)$  and  $(0,v)$  that complicate the empirical evidence. For example, binocularly evaluated black-area equivalences in jointly presented pairs of markedly different (no just noticeable differences) black pie parts of circular discs and rectangular black parts of squares (or black pie parts of discs with different diameters and different black rectangle parts of varying rectangle sizes). We conjecture that one of our response measurements (likely the open-Euclidean one) will then be verified with parameter  $b$  as average black area parts of circular discs or squares (also of circular discs with varying diameters and rectangles with varying sizes). Stimulus-adaptation level  $b$  likely is a common parameter for individuals if the stimulus combinations of a known stimulus set are randomly presented. If pies of different circle diameters and parts of varying rectangle sizes are used then we further predict that the fitted power exponent likely approaches  $t = 1/2$ .

Besides the unprecedented result of inferred-extensive utility measurement by Luce (2000) and our transformed-extensive response and valence measurements, only interval scales have been derived from rank order structures of conjoint component outcomes or from existing multidimensional scaling or unfolding analysis methods of ordered dissimilarity or preference structures. It would qualify quantitative theories in today's psychology of judgment and preference as meaningless. In the sequel of this chapter we argue that the questionable measurement status in the psychology of judgment and preference is caused by not specifying:

1. individually meaningful and distinct translations and weights for the comparability of sensation dimensions that specify by their exponential transformation distinctly power-raised stimulus fraction dimensions,
2. the permissible (conditionally) structure-invariant geometry that can represent dissimilarity or preference rank orders by (conditional) distances in spaces that are strictly isomorphic to stimulus spaces with a physically acceptable geometry.

It seems as if researchers in psychology have expected that their conjoint structure scaling or their analyses of rank-order data by multidimensional scaling methods will reveal the appropriate geometries for the relevant psychological domains, in the same way as physical data analyses showed after some centuries of physical research that the appropriate physical geometry is not Euclidean, but the hyperbolic space-time geometry for dimensionally invariant equations of physical laws with dimensionless power exponents. However, this hope must be vain if psychological data analysis is not used for the confirmative testing of theoretically permissible geometries for psychological data. Moreover, the dimensional invariance of the multiplicative equations for physical variables (FoM: ch. 10, ch. 22) and precision of measurements in crucial experiments has led to the relativity theory that determines the hyperbolic space-time geometry of modern physics, but (some kind of) dimensional invariance of psychological measurements has not been achieved (except maybe for measurements of item difficulty and individual capacity by Rasch (1960, 1966a) model analyses of intelligence sub-tests). Measurement by scaling of conjoint ordinal structures or by multidimensional scaling of ordinal data in psychology only yields interval scales that are not dimensionally invariant and can hardly reveal the appropriate distance metric and open nature of the geometry for the respective psychological domains. Interval scale measurements in the nonphysical sciences determine the impossibility of meaningful quantitative relationships between their dimensional measurements, which makes empirical verifications of their quantitative relationships in principle impossible. In FoM (ch. 10, section 10.12) alternative suggestions are discussed. We quote from (FoM, ch. 10, p. 518):

*"What, then is the significance of all this for the nonphysical sciences? It suggests that they must either 1) discover their own ratio scales and append them to the existing structure of physical quantities, 2) introduce into that structure new nonbasic quantities that are relevant to the nonphysical sciences, or 3) arrive at lawful formulations having a character different from the dimensionally invariant equations of physics."*

Each alternative path is further commented. For suggested path I) it is commented that one could take differences between elements of interval scales as arguments of a ratio

for its scales, but this is rejected by the apparent non-uniqueness of such differences. However, it will be clear that we followed this path for the (O,2,O)-unique scale of comparable sensations, where we solved the non-uniqueness problem by defining comparable sensation scales as the ratio of a difference between a variable and a fixed scale point and a constant distance to that fixed scale point on the interval scales for each individual, where the fixed point and the distance define solvable parameters. Thereby, comparable sensation dimensions exhibit a kind of dimensional invariance, because invariant under linear transformations of its underlying Fechnerian interval-scale dimension. However, it introduces a dependence on individually defined space translation and dimensional weight parameters that specify their dimensional invariance. A comment on suggested path 2) states

*"the whole of psychophysical scaling can be looked upon as a major attempt to add nonbasic psychological variables to the existing structure of physical quantities."*

It is further suggested that one could derive relations between power-raised ratio scales from the matching of subjective intensities for interval-scale measures of sensations and, if we were empirically able to determine these dimensional power exponents, that we then could determine their dependence on various physical quantities, but that *"this has yet to be done"* (FoM, ch. 10, p. 520). In the derivations for our psychophysical theory we also followed this path, where we analytically derived distinctly power-raised stimulus fraction scales from comparable sensations. In section 3.3 we identified Stevens' power exponents  $\tau_k$  of subjective stimulus magnitudes as twice the inverse of adaptation-level parameters by  $\tau_k = 2/a_k \approx 2/\ln(b_k/u_k)$ . A constant Stevens' power exponent then implies a constant distance  $a_k = \ln(b_k/\mu_k) - \ln(u_k/\mu_k)$  between the adaptation and just noticeable level on a Fechner sensation dimension with an interval scale measurement. Varying Fechner interval-scale differences  $y'_k - a_k$  and fixed scale distance  $1/2a_k$  define by their ratios the (O,2,O)-unique scales of comparable sensations. Thereby, we also implicitly followed the suggested path 3), because comparable sensations are invariant under linear transformations of the underlying interval scale for Fechner sensations. This measurement invariance allows a formulation of meaningful, quantitative relationships between dimensional response or valence measurements that derive from metric transformations of comparable sensations.

The psychophysical response and valence theory, described in chapters 2 to 5 of this monograph, thus, integrates the three suggested paths in a consistent way. The *"own ratio scales"* of psychology mentioned for suggested path 1) are derived or rather are replaced by metric transformations of comparable sensation scales to open measurement dimensions of responses or valences, whereby the underlying comparable sensation scales are indeed *"appended to"* or rather specify physical quantities as distinctly power-raised stimulus fraction scales. The *"new nonbasic quantities"* for suggested path 2) are the open response or valence measurement scales that derive from metric response or valence transformations of distinctly power-raised fraction scales of stimuli with a ratio scale. Moreover, as described in chapter 3 to 5 in here, metric transformations of Euclidean or non-Euclidean stimulus spaces to spaces of comparable sensations, or responses or valences define their respectively permissible geometries by the permissible Euclidean or non-Euclidean stimulus geometries. Our metric transformations of dimensionally invariant, comparable sensations specify also the

dimensional invariance of response and monotone or single-peaked valence measurements, which enables the formulation of meaningful relationships between dimensional measurements in the psychology of judgment and preference. In order to explain further the measurement-theoretical implications of our theory, we firstly discuss what fundamental measurement theory has and has not achieved in more detail.

#### 6.1.4. *Meaningfulness and axiomatic measurement theory*

Physics is based on extensive measurements wherein additive scale units correspond to the concatenation of observable units, such as equal units of length or mass. Its axiomatisation yields extensive (primary or direct) measurement of ratio scales, where we denoted it as ostensive-extensive measurement. Empirical relationships in physics are primarily described by multiplicative laws of ratio scales, where the product and/or ratio of scale units of multiplied and/or divided dimensions define the scale unit of the ratio scale for their law outcomes. Several scales in physics have no directly observable concatenation of physical units that correspond to the additivity of scale units, as for example holds for temperature (temperatures don't add, but average). Their ratio scales are derived from empirical relationship outcomes that are defined by products or ratios of ostensive-extensive measurement scales as holds for binary laws in physics. For example, the Boyle/Gay-Lussac or Charles law  $T = P \cdot V$  for  $T$  as temperature and  $V$  as volume of an ideal gas with pressure  $P$ , where the temperature reduction of a volume at  $0^\circ\text{C}$  decreases  $P$  by  $1/273$  by each degree at constant  $V$  or decreases  $V$  by  $1/273$  by each degree at constant  $P$ , which defines  $-273^\circ\text{C}$  as the zero of Kelvin's ratio scale of temperature. Derived-extensive temperature measurement becomes then possible by conjoint results  $T = p \cdot v$  for pairs of ostensive-extensive measurements with absolute origins for series of closed volumes  $V$  and their changed pressures  $P$ , where the scale unit of outcomes  $T$  is defined by the constant amount of work for a dimensionless change of  $1/273$  in pressure  $P$  for each constant volume  $V$ . However, derived-extensive measurement is not possible in nonphysical sciences, because we have no ostensive-extensive measurement for any nonphysical component. Only observable order (and/or equivalence) evaluations for stimuli as combinations of varying components or for objects with varying attributes can be the basis for their fundamental measurement. Conjoint component, or difference, or distance measurement structures for transitively ordered binary point evaluations can only yield interval-scale dimensions, if no distinct and solvable, dimensional parameters for their origin and scale unit can be specified. The additive structures in conjoint measurement (Luce and Tukey, 1964) and the closely related measurement models of difference structures (Suppes and Winet, 1955) as well as the distance structures of MDS-models for transitively ordered evaluations of stimulus pairs, have led all to interval-scale measurements of psychological observations. Interval scale measurement is as fundamental as extensive measurement types that define ratio scales. Interval-scales are usually obtained for components in conjunctive structures from suitably rich ordinal data that satisfy weak monotonicity and an axiom system that contains an associative conjunction axiom, where an associative operation  $\oplus$  on elements  $x, y, z$  of an underlying component means that

$$x \oplus (y \oplus z) = (x \oplus y) \oplus z.$$



An associative conjoint structure yields either interval scales  $x$  and  $y$  with a common scale unit or power-raised ratio scales with a common power exponent, provided that some rather technical axioms are satisfied (FoM: ch. 6).

We define elements  $u_i, v_k$  of component  $X$  and elements  $u_j, v_h$  of component  $Z$  with ordered data  $u_i \oplus v_k \geq u_j \oplus v_h$  that satisfy monotonicity for its conjoint outcome structures with associative operation  $\oplus$ . It defines that interval scales  $x_i = \alpha \cdot x'_i + \beta$  for  $X$  and  $z_k = \alpha \cdot z'_k + \beta$  for  $Z$  can be solved such that if

$$u_i \oplus v_k \geq u_j \oplus v_h \text{ then } \begin{cases} (x_i + z_k) \geq (x_j + z_h) \\ (\alpha x'_i + \alpha z'_k) \geq (\alpha x'_j + \alpha z'_h) \end{cases} \quad (76a)$$

where a change in scale unit  $\alpha$  must be identical for both components. The possible numerical representations of an additive conjoint structure is not limited to interval scales for  $x$  and  $z$ . There exist strictly monotone functions  $I_x, I_y, I_z$  and  $h$  such that  $u_i \oplus v_k \geq u_j \oplus v_h$  is satisfied for

$$u_i \oplus v_k = I_x^{-1}[I_x(x'_i) + I_z(z'_k)] = h_x(x_i) \oplus h_z(z_k) \quad (76b)$$

An alternative representation defines combination rule  $\oplus$  to correspond with a multiplicative scale combination by the exponent of logarithmic transformed interval scales  $x'_i$  and  $z'_k$  with common scale unit parameter  $b_Y$

$$1 = 1_x = 1_z = \ln \text{ and } h_x = h_z = h = f^{-1} = \exp$$

whereby

$$u_i \oplus v_k = \exp[\alpha \ln(x'_i) + \beta] + \exp[\alpha \ln(z'_k) + \beta] = c \cdot x_i^{\alpha} z_k^{\alpha} \quad (76c)$$

with

$$c = \exp(\beta_x + \beta_z) \text{ and } \alpha \text{ as arbitrary parameters}$$

This type of measurement from order relations in additive (FoM: ch. 6) and polynomial additive (FoM: ch. 7) conjoint structures, where operation  $\oplus$  is an associative operation (addition, subtraction, multiplication or division) of metric scale values for the components of the combination, has enriched the classical measurement theory of physics. Before the sixties of the last century fundamental measurement was restricted to the ostensive-extensive or derived-extensive measurement of physics that specifies multiplicative dimensional relationships (although equivalently expressed by logarithmic transformations to log-interval scales with log-additive relationships). More general representations of intensive measurement are obtained (FoM: ch. 19, ch. 20) by generalising the associativity for the operation  $\oplus$  in the measurement axioms (Narens and Luce, 1976). It defines measurement scales  $x_i$  and  $z_k$  for generalised conjoint structures  $u_i \oplus v_k$  that satisfy monotonicity by a function  $g$  that requires that  $g(x_i)$  is monotonic increasing and  $g(x_i)/x_i$  monotonic decreasing. Thereby, ratio scales  $x_i \geq 0$  and  $z_k \geq 0$  for components  $X$  and  $Z$  are derivable from

$$u_i \oplus v_k = h_x(x_i) \oplus h_z(z_k) = f^{-1}[f_x(x_i) \oplus f_z(z_k)] = z_k' g(x_i/z_k)$$

$$u_i \oplus v_k = f_x(x_i) \circ f_z(z_k) = f[h_x(x_i) \oplus h_z(z_k)] = f[z_k' g(x_i/z_k)]$$

Here  $\oplus$  is a generalised conjunction rule that can correspond to associative or nonassociative operations  $\otimes$  or  $\oslash$  between transformed ratio scales  $x$  and  $z$  by monotone functions  $f_x$  and  $f_z$  or  $h_x$  and  $h_z$ . The requirements for function  $g$  are implied by the (weak) monotonicity axiom that is assumed to hold for the data of the conjoint structures. Conjunction rule  $\oplus$  is a generalised one that needs not, but may be associative (addition or subtraction and multiplication or division) and can as well correspond to different non-associative operations  $\otimes$  and  $\oslash$ , such as numerical averaging of  $f_x(x_i)$  and  $f_z(z_k)$  and geometric averaging of  $h_x(x_i)$  and  $h_z(z_k)$ . It can yield also nonassociative operations for ratio scales  $x$  and  $Z$  (FOM: ch.19 and ch.20, especially theorems 3 and 10), provided the above-mentioned requirements for function  $g$ , some technical axioms, and the axiom of positive concatenation sequences are satisfied. Generalised conjoint structures that empirically satisfy monotonicity and are characterised by non-associative operations specify by positive concatenations and the mentioned function  $g$  that the resulting scales  $x$  and  $Z$  are ratio scales or power-raised ratio scales. Notice also that if  $g$  is a power function then it must have a positive power exponent smaller than unity in order to satisfy that  $g(x/z)/(x/z)$  for any constant  $z$  is decreasing for  $x/z > 1$  (if  $x/z < 1$  then  $x$  and  $z$  are reversed, which introduces a distinct unit point) and then  $h_x$  and  $h_z$  also are functions with common power exponents and multiplicative operation  $\circ$ . In that case the inverse function  $f$  can be the exponential function and  $f_x$  and  $f_z$  identically weighted, logarithmic functions. Only for physical log-interval scales such weights are dimensionless integers or ratios of integers.

For monotonically increasing functions  $f$  and  $h$  of scales  $x$  and  $z$  that quantify the components  $U$  and  $V$  as  $h_x(x_i) = U_i$  and  $h_z(z_k) = V_k$  and generalised conjunction rule  $\oplus$  that corresponds to associative or non-associative numerical operations  $\otimes$  and  $\oslash$  in generalised conjoint structures, satisfying some technical axioms and the axioms of monotonicity and positive concatenation structures, it holds that

$$\text{and } U_i \oplus V_k = f_x^{-1}[f_x(x_i) \circ f_z(z_k)] = h_x(x_i) \otimes h_z(z_k) \quad (77a)$$

$$U_i \oplus V_k = z_k \cdot g(x/z_k) \quad (77b)$$

provided that function  $g(x/z)$  is monotonic increasing and  $g(x/z)/(x/z)$  monotonic decreasing. This requirement for function  $g$  implies that the operation  $\circ$  is nonotonic in the usual sense that

$$\text{and } \begin{aligned} \text{if } f_x(x_i) > f_x(x_j) & \text{ then } f_x(x_i) \circ f_z(z_k) > f_x(x_j) \circ f_z(z_k) \\ \text{if } f_z(z_k) > f_z(z_h) & \text{ then } f_x(x_i) \circ f_z(z_k) > f_x(x_i) \circ f_z(z_h) \end{aligned}$$

Combining (77a) and (77b) we have

$$f_x(x_i) \circ f_z(z_k) = [z_k \cdot g(x/z_k)] \quad (77c)$$

If operation  $\circ$  satisfies associativity then and only then equations (76) also apply. For (77a) and (77b) associativity of operation  $\circ$  is nonessential. By (77a) we also have

$$f_x(x_i) \circ f_z(z_k) = f[h_x(x_i) \circ h_z(z_k)] \quad (77d)$$

which in (77a) or (77d) or (77a) just defines an alternative scaling of

the conjunction by the two different monotone functions  $f$  and  $h$  as

$$u_i \oplus v_k = f(x_i) \oplus f(z_k) = f[h(x_i) \otimes h(z_k)] = f[z_k \cdot g(x_i/z_k)] \quad (77e)$$

From  $h(x_i) \otimes h(z_k) = z_k \cdot g(x_i/z_k)$

invariance under a common ratio scale unit change of  $x$  and  $z$  follows by

$$(a \cdot z_k) \cdot g[(a \cdot x_i)/(a \cdot z_k)] = a[h(x_i) \otimes h(z_k)]$$

$$a[h(x_i) \otimes h(z_k)] = [a \cdot h(x_i)] \otimes [a \cdot h(z_k)]$$

If conjunction rule  $\otimes$  is the bisection for psychophysical scaling of elements of  $x_i$  and  $x_j$  of the same component, then it applies to  $u_i \oplus u_j$  and  $f = f$  with metric operation  $\otimes$  as the average of  $f(x_i)$  and  $f(x_j)$ . In order to guarantee that the bisection method for  $f(x_i) \otimes f(x_j)$  with non-associative average operation  $\otimes$  yields an interval scale for  $f(x)$ , it has to satisfy, besides the monotonicity and some technical axioms, the so-called bisymmetry axiom:

$$[(X_i) \otimes \{(x_j)\}] \otimes [f(x_k) \otimes \{(X_l)\}] = \{[(X_i) \otimes f(x_k)] \otimes \{(X_j) \otimes (x_l)\}\}$$

If  $\{ = \text{In}$  for sensations of a stimulus modality  $x$  and operation  $\otimes$  is the average for the bisection operation  $\oplus$  for sensations  $\{(x)\}$ , then this satisfies the bisymmetry axiom and by (77c) and (77d) we obtain

or  $\{(x_i) \otimes \{(x_j)\} = \frac{1}{2} \ln(x_i) + \frac{1}{2} \ln(x_j) = \text{In}[x_i \cdot g(x_i/x_j)]$

and  $\sqrt{x_i} \cdot \sqrt{x_j} = X_i \cdot g(x_i/x_j) \quad \text{or} \quad g(x_i/x_j) = J(x_i/x_j)$

$$h(x_i) \otimes h(x_j) = x_i \cdot g(x_i/x_j) = x_i \cdot J(x_i/x_j) = \sqrt{x_i} \cdot \sqrt{x_j}$$

where we see that  $h$  as square root and operation  $\otimes$  as multiplication of square root stimulus values, define the bisection operation as the geometric mean for stimulus values. Here  $\otimes$  also is the square root function that satisfies for  $x > 1$  the requirement of increasing  $g(x)$  and decreasing  $g(x)/x = 1/\sqrt{x}$ . If  $x < 1$  then for increasing  $g(1/x)$  the expression  $g(1/x)/(1/x) = \sqrt{x}$  is decreasing, with distinct point  $x = 1$  as demarcation. It defines by  $\{ = \text{In}$  sensations  $\text{In}(x) = y$  that then have positive concatenations for negative units if  $y < 0$  and for positive units if  $y > 0$  with distinct sensation point  $y = 0$  as demarcation.

Positive concatenation structures for generalised conjoint measurement that satisfies monotonicity have solvable scales  $x$  and  $z$  such that the corresponding conjoint elements in the generalised combination rule  $\oplus$  are quantified by  $z'g(x/z)$ , provided that function  $g$  is increasing for  $g(x)$  and decreasing for  $g(x)/x$ . If operations  $\otimes$  and  $\oplus$  are associative then addition or subtraction of interval scales  $x$  and  $z$  or respectively multiplication or division of exponentially transformed scales  $x$  and  $z$  can only quantify the conjoint elements, where these associative conjoint structures are historically called additive. But associativity of  $\otimes$  and  $\oplus$  is nonessential for the general application of conjoint measurement, because for scales  $x$  and  $z$  their equivalence with  $z'g(x/z)$  also holds for nonadditive structures, where conjunction operations are not associative. The scaling by non-associative operations may require the specification of a distinct scale point, where below and above the infinite, positive scale unit concatenation is

separately specified. If  $g(x/z) = 1/(x/z)$  then function  $g(x/z)$  is increasing, but  $g(x/z)/(x/z) = 1/(x/z)^2$  is only decreasing for  $x/z > 1$ . We may define  $z = b$  as a constant value of scale  $x$ , with  $x/b = t$  as distinct unit point where above infinite concatenations of positive (infinitely small) scale units exist. However, defining  $z = 1/b$  and a reciprocal scale  $1/x$ , we have infinite positive concatenations for values  $b/x > 1$ . Thereby, it defines a so-called homogeneous measurement scale for  $x$  from 0 to infinity with differently defined positive infinite concatenations on each side of the distinct unit point as connection point. For a scaled conjunction structure with  $g = \sqrt{\quad}$  we have

$$[ \cdot^{-1} [I(x) \odot [(b)]] = b \cdot g(x/b) = b \cdot \sqrt{(x/b)} = \sqrt{x} \cdot \sqrt{b}$$

It defines  $[$  as logarithmic function and operation  $\odot$  as the bisection or average operation, because only  $\exp\{[\ln(x) + \ln(b)]/2\} = \sqrt{x} \cdot \sqrt{b}$ . Here averaging operation  $\odot$  is a non-associative operation, which thus very well can represent conjoint structures that satisfy the monotonicity requirement and the requirement of infinite concatenations with a positive scale unit, although the latter here with respect to a distinct unit point. A relevant example is the bisection method in psychophysical scaling (Cross, 1965), where subjects judge the sensation of an adjusted stimulus intensity to be halfway the sensations of two presented stimuli, which implies the average for the operation  $\odot$  in  $[f(x) \odot [f(x)]$ . The axiomatic derivation of bisection measurement is originally formulated by Pfanzagl (1968). For sensations as a logarithmic scale of a stimulus modality it yields the geometric mean of the two presented stimuli as stimulus intensity for the bisection of sensations as  $\exp\{1/2 \ln(x_1) + 1/2 \ln(x_2)\} = \sqrt{x_1} \cdot \sqrt{x_2}$ . Another example of bisection is conjunctive temperature measurement by conjunction of two equal (almost closed) volumes of the same liquid that are heated in identical ways for different periods, because temperature of the added volumes equals the temperature of a volume that is heated for the average period of the periods for the two added volumes.

The concatenation under non-associative operations is said to be idempotent and bisymmetric if  $u_i \oplus u_j$  equals the midpoint of  $f(x_i)$  and  $[f(x_j)]$  with  $\oplus$  as averaging, where

$$u_i \oplus u_j = [f(x_i) + f(x_j)]/2.$$

Concatenations are defined as positively asymmetric if

$$u_i \oplus u_j > [f(x_i) + f(x_j)]/2;$$

for example, if  $\oplus$  is the geometric averages of  $0 < f(x_i) < 1$  and  $0 < [f(x_j)] < 1$ . Negatively asymmetric concatenations apply if

$$u_i \oplus u_j < [f(x_i) + f(x_j)]/2;$$

for example, if  $\oplus$  specifies the geometric averages of  $[f(x_i)] > 1$  and  $f(x_j) > 1$ . A conjunction rule  $\oplus$  that corresponds to non-associative operations, such as geometric averaging, can thus yield asymmetric concatenations with respect to the unit point where below concatenations are positively asymmetric and above negatively asymmetric. The requirements of function  $g$  and infinite positive concatenations for some scaling are only satisfied if we take for values below unity the reciprocal scale values. For the logarithmic transformation of ratio scales the original geometric average operation becomes the averaging operation of logarithmically transformed ratio scales, which then corresponds to means of interval-scale values. Then we have a distinct zero

point as demarcation point for the positive concatenations of log-scale values, because infinite positive concatenations for negative log-scale values are only defined for the corresponding logarithm of the reciprocal for its original scale terms, It demonstrates that the axiom of positive infinite concatenation structures can require the specification of a distinct scale point with different positive concatenations on each side of that distinct scale point in order to define scales over the whole range of scale values that are hypothesised to apply. The non-associative bisection operation is idempotent for sensations, because  $u_i \oplus u_i = (y_i + y_i)/2$ , but is asymmetric for stimulus scales, because  $u_i \oplus u_i = \sqrt{x_i \cdot x_i}$ . Another example is the result for generalised conjoint measurement of subjective expected utility by the so-called dual bilinear utility model (FoM: ch. 20, section A.6) for gambles with uncertain outcomes. It assumes a dimensional utility point with idempotent concatenations above and below that dimensional point for weighted interval scales with positive weights  $< 1$ .

If the operation in generalised conjoint structures is idempotent then two equations are obtained, one for  $h(x) > 1$  with  $0 < c < 1$  and one for  $h(x) < 1$  with  $0 < d < 1$ , while  $h(1) = 1$ . Two equations for power-raised ratio scales  $x$  and  $z$  are then derived as

$$= \begin{cases} x^c \cdot z^{1-c} & \text{for } 1 > c > 0 & \text{if } x > z \\ x & & \text{if } x = z \\ x^d \cdot z^{1-d} & \text{for } 1 > d > 0 & \text{if } x < z \end{cases}$$

or taking  $u = \ln(x)$  and  $v = \ln(z)$  for interval scales  $u$  and  $v$ , as

$$u \oplus v = \begin{cases} c \cdot u + (1-c)v & \text{if } u > v \\ u & \text{if } u = v \\ d \cdot u + (1-d)v & \text{if } u < v \end{cases}$$

which are called dual-bilinear equations. For  $c$  and  $d$  as subjective outcome probabilities that need not to satisfy  $c + (1-d) = 1$  and some technical as well as two non-axiomatised requirements, a dual bilinear utility model is derived as generalised, subjective expected utility model, where  $u$  and  $v$  become interval scales for utility of component  $U$  and of component  $V$ . The two non-axiomatised requirements are that a common utility function  $u$  exists and  $\exp(c \cdot u) = x^c$  is homogeneous {not restricted to a maximum, continuous and uniquely determined up to the scale unit of  $x$  and the parameter  $c$ }.

The classical theory of additive conjoint measurement yields extensive measurements as ratio scales with no essential distinct points or maxima (FoM: ch. 6, P 258). The classical theory of additive conjoint structures developed in the late sixties and seventies of the 20th century has subsequently been generalised considerably, using the mentioned assumptions for function  $g$  and positive concatenations, where the generalised conjunction operations are also non-associative (FoM: ch. 19 and 20). These generalisations also can lead to constructions of infinite or open scales for distance structures that satisfy (weak) monotonicity and are characterised by (eventually non-idempotent) concatenations with respect to a distinct point or, if open then between the limits of a positive maximum and negative minimum as additional distinct or

singular scale points. The axiomatisation of probability measurement (FoM: ch. 5) defines a singular maximum as the unit point that corresponds to the universal event, whereby event probabilities of finite event sets are (O,D,I)-unique fraction measurements of the total event set. Also an axiomatisation of a generalised conjoint structure for length and finite velocity of light in relativistic physics (FoM: ch.3, section 3.7) requires non-associative structures with an essential maximum point for positive measurement scales of relativistic measurements by the constant velocity of light, but such an axiomatisation is not given. Besides the discussed (subsection 6.1.3.) inferred-extensive measurement of utility by Luce (2000), axiomatic measurement results for psychological measurements with a distinct zero point, a singular or distinct, positive maximum, and a singular or distinct, negative minimum are not published to our knowledge, but are implied by the response and preference measurements in our psychophysical response and valence theory, as discussed in the sequel.

Generalised conjoint measurement structures with non-associative operations have helped the understanding of which scales allow meaningful propositions between measurements of components from conjoint structures that satisfy monotonicity. It is proved (FoM: ch.20) that generalised conjoint structures  $u \oplus v$  with associative or non-associative operation  $\oplus$  for outcome structures that satisfy monotonicity can always be scaled by positive scales of reals  $x$  and  $z$  for its components  $u$  and  $v$  and identical power exponents  $\tau > 0$  (FoM: ch. 20, theorem 11), where  $x$  and  $z$  satisfy measurement homogeneity (infinitely uniform concatenations) and

$$f(x^\tau) = [I(x)]^\tau \quad \text{and} \quad h(z^\tau) = [h(z)]^\tau$$

This result is important, because their admissible transformations define which scale types satisfy meaningfulness of quantitative relationships between variables  $x$  and  $z$ . If  $f(x) = x/\mu$  and  $h(z) = z/\mu'$  then the expressions clearly hold, whereby they hold for (I,O,O)-unique ratio scales and for distinctly power-raised, (I, I,a)-unique ratio scales, provided that their scale units are taken into account (FoM: ch. 19 and ch. 20). The above expressions hold not for  $x$  and/or  $z$  as bipolar or negative ratio scales, or interval scales, but apply to positive (0, I,a)-unique stimulus fraction scales with a dimensional unit point and to positive (0,2,0)-unique, distinctly power-raised stimulus fraction scales with distinctly defined unit points and dimensional power exponents.

It could also apply to the dual-bilinear utility measurements that are described in the last mathematical section, but only if their power exponents and demarcation levels for their dual scale representation would be distinctly defined by solvable dimensional parameters. Without such distinctly defined, dimensional parameters its power-raised scales are not (1,2,0)-unique, but (2, 1,a)-unique utility scales, since their logarithmic scales are interval scales with a distinct demarcation point. As also discussed in the previous section, the axioms for dual-bilinear utility measurement have recently been modified and generalised by Luce's (2000) rank- and sign-dependent utility without some associativity axiom and thus also without using the function  $g$  that is increasing for  $g(x)$  and decreasing for  $g(x)/x$ . Luce's utility axioms apply to equivalence structures for joint receipts of valued good pairs, where a generalised additivity is not presupposed, but derived. It specifies an inferred-extensive utility measurement for subjectively evaluated losses or gains with respect to a distinct point as individual status quo with zero utility, but with an unspecified unit  $\mu$  of value scale

$x/\mu$  and unspecified ratio  $elk$  for dimensionless limits  $c$  of gains and  $-k$  of losses. Thereby, Luce derived (I, I, I)-unique utility measurement of losses or gains separately, but it can't be applied to loss and gain mixtures and due to unspecified utility limits also not for a meaningful comparison between utilities of individuals.

We noticed earlier that positive ratio scales  $x/\mu$  with respect to a fixed ratio scale value  $x/b = I$  become fraction scales  $x/b$  that have distinctly defined scale units. Due to their 1-dimensional unit points  $x/b = 1$ , such fraction scales of ratio scales are (O,I,O)-unique scales. Semi-positive ratio scales have a zero origin and no distinct point, but are dependent on an arbitrary scale unit  $\mu$  and thus (I,O,O)-unique. Clearly semi-positive fraction scales are allowed to be some scale  $x$  in the above expression  $f[x] = [f(x)]^\tau$ . For  $\tau > 0$  and  $f(x) = x/\mu$  the expression describes a power-raised ratio-scale  $(x/\mu)^\tau$  and its logarithmic transformation defines a weighted interval scale  $\tau \cdot \ln(x/\mu)$ . These scale types are (2,0,0)-unique, if there are no distinct parameters for these scales: one for the scale unit  $\mu$  of the underlying ratio scale and one for the power exponent  $\tau$  that for its interval scale become respectively a dimensional translation parameter  $\ln(\mu)$  and a dimensional unit parameter  $1/\tau$ . Only in physics the power exponent  $\tau$  is a dimensionless parameter, whereby its scale and its log-scale are both (1,0,I)-unique. In physics the measurement unit is conventionally agreed, while its power-raised fraction scales have dimensionless power exponents that are determined by the dimensional invariance for physical scales (FoM: ch. 10), whereby power exponents  $\tau$  are integers or ratio of integers, such as the power-raised scale for volume that has  $\tau = 3$  by its cubic length measures. But there is a conventional aspect hidden, because if volume would be chosen as the basic, not power-raised scale then length would have a power-raised scale with  $\tau = 1/3$ . If physical scales are not specified by fractions of their conventionally agreed standards for their scale units then the power-raised scales and their log-interval scales are (I,O,i)-unique, because the power exponents that are determined by integers or by ratios of integers as specific dimensionless parameters that depend on the (ratio of) of the space dimensionality of the (ratio of) the measurement. The conventionally agreed standards for the units of physical ratio scales, such as the length of one metre or a minute for time, define physical fraction scales with dimensional unit points that correspond to the standard measurement unit of physical ratio scales. Thus, power-raised ratio scales, when expressed by fractions of their conventional units in physics, become power-raised fraction scales and then are dimensionally invariant, (O,i,1)-unique scales in our definition of scale uniqueness. Without such specified measurement standards also power-raised physical ratio scales only are (1,0,I)-unique and define no dimensionally invariant relationships between physical dimensions. But, as shown in the next section, the absence of arbitrary parameters for (0, 1, 1)-unique, power-raised fraction scales in physics similarly apply also to distinctly solvable, (0,2,0)-unique, power-raised stimulus fraction scales as subjective stimulus magnitudes that derive from the exponential transformation of comparable sensation scales. The physical stimulus space exhibits a rotation-invariant geometry, while the dimensional power exponents for the power-raised stimulus space of subjective stimulus magnitudes are rotational parameters, as shown in chapter 3, which for subjective stimulus magnitudes defines a dimensional invariance that is comparable to the dimensional invariance of physical measurements.

### 6.1.5. Meaningfulness by dimensional invariance

The exponential transformation of intensity-comparable sensations defines power-raised fraction scales of stimuli with a power exponent that equals twice the inverse of the logarithm of the ratio of the individual adaptation level  $b_k/\mu_k$  and the just noticeable stimulus level  $u_k/\mu_k$  on the stimulus ratio scale  $k$ , while the fraction is defined by the individual adaptation point as unit scale point  $x_k/b_k=1$ . The power-raised stimulus scales from Stevens' subjective magnitude scaling are to be characterised as (1,1,0)-unique, because they have arbitrary scale units and distinctly solvable, dimensional power exponents. Its power exponents  $\tau_k = 2/\ln(b_k/u_k) = 2/a_k$  are distinctly defined, but are not dimensionless, as holds for power-raised ratio scales in physics. These power-raised stimulus fraction scales  $(x_k/b_k)^{\tau_k}$  are defined by exponentially transformed, comparable sensations  $s_{ik} = 2(y_{ik} - ak)/a_k$  that depend on two distinct unit points on fraction scales of stimulus ratio scales  $x_k/\mu_k$ . One dimensional unit point is the adaptation point  $x_k/b_k = 1$  and the other one  $x_k/u_k = 1$  corresponds to the just noticeable sensation intensity  $\ln(x_k/u_k) = 0$  as Fechner space origin. Thus, here there are two dimensional points that determine the fraction scale and its power exponent, while the stimulus fraction scale  $x_k/b_k$  and the power exponent  $2/\ln(b_k/u_k) = \tau_k$  are independent of the arbitrary scale unit  $\mu_k$  of the corresponding stimulus ratio scale. It determines this distinctly solvable, power-raised fraction scale of stimuli to be (0,2,0) unique, because defined by two dimensional values. The logarithm of a distinctly power-raised stimulus-fraction scale  $k$  defines the intensity-comparable sensation scale

$$f[(x_{ik}/\mu_k)/(b_k/\mu_k, u_k/\mu_k)] = \ln[(x_{ik}/b_k)^{2/a_k}] = 2\ln[(x_{ik}/\mu_k)/(b_k/\mu_k)]/\ln[(b_k/\mu_k)/(u_k/\mu_k)]$$

which is equivalently written by  $\tau_k = 2/a_k = 2/\ln(b_k/u_k)$  and the cancelling of  $\ln(\mu_k)$  as

$$2[\ln(x_{ik}) - \ln(b_k)]/[\ln(b_k) - \ln(u_k)] = \tau_k \cdot \ln(x_{ik}/b_k)$$

and by taking the just noticeable Fechner sensation  $\ln(u_k) = 0$  as zero sensation intensity

$$2[\ln(x_{ik})/\ln(b_k) - 1] = 2(Y_{ik}/ak - 1) = s_{ik}$$

Here  $Y_{ik} = \ln(x_{ik}/b_k)$  becomes a Fechnerian sensation scale by scaling  $x_{ik}/\mu_k = 1$  as unit stimulus scale point, since Fechner took  $\ln(x_k/u_k) = 0$  as origin of positive sensation scale origin *for*  $u_k/\mu_k$  as stimulus threshold. However, Fechner's sensation scales have no constant origin and are not comparably weighted and, thereby, can't be used for their measurement relationships. Since  $\tau_k = 2/\ln(b_k/u_k) = 2/[\ln(b_k/1) - \ln(u_k/\mu_k)]$  is shown by Stevens' power exponent to be almost constant for each sensory stimulus modality  $x_k/\mu_k$  (except at extremely low or high stimulus intensities), we see that  $u_k/\mu_k$  and  $b_k/\mu_k$  determine a virtually constant sensation distance on the logarithmically transformed ratio scale for stimuli  $x_{ik}/\mu_k$ . Thus, intensity-comparable sensations and their exponential transformation to power-raised fraction stimulus scales are both meaningful (0,2,0)-unique scales as transformed-extensive measurements.

Notice that intensity-comparable sensation scales are also written as a ratio of a variable difference and a constant distance on the interval scales of logarithmic stimulus ratio scales, expressing:



- 1) dependence on two distinct unit points: one on stimulus-fraction scale  $x_k/b_k = 1$  that corresponds to the origin of Fechner-Helson sensation scale and one on a redefined stimulus-fraction scale  $x_k/u_k = 1$  that corresponds to the Fechner scale origin, whereby  $\tau_k = 2/a_k = 2/\ln(b_k/u_k)$  becomes a dimensional parameter that as Stevens' power exponents empirically shown to be (almost) constant;
- 2) invariance under linear transformations of its logarithmic stimulus ratio scales, whereby independence of stimulus-scale units is established, while unit and origin of intensity-comparable sensation scales are determined by distance  $\ln(b_k/u_k)$ .
- Remembering the earlier quoted third alternative for dimensionally invariant measurements in the nonphysical sciences, where it is stated that these sciences without ratio scales must

*"arrive at lawful formulations having a character different from the dimensionally invariant equations in physics",*

we cite further more from comments on that alternative (FoM: ch. 10, p. 520):

*"In addition to considering the possibility of using laws that violate dimensional invariance, which is not very appealing, we can also entertain laws of a rather different sort. One example is laws that establish relationships at two different times. If  $u(a,t)$  is an interval scale measure of some attribute of entity  $a$  at time  $t$ , the quantity*

$$[u(a,t) - u(b,t)]/[u(a,n) - u(b,n)]$$

*is invariant under affine transformations and asserting so that is a constant is a lawlike statement that is dimensionally invariant. Just what all the possibilities are in this direction has never been worked out."*

Comparing the expression for intensity-comparable sensations with the expression in this citation, we replace  $u(a,t)$  by  $\ln(x_k/\mu)$  as interval scale value of Fechner sensations,  $u(b,t)$  and  $u(a,t')$  both by  $\ln(b_k/\mu)$ , and  $u(b,t')$  by  $\ln(u_k/\mu)$  as distinct points on that Fechner sensation scale, whereby also intensity-comparable sensation scales are invariant under linear transformations of their underlying Fechner sensation scales with interval-scale measurement. Thus, we implicitly worked out one relevant direction by transforming Fechner sensations to intensity-comparable sensations that are dimensionally invariant by the invariance under linear transformations of their underlying Fechner sensations. Notice also that this dimensional invariance of comparable sensations is stronger than the measurement invariance for z-scores of interval-scale variables with nonnormal distributions, because the z-scores depend on the validity of the nonnormal distribution assumption and for different samples on the assumption of random selections from one population.

Similar matters holds for valence-comparable sensations, where adaptation level  $b_k/\mu$  and ideal point  $p_k/\mu$  define two distinct points on each stimulus dimension  $k$  for preference evaluations of individuals. Here we write the valence-comparable sensations, as logarithm of the underlying stimulus scale  $k$  with an arbitrary scale unit, by

$$\mathcal{L}[(x_k/\mu)/(b_k/\mu, p_k/\mu)] = |\ln[(x_k/\mu)/(p_k/\mu)]| / |\ln[(b_k/\mu)/(p_k/\mu)]|,$$

which is equivalently written by  $\sigma_k = 1/|\ln(b_k) - \ln(p_k)|$  and the cancelling of  $\ln(\mu)$  as

$$1/|\ln(x_k) - \ln(p_k)| \cdot |\ln(p_k) - \ln(b_k)| = \sigma_k \cdot |\ln(x_k/p_k)|,$$

Taking  $d_k = |\ln(b_k) - \ln(p_k)| = |a_k - g_k|$  as scale unit with  $g_k = \ln(p_k)$  as ideal point

of the valence- comparable sensation scale we have

$$\ln(y_i - g_k) - \ln(P_k) = \ln(x_k/P_k) - \ln(x_k - g_k)$$

Distances  $y_i - g_k$  and  $d_k$  are respectively variable and fixed distances to the ideal point on logarithmic stimulus ratio scales as Fechnerian interval scales, where adaptation level  $b_k$  together with ideal point  $p_k/\mu$  define two distinct unit points: one on stimulus-fraction scale  $x_k/b_k$  and the other on stimulus-fraction scale  $x_k/P_k$ . Thus, also valence-comparable sensation scales are (O,2,O)-unique and invariant under linear transformations of their underlying Fechner scales  $y_i = \ln(x_k/b_k)$ , due to their ratio of variable distances and a constant distance on logarithmic ratio scales  $y_i = \ln(x_k/\mu)$ . This invariance of comparable sensation scales is comparable to the dimensional invariance for power-raised fraction scales of ratio scales in physics, although the power exponents  $\tau_k$  and  $\sigma_k$  are here dimensional values (no dimensionless power exponents, as in physics). Notice that by definition  $\ln(b_k) - \ln(P_k) = \ln(b_k) - \ln(f_k)$  for  $f_k/\mu$  as deprivation point, where if  $f_k/\mu$  coincides with the just noticeable Fechner sensation  $u_k/\mu$  then  $\ln(b_k) - \ln(P_k) = \ln(b_k) - \ln(u_k)$ , whereby  $\sigma_k = \tau_k$ .

In fact this type of dimensional invariance already is axiomatically implied in FoM (section 4.3.), where it is stated that if the order relations between interval-scale differences  $y_i - y_j$  can be represented by ratios of ratio-scale values  $g(y_i)/g(y_j) = x_i/x_j$  with the same order then it requires for strictly increasing functions  $f$  and  $g$  that

$$\text{and } f(y_i - y_j)/a = [g(y_i)/g(y_j)]^\tau$$

$$f(y_i + B)/a = [g(y_i)]^\tau$$

but then  $\beta$ ,  $\alpha$ ,  $\beta$ , and  $\mu$  must "be uniquely determined by such a requirement if, indeed, the requirement can be satisfied at all". (FoM, ch. 4, p.153). Although this requirement seems doubted by "if, indeed, the requirement can be satisfied at all", it exactly is this requirement that is satisfied by  $f = g = \exp$  of comparable sensations scales with  $\alpha = \ln r$ ,  $\mu = b^{-1}$ , and  $-\beta = a = \ln(b)$  as adaption level and range midpoint of intensity-comparable sensations or with  $\alpha = 1/\sigma = d = \ln a - g$  and  $-\beta = g$  as individual ideal point of valence-comparable sensations. Moreover, if the deprivation and just noticeable levels coincide then  $d = 1/2a$  and, thus,  $\sigma = \tau$ , whereby intensity- and valence-comparable sensation scales are identical. It is further commented (FoM, ch 4, p.154) that the two expressions above are implied by Torgerson's (1961) suggestion that estimated differences and ratios are related by  $f(y_i - y_j) = \exp[y_i - y_j]$ . Torgerson suggests that the instruction of difference evaluations induces another intensity scale than instructions for ratio evaluations. A Fechner sensation difference  $y_i - y_j$  as category  $m$  on an ordered difference rating scale  $C$  satisfies

$$C_{m-1} < (y_i - y_j) + B/u < C_{m+1}$$

which equivalently is described by rating scale  $N_m = [\beta + C_m/u]$  by

$$N_{m-1} = \beta + C_{m-1}/u < (y_i - y_j) < \beta + C_{m+1}/u = N_{m+1}$$

while then a corresponding ratio evaluation by rating category  $n$  on rating scale  $R$  becomes

$$R_{n-1} < f[(y_i - y_j) + G]/a = \mu \cdot \exp[(y_i - y_j) \ln] < R_{n+1}$$

for  $f = \exp$  and  $\mu = \exp(\beta/\alpha)$ . For rating scale  $M_n = a \ln[R_n/\mu]$  this implies

$$M_{n-1} = a \ln[R_{D-1}/\mu] < (y_i - y_j) < a \ln[R_{n+1}/\mu] = M_{n+1},$$

It then follows that  $N_m = M_m$ , whereby

$$C_m = a(N_m - B) \quad \text{and} \quad R_n = \mu \cdot \exp(N_m/a).$$

Thus, rating scale C acts as interval scale and rating scale R as power-raised ratio scale. But, as commented (FoM, ch. 4, bottom line p.154),

*"then the subjects really do act as though they are judging numerical differences and ratios of sensations, when requested to judge differences and ratios",*

In the comment this is doubted, because subjects may generate different order relationships for ratio and difference judgements that both satisfy transitivity and if so then each can be scaled in many ways. In our tenns this comment states that difference and ratio judgments may exhibit the property of reference invariance, but that structure invariance for ratios and differences may be expressed by different structure-invariant geometries. We have shown that something similar to Torgerson's ad hoc hypothesis may apply to Stevens' fractionation method, where we conjectured that fraction judgement is a matching with cognitive magnitude dimension  $[\ln(q_i) - a]$  as logarithmic transformation of an objective ratio scale for magnitude  $q_i/b$ . This may be comparable to

$$q_i/b = R_n \quad \text{and} \quad [\ln(q_i) - a] = C_m,$$

but this is not what was hypothesised by Torgerson (1961). However, intensity-comparable sensations require not the ad hoc hypothesis of Torgerson, because differences between intensity-comparable sensations and their ratios as

$$\text{and} \quad \frac{(y_i - y_j)/a}{I} = \frac{\ln(x_i/x_j)/\ln(b/u)}{I}$$

$$\frac{y_i/a - I}{I} = \frac{\ln(x_i/b)/\ln(b/u)}{\ln(x_j/b)\ln(b/u)}$$

are both invariant under linear transformation of Fechner sensation scale  $y$ , whereon sensations  $y_i = \ln(x_i/\mu)$ ,  $y_j = \ln(x_j/\mu)$ , adaptation level  $\ln(b/\mu)$ , and just noticeable level  $\ln(u/\mu)$  are located and whereon distance  $\ln(b/u)$  is almost constant, because Stevens' power exponent  $\tau = 2/\ln(b/u)$  is almost constant.

**In summary:** the exponential transformations of comparable sensation dimensions define distinctly power-raised stimulus-fraction dimensions as subjective stimulus magnitude scales. Power-raised fraction scales in physics and power-raised stimulus fraction scales in psychophysics and their logarithmic scales are both respectively (0,1,1)- and (0,2,0)-unique scales. The only differences are (1) dimensionless versus dimensional power exponents and (2) collectively agreed versus individually solvable unit points for the respective fraction scales in physics and psychophysics. The power-raised fraction scales of subjective stimulus magnitudes have a similar dimensional invariance as measurements in physics, because Stevens' power exponents are rotational parameters that equal the distinct weights of dimensions in rotation-invariant, comparable sensation spaces. Therefore, we explicitly formulate:

Corollary 2: Meaningfulness by (0,2,0)-unique scales of comparable sensations

Intensity- or valence-comparable sensation dimensions are weighted, dimensional Fechner-sensation differences to respectively dimensional adaptation or ideal points with weights defined respectively by twice the inverse of a dimensional distance between the dimensional adaptation and just noticeable points or by the inverse of the distance between the dimensional adaptation and ideal points in a rotation-invariant Fechner space, whereby comparable sensations are invariant under linear transformations of their underlying Fechnerian dimensions. Due to this invariance and the dependence on two dimensional points, comparable sensation scales are dimensionally invariant, (0,2,0)-unique scales in a rotation-invariant space, whereby meaningfulness of their measurements holds.

Due to the dimensional invariance of comparable sensations also their metric transformations to responses and monotone or single-peaked valences are dimensionally invariant, which enables the formulation of meaningful, quantitative relationships in the psychology of judgment and preference. If we have algebraic different, quantitative relationships for each response or valence geometry and by empirical evidence only one relationship kind is confirmed, then we also have metric uniqueness of quantitative relationships for a theory of individual judgment and preference. Also meaningful quantitative relationships between responses or valences of different individuals are possible, provided that the individual translation and weight parameters of the underlying comparable sensations are distinctly solved. Since this holds for the analyses in chapters 4 and 5 of this monograph, we can meaningfully describe relationships between response or valence measurements of individuals.

*6.1.6. Permissible geometries for similarity and preference measurements*

Although modern measurement theory contributes much to the understanding of the permissible types of measurement from conjoint outcome structures, it has not specified psychological measurement scales by ratios of a variable difference or distance and a fixed distance of an interval scale. But, such scales are dimensionally invariant, because invariant under linear transformations of the underlying interval scale. Modern measurement theory also lacks a geometric foundation and clarifies not which geometries are permissible for the multidimensional analysis of observed ordinal data in psychology. These facts have been the main obstacles for progress in psychological theory, because they prohibit dimensional invariance of measurements and meaningfulness of quantitative relationships between dimensional measurements. Analyses of conjoint component outcomes and ordinal distances structures are represented by spaces with metric, continuous dimensions, but their dimensional scales generally are interval scales of dimensions in infinite spaces. The object representations on these infinite dimensional scales may not completely be determined and then the dimensional scale type becomes a so-called semi-metric ordered or hyper-ordinal scale. It formally falls between the interval and ordinal scale type, although only very small changes in multidimensional scale positions are generally allowed, because otherwise the observed rank order information becomes violated massively. Therefore, if the information on the ordinal dissimilarity relations between pairs of objects is sufficiently rich, then the semi-metric ordered dimensional scales by MDS or unfolding analyses define

dimensional measurement representations that virtually are (1,O,D)-unique. This holds for the existing MDS-analyses of similarity responses or multidimensional unfolding analyses of preferences. If the numbers of objects and individuals are large enough and order relations between object pairs (ordered dissimilarities) or order relations of objects with respect to an imaginary ideal object (ordered preferences) are satisfactorily represented by metric space distances, then the dimensional measurement representations become (2,O,O)-unique interval scales with a restricted measurement variability that hardly differs from the usual measurement error of scales in physics. Measurements derived from space representations of distance inequalities by MDS-methods then define interval scale measurements. However, it is not sufficient to have suitably rich ordinal information of individual dissimilarities for MDS-analyses, because one additionally needs a distance metric of a permissible geometry for multidimensional representation of transitively ordered dissimilarities. As discussed in preceding sections and also is apparent from the geometric representations of distance measurements (FoM: ch. 14), axiomatic measurement theory not only contributed little to dimensionally invariant measurements in nonphysical sciences, but also little to the geometric foundation of multidimensional measurement representations of observed data in nonphysical domains. Measurement axiomatisation remains incomplete without geometric axioms, while also in psychology any attention is hardly given to theoretically permissible geometries for multidimensional representations, although the requirement of transitive distance representations specifies which geometries are permissible, as further demonstrated next.

Transitively ordered dissimilarities as unidimensional distances between points of two point sets (a,b,c) and (x,y,z) have to satisfy the weak monotonicity axiom

$$\text{if } d(a,b) \geq d(x,y) \text{ and } d(b,c) \geq d(y,z) \text{ then } d(a,c) \geq d(x,z)$$

for any scale that represents individual dissimilarity rank orders as transitive distance rank orders (intransitivity of dissimilarities can consistently occur and appropriately analysed, which is further discussed in chapter 7). The weak monotonicity axiom requires that the metric dimension has a zero or constant curvature. This is proved for the lengths of intervals ab, bc, ac, xy, yz and xz that satisfy  $d(a,b) \geq d(x,y)$  and  $d(b,c) \geq d(y,z)$  on a straight line or circle or hyperbola, while on curves with varying curvatures  $d(a,c) \geq d(x,z)$  can easily be falsified. Multidimensional measurement spaces that represent transitive dissimilarities as space distances require a space with a zero or constant curvature, because dimensions that satisfy the weak monotonicity axiom specify that the triangular distance inequality holds, which only is satisfied for spaces with a zero or constant curvature (Busemann, 1955). Thereby, the quadrangular monotonicity axiom, expressed in corollary 3 below, derives.

Corollary 3: quadrangular monotonicity axiom

Ordered space distances as representations of individually rank-ordered dissimilarities require that a weak order of quadrangle sides specifies a weak order of quadrangle diagonals (z,x) and (w,y) that satisfy

$$\text{if } d(w,z) \geq d(x,y) \text{ and } d(y,z) \geq d(w,x) \text{ then } d(z,x) \geq d(w,y),$$

which only is true for distances in spaces with a zero or constant curvature.

The proof of this axiom is derived by sequences of triangular distance inequalities of triangles with a common quadrangle side, where the triangular distance inequalities only holds in spaces with a zero or constant curvatures. Thus, distances in spaces with a zero or constant curvature can represent the unconditional reference invariance for observed rank order relations of individual dissimilarities. Corollary 3 implicitly specifies the permissible transformations of dimensional measurements, because distance rank orders in zero and constant curvature spaces are invariant under translation, rotation (except in Minkowski spaces), and central dilation. Distance rank orders not only can change under dimensional dilations, but also under isomorphic space transformations. For example, if  $f \approx \tanh$  and  $d(w,z) > d(x,y)$  holds then  $d[f(w),f(z)] > d[f(x),f(y)]$  may not hold, depending on the difference in proximity to the space origin for  $(w,z)$  and  $(x,y)$ . Suppose  $d(w,z) > d(x,y)$  holds in the weighted Euclidean sensation spaces of two individuals with different adaptation points, while distances  $d[f(w),f(z)]$  and  $d[f(x),f(y)]$  in their open-hyperbolic response spaces represent their observed dissimilarities, then  $d[f(w),f(z)] > d[f(x),f(y)]$  may hold for one individual and  $d[f(w),f(z)] < d[f(x),f(y)]$  for the other. Therefore, individual difference MDS-analyses of dissimilarities can be invalid, because dissimilarities must be analysed as distances in individually different, open response spaces.

Multidimensional scaling methods yield measurements that depend on the chosen geometry for the common object space, which generally is a flat (Euclidean or Minkowskian) geometry. However, other permissible, structure-invariant distance geometries may better fit the unconditional rank orders of individual dissimilarities by its distances, as the here relevant structure invariance for binary space points. If dissimilarities are represented by distances in individually different spaces then generally the multidimensional scaling analysis is only modified by individual dilations (weights) for the space dimensions. These individual weights then define individually different space distances, but individual translation parameters are arbitrary, because distances are invariant under translations. Even if it is assumed that the geometry for such individual measurement representation is valid for dissimilarity responses as space distances, it still means that the individual translation parameters for the dimensional scales are unknown, unless dimensional weights and translations are theoretically related parameters. In our psychophysical response theory they are related individual parameters for comparable sensation spaces, but dissimilarities in our theory are represented by distances in individually different response spaces that have no arbitrary measurement parameters. Since in individual difference MDS-analyses define space with arbitrary translations, quantitative relationships between its dimensional measurements can't be meaningful, because not dimensionally invariant. Therefore, without a valid theory that determines by dissimilarity analysis a measurement space without arbitrary parameters (besides central dilations), quantitative relationships between dimensions can't be dimensionally invariant. Thus, quantitative theories that are based on measurements from any existing MDS-analysis of dissimilarities must in principle be not meaningful. Moreover, without the valid uniqueness of the geometry the formulation of quantitative relationships can be different for permissible geometries. It is often argued that the geometry can be specified by choosing the geometry with the most parsimonious representation (the geometry with the minimum

number of dimensions that fits best the dissimilarity inequalities). However, the most parsimonious geometry provides no valid knowledge on the actual geometry, because it falsifies not other permissible geometries. Only dissimilarity analyses that uniquely determine dimensional translation and scale-unit parameters can yield dimensionally invariant measurements and meaningful quantitative relationships for each permissible geometry, which by empirical evidence for a uniquely valid metric formulation of dimensional relationships then would uniquely define the valid geometry. According to our psychophysical response theory, individual rank orders of dissimilarity responses are to be represented by the rank order of distances in open response spaces with a zero or constant curvature. Inverse response transformations of individually solved open response spaces define individually weighted and translated sensation spaces and the transformations of the latter spaces to a common Euclidean object space uniquely solve the individual translation and scale-unit parameters that determine dimensionally invariant measurements for meaningful quantitative theory in psychology.

In case of unidimensional, single-peaked preferences the weak monotonicity axiom conditionally applies to ordered distances of points  $a$ ,  $b$ ,  $x$ , and  $y$  with respect to ideal point  $p$  on a straight or curved dimension as unidimensional representation of ordered preferences, where the conditional quaternary distance inequalities require that midpoints  $m(a,x)$  and  $m(b,y)$  satisfy

$$\text{if } d(p,x) \leq d(p,a) \leq d(p,b) \leq d(p,y) \text{ then } m(b,y) \leq m(a,x) \text{ and } d(a,b) \leq d(x,y).$$

If the preference order of an individual with ideal point  $p$  is unidimensional then the scale with ordered points  $p,x,a,b,y$  is called a folded, ordinal scale with  $p$  as folding point of the unfolded scale with ordered points  $b,a,p,x,y$ . The gained information concerns the implication that if order  $x < a < b < Y$  holds then ideal point  $p$  satisfies  $m(b,y) < p < m(a,x)$  and thus  $d(a,b) < d(x,y)$  and if order  $a > x > y > b$  holds then  $m(b,y) > p > m(a,x)$  and thus  $d(a,b) > d(x,y)$ . Thereby, we obtain some metric information by the implied ordering of scale midpoints from the preference order. If the rank orders of many subsets of four points fit the conditional quaternary distance inequalities with respect to different located ideal points of several individuals, then it defines a semi-metric ordered scale of the Coombsian unfolding analysis in one dimension, which dimension generally is assumed to be straight (zero curvature). However, a dimension with zero or even a constant curvature is not necessary. The conditional quaternary distance inequalities only requires that the absolute curvature of the scaled dimension increases not with the order of the curved distances. This is easily proved for ordered points  $b,a,p,x,y$  on a straight line, on a circle, on a hyperbola, and on a curve with an absolute curvature that decreases with the curved distances to point  $p$  (a smaller average curvature of distances means a larger average radius and, thus, enlarged curve distances to  $p$ ), since distance rank order  $d(p,x) < d(p,a) < d(p,b) < d(p,y)$  implies the midpoint order  $m(b,y) < m(a,x)$ , which can easily become falsified by  $m(b,y) > m(a,x)$  on other curves. If more than four points and individual ideal points are located on a curve with a curvature that individually decreases with the curved distance to differently located ideal points, then the conditionally weak quaternary monotonicity still individually holds for all multiples of four objects. For multidimensional preferences we formulate correspondingly:

**Corollary 4: conditional quaternary monotonicity axiom**

Conditionally ordered space distances as representations of individual preference rank orders require that weakly ordered distances of space points (a, b, x, y) to an ideal point p also specify a weak rank order of distances  $dCa, b$  and  $d(x, y)$  by

$$\text{if } d(p,x) \leq d(p,a) \leq d(p,b) \leq d(p,y) \text{ then } dCa,b \leq d(x,y),$$

which only is true for spaces with a zero or constant curvature or with absolute curvatures that decrease with increased distances to space point p.

Its unidimensional and multidimensional axioms are identical, because the circular projections of space points (a,b,x,y) with respect to projection centre p on dimension  $Cp,x$  preserve their distance order to point p, if the projection circles have the same (zero or constant) curvature or absolute circle curvatures that decrease with increased distances to point p. Thus, if the space curvatures vary then corollary 4 only holds for absolute space curvatures with the reversed rank order of their curved distances to point p. This is proved by realising that curvature-corrected space distances divided by their curvatures define curved space distances. Only if the space curvatures vary irregularly or have the same order as their distances to ideal point p then curvature ab. of distance  $d(a,b) := |a - b|/\zeta_{ba}$  can be smaller than curvature  $\zeta_{xy}$  of distance  $d(x,y) := |x - y|/\zeta_{xy}$ , whereby the weak distance rank order  $d(p,x) \leq d(p,a) \leq d(p,b) \leq d(p,y)$  can lead to  $d(a,b) = |a - b|/\zeta_{ba} > d(x,y) = |x - y|/\zeta_{xy}$ , but then it requires that the conditional space distances are defined by non-monotone or different monotone functions of their corresponding distances to ideal point p in the curvature-corrected space. Therefore, the conditional quaternary monotonicity axiom only holds for distances in spaces with a zero or constant curvature or with absolute curvatures that decrease with increases of their conditional distances to ideal space point p. It implies that all curvature-corrected distances to ideal space point p are monotonic transformed by the same function, whereby curved and curvature-corrected distances to point p have the same rank order.

Corollaries 3 and 4 only restrict, but don't uniquely specify the geometry curvature and both also don't specify whether their distance metrics apply to infinite or open spaces or whether the spaces describe individually different or identical object configurations. The next two corollaries state this more explicitly.

**Corollary 5: permissible geometries for dissimilarity representations as distances**

Spaces that represent transitively ordered dissimilarities by unconditionally ordered distances are spaces that can only have an infinite or open geometry with a zero or constant curvature and may contain individually different object configurations.

Corollary 5 implies that a MDS-analysis can't represent transitive dissimilarities by distances in a power-raised stimulus space, because power-raised stimuli have local curvatures that rotationally change with their dimensional directions from the space adaptation point as rotational centre, as shown in chapter 3. The Fechnerian scaling theory of Dzhabarov and Colonius (1999,2001), who represent dissimilarity responses by location- and direction-dependent distances in the Finsler space of power-raised stimuli, could be applied, but the analysis would then reduce to only direction-dependent, binary point representations of dissimilarities in a power-raised stimulus fraction space with respect to dimensional adaptation points as unit reference points.



However, if their Fechnerian scaling would not represent dissimilarity responses in a power-raised stimulus space, but in an open involution space of the power-raised stimulus fraction space with the adaptation point as unit point, then the open scaling space would have a zero or constant curvature. The Fechnerian scaling would then reduce to a MDS-analysis of individual dissimilarities as location- and direction-independent distances in a single-elliptic, or open-Euclidean or hyperbolic response space with the adaptation point as origin. Notice that identical and constant adaptation points may only hold in case of dissimilarity evaluation tasks for randomly selected, perceptual stimulus pairs from a prior known stimulus set, otherwise adaptation points may shift by task- and stimulus-dependent dissimilarity evaluations, which is further discussed in next chapter 7. If adaptation points are individually constant and different, which generally holds for dissimilarity evaluations between cognitive objects from a known object set, then a Euclidean MDS-analysis of individual dissimilarities may be appropriate, if the response space is open-Euclidean. However, also MDS-analysis of individual dissimilarities can hardly resolve whether the actual response geometry is flat (Euclidean or Minkowskian), or hyperbolic, or single- or double-elliptic and, if flat or hyperbolic, whether the geometry is open or infinite, due to the ordinal measurement level of the observed data and the absence of a valid theory that restricts the permissible response geometries. Existing MDS-analysis only allow individual dimension weights, rotations (if the distance metric is not Minkowskian), and translations of a common flat space. Our psychophysical response theory implies that individual response spaces have either an open-hyperbolic, or open-Euclidean, or single-elliptic geometry as perspective-dependent projections of infinite, Euclidean or hyperbolic spaces of comparable sensations. Thus, if adaptation points are constant then corollary 5 requires that we analyse individual dissimilarities as distances in their open response geometries and that the individually solved, open response spaces must be transformed to a common Euclidean object space in order to see whether object configurations of individuals are indeed identical. Therefore, we firstly have to transform by inverse projections the individually solved response spaces to individual Euclidean or hyperbolic spaces of comparable sensations and secondly have to match (by translations, rotations, and inverse weighing of dimensions,) these comparable sensation spaces to a common sensation space, which are topics described in chapter 4. If sensations are hyperbolic then the common Euclidean object space is the stimulus or cognitive-attribute space, else it is the common sensation space.

Corollary 6: permissible geometries for preference representations by distances

Spaces that represent transitively ordered preferences by conditionally ordered distances to individual ideal points are spaces that only can have an infinite or open geometry with a zero or constant curvature or with absolute curvatures that decrease with the distance to individual ideal points and may contain individually different object configurations.

Corollaries 4 and 6 imply no severe geometry problem for unfolding analyses of rank ordered, single-peaked preferences, due to the conditional order of preference data that have circular iso-valent contours to ideal points in individual valence and sensation spaces. An unfolding analysis of conditionally ordered preference data only can analyse

preference representations in a common space. If the sensation space is Euclidean and the unfolding analysis represents preferences by individual iso-valent circles in individually weighted Euclidean sensation spaces then, according to our theory, it may correctly solve the object configuration. But, it does not reveal the appropriate metric for the preference strengths of individuals, nor whether their preference spaces are open or infinite. Only analyses of individually ordered data of preference dissimilarities between all object pairs could describe an individual preference space, but generally such preference data are not available. Thus, generally we can't determine individual space solutions, but only common space solutions, whereby we only can infer from individually different dimension weights and the differently spaced and oriented iso-valent contours of individuals whether individual preferential object configurations are markedly different or not. Both last corollaries also imply that the object configuration not only can be different by individually weighted spaces, but also by individual projection transformations of an infinite object space to open, individual spaces with a constant negative curvature or with absolute curvatures that decrease with the increased distance to ideal points. Thereby, existing analysis methods of single-peaked preferences may yield partially invalid solutions. Moreover, quantitative relationships between dimensional measurements from existing MDS-analyses of dissimilarities or unfolding analyses of preferences can't be meaningful.

In view of the psychophysical response and valence theory the assumed infinite geometries with a zero curvature (thus Euclidean or Minkowskian) for the usual MDS or unfolding analyses are questionable, as shown in chapters 4 and 5. In chapter 4 we identified individual response spaces as individually different spaces with an open-Euclidean or, open-hyperbolic, or single-elliptic geometry that satisfy the unconditional quadrangular monotonicity axiom. In chapter 5 preferences for objects with monotone valences are represented by individually oriented ideal axes in their response spaces and preferences for objects with single-peaked valences by valence measurements in individually different, open Finsler or open-hyperbolic geometries that satisfy the conditional quaternary monotonicity axiom with respect to the ideal point, because its absolute curvatures either decrease with the increased distance to the individual ideal point or are constant. Individual response or valence spaces are symmetrically isomorphic projection transformations of infinite, hyperbolic or Euclidean, comparable sensation spaces (with respect to the adaptation or ideal space points of individuals), while comparable sensation spaces are asymmetrically isomorphic (exponentially) transformed to dimensionally invariant, power-raised, Euclidean or non-Euclidean spaces of subjective stimulus-fraction magnitudes. The common Euclidean object space and the individual parameters are solved from inverse transformations of individual response or valence spaces, wherein ordered distance inequalities represent their dissimilarity or preference rank orders. It then also allows the formulation of meaningful quantitative relationships between comparable sensation dimensions, due to their dimensional invariance, although only in an induced way because not sensation, but response and valence space distances represent observed rank orders of dissimilarities or preferences. Due to their metrically isomorphic transformations of comparable sensation spaces to response or single-peaked valence spaces, response and single-peaked valence measurements also are dimensionally invariant.

The measurement spaces in our psychophysical response and valence theory still lack the property of geometric uniqueness, due to the alternatives of the permitted hyperbolic, elliptic, or zero curvatures for the open geometry of the response spaces, while valence spaces also have three alternatives for their permitted, open geometries either with a constant hyperbolic curvature or with absolute curvatures that decrease with increasing distances to the ideal point. Nonetheless, the formulation of quantitative relationship between binary point values of responses or single-peaked valences is different for each permissible geometry. Therefore, it is in principle possible that empirical evidence verifies only one of the differently formulated, quantitative relationships, which in turn would define the unique geometry for the stimulus, sensation, response, and valence spaces. Since hyperbolic tangent functions of comparable sensations define responses in open-Euclidean or open-hyperbolic spaces, geometric uniqueness of quantitative relationships between point values of response spaces may not hold, but metric and geometric uniqueness can in principle be satisfied for relationships between binary response space points. Notice also that the unidimensional scaling of data with a conditional reference invariance for binary scale points with respect to a target scale point, such as in Stevens' psychophysics, determines not the scale curvature, which has obscured the geometric consistency between Fechner's and Stevens' alternatives of the psychophysical function, as discussed earlier. The dimensional invariance and uniqueness properties of response and valence measurements are further discussed below and in section 6.2. The uniqueness properties of measurements in modern measurement theory determine, despite its lack of a geometric foundation, whether dimensional invariance holds for measurement representations, which theory must be discussed further before we can fully characterise the uniqueness properties of our response and valence measurements.

#### *6.1.7. Dimensionally invariant response and valence measurements*

Some aspects of modern measurement theory are related to the measurements that derive from the analyses of open response and valence spaces with their permissible distance metrics, presented in chapters 4 and 5 of this monograph. Modern measurement theory mainly assumes infiniteness and homogeneity of measurement scales (FoM: ch. 20). Axiomatic probability measurement (FoM: ch.5) is one classical exception and another is the extensive measurement with essential maxima (FoM: ch.3, sections 3.7 to 3.9) in the nonadditive (generalised-associative) measurement representations in relativistic physics. A third novel third exception is the earlier discussed theory of Luce (2000) for inferred-extensive utility measurement of gains or losses, where utility of gains has a lower measurement limit than the absolute value of the negative limit for utility of losses. The measurement-theoretical concept of homogeneity means that functions of a set of arbitrarily dense data points transform data points  $x$  one to one to metric scale points  $a$  that specify measurement values by  $f(x) = a$  with the same (weak) order as the qualitative data points  $x$  (Narens, 1981). Homogeneous measurement also implies the concatenation of uniform and infinitely small positive units to continuous and infinite scales (Narens and Luce, 1976). Although it seems assumed that uniform concatenations define flat measurement dimensions, we remark that concatenations of uniform, infinitely small units may also define scales of dimensions in a differentially Euclidean geometry and, thereby, also

can define scales with a constant curvature, because infinitely small distances in non-Euclidean spaces are locally Euclidean. There also exist involution transformations that transform homogeneous measurement dimensions of flat or hyperbolic, or double-elliptic spaces to open spaces with homogeneous measurements between singular points and a corresponding curvature. Therefore, we define:

**Definition 9: homogeneous measurement spaces**

Concatenations of uniform, infinitely small units define homogeneous measurement scales as continuous dimensions in spaces that only can be: 1) open or infinite, flat (Euclidean or Minkowskian) spaces, or 2) open or infinite, hyperbolic spaces, or 3) single or double-elliptic spaces, wherein dimensional unit concatenations are limited to open intervals, except for infinite, flat or hyperbolic spaces.

Semi-positive ratio scales define (1,0,0)-unique, homogeneous measurement spaces with a zero origin, but their (1,0,1)-unique, power-raised ratio-scale spaces with dimensionless power exponents are nonhomogeneous measurement spaces, because their curvatures directionally vary with rotation of their space dimensions, as shown in chapter 3. Their corresponding (1,0,1)-unique log-interval scales have negative and positive values and if their log-interval dimensions are infinite and homogeneous then they include by definition  $f(x) = \ln(x) = a$  also  $f(1) = \ln(1) = 0$ . Thus, a homogeneous measurement space can contain distinct zero or unit space points. One such distinct space point is the unit point of homogeneous fraction dimensions of a semi-positive ratio-scale space, which then defines fraction dimensions by a dimensional weighing that defines the dimensional unit point on the ratio-scale space co-ordinates. The measurement conventions in physics define fraction measurement spaces, where dimensional unit points are specified by conventionally agreed standards for dimensional measurement units. Their dimensionless power exponents define (0, 1, 1)-unique, power-raised, physical fraction spaces that are dimensionally invariant, but no longer homogeneous. Nonetheless, homogeneous measurement and dimensional invariance also apply to their (0, 1, 1)-unique, log-transformed spaces, due to their zero or constant space curvature, their dimensional zero points and distinct scale units as respectively defined by dimensional unit points and power-exponent values of their power-raised fraction dimensions. Invariance of comparable sensations under linear transformations of the underlying Fechner sensations defines comparable sensation spaces to be dimensionally invariant. Since their measurements are (0,2,0)-unique and infinitely homogeneous, Bower spaces only can be flat or hyperbolic by definition 9. Exponentially transformed Bower spaces define (0,2,0)-unique, power-raised stimulus fraction spaces that only differ from power-raised, physical fraction spaces by individually distinct, instead of conventionally agreed, dimensional units and by dimensional, instead of dimensionless, power exponents.

Narens and Luce (Narens, 1981, 1985; Narens and Luce, 1986; Luce, 1992, 2000) consider homogeneous and nonhomogeneous measurement representations. By the contrary of definition 9, nonhomogeneous, continuous measurement scales are dimensions in open or infinite Finsler geometries that have variable curvatures. Infinite measurement spaces that represent a structure invariance for unconditional distances not only are homogeneous and continuous measurement geometries, but also have a

zero or constant hyperbolic curvature, as implied by corollary 3 and definition 9, and are thus flat (Euclidean or Minkowskian) or hyperbolic spaces. However, also open-Euclidean, open-hyperbolic, and single- or double-elliptic geometries have homogeneous measurements between singular space points, because their curvatures are *zero* or constant and allow uniform unit concatenations between their limits. Open-hyperbolic measurement spaces and double- or single-elliptic measurement spaces can thus also represent homogeneous measurements between limit points in the measurement-theoretical meaning of homogeneity, although the curved space coordinates are nonhomogeneous in the geometric meaning of that concept. Geometric transformations of an extensive measurement space to open spaces with a zero or constant curvature specify a measurement space that has singular limits and a zero space origin or has a space centre with a distinct maximum, zero dimension points, and a singular negative space limit. They define homogeneous measurements between singular or distinct points, such as

- a) between a singular maximum and a zero for Luce's (2000) utility of gains

$$!(x) \approx c[1 - \exp(-x/\mu)] \quad \text{for } x \geq b,$$

- b) between positive and negative, singular limits with a distinct zero point as for one of our response functions  $f(x) = \tanh[\ln(x/b)/a]$  that simplifies to involution

$$!(x) = -[1 - (x/b)^\tau] / [1 + (x/b)^\tau] \quad \text{with } \tau = 2/a = 2/\ln(b/u);$$

- c) between a distinct maximum and singular negative limit with distinct zero points for our open-hyperbolic, single-peaked valences, where the product of hyperbolic tangent functions  $\tanh[\sqrt{2}\ln(x/b)/\ln(b/p)] \cdot \tanh[-\sqrt{2}\ln(x/lz)/\ln(b/p)]$  simplifies for ideal point  $\ln(p) = \sqrt{2}\ln(b/z)$  by hyperbolic distances  $\cosh[\ln(x/p)/\ln(b/p)]$  to

$$!(x) \approx \tanh[-\frac{1}{2}\ln\{\cosh[\ln(x,lp)/\ln(b/p)]/\cosh(I)\}]$$

If an infinite and continuous space of (0,2,0)-unique, homogeneous, and bipolar measurements with zero or hyperbolic curvature are transformed by a finite projection with respect to a distinct projection origin to an open continuous space, then its open space not only has singular limits, but also a distinct zero space point that demarcates the change from positive to negative, finite concatenations. Their dimensional measurements are homogeneous between singular points if its projected homogeneous measurements define open spaces with a zero or constant curvature. Notice that the type of (generalised) associativity for the measurement representation of observations in such open measurement spaces depends on the curvature of their geometry, while their geometry and the type of evaluation also define the function of binary space points (as conditional distance representations of preferences or subjective stimulus fractions, or as unconditional representations of dissimilarities, or as the equalities between pairs of two point values as equivalences between jointly presented object pairs).

Perceptual stimulus spaces are physical spaces, whereby also stimulus spaces either have a zero curvature (if Newton's Euclidean space applies to stimuli) or have a constant curvature (if the double-elliptic geometry of the optical space or the hyperbolic space-time geometry in modern physics applies to stimuli). Response spaces are space involutions of distinctly power-raised stimulus-fraction spaces (also for the quasi-involutions of a double-elliptic stimulus space as elliptic space projectivities to

single-elliptic response spaces). The corresponding stimulus and response spaces have the same curvature, where the transformed-extensive response measurements define open-Euclidean, or open-hyperbolic, or single-elliptic response spaces. Since power-raised stimulus fraction dimensions are  $(O,2,D)$ -unique, the open response space dimensions define  $(O,2,1)$ -unique scales due to the additional singular value of the response space limit. Open response spaces of individuals can fit transitively ordered dissimilarities by distances, because their geometries satisfy the quadrangular monotonicity axiom (corollary 3). These structure-invariant response geometries for distances are solved from individual dissimilarities by the methods described in chapter 4 and by their transformations to a common Euclidean object space define also the individual parameters for their transformed-extensive response measurements.

Open Finsler or open-hyperbolic geometries for single-peaked valence spaces represent preference measurements that by corollary 4 satisfy the conditional ordering of the quaternary distance inequalities with respect to the ideal space point, because its open spaces have either a constant negative curvature or absolute curvatures that decrease with increased distances to that distinct maximum space point. The single-peaked valence spaces are conditionally structure-invariant, because preferences are represented by conditional distances with respect to ideal points. However, conditionally structure-invariant, open Finsler geometries of single-peaked valences from flat sensation spaces have open nonhomogeneous measurement representations, because varying curvatures imply non-uniform concatenation structures. Nonetheless, their valence measurements are defined by dimensional products of open, homogeneous measurement spaces of covariant valence curvatures and curvature-corrected valences with a single-elliptic or an open-hyperbolic geometry, as demonstrated in chapter 5. Therefore, these products define dual-homogeneous measurements of single-peaked valences that have zero dimensional points somewhere between a dimensionless positive maximum point and a singular negative minimum. However, the open-hyperbolic spaces of single-peaked valences from hyperbolic sensation spaces directly specify homogeneous valence measurements between a singular minimum and a dimensionless maximum, because defined by open single-peaked valence spaces with curvature  $\zeta = -\sqrt{2}$  and ideal space points with a dimensionless maximum valence. The three types of open geometries for single-peaked valences define dimensional concatenation structures for single-peaked valences to be homogeneous (if open-hyperbolic) or dual-homogeneous (if open Finslerian) between a dimensionless maximum and a singular minimum, where dual-homogeneous refers to the dimensional products of their covariant valence-curvature and curvature-corrected valence spaces with homogeneous measurements between singular limits. The dimensionless valence maximum differs from the absolute value of the singular valence minimum, whereby homogeneous or dual-homogeneous valence measurements are  $(0,2,2)$ -unique. Thus, our psychophysical response and valence theory implies  $(0,2,1)$ -unique, homogeneous response measurements and  $(0,2,2)$ -unique, homogeneous or dual-homogeneous valence measurements.

For several other examples of measurement with singular or distinct points we cite again from Luce (1992):

*\*\*\* Relativistic velocity, for which both a maximum (the velocity of light) and a minimum (which is also a zero, namely no relative motion) exist.*

*\* Prospect theory (Kalmeman & Tversky, /979; Tversky & Kahnenum, /990 <actually published in 1992>, which is a generalisation of expected utility theory in which there is a distinctive zero, the status quo, that divides consequences into gains and losses.*

*\* Continuous probability, which both a maximum (the universal event) and minimum (the null event), fails to be Jwmogeneolls between them."*

Citing Luce (1992) fmther:

*"the physically important principle of dimensional invariance, which underlies the method of dimensional analysis that is used in physics, engineering, and to a lesser degree in biology, is merely a special case of demanding that physical laws be invariant under the symmetries of the structure of physical quantities".*

What here is meant by symmetries is the language of mathematical physics and measurement theory, where symmetry refers to homomorphism (automorphism and isomorphism) of the point-to-point mapping of metric space representation of data points, which in physics is a mapping by proportional and power-exponent functions of physical dimensions with an absolute zero origin and a zero or constant curvature. Physical measurement structures imply positive measurements and their dimensional invariance (FoM: ch. 19 and ch. 22) determines the dimensionless power exponents in physical laws of multiplicative dimensions. Logarithmic transformations of positive stimulus fraction dimensions with multiplicative relationships between power-raised stimulus fraction dimensions define additive relations between its weighted sensation space dimensions that then have a zero origin that corresponds to the unit space point of the relative stimulus fraction space. Arbitrary stimulus scale units for dimensions of the physical stimulus space prohibit meaningfulness of relationships between the dimensions of its logarithmic transformed space as the Fechner sensation space, because each sensation dimension then contains an arbitrary translation parameter and if also the psychophysical power exponents of stimulus dimensions would not be distinctly specified then also its dimensional sensation scale units would be undetermined. Formulations of quantitative relationships in psychology only can yield meaningful quantitative propositions if the relationships are invariant under linear transformations of its underlying Fechner space dimensions. As shown, this holds for Bower space of comparable sensations that then correspond to a logarithmic transformed, power-raised stimulus fraction space. Additive measurement relationships between Bower space dimensions then correspond to multiplicative measurement relationships between stimulus fraction dimensions with dimensional power exponents, which resembles multiplicative physical laws with dimensionless power exponents. Formulations of multiplicative relationships between power-raised ratio-scale dimensions are meaningful propositions in physics by their dimensionless power exponents and their conventionally agreed measurement standards of physical scale units, which standards then define fraction scales for physical dimensions. In our psychophysical response and valence theory the stimulus fraction dimensions are defined by fractions of distinct points (the dimensional adaptation or ideal points) on their stimulus ratio scale dimensions as scale unit standards for their fraction

measurements. The power exponents of stimulus fraction dimensions derive from exponential transformations of comparably weighted sensation dimensions and, thus, equal the distinctly defined sensation-weight parameters. Power-raised stimulus fraction dimensions and their logarithmically transformed measurements as comparable sensation dimensions define both (O,2,D)-unique and dimensionally invariant measurements. The symmetric projection transformations of comparable sensations to responses or single-peaked valences define measurements without arbitrary parameters, whereby the (D,2,I)-unique and (O,2,2)-unique scales of respectively responses and single-peaked valences also imply a dimensional invariance of their measurements. Therefore, replacing the word '*physical*' by 'psychological' in the last citation from Luce (1992), it could be said that

*"the 'psychologically' important principle of dimensional invariance <> is merely a special case of demanding that 'psychological' laws be invariant under the symmetries of the structure of 'psychological' quantities".*

Although comparable sensations are dimensionally invariant, we don't have observed order relations between comparable sensations, but between observable responses or preferences. Thus, we don't have any directly observable reference invariance for sensations, whereby we have also no directly verifiable sensation measurements. Nonetheless, we can derive infinite, homogeneous, and dimensionally invariant measurement spaces of comparable sensations from the inverse response or valence transformations of (conditionally) structure-invariant, open measurement spaces that represent the observed rank order of (dissimilarity) responses or the observed, conditional rank order of preferences. Infinite and homogeneous measurement spaces of comparable sensations then specify a theoretically induced measurement space with a derived reference invariance that uniquely corresponds to the observable reference invariance of the (conditional) structure invariance of open response or valence measurement spaces.

## 6.2. Measurement by isomorphic stimulus space transformations

### 6.2.1. Isomorphic spaces and their measurement properties

We defined reference invariance of space points in subsection 6.1.1., where the invariance requires that observations and space point values have the same rank order. If a transformation of a metric space satisfies the same reference invariance for its space points then it specifies an isomorphic space transformation, whereby we generalise the concept of order isomorphism for unidimensional scales (FoM: ch. 19, p.50, theorem 7) to order isomorphism for metric spaces. If a transformed space exhibits the structure invariance for distances of the original space then the transformation is automorphic, which holds for translations, central dilations, and rotations (if rotation-invariant) of spaces with a zero or constant curvature. Isomorphic transformations of a space with structure-invariant distances define spaces wherein distance automorphism is not satisfied, although a corresponding reference invariance of the structure invariance is preserved by some function of transformed space point values of the structure-invariant distances. We explicitly formulate:



**Definition 10: automorphic spaces**

Transfonnnations of a space with structure invariance for distances to spaces, wherein that structure invariance also holds, define automorphic spaces

**Definition 11: symmetrically isomorphic spaces**

Transfonnnations of a space with (un)conditional structure invariance for distances to spaces, wherein that structure invariance is preserved, define symmetrically isomorphic spaces with respect to its transformation centre.

**Definition 12: asymmetrically isomorphic spaces**

Transformations of a space with structure invariance for distances to spaces, wherein that structure invariance is not preserved, but wherein the order of corresponding dimensional points remains the same, define asymmetrically isomorphic spaces.

**If** a reference invariance of **binary** space points concerns unconditional distances then its structure-invariant distance geometry only can have a zero or constant curvature, which holds for open response and monotone valence spaces. These spaces are asymmetrically isomorphic transfonnnations of power-raised stimulus fraction spaces and symmetrically isomorphic transfonnnations of comparable sensation spaces. Thus, the structure invariance for response space distances needs not to hold for distances between corresponding points in individually isomorphic stimulus and sensation spaces. The structure invariance for single-peaked valence spaces concerns conditional distances to the ideal point in open geometries with constant curvature  $\zeta = -1/2$  or with absolute curvatures that decrease with the increased distance to the ideal point. Since single-peaked valences spaces are symmetrically isomorphic transfonnnations of comparable sensation distances to ideal points, the conditional structure invariance for distances to ideal points also holds in comparable sensation spaces. Transfonnnations of comparable sensation spaces to power-raised stimulus fraction spaces (or vice versa) are asymmetrically isomorphic transfonnnations, whereby conditional and unconditional structure invariance holds not in the power-raised stimulus fraction spaces. Transformations of response or single-peaked valence spaces to comparable sensation spaces (or vice versa) are transfonnnations with respect to a distinct transfonnnation centre. For response spaces the transfonnnation centre is the individual adaptation point and for single-peaked valence spaces it is the individual ideal space point.

Asymmetrically isomorphic space transfonnnations of response and single-peaked valence spaces to stimulus spaces preserve *not* the conditional valence or unconditional response distance inequalities, although the quadrangular monotonicity axiom holds in stimulus spaces due to their zero or constant curvature. Transfonnnations of response or single-peaked valence spaces to comparable sensation spaces only preserve conditional and *not* unconditional rank orders of distances, although again the quadrangular monotonicity axiom holds in comparable sensation spaces, due to their zero or hyperbolic space curvature. Nonetheless, some corresponding reference invariance for **binary** points holds in asymmetrically isomorphic stimulus and symmetrically isomorphic sensation spaces. **If** an open-Eudidean response space with distances  $d(a',b')$  is symmetrically transformed by  $f(a') = 2[\arctanh(a')] \rightsquigarrow a$  to the

hyperbolic space of comparable sensations a then

$$d(a',b') := |a' - b'| = |\tanh(\frac{1}{2}a) - \tanh(\frac{1}{2}b)| = \mathcal{F}(a,b),$$

where the rank order of binary point values  $\mathcal{F}(a,b)$  and hyperbolic distances  $\cosh(a - b)$  differ. Also if open-Euclidean response spaces become asymmetrically transformed by  $f(a) := (1 + a)/(1 - a) := a$  as inverse involutions of its response space points then the stimulus space is Euclidean, whereby

$$d(a',b') = |a' - b'| = |1(1 - a)/(1 + a) - (1 - b)/(1 + b)| = \mathcal{F}(a,b),$$

which differs in a non-monotone way from  $|a - b|$  as Euclidean stimulus distance. For an open-hyperbolic response space comparable sensation space is Euclidean, whereby

$$d(a',b') := \cosh[\tanh(\frac{1}{2}a) - \tanh(\frac{1}{2}b)] = \mathcal{F}(a,b),$$

which differs again in a non-monotone way from  $|a - b|$  as Euclidean sensation distance, while its inverse involution to a hyperbolic stimulus space determines

$$d(a',b') := \cosh[(1 - a)/(1 + a) - (1 - b)/(1 + b)] = \mathcal{F}(a,b),$$

which also differs in a non-monotonic way from  $\cosh(a - b)$  as hyperbolic stimulus distance. Therefore, we formulate:

Corollary 7: corresponding reference invariance of binary point values in isomorphic spaces of a structure-invariant distance space

If a space, wherein quadrangular diagonals  $(a',c')$  and  $(d',b')$  satisfy

$$\text{if } d(d',c') > d(a',b') \text{ and } d(a',d') > d(b',c') \text{ then } d(d',b') > d(a',c'),$$

is symmetrically or asymmetrically isomorphic-transformed by  $f(a) := a$  to a space wherein the quadrangular monotonicity axiom holds then it needs not to hold for distances between corresponding points  $(a,b,c,d)$  that

$$d(d,c) > d(a,b), d(a,d) > d(b,c), \text{ and } d(d,b) > d(a,c),$$

but a corresponding reference invariance for some binary point function  $\mathcal{F}$  satisfies

$$\mathcal{F}(d,c) > \mathcal{F}(a,b), \mathcal{F}(a,d) > \mathcal{F}(b,c), \text{ and } \mathcal{F}(d,b) > \mathcal{F}(a,c).$$

A space that satisfies the conditional distance inequalities may have a zero or constant curvature or absolute curvatures that decrease with the distances to the common point, but its symmetrically isomorphic transformation with respect to the common point as transformation centre defines a space that satisfies the same conditional distance inequalities of corresponding space points. Therefore, we formulate:

Corollary 8: conditional structure invariance in symmetrically isomorphic spaces

If a space with a distinct point  $p'$  and quadrangle corner points  $(a',x',b',y')$  that satisfy for diagonals  $(x',y')$  and  $(a',b')$

$$\text{if } d(p',x') > d(p',a') > d(p',b') > d(p',y') \text{ then } d(x',y') > d(a',b')$$

is transformed with respect to point  $p'$  to a symmetrically isomorphic space wherein the conditional quaternary monotonicity axiom holds then the corresponding quadrangle corner points  $(a, x, b, y)$  also satisfy for  $p$  as corresponding point of  $p'$

$$d(p,x) > d(p,a) > d(p,b) > d(p,y) \text{ and } d(x,y) > d(a,b).$$

By replacing conditional distances in corollary 7 it follows that the conditional structure invariance holds not for asymmetrically isomorphic space transformations, but that some corresponding reference invariance for the conditionally binary space points is satisfied. The observed rank order for the conditional structure invariance of corollary 8 applies by corollaries 4 and 6 to preferences as single-peaked valence space distances to ideal points. The transformation of single-peaked valence spaces to comparable sensation spaces is symmetrically isomorphic, but their transformation to power-raised stimulus-fraction spaces is asymmetrically isomorphic by the exponential transformation of their comparable sensations. Although in symmetrically isomorphic sensation spaces the conditional structure invariance also holds, the distances to the ideal point in comparable sensation spaces differ in a monotone way from their corresponding distances in single peaked valence spaces. Except for open-hyperbolic, single-peaked valence spaces of hyperbolic sensation spaces, also the distance function in single-peaked valence spaces differs from the distance function in their comparable sensation spaces, because single-peaked valence spaces of flat sensation spaces are open Finsler spaces with variable curvatures. Since power-raised stimulus-fraction spaces are asymmetrically isomorphic spaces, the conditional reference invariance for distances to the ideal point as transformation centre holds no longer, according to definition 12. But a corresponding reference invariance for another function of conditionally binary space points may hold. For example, if  $d(g,a) > d(g,b)$  holds for distances to ideal point  $g$  then the preference  $a > b$  implies  $\exp(a/g) > \exp(b/g)$  as well as  $\exp(-a/g) > \exp(-b/g)$ . Therefore, if  $d(g,a) > d(g,b)$  holds then also a corresponding reference invariance  $\sinh(a/g) > \sinh(b/g)$  holds for Euclidean and hyperbolic stimulus spaces, while correspondingly  $\sin(a/g) > \sin(b/g)$  holds for double-elliptic stimulus spaces, but  $\sinh(a/g)$  and  $\sin(a/g)$  are again no distance function for  $(a,g)$  and  $(b,g)$ .

Since corollary 8 applies to preference rank orders that are represented by rank orders of distances to ideal points in single-peaked valence spaces, their conditional distance rank orders equivalently hold in their symmetrically isomorphic, Euclidean or hyperbolic spaces of comparable sensations. Thus, provided that the sensation space is not hyperbolic, individually weighted multidimensional unfolding solutions of preference data may correctly solve the Euclidean object configuration and the ideal point locations of individuals. In this way solved Euclidean spaces are not preference-strength spaces, but a common Euclidean sensation space with individual dimension weight and translation parameters that are determined by their ideal points. Otherwise the solved Euclidean sensation spaces are interval-scale spaces. According to the psychophysical valence theory the actual single-peaked preference geometry that corresponds to a Euclidean sensation space is an open Finsler geometry with absolute curvatures that reduce with increased distances to the ideal point, while also individually weighted, common object configurations are not identical to the object configurations in individual preference spaces. Thus, individually weighted sensation distances to ideal points represent not the individual preference strengths, which invalidates the usual interpretation of non-metric unfolding analyses.

Isomorphic transformations of zero or constant curvature spaces to respectively other constant or zero curvature spaces restrict the transformation functions, as formulated in the next corollary.

Corollary 9: permissible functions for isomorphic transformations of zero or constant curvature spaces to constant or zero curvature spaces

Isomorphic transformations of zero or constant curvature spaces to respectively constant or zero curvature spaces restrict the permissible functions for the space transformations to the logarithmic, arctangent, and hyperbolic tangent functions and their inverse functions as well as their geometrically compatible combinations.

Such geometrically compatible function combinations are restricted to either 1) the hyperbolic tangent or arctangent of logarithmic functions and their inverses (dimensional involutions and inverse involutions) or 2) products of reflected, hyperbolic tangent functions of translated, hyperbolic spaces, because other function combinations are mathematically incompatible or yield spaces with varying curvatures. Thus, corollary 9 implies definition 3 of our judgement- and preference-relevant functions of stimulus spaces (section 6.1.1.). In definition 3 we also considered dimensional products of reflected, hyperbolic or inverse tangent functions of distinctly weighted and translated, Euclidean sensation dimensions, where these dimensional products define open Finsler geometries for ~~single-peaked~~ valence spaces with absolute curvatures that decrease with increased distances to the ideal point.

In chapters one of this monograph, the symmetric, bipolar, and ogival function properties are derived as necessary properties of the response function. For the transformation of Euclidean or hyperbolic spaces of intensity-comparable sensations to open response spaces with a zero or constant curvature there exist indeed no other symmetric, bipolar and ogival response functions than the hyperbolic tangent and arctangent, because a zero or constant curvature is needed for the unconditional distance representation of transitively ordered dissimilarities. These response functions are defined by distinctly linear transformations of the logistic and Cauchy probability functions. This also implies that the logistic and Cauchy probability functions are the only probability functions of sensations that apply to discrimination probabilities. They also are the only probability functions that yield homogeneous probability measurements between unity and zero, because their probability spaces are linear transformations of open response spaces that have homogeneous dimension measurements between singular points. Thus, the earlier given citation from Luce (1992), wherein it is said that continuous probability fails to be homogeneous between the unit and zero probability, is not correct for the Cauchy and logistic probability functions. The logistic and Cauchy probability functions are the only probability functions that transform infinite spaces with a zero or constant curvature to open probability spaces with a constant or zero curvature. All other probability functions of infinite spaces define open probability spaces that have no constant curvature and, thereby, indeed fail to define homogeneous probabilities.

Distances as representation of transitive dissimilarity rank orders require spaces that satisfy the unconditional quadrangular monotonicity axiom, which implies that the geometry of dissimilarity response spaces must have a zero or constant curvature, while the arctangent and the hyperbolic tangent transform infinite sensation spaces to open response spaces with a distance metric that is conformal to the stimulus space. Given that the stimulus space has a zero or constant curvature, its space involution defines the response space geometry as an open space with a constant or zero curvature, while

transformations of response spaces to comparable sensation spaces define that the sensation geometries are infinite Euclidean or hyperbolic geometries. The stimulus space involutions to open response spaces also imply that both spaces have the same curvature and thus have conformational distance metrics. This not only is the mathematical result of chapters 3 and 4, but is also a psychological necessity, because isomorphism and conformational distance metrics of response and stimulus spaces have to be satisfied, otherwise behaviour hardly can be consistent with physical reality. We only need to specify the curvature of the stimulus geometry in order to have a determined curvature for the geometries for the infinite spaces of sensations and the open spaces of responses. The physical space is semi-definitely positive and in Newtonian physics its geometry is Euclidean, while relativistic physics implies a hyperbolic space-time geometry that contains a double-elliptic space for its optical subspace with an extremely large and expanding radius. We left it open whether the stimulus geometry is Euclidean, or double-elliptic, or hyperbolic. but the physical space of stimuli for human perception seems well described by Euclidean geometry. Therefore, we favour Euclidean stimulus geometry and thus also hyperbolic sensation and open-Euclidean response geometries. Moreover, this also yields a conformational distance metric for hyperbolic sensation and open-hyperbolic, single-peaked valence spaces, which conformational distance metric holds not for single-peaked valences with open Finsler geometries, while it seems required by consistency between cognition and preference.

Power-raised fraction scales in physics have dimensionless power exponents and dimensional unit points for their conventionally agreed measurement units become (0,1,I)-unique scales that are dimensionally invariant, as also are (1,0,I)-unique power-raised ratio scales in physics. Bower spaces of comparable sensations have individually solvable (instead of conventionally agreed) dimensional units and origins for its dimensions, where its dimensional translations and scale units are measurement parameters that are solved from relationships between a common sensation space and response or valence spaces of different individuals, as shown in chapters 4 and 5. Thereby, Bower space dimensions define also (0,2,0)-unique measurement spaces that are dimensionally invariant, as also follows from their invariance under linear transformation of the underlying, (2,0,0)-unique Fechner space dimensions. Exponential transformations of comparable sensations define then also «0,2,0)-unique, dimensional-invariant, power-raised stimulus fraction measurements, which explains why cross-modality matching defines a power-exponent relationship between stimulus modalities. In Luce and Galanter (1963b), Luce (1992), and FoM (ch. 6 and 10) it is discussed that matching of stimulus modalities requires a representation by power functions of ratio scales. Luce (1992, p.55) remarks that a power function of ratio scales for matched stimulus modalities is already postulated by himself in 1959 (Luce, 1959a) based on the *"principle of theory construction akin to dimensional invariance"*. Luce (1992) also refers to the Krantz-Shepard relation theory of cross-modality matching (Krantz, 1972; Shepard, 1978, 1981), wherein matching is defined as a ratio judgement of power functions for the matched stimulus intensities. Luce (1992) remarks that the Krantz-Shepard relation theory is obscured by the intervening role of *"an undetermined monoronic transformation"* in the matching of stimulus modalities and that it seems *"too strong in its supposition that there are implicit standards"*.

Nonetheless, we determined that monotonic transformation by an equality weighing of logarithmic stimulus fractions as weighted sensation differences from adaptation level, where the weights and translations define implicit standards of individuals. On several places we have shown that Stevens' power exponents derive from the exponential transformation of comparably weighted sensation space dimensions with the adaptation level as common origin. In chapter 2 we derived that Stevens' power exponents are dimensional sensation weights defined by twice the inverse of the dimensional distance between the adaptation and just-noticeable level in the logarithmically transformed stimulus space, while the dimensional adaptation-level parameters also determine the translations of sensation dimensions. In chapter 3 we showed that the seemingly inconsistent psychophysics of Fechner and Stevens are consistent representation of the same in different geometries, where if Stevens' subjective stimulus magnitudes are represented by a power-raised Euclidean stimulus space then their corresponding sensation space is hyperbolic and if represented by a power-raised non-Euclidean space then the corresponding sensation space is flat. The correspondence between power-raised stimulus fraction and intensity-comparable sensation dimensions imply indeed *"that there are implicit standards"* for the power-raised stimulus fraction and comparable sensation dimensions, as defined by

- standards for fraction scales with stimulus adaptation points as unit points;
  - Standards for power exponents as weights of intensity-comparable sensations defined by twice the inverse of the adaptation levels on Fechner sensation scales.
- In chapters 2 and 3 we identified power exponents as  $\tau = 2/a = 2J/\ln(b/u)$ , where adaptation level  $a = \ln(b/d) - \ln(u/J) > 0$  is defined by the constant distance between the just noticeable sensation level  $\ln(u/J) = 0$  as origin of a Fechnerian space dimension and the adaptation level  $\ln(b/J) = a$  as sensation midpoint of the employed stimulus range. Since power exponent  $\tau$  of a modality is constant for a wide midrange of its stimuli, while Helson's adaptation level  $\ln(b/J)$  may vary, we define  $\ln(u/\mu) = 0$  not as Fechner's absolute level of the just noticeable sensation, but define  $\ln(u/J)$  as a just noticeable sensation level that depends on the adaptation level  $\ln(b/\mu)$  as midpoint of the sensation range of employed stimuli. Whether this dependence indeed always yields a constant sensation distance  $a = \ln(b/u)$  is further discussed in section 6.3.1. In chapters 1 and 2 we discussed differences between individual adaptation levels for cognitive stimuli and its stimulus-dependent variability for selectively presented stimuli to an individual, while in chapter 7 we explicitly discuss the consequences of stimulus-dependent variability of adaptation levels for multidimensional space analyses. But here, as in chapters 3 to 5, we assume a random stimulus exposure within a constant context that defines the adaptation point to be a constant sensation distance  $a = \ln(b/u)$  between the adaptation point and the just noticeable sensation.

Open response space dimensions

$$\text{or } r_{ik} = \tanh[\tau \ln(x_{ik}/b_k)] = \tanh(Y_{ik}/a_k - I)$$

$$r_{ik} = \arctan[\tau \ln(x_{ik}/b_k)] = \arctan[2(y_{ik}/a_k - 1)]$$

for stimulus dimension  $x_{ik}$  with Fechner sensations  $Y_{ik}$  define homogeneous response measurements between singular points. The homogeneous measurements of response spaces are (0,2,1)-unique, because not only symmetrically isomorphic to the (0,2,0)-

unique Bower space, but also limited by oppositely signed singular points of an equal absolute value for their maximum of  $I$  or  $1/2\pi$  and minimum of  $-I$  or  $-1/2\pi$  that correspond respectively to infinitely positive and negative sensations. It defines a measurement-theoretically new scale type, because defined by (0,2,1)-unique and homogeneous measurements between singular positive and negative points with equal absolute value of the open response spaces with a zero curvature (if open-Euclidean) or with unit curvature (if single-elliptic) or with a curvature of minus unity (if open-hyperbolic). The three permissible response geometries derive from the three alternatives for the stimulus geometries (Euclidean, double-elliptic or hyperbolic) and their two unique alternatives for the metric response functions (the hyperbolic or inverse tangent) that define isomorphic transformations of stimulus spaces to open response spaces with conformal distance metrics. All these results correspondingly hold also for ideal response space axes that define (0,2,1)-unique scales for monotone valences. We define explicitly:

Corollary 10: (0,2,1)-uniqueness of response and monotone valence measurements  
 Open-Euclidean, or open-hyperbolic, or single-elliptic geometries are the only three permissible geometries for (0,2,1)-unique measurement dimensions of responses or monotone valences, where the dimensional parameters are defined by individually distinct adaptation and just noticeable sensation space points and the dimensionless parameter of the singular value for the response space boundary.

The analyses of individual response space distances as representations of dissimilarities or the analyses of individual ideal response axes as representations of preferences with monotone valences, described respectively in chapter 4 and 5, determine individually (0,2,1)-unique measurement spaces, the dimensional measurement parameters of individuals, and the underlying object configuration in a common Euclidean stimulus or sensation space. For comparison of our response and monotone valence measurements with axiomatic measurement theory, we again cite Luce (1992) where he closes his discussion on psychological measurement by writing:

*"I consider the work done to date to be just a beginning of research on ratio scale theories of utility. We have explored only those ratio theories that involve a heavy dose of averaging, but <> a large family of nonadditive, nonaveraging possibilities exists. Little is known about axiomatizing specific members of that family, but the need to restrict possibilities certainly invites the formulation of new behavioral axioms. Additional general theory about nonhomogeneous outcomes, especially those that are homogeneous between singular outcomes, is needed as input to these more psychological applications."*

What Luce here describes as "ratio scale theories of utility" are ratio-scale theories for monotone valences. In section 6.1.3. we discussed the more recent specification of Luce's axiomatic measurement for novel equivalence structures between pairs of valued goods, whereby Luce (2000) obtained an inferred-extensive utility measurement for gains and losses separately. We compared Luce's inferred-extensive utility measurement with the measurement-theoretical implication of our response dimensions with identical implications for monotone valences as utility measurements, because described by ideal response space axis (sections 5.2 and 5.5.2.). Our psychophysical

response theory incorporates all what is needed for a (0,2,1)-unique, transformed-extensive preference measurement of object dimensions with monotone valence functions. Thus, ideal response axes that correspond to power-raised stimulus-fraction dimensions define our "ratio scale theories of utility", but these ideal response space axes are measurement representations of utility in open-hyperbolic, or open-Euclidean, or single-elliptic response spaces. Thereby, our theory provides the required

*"additional general theory about nonhomogeneous outcomes <> that are homogeneous between singular outcomes"*

for utility measurement. Our utility is measured by the ideal response axis with a distinct zero utility for the status quo as adaptation point and homogeneous measurements between its singular maximum and minimum. Luce's (1995, 2(00)) axiomatisation of rank- and sign-dependent utility yields an inferred-extensive measurement for the prospect theory (Kahneman and Tversky, 1979; Tversky and Kahneman, 1986, 1992). Rank- and sign-dependent utility modifies the earlier discussed dual-bilinear utility model that also yields larger utility losses than gains for objectively equal losses and gains with respect to a distinct zero utility as the status quo. But the dual-bilinear or the rank- and sign-dependent measurement models define utility still by at least one arbitrary parameter and a distinct point or also a distinct limit value. These utility measurements are either (2,1,0)-unique (two arbitrary parameters and a distinct demarcation point in the dual-bilinear model) or (1,1,1)-unique (one arbitrary unit parameter for the ratio-scale values of valued goods, one dimensional parameter for the status-quo level, and one dimensionless parameter for utility loss or gain limits in the rank- and sign-dependent model). Thus, their measurement levels are weaker than our (0,2,1)-unique scale for monotone valences as ideal response space axis or our (0,1,1)-unique scale for utility of valued goods (where  $\tau = 1$  applies by the equality of cognitive magnitude sensations and value sensations of valued goods). What our monotone valence theory further implies for subjective expected gamble utility will be discussed in section 7.3.

As described in sections 5.2. and 5.4.3 single-peaked valences are defined by open-hyperbolic spaces with curvature  $-Y^2$  or open Finsler spaces with absolute curvatures that decrease with the distance to the ideal point. The dimensionless valence maximum of the ideal point and the singular minimum of the boundary for the single-peaked valence space determine, together with the (0,2,0)-unique scales of their underlying valence-comparable sensations - the (0,2,2)-uniqueness of single-peaked valence scales. Their four non-arbitrary measurement parameters are the two distinctly solvable dimensional values for the adaptation and ideal sensation levels in the specification of valence-comparable sensations that by their transformation to a single-peaked valence space additionally define a dimensionless maximum space valence and a singular minimum valence for its space boundary as the two, a priori specified, other dimensionless parameters for single-peaked valence measurements. Notice that open Finsler geometries of single-peaked valence spaces are defined by products of homogeneous measurement spaces of covariant valence curvatures and curvature-corrected valences as quasi-response spaces of reflected and distinctly translated Bower sensation spaces, whereby their single-peaked valence measurements are dual-homogeneous between a dimensionless maximum and a singular minimum. The



indifference circles in single-peaked valence spaces define reflected zero points on dual-homogeneous or homogeneous valence dimensions with respect to the ideal point with a maximum valence that differs from the reflected minimum limit for the single-peaked valence space. Therefore, single-peaked valences define new scale types of homogeneous (if open-hyperbolic) or dual-homogeneous (if open Finslerian) and  $\{O,2,2\}$ -unique measurements between a negative minimum and positive maximum. Single-peaked valence spaces are symmetrically isomorphic transformations of dimensionally invariant, valence-comparable sensation spaces, whereby also single-peaked valences define dimensionally invariant measurements. As described in sections 5.2 and 5.4.3. the absolute curvatures of open Finsler geometries for single-peaked valences of Euclidean comparable sensation spaces decrease with the distances to the ideal point, which curvatures are either negative (for hyperbolic tangent-based valences) or positive (for arctangent-based valences), while single-peaked valence transformations of comparable, hyperbolic sensation spaces specify an open-hyperbolic geometry of single-peaked valences. We summarise these aspects by

**Corollary 11:  $\{O,2,2\}$ -uniqueness of single-peaked valence measurements**

The geometry of the single-peaked valence space is either an open-hyperbolic geometry with curvature  $-1/2$  or an open Finsler geometry with absolute curvatures that decrease with the distance to the ideal point. Due to the dimensionless valence maximum that differs from the absolute value of their negative space limit, single-peaked valences depend on one dimensionless parameter more than response measurements, whereby their single-peaked valences define  $\{O,2,2\}$ -unique scales.

Since open single-peaked valence spaces are metrically isomorphic to dimensionally invariant Bower spaces, also single-peaked valence measurements are dimensionally invariant. Thus, subjective stimulus magnitudes as power-raised stimulus fractions, comparable sensations, responses, monotone valences, and lastly single-peaked valences all allow meaningful quantitative relationships, but their respectively  $\{O,2,0\}$ -,  $\{O,2,1\}$ -, and  $\{O,2,2\}$ -unique scales individually depend on two dimensional parameters and collectively depend respectively on zero, one or two dimensionless space parameters. Only if the individual measurement parameters are distinctly solved and taken into account then also meaningful relationships between dimensional measurements of different individuals are possible. Apart from this parametric measurement condition, the main problem is the absence of geometric uniqueness. Nonetheless, for each of the permissible geometries for responses or single-peaked valences one may in principle formulate metrically unique relationships between binary point values, which could determine by empirical evidence for only one formulation the unique geometry. This might be possible if individual data on sufficiently precise similarity (categorisation, confusion) or preference probabilities are gathered and appropriately analysed as function of metric response or valence spaces, which is further discussed in chapter 7. However, for appropriate analysis results from ordered dissimilarity or preference observations. such decisive evidence might hardly be obtainable, due to the ordinal level of the fitted data

### 6.2.2. *Measurement as by-product of substantive theory*

As cited earlier from Luce (1992) "*restrictions on the many possibilities of nonadditive structures for measurement in the behavioural sciences must be formulated*". Such restrictions are obtained from the permissible alternatives for isomorphic space transformations of stimulus spaces to response or valence spaces. In order to obtain meaningful measurements from isomorphic space transformations one firstly has to define some permissible geometry of the stimulus space and secondly one has to define restrictions that are imposed on the possible space transformation from stimulus spaces to sensation space and from sensation spaces to response and monotone preference spaces or to single-peaked valence spaces. The restrictions need to be guided by empirically validated research and theories on judgement and preference and then may lead to permissible geometries for measurement representations of responses and preferences by the derived, isomorphic transformations of stimulus spaces. We have derived the necessary and sufficient restrictions for the isomorphic space transformations of ratio-scale stimulus spaces with the physically permissible, Euclidean or hyperbolic, or double-elliptic geometries from a consistent integration of substantive theories that are to a considerable extent validated by research. The empirical research and substantive theories for the unidimensional restrictions of the isomorphic transformation functions are discussed in chapters 1 and 2. In chapter 2 the transformation of stimuli to sensations is shown to be Fechnerian, where based on function properties from chapter 1 and mathematical response theory we derived the hyperbolic tangent function and in section 4.2. also the arctangent function for multidimensional transformations of dimensionally comparable sensation spaces to open response spaces. In chapter 3 we showed that logarithmic transformations of Euclidean or non-Euclidean stimulus spaces yield respectively hyperbolic or flat, comparable sensation spaces and in chapter 4 that the isomorphic transformations of these infinite sensation spaces yield open individual response spaces with a Euclidean, elliptic or hyperbolic metric. Since individually transitive rank orders of dissimilarities are represented by unconditional distance orderings, the isomorphic transformations of sensation to response spaces must be transformations to the constant or zero curvature spaces of responses that satisfy the quadrangular monotonicity axiom. Thereby, transformations of sensation spaces indeed only can be hyperbolic or inverse tangent transformations to open-Euclidean, or open-hyperbolic, or single-elliptic response spaces. In chapter 5, based on chapters 2 and 3 and section 4.2, the psychophysical valence theory and analysis methods of preferences for multidimensional objects are described, where object spaces with monotone valence attributes define preferences to be measured by unidimensional ideal axes in individual response spaces (section 5.1). Preference measurements of objects with single-peaked valence attributes are defined by open, individual valence spaces with a maximum valence point and a constant curvature  $\zeta = -1/r$  or absolute curvatures that decrease with the distance to the ideal point, which spaces are symmetrically isomorphic transformations of valence-comparable sensation spaces with individual ideal points as origins and transformation centres (section 5.2.).

An axiomatisation of response and valence measurements becomes a mathematical exercise based on what chapters 2 to 5 yield as by-products:

- (O,2,O)-unique and homogeneous measurements of Bower spaces for comparable sensations that are dimensionally invariant by invariance under linear transformations of underlying logarithmic dimensions of Euclidean or non-Euclidean stimulus spaces with ratio-scale measurements;
- (O,1,O)-unique and nonhomogeneous measurements of power-raised stimulus fraction spaces for subjective stimulus magnitudes, defined by the asymmetrically isomorphic, exponential transformation of Bower space dimensions;
- (O,2,1)-unique and homogeneous measurements between singular, positive and negative, absolute-equal points of individual response spaces or monotone valence axes, defined by symmetrically isomorphic projections of Bower space dimensions;
- (O,2,2)-unique and homogeneous or dual-homogeneous measurement spaces of individual, single-peaked valences between a singular minimum and a dimensionless maximum, defined by symmetrically isomorphic distance transformations with respect to the ideal point (as multiplied quasi-responses of translated and reflected Bower space dimensions).

Since Bower space dimensions define dimensionally invariant sensation measurements, their metrically isomorphic transformations define also dimensionally invariant measurement spaces of subjective stimulus magnitudes, responses, and monotone or single-peaked valences. It yields the sufficient and necessary conditions that guarantee the meaningfulness of quantitative relationships in psychological theory.

An axiomatic account of response measurements might be guided by the psychophysical response theory, but need not to be based on knowledge of our theory. It also may be derived from a generalisation of Luce's (2000) inferred-extensive measurements of utility, where the required generalisation is indicated in section 6.1.3. However, one hardly could formulate measurement axioms for single-peaked valences without the guidance of the psychophysical valence theory. For an axiomatisation of responses to multidimensional stimuli we have to take responses as functions of intensity-comparable sensation dimensions, because the weighted Fechner-Helson dimensions with respect to individual adaptation points are the sensory representations of dimensionally comparable stimulus magnitudes. A Fechnerian sensation space can have a central dilation factor  $\zeta$  (if flat) or a negative curvature  $-\zeta$  (if hyperbolic), but the isomorphic transformation of flat, comparable sensations spaces to single-elliptic response spaces by the inverse tangent function defines

$$\arctan\{2\zeta \cdot \ln(x/b) / [\zeta \cdot \ln(b/u)]\} = \arctan\{2 \ln(x/b) / \ln(b/u)\},$$

which is independent of scale factor  $\zeta$ . Independence of central dilation factor or hyperbolic curvature also holds for the isomorphic transformation of intensity-comparable, flat or hyperbolic sensation spaces to open-hyperbolic or respectively open-Euclidean response space by the hyperbolic tangent function, as defined by

$$\tanh\{[\zeta \cdot \ln(x/b)] / [\zeta \cdot \ln(b/u)]\} = \tanh\{\ln(x/b) / \ln(b/u)\}.$$

The three non-axiomatised geometric assumptions for the multidimensional measurement representations of (dis)similarity rank orders are:

1. transitive dissimilarity orders are represented by distances in open response spaces;
2. the stimulus space geometry is Euclidean, or hyperbolic, or double-elliptic;

3. the function that transforms a common stimulus space to individual response spaces is a symmetric, bipolar, S-shaped function of logarithmic stimulus spaces that are dimensionally weighted and translated for their sensation comparability.

These non-axiomatised assumptions define by assumption 1 that individual response spaces are spaces with a zero or constant curvature, because otherwise response spaces can't satisfy the quadrangular distance axiom as required by distance representations of transitively ordered dissimilarities. From assumptions 2 and 3 it follows that no other symmetric, bipolar, S-shaped function than the hyperbolic tangent or arctangent function can transform comparable sensation spaces with a zero or hyperbolic curvature (as follows from the logarithmic transformation of Euclidean or non-Euclidean stimulus spaces, see chapter 3) to open response spaces with a constant or zero curvature. By assumptions 1, 2, and 3 it also follows that (quasi-)involutions transform power-raised stimulus fraction spaces to open, individual response spaces with the same distance metric as their (not power-raised) stimulus fraction spaces with a zero or constant curvature. Thereby, the individual response spaces are either open-Euclidean, or open-hyperbolic, or single-elliptic spaces that define (0, 2, 1)-unique, homogeneous response measurements between singular points. Up to now these response measurements are not axiomatised, but axioms for a response-distance structure of dissimilarities

$$\text{must satisfy } |r_i \ominus r_j| > |r_k \ominus r_l|$$

$$|r_i \otimes r_j| = h(r_i - r_j) = h[\tau \ln(x_i/b) - \tau \ln(x_j/b)]$$

where in open-Euclidean spaces  $h(r) = |r|$  and in open-hyperbolic spaces  $h(r) = \cosh(r)$  both with  $\text{res} = \tanh(Y)$ , while in single-elliptic spaces  $h(r) = \cos(r)$  with the function  $\text{res} = \arctan(s)$ , and where in all cases  $f(x) = \tau \cdot \ln(x/b)$  with  $\tau = 2/a = 2/\ln(b/u)$  for distinct sensation distance  $\ln(b/u)$  between stimulus adaptation level  $b/u$  and just noticeable stimulus level  $u/\mu$ . For open-Euclidean response space of hyperbolic sensation spaces it defines

$$|r_i \ominus r_j| = |r_i - r_j| = |\tanh(y_i/a - 1) - \tanh(y_j/a - 1)|$$

and in involution terms of a corresponding Euclidean stimulus space

$$|r_i \otimes r_j| = |r_i - r_j| = |1 - (x_i/b)^\tau| |1 + (x_i/b)^\tau| - |1 - (x_j/b)^\tau| |1 + (x_j/b)^\tau|$$

For open-hyperbolic response spaces with Euclidean sensation and hyperbolic stimulus spaces we correspondingly define

$$|r_i \ominus r_j| = \cosh(r_i - r_j) = \cosh[\tanh(y_i/a - 1) - \tanh(y_j/a - 1)],$$

and

$$|r_i \otimes r_j| = \cosh\{ |1 - (x_i/b)^\tau| |1 + (x_i/b)^\tau| - |1 - (x_j/b)^\tau| |1 + (x_j/b)^\tau| \}$$

while for single-elliptic response space with Euclidean sensation and double-elliptic stimulus spaces we correspondingly represent dissimilarities by

$$|r_i \ominus r_j| = \cos(r_i - r_j) = \cos\{\arctan[2(y_i/a - 1)] - \arctan[2(y_j/a - 1)]\},$$

which in quasi-involution terms for a double-elliptic stimulus space remains to be written by

$$|r_i \otimes r_j| = \cos(r_i - r_j) = \cos\{\arctan[\tau \cdot \ln(x_i/b)] - \arctan[\tau \cdot \ln(x_j/b)]\}.$$

For hyperbolic spaces of comparable sensations that correspond to open-Euclidean response spaces a sensation  $s_f$  as hyperbolic addition of sensations  $s_i$  and  $s_j$  is defined

$$s_f = (s_i + s_j) / (1 + \zeta \cdot s_i \cdot s_j)$$

where  $\zeta = -1$  is the curvature of the comparable sensation space. because curvature-dependent Fechner-Helson sensations  $\zeta(y_i - a)$  are weighted by twice the inverse of curvature-dependent sensation distance  $2/(\zeta \cdot a)$  to curvature-independent comparable sensations  $s_i$ :  $2\zeta(y_i - a)/(\zeta \cdot a) = 2(y_i - a)/a$ . Thereby, response  $r_f = \text{taOO}(Y2s_f)$  represents a response to a joint presentation of stimuli  $i$  and  $j$  in one integrated stimulus display, such as black and white pie parts of one circular disc, where

$$r_f = \text{taOO}[\text{artanh}(r_i) + \text{artanh}(r_j)] / (1 + \text{ar taOO}(r_i) \cdot \text{ar tanh}(r_j))$$

For Euclidean spaces of comparable sensations  $s_f = s_i + s_j$ , whereby the hyperbolic tangent function as response function defines open-hyperbolic response dimensions and

$$r_f = \text{tanh}[Y2(s_i + s_j)] = \text{tanh}[\text{ar tanh}(r_i) + \text{ar tanh}(r_j)] = (r_i + r_j) / (1 + r_i \cdot r_j),$$

while response function  $r_f = \text{arctan}(s_f)$  defines single-elliptic response dimensions and

$$r_f = \text{arctan}[s_i + s_j] = \text{arctan}[(\tan(r_i) + \tan(r_j))].$$

Axioms for qualitative magnitude equivalences  $(x_i, x_i) \approx (x_j, x_j)$  for jointly presented, unidimensional stimulus pairs then have to describe metric equality  $r_i \oplus r_j = r_i \oplus r_j$  as defined by one of the above expressions. which for alternative  $r_i \oplus r_j$

$$r_i \oplus r_j = \text{tanh}[\text{ar tanh}(r_i) + \text{ar tanh}(r_j)] = (r_i + r_j) / (1 + r_i \cdot r_j)$$

might be based on a generalisation of Luce's axioms for equivalence structures for joint receipts of valued goods, as indicated in section 6.1.3. Notice also that the measurement of relativistic velocity with  $c$  as velocity of light is defined for  $\mathcal{L}(z) = \text{tanh}(z)$  by

$$x_i \oplus x_j = \mathcal{L}[\mathcal{L}^{-1}(x_i) + \mathcal{L}^{-1}(x_j)] = (x_i + x_j) / (1 + x_i \cdot x_j / c^2),$$

since  $\text{artanh}(x) = z$  defines  $\text{tanh}[z + z] = [\text{taOO}(z) + \text{tanh}(z)] / [1 + \text{taOO}(z) \cdot \text{taOO}(z)]$ . This is the example of non-associative structures for extensive measurements with an essential maximum in FoM (ch. 3, sections 3.7. and 3.9), where in section 3.7 (p. 95) it is remarked that function  $\mathcal{L}^{-1}$  in  $x_i \oplus x_j = \mathcal{L}[\mathcal{L}^{-1}(x_i) + \mathcal{L}^{-1}(x_j)]$  need not to be the inverse hyperbolic tangent function and that it is unknown "how to axiomatize that specific result in any natural way using the present primitives". Without assuming a geometry of the measurement space the expression indeed defines no unique function  $\mathcal{L}$ . because other strictly monotone functions may not define

$$x_i \oplus x_j = (x_i + x_j) / (1 + x_i \cdot x_j / c^2).$$

However, the geometry of relativistic velocity is given by its hyperbolic time-space geometry with constancy  $Elm = c^2$  for squared velocity of light. The difference with open-hyperbolic response spaces is that physical observations for relativistic velocity directly relate to extensive Newtonian measurements of length and time measurements by their Lorentz transformations, where the transformation of hyperbolic stimuli to open-hyperbolic responses is mediated by flat comparable sensation spaces that

correspond to distinctly power-raised stimulus fraction spaces. The hyperbolic space-time geometry of relativistic physics is empirically verified by Lorenz transformations of the extensive measurements of Newton's Euclidean space, but the geometry of response spaces is not uniquely determined, although restricted to open spaces with a zero or constant curvature by the property requirements for the response function and the structure-invariant geometry that can represent transitively ordered dissimilarities.

Empirical evidence for one of the geometry-dependent alternatives for the relationship between responses and extensive stimulus measurements may specify "the new behavioural axiom" that Luce (1992), as cited in earlier, was searching for his "homogeneous measurement between singular points". We quote from FoM (ch. 3, p. 102), where with respect to additive and nonadditive structures for extensive measurement representations it is remarked that:

*"the additive representation is just one of the infinitely many, equally adequate representations that are generated by the family of strictly monotonic increasing functions from the reals to the positive reals. The essential fact about the uniqueness of a representation is not the group of admissible transformations, but that all groups are isomorphic and, in the case of extensive measurement, are all one-parameter groups; that is there is exactly one degree of freedom in any particular representation."*

It will be clear that extensive fraction measurement in physics uses that one degree of freedom for the conventionally agreed measurement unit, while multiplicative relationships between their dimensionally invariant measurements define physical measurements with dimensionless power exponents. The inverse space involutions of response to power-raised stimulus-fraction spaces distinctly define dimensional adaptation points  $x_k/b_k = 1$  and just noticeable points  $x_k/u_k = 1$  that also determine the dimensional power exponents by  $r_k = 2/\ln(b_k/u_k)$ . An axiomatisation of response measurements may require non-associative operators as well as symmetric, but finite concatenations for negatively and positively signed responses with respect to the zero response point of adaptation level. Such an axiomatic result should then define our isomorphic space transformations of power-raised stimulus-fraction spaces that correspond to the Bower spaces of intensity-comparable sensations. The dimensional invariance property of Bower spaces with dimensionally distinct parameters defines by their isomorphic space transformations to response spaces that individual response measurements not only are homogeneous between singular points, but also have the property of dimensional invariance. A measurement axiomatisation for open response spaces may also be derivable by functional equation methods similar to the axiomatic measurement derivations for probability spaces (FoM: ch.5) and then for probability spaces that satisfy the triangular distance inequalities for response probability spaces, which only is satisfied for the logistic and Cauchy probability spaces. The linear transformations of these probability spaces to open response spaces by  $2 \cdot p - 1 = r$  for the logistic probability function or alternatively by  $\pi \cdot p - \frac{1}{2}\pi = r$  for the Cauchy probability function then yield the three alternatives for open response spaces that have the same distances metric as their corresponding Euclidean or non-Euclidean stimulus spaces. The axiomatisation of monotone preferences would follow from axioms similar to axioms for response measurements, because defined by ideal response axes.

Since single-peaked valence spaces are defined by corresponding products of quasi-response transonnations of translated and reflected Bower spaces of valence-comparable sensations, also the three geometries of single-peaked valences are defined by the three open response geometries. An axiomatisation of single-peaked preference measurements likely is most simply based on the above indicated axiomatisation of response measurements and an axiom that guarantees single-peaked valences to be equal to the product of corresponding values in the two quasi-response spaces. Such axioms are to be deduced from the psychophysical valence theory, because hardly derivable otherwise. By  $d = \frac{1}{V} \ln(\frac{b}{a})$  as sensation distance between the adaptation and ideal points and  $d_i = \frac{1}{V} \ln(\frac{x_i}{p_i})$  as distance between the sensation for object  $i$  and individual ideal points  $p_i$ , the transformation functions of valence-comparable sensations to single-peaked preferences are defined in three alternative ways:

1. either for single-peaked valences of hyperbolic or Euclidean stimulus spaces by

$$v_i = \tanh[V2(1 - d_i)] \cdot \tanh[V2(1 + d_i)] = \tanh[-V2 \ln \{ \cosh(d_i) \cosh(1) \}],$$

2. or for single-peaked valences of double-elliptic stimulus spaces by

$$v_i = \arctan(1 - d_i) \cdot \arctan(1 + d_i),$$

where  $d, d_i$  are distances to the ideal point in valence-comparable, Euclidean sensation spaces that correspond to non-Euclidean stimulus spaces, while  $\cosh(d, d_i)$  inherently are hyperbolic distances to the ideal point in valence-comparable, hyperbolic sensation spaces that correspond to Euclidean stimulus spaces.

The individual dimensional or space-dependent, dimensionless maximum valence  $v_{max}$ , defined by  $v_i$  for  $d_i = 0$ , differs in absolute value from singular minimum  $v_{min}$ , defined by  $v_i$  for infinite sensation distance  $d_i$ , whereby single-peaked valence scales are (0,2,2)-unique. The two non-axiomatised assumptions for the measurement of single-peaked preferences, additional to the non-axiomatised assumptions for responses, are

- conditional preference orders of objects are represented by distances to ideal points in single-peaked valences spaces;
- individual, single-peaked valence spaces are defined by multiplication of correspondingly rotated quasi-response dimensions for valence-curvatures and curvature-corrected valences as dimensional projections of reflected and distinctly translated Bower sensation spaces.

The properties of multiplicativity, reflection, and origin distance for two symmetric, bipolar, ogival functions of sensations that define the single-peaked valence function are derived from learning, motivation, and neurophysiological research in chapter 1, where the bipolar, ogival function equals the response function. Due to the conditional distance representation of preferences for objects with single peaked valences, the geometry for conditional distance representations requires that the conditionally quaternary distance axiom is satisfied. Single-peaked valence spaces indeed satisfy this axiom, either by their open finsler spaces with absolute curvatures that decrease with increasing distances from the ideal point, if the sensation space is flat, or by their open-hyperbolic spaces, if the sensation space is hyperbolic. However, as discussed in chapter 5, also representations in individually weighted spaces of the common Euclidean or hyperbolic sensations space satisfies this axiom, but object distances to ideal points in individually weighted sensation spaces reflect not the actual preference

strengths of individuals for the correctly solved object configuration in the common sensation space. The response and single-peaked valence measurement spaces and the individual measurement parameters are solved by the methods described in chapters 4 and 5. Thereby, a measurement axiomatisation of responses or single-peaked valences is not needed, because response or single-peaked valence spaces define transformed-extensive measurements by their isomorphic transformed stimulus measurements.

### 6.2.3. Measurement aspects of the psychophysical response function

Since sensations are not observable aspects of behaviour, we can't specify measurement structures with an observable rank order of conjoint sensation component outcomes, but only measurement structures for an observable rank order of psychophysical responses. Therefore, one could even omit the concept of covert sensations as something that can't be measured in any reference-invariant way. However, the logarithmic transformation of stimulus intensities follows also from the so-called wave theory (Link, 1992a,b) for the peripheral excitation and further transmission of nerve cell potentials, which by the modern electro-neurophysiological techniques of nerve potential measurements are nowadays observable processes. Sensation differences from the adaptation level can then be regarded as the result of the observable, neurophysiological signal transmission from externally excited receptors to peripheral nerve-cell potentials with adapted excitation levels with their subsequent signal-transmission frequency via nerve fibres to the brain. Comparably weighted sensations then might represent the neurophysiological input and transmission processes of the modality-specific sense organs to their brain centres. Their association with mediating, cognitive or affective response sensations then would relate to the signal throughput in the brain wherein the signal processing becomes facilitated or inhibited by reinforcement-based learning of reward or aversion expectancies of anticipatory response sensations. The signal-output trajectories from the central brain to peripheral nerve cell potentials of the motoric effector responses then would relate to the co-ordinated muscular actions of cognitive responses and affective preferences, such as spoken or written words for judgmental responses and preferential choice realisations. The whole signal-transmission process from stimuli to judgmental or preferential responses could then on a macroscopic level be described by the multidimensional transformations of stimulus to response or valence spaces. These space transformations would then correspond to adaptively modified signal throughput processes that determine the judgmental and preferential responses that are also recurrently influenced by congenital and learning-based, affective facilitation or inhibition of the signal throughput in the central brain. *Nonetheless, sensations are still not observable.* Our extensive-transformed measurement structures can only be verified by analyses of rank orders of observed responses to stimuli or stimulus pairs or by analyses of observed preference rank orders for objects.

We called  $\psi(x./b) = 2[\ln(x./b)/a]$  with  $a = \ln(b/u)$  the psychophysical function, but the observable function is a *psychometric response function* that describes the transformation of stimuli to magnitude responses and not the transformation of stimuli to sensations or subjective stimulus magnitudes. If we omit for simplicity of descriptions the arctangent as response function then the *psychometric* function is the hyperbolic involution of power-raised fraction stimuli  $(x./b)^{2/a}$  with respect to stimulus



$x_i/b = 1$ , whereby the psychometric response function  $f(x_i/b) = r_i$  writes as

$$f(x_i/b) = r_i = \frac{\tanh(\ln(x_i/b)/a)}{1} = \frac{(x_i/b)^{2/a} - 1}{(x_i/b)^{2/a} + 1}$$

It differs from the psychophysical function, but the values of  $r_i$  and  $\ln(x_i/b)/a$  are almost identical for wide ranges of  $x_i/b$  around  $x_i/b = 1$ , as figure 37 shows.

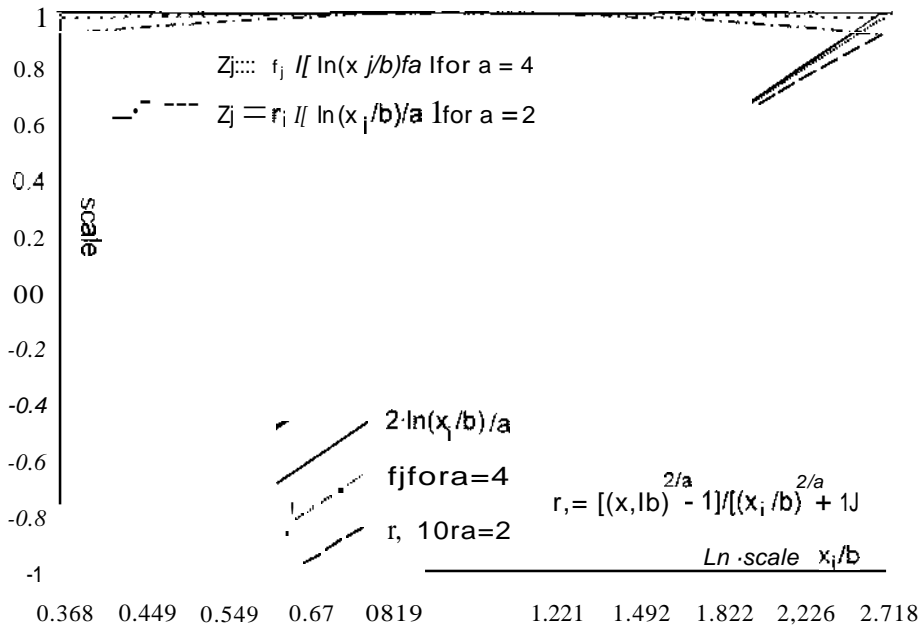

Figure 37. Relationships between responses and comparable sensations (for  $a = 2$  and  $a = 4$ ) with their ratios for fraction scale  $\exp(-1) < x_i/b < \exp(1)$

In the figure above we plotted intensity-comparable sensations  $2\ln(x_i/b)/a$ , their responses  $r_i$ , and ratios  $z_i = r_i / [\ln(x_i/b)/a]$  for adaptation level values  $a = 2$  and  $a = 4$  within range  $\exp(-1) < x_i/b < \exp(1)$ , where ratio  $z_i = a \cdot r_i / \ln(x_i/b)$  almost equal unity for that range of  $x_i/b$  around adapted level  $x_i/b = 1$ . The ratios  $z_i$  equal unity the better the smaller power exponent  $\tau = 2/a$  is, whereby  $r_i = \ln(x_i/b)/a$  almost holds. Just noticeable increases by Weber's (1834) fraction  $K$  of adapted stimuli  $x_i/b = 1$  concern not subjective magnitude estimations and, thus, have no sensation weights, whereby

$$r_i(x_i/b=1; K) = \tanh[\ln(1 + K)] = z_i \cdot \ln(1 + K).$$

All Weber fractions satisfy  $K < 0.2$  (Laming, 1986), while Weber fractions are just noticeable increases from adapted stimulus levels  $x_i/b = 1$ . For Weber fractions  $\kappa < 0.2$  the ratio

$$1 > \tanh[\ln(1 + K)] / \ln(1 + K) = z_i > 0.997$$

Thus, a scaling by just noticeable stimulus increases cannot only yield the psychophysical function as logarithmic function of stimulus values, but almost equally well also the psychometric response function as hyperbolic tangent function of

logarithmic stimulus values. Other methods of psychophysical scaling, such as the method of equal appearing intervals or Stevens' fractionation method are not based on just noticeable stimulus differences. However, the ordered category scaling with equal appearing intervals has shown median category values that are log-linear functions of stimulus intensities (despite the theoretically questionable method), but with large individual variances. Stevens' fractionation method yields also large individual deviations (even up to 40%) from median subjective stimulus magnitudes and, thus, their logarithmic scales too. In view of the variability in the individual data and the limited stimulus intensity ranges of human perception, psychophysical scaling methods hardly can discriminate between psychophysical function as weighted logarithmic function of stimulus values and the psychometric response function as hyperbolic tangent function of logarithmic stimulus values. This is why in chapters 2 and 3 we also could treat the logarithmic transformation of Stevens' power-raised stimulus fraction scales as intensity-comparable sensation dimensions. However, Stevens' power-raised stimulus fraction scales actually are magnitude-matching responses to comparably weighted sensations, because only responses and not sensations are observable. Only due to hardly distinguishable differences between responses and comparably weighted, logarithmic stimulus fractions, we could help weighted Fechnerian sensation scales out of the morass like the 'baron of Munchausen'. Nonetheless, the intermediate concept of covert Fechnerian sensations in the transformation of stimuli to responses is necessary for the mathematical description of 1) slower adaptation to low than high stimulus intensities, 2) slower saturation to more of appreciated matters than aversion to equally more of depreciated matters, and 3) higher utility losses than gains for objectively equal loss and gain values, as experimentally verified phenomena that derive from larger, logarithmic stimulus differences on low than high intensity levels for identical stimulus differences. Since many modalities have power exponents larger than unity, these phenomena can't be explained by Stevens' power function of stimuli.

Psychophysical observations are responses, whereby a psychometric response function as transformation of stimuli to responses and not of stimuli to sensations is implied. Therefore the actual function in psychophysics is a psychometric response function, under exclusion of the arctangem-based function, is defined by

$$\text{psychometric function } f(x, I_b) = \tanh[\ln(xJb)/a] = \frac{(xJb)^{2I_a} - 1}{(x, I_b)^{2I_a} + 1}$$

Notice that  $f(x, I_b) = \tanh[\ln(x, I_b)/a]$  for a wide sensation range is similar to

$$f(x, I_b) = r_1 = \arctan[2 \ln(xJb)/a] / (V_m),$$

as shown in section 4.2.1. This implies that the psychometric response function could also be expressed by  $f(x, I_b) = \arctan[2 \ln(x, I_b)/a] / (Y_m)$  and, according to our derivations, should be expressed in that way if the stimulus geometry is double-elliptic. Notice that Stevens' power-raised stimulus fraction scales of subjective stimulus magnitudes are responses to weighted sensations,  $\ln(x, I_b)$  that match with cognitive magnitude sensations  $\ln(f, I_b')$  of objective fraction quantities  $f, I_b'$ , become in response terms for the hyperbolic tangent-based function expressed by  $1/z_1 \approx 1$  and  $2/a = \tau$  as

$$\text{Stevens fractionation: } f_i/b = \exp \left[ 2 \frac{(x_i/b)^{\tau} - 1}{(x_i/b)^{\tau} + 1} \right] \approx (x_i/b)^{\tau} \approx (x_i/b)^{\tau}$$

where  $a = \ln(b/u)$  is the adaptation level as measured by sensation interval  $\ln(b/u) - \ln(u/\mu)$  for a modality. Notice also that  $\exp(-2) < f_i/b' < \exp(2)$ , where  $f_i/b' \approx (x_i/b)$  is no exact equality with differences that become the larger the higher the values of  $\tau$  and the wider or the more extremely located (low or high) the employed stimulus ranges are. Notice further that the value  $\tau$  is quite well estimated for a midrange of stimulus intensities fairly above the absolute just noticeable level and fairly below the sense-damaging intensity level by

$$\tau \approx 2 \sum_{i=1}^n (\tanh[\ln(x_i/b)/a] / \ln(x_i/b)) / n = 2 \cdot z/a = 2 \cdot z / \ln(b/u),$$

for  $n$  uneven and equal spaced values  $\ln(x_i/b)$  around  $\ln(x_i/b) = 0$  as midpoint of their sensation intensity ranges. Here the value of  $z$  as average  $z$  is almost unity for a logarithmic stimulus fractions between  $-2/a < \ln(x_i/b) < 2/a$  or between stimulus fractions  $J(u/b) < X_i/b < J(b/u)$ , because within that range  $2/a - \tau < 0.03$ . It means that a range from  $\exp(-1/\tau)$  to  $\exp(1/\tau)$  is the range where Stevens' fractionation method for subjective stimulus magnitudes determines a power exponent  $\tau$  that deviates no more than 3% from the value of  $2/a$ . Stevens generally fitted his power exponent of subjective stimulus magnitudes for stimulus ranges well above the just noticeable level, which yields the more accurate estimates of  $\tau$  the smaller the midrange and the higher the adaptation level of the modality are. The highest and lowest averages of power exponents for modalities are  $\tau = 2.5$  for electric shock and  $\tau = 0.33$  for brightness (Laming 1986). Thus, Stevens' fractionation method for subjective brightness magnitudes allow a large stimulus range for its power exponent estimation. A brightness stimulus range with geometric average 800 lux as adaptation level almost exactly fits  $\tau = 1/3$  for a brightness range between  $\exp(3) = 20 = 16,000/800$  for 16,000 lux as upper bound and  $\exp(-3) = 0.05 = 40/800$  for 40 lux as lower bound. Since power exponent  $\tau = 2/\ln(b/u)$ , we have  $u = b/\exp(2/\tau)$ . For brightness with  $\tau = 1/3$  and  $b = 800$  lux it yields  $u = 800/\exp(6) = 2$  lux as just noticeable brightness. An accurate estimation of the power exponent for electric shocks on the skin requires in contrast to brightness a relatively small stimulus range. For a shock range with stimulus-adaptation level  $b = 1.2$  ma and  $\tau = 2.5$  it allows a range between  $\exp(1/2.5) = 1.5 = 1.8/1.2$  for upper bound 1.8 ma and  $\exp(-1/2.5) = 0.67 = 0.8/1.2$  for lower bound 0.8 ma, while the electric shock threshold would become  $u = b/\exp(2/\tau) = 1.2/\exp(2/2.5) \approx 0.5$  ma.

Power exponents in fraction magnitude estimations vary between individuals and their median power exponents also intra-modally (Teghtsoonian, 1973), where the median power exponent increases with range decreases of the employed stimulus values. For relatively large to small loudness ranges the median power exponents increase from 0.40 (with individual values varying from 0.32 to 0.60) to 0.62 (individual values vary from 0.46 to 1.08), or for relatively large distances to small lengths the estimated median power exponents are varying from 0.88 to 1.12 (individual values varying from 0.74 to 0.98 for large distances and from 1.03 to 1.28 for small lengths), or for relatively large to small electric shock ranges the estimated

power exponents vary from 1.5 to 3.5 (Teghtsoonian, 1971). This is explained by noticing that the estimation actually yields  $\tau = 2/z/a$  instead of  $\tau = 2/a$ , where stimulus ranges between  $\exp(\pm 2/t)$ , thus between  $u/b$  and  $b/u$ , yield average  $z = 0.67$  and stimulus ranges between  $\exp(\pm 1/t)$ , thus between  $J(ub)$  and  $I(b/u)$ , yield average ratio  $z = 0.97$ . This explains why Stevens et al. (1958) found a power exponent  $\tau = 3.5$  for electric shock by employing a rather small and low-located intensity range of electric shocks on a finger tip from the almost absolute Just-noticeable level  $u/\mu = 0.38$  ma to only 1.15 ma with geometric average  $b/\mu = 0.67$  ma, which yields  $\tau = 2/\ln(b/u) = 3.53$ , instead  $\tau = 2.5$  for  $b/\mu = 1.2$  ma and  $u/\mu = 0.5$  ma, as illustrated earlier. It illustrates that intra-modal changes of power exponents are explained by taking magnitude responses as subjective stimulus magnitudes. Firstly, the value  $\tau = 2/z/a$  defines that power exponent  $\tau$  becomes the smaller the larger the range of stimuli, due to the lower values of  $z$  for the larger ranges, which explains why the power exponent within each modality reduces with increased levels of the stimulus value range. Secondly, power exponent  $\tau$  becomes the larger the lower the value of adaptation level  $a = \ln(b/u)$  is, which not only explains the power-exponent differences between modalities, but also why power exponents within modalities are the higher the closer the adaptation level approaches the absolute just-noticeable level (thus the narrower and lower the stimulus range is).

The observed individual power-exponent deviations probably are caused by 1) individual differences in sense-organ sensitivity, where a relatively lower sensitivity with a relatively higher, absolute just-noticeable level implies a relatively higher power exponent and 2) adaptation-level shifts to sequentially presented stimuli, where the shifted adaptation levels also can cause intra-individual variations of the power exponent. Nonetheless, estimates of  $\tau = 2/\ln(b/u)$  are well specified by the average of individual sensation distances between adaptation level  $\ln(b/\mu)$  and just noticeable level  $\ln(u/\mu)$  of employed stimulus modality ranges. A rather constant power exponent  $\tau$  for a modality and variable adaptation level as geometric midpoints of employed different stimulus ranges imply a dependence of the just noticeable level on the adaptation level. Since the just noticeable stimulus level  $u/\mu$  seems indeed to vary with the geometric midpoint of the employed stimulus range, distance  $\ln(b/u)$  will be rather constant for shifted stimulus ranges well above the absolute threshold. The variance of  $\tau = 2/\ln(b/u)$  between modalities is much larger than within each modality, as implied by the different and almost constant distance  $\ln(b/u)$  for each modality. The adaptation level  $a = \ln(b/u)$  is defined by  $u/\mu$  as scale unit for  $b/u$ , which seems akin to Fechner's assumption. However, for a wide stimulus midrange well above the absolute threshold we have by rather constant power exponents  $\tau_k = 2/\ln(b_k/u_k)$  also rather constant units of intensity-comparable sensations. Thus, for  $b_k/\mu$  as stimulus-adaptation level and  $u_k/\mu$  as just noticeable stimulus level well above the absolute threshold we conclude that stimulus intensities within range  $\exp[\pm 2/\ln(b_k/u_k)]$  yield negligible differences between intensity-comparable sensation and response measurements and, thus, stable power exponent estimates of subjective stimulus magnitudes. Nonetheless, estimates of intra-modal power exponents decrease with increased range width of employed stimuli and the more if the lower range bound approaches the absolute threshold, due to then marked differences between responses and intensity-comparable sensations.

Since intensity-comparable sensations are matched with cognitive magnitudes that equal length sensations (the psychophysical power exponent of length is unity), it is tempting to conjecture that appropriate power exponents for stimulus modalities should equal the inverse value of physical power exponents for so far as their physical perception dimensions can be expressed by (a product and/or ratio of) length or length-equivalent measurements (including frequency, length of time and lengths of wave amplitude and period). This conjecture holds for subjective magnitudes of area as squared length (power exponent 2 physically and 1/2 psychophysically) and volume as cubic length (power exponent 3 physical and 1/3 psychophysical), It might also hold for loudness (if related to area by eardrum diameter times vibration amplitude - psychophysical power exponent 1/2) and for brightness (if related to volume by excitation frequency times excited retina area - psychophysical power exponent 1/3). For lifted weights the power exponent is 3/2, but we don't know how lifted weight or other modalities could be related to (inverse ratios of) length or length-equivalent measurements. Since for other modalities this also may apply, reciprocal values of physical and psychophysical power exponents likely hold not in general.

6.2.4. Summary of transformed-extensive measurements

To summarise the measurement types as by-products of our theory, we have:

1) (O,2,O)-unique scales  $(x_{ik}/b_{Jk})^{T_{Jk}}$  for *subjective stimulus magnitudes* with adaptation points  $b_{Jk}/u_{Jk}$  and power exponents  $T_{Jk} \approx 2/\ln(b_{Jk}/u_{Jk})$ , defined by distinct values on stimulus ratio scales  $x_{ik}/\mu_k$  for  $b_{Jk}/\mu_k$  as individual adaptation point and  $u_{Jk}/\mu_k$  as just noticeable level with  $b_{Jk}/\mu_k > u_{Jk}/\mu_k$  for  $u_{Jk}/\mu_k$  as absolute, just noticeable stimulus threshold, whereby we obtain:

- independence of scale unit  $\mu$  of power-raised fraction scale  $(x_{ik}/b_{Jk})^{T_{Jk}}$  with distinct unit points  $x_{ik}/b_{Jk} \approx I$  and distinct power-exponents  $T_{Jk} \approx 2/\ln(b_{Jk}/u_{Jk})$ .
  - values  $(x_{ik}/b_{Jk})^{T_{Jk}}$  are nonhomogeneous measurements.
- Its geometry is either a power-raised, Euclidean or hyperbolic or double-elliptic, positive orthant space of (O,2,O)-unique, power-raised stimulus fraction scales with zero origin and a distinct individual unit space point (but power-raised, double-elliptic fraction spaces actually define (O,2,1)-unique scales, due to the polar maximum of double-elliptic spaces).

2) bipolar (O,2,O)-unique scales of *comparable sensations* that are defined by:

2a) intensity-comparable, hyperbolic or flat sensations

$$2(y_{ik}/a_{Jk} - I) \approx 2[\ln(x_{ik}) \cdot \ln(b_{Jk}) - \ln(u_{Jk})] \approx 2\ln(x_{ik}/b_{Jk})/\ln(b_{Jk}/u_{Jk})$$

with scale properties:

- $2(y_{ik}/a_{Jk} - I) \approx 2\ln(x_{ik}/b_{Jk})/\ln(b_{Jk}/u_{Jk})$  is invariant under linear transformations of  $Y_{ik} = \ln(x_{ik})$ ;  
 $Y_{ik} - a_{Jk} = \ln(x_{ik}/u_{Jk}) - \ln(b_{Jk}/u_{Jk}) = \ln(x_{ik}/b_{Jk})$  is a dimensional Fechner-Helson sensation difference with respect to the dimensional adaptation level;
- $2(Y_{ik}/a_{Jk} - I)$  is an intensity-comparable sensation dimension, where unit stimulus fraction scale points  $x_{ik}/b_{Jk} \approx I$  and  $x_{ik}/u_{Jk} = I$  define infinite, (O,2,O)-unique, and

homogeneous measurements for intensity-comparable sensation dimensions that relate to power-raised stimulus-fraction dimensions by

$$\exp[2(Y_{ik}/a_{Jk} - 1)] = \exp[(2Y_{ik} - a_{Jk})/a_{Jk}] = (x_{ik}/b_{Jk})^{\tau_{Jk}}$$

$$\text{with } \tau_{Jk} = 2/a_{Jk} \dots 2/\ln(b_{Jk}/a_{Jk})$$

2b) valence-comparable, flat sensation distances

$$|(Y_{ik} - g_{Jk})/d_{Jk}| = |\ln(x_{ik}) - \ln(P_{ik}/\ln(b_{Jk}/a_{Jk}) - \ln(p_{Jk})| = |\ln(x_{ik}/p_{Jk})| / |\ln(b_{Jk}/p_{Jk})|$$

with similar scale properties, because:

- $(y_{ik} - g_{Jk})/d_{Jk}$  is invariant under linear transformations of  $Y_{ik} = \ln(x_{ik})$ ;
- $Y_{ik} - g_{Jk} \dots \ln(x_{ik}/p_{Jk})$  is the dimensional sensation difference from the ideal point;  $(Y_{ik} - g_{Jk})/d_{Jk} \dots \ln(x_{ik}/p_{Jk})/\ln(b_{Jk}/p_{Jk})$  is a valence-comparable sensation dimension, where distinct unit stimulus fraction point  $x_{ik}/p_{Jk} \dots 1$  and  $x_{ik}/b_{Jk} = 1$  defines infinite, (0,2,D)-unique, and homogeneous measurements for valence-comparable sensation dimensions that relate to power-raised stimulus-fraction dimensions by

$$\exp[(Y_{ik} - g_{Jk})/d_{Jk}] = (x_{ik}/P_{Jk})^{\sigma_{Jk}} \text{ with } \sigma_{Jk} = 1/d_{Jk} = 1/\ln(b_{Jk}/p_{Jk}).$$

2c) valence-comparable, hyperbolic sensation distances

$$\cosh[(Y_{ik} - g_{Jk})/d_{Jk}] = \cosh[\ln(x_{ik}/p_{Jk})/\ln(b_{Jk}/p_{Jk})]$$

with similar scale properties, because:

- $\cosh[(y_{ik} - g_{Jk})/(a_{Jk} - g_{Jk})]$  is invariant under linear transformation of  $Y_{ik} = \ln(x_{ik})$ ;
- $\text{COSH}[\ln(x_{ik}/P_{Jk})/\ln(P_{Jk}/b_{Jk})]$  is a valence-comparable dimensional sensation distance, where distinct unit stimulus fraction points  $x_{ik}/b_{Jk} \dots 1$  and  $x_{ik}/P_{Jk} = 1$  define infinite, (0,2,0)-unique, homogeneous measurements of valence-comparable sensation dimensions that relate to power-raised, conjugate stimulus-fraction dimensions by

$$\cosh[(Y_{ik} - g_{Jk})/d_{Jk}] = [(x_{ik}/P_{Jk})^{1/d_{Jk}} + (P_{Jk}/x_{ik})^{1/d_{Jk}}] / 2.$$

- The geometries of comparable sensations are infinite and flat (Euclidean or Minkowskian), if the stimulus space is non-Euclidean, or infinite and hyperbolic, if the stimulus space is Euclidean.

3) bipolar (0,2,1)-unique scales of *judgmental responses* within an open interval with absolute equal, singular maximum and minimum values, defined by one of the two permissible response-space transformations of two permissible geometries for intensity-comparable sensation spaces, which yield individual response space as (quasi-)involution spaces of the power-raised stimulus space with respect to the individual unit adaptation point. The alternative response spaces are defined by:

3a)  $r_{Jik} = \arctan[2(y_{ik}/a_{Jk} - 1)]$  as single-elliptic response space dimension with:

- $r_{Jik}$  as response dimension for flat intensity-comparable sensations  $2(y_{ik}/a_{Jk} - 1)$ ;
- $\exp[2(y_{ik}/a_{Jk} - 1)] \dots (x_{ik}/b_{Jk})^{\tau_{Jk}}$  as power-raised, double-elliptic stimulus dimension  $k$ ;
- $r_{lik} \dots 0$  corresponds to sensation  $y_{ik}/a_{Jk} \dots 1$  and is the origin of the bipolar homogeneous response scale between singular maximum  $1/2\pi$  and minimum  $-1/2\pi$ .

- Its geometry is a single-elliptic space with adaptation point  $r_{Iik} = 0$  as origin and centre of a circular limit boundary at elliptic distance  $\frac{1}{2}\pi$  from  $r_{Iik} = 0$ ,

3b)  $r_{Jik} = \tanh[y'_k/a_{Jk} - I]$  as open-Euclidean response space dimension with:

- $r_{Jik}$  as response dimension for hyperbolic, intensity-comparable sensation  $2(yik/a_{Jk}-i)$ ;
- $\exp[2(y'_k/a_{Jk}-1)] = (x'_k/b_{Jk})^{T_{Jk}}$  as power-raised, Euclidean stimulus dimensions  $k$ ;
- $r_{Jik} = 0$  corresponds to sensation  $yik/a_{Jk} = I$  and is the origin for the bipolar, homogeneous response scale between singular maximum  $+I$  and minimum  $-I$ ,
- Its geometry is an open-Euclidean space with  $r_{Jik} = 0$ , as origin and centre of circular limit boundary at unit distance from  $r_{Jik} = 0$ ,

3c)  $r_{Jik} = \tanh[Yik/a_{Jk} - I]$  as open-hyperbolic response dimension with

- $r_{Jik}$  as response dimension for flat intensity-comparable sensations  $2(yik/a_{Jk} - 1)$ ;
- $\exp[2(Yik/a_{Jk} - I)] = (x_{ik}/b_{Jk})^{T_{Jk}}$  as power-raised, hyperbolic stimulus dimensions  $k$ ;
- $r_{Jik} = 0$  corresponds to sensation  $yik/a_{Jk} = I$  and is the origin for the bipolar, homogeneous response scale between singular maximum  $+I$  and minimum  $-I$ .
- Its geometry is an open-hyperbolic space with  $r_{Jik} = 0$  as origin and centre of circular limit boundary at unit distance from  $r_{Jik} = 0$ ,

Dissimilarities rank orders are represented by response space distances rank orders that for weighted, comparable sensation pairs  $(i,j)$  and  $(i',j')$  are defined either for distances in open-Euclidean response spaces by

$$\sqrt{\sum_{k=1}^{k=m} [\tanh(Yik/a_{Jk}-1) - \tanh(Yjk/a_{Jk}-1)]^2} > \sqrt{\sum_{k=1}^{k=m} [\tanh(yi'k/a_{Jk}-1) - \tanh(Yj'k/a_{Jk}-1)]^2}$$

or for distances in open-hyperbolic response spaces by

$$\operatorname{gcoSh}\{\tanh[Yik/a_{Jk}-1] - \tanh[Yjk/a_{Jk}-1]\} > \operatorname{gcoSh}\{\tanh[Yi'k/a_{Jk}-1] - \tanh[Yj'k/a_{Jk}-1]\}$$

or for distances in single-elliptic response spaces by

$$\prod_{k=1}^{k=m} [\cos\{\arctan[2(y_{ik}/a_{Jk}-1)] - \arctan[2(y_{jk}/a_{Jk}-1)]\}] > \prod_{k=1}^{k=m} [\cos\{\arctan[2(y_{i'k}/a_{Jk}-1)] - \arctan[2(y_{j'k}/a_{Jk}-1)]\}]$$

- 4) bipolar  $(0,2,1)$ -unique scales of *monotone valences* that are measured by ideal response space axis as an individually rotated response dimension in one of the three alternative response spaces, where for all three possibilities the preference of  $J$  for object  $i$  is measured for  $h_{Jk}$  as rotation coefficients by

$$v_{Ji} = \sum_{k=1}^{k=m} v_{Jik} = \sum_{k=1}^{k=m} h_{Jk} \cdot J_{i-k} \text{ with scale properties:}$$

- $v_{Ji}$  is the ideal axis determined by rotation cosines  $h_{Jk}$  in a response space;
- $v_{Ji}$  is a bipolar, homogeneous scale with  $v_{Ji} = 0$  as distinct zero centre of values between singular maximum  $\frac{1}{2}\pi$  or  $I$  and minimum  $-\frac{1}{2}\pi$  or  $-I$ , where the scale equals an open-Euclidean, or single-elliptic, or open-hyperbolic response dimension,

- 5) bipolar (O,2,2)-unique scales for *single-peaked valences*, defined by one of the two theoretically compatible, symmetrically isomorphic space transformations with respect to ideal points of the two permissible geometries for valence-comparable sensation spaces, where single-peaked valences are described

5a) for double-elliptic stimulus space dimensions by

$v_{Jik} = \arctan[1 - d_{Jik}/d_{Jk}] \cdot \arctan[1 + d_{Jik}/d_{Jk}]$  with scale properties:

- $v_{Jik}$  is a **single-peaked** valence dimension for flat valence-comparable sensations from elliptic stimulus dimensions  $k$  with  $d_{Jik} = |\ln(x_{ik}/p_{Jk})|$ ,  $d_{Jk} = |\ln(b_{Jk}/p_{Jk})|$ , and space distances  $d_{Ji} = |\ln(x_i/p_{Ji})|$  and  $d_{Jj} = |\ln(b_j/p_{Jj})|$ , where  $p_{Jk}/\mu_k$  is the individual ideal point and  $b_{Jk}/\mu_k$  the individual adaptation point on a stimulus dimension  $k$ ;
- $v_{Jik} = 0$  for  $d_{Jik}/d_{Jk} = 1$  defines individual zero valence points for dimensional adaptation and saturation or deprivation points with maximum valence as midpoint;
- individual (0,2,2)-unique, dual-homogeneous valence scales with maximum valence  $v_{\max} = \arctan^2(1) = \pi^2/16$  for  $d_{Ji} = 0$  and minimum valence  $-\pi^2/4$ ;
- Its geometry defines an open Finsler space with  $\zeta_{Ji} = 1/m \arctan[1 + d_{Ji}/d_{Jj}]$  as curvatures that reduce with increased sensation distances  $d_{Ji}/d_{Jj}$ ; a conditional rotation invariance for the ideal point as rotation centre.

5b) or for Euclidean stimulus spaces by

$v_{Jik} = \tanh[\frac{1}{2}(1 - d_{Jik}/d_{Jk})] \cdot \tanh[\frac{1}{2}(1 + d_{Jik}/d_{Jk})] = \tanh[-\frac{1}{2} \ln\{\cosh(d_{Ji}/d_{Jk})/\cosh(I)\}]$   
with scale properties:

$v_{Jik}$  as single-peaked valence dimension of valence-comparable, hyperbolic sensation and Euclidean stimulus dimension  $k$  with distances  $d_{Jik} = |\ln(x_{ik}/p_{Jk})|$ ,  $d_{Jk} = |\ln(b_{Jk}/p_{Jk})|$ , where  $p_{Jk}/\mu_k$  and  $b_{Jk}/\mu_k$  are the individual ideal and adaptation points on stimulus dimension  $k$ ;

- $v_{Jik} = 0$  for  $d_{Jik}/d_{Jk} = 1$  defines individual zero valence points for dimensional adaptation and saturation or deprivation points with maximum valence as midpoint;
- individual (0,2,2)-unique, homogeneous valence scales between maximum valence  $v_{\max} = \tanh^2(1/2)$  for  $d_{Ji} = 0$  and minimum valence  $-I$  for infinite sensations. Its geometry defines an open-hyperbolic space with constant curvature  $\zeta = -1/2$ ;

5c) or for hyperbolic stimulus spaces by

$v_{Jik} = \tanh[\frac{1}{2}(1 - d_{Jik}/d_{Jk})] \cdot \tanh[\frac{1}{2}(1 + d_{Jik}/d_{Jk})] = \tanh[-\frac{1}{2} \ln\{\cosh(d_{Jik}/d_{Jk})/\cosh(I)\}]$   
with scale properties:

- $v_{Jik}$  as single-peaked valence dimension of valence-comparable, Euclidean sensation and hyperbolic stimulus dimensions  $k$  with distances  $d_{Jik} = |\ln(x_{ik}/p_{Jk})|$  and  $d_{Jk} = |\ln(p_{Jk}/b_{Jk})|$ , where  $p_{Jk}/\mu_k$  is the individual ideal point and  $b_{Jk}/\mu_k$  the individual adaptation point on stimulus dimension  $k$ ;
- $v_{Jik} = 0$  for  $d_{Jik} = d_{Jk}$  defines individual zero valences for distinct dimensional adaptation and saturation or deprivation points with maximum valence as midpoint;



- individual (0,2,2)-unique, dual-homogeneous valence scales between maximum valence  $v_{\max} = \tanh^2(1/2)$  for  $d_{ji} = 0$  and minimum valence  $-1$  for infinite sensations.
- Its geometry defines an open Finsler space with  $\zeta_{ji} = -1/\tanh[Y2(l+d_{ji})]$  as curvatures, where  $|\zeta_{ji}|$  reduces with increased sensation distance  $d_{ji}$ .
- a conditional rotation invariance with the ideal point as rotation centre;

The single-peaked preferences of an individual  $J$  for objects  $i$  are measured on a bipolar open scale that for Euclidean stimulus spaces is defined by

$$vJ'_1 = \tanh\left[\sum_{k=1}^{k=m} \arctanh(v_{J_1 k})\right],$$

and for valences  $vJ'_1$  of hyperbolic stimulus spaces by

$$(v_{\max} - v_{J_1}) / (1 - v_{\max}) = \tanh^2\left[\sum_{k=1}^{k=m} \arctanh^2\left\{\frac{(v_{\max} - v_{J_1 k})}{(1 - v_{\max})}\right\}\right],$$

while for valences of double-elliptic stimulus space no similar sum expression of dimensional valences could be derived or may not exist. Observed preferences are represented by conditional distance rank orders, but solved valence-comparable sensation spaces define metric preference differences between objects for individuals, where  $v_{J_1} - v_{J_1'}$  is determined by  $d_{ji}$ ,  $d_j$  and  $d_j'$  while also metric differences  $v_{J_1} - v_{J_1'}$  between the preference strength of different individuals are determined by  $d_{ji}$  and  $d_j$  for individual  $J$  and by  $d_j$  and  $d_j'$  for individual  $l$ .

Referring to the earlier given citation from FoM (ch. 10, p. 518), we have introduced "new nonbasic quantities that are relevant to the nonphysical sciences", which nonbasic quantities here apply to the psychology of judgement and preference. Since all above-defined measurements have distinctly solvable dimensional parameters and no arbitrary parameters, they allow meaningful, quantitative relationships between measurements for the psychological theory of judgment and preference. The isomorphic transformations of power-raised stimulus fraction spaces to response or valence spaces define transformed-extensive response or valence measurements, where we "append them to the existing structure of physical quantities" by the inverse of their respective stimulus space transformations to common stimulus spaces. Response and valence spaces are isomorphic projection transformations of (0,2,0)-unique measurement spaces of comparable sensations with respect to the adaptation or ideal point as projection centre. However, individual adaptation and ideal space points may shift if exposure to stimuli and/or reinforcements are changing. Therefore, psychological measurements are always individual and relative measurements that individually or collectively may change by the sequential exposure to stimuli and/or reinforcements, which relativity dynamics are discussed in the next chapters.

## CHAPTER 7

### PSYCHOLOGICAL RELATIVITY AND CHOICE DYNAMICS

*"Adaptation level as a weighted mean immediately implies that every stimulus displaces level more or less in its own direction <>. If a stimulus is above level, the level is displaced upward, if below level downward, and if it coincides, it does not change level. <> especially repeated stimulation, negates itself to some degree by reducing its distance from level. "*

Helson (1964). *Adaptation-level theory*, (p. 61). Harper & Row, New York

*"It may be useful to distinguish between two forms of stimulus bias, a set-independent bias and a set-dependent bias. <> An example of a set-independent bias would be the strength with which an item is stored in the memory due to its frequency of presentation. <> By contrast, biases resulting from differential densities are set dependent."*

Nosofsky (1991). Stimulus bias, asymmetric similarity, and classification, (p. 134). *Cognitive Psychology*, 23: 94 -140.

## CONTENT DETAILS CHAPTER 7

	page
7.1. Dynamic relativity in perception, cognition, and preference	303
7.1.1. Adaptation-level relativity and dynamics	305
7.1.2. Target-stimulus dependence of adaptation-level shifts	309
7.1.3. Stimulus-pair dependence of adaptation-level shifts	314
7.1.4. Stimulus- and task-dependent attention dynamics	317
7.1.5. Dual stimulus-pair dependence of adaptation-level shifts	320
7.1.6. Dynamic cognition and preference relativity	322
7.2. Perception research and dynamic similarity relativity	325
7.2.1. The visual space as open-Euclidean response space	326
7.2.2. The choice axiom, symmetric similarity, and MDS	329
7.2.3. Multiplicative bias in choice and similarity probability	343
7.2.4. Multiplicative or power-raised. stimulus-dependent similarity bias	347
7.2.5. Deterministically relative versus stochastic similarity analyses	357
7.3. Cognition research and dynamic similarity relativity	359
7.3.1. Individual similarity relativity and cognitive similarity analysis	359
7.3.2. Methodological artifacts in cognitive similarity research	362
7.4. Preference research and dynamic preference relativity	371
7.4.1. Preferential choice dynamics	371
7.4.2. Dynamic relativity of utility- and risk-dependent preferences	372
7.4.3. Dynamic relativity of preferences with single-peaked valences	393

### 7.1. Dynamic relativity in perception, cognition, and preference

In chapters 4 and 5 individual transformations of sensation spaces are defined with respect to an individually fixed adaptation or ideal points and with dimensional sensation weights that depend on the dimensional parameters for individually fixed distances between the just noticeable and adaptation points or between the adaptation and ideal points, where these dimensional weights enable intensity- or valence comparability of sensation dimensions. In chapter 3 we demonstrated that power exponents of stimulus dimensions correspond to the dimensional weights in the Bower space of intensity-comparable sensations, where the dimensional stimulus power exponents are Stevens power exponents defined by twice the inverse of the dimensional distance between the adaptation and just noticeable points in the (not weighted) Fechner sensation space of logarithmically transformed stimuli. The adaptation level is defined by the average sensation intensity of the stimuli that are randomly presented to the individual. No special attention was given to adaptation points of stimulus dimensions that are not characterised by energetic intensity. Non-energetic stimulus dimensions are not characterised by intensity dimensions, but by the extensiveness dimensions of the spatial distribution pattern of energetic stimuli. For example, spatially different visual stimuli that are equal in brightness are perceived by pattern relations between retina signals at different retina locations that correspond to the spatial stimulus pattern. Similar things hold for colours or tones that only differ in wavelengths (same energetic intensity: equal colour luminosity or equal decibels of tones). The spatial distribution of (positively or negatively) evoked rods and cones in the retina determine the colour perception, as illustrated by the correspondence between the colour circle from the similarity analysis of colours and the opposite excitation pattern of cones for red-green and of rods for blue-yellow. Also the spatial patterns of evoked ganglions in the spiral cochlea of the inner ear determine the tone level perception, where the MDS analysis of similarities between tones of equal loudness (Levelt, et al. 1966; Van de Geer, 1970) nicely illustrates the spatial perception structure of tones by the closer spiral distances between identical octave tones in successive octave spirals than between remote tones within the same octave. The adaptation point for such non-energetic qualities of stimulus modalities equals the spatial centroid of these quality sensations for randomly presented stimuli of a homogeneous stimulus set. The adaptation level of perceptual stimuli with energetic intensities and non-energetic extensivities generally will be identical for different individuals in common stimulus situations (except for individuals with perception abnormalities, such as colour blindness). Extensiveness sensations for non-energetic stimulus dimensions (length, height, and depth as well as spatially coded stimulus dimensions of duration length for time and wavelength for colours and tones) need also to be made comparable with respect to each other and with respect to sensations of energetic stimulus dimensions in order to enable similarity evaluations. In chapter 2 we further analysed the relationship between stimulus range and Stevens' power exponent in Teghtsoonian's (1971, 1973, 1974) meta-analysis of many studies. Thereby, we derived that generalised length sensations serve as cognitive magnitude sensations for the matching of dimensional sensation differences from adaptation level. Matching weights  $\tau_k = 2/a_k = 2/\ln(b_k/u_k)$  of sensation differences  $\ln(y_k/b_k)$  where  $\ln(b_k/u_k)$

is the almost constant sensation distance between the dimensional adaptation and just noticeable levels, define intensity-comparable sensation dimensions of stimuli. In chapters 3 to 6 we assumed individually constant adaptation levels that indeed may be identical for randomly selected stimuli from a prior known set of perceptual stimuli.

Nonetheless, evaluation studies may sequentially present stimuli or pairs of stimuli and also not randomly from a previously unknown stimulus set and/or the evaluation tasks may require comparisons with repeatedly presented or memorised target stimuli. As discussed in chapter 1, Helson's (1964) adaptation-level theory specifies that individual adaptation levels are determined by some averaging process, either of recent sensations during the sequential exposure of stimuli in perceptual evaluation tasks, or of memorised sensations from similar object contexts in more cognitive evaluation tasks, or some mixture of both. We have also argued that the time frame for the sequential averaging process for the adaptation level can be different for perceptual and cognitive or affective domains. In chapter I we referred to Broadbent's processes of 'filtering', 'pigeon holing' and 'categorisation' (Broadbent, 1971) as relevant for the time frames of adaptation. There, we suggested that 'filtering' coincides with immediate adaptation to the ongoing stimulation from sequentially presented, focal stimuli and/or contingently given, physical reinforcements, where the momentary time sequence defines the time frame of adaptation to perceptual stimuli and/or contingent-affective reinforcements. The adaptation level derives then from some averaging process of perceptual and affective sensations over the time intervals for the presented stimuli. The 'pigeon holing' process is assumed to establish the temporary stable adaptation or reference levels for the response sensations that are related to the evaluation task for the particular stimulus set and as such are dependent on the memory for similar response tasks and stimulus sets. Its reference levels become updated by an averaging process over the actual task for the stimulus set and preceding similar tasks for similar stimulus sets, where the time frame for the averaging is defined by the periods of the present and past task experiences for the memory-based selection of similar tasks and stimuli. It dominantly defines temporary stable adaptation or reference levels for evaluation responses to presented stimuli or to objects that imply a cognitive and/or preferential selection from a known set of memorised stimuli or objects. The long-term time frames for developmental changes in adaptation or reference levels for cognitive judgements and preferences are characterised by the 'categorisation' process that determines the more or less lasting traits of the adult personality.

Brightness adaptation shows that the adaptation level can very quickly shift with the ongoing focal stimulation. This also holds for other perceptual modalities, which then may change the adaptation level for judgmental perception responses and then also its distance to the ideal level for preferences of perceptual stimuli. For evaluation tasks of cognitive objects the reference levels will be determined by stored or inferred levels from previous similar contexts of cognitive objects, such as the just noticeable sensation level, or object- and/or task-dependent reference- or target-sensation levels and/or ideal sensation levels. These memorised reference levels are assumed to be temporarily stable, but different for different tasks and object sets and for the ideal levels also different for different individuals. However, if tasks or reinforcement conditions change, these other reference levels also can change suddenly, due to the

reference to other stored levels that are associated with these different tasks or changed conditions. Many evaluation tasks concern not the primary perceptual stimuli, but the cognitive objects that are represented by learned connotations and affections of primary perceptual stimuli, such as the stimuli of written or spoken words. The sensory adaptation processes are then of secondary importance, because the cognitive objects primarily refer to memory-based sensations for object sets that have their own stored connotative and/or affective adaptation and/or ideal levels. Nonetheless, also sequential presentations of cognitive objects that refer to physical objects may by adaptation to the internally generated object sensations influence the adaptation level in a way that to some extent is similar to the presentation of the physical objects themselves, especially if responses to the cognitive objects with corresponding physical objects are contingently reinforced. The sequential presentation of objects from a cognitive object set that refers not to physical objects (for example words for political parties or religions) will hardly influence the adaptation level for the cognitive object set that then determines by its presentation and task condition some slightly updated average of the stored cognitive or affective reference levels from previous presentations of similar cognitive object sets in similar task conditions. For purely cognitive objects the adaptation and ideal point thus relate to stored levels for the set of objects that only may gradually change by newly reinforced experiences of the presented object set and task, or may hardly change, because cognitively and/or affectively dissonant information tends to be ignored (Festinger, 1957, Wicklund and Brehm, 1976, McGuire, 1985). However, the reference frame can suddenly change by changed sub-tasks for responses to cognitive objects or by changed reinforcement conditions for preferential responses (Kendler and Kendler, 1962), because then the 'pigeon holing process' refers to other selections of stored levels than the reference level for the total object set and overall task condition. The characterisation of a stimulus or object with respect to the stimulus or object set and surrounding field usually is defined as the stimulus or object context, while we define the type of task environment and/or reinforcement conditions as task conditions. Sensory stimuli thus relate to quick sensory adaptation processes that may determine momentary shifts of the existing adaptation level by a presented stimulus or stimulus subset, while the stimulus or object context defines the average adaptation level. But cognitive object contexts and their task conditions primarily relate to the selection of stored reference levels, determining the more or less static adaptation level and ideal level for a particular context and condition, where the adaptation level only may secondarily change to some extent by the adaptation to the cognitively presented objects if the cognitive objects refer to physical objects. Otherwise its reference levels only may suddenly change, if task conditions are changed and/or contexts of subsets of stimuli or objects refer to differently selected reference levels.

#### *7.1.1. Adaptation-level relativity and dynamics*

The averaging process for the momentary adaptation level in the presentation sequence of focal stimuli from a particular stimulus context (determining the average adaptation level) in particular conditions (determining the temporary or lasting reference levels) is formally described on the basis of Helson's (1964) adaptation-level theory in the next mathematical subsection.

For the averaging process in Helson's (1964) adaptation-level theory we define a time-dependent sequential averaging process of the scale-dependent, momentary adaptation level by

$$\ln(b_t/\mu) = (1-w) \cdot \ln(b_{t-1}/\mu) + w \cdot \ln(x_{i,t}/\mu),$$

- where 1) the adaptation level  $\ln(b_t/\mu)$  for  $t = 0$  derives from some stored level of preceding similar stimulation for modality  $x$  or  $\ln(b_0/\mu) = \ln(u/\mu) = 0$  where  $u/\mu$  is the threshold of just noticeable stimuli;
- 2) time intervals  $(0, 1, \dots, t-1, t)$  are successive time intervals of discretely presented stimuli that represent the actually continuous perception process in real life;
- 3)  $w < 1$  a proportional weight that depends on the length of the time interval for the exposure to stimulus  $i$ .

For focal stimulus  $x_{i,t}/\mu$  the Markov sequence of  $n$  sequentially random stimuli in equal exposure intervals  $t$  the updated adaptation level becomes defined by a constant  $w$ , where for  $i=1$  at  $t=1$ ,  $i=2$  at  $t=2$  and so on to  $i=n$  at  $t=n$  for sequential presentations of  $n$  different stimuli, we obtain the sequence

$$\begin{aligned} \ln(b_1/\mu) &= (1-w) \cdot \ln(b_0/\mu) + w \cdot \ln(x_1/\mu), \\ \ln(b_2/\mu) &= (1-w) \cdot \ln(b_1/\mu) + w \cdot \ln(x_2/\mu), \\ \ln(b_3/\mu) &= (1-w) \cdot \ln(b_2/\mu) + w \cdot \ln(x_3/\mu) \end{aligned}$$

and by substitution

$$\ln(b_2/\mu) = (1-w)^2 \cdot \ln(b_0/\mu) + (1-w) \cdot w \cdot \ln(x_1/\mu) + w \cdot \ln(x_2/\mu),$$

and

$$\ln(b_3/\mu) = (1-w)^3 \cdot \ln(b_0/\mu) + \sum_{i=1}^{i=3} (1-w)^{3-i} \cdot w \cdot \ln(x_i/\mu).$$

For any  $t$

$$\ln(b_t/\mu) = (1-w)^t \cdot \ln(b_0/\mu) + \sum_{i=1}^{i=t} (1-w)^{t-i} \cdot w \cdot \ln(x_i/\mu).$$

It defines a sequential Markov averaging process that, by  $(1-w) < 1$  and large enough values of  $t$ , reduces to

$$\ln(b_t/\mu) \approx \sum_{i=1}^{i=t} (1-w)^{t-i} \cdot w \cdot \ln(x_i/\mu).$$

For randomly selected stimuli from a set of relatively similar stimuli  $\ln(x_{ik}/\mu) = \ln(b_k/\mu) + \ln(x_{ik}/b_k)$ , where the dimensional sensations  $\ln(x_{ik}/b_k)$  randomly deviates by relatively small amounts from zero, it will soon show a rather static adaptation level  $\ln(b_k/\mu)$ , because then

$$\ln(b_{tk}/\mu) = \sum_{i=1}^{i=t} (1-w)^{t-i} \cdot w \cdot [\ln(b_k/\mu) + \ln(x_{ik}/b_k)]$$

by  $w < 1$ ,  $t$  large enough, and randomly deviating small terms  $\ln(x_{ik}/b_k)$

$$\sum_{i=1}^{i=t} (1-w)^{t-i} \cdot w = 1 \quad \text{and} \quad \sum_{i=1}^{i=t} (1-w)^{t-i} \cdot w \cdot \ln(x_{ik}/b_k) = C.$$

reduces by replacing just noticeable level  $u$  for arbitrary scale factor  $\mu$  for  $\ln(b/u) = a$  with just noticeable sensation level  $\ln(u/\mu) = 0$  to

$$a_{tk} = \ln(b_{tk}/u) = \ln(b_k/u) = a_k.$$

However, for not similar and randomly selected stimuli we obtain for  $t-1$  and large enough  $t$  by  $w < 1$  still approximately

$$\sum_{i=1}^{t-1} (1-w)^{t-1-i} \cdot w \cdot \ln(x_{ik}/b_k) = e_{t-1} \approx 0,$$

whereby

$$\ln(b_{tk}/u) = \ln(b_k/u) + w \cdot \ln(x_{ik}/b_k),$$

or

$$\ln(b_{tk}/u) = (1-w) \cdot \ln(b_k/u) + w \cdot \ln(x_{ik}/u),$$

or

$$a_{tk} = (1-w) \cdot a_k + w \cdot y_i.$$

Similarly it holds for sequences of presented pairs of stimuli, where stimuli  $(i,j)$  are randomly chosen from a fixed set with an average sensation  $\ln(b/u)$ , that

$$\ln(b_t/u) = \sum_{i,j=1}^{t-1} (1-w)^{t-i} \cdot w \cdot [\ln(b/u) + \frac{1}{2} \{ \ln(x_i/b) + \ln(x_j/b) \}],$$

can be rewritten for  $\{i,j\} = (1,2, \dots, t-1,t)$  by

$$e_{t-1} = \sum_{i,j=1}^{t-1} (1-w)^{t-1-i} \cdot w \cdot \frac{1}{2} \{ \ln(x_i/b) + \ln(x_j/b) \},$$

where for values of  $w$  smaller than unity the sum term of  $e_{t-1}$  still soon approaches zero for enough presented random stimulus pairs  $i,j$  and thus

$$\ln(b_t/u) = (1-w) \cdot \ln(b/u) + \frac{1}{2} w \{ \ln(x_i/u) + \ln(x_j/u) \}$$

or

$$a_{tk} = (1-w) \cdot a + \frac{1}{2} w [y_i + y_j].$$

Here the shift of the adaptation level towards the midpoint sensation for  $y_i$  and  $y_j$  will be the larger the longer the exposure interval or the eraser  $w$  to unity is and the larger the difference between the average sensation  $a$  and sensation midpoint  $\frac{1}{2}(y_i + y_j)$  is.

In the mathematical section above we derived for stimulus intensities  $x_i/u$ , where  $u$  as just noticeable level replaces an arbitrary unit of their ratio-scale terms, a Markovian averaging process of sensations from presented stimuli that defines the momentary adaptation level  $a_t = \ln(b_t/u)$  by

$$a_t = (1-w) \cdot a + w \cdot y_i$$

for sensory stimulus  $i$  that is presented in time interval  $t$  and where weight  $w$  depends on the length of the time interval for the exposure to stimulus  $i$ . For randomly selected and in equal time intervals, sequentially presented stimuli from a fixed set of stimuli, it is shown that the value of the momentary adaptation level soon approximates average adaptation level  $a = \ln(b/u)$  for the whole stimulus set. Partial adaptation to a sensory stimulus pair causes a shift of the adaptation level towards the location of the average sensation  $\frac{1}{2}(y_i + y_j)$  of the presented stimuli  $(i,j)$ , which is expressed by

$$a_t = (1-w) \cdot a + \frac{1}{2} w (y_i + y_j).$$

These shifts are the larger the longer the stimulus exposure is, which is expressed by increases of weight  $w$  satisfying  $0 < w \leq 1$  and also the more the average sensation of the focal stimuli deviates from the average adaptation level for the whole set of stimuli.



If the intensities of the stimuli in the set vary in a relatively small range and the stimuli are randomly presented, then the adaptation level is almost static and equals  $a = \ln(b/u)$ , especially if similar stimuli are faintly presented in relatively short time intervals. These conditions may apply to stimulus-confusion studies, wherein only short exposures of faintly presented and/or rather similar stimuli will create non-zero confusion probabilities. Stimulus confusions require that  $|\ln(x_i/b) - \ln(x_j/b)| < \ln(1 + 6K)$  for Weber fractions  $\kappa$  and a relatively short stimulus exposure times, otherwise non-zero confusion probabilities are hard to obtain. For  $w < 0.125$  and  $\kappa < 0.06$  the resulting deviations from a constant level  $a = \ln(b/u)$  are then only ranging between 4% above and below the constant level. However, the presented stimuli generally differ more than six Weber fractions from the average stimulus and then may cause marked shifts of the adaptation level. It can produce asymmetry of confusion probabilities  $P_{ij}$  and  $P_{ji}$  as well as intransitivity of rank orders for confusion probabilities of stimuli with a repeated target stimulus  $j$  or  $i$ . Intransitivity can be more often expected the longer the stimulus-exposure interval is and the more the stimuli deviate from the average stimulus. Generally dissimilarity evaluations concern clearly presented stimulus pairs in sufficiently long exposure intervals, where weight  $w$  can approach unity. If  $w = 1$  then it defines that the momentary adaptation level is completely shifted to the midpoint sensation of the presented stimulus pair, whereby such stimulus-dependent adaptation-level shifts can cause intransitivity of symmetric similarities.

Reference levels can also depend on the memory of individuals, such as their ideal sensation level  $g = \ln(p/b)$  and their memorised adaptation level for evaluations of cognitive objects, where a memory-selected adaptation level  $\ln(b/u)$  also must be distinguished from the adaptation level  $\ln(b/u)$  for sensory stimuli. Memory-selected reference levels are relevant for responses to cognitive object presentations and are dependent on the object context and task condition of the response task for newly presented objects, but the new presentation of the object set may also cause an update of the stored level from previous stimulation of similar objects in similar task conditions. Here the update becomes the Markovian average of the relevant, stored reference level, which may also apply to set-induced levels of respectively the just noticeable level and the ideal level for the presented stimulus or cognitive object set. Thus, in principle they are assumed to be influenced by a similar Markovian averaging process, where the updates of the stored reference levels from  $(t-1)$  are averaged with the corresponding reference levels of the present exposure to the object set. The reference levels at  $t-1$  refer to their selections from the memory for similar context and/or task conditions as for the present object set, but due to the similarity selection from the memory of an individual the differences between  $[\ln(u/\mu) - \ln(u_1/\mu_1)]$ ,  $[\ln(p_1/b_1) - \ln(p_1/b_1)]$ , and  $[\ln(b_1/u_1) - \ln(b_1/u_1)]$  are relatively small or almost zero. Therefore, it yields temporarily static reference levels for:

- 1)  $\ln(u/\mu)$  as context-dependent just noticeable sensation level,
- 2)  $\ln(p/\mu)$  as context- and task-dependent ideal sensation level,
- 3)  $\ln(b/\mu)$  as memorised adaptation level in evaluation tasks for newly presented cognitive objects that are similar to cognitive object sets in previous tasks as context- and/or task-dependent selections of memorised reference levels.

In successive comparison tasks for perceptual objects with respect to successively different targets, the reference level can suddenly shift towards different levels of memorised target sensations. In cognitive evaluation tasks without target objects the adaptation level may hardly shift, but in other tasks the momentary adaptation level  $\ln(b_t/u)$

$$a_t = \ln(b_t/\mu) - \ln(u/\mu) = \ln(b/u)$$

may shift to sequential object presentation, whereby also the ideal point

$$g_t = \ln(p/\mu) - \ln(b_t/\mu) = \ln(plb_t)$$

may shift, since only  $\ln(u/\mu)$  and  $\ln(p/\mu)$  are assumed to be temporarily static levels for each stimulus set and task condition. Thereby also the corresponding Stevens' power exponents  $\tau_t = 2/a_t \dots 2/\ln(b/u)$  may become dynamic stimulus-dependent power exponents of stimulus intensities by shifts of  $\ln(b/\mu)$ , which may explain why large variances of Stevens' power exponents  $\tau$  are found. It also must be remarked that the adaptation level only can be shifted within limits, because it can't shift beyond the absolute just-noticeable or absolute saturation level. Adaptation to intensities close to threshold  $\ln(u/\mu) = 0$  will shift the adaptation level towards the threshold, whereby distance  $\ln(b/\mu) - \ln(u/\mu) = \ln(b/u) > 0$  becomes smaller, which predicts Stevens power exponent  $\tau_t = 2/\ln(b/u)$  to increase, as is known to occur since long (Luce and Galanter, 1963b, pp. 276 and 281) for stimulus ranges close to the absolute threshold. It also implies that the Weber fraction  $\kappa$  for  $\kappa_t$  close to the perception threshold is no longer constant and must systematically become larger the closer the stimuli are to the perception threshold of a modality, as a reduced discrimination sensitivity between stimuli in that range. The constancy of fraction  $\kappa_t$  also can't hold for stimulus ranges close to saturating intensity, since adaptation level  $b/u$  can't exceed the saturation level. It also implies that the discrimination sensitivity will decrease for stimulus intensity levels close to the saturation level of a modality (for example: brightness differences at glare level). Both phenomena are indeed observed for several Weber fractions near absolute thresholds and near saturation levels (Luce and Galanter, 1963a, p. 204, fig 6). However, most studies concern stimuli that range from fairly above the absolute just noticeable level to fairly below the absolute saturation level.

### 7.1.2. Target.stimulus dependence of adaptation-level shifts

Adaptation level  $a_t = \ln(b/u)$  can be almost static for short presentations of stimuli that are randomly varying in atmidrange of dimensional sensation intensities, which will be called a homogeneous stimulus set or homogeneous context of presented stimuli (adjective 'homogeneous' refers here not to its measurement-theoretic meaning). The average sensation for a stimulus set defines the average adaptation level  $a = \ln(b/u)$  for the average observer of all stimuli in the set, while we define momentary shifted adaptation level  $a_t$  with shift  $(a_t - a)$  at time  $t$  with respect to the average adaptation level. Presented stimuli from nonhomogeneous contexts shift more or less the existing adaptation level to levels  $a_t = \ln(b_t/u)$  and the ideal levels  $g_t = \ln(plb_t)$  in a stimulus-dependent way, the latter due to stimulus-dependent shifts of  $\ln(b_t/u)$  and respectively, almost static reference levels  $\ln(u/\mu)$  and  $\ln(p/\mu)$ . Shifts of adaptation level can become systematic in studies that selectively present nonhomogeneous stimuli and are

cumulative if stimuli are presented in the order of their intensities. The design of the stimulus presentations in studies on judgmental and preferential evaluations of stimuli is thus crucial for shift effects of the adaptation and ideal levels.

Randomly selected and sequentially presented stimuli from a nonhomogeneous set cause shifts of the average adaptation level towards the sensation of the presented stimulus, where the shift depends of the extremeness and exposure time of the stimulus. This also holds for homogeneous stimuli when the time interval of the stimulus exposure is relatively long or when presented in short time intervals and compared to a repeatedly and simultaneously presented target stimulus, where in the last case the adaptation level will dominantly shift towards the sensation of the target stimulus. It then concerns a study design with  $n$  sequences of stimulus pairs  $(i|j)$ , wherein shortly exposed random stimuli  $i$  are compared with a repeatedly presented fixed stimulus  $j$  within each sequence of a subsequently other target stimulus  $j$ . If we have study designs wherein a randomly selected stimulus  $i$  is evaluated for its similarity (or is confused) with a cognitive stimulus  $j$  (or is categorised as belonging to stimulus category  $j$ ) from a memorised similar stimulus set  $S_m$ , then sensations of stimuli  $i$  are compared with the respective sensations of memorised stimuli  $j$ . Thereby, the adaptation level shifts towards the internally repeated sensation of target stimulus  $j$  and subsequently shifts towards the respective sensation levels for subsequently other target stimuli. These shifts are the more complete the longer the allowed response time and the shorter the stimulus exposure are.

The adaptation level for stimuli  $i|j$  at sequential time interval  $t=i$  for a unidimensional stimuli  $i$  and a fixed, target stimulus  $j$  becomes updated more by the sensations for the repeated target stimulus  $j$  than by the different sensations of randomly selected stimuli  $i$ , where

$$\ln(b_t/u|j) = \sum_{i=1}^{i=t} (1-w)^{t-i} \cdot w \cdot [\ln(b/u) + \frac{1}{2}\{\ln(x_i/b) + \ln(x_j|b)\}]$$

with  $u/\mu$  as the just unnoticeable level for the set of stimuli. It is rewritten by  $a = \ln(b/u)$  as

$$a_t |j = \sum_{i=1}^{i=t} (1-w)^{t-i} \cdot w \cdot [a + \frac{1}{2}\{\ln(x_i/b) + \ln(x_j|b)\}]$$

For a sequence of different stimuli  $i$  around  $x_i/b = 1$  with respect to repeated sensations for target stimulus  $j$ , it rewrites by

$$\sum_{i=1}^{i=t} (1-w)^{t-i} \cdot w \cdot [a + \frac{1}{2}\{\ln(x_j/b)\}] \approx a + \frac{1}{2}\ln(x_j/b)$$

as

$$a_t |j = a + \frac{1}{2}\ln(x_j/b) + \sum_{i=1}^{i=t} (1-w)^{t-i} \cdot w \cdot \frac{1}{2}\ln(x_i/b)$$

After enough presentations of randomly selected stimuli  $i$  with positive and negative sensations its sum term for  $t-i-1$  approximates

$$\sum_{i=1}^{i=t-1} (1-w)^{t-1-i} \cdot w \cdot \frac{1}{2}\ln(x_i/b) \approx 0$$

whereby

$$a_t |j \approx a + \frac{1}{2}[\ln(x_j/u) - \ln(b/u)] + \frac{1}{2}w \cdot [\ln(x_i/u) - \ln(b/u)]$$

or

$$a_t |j = \frac{1}{2}[(1-w) \cdot a + Y_j + w \cdot y_i]$$

However, stimulus confusions  $i|j$  concern short presentations of faint stimuli  $i$ , where for non-zero confusion probabilities  $w$  must be very small and  $|\ln(x_i/b) - \ln(x_i/b)| < 6d/b$  for  $d/b = K$  as Weber fraction. By  $w$  approaching zero we see that  $a_t |j$  hardly differs from

$$a_t |j = \frac{1}{2}[a + y_j]$$

For unidimensional random stimuli that are compared to a target stimulus  $j$  from a memorised similar set  $S$  the reference level for the comparison is the memorised sensation  $\ln(x_j/u)$  of the target stimulus and writes as

$$a_t |j, S = \sum_{j=1}^{j=t} (1-w)^{t-j} \cdot w \cdot \frac{1}{2} [\ln(x_j/u) + \ln(x_i/u)]$$

For enough repetitions of target  $j$  it simplifies by approximations of

$$\sum_{j=1}^{j=t} (1-w)^{t-j} \cdot w \cdot \frac{1}{2} [\ln(x_j/u)] \approx \frac{1}{2} \ln(x_j/u)$$

and for  $\ln(x_i/u) = \ln(b_i/u) + \ln(x_i/b_i)$  and  $t-1$  presentations of the different stimuli  $i$  of  $S$

$$\sum_{j=1}^{j=t} (1-w)^{t-j} \cdot w \cdot \frac{1}{2} [\ln(x_j/u) + \ln(x_i/u)] = \frac{1}{2} \ln(x_j/u) + \frac{1}{2} w \cdot \ln(x_i/u)$$

to

$$a_t |j, S = \ln(x_j/u) + \frac{1}{2} w \cdot \ln(x_i/u)$$

or

$$a_t |j, S = (1 - \frac{1}{2}w) \cdot y_j + \frac{1}{2}w \cdot y_i$$

For long time intervals of comparisons  $i|j$  the terms for the factor  $w$  may approach unity, where then

$$a_{t,i} |j, S = \frac{1}{2}[y_j + y_i] \quad |w|=1$$

In the mathematical sections above it is shown that a shift from the average adaptation level to the momentary adaptation level  $a_t$  depends on the design of the stimulus presentations and the evaluation task. In designs, wherein stimuli  $i$  are compared in successive sequences with respect to a repeatedly shown target stimulus  $j$ , the shifts are stimulus-dependent shifts toward the target-stimulus sensation for each comparison sequence. The momentary dimensional adaptation level is expressed by

$$a_{itk} |j = \frac{1}{2} [(1-w)a_k + Y_{jk} + w \cdot y_{ik}]$$

for  $y_{ik} = \ln(x_i/u_k) > 0$  as dimensional target sensation in stimulus confusion designs. Weight  $w$  reduces to almost zero, if shortly presented, faint stimuli  $i = 1$  to  $i = n$  are compared with a repeatedly presented target stimulus in successive sequences for similar targets  $j = 1$  to  $j = n$ . It simplifies the expression for the momentary adaptation level  $a_k$  per comparison sequence, due to the dominating influence of repeated stimulus  $J$ , to

$$a_{itk} |j = \frac{1}{2}(a_k + Y_{jk})$$

We see that the momentary adaptation level for a comparison sequence can be an enlarged or a reduced adaptation level compared to the average adaptation level  $a_k$ , depending on whether  $y_{jk} > a_k$  or  $y_{jk} < a_k$ . However, for stimuli  $i$  in pairs  $(i|j)$  from non-homogeneous sets of stimuli that are exposed long enough to detect differences

between  $i$  and fixed stimulus  $j$  we have, by the repeated sensation of stimulus  $j$  and the non-negligible influence of the momentary sensation of stimulus  $i$ , a shift that remains defined by  $a'_{ik,t}(j) = \sqrt{2}[(1-w) \cdot a_{ik} + y'_{ik} + w \cdot y'_{jk}]$ , where  $0 < w < 1$  is dependent on the length of time intervals for exposure of stimulus pair ( $i|j$ ) and where  $w$  approaches unity the more the longer that exposure time is,

For evaluation tasks where randomly presented stimuli  $i$  are compared with respect to successive reference targets  $j$  from a memorised similar stimulus set  $S_m$ , the adaptation-level shift for comparisons of different sensations  $i$  with the internally repeated sensation for the selected reference target  $j$  is written by

$$a'_{ik,t}(j, S_m) = e^{t} \cdot \sqrt{2}w y'_{jk} + \sqrt{2}w y'_{ik}$$

Compared to the expression for single-stimulus-dependent shifts of presented target stimulus shows by the difference in factor  $w$  and  $\frac{1}{2}w$  that the shifts are smaller for memorised reference targets than for presented targets. If the response comparison time is long enough, however, then the influence of stimulus  $i$  increases and for long comparison times  $w=1$ , whereby then

$$a'_{ik,t}(w=1, j, S_m) = \frac{1}{2}(y'_{jk} + y'_{ik})$$

In the study designs for clearly presented stimuli  $i$  with respect some target  $j$  and shifted dimensional adaptation level  $a_{Jjk}$  for individual  $J$  we write the intensity-comparable sensation dimension  $k$  as

$$s_{ik}(j) = 2\{y_{ik}/a_{Jk} - 1\} = 2\{(y_{ik}/a_{Jk})/[(1-w) + w \cdot y'_{jk}/a_{Jk}] - 1\}$$

where  $a_{Jk}$  is the average adaptation level and where factor  $0 < w < 1$  depends on the individual and the exposure time of randomly presented stimuli  $i$  that are evaluated with respect to a presented or memorised target stimulus  $j$ . Here  $2\{y_{ik}/a_{Jk} - 1\}$  is the redefined dimensional sensation in the individual Bower space of intensity-comparable sensations, but due to the dynamics of adaptation towards experienced sensations it becomes smaller, if target  $y'_{jk} > a_{Jk}$ , and larger, if  $y'_{jk} < a_{Jk}$ . Notice also that for sensory stimulus sets, instead of cognitive objects, the shifts generally are with respect to the common average adaptation level for the stimulus set, which then defines for  $w_J = w$

$$s_{ik}(j) = 2\{y_{ik}/a_{jk} - 1\} = 2\{(y_{ik}/a_k)/[(1-w) + w \cdot y'_{jk}/a_k] - 1\} \quad a_{Jk} = a_k$$

Thus the dimensional sensations in the Bower space become adaptively changed by the shifts of the average adaptation level towards the sensation for the stimulus  $j$  in each sequence of pairs ( $i|j$ ) with randomly chosen stimuli  $i$ . Intensity-comparable sensation dimensions can also be written as

$$s_{ik}(j) = y_{ik} \cdot \tau_{Jk} \cdot \lambda_{Jjk} - 2,$$

where

$$\tau_{Jk} = 2/a_{Jk} \quad \text{and} \quad \lambda_{Jjk} = 1/[(1-w) + w \cdot y'_{jk}/a_{Jk}].$$

Thus, here these adaptation-level shifts can also be expressed by multiplicative terms of power exponents and their proportional deviation from the shift that depends on the target stimulus, the exposure time, and eventually the individual. However, if it concerns nonhomogeneous stimuli  $i|j$  or relatively long exposures of homogeneous

random stimuli  $i|j$  then the influence of stimulus  $i$  can't be neglected and then

$$s_{jik} = 2\{Y_{ik}/[V2\{(1-w) \cdot a_{jk} + Y_{jk} + w \cdot Y_{ik}\}] - 1\}$$

or if  $a_{jk} = a_k$  and  $w_J = W$

$$s_{ik} = 2\{y_{ik}/[1/2\{(1-w) \cdot a_k + Y_{jk} + w \cdot Y_{ik}\}] - 1\},$$

where the adaptation-level shifts can't be rewritten by multiplicative terms..

Although similarity responses concern response space distances that for the same stimuli have different response space configurations for different stimulus-dependent shifts of adaptation levels, it is instructive to consider also the influence of shifted adaptation levels on sensation distances in the intensity-comparable sensation space. The sensation distances between  $i$  and  $j$  in the Fechner-Helson space are not influenced by shifts of adaptation level, but their distances in the intensity-comparable sensation space change due to the weighing by twice the inverse value of the shifted adaptation levels, where a shifted dimensional adaptation level for  $Y'_k < a_k$  relatively increases the dimensional distance  $d_{ijk}/a_k$  and for  $Y'_k > a_k$  its distance is relatively reduced. The corresponding response distances thus change also, but even response distances for equal intensity-comparable sensation distances become changed, because the projective transformations of intensity-comparable sensation spaces to open response spaces depend on its shifted adaptation level as projection origin. The next table shows for selected sensation  $y_i$  from 1 to 9 and  $y_i = 4$  and  $y_i = 5$  their weighted unidimensional distances  $d_{i,j} \cdot a_i$ , their distances  $d_{i,j} \cdot a_i = |y_i - y_j| / [1/2a + 1/2Y_j]$  for  $W=V2$  and an original adaptation level  $a=3$ , and their distances  $|r_i - r_j|$  on an open-Euclidean response dimension that corresponds to a hyperbolic sensation dimension with responses  $r_i = \tanh\{-y_i/[1/2a + V2Y_i] - 1\}$  and  $r_j = \tanh\{-y_j/[1/2a + V2Y_j] - 1\}$

col.	A		B		e		o		column ratio		
$y_i=4$	$y_i=5$	$y_i=4$	$y_i=5$	$y_i=4$	$y_i=5$	$y_i=4$	$y_i=5$	$r_i - r_j$	$r_i - r_j$	$A/e$	$BID$
$y_j$	$d_{ij}$	$d_{ij}$	$d_{ij} \cdot a_i$	$d_{ij} \cdot a_i$	$a_j$	$d_{ij} \cdot a_i$	$d_{ij} \cdot a_i$	$r_i - r_j$	$r_i - r_j$		
1	3	4	1.00	1.33	2.0	1.50	2.00	1.22	1.37	1.22	1.02
2	2	3	0.67	1.00	2.5	0.80	1.20	0.73	0.96	1.10	0.96
3	1	2	0.33	0.67	3.0	0.33	0.67	0.32	0.58	0.97	0.81
4	0	1	0.00	0.33	3.5	0.00	0.29	0.00	0.26		0.79
5	1	0	0.33	0.00	4.0	0.25	0.00	0.25	0.00	0.73	
6	2	1	0.67	0.33	4.5	0.44	0.22	0.43	0.21	0.65	0.63
7	3	2	1.00	0.67	5.0	0.60	0.40	0.57	0.38	0.58	0.57
8	4	3	1.33	1.00	5.5	0.73	0.55	0.69	0.52	0.52	0.51
9	5	4	1.67	1.33	6.0	0.83	0.67	0.78	0.63	0.47	0.47

Table: Influences on intensity-comparable sensation and response distances by shifts of adaptation level for  $w = 1/2$ ,  $a = 3$ ,  $y_i = 4$  or  $y_i = 5$  and varying values of  $y_j$ .

The table clearly shows the effect of the shifted adaptation level on the intensity-comparable sensation distances. Moreover, intensity-comparable sensation distances with midpoints in the proximity of the shifted adaptation point are relatively less reduced to response distances than the intensity-comparable sensation distances with

midpoints that are remotely located from the shifted adaptation level. For example, pairs  $(i|j) = \{412, 513, 416, \text{ and } 517\}$  have same Fechner distance  $|y_i - Y_i| = 2$  and respectively shifted adaptation levels 2.5, 3.0, 4.5, and 5.0, whereby their response distances become respectively 0.73, 0.58, 0.43, and 0.38, while pairs  $(i|j) = \{511, 418, \text{ and } 519\}$  have Fechner distance  $|y_i - Y_i| = 4$  and respectively shifted adaptation levels 2.0, 5.5, and 6.0, whereby their response distances become respectively 1.37, 0.69 and 0.63. It also causes asymmetry of intensity-comparable and response distances, as pairs (514) and (415) show. Effects from shifted adaptation levels for intensity-comparable sensations combined with effects from their transformation to responses cause that

- dissimilarity responses  $|r_{ij}|$  become relatively the larger  $I$  the more remote the Fechner sensations  $i$  are to a target sensation  $j$ , 2) the smaller the shifted adaptation point is, while the dissimilarity response becomes relatively the less reduced the closer their sensation midpoint is from the shifted adaptation level;
- dissimilarity responses  $|r_{ij}|$  become relatively the smaller  $I$  the closer the Fechner sensations  $i$  are to a target sensation  $j$ , 2) the larger the shifted adaptation point is, while the dissimilarity becomes relatively the more reduced the more remote their sensation midpoint is from the shifted adaptation level;
- dissimilarity responses  $|r_{ij}|$  become 1) increased for already similar Fechner sensations  $i$  and target  $j$  with a relatively small shifted adaptation level and 2) reduced for already dissimilar Fechner sensations  $i$  and target  $j$  with a relatively large shifted adaptation level, both with respect to their intensity-comparable sensation distance that for the former is relatively enlarged and for the latter relatively reduced with respect to their Fechner sensation distance. Thereby the latter dissimilarity response becomes a twofold reduced Fechner sensation distance, while in the former case the relative enlargement of the intensity-comparable sensation distance generally dominates over its reduction to response distance.

Single stimulus-dependent shifts of adaptation level cause that dissimilarity response  $|r_{ij}|$  becomes different from dissimilarity response  $|r_{ji}|$ . This asymmetry is caused by the usually so-called response bias that actually is better characterised as a stimulus-dependent bias. This is further discussed in the sequel and section 7.2.

### 7.1.3. Stimulus-pair dependence of adaptation-level shifts

In case sensory stimuli  $i$  and  $j$  from a nonhomogeneous context are presented in random combinations  $(i,j)$  then the dimensional shift of the adaptation level becomes a shift towards the average dimensional sensation of focal stimuli  $i$  and  $j$ , which implies that the origin for the sensation space is shifted towards the space midpoint of  $i$  and  $j$ . Intensity-comparable sensation dimensions then are defined by

$$s_{Jik}^{ij} = 2\{Y_{ik}/[(1-w_J)a_{Jk} + 1/2w_J(y_{ik} + Y_{jk})] - I\},$$

where for shifted adaptation level

$$a_{Jk}^{ij} = (1-w_J)a_{Jk} + 1/2w_J(y_{ik} + Y_{jk})'$$

we have similarly to earlier expressions

$$s_{Jik}^{ij} = 2\{y_{ik}/a_{Jk}^{ij} - I\},$$

and if  $w_J = 1$

$$s_{ik|ij} = 2\{Y_{ik}/[V2(Y_{ik} + Y_{jk})] - I\} \quad jw_J = I$$

For  $a_{jk} = a_k$  and  $w_J = w$ , as may again be assumed for the average adaptation level of a set of randomly presented, sensory stimulus pairs for each individual, we have

$$s_{ik|ij} = 2\{Y_{ik}/[(1-w)a_k + Y2w(Y_{ik} + Y_{jk})] \cdot I\}. \quad Ia_{jk} = a_k; w_J = w$$

What has been said for adaptation level shifts towards the sensation of memorised target stimulus  $j$  or a repeatedly presented stimulus  $j$  here mainly applies also to adaptation level shifts towards the space-midpoint of  $i$  and  $j$  in the Bower space. Its effects on response space distances similarly are that

- a) dissimilarity responses  $|r_{i,j}|$  become relatively the larger 1) the larger the Fechner sensation distances between  $i$  and  $j$  are, 2) the smaller their shifted adaptation level is, and 3) the closer shifted adaptation level are to the Fechner midpoint sensation;
- b) dissimilarity responses  $|r_{i,j}|$  become relatively the smaller 1) the closer the Fechner sensations  $i$  and  $j$  are, 2) the larger their shifted adaptation level is, and 3) the more remote shifted adaptation levels are from the Fechner midpoint sensation;
- c) dissimilarity responses  $|r_{i,j}|$  generally become increased with respect to their response distance  $|r_{i,j}|$  with an unchanged adaptation level, but can become reduced for dissimilar Fechner sensations  $i$  and  $j$  with a relatively high Fechner midpoint sensation, because the relative change of the intensity-comparable sensation distance generally dominates over its reduction to response distance.

This is illustrated in the next table for unidimensional sensation pairs  $(y_i, y_j)$  with Fechner distances of 1, 2, 4, and 6 for  $w = 0.8$  and  $a = 4$ . The Fechner and intensity-comparable sensation distances for constant and shifted adaptation levels are shown as well as their open-Euclidean response distances  $|r_{i,j}| = |r_i - r_j|$  for constant adaptation level  $a = 4$  in responses  $r_i = \tanh[-(y_i/a) - 1]$  and  $r_j = \tanh[-(y_j/a) - 1]$  and respectively  $|r_{i,j}| = |L_i - L_j|$  for shifted adaptation levels  $a_{i,j} = (1-w)a + w(y_i + y_j)$  in responses  $r_i = \tanh[-(y_i/a_{i,j}) - 1]$  and  $r_j = \tanh[-(y_j/a_{i,j}) - 1]$ . The table below shows the dominating effect of adaptation-level shifts to midpoint sensations on the intensity-comparable sensation and response distances, as illustrated by the markedly different rank orders of response distances  $|L_i - L_j|$  with respect to the similar rank orders of intensity-comparable sensation distances  $|y_i - y_j|/a_{i,j}$  and response distances  $|r_i - r_j|$ .

$i, j$	$ y_i - y_j $	$ Y_i - Y_j /a$	$a_{i,j}$	$ Y_i - Y_j /a_{i,j}$	rank	$ r_{i,j} $	rank	$ r_i - r_j $	rank
0,1	1.0	0.25	1.2	0.833	7	0.126	1	0.762	7
2,3	1.0	0.25	2.8	0.357	3,4	0.217	3	0.379	4
4,5	1.0	0.25	4.4	0.227	2	0.245	4	0.236	2
6,7	1.0	0.25	6.0	0.167	1	0.173	2	0.170	1
0,2	2.0	0.50	1.6	1.250	8,9	0.299	5	1.166	9
2,4	2.0	0.50	3.2	0.625	5	0.462	7	0.643	5
5,7	2.0	0.50	5.6	0.357	3,4	0.390	6	0.362	3
0,4	4.0	1.00	2.4	1.667	10	0.762	8,9	1.436	10
4,8	4.0	1.00	5.8	0.714	6	0.762	8,9	0.701	6
0,6	6.0	1.50	3.2	1.875	11	1.224	10,11	1.523	11
2,8	6.0	1.50	4.8	1.250	8,9	1.224	10,11	1.140	8

Table: Effects of adaptation-level shifts ( $a = 4$ ;  $w = 0.8$ ) on sensation and response distances



The adaptation-level shifts towards that midpoint cause that response distances become the more enlarged the more the adaptation level shifts downward {pairs (0,1), (0,2), (0,4), (2,3), (2,4) and (0,6)} and the more reduced the more the adaptation level shifts upward {pairs (6,7), (4,8), (5,7), (2,8), and(4,5)}. However, for pairs with low Fechner midpoints the changes are larger than for pairs with high Fechner sensation midpoints, which is nicely illustrated by the pairs (0,4) and (4,8). The table also illustrates that response distances for relatively small Fechner sensation distances can become larger than for relatively large Fechner sensation distances. All dissimilarity responses for stimulus pairs with equal Fechner sensation distances show that the Fechner distances for pairs (0,j) become the largest response distance within their group of equal Fechner sensation distances, due to their lower sensation midpoint and, thus, smaller value of shifted adaptation level that by twice its inverse value as weight define relatively larger intensity-comparable sensation and response distances.

The fact that adaptation-level shifts in studies on identification of stimuli or on similarity evaluation of stimuli can systematically influence the evaluation, has already been shown by Capehart et al. (1969) in several experiments more than 35 years ago. In support for their stimulus equivalence theory Capehart and co-researchers even have demonstrated that experimentally induced systematic shifts of adaptation levels can induce a stimulus to appear more similar to another stimulus than to a copy of the stimulus itself. Such stimulus identifications are here on the one hand described by the influence of single stimulus-dependent shifts of the adaptation level on response distances, as dependent on their Fechner sensation distance and on the eccentricity and sign of the Fechner-Helson sensation of a target stimulus  $j$ . On the other hand such similarity evaluations are here described by the influence of adaptation-level shifts towards the sensation midpoint of presented stimuli  $i$  and  $j$ , where the changes of the response distances depend on their Fechner sensation distance and on the eccentricity and sign of their Fechner-Helson midpoint of pairs (i,j). Eccentric target stimuli and eccentric stimulus pairs clearly have larger stimulus-dependent shifts than target stimuli or stimulus pairs in the proximity of the geometric centroid of all stimuli. Since the average adaptation level is defined by the geometric centroid of all stimuli, central sensation pairs with small shifts hardly influence their response distances, while eccentric sensation pairs with large upward shifts reduce the response distances or with large downward shifts markedly increase the response distances.

Since familiar stimuli are stimuli with low or average stimulus intensities, unfamiliar stimuli are by definition eccentric stimuli that generally have relatively high stimulus intensities. Therefore, unfamiliar sensations cause relatively large upward shifts of the average adaptation level and thus also markedly reduced response distances with respect to their Fechner or Fechner-Helson sensation distances and to their response distances without adaptation level shifts. Unfamiliar stimuli with same Fechner sensation distances as familiar stimuli show by their upward shifted adaptation levels not only reduced intensity-comparable sensation distances, but also more reduced response distances. This follows from the projective transformation of the intensity-comparable sensation distances to distances in the response spaces, which distance transformation not only depends on the distance between the intensity-comparable sensations, but also on the distance of their midpoint to the shifted adaptation point as

projection origin. The upward adaptation-level shift for unfamiliar stimuli generally approaches not their sensation midpoint, because adaptation to unfamiliar stimuli would make them familiar. The reduction of response space distances for unfamiliar stimuli are thus in two ways dependent on stimulus-dependent shifts of the adaptation point. Single stimulus-dependent shifts of adaptation level for familiar stimulus  $i$  and unfamiliar stimulus  $j$  cause asymmetry of distances  $(ij)$  and  $(ji)$ . Single and pair-wise stimulus-dependent shifts cause also intransitivity of dissimilarities for familiar as well as unfamiliar stimuli. Their dissimilarities are no longer transitive (not satisfying the quadrangular distance inequalities, as specified by corollary 3 in section 6.1.6), because the adaptation level shifts towards the target stimuli in pairs of respectively  $(fi)$ ,  $(ij)$  and  $(fj)$  or towards the midpoints of respectively  $(f,i)$ ,  $(i,j)$  and  $(f,j)$  may increase the dissimilarity distance for familiar stimuli, while they decrease for unfamiliar stimuli, both with respect to their transitive dissimilarities with a constant adaptation level. If eccentric stimuli are added to or deleted from the set then the average adaptation point may shift markedly, which then may cause also markedly changed dissimilarity-response distances.

#### 7.1.4. Stimulus- and task-dependent attention dynamics

Weight  $w_j$  approaches the more the value of unity the longer the exposure time is, whereby the adaptation level  $a_{Jk}$  shifts to  $\frac{1}{2}(y_{ik} + Y_{jk}) :: a_{ijk}$  and for  $w_J :: 1$

$$d_{ijk}/[(1-w_J) \cdot a_{Jk} + \frac{1}{2}w_J \cdot (y_{ik} + Y_{jk})] :: d_{ijk}/a_{ijk} \quad \sqrt{2}(Y_{ik} + Y_{jk}) :: a_{ijk},$$

while if  $w_j < 1$  depends on the time of exposure to stimuli  $i, j$  then either

$$\begin{aligned} & d_{ijk}/[(1-w_J) \cdot a_{Jk} + \frac{1}{2}w_J \cdot (y_{ik} + Y_{jk})] > d_{ijk}/a_{jk} \quad \text{if } \frac{1}{2}(y_{ik} + y_{jk}) < a_{jk}, \\ \text{or} & d_{ijk}/[(1-w_J) \cdot a_{Jk} + \frac{1}{2}w_J \cdot (y_{ik} + Y_{jk})] < d_{ijk}/a_{Jk} \quad \text{if } \frac{1}{2}(y_{ik} + Y_{jk}) > a_{Jk}, \end{aligned}$$

where the last distances inequalities decrease the more to equality the closer  $w_J$  is to unity or the longer the exposure to stimuli  $(i, j)$  is. It expresses an exposure-time and stimulus-dependent weighing of intensity-comparable sensations for individual similarity evaluations of stimuli. The last two expressions mean that a dynamic increase of dimensional sensation distances occurs the more the smaller the difference between the midpoint sensation and the sensation threshold is, because intensity-comparable sensations with shifted adaptation levels towards sensation midpoints have dimensional weights that are the larger the more the dimensional midpoint sensation approaches the zero value of the dimensional sensation threshold.

On the one hand the stimulus- and exposure-dependent shifts of the dimensional adaptation levels define what in cognitive psychology is described as gradually more attention to initially less-noticeable object attributes of the dissimilarity the longer the exposure to objects is. On the other hand the dimensional sensation attributes that are unnoticeable for both stimuli clearly are irrelevant for dissimilarity evaluations, because if  $Y_{ik} :: y_{jk} :: 0$  then also  $d_{ijk} :: 0$ , which also holds for well-noticeable stimuli with unnoticeable sensation distances, independently of the stimulus exposure time. But, if the dissimilarity of a pair  $(ij)$  is compared to the dissimilarity of pair  $(g, h)$  that have well-noticeable sensation distances for dimensions whereon pair  $(i, j)$  has unnoticeable

JIS

sensations then again these dimensions will get again relatively higher weights or relatively more attention than when pair (i,j) also has well-noticeable sensation distances on these dimensions. For similarity evaluations between i and j that have unnoticeable sensations for stimulus j or  $Y_{jk} \approx 0$ , it follows from

$$d_{ijkl} = d_{ijk} / [(1 - w_j) \cdot a_{jk} + \frac{1}{2} w_j \cdot (y_{ik} + Y_{jk})],$$

by  $y_{jk} = 0$  and  $w_j = 1$  that

$$d_{ijkl} \approx d_{ijk} (w_j = 1, y_{jk} = 0) \approx 2Y_{ik} / (1 + Y_{ik}) \approx 4.$$

Thus if either stimulus j or i is unnoticeable then the corresponding dimensional sensation distance between i and j under full adaptation becomes constant, independently of the intensity of the other stimulus. Under full adaptation as  $w_j = 1$ , we further notice that well noticeable stimuli  $Y_{ik} > 0$  and  $Y_{jk} > 0$  we have

$$d_{ijkl} = d_{ijk}(w_j=1) = 2(Y_{ik} - Y_{jk}) / (Y_{ik} + Y_{jk}) < 4.$$

A Euclidean Bower distance  $d_{ijk}(w_j=1)$  for dissimilarity evaluations between i and j becomes by full adaptation to midpoint (i, j) written for  $m_i$  dimensions with  $Y_{jk} = 0$  and  $Y_{ik} > 0$  and for  $m_j$  dimensions with  $Y_{ik} = 0$  and  $Y_{jk} > 0$ , while other  $m$  dimensions have  $Y_{ik} > 0$  and  $Y_{jk} > 0$ , by

$$d_{ijk}(w_j=1) = \sqrt{4(m_i + m_j) + \sum_{k=1}^{k=m} 2d_{ijk}^2 / (Y_{ik} + Y_{jk})}$$

Similar things hold for hyperbolic Bower spaces, where  $\cosh(d_{ijk})$  becomes written by products of hyperbolic cosines for dimensional sensation distances. The dissimilarity responses for intensity-comparable sensation distances of pairs (i,j) with  $w_i = 1$  depend on the respective dimensional adaptation level shifts to  $\frac{1}{2}(y_{ik} + y_{jk})$  as the i-dimensional sensation midpoints of the presented stimuli. It represents a stimulus-dependent change of attention to dimensional attributes, where the order of distances  $d_{ijk}(w_j = 1)$  and  $d_{ifg}(w_j = 1)$  depends not on the number of dimensions with unnoticeable sensations for i or j and for g, if that number is equal for all compared pairs (i,j) and (f,g), since then

$$\sqrt{4(m_i + m_j)} = \sqrt{4(m_f + m_g)}.$$

However, if  $(m_i + m_j)$  and  $(m_f + m_g)$  are different then the order of  $d_{ijk}$  and  $d_{ifg}$  will tend to be the same as the order of  $(m_i + m_j)$  and  $(m_f + m_g)$  and equals that order if  $m$  (the number of common dimensions with well-noticeable, different sensations) is smaller than the minimum of  $(m_i + m_j)$  and  $(m_f + m_g)$ , because

$$d_{ijkl}(w_j=1; Y_{ik} > 0; Y_{jk} > 0) < 4.$$

This type of attention is induced by the presented focal stimuli and, therefore, its attention has a psychophysical and not a cognitive origin.

Some types of attention may be regarded as mainly task-dependent and memory-based. For example, in the evaluation tasks for dissimilarities of stimulus i to j, where stimuli i are presented and compared to a memorised target stimulus j, the dimensional attention differs from the discussed dimensional attention in (dis)similarity evaluations between stimulus i and j that are both presented. For this (i-to-j)-similarity the

asymmetric similarity can be explained by task-dependent, cognitive shifts of the adaptation level towards the reference sensation of  $j$  as response distance  $|r_i|$  to  $r_j = 0$ . For example, if the dissimilarity evaluation of North Korea is expressed by similarity ratings on the rating scale for similarity to China then the shift is towards the reference sensation of China and reverse in the dissimilarity evaluation of China on the rating scale for similarity to North-Korea, where the shift is towards the reference sensation of North-Korea. It yields dissimilarity evaluations of asymmetric distances  $d_{ij}$  of stimuli  $i$  with respect to target stimulus  $j$  or of  $d_{ji}$  with respect to target  $i$ , because for  $w_j = 1$  in a (i-to-j)-similarity we obtain

$$d_{i|j} = \frac{2(Y_{ik} - Y_{jk})}{Y_{jk}} = 2 \frac{y_{ik}}{Y_{jk}} - 1$$

and (j-to-i)-similarity

$$d_{j|i} = \frac{2(Y_{jk} - Y_{ik})}{Y_{ik}} = 2 \frac{y_{jk}}{Y_{ik}} - 1$$

We assume this to hold for (i-to-j)- and (j-to-i)-similarities, instead of similarities between  $i$  and  $j$ . It not only applies to similarity evaluations of cognitive objects with respect to a particular cognitive target, but also to stimulus confusions or categorisation or recognition tasks wherein faintly and/or shortly presented stimuli  $i$  have to be identified or categorised as a stimulus or category  $j$  that is not presented, but memorised. For example, in a task where a shortly presented colour  $i$  (e.g. pink) has to be identified as belonging to one colour category (e.g. purple, red, pink or orange) from a list of colour category names. This matter is further discussed in section 7.2.

Notice also that intensity-comparable sensations close to the just noticeable level are never located very eccentrically, because its weighted dimensional difference from adaptation level  $2(y_{ik} - a_{jk})/a_{jk} = 2Y_{ik}/a_{jk} - 2$  approaches minus two for  $Y_{ik}$  approaching zero. Therefore, stimulus pairs of simple stimuli (ij), which by definition have several dimension intensities below their perception thresholds, have adaptation level shifts towards eccentrically low sensations for  $i$ , or  $j$ , or  $i$  and  $j$ . Thereby, the intensity-comparable sensation distance between simple stimuli (ij) always reduces relatively less than the intensity-comparable distances for unfamiliar complex stimuli (f,g). This follows by definition, because on almost all dimensions unfamiliar complex stimuli (f,g) will have relatively high values  $Y_{fk}/a_{jk} + y_{gk}/a_{jk} > 2$ , whereby  $w_j < 1$  for

$$(df_{ij}/a_{jk}) / [(1-w_j) + \frac{1}{2}w_j \cdot (y_{fk} + Y_{gk})/a_{jk}] < d_{fg}/a_{jk}$$

For simple stimuli (i,j) with several unnoticeable sensation dimensions we have

$$(d_{ij}/a_{jk}) / [(1-w_j) + \frac{1}{2}w_j \cdot (y_{ik} + y_{jk})/a_{jk}] > d_{ij}/a_{jk}$$

because pairs of simple stimuli with  $Y_{ik} = 0$  and/or  $Y_{jk} = 0$  on several dimensions the dimensional midpoints are either zero or satisfy  $(y_{ik}/a_{jk} + y_{jk}/a_{jk}) < 2$ , whereby each of the non-zero dimensional distances satisfy

$$(d_{ijk}/a_{jk}) / [(1-w_j) + \frac{1}{2}w_j \cdot (y_{ik} + Y_{jk})/a_{jk}] > d_{ijk}/a_{jk}$$

Thus, the intensity-comparable sensation distances increase for simple stimuli (i,j) with few moderate and several zero intensities  $Y_{ik}$  and  $Y_{jk}$  and they reduce for unfamiliar

complex stimuli (f,g) with relatively high intensities  $y_{fk}$  and  $y_{gk}$  on almost all dimensions. This difference between stimulus-dependent adaptation-level shifts towards moderately low midpoint values for simple stimuli and towards relatively high midpoint values for unfamiliar complex stimuli can be seen as a stimulus-induced attention difference, where attention is high for simple stimuli and low for unfamiliar complex stimuli. Moreover, although all intensity-comparable sensation distances become reduced to response distances, the response distances for simple stimulus pairs are much less reduced than for unfamiliar complex stimuli, because the latter distances are more eccentric located. In cognitive psychology terms it means that an individual pays more attention to simple stimuli than to unfamiliar complex stimuli, but this cognitive phenomenon actually is caused by differences in stimulus-dependent adaptation level shifts. Notice that also a complexity-induced, internal repetition of complex sensations (and their mediating response sensations) may occur, which may extend over the time interval of their presentation. It then may cause a further shift of the adaptation level towards these cognitively complex stimuli or objects, comparable to longer or more often presented stimuli, whereby  $w = 1$  is approached. However, the stimulus-dependent, relatively low attention to unfamiliar, physical objects is not counteracted by a complexity-induced repetition, because the given inequalities for unfamiliar stimuli are increased if values  $w_j$  increase to  $w_j = 1$ . This also holds for sensory stimuli, where a quick sensory adaptation generally will cause that  $a_{jk} = a_k$  as identical, dimensional average and adaptation level of the stimulus set for all individuals. Cognitive psychologists generally argue that complexity and unfamiliarity attention not only depend on sensation intensities, but also on memory and knowledge of individuals, because the presented set may be complex and/or rather unfamiliar for one individual, but simple and/or rather familiar for another, dependent on their past experience with similar object sets. It implies that differences in individually stored adaptation levels  $a_{jk}$  then individually dominate over common sensory adaptation to the average sensation, which indeed would cause individually different, intensity-comparable sensation distances. We follow that cognitive psychology terminology, since it differentiates between common stimulus- and task-dependent effects and individual memory-dependent effects of cognitive unfamiliarity and complexity.

#### 7.1.5. Dual stimulus-pair dependence of adaptation-level shifts

Dissimilarity rank order evaluations between simultaneously observed pairs of stimuli or physical objects for random pairs (i,j) and (f,g) may be relatively less influenced by adaptation-level shifts, because the average adaptation level of the fixed set of stimuli then may dimensionally shift to the dimensional sensation centroids of four random stimuli of two presented stimulus pairs. It would define a double stimulus pair-dependent weight for the intensity-comparable sensation distance. The reciprocal weight then contains four sensation terms for the stimulus-dependent shifts of the individual adaptation level and for dimension k is written by

$$s_{ijkljfg} = 2\{Y_{ik}/a_{ijfgk} - 1\}$$

with

$$a_{ijfgk} = (1-w_j) a_{jk} + \frac{1}{4} w_j (y_{ik} + Y_{jk} + Y_{fk} + y_{gk})$$

If the adaptation point shifts towards the sensation space centroid of (i,j,f,g) then shifts

for randomly chosen pairs of stimulus pairs will often be minor, even for  $w_J = J$ , due to the often rather small deviations of centroids of four random space points from the centroid of all space points. Nonetheless, also sensation centroids of four stimuli can deviate from the overall sensation centroid for all stimuli, where the adaptation level-shifts are the larger the more eccentric the sensation centroid and the longer the exposure time is for the four stimuli or objects in the pair-pair dissimilarity comparison of sequentially presented pairs of stimulus or object pairs. Here the effects on response distance comparisons are thus dependent on (1) the exposure time, (2) the eccentricity of their sensation subset centroid (3) the unfamiliarity and complexity of the stimuli (where the shift is upward for unfamiliar, complex stimuli and small or downward for respectively familiar or eccentric, intensity-low stimuli), and obviously also (4) the distance differences between the pairs in the Fechner sensation space.

The overall sensation centroid for sensory stimuli or physical objects may determine individually identical, dimensional adaptation levels  $a_{Jk} = a_k$ , but adaptation level shifts are rather quick and almost complete ( $w_J = 1$ ) for long enough observed pairs of sensory stimuli or physical object pairs and, thus, may also cause that symmetric dissimilarities become intransitive. If the average adaptation levels are different for different individuals, as one generally may assume to hold for cognitively presented object pairs, then possible shifts of adaptation levels become no longer expressed by the same dimensional shift factors for all individuals, but by dimensional shift factors that are dependent on the object pairs and the individual. This implies once more that one must separately analyse for each individual the dissimilarity responses for cognitive object pairs and here also under individually different correction factors for the compared object pairs, because the individually identical terms that describe the object-dependent part of the adaptation-level shifts are also shifts with respect to individually different average adaptation levels. A similarity evaluation for pair (i,j) as more dissimilar than pair (f,g) for stimulus or cognitive object pairs that are simultaneously presented, implies a response distance comparison  $d(r_i, r_j) > d(r_f, r_g)$  that is based on responses to intensity-comparable sensations with weights of twice the inverse value of the shifted adaptation level towards the sensation centroid of stimulus subset (ijJ, g), which centroid also is the changing projection origin of the projective transformation from intensity-comparable sensation to response locations of stimuli i, j, f, and g. These dissimilarity evaluations  $d(r_i, r_j) = r_{Jij}$  requires a comparison of distances between responses

$$\text{and } r_{Ji} | i,j,f,g = \tanh(y_{Ji} a_{Jij} - 1)$$

$$r_{Jj} | i,j,f,g = \tanh(y_{Jj} a_{Jij} - 1),$$

where open-hyperbolic response space distances from flat sensation spaces specify

$$r_{Jij} | i,j,f,g = \cosh(r_{Ji} - r_{Jj}),$$

and for open-Euclidean response space distances from hyperbolic sensation spaces

$$r_{Jij} | i,j,f,g = |r_{Ji} - r_{Jj}|,$$

which equal  $\tanh[|y_{Ji} - y_{Jj}| a_{Jij} - 1]$  unless either  $y_{Ji}$  or  $y_{Jj}$  coincides with  $a_{Jij}$  where

then either  $r_{J_i}^i(i,j,f,g) = 0$  or  $r_{J_j}^j(i,j,f,g) = 0$ . For a single-elliptic response space we have responses

$$r_{J_i}^i(i,j,f,g) = \arctan[2\{y_{ij}^i a_{ij}^i f g - 1\}]$$

and

$$r_{J_j}^j(i,j,f,g) = \arctan[2\{y_{ij}^j a_{ij}^j f g - 1\}]$$

with single-elliptic response distance

$$r_{J_i}^i(i,j,f,g) - r_{J_j}^j(i,j,f,g) = \cos(r_{J_i}^i - r_{J_j}^j).$$

Here all these response space distances then satisfy symmetry

$$r_{J_i}^i(i,j,f,g) = r_{J_j}^j(j,i,f,g),$$

because pairs  $(i,j)$  and  $(j,i)$  have the same shifted adaptation level within simultaneously presented subsets of stimuli  $i,j,f,g$  and thus will show transitive and symmetric dissimilarities for the pairs from subset  $(i,j,f,g)$ . However, pairs from subset  $(i,j,f,g)$  and pairs from subset  $(i,j,f',g')$  will have differently shifted adaptation levels, whereby pair  $(i,j)$  in the dissimilarity orders of  $(i,j)$  and  $(f,g)$  and of  $(i,j)$  and  $(f',g')$  can refer to a different response space distance  $(i,j)$  and then can cause intransitivity of symmetric dissimilarity rank orders. Adaptation is complete for  $w_J = 1$  and then  $a_{ij}^i f g = a_{ij}^j f' g'$  because the term  $(1-w_J) a_{ij}^i$  vanishes, and defines

$$r_{J_i}^i(i,j,f,g) = \frac{1}{4}(y_{ik}^i + y_{jk}^j + y_{fg}^i + y_{fg}^j) = a_{ij}^i f g.$$

For several subsets of four objects with a different dimensionality it can mean that the same pair  $(i,j)$  in the subspace for  $(ij,f,g)$  and the subspace for  $(i,j,f',g')$  are evaluated with respect to different attributes that characterises each subspace of four objects. This not only is predicted to occur for sensory stimuli, but also for cognitive objects from nonhomogeneous sets of cognitive objects, where dimensionally different subsets can cause suddenly shifted adaptation levels for cognitive object subsets. In sequentially presented pairs  $(i,j)$  and  $(f,g)$  it may be that the adaptation level firstly shifts to the sensation midpoint of  $(i,j)$  and then secondly to the sensation midpoint of  $(f,g)$ , whereby we also have symmetric similarities that may become intransitive. Dissimilarity evaluations generally are evaluations between stimulus or object pairs with stimulus- or subset-dependent response distances that may yield intransitive rank orders of symmetric dissimilarities.

#### 7.1.6. Dynamic cognition and preference relativity

The average adaptation levels of individuals can be more or less identical for fixed sets of (sensory) stimuli or physical objects, but in studies where cognitive objects are presented by words this may not hold if the educational and cultural background of individuals are different. The adaptation and the ideal levels for a set of cognitive objects are not primarily based on the momentary set of presented cognitive objects, but mainly on the memory-stored, temporarily static levels for similar previous sets of cognitive objects that are associated to the presented set of cognitive objects. The memorised adaptation levels may very well be different for individuals, due to differences in cognitive learning history and affective development. Individual ideal levels certainly are different, because every individual has a different history of

affective reinforcements for the same objects. Although cognitive adaptation levels are based on individual memories of adaptation levels for cognitive object sets that are similar to the presented cognitive object sets, also the presented cognitive objects within the set may cause some momentary shifts of the adaptation level towards the presented cognitive objects, especially if the association with the physical objects is reinforced. Such shifts for cognitive objects generally are absent or minor, because based on memorised reference levels from similar object contexts in the past. Nonetheless, also presented cognitive objects that refer to physical objects or stimuli from a nonhomogeneous set of cognitive objects may partially shift the average adaptation level for the set in similar ways as for sensory stimuli. Moreover, as discussed before, subsets of cognitive objects with a different dimensionality as well as similarities of cognitive object  $i$  with respect to target objects  $j$  «or object pair  $ij$  with respect to target object pairs  $f,g$ ) may relate to individually other stored reference levels for the respective target objects or subsets, because the memorised sensation contexts for such memorised target or subset sensations can be individually different. Thus, the momentary adaptation or reference or ideal level for cognitive objects can partially shift in a gradual way, if there exist associations with corresponding physical objects. Nonetheless, suddenly shifted adaptation or reference levels likely can be more often expected, if subsets of cognitive objects are characterised by different attribute subspaces or  $i$  likely more often if the evaluation task requires the selection of different reference levels. In subsection 7.4.2. we extensively discuss intransitivity of utility- and risk-dependent preferences that are shown to be caused by adaptation-level shifts or by a different attribute dimensionality of gamble subsets.

Only for individuals with a common educational and cultural background the stored adaptation levels for cognitive object sets and subsets will be similar and otherwise most likely different. Moreover, different repetitions of presented cognitive objects and a temporary deletion of objects, as well as a temporary addition of objects, also for objects that are characterised by same dimensional attributes, will also cause a shift of the adaptation level with respect to the adaptation level for a fixed set of cognitive objects that are equally frequent presented. The shift of the adaptation level is then towards the most frequently presented or added objects and away from the deleted objects. Such shifts are mathematically comparable to adaptation-level shifts for nonhomogeneous sensory stimuli, but actually are often sudden discontinuous shifts that are caused by selection of other static levels in memorised attribute subspaces for different (sub)sets of cognitive objects. Moreover, cognitive objects need not to be characterised by common dimensional attributes, but may have individually different dimension attributes, such as the individually different unfamiliarity, novelty, complexity and/or ambiguity of cognitive objects. due to different past experiences of individuals with the same cognitive objects. Cognitive object sets or subsets then can individually differ in complexity, unfamiliarity, novelty, and/or ambiguity and then not only may refer to other stored contexts and conditions for subsets with individually different, stored reference levels, but also may induce, thereby, differences in cognitive attention to attribute dimensions. Inter- and intra-individual differences in cognitive attributes for cognitive objects can again cause differences in intensity-comparable sensations and especially for individually eccentric object pairs, where complexity



attention also can produce internal repetition of the sensations and mediating response-sensations that are associated with the cognitive objects. Similar to prolonged presentations of physical objects it then may cause also complete adaptation-level shifts to cognitive objects, while cognitive objects from nonhomogeneous sets also may have dimensionally different object subsets. Thus, mainly nonhomogeneous contexts of cognitive objects will cause that the reference levels differ and/or shift intra-individually, because such sets of cognitive objects contain subsets that are characterised by different dimensions for each subset. The type of similarity evaluation is important, as it is for similarity evaluations of objects (i,j) with respect to target pair (f,g) and adaptation-level shifts to the sensation midpoint of (f,g).

The ideal level  $g_j = \ln(p_j/b_j) = V_2 \ln(z_j/f_j)$  is defined by a fixed stored saturation level  $s_j = \ln(z_j/u_j)$  and the possibly shifting adaptation level  $a_j = \ln(b_j/u_j)$ , whereby also the ideal level shifts if the adaptation level shifts. Due to the fact that  $s_j$  is constant and  $g_j = 1/2(s_j - a_j)$ , the ideal level shifts by half the shift of the adaptation level. For intensity-comparable and valence-comparable sensation dimensions these dimensional adaptation and ideal levels determined by  $21a_j$  and  $111g_j$  dimensional sensation weights that are equal if the deprivation level equals the just noticeable level. These weights not only are individually different, but also differ intra-individually for so far as the adaptation level shifts to presented cognitive objects or shifts suddenly to individually different stored levels for object subsets that have different dimensional attributes. Valence-comparable sensations are weighted sensation differences with respect to the ideal level and, thus, also depend on ideal level shifts from adaptation level shifts. The dependence of the ideal level on the adaptation level also tells that ideal level shifts for valence-comparable sensations are half as large as the adaptation-level shifts. Since valences are defined by multiplicative response functions of weighted sensation distances to the ideal points (weighted by the inverse distance between the ideal and adaptation points), shifted adaptation levels characterise also valence space changes.

In summary: comparable sensations are weighted sensation differences with respect to the adaptation or ideal level, which are weighted by twice the inverse value of the distance between the adaptation and just noticeable levels or by the inverse value of the distance between the ideal and adaptation levels, where the shift of the adaptation level can be task-dependent and different for different individuals and are different within an individual if (1) momentary adaptation-level shifts to stimuli or objects are present and/or (2) if presented stimuli or object pairs or subsets have a reduced dimensionality or (3) if task-dependent selections of reference levels for target stimuli or objects are induced. The changes of stimulus or object subset dimensionality and/or dimensional weights influence the values and distances of comparable sensations and, therefore, influence response differences and distances and single-peaked valence values. Individual, memory-dependent and/or object-dependent shifts in adaptation levels and/or dimensionality reductions cause the response-space distances to be different, due to the projective response transformation of the intensity-comparable sensation space with respect to the individually shifted adaptation or ideal levels as projection origin. Shifts of the adaptation level  $a_j = \ln(b_j/u_j)$  influences the ideal point  $g_j = 1/2 \ln(p_j/b_j)$ , while single-peaked valences depend on the distance between the ideal and adaptation levels, also single-peaked valences depend in similar ways on object-

dependent adaptation-level shifts. The dimensionality of presented object or stimulus subsets and individual adaptation-level shifts are dynamically dependent on momentary perception of sensory stimuli and are conditionally dependent on temporary selections of different, static reference levels for the context and task of the evaluation of sensory stimuli. For cognitive objects these temporary static levels can be different for individuals, but may also vary within individuals by object-dependent shifts of the adaptation level and dimensionality differences and/or by task-dependent selections of other temporary static, cognitive reference levels for object subsets or target objects.

Therefore, all judgment and preference measurements are dynamically relative measurements with respect to individual reference levels, that may quickly shift in a stimulus-dependent way by sensory adaptation or can slowly shift by adaptation to cognitive objects that refer to physical objects, as well as can suddenly shift to selected, temporarily static reference levels for subsets of cognitive objects with a possibly different dimensionality or to task-dependent cognitive target objects. These dynamically relative judgment or preference measurements concern measurements in intra-individually different response or valence spaces that are defined by the respective isomorphic space transformations of the intensity- or valence-comparable sensation spaces that depend on the dynamically changing adaptation and/or individual ideal levels and/or depend on dynamically changing subspace dimensionality. One has to recognise that the manner and order of stimulus or object presentation and the type of evaluation task are crucial determinants for shifts of adaptation level and/or changing reference level for selected subspaces with their dynamic effects on individual responses or valences.

## 7.2. Perception research and dynamic similarity relativity

Individuals are characterised by different adaptation levels, because their histories of location in space and time have provided different stimuli in different contexts. Over the course of time this also causes shifting adaptation levels within individuals. Nonetheless, the average intensity levels of sensory stimuli can often become their common adaptation level. For example, in daylight we all perceive the same mixture of colours, whereby we all are adapted to white and the same level of brightness for the daylight context. Only in the exceptional cases of coloured light circumstances one adapts to the different colour and brightness of the exceptional illumination context. In a dark-red context a bright-red stimulus may induce a colour conversion, as illustrated by Helson's (1964) experience that the top of his burning cigarette appears as green in his scarcely red-illuminated dark room. Since sensory adaptation is quick and individual memories of perceptual objects generally are almost identical, the adaptation points of individuals that are exposed to same perceptual stimuli from a homogeneous context in psychological experiments, will be almost identical for all individuals that have no abnormal perception capacities. Consequently the individual response distances for dissimilarity evaluations of randomly selected stimulus pairs from a prior-known, homogeneous set of sensory stimuli will be (almost) identical, because referring to identical average and hardly shifted adaptation levels, where set homogeneity refers to normal-distributed stimuli within restricted stimulus-intensity ranges. Euclidean

MDS-analyses of aggregated individual dissimilarities may then yield stimulus configurations that fit the dissimilarity rank orders. This holds despite the fact that the response space is not Euclidean, but open-Euclidean, single-elliptic, or open-hyperbolic, because the Euclidean space representations are then common to all individuals. It then is not recognised that the configuration is contained in an open response space, but several spatial configurations with a common adaptation point as centre in a  $m$ -dimensional response space are as well represented in a  $m$ -dimensional Euclidean space, even if the response space is open-hyperbolic or single-elliptic. For example, the colour circle in any open response space (single-elliptic, open-hyperbolic or open-Euclidean) with the adaptation point for white as centre remains a circle in a Euclidean space. A stimulus context of simultaneously presented stimuli may yield a common response space for all observers, but the response space differs from the stimulus space. For example, observers of the open field have identical adaptation levels for their visual space, but the open response geometry of the visual space differs from the open field geometry, as further discussed in the next section.

#### *7.2.1. The visual space as open-Euclidean response space*

The nature of the geometry for the visual space (VS) of the three-dimensional, objective space has been extensively researched. We can't give detailed references to the relevant experimental studies in the rich literature on the nature of the VS, but refer to Suppes (2002, sections 6.4 to 6.8) and to Luce et al. (1995) for VS-research overviews and references, while Indow (1997) and Helier (1997, 1998) contain discussions on the apparently non-Euclidean phenomena of the VS. If it is taken for granted that visual stimulus space is a three dimensional Euclidean space (ES) then our psychophysical response theory specifies the VS to be an open-Euclidean, three-dimensional response space that derives from the hyperbolic tangent transformation of the hyperbolic space of comparable sensations of the ES. Thus, the VS is specified by the involution of a dimensionally power-raised ES with respect to dimensionally different unit points of the observer. It is important to recognise that the dimensional unit points are adaptation points that not only are defined by the dimensional range midpoints of visual stimuli, but also by the observer's position with respect to the stimulus configuration in the ES. Thereby, dimensional adaptation levels and, thus, also the dimensional power exponents of their subjective stimulus magnitudes, may differ for equal length, height, and depth stimuli. For centrally perceived stimuli at eye level the dimensional adaptation level of horizontal lengths at any distance from the observer is the length-range midpoint itself, but for central heights it is the geometric average of the height stimuli and their altitudes with respect to the (perspective-projected) eye level, while for central depths it becomes the geometric average of the depth stimuli and the distance between the depth stimuli and the observer. Therefore, the open-Euclidean geometry of the VS is not defined by involutions of rotated ES dimensions, but the VS generally is an involution of differently power-raised ES dimensions with respect to dimensionally different unit points, due to differences between dimensional adaptation levels that define different weights for comparable length, height, and depth dimensions of the visual sensation space. It would deserve a more elaborate treatment, but based on the arguments given below we conjecture that an adequate description of the VS is given by the open-Euclidean response geometry of the VS as context-dependent

involvement of differently power-raised ES dimensions, where the context-dependence of the dimensional power exponents is specified by the dimensional stimulus ranges and the location of the observer with respect to the stimulus configuration in the ES. The arguments are briefly described by:

- 1) The so-called parallel alley in the VS (series of light stimuli that are subjectively placed on straight parallel lines symmetrically to the left and right of the observer in a dark room) corresponds to diverging lines in the ES. Since parallels diverge in the hyperbolic space, it has been the basis for Luneburg's (1947) theory of a hyperbolic geometry for the VS of binocular vision. However, the open-Euclidean VS as visual response space also says that horizontal lines of equal length in the ES are subjectively the larger the closer they are displayed to the observer, because then also defining response space distances that are larger the closer they are to the adaptation point as response space centre of the observer, which explains why the equidistant parallel alley in the VS corresponds to diverging lines in the ES. As discussed in section 6.2.3. the power exponents of short and close, horizontal line lengths are higher (up to 1.12) than for large and remote, horizontal distances (decreasing to 0.88). The estimation of power exponent  $\tau \approx 2 \cdot z/a$  not only depends on adaptation point  $a \approx \ln(b/u)$ , but is also on a factor  $Z$  as average of  $z$ ,  $\approx 2 \cdot r/s$ . for length responses  $r$ , to length sensations  $s$ . Since averaged sensations of length  $l$  and distance stimuli equal cognitive magnitude sensations, the estimation difference between power exponents for close and remote lines represent the response length difference between close and remote lines of equal length. Therefore, the equidistant parallel alley in the open-Euclidean VS is represented in the ES by diverging lines that become again parallels after the horizontal distances between its diverging lines are transformed by inverse power exponents of  $1/1.12$  for close to  $1/0.88$  for remote line distances. Similar matters could also hold for open-hyperbolic response spaces as VS, but this would imply that the objective vision space is hyperbolic and not Euclidean as assumed for the ES. Similar matters hold not for the VS as single-elliptic response space, because its parallel alleys correspond in the double-elliptic stimulus space to lines that first would diverge and farther away converge, which might invalidate the arctangent function as response function and the double-elliptic geometry for the visual stimulus space.
- 2) The VS as involution space of the ES preserves the angles between vectors from the space adaptation point in the ES, but its length/depth ratio invariance is violated by their larger perceived than objective ratios, which phenomena are observed in experiments by Foley (1966, 1972) and Wagner (1985). This phenomenon invalidates the hyperbolic VS assumed in Luneburg's theory. However, the phenomenon of larger perceived length than depth of equal objective magnitude is inherent to the open-Euclidean VS as involution of power-raised ES dimensions if the power exponent for length is higher than for depth. For perspective depth perception the situation is different from horizontal length perception, because the distance between the observer and the display of evaluated depth stimuli influences the adaptation level for depth and the more the remote the depth stimuli are. In the horizontal plane at eye level the respective adaptation levels at and an. of length and depth stimuli define power exponents  $\tau_l = 2/a_l$  and  $\tau_d = 2/a_d$  "The horizontal

- diagonal (C,B) with length  $x$  in square (O,C,A,B), where point  $\hat{O}$  is directed toward the observer in the horizontal plane, becomes represented by the response distance  $r_l = 2 \cdot \tanh[\frac{1}{4}\tau_l \{ \ln(x) - a \}]$  in the VS, because its adaptation point is the length midpoint. Depth diagonal (O,A) of equal length  $x$  becomes represented by response distance  $r_d = \tanh[\frac{1}{2}\tau_d \{ \ln(x) - ad \}]$  in the VS, provided that the depth-diagonal length  $x$  has point  $\hat{O}$  as adaptation point, which holds if  $x$  equals the distance between point  $\hat{O}$  and the observer. If  $a_l = ad$  and, thus, if power exponents  $\tau_l = \tau_d$  then  $r_l < r_d$  whereby  $r_l/r_d > 1$ . For example, if  $q = \frac{1}{2}\tau \{ \ln(x) - a \} = \{ \frac{1}{4}, 1/2, 1, 2 \}$  and  $\tau = r$  then we obtain  $r_l/r_d = 2 \cdot \tanh[2q]/\tanh[q] = \{ 1.015, 1.06, 1.21, 1.60 \}$ . However, in experimental studies  $a_l < ad$  because the distances between the observer and point  $\hat{O}$  generally are larger than depth stimuli with basis  $\hat{O}$  in indoor experiments, while average  $I = 2/a_l = 1$  holds for horizontal lengths, whereby then also  $I = \tau_l > \tau_d$  for indoor experiments. Thus, in experiments the ratio  $r_l/r_d$  for length and depth of equal objective magnitude generally becomes more increased than in the hypothetical example of equal adaptation levels  $a_l = ad$ . This also explains why the horizon is perceived as straight, although it is a circular curve part.
- 3) The open-Euclidean VS for the outdoor field of the ES explains why the moon is perceived larger at horizon level than in the sky. Size perception of constant sizes varies with the angle of regard and the spatial direction of the size stimuli (Van de Geer and Zwaan, 1964), which causes the moon illusion (Van de Geer and Zwaan, 1966). Perceived magnitudes of vertical length behave as subjective magnitudes of horizontal lengths, if height stimuli are relatively close to the observer and centrally displayed with midpoints on eye level. This is why the average power exponent of frontal area on indoor displays is about a half, where  $\tau_l = 0.5 = 2/(a_l + a_h)$  with adaptation levels  $a_l$  and  $a_h$  for respectively horizontal length and vertical height imply by  $I = 2/a_l = 1$  that indeed  $a_l = a_h = 2$  and  $I = 2/a_h = 1$ . Indoor experiments indicate that the average power exponent of vertical lengths with their midpoint at eye level is indeed about unity, but for vertical lengths with their base above eye level the power exponent reduces to far below unity. The lower range bound of the power exponents for outdoor heights with high altitude basis becomes  $\tau_h \approx 0.46$  (Baird and Wagner, 1982), which is a much lower range bound than for horizontal outdoor distances with  $I \geq 0.88$  (Teghtsoonian, 1973). Subjective magnitudes of frontal area in the outdoor field depend on the altitude of their length and height. Horizontal lengths at relatively high altitudes generally are lengths at larger distances from the observer than horizontal lengths at eye level, whereby their subjective magnitudes are smaller than same lengths that are close to the observer at eye level, as explained in the first argument above. The adaptation level of heights at some altitude is increased by the influence of the base level altitude, which is similar to depth adaptation levels that are increased by the influence of the distance between the base level of presented depth stimuli and the observer. Thereby, also heights at altitudes have a larger adaptation level than at eye level and thus a smaller power exponent for their subjective magnitudes than heights at eye level. Therefore, areas at eye level are judged larger than at higher altitudes, which explains why the moon is perceived larger at horizon level than in the sky.

- 4) The open-Euclidean VS derives from the hyperbolic tangent projection of the hyperbolic space for comparably weighted and translated sensations of the ES, where the comparable sensation space is invariant under linear transformations of the logarithmically transformed ES. Thus, the involution of the (power-raised) ES to the open-Euclidean VS solves Suppes' (2002) finite and quantifier-independent VS and Helier's (1997, 1998, 2001) search for a VS that is specified by a dimensionally invariant measurement transformation of the ES.
- 5) The apparent context dependence of the VS, discussed by Suppes (2002), is implied by the open-Euclidean geometry for the VS, because the involution of the power-raised ES to the VS is with respect to the space adaptation point, where the dimensional adaptation levels and, thus, their corresponding power exponents also, not only are different, but also may vary depending on the stimulus configuration in the ES and on its distance and altitude with respect to the observer.
- 6) The observer location and the stimulus configuration in the ES determine the dimensional adaptation points for the space perception. However, the open-Euclidean VS in the proximity of the adaptation space point is almost equal to the ES in the proximity of the observer, which explains why motoric behaviour that is based on the VS as open response space still copes very well with ES.

### 7.2.2. The choice axiom, similarity probability and MDS

Individual adaptation levels may be different and then individual response spaces are different. However, task- and/or stimulus-dependent shifts of adaptation levels may occur and then yield also intra-individually different response spaces as task- and/or stimulus-dependent involutions of the stimulus space. In the sequel we discuss how probabilities for 1) confusing stimulus  $i$  with stimulus  $j$  or choosing stimulus  $i$  as belonging to stimulus category  $j$  and 2) choosing stimulus  $i$  and  $j$  as more similar than  $g$  and  $j$  can be consistently analysed by distance transformations of so-called biased choice probabilities, if task- and/or stimulus-dependent shifts of adaptation levels are present. In the next sections it is shown that other than existing biased choice-probability models may apply, if stimulus-dependent adaptation-level shifts are present. In chapter 4 we described response space analyses that are based on the psychophysical response theory and constant individual adaptation levels, where these analyses then also need to be modified if stimulus-dependent adaptation-level shifts are present.

The choice probability that stimulus  $i$  is intenser than stimulus  $j$  or is more preferred than stimulus  $j$  from a set of stimuli with monotone valences is derived by Luce (1959b) from his choice axiom. The axiom implies that the choice probability for stimulus  $i$  from a set of  $n$  stimuli with magnitude scale  $v$  is determined by

$$p_i = v_i / \left[ \sum_{g=1}^{g=n} v_g \right],$$

whereby also  $p_i/p_j = v_i/v_j$ . For  $n=2$  we have the choice probability for  $i$  from pair  $(i,j)$  as

$$p_i(i,j) = v_i / (v_i + v_j) = 1 / [1 + v_j/v_i].$$

Thus the choice probability  $p_i(i,j)$  and ratio  $p_i/p_j$  for  $i$  and  $j$  from a set of  $n$  stimuli is assumed to be independent from other stimuli. This is the so-called property of

irrelevance of other choice alternatives in the choice set, which irrelevance property is implied by the choice axiom. Defining  $v_i = \exp(s_i) = \exp[2(y_i/a - 1)J] = (x_i/b)^\tau$  as subjective stimulus magnitude with power exponent  $\tau = 2/a$  we can rewrite this expression by the logistic discrimination probability function for stimuli  $i$  to be intenser than stimulus  $j$  as function of intensity-comparable sensation differences  $s_i$  with respect to fixed  $s_j$

$$p_{i>j} = \frac{1}{1 + \exp[-(s_i - s_j)]} = \frac{1}{1 + \exp[-(y_i/a - y_j/a)]} = \frac{1}{1 + (x_j/x_i)^\tau}$$

Several probability functions of a random variable define difference probability functions for choice-discrimination probabilities between alternatives, but Yellot (1977) proved that the double exponential probability function is the only probability function that satisfies the choice axiom for its difference probability function of choices between alternatives. A flat (Euclidean or Minkowskian) sensation dimension  $s$  corresponds to a hyperbolic stimulus dimension  $\exp(-s)$  that has double-exponential tenus  $\exp[-\exp(-s)]$  for one of its two rectangular Euclidean co-ordinates, as discussed in section 3.2.1. If co-ordinate  $\exp[-\exp(-s)]$  functions as random variable with a double exponential probability function then the probability difference  $s_i - s_j = 2(y_i - a)/a$  from  $s_i = 0$  is defined by the logistic probability function that corresponds to responses  $r_i$  with  $r_j = 0$ , as defined by

$$p_{i>j} = \frac{1}{1 + \exp(-s_i)} = \frac{1}{1 + (b/x_i)^\tau} = \frac{1 + \tanh(r_i)}{2} = (1 + r_i)/2$$

However, if it is written as

$$p_{i>j} = \frac{1}{1 + \exp[-(s_i - s_j)]} = \frac{1 + \tanh\{1/2(s_i - s_j)\}}{2} = (1 + r_{ij})/2$$

where  $-1 \leq \tanh\{1/2(s_i - s_j)\} = r_{ij} = (r_i - r_j)/(1 - r_i r_j) \leq 1$ , then  $r_{ij}$  is a hyperbolic difference, if sensation difference  $s_i - s_j$  is Euclidean (or Minkowskian). However, as discussed in chapter 4, responses to flat sensation differences  $s_i - s_j$  are not defined by  $\tanh\{1/2(s_i - s_j)\}$ , but defined by open-hyperbolic response space differences  $\pm \cosh[\tanh(1/2 s_i) - \tanh(1/2 s_j)] = \pm \cosh(r_i - r_j)$ . Thus, only if  $r_i = 0$  the last expression for  $p_{i>j}$  holds, whereby its probability conditionally applies to  $y_i - a = 0$  or  $x_i/b = 1$ . This also follows from the fact that the hyperbolic tangent projection of a flat sensation space to an open-hyperbolic response space depends on the projection origin. Only if  $y_i = a$  then  $r_{ij} = r_i$ , whereby  $p_{i>j}$  is the conditional discrimination probability of  $s_i$  with respect to  $s_j = 0$ . Thereby, also the logistic probability function only holds for  $y_i = a$  at  $p_{i>j} = 1/2$ . Therefore, the choice axiom conditionally holds and defines a conditional irrelevance of other alternatives, because choice probability  $p_{i>j}$  is conditional to reference stimulus  $j$  at  $p_{i>j} = 1/2$ , as also follows from the logistic probability function for differences  $s_i - s_j$  with respect to zero difference with  $p_{i>j} = 1/2$ .

Also only for  $r_i = 0$  the hyperbolic distances  $r_{ij} = |(r_i - r_j)/(1 - r_i r_j)|$  reduces to  $r_i$ , whereby  $|r_{ij}| = \tanh[|y_i - y_j|/y_j]$  with  $a = y_j$  also define conditional dissimilarity probabilities

$$p_{i|j} = |r_{ij}| = \tanh(|s_{ij}|) \leq 1$$

for any  $s_i$  with respect to  $s_j = 0$ . We obtain by the probability complement of hyperbolic dissimilarity responses for intensity-comparable sensation distances to  $y_i = a$  the confusion probabilities  $p_{i|j} = 1 - p_{i>j}$  that stimulus  $i$  is confused with stimulus  $j$  (or identified as stimulus  $j$ , or categorised as belonging to category  $j$ ) as defined by

$$p_{ij} = 1 - |r_i| = 1 - \ln \frac{1 + \exp(-2|y_i - y_j|/y_j)}{2} = \frac{1}{2} [1 + \exp(-2|y_i - y_j|/y_j)], \quad |y_j| = a$$

Thus, conditional confusion probabilities equal twice the symmetrically 'folded' discrimination probabilities for  $s_i \geq s_j = 0$ , where it applies to the similarity of any stimulus  $i$  with respect to stimulus adaptation point  $j$  as response space distance to its space origin  $r_i = 0$ . Also only if adaptation level shifts to  $a = y_j$  we can write *similarity probability*  $p_{ij}^1$  by the conditional choice axiom as

$$p_{ij}^1 = \frac{v_{ij}}{\sum_{g=1}^n v_{ig}} \quad |v_{ij}| = 1$$

whereby the probability that stimulus  $i$  is more similar to stimulus  $j$  than stimulus  $g$  becomes by  $d_{ij} = 2|y_i - y_j|/y_j$  written as logistic probability function

$$p_{ij}^1 = \frac{1}{1 + \exp(d_{ij} - d_{ig})}$$

where

$$2p_{ij}^1 - 1 = \tanh\left[\frac{1}{2}(d_{ij} - d_{ig})\right] = \frac{1 - |r_{ij}|}{1 + |r_{ij}|}$$

is the response space difference between dissimilarity responses  $|r_{ij}|$  and  $|r_{ig}|$  with  $L = 0$  as common origin and where dissimilarity response  $|r_{ij}|$  is defined by the involution of dissimilarity measure  $|v_{ij}| = \exp(d_{ij})$  as follows from

$$|v_{ij}| = \frac{1 - |r_{ij}|}{1 + |r_{ij}|} = \tanh\left[-\frac{1}{2} \ln(v_{ij})\right]$$

Here  $v_{ij} = \exp(-d_{ij})$  and  $v_{ig} = \exp(-d_{ig})$  are conditional similarity magnitudes of stimulus  $i$  with respect to stimulus  $j$  in a hyperbolic stimulus space with  $|v_{ij}| = 1$  as unit point. For  $\tau_j = 2/y_j$  we have

$$|v_{ij}| = \exp(-2|y_i - y_j|/y_j) = \exp\{-\tau_j \ln(x_i/x_j)\} = (x_i/b)^{J < 1} \quad |x_j| = b$$

as power-raised stimulus fraction  $x_i/b$ . if  $x_i/b < 1$ , or  $b/x_i$ , if  $x_i/b \geq 1$ , with  $x_i/b = 1$  as stimulus adaptation point.

A flat sensation distance  $|y_i - y_j|$  can also derive from a double-elliptic stimulus space with  $\exp[-1 - \exp(-s)]$  as terms for one of its rectangular Euclidean co-ordinates (see section 3.2.1.), but  $v_i = 1 - \exp(s_i)$  yields by  $1/(1 + v_i/v_j) = 1/(1 - \exp[-(s_i - s_j)]) > 1$  no probability function and thus violates the conditional choice axiom also for  $s_i = 0$ . However, we see that  $\ln(-v_i/v_j)$  relates to the Cauchy distribution function

$$p_{i > j} \approx 1/\{\pi[1 + \{\ln(-v_i/v_j)/a\}^2]\}$$

By  $v_i = 1 - \exp(s_i)$  and  $v_j = 1 - \exp(s_j) = 1 - \sqrt{-1}$  for  $s_i = 0$  we have  $v_i/v_j = -1/v_j = \exp(-s_j)$  that satisfies the conditional irrelevance of other alternatives, because differences of  $s_i$  to  $s_j = 0$  in a flat sensation space depend not on other space points. while

$$\tan(L_{ij}) = \tan[\arctan\{2(y_i - y_j)/y_j\}] \approx 2(y_i - y_j)/y_j$$

defines

$$p_{i > j} = 1/\{\pi[1 + \{\ln(-1/v_j)\}^2]\} = 1/\{\pi[1 + \tan^2(r_{ij}^1)]\} \quad |a = y_j$$

Here the Cauchy *distribution* function for differences from  $y_j = a$  as median centre of its symmetric distribution has the cumulative probabilities  $p_{i > j} = 1/4$  and  $p_{i > j} = 3/4$  at levels  $y_i = \pm 1/2 a$ , because its mean and standard deviation exist not (all moments of its



distribution are zero, see Wilks, 1962, p. 256). Its integration (Courant, 1960, p. 150) yields  $r_{ij}/\pi = \arctan(s_{ij})/x$ , whereby  $r_{ij}/\pi = 2p_{ij} - I$  defines the Cauchy discrimination probability function

$$p_{ij} = [I + \arctan(s_{ij})/\pi]/2 = [I + L_{ij}]/2 \quad |y_j = a$$

for single-elliptic response spaces with unit radius (see section 4.2.1.) and  $L_{ij} = 0$  as origin. The Cauchy distribution function  $p_{ij}$  for sensation differences to  $y_j$  has its maximum probability  $1/\pi$  at  $y_j$  as median. Thereby, the symmetrically 'folded' Cauchy distribution function for flat sensation space distances  $d_{ij} = 2|y_i - y_j|/y_j$  defines after multiplication by  $\pi$  the confusion probability

$$p_{ij} = 1/[1 + 1/v_{ij}] = 1/[1 + d_{ij}^2] = 1/[1 + \tan^2(L_{ij})] = \cos^2(L_{ij})$$

for similarity magnitude  $v_{ij} = 1/d_{ij}$  where  $d_{ij} = 0$  yields self-similarity probability  $P_{ij} = 1$ . By its squared cosine transformation of single-elliptic response distances it directly relates to the complement of twice the symmetrically 'folded' Cauchy probability function for discrimination of sensation differences, because the actually observable confusion probability is defined by

$$p_{ij} = 1 - |r_{ij}|/(\pi/2) = 1 - \arctan(s_{ij})/(\pi/2)$$

If the adaptation level shifts to  $y_j$  for sensation distances  $d_{ij} = 2|y_i - y_j|/y_j$ , then we also define by analogy to  $r_{ij} = \tanh[-\sqrt{2}(d_{ij} - I)]$  the arctangent-based dissimilarity response

$$r_{ij} = \arctan(d_{ij} - I) = \arctan[|y_i - y_j|/y_j]$$

The dissimilarity response  $r_{ij}$  defines the conditional similarity probability that stimulus  $i$  is more similar to stimulus  $j$  than stimulus  $g$  by

$$p_{ij|gj} = [I + r_{ij}]/2 = [I + \arctan(d_{ij} - d_{ig})]/2$$

Its differentiation and scaling yields

$$p_{ij|gj} = \cos^2(1 - p_{ij|gj}) = 1/[1 + (d_{ij} - d_{ig})^2]$$

but defines no proper expression for probability that stimulus  $i$  is more similar to stimulus  $j$  than stimulus  $g$ , because  $p_{ij|gj} = I$  for  $d_{ij} = d_{ig}$  and  $p_{ij|gj} = 0$  for  $d_{ij} = \infty$  and  $d_{ig} = 0$  or for  $d_{ij} = 0$  and  $d_{ig} = \infty$ . If  $v_{ij} = 1/d_{ij}$  would define a similarity magnitude and the conditional choice axiom would apply then it would define

$$P_{ij|gj} = 1/[1 + (d_{ij}/d_{ig})^2]$$

but this expression derives not from differentiation of  $p_{ij|gj}$ . Since the Cauchy probability function satisfies the conditional irrelevance of other alternatives, we see that the conditional choice axiom implies the conditional irrelevance of other alternatives, but the property of conditional irrelevance of other choice alternatives not the conditional choice axiom. The property of conditional irrelevance of other alternatives for choice probabilities should also be evident from the result that the stimulus, sensation and response spaces are perspective-dependent projection

transformations of each other space with a zero or constant curvature. Choice probability functions for pair comparison choices not only can be the logistic and Cauchy probability functions, but also the Gaussian probability function of Thurstone's (1927a) theory of comparative judgment (with identical normal distributions for  $s_i$  and  $s_j$  as case V) or several other probability distribution functions of differences (with mean or median  $s_i - s_j = 0$  (Yellott, 1977)). However, only the logistic and Cauchy probability functions transform dimensional differences or distances in a zero curvature space to probability spaces with a constant space curvature (hyperbolic for the logistic function and elliptic for the Cauchy function), whereby only the logistic and Cauchy probability functions satisfy the property of irrelevance of other alternatives. For conditional distances in single-elliptic response spaces the 'scaled' and 'folded' Cauchy probability function at  $p = 1/2$  defines the observed confusion or similarity probability of double-elliptic stimuli, but the 'scaled' and 'folded' Cauchy distribution function at  $p = 1/\pi$  defines derived confusion probabilities that conveniently relate to conditional Euclidean sensation distance by

$$\text{while } d_{ij} = [(1 - p_{ij})/p_{ij}],$$

$$d_{ij} - d_{ig} = \tan[(2 \cdot p_{ij} \cdot |g_j - 1|) \cdot (1/\pi)]$$

derives from the conditional similarity probability.

Response transformations of comparable, hyperbolic sensations  $s_i = 2(y_i/a - 1)$  concern a transformation of weighted and translated, hyperbolic sensation spaces to open-Euclidean response spaces by  $\tanh(1/2 s_i) = r_i$ , whereby it holds that

$$(1 + r_i)/2 = [1 + \tanh(1/2 s_i)]/2 = 1/[1 + \exp(-2(y_i/a - 1))].$$

The open-Euclidean response space defines response distances  $r_i$  to  $r_j = 0$ , whereby confusion probabilities of  $s_i$  with  $s_j = 0$  for  $y_j = a$  are also expressed by

$$P_{ij} = 1 - |r_{ij}| = 1 - \tanh(|y_i - y_j|/y_j) = 2/[1 + \exp(-2|y_i - a|)] \quad |y_j = a$$

where  $\exp(-2|y_i - a|/a) = \exp(-|s_i|)$  is a Euclidean co-ordinate of the hyperbolic sensation space distance of  $s_i$  to  $s_i = 0$ . Since co-ordinate  $\exp(-s_i)$  specifies no double exponential function for  $s_i$ , it satisfies not the conditional choice axiom. But random differences  $s_i$  to  $s_j = 0$  still have a logistic probability function, because  $s_j(s_i + s_j)$  has for  $s_j = 0$  by definition a uniform distribution, whereby the logistic probability function for differences  $s_i - s_j$  holds (Laha, 1964), although the random variable  $s_i$  is not double exponential. Since the logistic probability applies also

$$p_{ij} | g_j = 1/[1 + \exp\{-2(|y_i - y_j| - |y_i - Y_j|/y_j)\}] = 1/[1 + \exp(d_{ij} - d_{g_j})],$$

may apply as conditional similarity probability that Euclidean stimulus  $i$  is more similar to Euclidean stimulus  $j$  than Euclidean stimulus  $g$ . By its conditional probability with respect to  $y_j$  as common reference point, it only requires the irrelevance of a second alternative and not the irrelevance for a third one, which is the condition for its validity (Yellott, 1977), if the choice axiom fails to apply. Nonetheless, their hyperbolic sensation distances of  $s_i$  to  $s_j = 0$  are not expressed by  $|s_{ij}| = 2|y_i - y_j|/y_j$ , but by  $\text{COSH}(s_{ij})$ . If we rotate co-ordinates  $\exp[2(y_i - a)/a]$  and  $\exp[-2(y_i - a)/a]$  of hyperbolic

sensations by 45° and multiply the rotated co-ordinates by  $1/\sqrt{2}$  (see section 3.2.2.) then we obtain the central Euclidean co-ordinate of that hyperbolic dimension as

$$\cosh[2(y_i - a)/a] = [(x_i/b)^\tau + (b/x_i)^\tau] / 2 \quad \tau = 2/a = 2/(\ln(b/u))$$

whereby

$$|r_{ij}| = \text{taoh}[Y2 \ln(\cosh[2(y_i - y_j)/y_j])] \quad y_j = a$$

It defines an alternative dissimilarity response  $|r_{ij}|$  for comparable, hyperbolic sensation distance  $\cosh[(y_i - y_j)/y_j]$  for shifted adaptation level  $a = y_j$ . Thereby,

$$P_{ij}'' = 1 - |r_{ij}| = 2/[1 + \cosh\{2(y_i - y_j)/y_j\}] \quad y_j = a$$

or

$$P_{ij}'' = 2/[1 + \cosh\{2(y_i - y_j)/y_j\}] \quad v_{ij} = \text{leash}(s_{ij})$$

define confusion probabilities that satisfy the conditional choice axiom, because  $\exp(-1/v_{ij}) = \exp[-(\cosh\{2(y_i - y_j)/y_j\})]$  is a double-exponential probability function that is truncated at its inflexion point  $\exp(-1) = \exp\{-\cosh(0)\} = \exp(-1/v_{ij})$ . Notice that the truncation point of the double exponential function corresponds to inflexion point  $p = 1/2$  of the logistic probability function for corresponding differences of distances  $\cosh[2(y_i - y_j)/y_j]$  which by its folding at  $p_{ij} = 1/2$  defines the factor 2 in the logistic confusion probability function of  $s_{ij}$  with  $s_{ij} = 0$  as  $P_{ij}'' = 2/(1 + 1/v_{ij})$  where similarity magnitude  $v_{ij} = 1/\cosh[2(y_i - y_j)/y_j]$  and  $|r_{ij}| = 1$ . Thus for hyperbolic sensation spaces we have  $\cosh[2(y_i - y_j)/y_j]$  as comparable sensation distances to  $y_j = a$  as reference sensation level,  $|r_{ij}| = \cosh[2(y_i - y_j)/y_j]$  is a stimulus-like dissimilarity magnitude of Euclidean stimuli with  $v_{ij} = 1$  because for  $y_j = a$ , thus for  $x_i = b$  and power exponent  $\tau_j = 2/\ln(x_i/u)$  we see that  $s_{ij} = \cosh\{2(y_i - y_j)/y_j\} = [(x_i/x_j)^\tau + (x_j/x_i)^\tau] / 2$   $x_j = b$   $x_i = I$

corresponds to a power-raised conjugate stimulus fraction midpoint of Euclidean stimuli  $x_i$  with respect to  $x_j$ . Thus, dissimilarity response distance  $|r_{ij}|$  is also defined by the involution of similitude magnitude  $v_{ij} = 1/\cosh[2(y_i - y_j)/y_j]$  as follows from

$$|r_{ij}| = \tanh[-1/2 \ln(v_{ij})] = [1 - v_{ij}]/[1 + v_{ij}]$$

This dissimilarity defines confusion probability  $p_{ij} = 1 - |r_{ij}| = 2/(1 + 1/v_{ij})$  to satisfy the conditional choice axiom for  $1/v_{ij} = \cosh[2(y_i - y_j)/y_j]$  as weighted, hyperbolic distances between  $y_i$  and  $y_j = a$ , because  $\exp(-1/v_{ij})$  is a double exponential probability function of dimension  $y_j - 1$  with  $y_j = a$ . Notice also that the response  $|r_{ij}| = \tanh[\ln\{\cosh[2(y_i - y_j)/y_j]\}]$  is open-hyperbolic and differs from the open-Euclidean response that is specified by  $|r_{ij}| = \tanh[|y_i - y_j|/Y_j]$  for hyperbolic sensation distance between  $y_i$  and  $y_j = a$ . However, for hyperbolic sensation spaces the similarity probability  $p_{ij}$  satisfies the conditional choice axiom if the similarity magnitudes are defined by  $v_{ij} = 1/\cosh(d_{ij})$  for  $d_{ij} = 2|y_i - Y_j|/y_j$ . Thereby, we also obtain

$$p_{ij} = v_{ij} / \sum_{g=1}^n v_{ij} \quad |v_{ij}| = 1/\cosh[2(y_i - y_j)/y_j]$$

and also

$$p_{ij} = 1/[1 + v_{ij}] \quad |v_{ij}| = 1/[1 + \cosh(d_{ij})/\cosh(d_{ij})]$$

as alternative for the conditional similarity probability that stimulus  $i$  more similar to stimulus  $j$  than stimulus  $g$  for hyperbolic sensation spaces. Notice that the corresponding response expression

$$r_{ij} = \frac{1}{a} \exp\{-\sqrt{2} \ln[\cosh(d_{ij}^i) \cosh(d_{ij}^g)]\} \quad |y_j = a$$

not only resembles the single-peaked valence expression

$$v_i = \tanh[-\sqrt{2} \ln\{\cosh(d_{ij}) \cosh(d_j)\}]$$

for weighted hyperbolic sensations distances  $d_{ij}^i = |y_i - g|$  and  $d_{ij}^g = |a_j - g|$  to ideal point  $g$ , but since the dimensional tensors  $\cosh(d_{ijk})$  for hyperbolic spaces multiply to  $\cosh(d_{ij})$  it also specifies an open-hyperbolic space of dissimilarity responses  $r_{ij}$  with curvature  $\zeta = -1/2$  for sensation space distances  $d_{ij} = \ln\{\cosh[2(y_i - y_j)/a]\}$  with a city-block metric of additive dimensional distances  $d_{ijk} = \ln\{\cosh[2(y_i - y_j)/a]\}$  to its zero space origin for  $y_i - a = 0$ . This means that the distance metric of open-hyperbolic (dis)similarity response spaces is conformal with the distance metric of hyperbolic sensation spaces, which might theoretically be required by psychological consistency between similarity responses and cognitive sensations, while psychological consistency between magnitude response and stimulus spaces requires a conformal distance between open-Euclidean response spaces and Euclidean stimulus spaces with hyperbolic sensation spaces. It may imply that our analysis method of dissimilarities between Euclidean stimuli, described in chapter 4, has to be modified by replacing open-Euclidean response distances  $|r_{ij} - r_{jk}| = |\tanh(y_i/a) - \tanh(y_j/a)|$  by open-hyperbolic response distances  $\cosh[r_{ij} - r_{jk}]$  for  $r_{ij} = \pm \tanh[\frac{1}{2} \ln\{\cosh(2y_i/a) - 2\}]$ . The Euclidean co-ordinates of open-hyperbolic response spaces would then become solved by principal component analyses of individual matrices with elements  $\cosh[r_{ij} - r_{jk}]$  as initially scaled values of individual dissimilarity rank orders. The Euclidean co-ordinates of the common hyperbolic sensation space would then iteratively be solved by Procrustes matching under rotations, weighing and weight-dependent translations of comparable sensation dimensions of individually solved, hyperbolic sensation spaces that derive by elements  $\cosh[2(y_i - a)/a] = \exp\{2[\arctanh(\frac{1}{2} \ln\{\cosh(2y_i/a) - 2\})]\}$  for optimally scaled values of  $r_{ij}$  from the solved, open-hyperbolic response spaces.

Conditional confusion or similarity probabilities yield metric information, where rank orders of similarity responses only yield ordinal information. Therefore, multidimensional analyses of conditional similarity probabilities could provide more decisive evidence for the actual geometry of the response space (and thus also of the sensation and stimulus spaces) than our semi-metric multidimensional analyses of dissimilarity rank orders. Confusion probabilities are obtained in research on confusion, identification, or categorisation of stimuli with respect to target stimuli or categories. If the choice axiom applies to  $v_{ij}$  conditional to  $v_{ij}^I = I$  then confusion probability

$$P_{ij}^I = 2v_{ij}^I / (v_{ij}^I + v_{ij}^I) = 2 / (1 + 1/v_{ij}^I)$$

with self-similarity probability  $p_{ij}^I = 2v_{ij}^I / (v_{ij}^I + v_{ij}^I) = 1$  holds, where conditional sensation distance  $d_{ij}^I = (2|y_i - y_j|/a)$  to  $y_i = a$  has stimulus-like value  $v_{ij}^I = \exp(-d_{ij}^I)$  as similarity magnitude and  $1/v_{ij}^I = \exp(d_{ij}^I)$  as stimulus-like dissimilarity magnitude. However, the conditional nature of the choice axiom with respect to  $v_{ij}^I = I$  or  $v_{ij}^I = 1$

for  $y_i = a$  generally is not acknowledged, whereby it would follow from  $v_{ij} = \exp(-d_{ij})$  for flat, unconditional sensation space distances  $d_{ij}$  that

$$d_{ij} = 2 \cdot y_i \cdot y_j / a = -\ln(v_{ij}) = \ln(v_i/v_j) = \ln(v_i/v_j) = \tau |\ln(x_i/x_j)|.$$

Choice-theoretical similarity probability  $p_{ij} = 2v_{ij}/(v_{ij} + v_{ji})$  only can be consistent with our psychophysical response theory if the dissimilarity response function is the hyperbolic tangent function of the intensity-comparable, Euclidean sensation distances  $d_{ij} = 2|y_i - y_j|/a$  with respect to adaptation level  $a = y_i$  or  $a = y_j$  as origin of the comparable sensation space. However, writing  $p_{ij}(y_i = a)$  or  $p_{ji}(y_j = a)$  as  $p_{ij}$  and inappropriately unconditional similarity probability we have

$$p_{ij} = 1 - \tanh(1/2 d_{ij}) = [1 - \exp(-d_{ij})] / [1 + \exp(-d_{ij})],$$

$$p_{ij} = 2 \exp(-d_{ij}) / [1 + \exp(-d_{ij})] = 2 / [1 + \exp(d_{ij})],$$

whereby

$$p_{ij} = 2 / (1 + \exp(d_{ij})) = 2 / [1 + \exp\{\ln(v_i/v_j)\}]$$

Due to the folding of differences  $\ln(v_i/v_j)$  to distances  $d_{ij} = \ln(v_i/v_j) = -\ln(v_{ij}) \geq 0$ , the confusion probability function  $p_{ij}$  equals twice the symmetrically 'folded' logistic discrimination probability function  $p_{ij}^{>}$  for  $2(y_i/a - 1) < 0$  that is folded at  $p = 1/2$  for  $y_i = a$ . By the correspondence between logistic probability and hyperbolic tangent functions the above derived similarity probability function may hold for Euclidean and hyperbolic sensation spaces with  $y_i = a$  or  $y_j = a$  as origin. Alternatively we would also have  $p_{ij} = 2 / [1 + \cosh(d_{ij})]$  for hyperbolic sensation distances  $d_{ij}$  to  $y_i = a$  or  $y_j = a$ , while if the Cauchy probability function applies we would have  $p_{ij} = 1 / [1 + d_{ij}^2]$  for Euclidean sensation spaces. However, if the conditional nature with respect to  $a = y_i$  or  $a = y_j$  is not acknowledged then it seemingly yields symmetric confusion and similarity probabilities that for hyperbolic tangent-based responses would write as

$$p_{ij} = 2 / (1 + \exp(d_{ij})) = 2 / [1 + \exp(2|y_i - y_j|/a)] = p_{ji},$$

where actually for  $a = y_j$  we have confusion probabilities

and if  $a = y_i$

$$p_{ij} = 2 / [1 + \exp(2|y_i - y_j|/a)]$$

$$p_{ji} = 2 / [1 + \exp(2|y_i - y_j|/a)]$$

where  $p_{ij} \neq p_{ji}$ . For similarity probabilities the choice axiom also conditionally holds as

$$p_{ij} \cdot v_{ij} = v_i / \sum_{g=1}^n v_{ig} \quad \text{with } v_{ij} = \exp(-2|y_i - y_j|/a) \text{ for } y_i = a$$

which defines for similarity magnitude  $v_{ij}$  with  $a = y_j$  conditional similarity probability

and if  $a = y_i$

$$p_{ij} \cdot |g_j| = 1 / [1 + \exp(2(|y_i - y_j|/a - |y_i - y_g|/a))]$$

$$p_{ji} \cdot |g_i| = 1 / [1 + \exp(2(|y_i - y_j|/a - |y_i - y_g|/a))]$$

where also  $p_{ij} \cdot |g_j| \neq p_{ji} \cdot |g_i|$ .

Luce (1961) has also derived by his choice-theoretical analysis of similarities  $-ln(v_{ij}) \dots d_{ij}$ , but for Fechnerian sensation distance  $d_{ij} \dots |y_i - y_j|$  with an undetermined scale unit. Luce distinguishes not between confusion and similarity probabilities and writes both expressions, rewritten in our notation by  $v_{ij}$  for Luce's  $v(a,b)$ , as

$$p_{ij} = v_{ij} / (\sum_{g=1}^{g=n} v_{ij}) \quad \text{and} \quad p_{ij} \dots 1 / (1 + \Pi v_{ij})$$

far  $p_{ij}$  as "symmetrically truncated ogive with horizontal tails". Luce remarks that the scale  $v_{ij}$  in the similarity probability function also depends upon  $j$  and on the truncation of the logistic probability function. That this dependence implies a symmetric folding of the logistic probability function is also implicitly mentioned by Luce (1961, p.159), where he defined for indices  $a \dots i$  and  $b \dots j$ :

$$v(a,b) \dots v(a)/v(b) \quad \text{if} \quad v(a) \leq v(b) \quad \text{or} \quad v(a,b) \dots v(b)/v(a) \quad \text{if} \quad v(a) \geq v(b),$$

as above implied by our definition  $d_{ij} \dots -ln(v_{ij}) \dots \Pi ln(v_i/v_j)$  and formulated that this "establishes a basic connection between the discrimination and similarity data, if the present theory is correct. Indeed, similarity distance,  $-log v(a,b)$ , is simply the absolute value of the difference of the logarithms of the discriminative scale values - what have been called Fechner scale values. Thus, the model is substantially like Coombs' unfolding technique, where  $-log v(a,b)$  is the folded scale and  $log v(a)$  the unfolded one."

However, Luce concluded not that stimulus  $b \dots j$  determines the folding point, nor that the confusion probability for sensation distances should be twice the symmetrically folded, logistic probability function for its sensation differences, instead of two symmetrically truncated ones - one for  $v_i < v_j$  and one for  $v_i > v_j$ . If folded at symmetry point  $p_{ij} \dots 1/2$  then it is half the logistic probability function (see figure 10 in section 2.1.3.), whereby multiplication by 2 is needed in order to become a confusion probability function with a self-similarity probability of unity. However, the confusion probability is then also conditional to  $v_{ij} \approx 1$  with self-similarity probability  $p_{ij} = 1$ . Writing probabilities  $P_{ij} \dots 2 / (1 + exp(d_{ij}))$  with  $P_{ij} \dots 1$  and  $p_{ij} \dots 2 / (1 + exp(d_{ij}))$  with  $P_{ij} \dots 1$ , we have asymmetric confusion probabilities from differently weighted distances

$$\text{and} \quad d_{ij} = ln[(2 \cdot P_{ij}) / (1 - P_{ij})] = 2|y_i - y_j| \quad \text{if} \quad y_i \geq y_j$$

$$d_{ij} = ln[(2 \cdot P_{ij}) / (1 - P_{ij})] = 2|y_i - y_j| \quad \text{if} \quad y_i \leq y_j$$

while Luce's expression  $p_{ij} = 1 / (1 + exp(d_{ij})) \leq p_{ij} = 1/2$  and  $p_{ij} \dots p_i / p_j \leq 1$  assumes symmetric distances  $d_{ij} = |y_i - y_j|$  with an undetermined scale factor and

$$\text{or} \quad d_{ij} = ln[(1 - p_{ij}) / p_{ij}] = |y_i - y_j| \quad \text{if} \quad v_i \leq v_j$$

$$d_{ij} = ln[p_{ij} / (1 - p_{ij})] = |y_i - y_j| \quad \text{if} \quad v_i \geq v_j$$

For symmetric distances  $d_{ij}$  we would have  $2p_{ij} = 1 / (1 + exp(d_{ij}))$ , whereby Luce's truncated choice probabilities define twice the symmetrically folded logistic probability function as the confusion probability function for a Euclidean sensation distance. It would incorrectly yield symmetric confusion and similarity probabilities  $p_{ij} = p_{ji}$ , due to the not-recognised condition for the adaptation level as reference sensation with probability  $p_{i-1} = 1/2$  that specifies either  $a = y_i$  or  $a \dots y_i$ .

In the sequel we compare our psychophysical response theory for (dis)similarities with results from multidimensional analyses of stimulus confusion, identification, or categorisation and similarity data in perception and cognition research and the related models for asymmetric similarity. We reference overview studies of authors that have analysed many data sets of confusion, identification or categorisation probabilities by MDS- or stochastic MDS-analyses of distances that are derived from similarity probability models. Relevant studies of other authors are not referenced unless they contributed to new insights. Studies on confusion, or identification, or categorisation of stimuli generally concern similarity probability expressions  $p_{ij} = n_{ij}/n$  for  $n_{ij}$  as the frequency of confusing stimuli  $i$  with  $j$  or categorising  $i$  as belonging to category  $j$  and  $n$  as the frequency of presenting stimulus  $i$  from the stimulus set, while in connectionistic learning theory  $n_{ij}$  is the frequency of generated output  $j$  to input  $i$  in  $n$  learning runs for input  $i$ . Some studies assume symmetric similarity probabilities  $p_{ij} = p_{ji}$  and self-similarity probability  $p_{ii} = 1$ , where  $p_{ij} = (n_{ij}/n_{i.} + n_{.j}/n_{.j})/2 < 1$  is used as error-adjustments for symmetric similarity probabilities. Also  $v_{ij}$  as function of  $d_{ij}$  is often more flexible defined in MDS-based similarity models by relating the similarity magnitude scale  $v_{ij}$  in a monotonic way to distances  $d_{ij}$ . Ashby (1992a) and Nosofsky (1992b) takes

$$v_{ij} = \exp(-d_{ij}^c) = \exp\left[-\sum_{k=1}^{k=m} w_k |Y_{ik} - Y_{jk}|^r\right]^{c/r}$$

It implies a flat space for distance  $d_{ij}$  and for  $c = 1$  one also assumes the so-called exponential decay function for similarity or generalisation (Shepard, 1957, 1958, 1987; Nosofsky, 1986, 1992b; Ashby, 1992b). If  $c = r = 2$  then  $d_{ij}^2$  is a squared Euclidean sensation distance and implies a so-called Gaussian decay function for similarity generalisation (Nosofsky, 1986, 1992b; Shepard, 1987; Eonis, 1988; Ashby, 1992b). Some studies take similarity scale  $v_{ij}$  as

$$v_{ij} = 1/d_{ij}^c$$

The first alternative rewrites by dimensional term  $v_{ijk}^c = \exp(-d_{ijk}^c)$  for any positive value of  $c$  as

$$v_{ij} = \left[\prod_{k=1}^{k=m} v_{ijk}^r\right]^{c/r} = \exp(-d_{ij}^c)$$

whereby the confusion probability would become written as

$$p_{ij} = 2/[1 + 1/v_{ij}] = 2/[1 + \exp(d_{ij}^c)],$$

or

$$p_{ij} = 2[1 + 1/v_{ij}]^{-1} = 2[1 + \left\{\prod_{k=1}^{k=m} \exp(d_{ijk}^r)\right\}^{c/r}]^{-1} = 2[1 + \exp\{\sum_{k=1}^{k=m} d_{ijk}^r\}^{c/r}]^{-1}$$

In this expression for symmetric similarity magnitude  $v_{ij}$  we have multiplicativity of dimensional terms  $v_{ijk}$ . Therefore, Nosofsky (1992a) called it the *multiplicative similarity model*. Since the multiplication of  $v_{ijk}$  concerns the multiplication of exponential terms of (power-raised) dimensional distances  $d_{ijk}^r$  in flat sensation spaces, we rather call it the *exponentially multiplicative similarity model*. The exponentially multiplicative similarity model is originally proposed by Medin and Schaffer (1978) for connectionistic learning and is empirically tested by Gluck and Bower (1988) in categorisation learning. The model is also implicitly used in several connectionist

learning models (Estes et al., 1989) and explicitly in the so-called general context model of Nosofsky (1992a). MDS-based analyses of exponentially multiplicative similarity models are then based on metric MDS analyses of individual distances

$$d_{ij} = \{\ln[(2 - p_{ij})/p_{ij}]\} \quad \text{ie} \quad = \left\{ \sum_{k=1}^{k=m} |y_{ik} - Y_{jk}| \right\} / r$$

where similarities are symmetric and transitive. However, as discussed above, a confusion or similarity probability model only may hold if individual adaptation levels are shifted to  $y_.$ , where  $\tanh(\sqrt{2}d_{..}) = \tanh(|y_i - y_j|/y_.) = |r_{ij}|$  and  $r_{ii} = 0$ , or are shifted to  $Y'$  where  $\tanh(\sqrt{2}d_{..}) = \tanh(|y_i - y_j|/Y') = |r_{ij}|$  and  $r_{ii} = 0$ . Thereby, their confusion probabilities are asymmetric and intransitive, but if shifted to  $a_{..} = (y_i + y_j)/2$  then  $s_{..} = -s_0$  and  $\tanh(\sqrt{2}d_{..}) = \tanh(|y_i - Y_j|/a_{..}) = 2|r_{ij}| = 2|r_{..}| = |r_{ij}|$  for  $|r_{ij}|$  as response space distance between  $r_i$  and  $r_j$ , whereby their confusion or similarity probabilities are symmetric, but may be intransitive. For open-hyperbolic response spaces the exponentially multiplicative similarity model would imply that sensation distances  $d_{..} = \ln[(2 - p_{..})/p_{..}] = |y_i - Y_j|/a$  define distances in a common Euclidean sensation space. If symmetric similarity probabilities  $p_{..} = 1 - 1/2|r_{..}|$  for  $|r_{..}|$  as response space distances would define Euclidean distances  $d_{..} = \ln[(2 - p_{..})/p_{..}] = |y_i - Y_j|/a$  then the MDS-analyses would be the metric Euclidean MDS-analysis of distances (Torgerson, 1958). However, symmetric distances  $d_{..} = \ln[(2 - p_{..})/p_{..}]$  only hold for confusion probabilities with shifted adaptation levels to sensation midpoints  $a_{..}$ . For conditional similarities we can't derive similarity probabilities for symmetric distances, because if adaptation levels are shifted to sensation midpoints then distances have no common adaptation level. Therefore, a metric Euclidean MDS-representation of transformed confusion (or identification, or categorisation) and similarity probabilities as distances in a common Euclidean sensation space only may approximately hold if the response space is open-hyperbolic and the response distances are not remotely located from their space origin, because then differences between response distances in response spaces with shifted and not-shifted adaptation levels are relatively small.

For hyperbolic sensation spaces we also could apply  $v_{..} = \exp(-d_{..})$ , if  $\exp(-d_{..})$  would represent a Euclidean co-ordinate distance of a hyperbolic sensation space distance  $d_{..}$ , that correspond to an open-Euclidean response space distance, which only holds again if either  $y_.$ , or  $Y_j$ , or  $(y_i + y_j)/2$  equals the adaptation level, because then the symmetrically folded logistic function may apply to confusion probabilities for subsets of  $n=2$ . However, we have to realise that  $v_{..} = \exp(-d_{..})$  are Euclidean co-ordinate terms of hyperbolic sensation-space distances, whereby similarity magnitudes

$$v_{ij} = \exp(-d_{ij}) = \sqrt{\sum_{k=1}^{k=m} \exp(-2d_{ijk})} = \sqrt{\sum_{k=1}^{k=m} \frac{2}{ijk}}$$

define conditional to  $a=y_.$ , or  $a=Y_j$ , or  $a=(y_i + y_j)/2$  a valid confusion probability model by

$$p_{ij} = 2/[1 + 1/v_{..}] = 2/[1 + \exp(d_{..})] = 2/[1 + \sqrt{\sum_{k=1}^{k=m} \exp(2d_{ijk})}]$$

This new similarity model is defined by addition, instead of multiplication, of exponential co-ordinates terms for dimensional distances in hyperbolic sensation spaces and, therefore, we call it an *exponential additive similarity model*. If the sensation



space is hyperbolic then only similarity magnitudes  $v_{ij} = 1/\cosh(d_{ij})$  could also satisfy the choice axiom, where then independent hyperbolic dimension distances combine to hyperbolic space distances by

$$\cosh(d_{ij}) = \prod_{k=1}^{k=m} \cosh(d_{ij}^k)$$

Again only if  $a = y_1$ , or  $a = y_2$ , or  $a = (y_1 + y_2)/2$  we have a valid confusion probability model

$$p_{ij} = 2/[1 + \Pi v_{ij}] = 2/[1 + \cosh(d_{ij})] = 2/[1 + \prod_{k=1}^{k=m} \cosh(d_{ij}^k)],$$

but, as discussed earlier, it then only holds for  $p_{ij} = P_{ij}$  or  $p_{ij} = p_{ij}$  by satisfying the conditional choice axiom. We call this new similarity probability model for hyperbolic sensation spaces a *hyperbolically multiplicative similarity model*. Since in the hyperbolically multiplicative model the distances are defined by  $\cosh(d_{ij}) = (2 - p_{ij})/p_{ij}$  or in the exponentially additive model by  $\cosh(d_{ij}) = \cosh[\ln\{(2 - p_{ij})/p_{ij}\}]$ , the principal component analyses of matrices with elements  $\cosh(d_{ij})$  as defined for each model then could solve the  $(m+1)$  Eudidean co-ordinates of the hyperbolic sensation space for both models.

The last, earlier mentioned alternative for

$$v_{ij} = 1/d_{ij}^c \quad \text{and} \quad p_{ij} = 1/[1 + d_{ij}^c]$$

with  $d_{ij}$  as distance in a flat sensation space specifies that

$$1/v_{ij} = \left[ \sum_{k=1}^{k=m} d_{ijk}^r \right]^{c/r} = d_{ij}^c$$

and

$$p_{ij} = 1/[1 + d_{ij}^c] = 1/[1 + \left( \sum_{k=1}^{k=m} d_{ijk}^r \right)^{c/r}]$$

with self-similarity probability  $p_{ij} = 1$  for  $d_{ij}^c = 0$ . However, the similarity magnitude  $v_{ij} = 1/d_{ij}^c$  with  $v_{ij} = 1/0 = \infty$  violates the choice axiom, because the similarity probability would be  $p_{ij} = 1/[1 + v_{ij}/v_{ij}] = 1/[1 + \infty/d_{ij}] = 0$  independently of the similarity between  $i$  and  $j$ , as also Coombs suggested to Luce (1961, p.155) as proof for incompatibility of  $v_{ij} = 1/d_{ij}^c$  with the choice axiom. However, if  $d_{ij}$  is a distance in a flat sensation space that corresponds to a double-elliptic stimulus space, then the choice axiom applies not to the imaginary values  $v_{ij} = 1 - \exp(-d_{ij})$  as similarity magnitude for distance  $d_{ij}$ , as discussed earlier. The response space is then single-elliptic and derives from the Cauchy probability function for flat sensation differences with respect to the adaptation point (see section 4.2.1.). For  $c = 2$  and  $a = y_1$ ,  $a = y_2$ , or  $a = (y_1 + y_2)/2$  the single-elliptic response space distances are only then defined by  $\arctan(d_{ij}) = |r_{ij}|$  as distances to their space origin or as distances with their space origin as midpoint, as discussed earlier, whereby

$$p_{ij} = \cos^2(r_{ij}) = 1/[1 + \tan^2(r_{ij})] = 1/[1 + d_{ij}^2] = 1/[1 + \sum_{k=1}^{k=m} d_{ijk}^2]$$

defines a seemingly legitimate similarity probability function for  $\Pi v_{ij} = d_{ij} = \tan^2(r_{ij})$ . Due to the Euclidean addition of the squared dimensional sensation distances  $d_{ijk}$  to squared sensation space distance  $d_{ij}$ , this model is an *additive similarity model* for

confusion, identification, or categorisation probabilities  $p_{ij}$ , as it also is called by Nosofsky (1992a). According to our psychophysical response theory, the additive similarity model implies individually different, single-elliptic similarity response space distances  $\tan(r_{ij}) = s_{ij}$  and the sensation space as common Euclidean object space. We discussed earlier the Cauchy distribution function  $p_{ij} = 1/\{\pi[1 + (s_{ij} - s_i)^2]\}$  for sensation differences to  $s_i$  that has its maximum probability  $1/\pi$  at  $s_i$  as median, whereby the by  $\pi$  multiplied and symmetrically folded Cauchy distribution function for flat sensation distances defines here confusion probabilities  $p_{ij} = 1/[1 + d_{ij}^2]$  that for  $d_{ij} = 0$  yields self-similarity probability  $p_{ij} = 1$ . We also showed earlier that it directly relates to twice the symmetrically folded Cauchy probability function for discrimination of sensation differences, because observed similarity probabilities for Euclidean distances  $d_{ij}$  to  $y_i = a$ , or to  $y_j = a$ , or to  $(y_i + y_j)/2 = a$ , correspond to single-elliptic distances  $r_{ij} = \arctan(d_{ij}) < 1/2\pi$  with respect to  $r_i = 0$  or  $r_j = 0$  and to distances  $r_{ij} = \arctan(d_{ij}/2) < 1/4\pi$  with  $(r_i + r_j)/2 = 0$  as midpoint, where the corresponding similarity probabilities are defined by

$$p_{ij} = 1 - |r_{ij}|/(1/2\pi) = 1 - \arctan(d_{ij})/(1/2\pi), \quad d_{ij} = 1/2 d_{ij}$$

Its differentiation yields twice the Cauchy distribution function  $1/\{\pi[1 + d_{ij}^2]\} = 1/p_{ij}$  for  $s_{ij}$  smaller than  $s_i$  and multiplied by  $1/2\pi$  for its symmetric folding and scaling to  $1/p_{ij} \leq 1$  it defines the derived similarity probability for sensation distances of elliptic

$$p_{ij} = 1/[1 + d_{ij}^2]$$

Both similarity probability functions satisfy not the conditional choice axiom, but they satisfy the property of conditional irrelevance for other alternatives under the condition that the adaptation level shifts to  $a = y_i$  or  $a = y_j$ , and for confusion probabilities also to  $a = (y_i + y_j)/2$ . If it would unconditionally apply then the common Euclidean sensation space would be solved by the individual difference version of metric MDS-analyses of intensity-comparable distances  $d_{ij} = [1 - \cos^2(1 - p_{ij})]/\cos^2(1 - p_{ij})$ . It requires a proper transformation of observed similarity probabilities by  $\cos^2(1 - p_{ij}) = p_{ij}$  where  $p_{ij}$  is the actually observed similarity probability.

The single-elliptic response distances  $r_{ij}/(1/2\pi)$  to origin  $r_i = 0$  equal dissimilarity probabilities  $1 - p_{ij}$  that satisfy  $\cos^2(1 - p_{ij}) + \sin^2(1 - p_{ij}) = 1$ . It allows the transformation of these elliptic dissimilarity probabilities  $1 - p_{ij}$  to Euclidean similarity probabilities

$$\cos^2(1 - p_{ij}) = \cos^2[r_{ij}/(1/2\pi)] = p_{ij}$$

or to Euclidean dissimilarity probabilities

$$1 - \cos^2(1 - p_{ij}) = \sin^2[r_{ij}/(1/2\pi)] = 1 - p_{ij}$$

The Euclidean co-ordinate representation of the single-elliptic probability space of the observed similarity response probabilities enables comparisons with other, much older scaling analysis methods. On the one hand  $\cos(1 - p_{ij})$  relates to principal component analysis of cosine-transformed dissimilarity probabilities as projection length of Euclidean space vector  $i$  on vector  $j$  (or  $j$  on  $i$ ) by Ekman (1965), whereby then not the sensation space, but a cosine-projected, single-elliptic response space is solved. On the

other hand  $I \cdot p_{ij} = \sin^2[r_{ij}/(1/2\pi)]$  relates by  $\arcsin[f(I \cdot p_{ij})] = r_{ij}/(1/2\pi)$  to the angular function  $2\{\arcsin[\sqrt{(1-p_{ij})}]\} \cdot 1/2\pi$  for the transformation of discrimination probabilities to scale differences (Bock and Jones, 1968, p. 72). It then not only is assumed that the transformation by  $2\{\arcsin[f(1-p_{ij})]\} \cdot 1/2\pi$  yields sensation scale differences  $s_{ij}$ , but also that probabilities  $1-p_{ij}$  are observed discrimination probabilities. But the observed dissimilarity probability is  $1-p_{ij}$  and not  $1-p_{ij}$ , while the transformed probability values  $2\{\arcsin[f(1-p_{ij})]\} \cdot 1/2\pi = 2r_{ij} \cdot 1/2\pi$  are linearly transformed values of single-elliptic response differences and not the sensation scale differences that are supposed to be scaled by the angular response probability function.

Multidimensional analyses of existing similarity models for confusion or identification, or categorisation probabilities generally are obtained by Euclidean or city-block MDS-analyses of metric distances that derive from the transformation of the observed similarity probabilities. In view of the psychophysical response theory the metric MDS-analyses of these similarity models are inappropriate, but can approximately be valid if response distances in the response space with the centroid as origin are almost equal to response distances in response spaces with shifted adaptation levels as origin. This condition approximately holds for response distances in the subspace of responses  $|r| < 1/2$  (or  $|r| < 1/4\pi$  if single-elliptic), due to almost linear part of logistic or Cauchy probability functions between  $p > 0.25$  and  $p < 0.75$ . The similarity models can then also be approximately fitted by metric MDS-analyses of dissimilarity distances in a common Euclidean or hyperbolic sensation space, if the response space distances are located within that subspace of the response space with the centroid as origin. Euclidean MDS-analyses for the additive similarity model requires that one transforms observed similarity probabilities  $p_{ij}$  to  $\cos^2(1-p_{ij}) = p_{ij}$ , whereby for  $c = 2$  the Euclidean sensation space distances of individuals are derived from

$$d_{ij} = \sqrt{((1-p_{ij})/p_{ij}) - 1} \quad |p_{ij}| = \cos^2(1-p_{ij}); p_{ij} = 1 - \arctan(d_{ij}/(1/2\pi))$$

whereby individually weighted and translated, Euclidean sensation spaces are approximately solved. Their Procrustes matching under translations and dimensional dilations then solves the common Euclidean sensation space. The exponentially additive and multiplicative similarity models define the individually intensity-comparable sensation distances  $d_{ij} = 2 \ln(y_i - y_j/a)$  for  $c = 1$  by

$$d_{ij} = \ln[(2-p_{ij})/p_{ij}] \quad |p_{ij}| = 1 - \tanh(1/2 d_{ij})$$

where the metric Euclidean MDS-analyses for the exponentially multiplicative model also approximately solves the individually weighted Euclidean sensation spaces and by the same Procrustes matching the common Euclidean sensation space. The exponentially additive model for hyperbolic sensation spaces requires principal component analyses of matrices of elements  $\cosh(d_{ij}) = \cosh\{\ln[(2-p_{ij})/p_{ij}]\}$ , whereby the  $(m+1)$  Euclidean co-ordinates of individually weighted, hyperbolic sensation spaces of dimensionality  $m$  are solved. For the hyperbolically multiplicative similarity model and  $c = 1$  the principal component analyses concern matrices of elements

$$\cosh(d_{ij}) = (2-p_{ij})/p_{ij} \quad |p_{ij}| = 1 - \tanh[1/2 \ln\{\cosh(d_{ij})\}]$$

and also solves the  $(m + 1)$ -dimensional Euclidean co-ordinates of individually weighted, hyperbolic sensation spaces. In both last cases we obtain from the Procrustes matching of the individual spaces under translations and dimensional dilations the  $(m + 1)$ -dimensional Euclidean co-ordinates of a common,  $m$ -dimensional, hyperbolic sensation space that after its proper translation should correspond to a logarithmic transformed, Euclidean stimulus space. For known Euclidean stimulus spaces we then could verify whether the exponentially additive or hyperbolically multiplicative similarity model holds, where only the exponentially additive model corresponds to open-Euclidean response spaces. Since the hyperbolic multiplicative model for Euclidean stimuli corresponds to an open-hyperbolic response space, our analysis method of open-hyperbolic response spaces, as described in chapter 4 for hyperbolic stimuli, needs to be modified, if the hyperbolic multiplicative similarity model turns out to be the valid model for a Euclidean stimulus space.

The MDS-based similarity model analyses, summarised here above, however, assume that individual response space distances are equal to response distances to their space origin, which is incorrect, but may approximately hold for response distances of comparable sensations in the proximity to the adaptation point of individuals. However, in view of dynamic adaptation processes in perception, described in section 7.1, shifting adaptation levels may be present in studies on confusion, or identification, or categorisation probabilities of stimuli with respect to target stimuli, whereby response distances are distances to the response for the target stimulus as origin. The probability-derived sensation space distances for the discussed similarity models may then be valid, but then their multidimensional analyses methods need to be modified, due to stimulus-dependent sensation weights for shifted adaptation levels. In the next sections we restrict ourselves to complete adaptation-level shifts to the sensation of target stimulus  $j$  or to midpoint sensation of stimuli  $i$  and  $j$ . For explicitness of shifted adaptation-level types we define comparable sensation distances under shifted adaptation levels by

$$\text{or } d_{ij}^I = d_{ij}/a_j = 2|y_i - y_j|/a_j \quad \text{for } a_j = y_j/a \quad \text{and} \quad d_{ij} = 2|y_i - y_j|/a$$

$$d_{ij}^{!ij} = d_{ij}/a_{ij} = 2|y_i - y_j|/a_{ij} \quad \text{for } a_{ij} = \frac{1}{2}(y_i + y_j)/a \quad \text{and} \quad d_{ij} = 2|y_i - y_j|/a$$

In the first case the similarity probability models apply to analyses of weighted sensation distances with weights that depend on the target stimuli, whereby similarity probabilities become asymmetric and intransitive. The second case concerns analyses of weighted sensation distances with weights that depend on stimulus pair midpoints, whereby similarity probabilities are symmetric, but can be intransitive. So-called biased choice probability models also describe asymmetric and intransitive similarities, which models are discussed in the next and following sections.

### 7.2.3. *Multiplicative bias in choice and similarity probability*

Some MDS-based similarity models imply symmetry of similarity probability  $p_{ij} = p_{ji}$ , where the choice axiom for  $v_{ij} = \exp(-d_{ij})$  as similarity magnitude is assumed. Several studies show support for symmetry of similarity by observed confusion probability data (Atkinson, Bower, and Crothers, 1965, Wagenaar, 1968), but many other studies don't support similarity symmetry. Empirical violations of the choice axiom are fully

acknowledged by Luce (1977) in his review on the evidence for his choice axiom from the 20 years of relevant research after its original formulation, while Luce (1959b, p. 133) already wrote

*"possibly we can find Axiom I <Luce's original choice axiom> directly confirmed for elementary choices. but probably not for more complex ones".*

It is especially not confirmed in studies on discrimination or similarity probabilities of stimuli that exhibit relatively large intensity differences and/or different amounts of practice for stimuli in stimulus combinations  $i|j$  or  $j|i$  (Hodge and Pollack, 1962). Such conditions may clearly cause shifts of the adaptation levels and thus indeed might yield similarity response probabilities that are not symmetric. The data then generally fit the so-called biased choice model much better. Luce and Galanter (1963a, p. 227) derived a biased choice model by plausible assumptions that introduces a so-called response bias for choice probabilities, -"which can differ from one experimental run to another" (Luce, 1977). The biased choice model for asymmetric response probabilities (Luce and Galanter, 1963a, sec. 4.2.) writes the discrimination probability for stimulus  $i$  as more intensive than stimulus  $j$  for some intensity scale  $v$  by

$$p_i = B_i \cdot v_i / [\sum_{j=1}^n B_j \cdot v_j]$$

and thus for stimulus  $i$  with respect to target stimulus  $j$  by

$$p_{ij} = \beta_i \cdot v_i / [\beta_j \cdot v_j + \beta_i \cdot v_i] = 1 / [1 + (\beta_j \cdot v_j) / (\beta_i \cdot v_i)]$$

The biased similarity probability that a presented stimulus  $i$  is confused with a target stimulus  $j$  or categorised as belonging to stimulus category  $j$  is written by Nosofsky (1991) for biased similarity scale values  $\beta_i \cdot \beta_j \cdot v_{ij}$  of pairs  $(i, j)$  with  $v_{ij} = \exp(-d_{ij})$ , where  $\beta_j$  cancels out in

$$p_{ij} = \beta_i \cdot v_{ij} / [\sum_{g=1}^n \beta_g \cdot v_{ig}]$$

If  $p_{ij}$  expresses our implicit condition  $a = y$ , then for pair  $(i, j)$  and  $v_{ij} = 1$  it would write as

$$p_{ij} = \beta_i \cdot v_{ij} / [\beta_j \cdot v_{ij} + \beta_i \cdot v_{ij}] = 1 / [1 + \beta_j / \beta_i]$$

It would yield self-similarity probability  $p_{ii} = 0.5$  by  $i=j$  and  $v_{ii} = \exp(0) = 1$  and, therefore, again in consistency with  $v_{ij} = \exp(-d_{ij})$  for sensation distances  $d_{ij}$  in the expression of the folded logistic probability function for similarity we actually should write

$$p_{ij} = 2 / [1 + \beta_j / \beta_i \cdot \exp(d_{ij})] = 2 / [1 + (\beta_j / \beta_i) \cdot \exp(d_{ij})] \quad v_{ij} = \exp(-d_{ij})$$

For similarity scale  $v_{ij} = 1/d_{ij}^2$  it is written as

$$p_{ij} = 1 / [1 + \beta_j / \beta_i \cdot d_{ij}^2] = 1 / [1 + (\beta_j / \beta_i) \cdot d_{ij}^2]$$

Again generally  $v_{ij} = \exp(-d_{ij}^c)$  or  $v_{ij} = 1/d_{ij}^c$  with  $r = 1$  or  $r = 2$  for sensation distance  $d_{ij}$  in respectively a city-block or Euclidean sensation space and with  $c = 1$  or  $c = 2$  for respectively exponential or Gaussian decay of similarity generalisation, while the  $\beta$ -terms represent the so-called response bias. If squared distances  $d_{ij}$  in  $v_{ij} = \exp[-d_{ij}^2]$  or

$v_{ij} = 1/d_{ij}^2$ , are assumed to equal the sum of squared dimensional distances in Euclidean sensation spaces then we could call the similarity model for  $B.I(8, y_{ij}) = (B.I/3) \exp(-d_{ij})$  an *exponentially multiplicative similarity model with multiplicative bias* and for  $(B.I(B, y_{ij})) = (\beta_j/\beta_i) d_{ij}^2$  an *additive similarity model with multiplicative bias*. For a hyperbolic sensation space the hyperbolic cosines of dimensional distances combine by multiplication to the hyperbolic cosine of the space distance, whereby probability  $p_{ij} = 2/[1 + B.I(B, v_{ij})]$  for  $v_{ij} = 1/\cosh(d_{ij})$  would become a *hyperbolically multiplicative similarity model with multiplicative bias*. For  $v_{ij}$  defined by the square root of the sum of squared Euclidean co-ordinates  $v_{ij} = \exp(-d_{ijk})$  of the hyperbolic sensation space it would become an *exponentially additive similarity model with multiplicative bias*. The two biased choice probability models for flat sensation spaces are called biased MDS-choice models, because distances that are derived from biased choice probabilities and are fitted by metric Euclidean or city-block MDS-analysis (unnecessarily assuming  $c = r$ ) to a m-dimensional sensation space, Initially solved space distances and observed probabilities are used for an adjusted estimation of bias parameters that in tum define modified distances for observed probabilities, where modified distances are used for renewed MDS-analyses and so on until convergence.

A MDS-analysis for the model with multiplicative bias would be solved for similarity magnitudes

$$\text{from } v_{ij} = \exp[-d_{ij}^c]$$

$$P_{ij}' = 2/[1 + (\beta_j/\beta_i) \cdot \exp(d_{ij}^c)]$$

One derives from this expression

$$\ln[(2 - P_{ij}')/P_{ij}'] = d_{ij}^c + \ln(\beta_j) - \ln(\beta_i)$$

where a linear regression with dummy variables solves distances  $d, c$  and bias parameters  $\beta_j$  from observed values of  $P_{ij}'$

Similarly for an additive model with multiplicative bias and  $v_{ij} = 1/d_{ij}^2$  we have

$$\ln[(1 - P_{ij}')/P_{ij}'] = \ln[(\beta_j/\beta_i) d_{ij}^2] = 2\ln(d_{ij}) + \ln(\beta_j) - \ln(\beta_i)$$

whereby also from observed values  $p_{ij}$  the distance and bias parameters are solved by linear regression with dummy variables. For  $c=2$  or  $c=1$  derived distances can be fitted by metric MDS-analysis and for the solved space distances the bias parameters can be readjusted. Alternating the weighted regression and MDS solutions that both minimise the Chi-square of predicted choice frequencies then converge to m-dimensional space distances from m'n object and n-1 bias parameters.

Confusion or categorisation studies show overwhelming evidence for asymmetric similarities with respect to target stimuli or object categories. Nosofsky (1991) shows that biased similarity models can be formulated by metric versions of Holman's (1979) model for asymmetric proximity. Holman's model defines proximity  $P(i,j)$  of stimuli  $i$  and  $j$  as

$$P(i,j) = s(i,j) + c'(i) + c(j),$$

where  $s$ ,  $c'$  and  $c$  are set-theoretic functions of the stimuli. Nosofsky reformulated it metrically for similarities  $V(i,j)$  of objects with continuous attributes as

$$V(i,j) = F[s(i,j) + f(i) + f(j)]$$

for  $F$  as a monotone function,  $s(i,j)$  as symmetric (dis)similarity function that is related to a space distance between  $i$  and  $j$ , and for  $f(i)$  and  $f(j)$  as bias functions for objects  $i$  and  $j$ . Nosofsky generally takes  $F(z) = \exp(z)$  and  $s(i,j) = -d_{ij}$ , where  $d_{ij}$  is taken as a flat sensation-space distance between  $i$  and  $j$ , while for  $f(i) = \ln(\beta_i)$  and  $f(j) = \ln(\beta_j)$  we

see that 
$$F[s(i,j) + f(i) + f(j)] = \exp(-d_{ij}) \beta_i \beta_j = \beta_i \beta_j v_{ij}$$

It defines Nosofsky's multiplicative or our *exponentially multiplicative similarity model with multiplicative bias* if the sensation space is flat, because then it implies that the multiplication of dimensional tensus  $v_{ij} = \exp(-d_{ij})$  equals  $v_{..} = \exp(-d_{..})$ . However, if  $s(i,j) = -2d_{ij}$  and the sensation space is hyperbolic then it would define an *exponentially additive similarity model with multiplicative bias*, because then similarity magnitudes  $v_{ij} = \exp(-2d_{ij})$  are squared Euclidean co-ordinate tensus of hyperbolic sensation distances  $d_{ij}$ . If  $s(i,j) = -2 \ln(d_{ij})$  then it defines an *additive similarity model with multiplicative bias*, because then we obtain

$$F[s(i,j) + f(i) + f(j)] = \beta_i \beta_j / d_{ij}^2 = \beta_i \beta_j v_{ij}$$

where similarity magnitude  $v_{ij} = 1/d_{ij}^2$  is defined by the Euclidean additivity of squared dimensional distances  $d_{ij}^2$ . This additive and the exponentially additive similarity models with multiplicative bias imply both the biased choice probability model because the bias  $\beta_i$  cancels out in the biased choice probability model

$$p_{ij} = \beta_i \beta_j v_{ij} / \sum_{g=1}^{k-1} \beta_g v_{ig} = \beta_j v_{ij} / \sum_{g=1}^{k-1} \beta_g v_{ig}$$

whereby

$$p_{ij} = \beta_j v_{ij} / (\beta_j v_{ij} + \beta_i v_{ij}) = 1 / (1 + \beta_i / \beta_j v_{ij})$$

But, as discussed earlier, for  $v_{ij} = 1/d_{ij}^2$  and  $v_{ij} = \exp(-2d_{ij})$  it does not satisfy the choice axiom, although the property of irrelevance of other alternatives is satisfied, because Euclidean or hyperbolic distances depend not on other distances. Notice that for hyperbolic distance  $d_{ij}$  also Holman's model with definition  $s(i,j) = -\ln[\cosh(d_{ij})]$  yields

$$F[s(i,j) + f(i) + f(j)] = \beta_i \beta_j / \cosh(d_{ij}) = \beta_i \beta_j v_{ij}$$

whereby for similarity magnitude  $v_{ij} = 1/\cosh(d_{ij})$  it would define a *hyperbolic multiplicative similarity model with multiplicative bias*. These hyperbolic and exponentially multiplicative similarity models with multiplicative bias might satisfy the biased choice axiom, but whether multiplicative bias holds for these models is discussed in the next section.

Nosofsky (1991) shows that the distance- and density-dependent model of Krumhansl (1978), Tversky's (1977) feature-contrast model, Carroll's (1976) hybrid spatial and hierarchical model, and Nosofsky's (1991, 1992a,b) general context model are special cases of Nosofsky's specification of Holman's model. Nosofsky (1991, p.

134) concludes from many sets of analysed data that the bias actually is not response-dependent, but that responses can be influenced by a stimulus set-independent bias and/or a stimulus-dependent bias. The stimulus set-independent bias represents the association strength of a memorised sensation with a perceived stimulus, while stimulus-dependent biases are due to locally different densities of presented stimuli in the space. Referring to sections 7.1.3 and 7.1.4, stimulus-dependent biases may correspond to momentary shifting adaptation levels from a nonhomogeneous stimulus set or to relatively long exposures of stimuli from a homogeneous stimulus set. Stimulus set-independent bias derives from task-dependent selection of reference levels for targets from memories of individuals. Thus, biases are stimulus-dependent and/or task-dependent, instead of response-induced, although they are called response-bias models for choice probabilities. Nosofsky's overview convincingly shows that most confusion probability data in tasks that imply (i-to-j)-similarity, instead of between i and j, fit the MDS-based choice model with multiplicative bias better than without bias.

#### 7.2.4. *MuLtiplicative or power-raised, stimuLus-dependent similarity bias*

In chapter 4 we defined intensity-comparable sensation spaces with constant adaptation levels and thus constant dimensional weights. However, based on the dynamic adaptation processes and adaptation level selections in (i-to-j)-similarity tasks, we must also define stimulus-dependent dimension weights as twice the inverse values of their shifted or selected dimensional adaptation levels. In stimulus confusion experiments of a presented stimulus  $i$  that is evaluated for its (i-to-j)-similarity with respect to respectively memorised stimuli or stimulus categories  $j$  for a fixed set of presented stimuli, the dimensional adaptation levels may cognitively shift towards the respectively memorised sensations  $y_j$ , as hypothesised in subsection 7.1.4. The sensation distance of a presented stimulus  $i$  to a memorised or repeatedly presented target stimulus  $j$  in an intensity-comparable Euclidean sensation space then is defined for adaptation-level shift to target  $j$  by

$$d_{ij}/a_j = \sqrt{\sum_{k=1}^{k=m} [(2|Y_{ik} - Y_{jk}|/a_k)/(Y_{jk}/k)]^2} = \sqrt{\sum_{k=1}^{k=m} (d_{ijk}/a_{jk})^2} \quad | a_{jk} = y_{jk}/a_k$$

for  $d_{ij} = 2|y_i - y_j|/a$  with  $a_j = y_j/a$  for the shift of the adaptation level in the Euclidean Fechner space. Since the response distance of  $i$  to  $j$  with  $j$  as reference level is identical to the absolute value of the response to sensation of  $i$ , the logistic similarity probability for similarity magnitude  $v_{ij} = \exp(-d_{ij})$ ,  $d_{ij} = 2|y_i - y_j|/a$ ,  $y_j/a = a_j$ , and power exponent  $\tau_j = \ln(a_j) = \ln(b/u)/\ln(x_j/u)$  with stimulus adaptation level  $b/u$  and threshold  $u/\mu$  writes as

$$p_{ij|j} = \exp\{-d_{ij}/a_j\} / \left\{ \sum_{g=1}^{g=n} \exp[-d_{ig}/a_g] \right\} = v_{ij} / \left[ \sum_{g=1}^{g=n} v_{ig}^{\tau_j} \right], \quad \tau_j = a/y_j$$

whereby  
and

$$p_{ij|j} = \frac{1}{1 + \sum_{g=1}^{g=n} \left\{ \exp\left[-\frac{d_{ig} - d_{ij}}{a_g}\right] \right\}^{\tau_j}} = \frac{1}{1 + \left( \frac{v_{ig}}{v_{ij}} \right)^{\tau_j}} \quad \left| \begin{array}{l} y_j/a = a_j \\ v_{ij} = \exp(-d_{ij}) \end{array} \right.$$

define by conditional similarity probability  $p_{ij|j}$  the probability that (i,j) is more similar than (g,j) and by confusion probability  $p_{i|j}$  the probability that stimulus (i) is recognised as stimulus (j). This follows from  $p_{i|j} = (1 + \tau_{ij} p_{ij|j})/2$  for similarity



response  $r_{ij}|g_j = \tanh[V2(d_{ij} - d_{gj})/a_j]$  with  $r_j = 0$ , whereby

while 
$$p_{ij}|g_j = \frac{\{1 + \tanh[V2(d_{ij} - d_{gj})/a_j]\}^2}{1 + \exp\{(d_{ij} - d_{gj})/a_j\}J}$$

$$p_{ij}|j = 1 - \frac{\{1 - \tanh[V2(d_{ij} - d_{gj})/a_j]\}^2}{1 + \exp\{(d_{ij} - d_{gj})/a_j\}J}$$

It follows for  $\tau = 2/a_j$ ,  $\tau_j = \sqrt{a_j}$ , and  $\tau_j = 2/y_j$ , that

or 
$$(d_{ij} - d_{gj})/a_j = \ln[(1 - p_{ij}|g_j)/p_{ij}|g_j] = -\tau_j \cdot \ln(v_{ij}/v_{gj}) = -\tau_j \cdot \ln(x_{ij}/x_{gj})$$

$$d_{ij}/a_j = 10[(2 - p_{ij}|j)/p_{ij}|j] = -\tau_j \cdot \ln(v_{ij}) = -\tau_j \cdot \ln(x_{ij})$$

define by their respective transformations of observed conditional similarity or confusion probabilities the conditionally weighted Euclidean distances that can be solved by an iterative metric, Euclidean MDS-analysis, as shown in the mathematical section below. Notice that the expressions define an asymmetric similarity or confusion probability due to the power-raised bias  $\tau_j$  for  $p_{ij}|g_j$  or  $p_{ij}|j$ . Since these probabilities correspond to open-hyperbolic response spaces with unit pseudo-radius, the derived sensation distances are Euclidean and not Minkowskian. Thus, the psychophysical response theory defines a new biased choice model for (i-to-j)-similarity as an *exponentially multiplicative similarity model with power-raised bias*, because for Euclidean sensation spaces the multiplication of exponential terms for squared dimensional distances defines the exponent for their squared space distance. Models with  $c = 2$  would yield

$$\ln[(1 - p_{ij}|g_j)/p_{ij}|g_j] = (d_{ij}/a_j)^2 - (d_{gj}/a_j)^2,$$

$$\ln[(2 - p_{ij}|j)/p_{ij}|j] = (d_{ij}/a_j)^2,$$

where  $v_{ij} = \exp[-d_{ij}^2]$  with  $\tau_j = a_j^{-1}$  would define a biased similarity with a so-called Gaussian decay function for similarity generalisation, but our derivations define  $c = 1$  and then similarity magnitude  $v_{ij} = \exp(-d_{ij})$  implies the exponential decay function.

Referring to the arctangent-based response transformations of Euclidean sensations, we may also have single-elliptic response spaces. Observed confusion probabilities of stimuli i with respect to a target stimulus j are then defined by

whereby 
$$p_{ij}|j = 1 - \frac{\tan^{-1}(d_{ij}/a_j)}{\pi/2} = 1 - \arctan(d_{ij}/a_j)/(\pi/2)$$

$$\tan[\pi/2 \cdot (1 - p_{ij}|j)] = d_{ij}/a_j$$

while its differentiation and proper scaling yields

$$p_{ij}|j = 1/[1 + \tan^2\{\arctan(d_{ij}/a_j)\}] = \cos^2[\arctan(d_{ij}/a_j)] = \cos^2(1 - p_{ij}|j) = 1/[1 + (d_{ij}/a_j)^2]$$

as the derived confusion probability that directly can be transformed to Euclidean space distances. Since the tangent of single-elliptic response distances with respect to  $f = 0$  specify Euclidean sensation distances, we obtain by

$$p_{ij} = 1/[1 + (d_{ij}/a_j)^2] = 1/[1 + 1/(\beta_j \cdot v_{ij})] = 1/[1 + \sum_{k=1}^{k=m} (d_{ijk}/a_{jk})^2]$$

for  $v_{ij} = 1/d_{ij}^2 \dots (2|y_i - y_j|/a)^2$  and  $\beta_j = (1/a_j)^2 = (a/y_j)^2$  an additive similarity model with **multiplicative bias** for derived confusion probabilities. The transformation of arctangent-based similarity response to observable, conditional similarity probability yields

$$p_{ij} |g_j = [1 - r_{ij} |g_j / (Vm)]^{1/2} = [1 - \arctan(d_{ij} - d_{gj})/a_j]^{1/2}$$

whereby

$$\tan[1/2\pi \cdot (1 - 2p_{ij} |g_j)] = |d_{ij} - d_{gj}|/a_j$$

defines the conditionally weighted absolute distance differences in Euclidean sensation spaces. For actually observed confusion and conditional similarity probabilities of double-elliptic stimulus pairs under adaptation-level shifts to target sensations it defines an *arctangent-based similarity models with multiplicative bias*. However, its differentiation and scaling to

$$p_{ij} |g_j = 1/[1 + \{(d_{ij} - d_{gj})/a_j\}^2]$$

yields no proper probability expression, while also the conditional choice axiom holds not for similarity magnitude  $v_{ij} = 1/d_{ij}^2$ . Therefore, also probability expression

$$p_{ij} |g_j = 1/[1 + v_{ij} \cdot |g_j|] = 1/[1 + (d_{ij} - d_{gj})^2]$$

holds not for conditional similarity probabilities from single-elliptic response spaces. Thus, only for derived confusion probabilities an additive model with multiplicative bias and power exponent  $n = 2$  holds, according to our psychophysical response theory. Notice that the additive similarity model with multiplicative bias for the derived confusion probabilities requires that observed confusion probabilities  $p_{ij}$  are transformed to  $p_{ij} |g_j = \cos^2(1 - p_{ij})$  before we can use distances  $d_{ij} = \sqrt{[(1 - p_{ij})/p_{ij}]}$  in a MDS-based similarity probability model.

For hyperbolic sensation spaces  $v_{ij} = \exp(-d_{ij})$  may also apply and if  $a_i = y_i/a$  then for power exponent  $T = 1/a$  it follows that the folded logistic probability function specifies by

$$p_{ij} = 2/[1 + \exp(d_{ij}/a)] = 2/[1 + (1/v_{ij})^T] \quad |d_{ij} = 2 \ln(y_i/y_j/a), a_i = y_i/a$$

the confusion probability that stimuli  $i$  are recognised as stimulus  $j$ . Although the choice axiom applies here not (see p. 304), the conditional similarity probability

$$p_{ij} |g_j = 1/[1 + \exp\{(d_{ij} - d_{gj})/a\}] = 1/[1 + (v_{ij} - v_{gj})^T] \quad |d_{ij} = 2 \ln(y_i/y_j/a), a_i = y_i/a$$

holds for this logistic probability of distance difference  $(d_{ij} - d_{gj})/a$  by the restriction to  $n=2$  with respect to fixed target stimulus  $j$ . Thereby, also weighted, hyperbolic sensation distances are then validly defined by terms  $\tau_j = a/y_j$  and  $\eta_j = 2/\ln(x_j/y_j)$  by

$$d_{ij}/a_j = \ln[(2 - P_{ij}^I)P_{ij}^I] = -\tau_j \cdot \ln(v_{ij}) = -\eta_j \cdot \ln(x_i/x_j)$$

or

$$(d_{ij} - d_{gj})/a_j = \ln[(1 - p_{ij} |g_j)/p_{ij} |g_j] = \tau_j \cdot \ln(v_{ij}/v_{gj}) = -\eta_j \cdot \ln[(x_i/x_j)/(x_g/x_j)] = \tau_j \cdot \ln(v_{ij})$$

Since here

$$\exp(-d_{ij}/a_j) = \sqrt{\prod_{k=1}^{k=m} \exp(-2d_{ijk}/a_{jk})} = v_{ij}^j,$$

applies to Euclidean stimulus dimensions with respect to  $x_k/a_k = 1$ , we have by the additive combination of dimensional terms  $\exp(-2d_{ijk}/a_{jk})$  an *exponentially additive similarity model with power-raised bias*, which requires a representation in the Euclidean stimulus or hyperbolic Fechner sensation space. The choice axiom, however, conditionally applies for similarity magnitudes that derive from the redefined, open-hyperbolic confusion or similarity responses as responses  $r_{ij}$  or  $r_{ij}^g$  with respect to  $r_j = 0$  that are specified for weighted hyperbolic sensation distances  $\cosh(d_{ij}/a_j)$  as

$$r_{ij} = \tanh[\ln\{\cosh(d_{ij}/a_j)\}]$$

and

$$r_{ij}^g = \tanh[\ln\{\cosh(d_{ij}/a_j)/\cosh(d_{ij}^g/a_j)\}].$$

For similarity magnitudes

$$v_{ij} = 1/\cosh(d_{ij}/a_j) = 1/\cosh[2(y_i - y_j)/a]$$

and compound bias  $\beta_{ij}$  that depends on hyperbolic distance  $d_{ij}$  and weight  $a_j$

$$\beta_{ij} = \cosh(d_{ij}/a_j)/\cosh(d_{ij}^g/a_j)$$

the confusion probability is defined by

$$p_{ij} = t - r_{ij} = 2/[1 + \cosh(d_{ij}/a_j)] = 2/[1 + 1/(\beta_{ij} \cdot v_{ij})], \quad \left| \begin{array}{l} a_j = y_j \\ J \end{array} \right.$$

$$[2 - p_{ij}]/p_{ij} = \cosh(d_{ij}/a_j),$$

while

$$p_{ij}^g = (1 + r_{ij}^g)/2 = t/[1 + \cosh(d_{ij}/a_j)/\cosh(d_{ij}^g/a_j)] = 1/[1 + (\beta_{ij}/\beta_{ij}^g) \cdot (v_{ij}/v_{ij}^g)]$$

defines the conditional similarity probabilities, whereby

$$[1 - p_{ij}^g]/p_{ij}^g = \cosh(d_{ij}/a_j)/\cosh(d_{ij}^g/a_j).$$

Since here,

$$\beta_{ij} \cdot v_{ij} = \frac{\cosh(d_{ij}/a_j)}{\cosh(d_{ij}/a_j)} = \prod_{k=1}^{k=m} \frac{\beta_{ijk} \cdot v_{ijk}}{\beta_{ijk} \cdot v_{ijk}} = \prod_{k=1}^{k=m} \frac{\cosh(d_{ijk}/a_{jk})}{\cosh(d_{ijk}/a_{jk})}$$

the similarity model becomes a *hyperbolically multiplicative similarity model with multiplicative compound bias*. It defines a new similarity model with multiplicative, distance- and stimulus-dependent bias, where we can solve by a principal component analysis of  $\cosh(d_{ij}/a_j)$  with iteratively improved estimates of  $a_j$  values the hyperbolic sensation space from observed confusion or conditional similarity probabilities, as also shown in the mathematical section below.

The observed  $p_{ij}$  or  $p_{ij}^g$  values yield  $n(n-1)$  or  $\frac{1}{2}n(n-1)^2$  equations for  $\frac{1}{2}n(n-1)$  distances  $d_{ij} = d_{ji}$  and  $n$  values  $a_j$

$$\text{or} \quad \ln\{[2 - p_{ij}]/p_{ij}\} = \ln(d_{ij}/a_j) \quad \ln(a_j)$$

$$a_j \{ \ln[(1 - p_{ij}) |g_j]! p_{ij}^n |g_j J] \} = d_{ij} - d_{gj}$$

in the exponentially additive or multiplicative models, while in the the arc tangent-based confusion or conditional similarity probabilities

$$\ln[\tan(\frac{\pi}{2}) \cdot (1 - p_{ij})] = \ln(d_{ij}) - \ln(a_j)$$

or

$$a_j \cdot [\tan(\frac{\pi}{2}) (1 - 2p_{ij})] = d_{ij} - d_{gj}$$

the first of the two expressions are solved by linear regressions with dummy variables for the estimates of  $\ln(d_{ij})$  and  $\ln(a_j)$  under scaling of average  $a_j$  to 2, because otherwise  $d_{ij} = 2|y_i - y_j|$  or  $y_i/a_j = a_j$  are undetermined. For the second equation we start the solution with

$a_j = 2$  and for solved values of  $d_{ij}$  and  $d_{gj}$  with average  $d_{ij}$  set to  $\exp(1)$  we obtain by

$$\sum_{i,g=1,2}^{i,g=(n-1)(n-2)/2} \{ (d_{ij} - d_{gj}) / \ln[(1 - p_{ij}) |g_j] / p_{ij} |g_j] \} / \{ \frac{1}{2}(n-1)(n-2) \} = a_j$$

or

$$\sum_{i,g=1,2}^{i,g=(n-1)(n-2)/2} \{ (d_{ij} - d_{gj}) / \tan(\frac{\pi}{2}) (1 - 2p_{ij}) |g_j] \} / \{ \frac{1}{2}(n-1)(n-2) \}$$

improved values of  $a_j$ , where after the regression solution for the second equation is solved with these estimates of  $a_j$  and by repeated solutions until convergence we obtain the  $a_j$  and  $d_{ij}$  values.

For the hyperbolically multiplicative model we obtain the equations

$$\ln\{\operatorname{ar\,cosh}[(2 - p_{ij})/p_{ij}]\} = \ln(d_{ij}) - \ln(a_j)$$

or

$$\ln[(1 - p_{ij}) |g_j] / p_{ij} |g_j] = \ln\{\cosh\{d_{ij}/a_j\} - \ln\{\cosh\{d_{gj}/a_j\}\}$$

where the first equation is solved as described above, while the second equation becomes iteratively solved for  $d_{ij}$  and  $a_j$  by initially taking  $a_j = 2$ . The initially solved values of  $\cosh(d_{ij})$  are then used in

$$\operatorname{ar\,cosh}(d_{ij}) / \operatorname{ar\,cosh}[(1 - p_{ij}) |g_j] / p_{ij} |g_j] = a_j$$

$$\operatorname{ar\,cosh}(d_{gj}) / \operatorname{ar\,cosh}[(1 - p_{ij}) |g_j] / p_{ij} |g_j] = a_j$$

where first solved values  $a_j$  are used for their improved solutions by

$$\ln[\operatorname{arcosh}\{[(1 - p_{ij}) |g_j] / p_{ij} |g_j] / \cosh(d_{ij}/a_j)\}] = \ln(d_{ij}) - \ln(a_j)$$

$$\ln[\operatorname{ar\,cosh}\{[(1 - p_{ij}) |g_j] / p_{ij} |g_j] / \cosh(d_{gj}/a_j)\}] = \ln(d_{gj}) - \ln(a_j)$$

where repeated solutions after convergence solves  $d_{ij}$  and  $a_j$ .

Next a metric MDS-analysis of solved  $d_{ij}$  values solves the  $m$ -dimensional Euclidean sensation space with estimated distances  $d_{ij}$  after the solved space is translated and centrally dilated in such a way that dimensional values satisfy  $y_{ijk} > 0$ , while the configuration centroid becomes located at distance 2 from the translated origin. Alternatively the principal component analysis of the matrix with  $\cosh(d_{ij})$  elements solves the Euclidean  $(m+1)$ -co-ordinates of the  $m$ -dimensional hyperbolic sensation space. Rotation of these co-ordinates to zero projections of centroid point  $a$ , except for one dimension  $k$  with  $Y_{jk} > 1$  and a central dilation

that scales average  $Y_k$  to  $a_k = 2$ , yields hyperbolic distances  $d_{ij}$  by ar  $\text{COSH}[Y_{ik} - Y_{jk}]$ .

For solved space values  $a_k$  should equal  $\frac{1}{2}Y_k$  for  $a = 2$ , provided the space is correctly translated and centrally dilated. Dilating and translating the solved space in such a way that the differences between  $a_k$  and  $\frac{1}{2}Y_k$  are minimised, we may take  $a_k = \frac{1}{2}Y_k$  as fixed values and can solve from the above equations best fitting, new estimates of  $d_{ij}$ , that are again used for the space solutions, which is repeated until convergence.

Confusion probability models with power-raised bias derive from a Holman-Nosofsky model

$$V(i,j) = F[s(i,j) \oslash \{f(i) \oplus f(j)\}]$$

by defining operators  $\oslash$  as division and  $\oplus$  as addition, function  $F(z) = \exp(-z)$ , value  $s(i,j) = d_{ij} = 2 \ln y_{ij} - y_{ij}/a$  with  $f(i) = 0$  and  $t(U) = a_{ij} = y_{ij}/a$ . We then obtain similarity magnitude  $v_{ij} = \exp(-d_{ij}/a)$  and  $\tau_{ij} = 1/a$ .

$$F[s(i,j) \oslash \{f(i) \oplus f(j)\}] = \exp[-d_{ij}/a] = v_{ij}$$

for  $d_{ij}$  as distance in a hyperbolic or Euclidean sensation space. Also the additive similarity model with multiplicative bias derives from this general model by  $F(z) = 1/z^2$  and the same terms  $s(i,j)$ ,  $f(i)$ , and  $f(j)$ . It yields for  $v_{ij} = 1/(d_{ij})^2$  and  $\beta_{ij} = a_{ij} = y_{ij}/a$ .

$$F[s(i,j) \oslash \{f(i) \oplus f(j)\}] = 1/(d_{ij})^2 = \beta_{ij} \cdot v_{ij}$$

Its multiplicative bias is evident from the product of  $\beta_{ij}$  and  $v_{ij}$ , while squared sensation distance  $d_{ij}$  defines the additivity of the similarity model by its Euclidean sensation distances. But the arctangent-based and hyperbolically multiplicative models with multiplicative biases derive not from a generalised Holman-Nosofsky model.

If adaptation levels in (i to j)-dissimilarity evaluations are not fully shifted to the sensation of the target stimulus or category, thus for  $0 < w < 1$ , we then have

$$\text{and } \begin{aligned} s_{ij} &= y_{ij} \ln[(1-w)a_{ij} + w \cdot y_{ij}] - I = y_{ij} \ln a_{ij} - I \\ s_{ji} &= y_{ji} \ln[(1-w)a_{ji} + w \cdot y_{ji}] - I = y_{ji} \ln a_{ji} - I \neq 0 \end{aligned}$$

$a_{ij} = (1-w)a_{ij} + w \cdot y_{ij}$

For  $0 < w < 1$  we have  $a_{ij} \neq y_{ij}$ , whereby  $r_{ij}$  becomes no longer the shifted response space origin and, therefore, we then have no reduction of dissimilarity responses  $|L_{ij}|$  as response space distances of response  $L_{ij}$  to  $L = 0$ . Thus, for hyperbolic tangent- or arctangent-based dissimilarity response we can't define the confusion probability by response complement, nor the conditional similarity probability by linear transformed dissimilarity responses. Thereby, no probability model can be derived for confusion and similarity probabilities if the adaptation-level shift is not complete (thus, if  $w \neq 1$ ).

Summarising: by the psychophysical response theory under complete adaptation level shifts to the reference stimulus  $j$  we derive for (i-to-j)-similarity responses either:

- I. for single-elliptic response spaces an additive model with multiplicative bias for transformed confusion probabilities with  $1/(d_{ij})^2$  as similarity magnitudes of Euclidean sensation spaces (no additive model for conditional similarities) or an arctangent-based similarity model with multiplicative bias for confusion and conditional similarity probabilities;

2. for open-Euclidean response spaces an exponentially additive similarity model with power-raised bias for confusion and conditional similarity probabilities with values  $\exp(-d_{ij})$  as similarity magnitudes for hyperbolic sensation spaces;
3. for open-hyperbolic response spaces
  - a) an exponentially multiplicative similarity model with power-raised bias for confusion and conditional similarity probabilities with values  $\exp(-d_{ij})$  as similarity magnitudes for Euclidean sensation spaces, or
  - b) a hyperbolically multiplicative similarity model with multiplicative compound bias for confusion and conditional similarity probabilities with values  $1/\cosh(d_{ij})$  as similarity magnitude of a Minkowskian space for logarithmic transformed, hyperbolic sensation distances  $\ln(\cosh(d_{ij}))$  with r-metric  $r=1$ .

Only these biased, MDS-based similarity models are consistent with the psychophysical response theory under complete adaptation level shifts to target-stimulus sensations. It would theoretically exclude the validity of Nosofsky's exponentially multiplicative similarity model with multiplicative bias. Nosofsky (1992a) shows overwhelming empirical evidence for the exponentially multiplicative model with multiplicative bias over the additive similarity model with multiplicative bias from MDS-analyses of data in many studies on categorisation probabilities of stimuli with respect to memorised or learned categories. Thus, on the one hand the additive similarity model with multiplicative bias is invalidated by the empirical evidence, which would also invalidate the arctangent function as response function as well as the single-elliptic geometry for response spaces and the double-elliptic geometry for stimulus spaces. On the other hand the exponentially multiplicative similarity model with multiplicative bias is inconsistent with our psychophysical response theory, but is sustained by empirical evidence. Nonetheless, if power-raised bias parameters are approximated by multiplicative bias parameters, then Nosofsky's results may sustain the hyperbolic tangent as response function for Euclidean sensation spaces in our psychophysical response theory. However, Nosofsky's evidence may not invalidate the arctangent as response function and the single-elliptic geometry of the response space, because the analyses concern observed probabilities  $p_{i|j}$  that are not prior transformed to probabilities by  $\cos^2(1 - p_{i|j}) = p_{i|j}$ , as required for the additive similarity model with multiplicative bias. The exponentially additive similarity models with power-raised bias, the hyperbolically multiplicative similarity model with multiplicative compound bias, and the arctangent-based similarity model with multiplicative bias are not considered by Nosofsky. Therefore, Nosofsky's (1992a) results are inconclusive for an empirically sustained choice for one of the alternative similarity models.

The evidence of Ashby and Perrin (1988, p. 145) from probabilistic MDS-analyses that equally well fit for exponential decay with  $c = r = 1$  and for Gaussian decay with  $c = r = 2$ , where  $c$  applies to similarity magnitude  $v_{ij} = \exp[-(d_{ij}^c)]$  and  $r$  to the underlying Minkowski metric of  $d_{ij}$ , and similarly so for MDS-choice models with multiplicative bias as well as for probabilistic Euclidean MDS-analysis with  $c = 1$  and  $r = 2$ , could indicate that the sensation space is flat and that the decay function depends not on the geometry of the flat sensation space. Other results of Nosofsky (1992a, p.161-163; 1992b, p. 373, 391) from MDS-choice models with multiplicative bias for

categorisation or confusion probabilities show that the exponential decay function for distances with  $(c::: r::: 1)$ ,  $(c::: 1, r::: 2)$ ,  $(c::: 2, r::: 1)$  or  $(c::: r::: 2)$  generally fit categorisation and confusion probabilities quite well for  $c::: 1$  in flat sensation spaces with  $r::: 1$  or  $r::: 2$ , while confusion probabilities of highly confounded stimuli fit better analyses with  $c::: r::: 2$ . It indicates that the Gaussian decay function may apply to confounded or fuzzy stimuli with Euclidean sensation distances. Open-hyperbolic or single-elliptic response spaces must be scaled to a (pseudo) radius of unity before response space distances define respectively the similarity probabilities  $P_{ij}::: |i-j|^{-1}$  or  $p_{ij}::: 1 - |r_{ij}|/(1/2\pi)$ , whereby the derivable flat sensation space can only be Euclidean. Thus, the theoretically appropriate values are  $c=1$  and  $r=2$ , but in line with Shepard (1988) and Nosofsky (1992b) we conjecture that  $c=2$  may apply if stimulus recognition is masked by physical noise, which conjecture is sustained by two kinds of theoretical research.

Firstly, Ennis (1988, 1992) generated data by an exponential decay function for Euclidean distances ( $c=1$  and  $r=2$ ) between sensations of artificial stimuli with so-called momentary fluctuations from a normal distribution for their dimensional sensations (logarithmically transformed stimulus dimensions). These artificial data fit the Gaussian decay function with  $c=2$  better than for exponential decay  $c=1$ , although generated by  $c=1$  and sensation distributions as noise around the central Euclidean loci of the sensations. Notice that the momentary fluctuations are here simulations of physical noise that cause stochastically fluctuating sensation distances, which differs from our deterministic distance fluctuations by stimulus-dependent shifts of adaptation level. Secondly, Staddon and Ried (1990) show that the recurrent diffusion-process time for errorless input signals in neural networks determines the shape of the decay function. The shape of the decay function changes with the diffusion-process time from an exponential to a Gaussian decay function, while for almost infinitely prolonged diffusion the decay function becomes almost linear. Moderately long recurrent diffusion process time for input signals in neural networks may simulate the cognitive recognition effort of internally repeated sensations of faint or fuzzy stimuli. Taking these theoretical studies and the evidence for  $c=2$  in empirical studies on confusion of fuzzy stimuli, it may be that generalisation as function of sensation distances is intrinsically determined by the exponential decay function, thus for  $c=1$  as it theoretically should be, while perceptual noise or fuzzy stimuli can induce Gaussian-like decay functions. Therefore, the analysis of similarities between clearly distinguishable stimuli or well-known cognitive objects generally will be characterised by an exponential decay function.

Clearly (i-to-j)- and (j-to-i)-similarities are asymmetric in all our biased choice models, while triple similarity comparisons also can easily become intransitive, unless triple similarities with the same reference stimulus are compared. It predicts the same asymmetry and intransitivity as predicted by Tversky's (1977) feature-contrast model, but here asymmetric similarities for  $(i|j)$  and  $(j|i)$  are induced by the stimulus- and task-dependent evaluation. Suppose (i-to-j)-similarity induces a complete shift of the adaptation level towards the reference sensation of  $j$ , while  $y^k / y^k = 1$  for  $m-1$  dimensions and  $y_{im} / y_{im} = 2$  for one dimension, then distances  $d_{ij} = 2 |y_{im} / y_{im} - 1| = 1$  and  $d_{ji} = 2 |y_{jm} / y_{jm} - 1| = 2$ , where  $i$  is more similar to  $j$  than  $j$  to  $i$ . Applying such to

North Korea and China by assuming that North Korea and China are identical in all attributes except one, whereon North Korea has a higher attribute value than China, then also the complete shift of the adaptation level implies a lower similarity of North Korea to China than of China to Korea. We prefer this more general explanation of asymmetric similarity from adaptation-level shifts above the explanation by the feature-contrast model of Tversky (1977).

Evaluations of presented stimulus or object pairs (i,j) for being similar or belonging to same category may be influenced by individual adaptation-level shifts towards the midpoint of sensations for i and j, while the individual average adaptation points will be equal to the average sensation for sensory stimuli or objects. The expression for intensity-comparable sensations i and j under shifting individual adaptation levels toward midpoint sensations are defined by

$$\begin{aligned} \text{and} \quad s_{Iij} &= 2\{y_i / [(1 - w_J)a_J + V2W_J(Y_i + y_j)] - I\} \\ \text{whereby} \quad s_{Jij} &= 2\{y_j / [(1 - w_J)a_J + V2W_J(Y_i + y_j)] - I\}, \\ d_{Iij}/a_{Iij} &= [2|y_i - y_j|/a] / a_{Iij} \quad \text{with} \quad a_{Iij} = a_J[(1 - w_J) + V2W_J(Y_i + y_j)]/a_J \end{aligned}$$

For  $w_J = 1$  we may simplify by  $a_J = a$  and  $a_{Iij} = Y2(Y_i + y_j)/a$  the expressions to

$$\begin{aligned} \text{and} \quad s_{Iij} &= 2[y_i - V2(y_i + y_j)] / [Y2(y_i + y_j)] = (y_i - y_j) / a_{Iij} \\ \text{whereby} \quad s_{Jij} &= 2[y_j - V2(y_i + y_j)] / [Y2(y_i + y_j)] = (y_j - y_i) / a_{Iij} \\ \text{and} \quad s_{Iij} &= -s_{Jij} \\ d_{Iij}/a_{Iij} &= |s_{Iij} - s_{Jij}| = [2|y_i - y_j|/a] / a_{Iij} \end{aligned} \quad \left| \begin{array}{l} a_{Iij} = 1/2(y_i + y_j)/a \end{array} \right.$$

For open-hyperbolic response space distance we then obtain

$$r_{Iij} = -r_{Jij} = \tanh(V2s_{Iij}) = \tanh[Y2(y_i - y_j)/a] / a_{Iij}$$

where response distances for Euclidean sensation distances  $d_{Iij} = 2|y_i - y_j|/a$  are written as

$$|r_{Iij} - r_{Jij}| = 2 \tanh[V2\{ |y_i - y_j|/a \} / a_{Iij}] = 2 \tanh(1/4 d_{Iij} / a_{Iij}) \leq 2$$

and the confusion probability as

$$p_{Iij}(ij, w=1) = [2 - 2|r_{Iij} - r_{Jij}|] / 2 = 2 / (1 + \exp(V2d_{Iij}/a_{Iij})), \quad a_{Iij} = 1/2(y_i + y_j)/a$$

which for  $\exp(Vzd_{Iij}/a_{Iij})$  as a Euclidean co-ordinate of hyperbolic sensation distances also holds for open-Euclidean response distances

$$\text{Defining} \quad |r_{Iij} - r_{Jij}| = |r_{Iij} - r_{Jij}| = |\tanh(-Y2s_{Iij}) - \tanh(-V2S_{Jij})| = 2 \tanh(1/4 d_{Iij} / a_{Iij}).$$

$$\text{and} \quad d_{Iij} = 2|y_i - y_j|/a, \quad v_{Iij} = \exp(-d_{Iij}), \quad a_{Iij} = V2(y_i + y_j)/a$$

$$\text{we have by} \quad \tau_{Iij} = 1/2 a_{Iij} = a / (y_i + y_j),$$

$$v_{Iij} = \exp[-1/2 d_{Iij} / a_{Iij}]$$



a biased confusion probability for Euclidean or hyperbolic sensation spaces as

$$p_{ij} = 2 / [1 + \exp\{\sqrt{2} d_{ij} / a_{ij}\}] \approx 2 / [1 + (\tau_{ij} / v_{ij})] \quad \tau_{ij} = \exp(-d_{ij}) \quad v_{ij} = a / (y_i + y_j)$$

Similarly we have  $C_{ij} = -L_{ij} \approx \arctan\{(y_i - y_j) / a_{ij}\}$  for single-elliptic response spaces with response distances  $r_{ij} = 2 \cdot r_{ij}$ , whereby

with  $p_{ij} = [2 - 2 \cdot r_{ij} / (\sqrt{2} \pi)] / 2 \approx 1 - \arctan(\sqrt{2} d_{ij} / a_{ij}) / (\sqrt{2} \pi)$

and  $d_{ij} / a_{ij} \approx 2 \cdot \tan[\text{Ym}(1 - p_{ij})]$

or  $p_{ij} = \cos^2(1 - p_{ij}) \approx 1 / [1 + (\sqrt{2} d_{ij} / a_{ij})^2]$

$p_{ij} = 1 / [1 + 1 / (\beta_{ij} \cdot v_{ij})]$   $v_{ij} = \text{lid}_{ij} \cdot \sqrt{\beta_{ij}} = a / (y_i + y_j)$

Its confusion probabilities are symmetric, but evidently can be intransitive and define a new type of biased confusion or categorisation probability. A conditional similarity probability  $p_{ij}$  under shifts to midpoint sensations can't be formulated, since response space distances  $r_{ij}$  and  $r_{ji}$  have no same space origin as midpoint.

Euclidean sensation spaces and similarity magnitude  $v_{ij} = \exp(-d_{ij})$  under adaptation-level shifts to midpoint sensations define again for confusion probabilities an exponentially multiplicative model that by its power-raised dual bias  $\tau_{ij} = a / (y_i + y_j)$  for  $v_{ij}$ , will be called the **exponentially multiplicative similarity model with power-raised dual-bias**. It predicts stimulus-dependent intransitivity, but no asymmetry of (dis)similarities. For hyperbolic sensation space with its addition of squared Euclidean co-ordinate terms  $\exp(d_{ij}^2 / a_{ij})$  to squared term  $\exp(d_{ij})$  of hyperbolic distance  $\sqrt{2} d_{ij} / a_{ij}$ , it becomes an **exponentially additive similarity model with power-raised dual-bias**. For Euclidean sensations of single-elliptic response space we have an **additive similarity model with multiplicative dual-bias** for derived confusion probabilities by its addition of squared, dimensional distances to Euclidean sensation space distances  $d_{ij}$ , and for the actually observable confusion probabilities an **arctangent-based similarity model with multiplicative dual-bias**. For the alternatively defined, open-hyperbolic response space with  $L_{ij} = 2 \cdot \tanh[\frac{1}{2} \ln\{\cosh(\sqrt{2} d_{ij} / a_{ij})\}] \leq 2$  and confusion probability  $p_{ij} = [2 - L_{ij}] / 2 = 1 / [1 + 1 / (\beta_{ij} \cdot v_{ij})]$  for  $v_{ij} = 1 / \cosh(\sqrt{2} d_{ij} / a_{ij})$  with dual-bias  $\beta_{ij} = \cosh(\sqrt{2} d_{ij} / a_{ij}) / \cosh(\sqrt{2} d_{ij} / a_{ij})$  we have again a **hyperbolically multiplicative similarity model with multiplicative compound dual-bias**, where the dual bias here depends on the sensation distance and its midpoint. The solutions for these models may be iteratively obtained from repeated solutions of a metric MDS-analysis of Euclidean distances  $d_{ij}$ , or a principal component analysis of hyperbolic distances  $\cosh(d_{ij})$  as defined by the respective transformations of observed, symmetric confusion probabilities under initial values  $a_{ij} \approx 2$ . Iteratively improved values  $a_{ij} \approx \frac{1}{2}(y_i + y_j) / a$  for the successively solved space values of  $y_i$  and  $y_j$  under similar central dilatations and translations of the solved sensation space, as described earlier in the mathematical section above for adaptation-level shifts to target sensations. Thereby, improved space solutions are obtained from improved estimates of space distances  $d_{ij}$  or  $\cosh(\sqrt{2} d_{ij} / a_{ij})$  for improved values  $a_{ij}$  and the transformed similarity probabilities, which by repeated improvements gives convergence of estimated  $a_{ij}$  values and the common sensation

space solution. We conjecture that the appropriately transformed similarity probabilities to weighted sensation space distances for the respective similarity models with multiplicative or power-raised (dual-)bias will fit better than existing MDS-based similarity probability models and obviously also better than the methods described in chapter 4, where we assumed no stimulus-dependent adaptation-level shifts.

The conditions for the validity of the analyses of individual (dis)similarity order data by the methods of chapter 4 in this monograph are:

- a homogeneous and known set of perceptual stimuli or cognitive objects,
- randomly selected and simultaneously presented stimulus or object pairs,
- limited, equal exposure time of stimulus or object pairs.

Under these conditions adaptation levels hardly shift and likely are individually identical for perceptual stimulus sets, while for cognitive objects they likely are different and stable. These conditions exclude similarity evaluations of well-discriminated stimuli from nonhomogeneous stimulus or object sets and similarity evaluations of presented stimuli or objects with respect to memorised or repeatedly presented target stimuli or objects, as used in many dissimilarity studies. Stimulus-dependent shifts of dimensional adaptation levels are most generally defined by

$$a_{Jijk} = [(1-w_J)a_{JK} + p \cdot w_J \cdot y_{jk} + (1-p)w_J \cdot y_{ik}] / a_{JK}, \quad 0 \leq w_J \leq 1 \text{ and } 0 \leq p \leq 1$$

It not only describes a task-induced, partial stimulus dependence for asymmetry of the (i to j)- or (j to i)-similarities by shift factor  $0 \leq w_J \leq 1$ , but describes by  $0 \leq p \leq 1$  also the effects of shifts that are caused by different frequency proportions or different durations of stimulus presentations for i and j, where p expresses the proportional presentation unbalance. For  $p < 1/2$  the shift is relatively more towards i than j and for  $p > 1/2$  relatively more to j than i, where presentation unbalance causes similarity asymmetry and intransitivity. However, no theoretically valid similarity probability model is derived from our response theory, if  $w_J = 1$  and  $p = 1$  or  $p = 0$  or  $p = 1/2$  is not satisfied. Only for  $p = 1$  or  $p = 0$  and  $w_J = 1$  it reduces to the described similarity models with stimulus-dependent bias that causes asymmetric and intransitive similarities. For values  $p = 1/2$  and  $w_J = 1$  it describes shifts to midpoints of i and j and then reduces to the described similarity probability models with dual stimulus-dependent bias that may cause symmetric similarities to be intransitively ordered.

#### 7.2.5. Deterministically *relative* versus stochastic dissimilarity analyses

Our psychophysical response theory assumes a common object space with deterministic object locations and predicts that similarities can become asymmetric and/or intransitive by deterministic, task- and stimulus-dependent shifts of adaptation levels. Asymmetry and intransitivity apply to (i-to-j)-similarities that are evaluated with respect to repeatedly presented target stimuli or objects or with respect to memorised stimulus or object categories, while similarity evaluations between stimuli or objects only can show a possible intransitivity of symmetric similarities. If such shifts of adaptation levels are present then the dissimilarity analysis methods in chapter 4 are inappropriate. Above we proposed iterative solution procedure for the analysis of intransitive similarity probabilities from shifts of adaptation levels to sensation midpoints or target sensations of stimulus pairs, but a similar analysis method may be used for the analysis of partially

intransitive dissimilarity rank orders that are influenced by similar adaptation-level shifts. Using that solution procedure for ordered dissimilarity values that are scaled to initial probability values between just above zero and just below unity for respectively the largest and smallest dissimilarity, we can iteratively solve the sensation space from such initially scaled similarities as probabilities and then obtain predicted similarity probabilities as function of solved, weighted sensation space distances. Better scaled similarity probabilities are obtained by minimally changed values of predicted probabilities that fit the partially intransitive order of observed dissimilarities. By repeated solutions for more optimally scaled similarity probabilities the solution converges to an optimal probability scaling and common sensation space representation that also determines the stimulus-dependent weights of sensations, whereby intransitive dissimilarities are analysed. If adaptation-level shifts to stimulus subsets are partial (thus, also dependent on individual adaptation levels) then a theoretically valid similarity probability model can also not be derived from our psychophysical response theory. Nonetheless, it might be possible to find solutions from rank orders of dissimilarities between simultaneously presented object pairs  $(i,j)$  and  $(f,g)$  with partial adaptation-level shifts towards the sensation centroids of object subsets  $(i,j|J,g)$ , where their dimensional sensations are defined (subsection 7.1.5.) by

$$s_{ikljfg} = 2 \{ Y_{ik} / [(1-w_J) a_{Jk} + w_J \cdot (y_{ik} + y_{jk} + Y_{fk} + Y_{gk})] - 1 \}.$$

Solutions for the analysis of intransitive dissimilarities with such adaptation level shifts might be obtained from by starting with the solution procedure of chapter 4 that solves the dimensional  $a_{Jk}$  and  $y_{ik}$  values for  $w_J = 0$ , as initial solution and subsequently by using the iterative scaling of intransitive similarity rank orders to similarity probabilities and their repeated solution by the above described procedure, but then for individual weights  $1 < w_J < 1$  that also have to be solved iteratively. Whether such an iterative procedure or another programming method can efficiently achieve solutions has to be researched, but would exceed our theory-oriented scope.

In our psychophysical response theory intransitive (dis)similarities are predicted by adaptation-level shifts and analysed by transformations of response distances that become intransitive by deterministically changing response spaces. Many data inconsistencies are not due to stochastic behaviour, but caused by insufficiencies of analysis methods that do *not* take into account:

- a) stimulus-dependent or task-induced adaptation-level shifts to between presented object pairs and the configuration centroid or task-dependent reference levels;
- b) the difference between the geometry of open individual response spaces and the common sensation or stimulus space.

These model insufficiencies lead to inconsistent data if the model is taken as more real than the data and then are often seen as stochastic phenomena. But insufficiencies of a model can't be cured by stochastic versions. Stochastic models are not always inappropriate, but deterministic models are more useful for theory development.

Firstly, stochastic models can be appropriate for similarity evaluations of noisy stimulus presentations or faintly presented objects, as indicated by the discussed simulation studies that showed Gaussian decay for noisy stimuli, but are doubtful for similarity evaluations of clearly perceivable stimuli or well-known objects.

Secondly, probabilistic scanning samples of sensory objects and probabilistic micro-processes of brain signals need not to determine stochastic responses, because responses are integrated outputs of multiple signal micro-processes, which generally yield almost deterministic output results in the same way as stochastic Brownian collisions of gas molecules against volume walls yield deterministic pressures.

Thirdly, probabilistic or rather stochastic MDS-analyses of similarity data (Ashby, 1992) define similarity by a multidimensional distribution overlap of sensation or stimulus pairs. However, this similarity definition is questionable for similarities between well-perceived stimuli and certainly is a strange definition for similarity evaluations that exhibit no uncertainty for individuals. Probabilistic MDS-analyses of similarities derive from the generalised recognition theory (Ashby and Perrin, 1988) that is based on a generalisation of signal detection theory (Tanner and Swets, 1954, Swets, 1961). Already in 1960 it is stated that signal detection theory is not a psychological theory, because it would require ideal human observers that don't exist as Tanner himself (Tanner et al., 1960, pp. 19-20) remarked:

*"Thus if the human observer were to perform as an ideal observer the following would be necessary: 1) he would have no source of internal noise. That is, the input signal would have to be transformed to a different type of energy by the end organ and transmitted by the nervous system, all with perfect fidelity. 2) He would have perfect memory for the signal parameters and the noise parameters. 3) He would be capable of calculating the likelihood ratio or some monotonic transformation of likelihood ratio.... Clearly, the human observer does not meet these specifications".*

Therefore, distribution overlap implies likewise a questionable similarity definition. Models for dissimilarities as deterministic space distances, however, need to specify the response geometry and have to take into account the dynamic relativity of comparable sensations in order to describe what otherwise would be stochastic noise.

### 7.3. Cognition research and dynamic similarity relativity

#### 7.3.1. Individual similarity relativity and cognitive similarity analysis

Individually different and stable adaptation points determine individually different and static response space configurations of the same stimuli. Stable individually adaptation levels and thus static individually different response spaces may exist in studies on evaluations between cognitive objects, provided that the cognitive objects are randomly selected from a fixed homogeneous set of cognitive objects and are not associated with the physical objects, which may hold for neutrally presented words of pure cognitive entities. Under these conditions the adaptation levels generally are stable, but individually different, because selected from their memories for similar object contexts. The probabilistic Eudidean MDS-analysis (Zinnes and MacKay, 1992) may seem an acceptable method for the analysis of aggregated dissimilarities from an object space with fixed object locations and a multidimensional, normal distribution of individually differing, stable adaptation points, because distributions of object vectors from a common origin then derive from the distribution of individual origins. However, according to our theory the solved Euclidean space then only can be the average of the open-Euclidean response spaces of individuals. The individual different response

spaces cause a distribution of objects in an averaged response space, wherein object vectors then differently vary in direction and length, dependent on their fixed object distance to individual adaptation points in the sensation space. Suppose we have a two-dimensional (hyperbolic) sensation space with fixed object sensation points and a bivariate nonnal distribution (circular by equal dimensional variances) of individual adaptation points. If the average adaptation point is taken as the fixed common space origin of the object vectors in that sensation space then we have identical circular-nonnal distributions of the object locations, because the object distributions of the actually fixed object locations are equal to the distribution of the individual adaptation points. The objects close to the average adaptation point remain to show such almost circular distributions in the open-Euclidean response space that is assumed to be common to the individuals, because the vector lengths of objects that are located closely to the individual adaptation points are hardly changed by the transfonnation from sensation to response spaces, while all object vector directions remain unchanged by that transfonnation. However, due to the transfonnation from infinite sensations to finite responses, the distribution of the response vector lengths will be the more narrowed the more remote the central object location is from the origin, while the distribution on the perpendicular axis is hardly narrowed. because distributed as the adaptation points. Thus, remote objects will show almost elliptic distributions with a smaller variance for their central vector length axis than for their perpendicular axis. Figure 38a below shows a simulated example of such differently shaped object distributions from an improper probabilistic MDS-analysis of aggregated individual dissimilarities in an open-Euclidean response space for detenninistically located objects and a nonnal bivariate distribution of individual adaptation points.

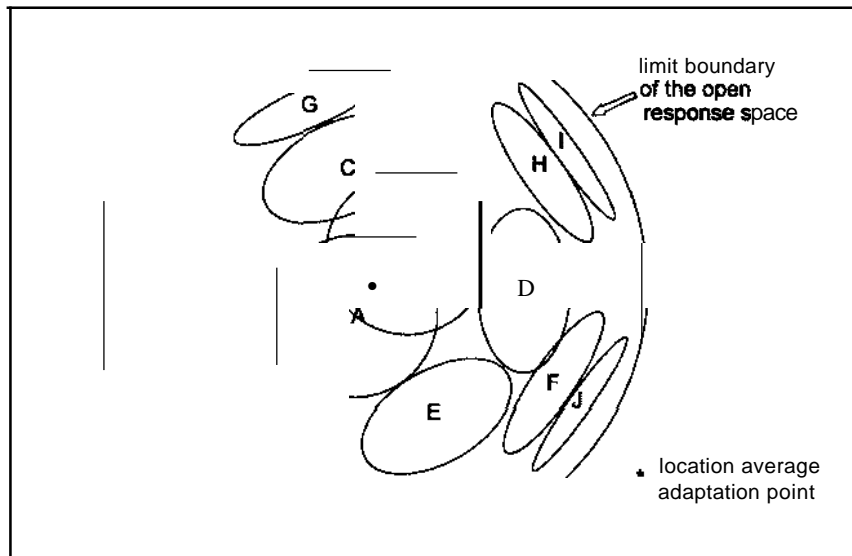

Figure 38a. Expected object distributions from a stochastic MDS-analysis for fixed objects and nonnal distributed adaptation points

Next figure 38b is a copy of an empirical example that shows such circular and elliptic object distributions from a probabilistic Euclidean MDS-analysis of aggregated individual dissimilarities of 52 students for eight toothpaste brands (MacKay and Droge, 1990). The authors interpret the dimensions of figure 38b as breath-freshening and decay-prevention dimensions of toothpaste brands. Their explanation for the differently shaped object distributions is that well-known toothpaste brands will have elliptic distributions with the smaller variance for their characterising dimension and circular distributions for unknown brands.

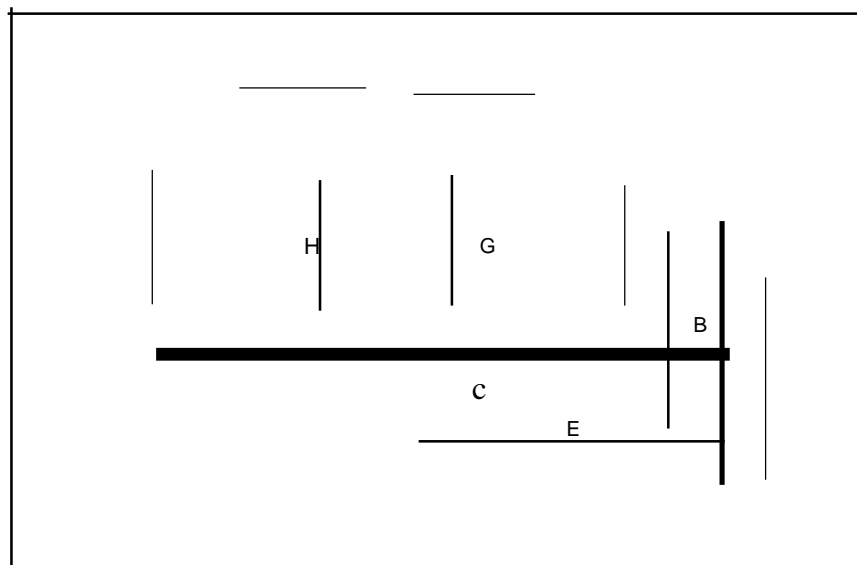

Figure 38b. Varying object distributions from a stochastic Euclidean MDS-analysis of dissimilarities between toothpaste brands

The characterising dimensions for the axes of the elliptic distributions with the smaller variance are the breath-freshening dimension for brands E = Aim and C = Aqua-fresh and the decay-prevention dimension for brands A = Crest and B = Colgate as well as for also clamour-appealing brands F = Ultrabrite and D = Close-Up, while smoker toothpastes G = Pepsodent and H = Pearl drops are unknown to students and, therefore, will have large circular and centrally located distributions. This explanation by the authors seems unwarranted, because why are all well-known brands not characterised by distributions with small variances on both dimensions? Our explanation is that such results are expected from an analysis of dissimilarities by a probabilistic MDS-analysis in a common Euclidean space, if the object configuration is deterministic and individuals have a multivariate normal distribution of adaptation points. If individuals have such a distribution of fixed adaptation points then they transform a deterministic object configuration in a hyperbolic sensation space to individually different object configurations in their open-Euclidean response spaces. These different configurations become then represented by object distributions in a common Euclidean space, while the object distributions are the more elliptic the more extreme their central object

locations are, due to the open-Euclidean response spaces. Since memories of neutral-tasting toothpastes define the individually different adaptation points, the neutral-tasting smoker's toothpastes (G = Pepsodent and H = Pearl drops) will be located close to the average adaptation point and also must be circularly distributed in the probabilistic MDS-analysis, while not neutral-tasting brands (decay-prevention brands A = Crest and B = Colgate and breath-freshening brands E = Aim and C = Aqua-fresh) must have elliptic distributions with the smaller variance on their characterising axis. The confirmation of these predictions for six out of eight toothpastes can be seen as evidence for our psychophysical response theory. The other brands (F = Ultrabrite and D = Close-Up) with more centrally located, elliptic distributions probably have eccentric locations on an unrevealed clamour-appeal dimension.

### 7.3.2. Methodological artifacts in cognitive similarity research

The presented example illustrates some of the methodological aspects and interpretation artifacts of MDS-analyses that analyse open individual response spaces as a flat infinite sensation space. Here we further discuss these methodological issues.

Firstly, MDS-analysis of aggregated, individual (dis)similarities for cognitive objects generally solve distorted distances between objects in the MDS-space, which will be caused by actually different responses spaces for a common configuration of fixed objects in the sensation space with individually different adaptation points. As discussed in chapter 4. we have to analyse individual dissimilarity data for cognitive objects and not the aggregated dissimilarity data of individuals in order to avoid artifacts and misinterpretations. This is again illustrated by the following simple, but realistic example. Suppose that we have dissimilarity data on political parties of individuals that generally have stable adaptation points coinciding with the respective location of their own political party, because their adaptation levels will shift to the location to their own party by the dominating high exposure frequency to their own party. Suppose further that we have 7 parties that are equally spaced on a single left-right sensation dimension that is flat or hyperbolic curved and that the more extreme right and left parties are the smaller parties. We picture this by a straight line for equally spaced party points A to G with symmetrically decreasing numbers of individual adaptation points on these locations, as shown here below.



The response transformation of individuals with adaptation point A defines A-B as the largest (non-Euclidean or Euclidean) response distance between adjacent parties with successively smaller response distances for B-C to F-G, while the reverse holds for individuals with adaptation point G. For individuals with adaptation points at B the response distances for adjacent parties are equal and largest for A-B and B-C and successively smaller for C-D to F-G, while by its reverse the response distance F-G and E-F are the largest and equal for individuals at F that have decreasingly smaller response distances for D-E to A-B. For individuals at C response distances between adjacent parties are equal and largest for C-D and B-C, since their response distances A-B and E-F are smaller and equal, while response distance F-G is their smallest response distance. The corresponding reverse holds for individuals at E. For the

individuals at D the response distances for adjacent parties are the largest and equal for D-E and C-D, since their response distances B-C and E-F are smaller and equal, while distance A-B and F-G are their smallest and equal distances. More individual adaptation points are located at D than on C or E and more at C or E than at B or F, while the least number of individual adaptation points are located at A or G. Therefore, the average response distances of the individuals for adjacent parties show the largest response distances C-D and D-E, smaller response distances B-C and E-F, and the smallest response distances A-B and F-G. Moreover, taking also the individual response distances between other pairs into account, we also see that average response distances between adjacent parties pairs are relatively less reduced than the average response distances between non-adjacent party pairs. Therefore, the usual Euclidean MDS-analysis of their aggregated dissimilarity data yields a two-dimensional solution with a horseshoe configuration of the party locations. While the actual individual response spaces are differently spaced unidimensional configurations with the same left-right rank order as on the sensation dimension. Such horseshoe configurations of political parties are empirically found by a Euclidean MDS-analysis of aggregated dissimilarity data for Dutch political parties in the late sixties of the 20<sup>th</sup> century (Daalder and Rusk, 1972.). The interpretation of Daalder and Rusk is a left-right dimension and a constructive versus nonconstructive party dimension, where the latter dimension describes the dimensional contrast between the major, mid horseshoe parties that participated in the Dutch coalition governments after World War II, while the minor parties at both extremes of the horseshoe configuration were opposition parties. An alternative elliptic MDS-analysis of these data by Van de Geer and de Man (1974) shows that this interpretation may be an artifact of the Euclidean MDS-solution, because they represent the horseshoe configuration by one well-fitting, elliptic space dimension. However, also the latter analysis is problematic. Firstly, because according to our psychophysical response theory there exists no common response or sensation space that is elliptic. Secondly, because the aggregation of individual dissimilarity data can be the cause for the artifact of the horseshoe configuration. No analysis of aggregated dissimilarities of individuals with different adaptation levels can satisfactorily fit a Euclidean or non-Euclidean space representation, due to the fact that averages of hyperbolic or arctangent transformations of individual sensations with different origins yield no response distances with a zero or constant curvature. Nonetheless, the unidimensional interpretation probably is still correct, because analysis of individual dissimilarities for Dutch political parties by the analyses for open response spaces that are described in chapter 4, probably would reveal only one left-right dimension, as it would for the constructed example. Hereby, we again demonstrate that individual dissimilarities must be analysed and not their aggregated dissimilarities.

Secondly, probabilistic MDS-analysis of similarities between cognitive objects can't cure the wrong assumption of a common response space and even may lead to interpretations of resulting distributions that are methodological artifacts of the distribution of individual adaptation points. Probabilistic MDS-analyses can show object distribution for objects that actually are not distributed, but have fixed common object locations that are differently evaluated by individuals with different adaptation points. The geometrically appropriate analysis of individual response spaces (described



in chapter 4 and modified for shifting adaptation levels in section 7.2) may reveal that these response spaces are individually deterministic transformations of an almost perfect fitting common space of fixed object positions and individual adaptation points with different locations. Referring to paragraph 7.2, asymmetric and intransitive or only intransitive dissimilarity evaluations of an individual can derive from deterministically stimulus-dependent modifications of weighted distances between the intensity-comparable sensations of presented stimuli or physical objects. This also can partially apply to cognitive objects, whereby also fluctuations of distances can be explained without assuming object distributions for cognitive objects, although ambiguity of cognitive objects may exist. Ambiguity of cognitive objects could be modelled by stochastic MDS-analysis for (dis)similarity of cognitive objects with distributions and one also could take into account a possible distribution of a wandering individual adaptation point, comparable to stochastic models for preference analysis with wandering ideal points (De Soete, Carroll and DeSarbo, 1986, 1989). We only have developed deterministic analysis methods for common Euclidean sensation or stimulus spaces from individual response spaces (chapter 4) or similarity probabilities (section 7.2) and from individual preference spaces (chapter 5), but their stochastic versions could be developed. We then also have to define the geometry of the space wherein the cognitive objects would have multidimensional, nonnal or other infinite distributions. This space can't be the open response space, because infinite distributions require an infinite space. It also will generally not be the stimulus space, because cognitive objects are not physical entities and if there are corresponding objects in the physical space then they generally are well determined. It may be the sensation space, wherein fuzzy cognitive objects could have an uncertain location that may be characterised by multivariate nonnal distribution of its location sensations. Signal process theories (Link, 1992a; Marley, 1992) lead to multidimensional Poisson or exponential distributions, instead of multidimensional nonnal distributions. These signal process theories then imply some log-linear analysis model for sensation space distributions, which is compatible with (revised) biased choice models (Marley, 1992). Although such appropriate models for a stochastic multidimensional analysis of open response spaces for individual (dis)similarities of imperfectly known cognitive objects could be developed, we earlier formulated our doubts on the psychological validity of the similarity concept that measures similarity by multidimensional overlap of stimulus distributions. These doubts hold as much for stimuli as for cognitive objects, because the general recognition and similarity theory (Ashby and Perrin, 1988) requires that individuals are evaluating similarities by overlapping multivariate distributions of the evaluated objects, where the multidimensional distribution parameters of cognitive objects must be cognitively processed for an accurate estimation of the distribution overlap by the individual. However, as discussed in section 7.2.5. with respect to signal detection theory and similarity evaluations, individuals have no accurate knowledge of cognitive object distributions. Nonetheless, it could be assumed that overlap of signal distributions in brain processes generate such similarity measures without any conscious knowledge of distribution parameters, but if so then it would likely specify common and not locally different distributions, whereby then also no asymmetry and/or intransitivity of similarities could be explained.

We rather are inclined to model differences between imperfectly known and well-known cognitive objects by a dimension for ambiguity differences between objects. Such an ambiguity dimension is used in the ambiguity and uncertainty theory of probabilistic inferences (Einhorn and Hogarth, 1985). Uncertainty is an attribute that corresponds to probability aspects of evaluated entities, such as gamble outcomes, while ambiguity is an attribute that corresponds to imperfect perception or knowledge of entities. For example, the colour mixture of draws from an urn with unknown shares of red and white balls has maximal ambiguity and maximal uncertainty. Its uncertainty is the same as for draws from an urn with known shares of 50% red and 50% white balls, but the colour mixture of such draws has no ambiguity. In our deterministic dissimilarity analysis an object pair with some ambiguity difference is judged more dissimilar than an object pair with same object differences on all dimensions, except on the ambiguity dimension. Asymmetry of similarity for pairs of cognitive objects may occur, if the similarity task requires to a similarity evaluation of object  $i$  to object  $j$ , because the asymmetry of the task instruction induces shifts of adaptation levels towards object  $j$  in (i-to-j)-similarity evaluation, as described before in our model for task-induced, stimulus-dependent asymmetry of similarities (instead of selective attention to attributes, as described before in our metric reformulation of Tversky's feature-contrast model). The earlier mentioned asymmetric similarity that North Korea is more similar to China than China to North Korea for most American subjects (Tversky and Gati, 1978), becomes explained by the 'onto'-similarity judgment and the plausibility that most Americans know more about China than North-Korea, whereby they may judge the ambiguity for China lower than for North Korea (dimensional Fechner sensation  $y_{ck} < y_{nk}$ ) and their other country attributes as rather similar. If so then it implies that China's similarity to North-Korea yields a lower similarity than North-Korea's similarity to China, because a shift of adaptation level to North Korea in the similarity of China to North-Korea specifies comparable ambiguity sensation distance  $2: y_{ck}/y_{nk} - 1$  and an adaptation-level shift to China in the similarity of North-Korea to China a comparable ambiguity sensation distance  $2[y_{nk}/y_{ck} - 1]$ . A lower ambiguity of China than North Korea causes a larger dissimilarity of North Korea to China than of China to North Korea, since if  $0 < y_{ck} < y_{nk}$  then  $y_{nk}/y_{ck} > y_{ck}/y_{nk}$ . Once more this illustrates our unifying reformulation of Tversky's feature-contrast model, as earlier discussed in section 7.1.4. Therefore, it may be unnecessary and likely is unjustified to represent asymmetric and/or intransitive similarities by the Tversky's feature-contrast model or by differing overlap proportions of differently shaped distributions of objects in a common object space. Nonetheless, many researchers (see Ashby, 1992a) use probabilistic MDS-analysis to describe asymmetric and/or intransitive dissimilarities and, thus, adhere to the general recognition theory of similarity judgment (Ashby and Perrin 1988).

Thirdly, dimensional adaptation levels for a set of cognitive objects primarily are individually selected reference levels from the memory of previous object sets with similar cognitive attributes, where the memorised dimensional adaptation levels become slightly or hardly updated during the completion of the similarity evaluation task of the newly presented objects. Therefore, the dimensional adaptation levels are hardly shifted during the similarity evaluation of randomly presented object pairs from a

homogeneous set of cognitive objects, provided that the individual is informed about the full object set. Nonhomogeneous sets of cognitive objects can be characterized by subsets of objects with dimensionally different subspaces and then the adaptation level can suddenly shift to different memorised adaptation levels for each object subset. However, the adaptation levels for a cognitive object set or for dimensionally different subsets of cognitive objects are memorised reference levels that can be individually different. Consequently, the individual weights for intensity-comparable sensation dimensions can be inter-individually and intra-individually different for object selections from a nonhomogeneous set of cognitive objects. As discussed in section 7.1.4 for nonhomogeneous object sets, the relevance of dimensions for similarity evaluation of object pairs, and especially for similarity evaluations of objects pairs in subspaces with another dimensionality than the total set of cognitive objects, can become different for each object pair either by object-dependent shifts of the individual adaptation levels or by sudden selections of other stored adaptation levels for similar subsets in the memory of individuals. 'Between'-similarity evaluations for cognitive object pairs from a set or subsets of cognitive objects give symmetric similarities, because its adaptation levels  $a_{jk}$  are memorised levels or selectively shift toward subset-relevant levels  $a_{jk}[(i \in S_h) \wedge (j \in S_g)] = \frac{1}{2}[a_{jk}^h + a_{jk}^g]$  for object subsets  $S_h$  and  $S_g$ . If the dimensionality  $S_h \cup S_g$  is different for different cognitive object subsets, or if either  $a_{jk}^h = 0$  or  $a_{jk}^g = 0$  as unnoticeable dimensional sensation levels, then the 'between'-similarity remains symmetric, but for objects from different subsets the similarities can become intransitive by their selectively shifted adaptation levels. If symmetry is satisfied and intransitivity is consistently present then one has to analyse distances in the common object space under corrections for biases that depend on the object pairs and eventually the individual.

If cognitive objects are evaluated for their (i-to-j)-similarity with respect to other cognitive objects or categories also asymmetric and intransitive similarities can consistently exist. In that design of (i-to-j)-similarity evaluations the analysis must use corrections for biases that depend on the cognitive reference object. Asymmetry of cognitive object similarity is a task-dependent asymmetry from similarity evaluations of objects  $i$  to target object  $j$ , as repeatedly discussed for the asymmetry of the higher dissimilarity for North Korea to China than for China to North Korea. Such a similarity asymmetry is also implied in categorisation tasks, where categorisation of objects or stimuli  $i$  as belonging to category  $j$  is modelled by a similarity measure between object or stimulus  $i$  and respective categories  $j$  (Nosofsky, 1992b). Similarity asymmetry as represented by differently weighted sensation distances between objects and categories is caused by momentary adaptation-level shifts, because the intensity-comparable sensation distance of objects  $i$  to target category  $j$  becomes weighted by twice the inverse value of the adaptation level that is shifting towards the centroid sensation of the presented objects that belong to the respective categories (for prototype-based categorisation model) or to the exemplar sensation of the respectively memorised categories (for exemplar-based categorisation model). It then defines by our psychophysical theory a category-dependent bias, either as power exponent or as multiplicative factor, dependent on the open response geometry. In the general context model for categorisation probabilities of Nosofsky (1992b) only the nature of the

category representation differs between exemplar- and prototype-based categorisation. Since Nosofsky's multiplicative similarity model is an exponentially multiplicative similarity model, we have to replace the multiplicative bias by a power-raised bias for a shift towards the sensations for the respective category representations and have to assume that the sensation space is Euclidean in order to be consistent with the psychophysical response theory. A prototype-based category is a-priori defined by the centroid sensation  $c_j$  of the Fechner sensations of the subset of objects that belong to category  $j$ , while an exemplar-based category is conceived as an individually memorised category sensation  $c_{j_i}$  as the centroid sensation of the Fechner sensations of individually memorised exemplars of category  $j$ . We assume that the categorisation tasks induce shifts of the dimensional adaptation level towards the respective categories  $j$ , whereby categorisation probability becomes defined by the weighted sensation distance between  $y_i$  and  $c_j$  (prototype model) or  $c_{j_i}$  (exemplar model).

For  $m$ -dimensional Euclidean sensation spaces and the prototype model we have

$$v_{ij}^{\tau_j} = \exp[-2|y_i - c_j|/c_j] = \exp[-\sqrt{\sum_{k=1}^{k=m} \{2(y_{ik} - c_{jk})/c_{jk}\}^2}]$$

with

$$\tau_j = 2/c_j = 1/\sqrt{\sum_{k=1}^{k=m} c_{jk}^2}$$

while for the exemplar model we must write

$$v_{ij}^{\tau_{j_i}} = \exp[-2|y_i - c_{j_i}|/c_{j_i}] = \exp[-\sqrt{\sum_{k=1}^{k=m} \{2(y_{ik} - c_{j_i k})/c_{j_i k}\}^2}]$$

with

$$\tau_{j_i} = 2/c_{j_i} = 1/\sqrt{\sum_{k=1}^{k=m} c_{j_i k}^2}$$

The probability that object  $i$  categorised as belonging to category  $j$  is then for the prototype model written by

$$p_{ij} = 2/[1 + 1/v_{ij}^{\tau_j}] = 2/[1 + \exp\{2|y_i - c_j|/c_j\}]$$

and for the exemplar model by

$$P_{ij} = 2/[1 + 1/v_{ij}^{\tau_{j_i}}] = 2/[1 + \exp\{2|y_i - c_{j_i}|/c_{j_i}\}]$$

because for Euclidean sensations spaces Nosofsky's categorisation model should be an exponentially multiplicative similarity model with power-raised, instead of multiplicative bias. Since individuals have cognitive category representations that need not to coincide with the centroids of sensations for presented objects that belong to each category, the actual space distances to category  $j$  are given by the exemplar-based model distances  $2|y_i - c_{j_i}|/c_{j_i}$ . Thus, our psychophysical response theory predicts that the exemplar-based categorisation model will fit the observed categorisation probabilities better than the prototype-based categorisation model that assumes common-weighted sensation distances to each category sensation. Notice that the Chi-square significance for  $n$  objects,  $q$  categories ( $q \leq n$ ),  $m$  dimensions, and  $N$  individuals is determined by lower degrees of freedom with an a-priori lower Chi-square of the exemplar-based model with  $q \cdot N$  parameters more than the prototype-based model with

only  $m(n-1)$  parameters for the prediction of categorisation probabilities that are identical for individuals in the prototype model and can be different in the exemplar model. Since individuals may have significantly different, observed categorisation probabilities, it is no surprise that Nosofsky (1992b) found in his re-analyses of 19 studies an overwhelming evidence in favour of the exemplar-based model, despite the improperly multiplicative bias in Nosofsky's model. Anyhow, MDS-based choice probability analyses transform choice probabilities to conditional sensation distances and, thereby, at least acknowledge the difference between response and sensation spaces, but also assume a flat (Euclidean or Minkowskian) sensation space. However, according to our psychophysical response theory, exponentially additive models with power-raised bias or hyperbolically multiplicative models with compound bias may hold and then imply that the sensation space is hyperbolic. If the response space is open-hyperbolic and the sensation space Euclidean then we conjecture that Nosofsky's general context model with power-raised bias would have fitted better than with multiplicative bias. Moreover, according to our psychophysical response theory it hardly is a matter of empirical research that not the prototype-, but exemplar-based model applies to categorisation probabilities, because categorisation is a cognitive task. Thereby, categorisation probabilities depend on successive reference-level shifts to individually memorised category sensations, where the memorised category sensations may only become updated by the average sensation of categorised objects that otherwise would solely define the reference levels for prototype-based categorisation.

Lastly, the validity of several other cognitive models and parts of cognition theories becomes questionable by their MDS-representation of dissimilarities as object distances in an infinite, flat (Minkowskian or Euclidean) space. Dissimilarity representations in sensation spaces that are not derived from dissimilarity responses as distances in open individual response spaces are liable to misinterpretations. Euclidean or Minkowskian MDS-analysis of dissimilarities directly represents dissimilarities as distances in flat infinite sensation spaces. Thereby, also theoretical inferences on:

1. perceptual and decisional separability versus integrality (Gamer, 1974, Maddox, 1992),
2. dimensional perception independence versus dependence (Kadlec and Townsend, 1992),
3. distance and density dependence of dissimilarity evaluations (Krumhansl, 1978),
4. space distance versus hierarchical feature-contrast (Tversky, 1977) as dissimilarity,
5. hybrid spatial and hierarchical dissimilarity evaluations (Carroll 1976),

become all questionable and likely invalid, because blurred by artifacts from MDS-analyses that don't transform the individually different object configurations of open response spaces to an individually weighted object configuration in an infinite sensation space. The main reason for these questionable and likely invalid inferences is the implicit, but wrong assumption that the object representation in an infinite flat object space defines properties that also hold for the response spaces of individuals. We firstly discuss this for inferences on 1) and 2), secondly for inferences on 3), and lastly to some extent also for inferences on 4) and 5).

**In** the MDS-analyses of dissimilarities it is not recognised that dissimilarity evaluations are represented by distances in individually different object configurations of open response spaces. Open non-Euclidean response spaces with an absolute curvature of unity only can be transformed to a common Euclidean sensation space,

while open-Euclidean response spaces only can be transformed to a common hyperbolic sensation space or to a common Euclidean stimulus space. Moreover, if individual dissimilarities are analysed as flat space distances and the response space is an open-Euclidean space then the distance metric for a MDS-analysis of individual dissimilarities is Euclidean. Alternatively, if the response space is open-hyperbolic or single-elliptic then individual dissimilarities should not be fitted by any MDS-analysis with a Minkowskian r-metric, while their Euclidean MDS-analysis analyses of open, m-dimensional, non-Euclidean response space distances then would describe the (m+1)-dimensional, Euclidean co-ordinate embedding of such open, m-dimensional response spaces. It follows that inferences from differences in the fit of MDS-analyses of individual dissimilarities as distances in flat spaces with different r-metrics (mainly city-block versus Euclidean metrics) must be invalid. Therefore:

- a) tests of Gaussian versus exponential decay by difference of fit between city-block and Euclidean space analyses of dissimilarities are questionable and likely invalid,
- b) inferences on perceptual or decisional separability versus integrality and on dimensional perception independence versus dependence that are based on the fit of dissimilarity analyses as distances in spaces with different Minkowski r-metrics also are likely invalid.

Other artifacts and misinterpretations also follow from mistaking open individual response spaces as (individually weighted) common flat sensation space. For the hyperbolic tangent function we can write

$$\tanh \left[ \frac{1}{2} \ln \frac{s_i - s_j}{s_i + s_j} \right] = \frac{\tanh \left( \frac{1}{2} \ln \frac{s_i}{s_j} \right) - \tanh \left( \frac{1}{2} \ln \frac{s_j}{s_i} \right)}{1 - \tanh \left( \frac{1}{2} \ln \frac{s_i}{s_j} \right) \tanh \left( \frac{1}{2} \ln \frac{s_j}{s_i} \right)}.$$

Omitting for simplicity of expressions individual indices we write by  $r_i = \tanh(Y_2 s_i)$  and  $r_j = \tanh(Y_2 s_j)$  the dissimilarity responses in open-Euclidean response spaces as function of sensation distance  $d_{ij}$  and sensations  $s_i$  and  $s_j$  in a hyperbolic space of intensity-comparable sensations as

$$r_i - r_j = \tanh \left( \frac{1}{2} \ln \frac{s_i}{s_j} \right) [1 - \tanh(Y_2 s_i) \tanh(Y_2 s_j)],$$

or as distances in open-hyperbolic response spaces of flat sensation spaces as

$$\cosh[r_i - r_j] = \cosh \left\{ \tanh \left( \frac{1}{2} \ln \frac{s_i}{s_j} \right) [1 - \tanh(Y_2 s_i) \tanh(Y_2 s_j)] \right\},$$

while distances in single-elliptic response spaces of flat sensation spaces become as function of sensation distance  $d_{ij}$  and sensation vectors  $s_i$  and  $s_j$  written by

$$\cos[r_i - r_j] = \cos \left\{ \arctan \left( \frac{s_i}{s_j} \right) - \arctan \left( \frac{s_j}{s_i} \right) \right\} = \cos \left\{ \arctan \left[ \frac{d_{ij}}{1 + s_i s_j} \right] \right\}.$$

Open-Euclidean response spaces distance  $|r_i - r_j|$ , or open-hyperbolic response spaces distance  $\cosh(r_i - r_j)$ , or single-elliptic response spaces distance  $\cos(r_i - r_j)$  are the proper dissimilarity representation. However, in MDS-analyses of dissimilarities single-elliptic response distance  $\cos(r_i - r_j) < 1$ , or open-hyperbolic response distance  $\cosh(r_i - r_j) < \cosh(2)$  or open-Euclidean response distance  $|r_i - r_j| < 2$  are taken as flat sensation space distances  $d_{ij}$ . The above expressions show that the dissimilarity as distance between  $r_i$  and  $r_j$  depends on the sensation distance  $d_{ij}$  and on the lengths of the sensation vectors  $s_i$  and  $s_j$  with the (eventually shifted) adaptation level as sensation space origin.

This dependence can be seen as an explanation of why a distance- and density-dependent model (Krumhansl, 1978) is needed for MDS-based dissimilarity analysis, if the sensation space is mistaken for the response space. The sensation distances are then the more shortened the larger the lengths of the sensation vectors are. The mistake of representing the dissimilarities as flat sensation space distances instead of a response space distances explains why the similarity between stimulus  $i$  and  $j$  becomes dependent on their spatial sensation density and the extremity of their sensation locations. Because sensation pairs close to the sensation centroid of the stimuli are central sensation distances that deviate slightly from their response space distances and also in case of complete adaptation-level shifts (the shifted adaptation point as distance midpoint then equals the response space origin), whereby in both cases the response distances are almost equal to their intensity-comparable sensation distances. Remote sensation pairs from the sensation centroid have relatively large sensation vector lengths, whereby their response distance becomes the more reduced the larger the sensation vector lengths are, and/or in case of adaptation level shifts towards vector endpoints or midpoints have relatively large, shifted adaptation-level values. Thereby, their intensity-comparable sensation distances become the more reduced the larger the shifted adaptation levels are (with respect to no adaptation level shifts), which thus reduces also the response distances the more these sensation distances become reduced. Therefore, on the one hand the higher the density around sensations  $i$  and  $j$  is the less distorted their mistaken response distance as sensation distance for the dissimilarity will be, whereby also intransitive dissimilarities will seldom occur. On the other hand distances in a non-dense sensation space region remote from the configuration centroid become the most reduced to response distances and mistaken as sensation distances may then cause intransitive dissimilarities. It shows that distance- and density-dependence of Krumhansl's (1978) model might derive from artifacts of mistaking open response spaces for an infinite sensation space.

Dissimilarities as response space distances of rather eccentric sensations are more dependent on differences in vectorial directions (equal in sensation and response spaces) than on differences in response vector lengths, because response vector lengths of eccentric sensations are by definition similar, due to their limitation by the open boundary of the response space. Taken this together with the effects of adaptation level shifts in dissimilarity evaluations of objects in subspaces with a different dimensionality, as discussed in subsection 7.1.4, it might follow that mistaking the flat sensation space for the response space and ignoring adaptation level shifts might also explain why Tversky (1977) had to formulate his feature-contrast theory of dissimilarity. Phenomena that are described by Tversky's feature-contrast dissimilarity model can also be predicted. On the one hand by adaptation-level shifts for objects in subspaces with a different dimensionality (see subsection 7.1A.). On the other hand by the transformation of sensation spaces to response spaces, whereby dissimilarities as response distances are the more determined by their feature contrast the more eccentric the response distance is, because then the more determined by the vectorial angle between their responses (or sensations) and the less by the length differences of their (then rather long) sensation vectors. Therefore, also the feature-contrast model could generate from methodological artifacts by mistaking the open response space as infinite

sensation space and by ignoring changes in weights of intensity-comparable sensations as function of adaptation level shifts for object subsets in different subspaces. The same may evidently apply to Carroll's (1976) hybrid spatial and hierarchical dissimilarity model as mixture of distance-based and feature-contrast models.

After the analyses of individual dissimilarity data that fit individual response spaces with a specified, open geometry and their transformations to a common Euclidean object space, the differences between object configurations in individual response spaces and the common Euclidean object space can be determined. Also only then we may draw inferences on cognitive processes that underlie individual evaluations. We conjecture that the main aspects of cognitive judgment processes are already implied by psychophysical response theory and its adaptation level dynamics. It remains to be seen whether individual similarity data are fitted better by appropriate transformations of open-Euclidean, or open-hyperbolic, or single-elliptic, individual response spaces to a common Euclidean object space. Especially the appropriate analyses of our biased similarity probability models could yield evidence on whether the response space geometry is open-hyperbolic, open-Euclidean, or single-elliptic and, thus, also whether the common Euclidean object space is the sensation space or the stimulus space (or stimulus-like attribute space for cognitive objects).

#### 7.4. Preference research and dynamic preference relativity

##### 7.4.1. *Preferential choice dynamics*

In section 5.2 and subsection 5.6.1 we demonstrated that preferences of objects with monotone valences are determined by individually oriented ideal axis in individual response spaces. Thus, if preferences are based on monotone valences then all what has been discussed for the dynamic relativity of responses also applies to the ideal axes of preferential responses and their representations in a common Euclidean sensation or stimulus space. Also successive presentations of stimuli or objects that are ranked for their preference may cause momentary shifts of the adaptation level towards the presented stimuli or objects. Since it here concerns dimensional valence values with respect to the dimensional adaptation level on individually different ideal axes, the effects are dependent on the dimensional adaptation-level shift on the ideal axis of a particular individual. For individual different ideal axes same shifts towards the presented stimuli or objects have different effects, because generally the orientations of the ideal axes are different for individuals. Similar to intransitivity of responses complete or partial shifts can also cause intransitive preferences, because the origin of the ideal axis changes with the shift of the adaptation level, whereby not only the origin location of ideal axis changes, but also somewhat its orientation to the ideal infinity direction for each individual in the common Euclidean object space. If an object set is characterised by single-peaked valence dimensions, then a shifted adaptation level will enlarge or shorten the distance between the adaptation and ideal points of an individual. Since valence-comparable sensation dimensions are inversely weighted by distances between their dimensional adaptation and ideal points, momentary adaptation-level shifts also influence single-peaked valence spaces of individuals, which can also cause intransitivity of preferences for objects with single-peaked valences.



Regarding preferential responses as dependent on hedonic sensations (see: sections 1.5. and 1.6.) that are more or less strongly associated with physical choice outcomes, as expected appreciation or aversion sensations of outcomes from matters that might be obtained by the choice, we may assume that preferential choices between objects will partially or completely shift the individual adaptation level towards the sensation midpoint of **(i,j)**, especially if the preferential choice *between objects i or j* concerns sequentially presented and non-randomly selected pairs (i,j) from an object set. However, also here the shift may be towards object j, if a preference task requires that objects i are evaluated with respect to the preference for a target object j. Both shift types also may apply to cognitive objects, but especially choices of *cognitive objects i over j* may produce effects that are similar to effects of adaptation-level shifts on preferential responses to physical stimuli. The relative object frequency and the presentation order of object pairs in (i-or-j)- or (i-over-j)-preference tasks, determine the direction of the adaptation-level shifts in similar ways as discussed for judgmental responses. Since momentary shifts of adaptation level changes the origin and also somewhat the orientation of the individual ideal axis in monotone valence spaces and/or the valence difference between objects in single-peaked valence spaces, it follows that momentarily shifted adaptation levels influence the relative preferences for objects with monotone, or single-peaked, or mixed valences. Therefore, also preferences become dynamically changing by the intra-individual dependence on shifted adaptation levels for the ideal axis and/or for their distances to the ideal point.

#### 7.4.2. *Dynamic relativity of utility- and risk-dependent preferences*

In the sequel we discuss the existing models for choices with uncertain outcomes (see historical overviews: Vlek and Wagenaar, 1979; Hogarth, 1987) that mainly are investigated for gamble alternatives with monetary values and numerically given or graphically indicated outcome probabilities. We discuss the psychological relevance-of the existing models, compare them with model formulations that derive by our psychophysical valence theory, and re-analyse by our models the preference probability data from a study by Tversky (1969).

##### *Expected value model*

In the expected value model gambles or risky investments are evaluated by the product of money value and objective probability of their outcomes. It is the rationally normative preference model for choices between alternatives with known probabilities and monetary values. However, apart from any hypothesis on whether humans act rationally or not, choice outcome probabilities and values are often imperfectly known, while the expected value model also assumes unlimited resources for gamble inputs or investments, which obviously is not the case in the real world. Moreover, if resources are almost unlimited and many small investments in a huge diversity of alternatives have a higher expected value than a few large investments in a small number of alternatives then the personal labour of the former may outweigh the difference in expected values. The expected value model can accommodate this by the multidimensional incorporation of labour costs that are different for different individuals, while also the affordable limits of individual resources can become prohibitive for the acceptance of small chances on big losses. Although a choice for the

alternative with maximum expected value is economically rational, according to our psychophysical valence theory for monotone valences the expected value model is not a model that describes human choice behaviour, because the product of value  $x_i$  and probability  $p_i$  would correspond to the sum of Fechner sensations  $\ln(x_i)$  and  $\ln(p_i)$  that are not comparable, while the arbitrary scale unit of at least  $x_i$  also implies an arbitrary scale origin for  $\ln(p_i \cdot x_i)$ . Any preference model that implies incomparable sensations and/or dependence of scale units, such as the currency of monetary values, must be an invalid model for the description or prediction of preference behaviour.

*Subjective expected value model*

A subjective expected value model evaluates choices by the product of the objective values and subjective probabilities of the alternatives. Subjective probabilities are individual evaluations of comparable (un)certainly sensations of (un)certainly stimulus magnitudes that are defined by objective probabilities. Our psychophysical response theory uniquely specifies the parameter-dependent (un)certainly sensations. If certainty stimuli are expressed by  $f(p_i)$  then  $f(1-p_i) = 1/f(p_i)$  are uncertainty stimuli, which only holds for  $f(p_i) = [p_i/(1-p_i)]^a$ . Thus, probability  $p_i$  defines  $z_i = [p_i/(1-p_i)]^a$  as certainty stimulus with subjective certainty magnitude  $(z_i/z_a)^{\tau_z}$  and comparable sensation  $\tau_z \cdot [\ln(z_i) \ln(z_a) - 1]$ , where power exponent  $\tau_z = 2/\ln(z_a)$  with certainty adaptation level  $\ln(z_a) = \ln[p_a/(1-p_a)] - \ln[p_a/(1-p_a)]$ , for threshold  $p_a$  and midrange point  $p_a$  for the range of presented probabilities  $p_i$ . If  $p_a = .50$  then  $\ln[p_a/(1-p_a)] = 0$  and  $z_a = (1-p_a)/p_a$ , but other adaptation levels may apply to sets of alternatives that on average are more or less probable than  $p = .50$ , although then also generally threshold  $p_a$  decreases in such a way that power exponent  $\tau_z$  is almost constant. Thereby, also the adaptation-level value  $\ln(z_a) = \ln[p_a/(1-p_a)] - \ln[p_a/(1-p_a)]$ , concerns a rather stable distance, unless adaptation level shifts to extreme or targeted certainty sensations of alternatives are present. Certainty response  $c_{ji}$  for outcome probability  $p_i$  with individual adaptation-level probability  $P_j$  an threshold probability  $p_a$  is described by the psychophysical response and monotone valence theory by

$$c_{ji} = \tanh\{[\ln[p_i/(1-p_i)] - \ln[p_a/(1-p_a)]] / \ln[p_i/(1-p_i)] - \ln[p_a/(1-p_a)]\}$$

$$c_{ji} = \arctan[2\{[\ln[p_i/(1-p_i)] - \ln[p_a/(1-p_a)]] / \ln[p_i/(1-p_i)] - \ln[p_a/(1-p_a)]\}]$$

provided that the choice presentation or task doesn't shift the adaptation level to certainty sensation  $\ln(z_a) = \ln[p_a/(1-p_a)]$  of target probability  $P_j = p_a$ . For the moment we will take  $P_j = p_a = .50$  for objective probabilities that range around  $p_a = .50$ , whereby  $\ln[p_a/(1-p_a)] = 0$  and  $z_a = [p_a/(1-p_a)]^a = 1$ , which simplifies comparable certainty sensations to  $2\ln[p_i/(1-p_i)]$ . Certainty responses  $c_{ji}$  in the hyperbolic tangent-based response expression for  $P_j = p_a = .50$  and  $p_a = 1/[1 + \exp(2)] = 0.1192$  defines  $a = \ln[p_a/(1-p_a)] = -2$ , whereby power exponent  $\tau_z = 2/a = -1$  would specify  $\ln[p_i/(1-p_i)]$  as comparable certainty sensations that would equal cognitive magnitude sensations as averaged length and distance sensations (see: p. 55 in here) and would yield for hyperbolic tangent-based certainty responses  $c_{ji} = c_i$

$$c_i = \tanh\{2 \ln[p_i/(1-p_i)]\} \quad \text{for } p_a = .1192; p = .50$$

By the relation between responses and logistic probability  $c_i = 2p_i - 1$  we obtain subjective probabilities  $p_i = (c_i + 1)/2 = 1/[1 + (1-p_i)/p_i]$  that satisfy  $p_i = p_i$ , provided that  $p_i = 1/[1 + \exp(a)] = 0.1192$  and  $p_a = 0.50$ . However, if just noticeable probability  $p_i < 0.1192$ , which likely holds, then subjective probability  $p_i$  over- and underestimates  $p_i$  the more  $p_i$  differs from  $p_a = 0.50$ . For example, if  $p_i = 0.08$  and  $p_a = 0.50$  we obtain by

$$p_i = [1 + \tanh\{\ln[p_i/(1-p_i)]/\ln(0.92105)\}]/2 \quad | p_i = 0.08; p_a = 0.50$$

the following subjective probabilities for objective probabilities:

Objective $p_i$	.10	.20	.30	.40	.50	.60	.70	.80	.90
Subjective $p_i$	.142	.243	.329	.415	.50	.585	.673	.761	.859

The generally found over- and underestimation of respectively low and high probabilities are predicted by our psychophysical response theory, if just noticeable probability  $p_i < 1/[1 + \exp(2)]$  and  $p_a = 0.50$ . This implies that subjective certainty magnitudes  $[p_i/(1-p_i)]^{\tau}$  have Stevens' power exponent  $\tau = 2/\ln[(1-p_i)/p_i] < 1$ , where  $\tau \approx 0.82$ , if  $p_i = 0.08$ . However, certainty response concern magnitude responses for probabilities, but probabilities in utility- and risk-dependent preference models are cognitively evaluated certainty preferences that may have individually different, cognitive reference levels  $P_{Ja} \neq p_a$  and/or  $P_{Jr} \neq p_r$ . Thus, our psychophysical response and monotone valence theory define monotone certainty valences of gambles by

$$c_{Ji} = \tanh\left\{ \frac{\ln[p_i/(1-p_i)]/[p_{Ja}/(1-p_{Ja})] - j/\ln[p_i/(1-p_{Ja})]/[p_{Jr}/(1-p_{Jr})]}{1} \right\}$$

or

$$c_i = \arctan\left[ 2 \frac{\ln[p_i/(1-p_i)]/[p_i/(1-p_i)] - 1/\ln[(p_i/(1-p_i))/(p_i/(1-p_i))]}{1} \right]$$

But subjective expected values  $(x_i/\mu) \cdot p_i = \exp[\ln(x_i/\mu) + \ln(p_i)]$  for values  $x_i/\mu$  and subjective probabilities  $p_i$  can't define preferences for alternatives with uncertain outcomes, because sensations  $\ln(x_i/\mu)$  define no comparable value sensations and depend on the value-measurement unit  $\mu$  or currency of monetary values, while  $\ln(p_i)$  also is no comparable certainty sensation, because its Fechnerian uncertainty sensations  $-\ln(1-p_i)$  equal not the Fechnerian certainty sensations  $\ln(p_i)$ .

*Expected utility model*

An expected utility model defines that choice alternatives are evaluated by the product of objective probability and subjective value (utility) of objective monetary value of the alternatives. The relationship between utility and monetary values is differently shaped for different individuals, which has already been shown in the classical study of Mosteller and Noguee (1951). That study showed that the utility scale in the range of five to six US\$ cents was concave (negatively accelerated) for Harvard students (generally from relatively rich families) and convex (positively accelerated) for guardsmen (relatively poor in the fifties of the 20<sup>th</sup> century). This is consistent with our theory, wherein the hyperbolic tangent or arctangent transforms the logarithmic value of money with respect to the different adaptation levels of affordable expenses for these two types of subjects, which would yield two different utility scales for monetary gamble values in the study of Mosteller and Noguee. Their study concerns an expected

utility model, wherein utilities are multiplied by objective probabilities, however the validity of using objective probabilities must be doubted. This objection has been accommodated in an experimental study by Davidson, Suppes and Siegel (1957) that was based on an approximating utility transformation of monetary values for alternatives with an ascertained equivalence of subjective and objective probability. But even if subjective and objective probabilities are approximately equal, it has been shown that subjects actually don't use the product of objective probabilities and utilities for their preferential responses (Coombs et al., 1970). Moreover, only interval-scale measurement is obtained for individual utility  $u_{ji}$  which yields no meaningful measurement of expected utility, neither for  $u_{ji}$  as subjective value magnitude in product  $p_i u_{ji}$ , nor for some combination of individual utility sensations and probability sensations, because dependent on arbitrary utility parameters.

The measurement axiomatisation of utility for gains or losses as proportional to a negative exponential function of objective values with respect to neutral level by Luce (2000) is discussed in subsection 6.1.3., where we compared Luce's inferred-extensive utility measurement with our hyperbolic tangent transformation of comparable value sensations to utility responses. According to our psychophysical response and monotone valence theory subjective values are transformed-extensive utility responses  $u_{ji}$  to comparable sensations of objective values  $x_i$  with respect to the adaptation level  $b_{ji} = x_{ja}$  of subject J. Utility response  $u_{ji}$  is written as

$$\text{or } \begin{aligned} "J'_i &= \tanh\{[\ln(x_i) - \ln(x_{ja})] / [\ln(x_{ja}) - \ln(x_{j0})]\} \\ "J_i &= \arctan[2\{[\ln(x_i) - \ln(x_{ja})] / [\ln(x_{ja}) - \ln(x_{j0})]\}] \end{aligned}$$

provided that individual adaptation level  $\ln(x_{ja})$  is not shifted by presented alternatives with respect to  $\ln(x_{j0})$  as Fechnerian just noticeable sensation for values. The ratio expression

$$s_{jix} = 2\{[\ln(x_i) - \ln(x_{ja})] / [\ln(x_{ja}) - \ln(x_{j0})]\}$$

defines comparable value sensations that are invariant under linear transformations of  $\ln(x_i/u)$ . For monetary values we may assume that  $\ln(x_{ja}/u) = 2$ , because their sensations likely equal cognitive magnitude sensations, whereby power exponent  $\tau_x = 1$ . For monetary values no just noticeable sensation level  $\ln(x_{j0}/u)$  may exist, but individuals may take some reference levels  $x_{ja}$  as relevant for their utility evaluations of monetary values, such as the minimum of the monetary values for a presented gamble set, whereby  $\tau_x = 2 / \ln(x_{ja}/x_{j0}) = 1$  needs not to hold. It implies that we define comparable value sensations of monetary values by

$$s_{jix} = 2 \cdot \ln(x_i/x_{ja}) / [\ln(x_{ja}/x_{j0})]$$

and utility responses by

$$\text{or } \begin{aligned} "J'_i &= \tanh[\ln(x_i/x_{ja}) / \ln(x_{ja}/x_{j0})], \\ "J_i &= \arctan[2 \cdot \ln(x_i/x_{ja}) / \ln(x_{ja}/x_{j0})]. \end{aligned}$$

Notice that  $V_{ji}^j = \exp(u_{ji})$  equals within a wide midrange the subjective value magnitudes  $(x_i/x_{ja})^{\tau_x}$ , as shown in subsection 6.3.2 for subjective stimulus magnitudes and responses. However, an expected utility model that is defined by product of

objective probability  $p_i$  and subjective value magnitudes  $v_{T_i}$  as utility for monetary values defines no valid preference model for choices with uncertain outcomes, because  $v_{T_i} = \exp[u_{T_i} + \ln(p_i)]$  defines for  $\ln(p_i)$  no comparable certainty sensations. Nonetheless, since subjective probabilities may not deviate too much from objective probabilities within a wide probability midrange, the order of the products of objective probabilities and power-raised values as utilities might approximately define the preference order for gambles within a restricted range of values and probabilities.

#### *Subjective expected utility models*

In subjective expected utility models the product of subjective values and subjective probabilities determine the preferences. Tversky (1967) designed a study for the simultaneous measurement of subjective values and subjective probabilities by an additive conjoint measurement analysis (see subsection 6.1.4.) of preference order data for gamble pairs with independently varying probabilities and values. Tversky's additive conjoint model presupposes independence of subjective probabilities and subjective values by the log-additivity of subjective probability and utility. Tversky fitted utility by the logarithm of power-raised, objective values, whereby the logarithmic values of subjective probabilities are determined by interval scale values. This log-additive model corresponds to additivity of independent certainty and subjective value sensations and to multiplicativity of subjective value and probability magnitudes. The relationship between objective and subjective probabilities was almost linear, but with over- and underestimations of respectively low and high, objective probabilities for most subjects. However, Tversky's findings of over- and underestimated probabilities can be due to the assumed power function of objective values as utility. Over- and underestimations of respectively low and high probabilities are found in most gamble preference studies, but not universally, which might be due to presence of single-peaked risk preferences. For ideal risk levels around  $p = .50$  this could be described by a preference dependence on probability variances of gambles, which dependence seems present for some subjects (Edwards, 1954; Coombs and Pruitt, 1960). If subjective expected utility evaluation is assumed to be a stochastic process with distributions of subjectively evaluated probabilities and values then we have a *random (probabilistic) model for subjective expected utility* (Luce and Suppes, 1965), otherwise it is a constant (deterministic) model. Tversky's (1967) additive preference model is a *constant model for subjective expected utility*, where Tversky's analysis confirmed the independence of subjective probabilities and utilities in his study for gamble pairs with independently varying values and objective probabilities.

#### *Prospect theory of subjective expected utility*

Modern measurement theory of subjective expected utility defines distinct anchor points for the evaluation of utility and certainty, where these anchor points play an important role in the prospect theory (Kahneman and Tversky, 1979, Tversky and Kahneman, 1992). The prospect theory is a *relative model of subjective expected utility* in the sense that some subjectively determined, neutral expected utility is introduced, where above or below expected utilities are appreciated or respectively disliked. As discussed in section 1.2., utility as dependent on an individual anchor value is originally introduced by Seigel (1957) and formalised by Kapteyn (1977) who defined the present

income-spending level on commodities for an individual as anchor point for utility evaluations of valued goods in his econometric theory of preference formation. As described in section 6.1.3, the recent axiomatisation of utility measurement for the prospect theory by Luce (2000) defines utility of losses or gains with respect to a status quo with zero utility, while Luce specified the utility of losses or gains by a metric, negative exponential function of the objective loss or gain values. In the prospect theory the anchor point can also be an expected reference level for affordable expenditures in the future, which then is comparable to a cognitively shifted adaptation level for the evaluation of gains or losses in the future. If we regard the dynamic anchoring adjustments as shifting adaptation levels, which also imply shifting weights for comparable certainty and value sensations, then we may metricise the prospect theory by the relativity dynamics of our psychophysical response and valence theory for probabilities and values with monotone valences.

*Psychophysical response theory of subjective expected utility*

If certainty of gamble outcome probabilities define certainty sensations with monotone valences (no single-peaked risk preference for ideal risks level  $0 < p_j < 1$ ), while utilities of monetary values likely are monotone valences, then a deterministic (constant) model of subjective expected utility for gamble preference responses can be in accordance with our psychophysical valence theory, if utility response  $u_{ji}$  are defined by

$$\text{or } u_{ji}' = \tanh(\frac{1}{2}s_{jiX}) = \tanh[\ln(x_{ja}/x_{jr})/\ln(x_{ja}/x_{jr})] \\ u_{ji}' = \arctan(s_{jiX}) = \arctan[2 \cdot \ln(x_{ja}/x_{jr})/\ln(x_{ja}/x_{jr})]$$

and subjective probability responses to certainty stimuli  $z_i = p_i/(1-p_i)$  with certainty-reference levels,  $z_{ja} = p_{ja}/(1-p_{ja})$  and  $z_{jr} = p_{jr}/(1-p_{jr})$  by

$$c_{ji}' = \tanh(\frac{1}{2}s_{jiC}) = \tanh\{\ln(z_{ja}/z_{jr})/\ln(z_{ja}/z_{jr})\} \\ c_{ji}' = \arctan(s_{jiC}) = \arctan\{2 \cdot \ln(z_{ja}/z_{jr})/\ln(z_{ja}/z_{jr})\}$$

provided that individual adaptation levels  $x_{ja}/\mu$  and  $z_{ja} = p_{ja}/(1-p_{ja})$  are not shifted with respect to reference levels  $x_{jr}/\mu$  and  $z_{jr} = p_{jr}/(1-p_{jr})$  by presented gamble alternatives that are compared to reference gamble  $r$ . A subjective expected utility model in our theory defines preferential responses by the ideal axis in the two-dimensional response space of certainty responses  $c_{ji}$  and utility responses  $u_{ji}$ . If subjective probability and utility are independent and no single-peaked risk valences are present, then individual rotation angles  $\alpha_{ji}$  and  $(90^\circ - \alpha_{ji})$  of certainty and utility response dimensions determine the individual ideal response axis  $r_{ji}$  with monotone preference values in our psychophysical response and valence theory (see subsection 5.2.1.) Since corresponding dimensions in response and comparable sensation spaces have identical angles to the ideal axes of individuals in both spaces, the rotation parameters  $h_{jC} = \cos(\alpha_{ji})$  and  $h_{jX} = \cos(90^\circ - \alpha_{ji})$  also define the ideal sensation axes

$$s_{ji}' = h_{jC} \cdot j_{jiC} + h_{jX} \cdot j_{jiX}$$

whereby the ideal response axes of monotone gamble valences are defined by

$$r_{ji}' = \tanh(\frac{1}{2}s_{ji}') = \tanh[h_{jC} \cdot Y_{2s_{jiC}} + h_{jX} \cdot \frac{1}{2}s_{jiX}]$$

or

$$r_{Ji} = \arctan(s_i') = \arctan[h_{Jc} \cdot s_{Jic} + h_{Jx} \cdot s_{Jix}]$$

Thus

$$\text{if } r_{Ji} - r_{Jj} > 0 \text{ then } s_{Ji} - s_{Jj} = h_{Jc}(s_{Jic} - s_{Jjc}) + h_{Jx}(s_{Jix} - s_{Jjx}) > 0$$

although  $r_{Ji} - r_{Jj} \neq \tanh[\frac{1}{2}(s_{Ji} - s_{Jj})]$  or  $r_{Ji} - r_{Jj} \neq \arctan[s_{Ji} - s_{Jj}]$ , unless either  $s_i' = 0$  or  $s_{jj} = 0$ . Assuming that we have hyperbolic tangent-based response transformat\ons of ideal sensation axes to open ideal response axes, then it holds that

$$\text{if } s_{Ji} - s_{Jj} > 0 \text{ then } r_{Ji} - r_{Jj} = \tanh[\frac{1}{2}(s_{Ji} - s_{Jj})] \cdot [1 - \tanh(\frac{1}{2}s_{Ji}) \cdot \tanh(\frac{1}{2}s_{Jj})] > 0.$$

It defines, apart from the metric response transformat\on, a model for preference rank orders that due to linear difference function is an additive model that only can handle transitive preference rank orders, because here

$$\text{if } r_{Ji} - r_{Jj} > r_{Jj} - r_{Jk} \text{ then } \sum_{k=1}^{k=m} h_{Jk} (s_{Jgk} - s_{Jjk}) > 0 \text{ and } \sum_{k=1}^{k=m} h_{Jk} (s_{Jik} - s_{Jjk}) > 0$$

implies

$$\sum_{k=1}^{k=m} h_{Jk} (s_{Jgk} - s_{Jjk}) > 0 \quad \text{and} \quad r_{Jg} > r_{Jj}$$

Only if the difference function is nonlinear then we obtain an additive difference model (Tversky. 1969; Falmagne, 1985, Suppes, et al. 1989. pp. 393-400) that reduces not to the additive model for preferences with utility and certainty components. This non-linearity condition for the additive difference model is proved for multidimensional objects with monotone preference functions by Tversky (1969) and for discrimination probability models by Falmagne (1985). If  $s_{rk} - s_{rl} > \delta$  and  $s_{rh} - s_{rl} < \delta$  define respectively regarded and ignored preference aspects for alternatives in successive evaluations of choice aspects then the additive difference model for preferences reduces to Luce's (1956) lexicographic semi-order model, which model also applies to the elimination by aspect (EBA) model of Tversky (1972). Since the EBA-model only dichotomises the additive difference model, it also can predict intransitive preference rank orders. However, we define gamble preferences by the ideal axis sensations that depend on rotational weights  $h_{Jc} \geq 0$  and  $h_{Jx} \geq 0$  for appreciated certainty and value sensations of gambles, whereby our model becomes an additive model.

We assumed independence between comparable certainty and value sensation dimensions with individually different ideal infinities, whereby individuals may differently rotate their comparable certainty and value sensation dimensions to individual ideal response axes. However, choices between uncertain outcomes generally concern alternatives with objective probabilities that are the lower the higher their values are, which applies to lotteries and usually also to studies on gamble preferences. Thus, certainty and utility dimensions generally are negatively correlated, whereby  $h_{Jc}^2 + h_{Jx}^2 = 1 + \rho_{cx}^2$  for correlation  $\rho_{cx}$ . If  $\rho_{cx} = -1$  then  $h_{Jc} + h_{Jx} = 2$ , because certainty and value sensations of gambles are both the more appreciated the higher they are. Also, the ideal preference axis for gambles with completely reverse-dependent probabilities and values reduces for  $h_{Jc} + h_{Jx} = 2$  to a metric additive model. It predicts only transitive gamble preferences, but if subsets of gamble pairs are perceived as differently unidimensional and/or if shifts of adaptation levels are present, then the

difference model is no longer linear. Thus, under subset-dependent dimensionality reductions and/or adaptation-level shifts our model becomes a nonlinear, additive difference model that can predict intransitive gamble preferences. If it asked which gamble of a presented gamble pair is preferred then it may be that the respective adaptation levels for values  $x_i$  and certainties  $z_i = p_i/(1-p_i)$  of probabilities  $p_i$  shift to

$$\text{and } \begin{aligned} \ln(x_{ij}) &= \sqrt{2} \ln(x_i/x_j) \\ \ln(z_{ij}) &= \sqrt{2} \ln\left\{\frac{p_i/(1-p_i)}{p_j/(1-p_j)}\right\} \end{aligned}$$

Under complete adaptation to midpoint sensations of compared gamble alternatives the weights  $\tau_{Jijx} = 2/J \ln|x_i/x_j|$  and  $\tau_{Jijz} = 2/J \ln|z_i/z_j|$  define comparable certainty sensations  $\tau_{Jijz} \cdot \ln(z_i/z_j)$  and comparable value sensations  $\tau_{Jijx} \cdot \ln(x_i/x_j)$ . Thereby, we rewrite (i-or-j)-preferences for subjective expected utility as

$$\begin{aligned} r_{ij} &= \tanh\left\{\frac{1}{2}\left[h_c \tau_{Jijz} \ln(z_i/z_j) + h_x \tau_{Jijx} \ln(x_i/x_j)\right]\right\} \\ r_{jij} &= \arctan\left[h_c \tau_{Jijz} \ln(z_i/z_j) + h_x \tau_{Jijx} \ln(x_i/x_j)\right] \end{aligned}$$

If  $r_{ij} - r_{jij} > 0$  then gamble alternative  $i$  is preferred over alternative  $j$  and also

$$h_c \tau_{Jijz} [\ln(z_i) - \ln(z_j)] + h_x \tau_{Jijx} [\ln(x_i) - \ln(x_j)] > 0,$$

but due to the weight terms  $\tau_{Jijz}$  and  $\tau_{Jijx}$  the difference function is no longer linear, which then defines an additive difference model that can yield intransitive preference rank orders. Since the equalities  $\ln(x_i/x_j) = \sqrt{2} \ln(x_i/x_j)$  and  $\ln(z_i/z_j) = \sqrt{2} \ln(z_i/z_j)$  define  $r_{ij} = -r_{jij}$ , whereby  $r_{ij} - r_{jij} = 2r_{ij}$ , we can write the hyperbolic tangent-based preference probability that  $i$  is preferred over  $j$  in (i-or-j)-preference tasks by

$$p_{r,ij} = \frac{1 + r_{ij}}{2}$$

If the preference task for gambles is described by questions on whether gamble  $i$  is preferred over gamble  $j$  or not, instead of questions on which gamble out of pair  $(i,j)$  is preferred, we could assume that the adaptation level will shift to gamble  $j$  and not to their midpoint. Thus for  $\tau_{Jijx} = 2/J \ln|x_i/x_j|$  and  $\tau_{Jijz} = 2/J \ln|z_i/z_j|$  in (i-over-j) preference responses we obtain

$$\text{or } \begin{aligned} r_{ij} &= \tanh\left\{\frac{1}{2}\left[h_c \tau_{Jijz} \ln(z_i/z_j) + h_x \tau_{Jijx} \ln(x_i/x_j)\right]\right\} \\ r_{jij} &= \arctan\left[h_c \tau_{Jijz} \ln(z_i/z_j) + h_x \tau_{Jijx} \ln(x_i/x_j)\right], \end{aligned}$$

where  $i$  is preferred over  $j$  if  $r_{ij} > 0$  defines again an additive difference model. Preferences with shifts to gamble  $j$  in (i-over-j)-preference tasks not only can become intransitive, but also asymmetric in the sense that gamble  $i$  can be preferred in the (i-over-j) preference task and gamble  $j$  in the (j-over-i) preference task for the same gamble pair  $(i,j)$ . Notice that also here  $p_{r,ij} = [1 + r_{ij}]/2$  define the probability that alternative  $i$  is preferred over alternative  $j$  in (i-over-j)-preference tasks.

Adaptation-level shifts to target gambles or to their pair midpoints in our model can predict transitivity violations in observed preferences or preference probabilities, because our psychophysical response theory then defines a metrically nonlinear, additive difference model for preferences. Tversky (1969) found intransitivity of



preference probabilities in a study, wherein the following five gambles are employed.

Gamble	Probability of winning	Payoff in US\$	Expected value
a	7/24	5.00	1.46
b	8/24	4.75	1.58
c	9/24	4.50	1.69
d	10/24	4.25	1.77
e	11/24	4.00	1.83

*Table: Gambles in Tversky's study of intransitive choice probabilities*

The ten pairs of these specific constructed gambles and ten other pairs of five gambles with different probabilities and payoffs are repeatedly presented in twenty sessions, wherein randomly selected gamble pairs are shown by graphical displays (also randomised in left-right location of gambles). The displays show complementary black and white sections of circular pies for respectively winning and losing probabilities and printed \$ numbers for payoff above the black pie section for the winning probability and zero's below the white pie section of the losing probability without any loss. The eight subjects in Tversky's study are the selected subjects that showed intransitive choice rank orders in a preliminary study with eighteen individuals and wherein also the presented gambles with intransitive choice results for eight out of eighteen subjects are selected. Although the majority of subjects actually show transitive choice patterns, again six out of the eight selected subjects showed significantly intransitive preference probabilities in the actual study of 20 times repeated sessions for gamble preferences between 10 pairs of the five selected gambles and 10 pairs of the five irrelevant other gambles. Tversky's selected gambles have probability difference  $1/24 = 0.042$  between adjacent gambles, where the probability difference has to be visually inferred from a correspondingly small pie-section difference that may be below the perception threshold. Differences in printed dollar values have no perception threshold, while the visually inferred probability difference  $4/24 = 0.167$  between the most remote gambles will be perceived. The gamble pairs with unperceivable probability differences can only be evaluated by their values, whereby adjacent gamble pairs (a,b), (b,c), (c,d), and (d,e) have preference order  $a > b > c > d > e$ , while the most remote gambles (a,e) can have intransitive preference order  $e > a$  if its perceivable probability difference 0.167 is judged more important than its value difference of one \$. In this way designed gambles are supposed to lead to intransitive preference probabilities in additive difference model of preference (Suppes et al., 1989, ch.17, p. 396-400). In the next table we copy the observed probabilities of one individual (subject 1 in Tversky, 1969, p. 35) for preferences of row gamble i over column gamble j from the five selected gambles, where bold figures indicate the intransitive probabilities.

gamble	a	b	c	d	e
a		.75	.70	.45	.15
b			.85	.65	.40
c				.80	.60
d					.85

*Observed, intransitive probabilities: subject 1*

The gamble pairs are randomly presented in order and left-right display positions, while the gambles have completely dependent values and probabilities that satisfy for positive appreciation weights  $h_{JC} + h_{JX} = 2$ . Thereby, a constraint model for preference probabilities with adaptation-level shifts to gamble midpoint sensations can be formulated as

$$\text{or } P'_{Jr}{}_{ij} = \{I + \tanh[h_{JC} \cdot \tau_{Jijz} \cdot \ln(z_i/z_j) + (2 - h_{JC}) \cdot \tau_{Jijx} \cdot \ln(x_i/x_j)]\} / 2,$$

$$P'_{Jr}{}_{ij} = \{I + \arctan[2 \cdot h_{JC} \cdot \tau_{Jijz} \cdot \ln(z_i/z_j) + 2 \cdot (2 - h_{JC}) \cdot \tau_{Jijx} \cdot \ln(x_i/x_j)] / (\sqrt{2}\pi)\} / 2.$$

This additive difference model reduces not the additive model with transitive preference probabilities, due to the comparability weights  $\tau_{Jijz} = 2 / [1 \ln(z_i/z_j)]$  and  $\tau_{Jijx} = 2 / [1 \ln(x_i/x_j)]$  by adaptation-level shifts to sensation midpoints  $z_{J0}$  and  $x_{J0}$  with  $z_{Jr} = P_{Jr} / (1 - p_{Jr})$  and  $x_{Jr} = X_{Jr} / (1 - p_{Jr})$  as individual reference levels for the evaluation of certainty and variance sensations of gambles in the above gamble set. Parameters  $h_{JC}$ ,  $P_{Jr}$  and  $x_{Jr}$  can be estimated for a prediction of observed preference probabilities under minimisation of Chi-square

$$\chi^2_J = 20 \cdot [(P_{Jij} - P_{Jir} \cdot l_{ij})^2 / (P_{Jir} \cdot l_{ij} \cdot (1 - P_{Jir} \cdot l_{ij}))],$$

where each observed probability  $p_{Jij}$  concerns 20 preferences for twenty times presented gamble pairs (iJ). Per individual we have ten independent preference probabilities  $P_{Jij}$  whereby the degrees of freedom for the Chi-square is  $df = 7$  for three estimated parameters.

However, the individuals may not always perceive the gamble-probability differences, because represented by pie-area differences that for adjacent gambles are hardly perceivable. For probabilities as pie-area proportions we expect  $\tau_z \approx 0.75$ , because for subjective magnitudes of circle-part lengths  $\tau_1 \approx 1$  and for subjective magnitudes of pie area  $\tau_2 = 0.5$ . If  $p_j = 0.5$  and  $\tau_z = (\tau_1 + \tau_2) / 2 = 0.75$  then  $p_o = 0.075$  is the just noticeable probability. The mean gamble probability, however, is  $9/24 = .375 < p = 0.50$ , whereby  $p_o$  will be somewhat smaller, but it then still may be expected that at least the probability differences  $1/24 = .042$  for adjacent gambles are hardly discriminated. For preference evaluations of gamble pairs with hardly perceivable probability differences we have to introduce a discrimination probability of gamble probabilities as complement of the confusion probability, defined in subsection 7.2.4. If we here replace distance  $1/2d_{ij}$  by  $\sqrt{2} \ln(z_i/z_j) / (1 - \ln(z_i/z_j))$  and the weight  $2/a_{ij}$  by  $2 \cdot [1 \ln(z_i/z_j) - \ln(z_{J0})] = 2 / [\ln(z_i/z_j) - 1]$  then for hyperbolic or Euclidean sensations under adaptation-level shifts to their midpoint sensations the discrimination probability of gamble probabilities is defined by

$$P'_{JIC}{}_{ij} = \tanh\{[\ln(z_i/z_j) / \ln(z_{J0})] / (1 - \ln(z_i/z_j))\},$$

or alternatively for hyperbolic sensations by

$$P'_{JIC}{}_{ij} = \tanh\{\sqrt{2} \ln\{ \cosh[2 \cdot \ln(z_i/z_j) / (1 - \ln(z_i/z_j))] \} / (1 - \ln(z_i/z_j))\},$$

or alternatively for Euclidean sensations by

$$P'_{JIC}{}_{ij} = \arctan\{2 \cdot [1 \ln(z_i/z_j) / \ln(z_{J0})] / (\sqrt{2}\pi)\},$$

where  $p_{ij}$  is the probability that certainty sensations are used in the preference evaluations. Thereby, and defining  $w = h_{JC} \cdot p_{ij}$ , we obtain for the gambles in Tversky's (1969) study by

$$P_{I|ij} = [1 + \tanh(w) \cdot \tau_{JIZ} \cdot \ln(z_i/z_j) + (2 - w) \cdot \tau_{JIx} \cdot \ln(x_i/x_j)] / 2$$

$$P_{I|ij} = \{1 + \arctan[2 \cdot w / (e^{\tau_{JIZ} \cdot \ln(z_i/z_j)} + e^{\tau_{JIx} \cdot \ln(x_i/x_j)})] / (Y21t)\} / 2$$

the probability that gamble i is preferred over gamble j. In this preference probability expression with comparability weights  $\tau_{JIZ} = 2J \ln(z_i/z_j)$  and  $\tau_{JIx} = 2J \ln(x_i/x_j)$  and in the expression for discrimination probability  $p_{ij}$  of gamble probabilities, we assumed different reference levels  $z_J = P_{JO} - P_{JS}$  and  $z_O = P_{JO} / (1 - P_J)$  for discrimination of probabilities. However, it seems reasonable to assume that  $p_{JO} = P_{JO}$  for certainty inferences from displayed pie-area proportions as gamble probabilities.

We fitted the arctangent-based and hyperbolic tangent-based models with their different expressions for  $p_{ij}$ , but only the hyperbolic tangent-based model with the hyperbolic cosine-based expression for  $p_{ij}$  yields significantly higher Chi-squares. This implies not a Euclidean sensation space, since  $p_{ij} = \tanh[\ln(z_i/z_j) / \ln(z_i/z_{JO})]$  not only may concern Euclidean distance  $d_{ij} = 2 \cdot |\ln(z_i/z_j) / \ln(z_i/z_{JO})|$ , but also Euclidean co-ordinate  $\exp(-d_{ij})$  of hyperbolic distance  $d_{ij}$ . Thus, our analyses of the preference probabilities of gambles with relatively small value and probability differences in the Tversky's study reveal no decisive evidence for whether the geometry of the stimulus space is elliptic, or hyperbolic, or Euclidean. In the sequel we only give detailed analysis results for hyperbolic tangent-based preference models with  $p_{ij} = \tanh[\ln(z_i/z_j) / \ln(z_i/z_{JO})]$ . In the next two tables we give the predicted preference probabilities by the model with  $P_{JO} = P_{JO}$  and the underlying probability-dissimilarity probabilities  $P_{I|ij}$  for subject I with the above shown observed choice probabilities, where here bold figures indicate intransitive predictions.

gamble a	b	c	d	e	gamble a	b	c	d	e
a	.61	.65	.55	.22	a	.15	.33	.55	.74
b		.66	.67	.30	b		.20	.46	.74
c			.77	.67	c			.31	.73
d				.83	d				.69

Predicted choice probabilities: subj. 1

Discrimination prob. of prob.: subj. 1

The model with estimated parameters  $h_{JC} = 2.0$ ,  $p_{JO} = P_{JO} = .462$ , and  $x_{JO} = 4.16$  yields the minimised  $\text{Chi}^2 = 7.75$  and, thus, fits rather well, because for  $df = 7$  (10 independent observations minus 3 parameters) its significance level is about  $p \approx .35$ , where  $df = 7$  has the expected  $\text{Chi}^2 = 6.35$  at  $p = .50$ . However, since  $h_{JC} = 2$  is maximal, we also may take  $h_{JC} = 2$  as prior model-type specification, while  $\text{Chi}^2 = 7.75$  for  $df = 8$  has significance level  $p \approx 0.45$ . We also fitted the model with different parameters  $P_I$  and  $P_{JO}$ , but for subject I the optimal parameter  $x_{JO}$  remains identical, while  $P_{JO} = .469$  and  $p_{JO} = .460$  hardly differ. Notice that level  $x_{JO} = 4.16$  almost equals the geometric midpoint of 4.0\$ and 4.25\$ for the values of gambles (e) and (d), while  $P_{JO} = .462$  almost equals  $p_e = 11/24 = .458$  for gamble (e). Since  $h_{JC} = 2$ , this subject seems to evaluate the gamble preferences by preferential probability responses with respect to

the upper probability range bound, if probability differences are discriminated and else by preferential value responses with respect to the lower value range bound this subject discriminates the probability differences with respect to gamble (e) better than other probability differences. The discrimination probability pattern of gamble probabilities for this subject with adaptation-level shifts to midpoint sensations may be surprising, because one could expect that discrimination probabilities monotonically increase with the difference between gamble probabilities. This indeed may occur if no adaptation-level shifts are present. We can't derive a determined preference probability model without stimulus-dependent adaptation-level shifts and, thereby can't test the model without such shifts. However, the preference-probability patterns of two other individuals with oppositely ordered preference probabilities for adjacent gamble pairs and intransitive preference probabilities for remote ones, as shown below for subjects 3 and 6 (Tversky, 1969, p. 35), can't be explained without adaptation-level shifts to reversed range bounds as reference levels for their value and probability evaluations.

gamble	a	b	c	d	e
a		.75	.70	.60	.25
b			.80	.65	.40
c				.95	.80
d					1.00

Observed choice probabilities: sub}. 3

gamble	a	b	c	d	e
a		1.00	.90	.65	.20
b			.80	.75	.55
c				.90	.65
d					.75

Observed choice probabilities: sub}. 6

gamble	a	b	c	d	e
a		.61	.66	.58	.29
b			.66	.69	.41
c				.77	.79
d					1.00

Predicted choice probabilities: sub}. 3  
 $h_{Jc} = 2.0$ ,  $p_{jr} = p_{jo} = .468$ , and  $x_{jr} = 4.15$   
 $Chi^2 = 7.49$  with  $df = 7$  yields  $p \approx 0.30$

gamble	a	b	c	d	e
a		1.00	.89	.52	.37
b			.82	.77	.70
c				.70	.63

Predicted choice probabilities: sub}. 6  
 $h_{Jc} = 2.0$ ,  $P_{jr} = P_{jo} = .278$ , and  $x_{jr} = 4.84$   
 $Chi^2 = 11.39$  with  $df = 7$  yields  $p \approx 0.15$

gamble	a	b	c	d	e
a		.15	.34	.54	.75
b			.20	.46	.75
c				.32	.75
d					.73

Discrimination prob. of prob.: sub}. 3

gamble	a	b	c	d	e
a		.53	.63	.67	.69
b			.25	.38	.46
c				.16	.27
d					.12

Discrimination prob. of prob.: sub}. 6

Subjects 3 and 6 have also both maximum weight  $h_{Jc} = 2$ , whereby the actual significance of their Chi-squares for the model with  $h_{Jc} = 2$  as a priori value become for subject 3  $p \approx .50$  and for subject 6  $p \approx .20$  by  $df = 8$ , which means this model also fits rather well for these two individuals. The interesting difference between subjects 3 and 6 is that their reference levels  $P_{Jr}$  and  $x_{Jr}$  approach opposite range bounds of

respectively probabilities and values. Reference level  $P_{Jr} = .278$  of subject 6 is just below the lower range bound  $7/24 = 0.292$  for gamble (a) of the gamble probabilities, while subject 3 has reference level  $P_{Jr} = .468$  that just exceeds the upper probability-range bound  $11/24 = 0.458$  for gamble (e), similarly to subject 1 with  $P_{Jr} = .462$ . Thereby, subject 6 discriminates the gamble-probability differences with respect to the probability of gamble (a) better than the other gamble probability differences, while subject 3 discriminates gamble probabilities in almost the same way as subject 1 with respect to gamble (e). Also the reference level  $x_{Jr} = 4.84$  for gamble values of subject 6 almost equals the geometric midpoint for the upper values 4.75 \$ and 5.0 \$ of gambles (a) and (b), instead of the lower values 4.0 \$ and 4.25 \$ of gambles (d) and (e) for subject 3 with  $x_{Jr} = 4.15$  or subject 1 with  $x_{Jr} = 4.16$ . It not only explains why the preference probability order of adjacent gambles for subject 6 is the reversed order of subjects 3 and 1, but also explains why  $p_{a>b} = 1.00$  and  $p_{d>e} = .65$  for subject 6 and  $p_{a>b} = .61$  and  $p_{d>e} = 1.00$  for subject 3. Therefore, adaptation-level shifts to sensation midpoints and selected range bounds as reference levels for probability and value evaluations are present. The next table lists for the eight selected subjects in Tversky's (1969) study the parameters and the significance levels of the minimised Chi-squares from the fitted models with  $P_{Jr} = P_{Jo}$  and with different estimates of  $P_{Jr}$  and  $P_{Jo}$

subj.	model with $P_{Jr} = P_{Jo}$ df = 7					model with $P_{Jr} \neq P_{Jo}$ df = 6					
	$h_{Jc}$	$p_{Jr} = p_{Jo}$	$x_{Jr}$	Chi <sup>2</sup>	p	$h_{Jc}$	$p_{Jr}$	$p_{Jo}$	$x_{Jr}$	Chi <sup>2</sup>	p
1	2.00	.462	4.16	7.75	.35	2.00	.467	.460	4.16	7.66	.28
2	2.00	.477	4.00	8.93	.25	1.90	.228	.421	4.19	7.31	.30
3	2.00	.468	4.15	7.49	.30	1.99	.446	.482	4.15	7.19	.34
4	2.00	.461	4.09	19.58	<.01	1.93	.279	.419	4.18	3.28	.80
5	1.80	.485	3.92	16.45	<.025	1.99	.118	.380	4.48	2.11	.91
6	2.00	.278	4.84	11.39	.15	2.00	.481	.286	4.84	7.90	.24
7	0.10	.382	3.53	2.67	.91	0.10	.382	.385	3.52	2.66	.85
8	<u>0.05</u>	<u>.439</u>	<u>3.61</u>	<u>0.70</u>	<u>&gt;.995</u>	<u>0.21</u>	<u>.440</u>	<u>.403</u>	<u>3.80</u>	<u>0.60</u>	<u>&gt;.99</u>

Results of 3- and 4-parameter models with discrimination prob. of probabilities

The significantly too low Chi-square of subject 8 for the model with  $P_{Jr} = P_{Jo}$  implies that even the three-parameter model has too many parameters for this subject, which also may apply to subject 7. Since their weights  $h_{Jc}$  are close to zero, we fitted the model for evaluated value sensations only under shifts to value midpoint sensations. The Chi-squares of subject 8 and 7 are respectively  $Chi^2 = 7.94$  and  $Chi^2 = 8.01$  with  $x_{Jr} = 5.23$  and  $x_{Jr} = 3.27$  as respectively reversed reference levels for their utility evaluations. Subjects 7 and 8 are two individuals with transitive preference probabilities and lexicographic semi-order violations, but their different preference probabilities are well predicted solely by utility evaluations with only one estimated parameter, because their Chi-square significance levels are just above  $P = .50$  for  $df = 9$ . The Chi-squares of subjects 1, 2, 3, and 6 for the model with different values  $P_{Jr}$  and  $P_{Jo}$  are not significantly lower than for the more parsimonious model with  $P_{Jr} = P_{Jo}$  and wherein these four subjects have all maximum weight  $h_{Jc} = 2$ . Thereby, they evaluate gamble preferences only by gamble probabilities i(Cgamble-probability differences are

discriminated and else only by gamble values. Thus, for these four subjects the model actually is a two-parameter model with  $df = 8$ , whereby the Chi-square significance of the model with  $P_{Jr} = P_{Jc}$  ranges around  $p = .45$  for subjects 1, 2 and 3, while for subject 6 the Chi-square significance becomes  $p \approx .20$ . For subjects 4 and 5 the model with different values  $P_h$  and  $p_{Jc}$  fits significantly better than with  $P_{Jr} = P_{Jc}$ , but their weights  $h_{Jc} = 1.93$  and  $h_{Jc} = 1.99$  differ not significantly from  $h_{Jc} = 2$ , as shown in the next tables by their predicted preference probabilities with  $h_{Jc} = 2$ , where we present their observed and predicted preference probabilities and lastly their discrimination probabilities of gamble probability differences.

gamble	a	b	c	d	e
a		.50	.45	.20	.05
b			.65	.35	.10
c				.70	.40
d					.85

Observed choice probabilities: sub). 4

gamble	a	b	c	d	e
a		.53	.42	.21	.07
b			.60	.43	.15
c				.58	.26
d					.83

Predicted choice probabilities: sub). 4  
 $plr = .275$ ,  $Plc = .121$ , and  $xlr = 4.16$   
 $Chi^2 = 4.85$  with  $df = 7$  yields  $p \approx 0.70$

gamble	a	b	c	d	e
a		.20	.46	.73	.94
b			.31	.72	.98
c				.68	1.00
d					.85

Discrimination prob. of prob.: subj 4

gamble_a	b	c	d	e
a	.75	.65	.35	.60
b		.80	.55	.30
c			.65	.65
d				.70

Observed choice probabilities: sub). 5

gamble	a	b	c	d	e
a		.72	.72	.47	.42
b			.78	.46	.45
c				.68	.68
d					.70

Predicted choice probabilities: sub). 5  
 $plr = .008$ ,  $Plc = .373$ , and  $xlr = 4.55$   
 $Chi^2 = 7.24$  with  $df = 7$  yields  $p \approx 0.10$

gamble	a	b	c	d	e
a		.34	.78	.99	1.00
b			.80	1.00	.99
c				.72	.74
d					.31

Discrimination prob. of prob.: sub). 5

The Chi-squares of subjects 4 and 5 have acceptable significance levels for  $df = 7$  of this three-parameter model. Subject 5 seems to evaluate the gambles in a psychophysical way, because reference level  $PJ \approx .373$  for probability discrimination virtually equals midpoint  $9/24 = .375$  of the probability range and reference level  $x_{Jr} = 4.55$  for values also equals almost midpoint 4.5 of the value range, where the reference level  $PJ \approx .008$  will be the absolute threshold for probability perception. The preference and probability-difference evaluations of the subjects 1, 2, 3, and 6 are more cognitive, because their reference levels relate to the upper or lower range bounds of probabilities and values. Also the levels  $PJ = .275$  and  $x_{Jr} = 4.16$  of subject 4 are close to the lower range bounds of probabilities and values, but the reference level  $PJ \approx .421$  has no special cognitive or psychophysical meaning.

In the preliminary exploration for Tversky's (1969) study only eight subjects out of eighteen showed intransitive preference rank orders and only subjects 1 to 6 out of the eight selected subjects for the actual study showed intransitive preference probabilities, while subjects 2, 5, 7, and 8 also show some violations of the lexicographic semi-order rule that only for subject 8 were significant. If also the probabilities had been given as numerical values then no discrimination probability of probability differences applies, but if stimulus-dependent shifts of adaptation level are present then still some intransitivity of preference probabilities can occur. As discussed above, our psychophysical response theory for monotone valences predicts no intransitive preference orders, due to the additive model for ideal axis sensations of preferential responses. Only adaptation level shifts and/or discrimination probabilities of hardly perceivable probability differences define an additive difference model for ideal axis sensations and then not only can predict intransitive preference orders, but also violations of the lexicographic semi-order for Tversky's (1972) elimination-by-aspects theory. We have assumed that subjects have no single-peaked valences for risk appreciation with respect to an ideal risk level  $qJ'$  but preference evaluations on the basis of monotone valences for gamble values and single-peaked risk valences for gamble probabilities with ideal risk level  $qJ$  and  $P_{JO} = qJ$  for discrimination probability of gamble probabilities constitute an alternative, parsimonious model that fits better for some subjects, as shown in the sequel.

*Portfolio theory of subjective expected utility and risk*

The portfolio theory of Coombs (1967, 1972, Coombs and Huang, 1970) assumes that choices with uncertain outcomes are described by the subjectively expected values and a single-peaked valence function for risks that depend on the subjective distance between the objective probability and an ideal probability. Several studies show evidence for the existence of an ideal risk level. In the study of personality traits individual ideal risk levels has been characterised by a 'sensation seeking' trait with bio-social determinants (Zuckennan, 1994). Coombs and Pruitt (1960) originally modelled this single-peaked risk as monotone function of variances  $p_i(1-p_i)$  for gamble pairs (i,j) with  $p_i = 1-p_j$  and zero expected values  $p_i x_i + (1-p_i)x_j = 0$ . The analysis of preference data of 99 undergraduates in the study of Coombs and Pruitt showed that a large minority of students also may show appreciation for higher gamble probability variances  $p_i(1-p_i)$ . Also Tversky (1967, p.199) concluded from several studies that

*"although utilities and subjective probabilities were additive and subjective probabilities were commodity-invariant, utilities were not risk-invariant"*,

We may formulate Coombs' portfolio theory by our psychophysical response and valence theory as preferences for uncertain choice alternatives that are defined by a mixed valence space of two dimensions: one for the monotone valences for expected values of gamble alternatives and one for the single-peaked risk valences for their probabilities. However, we rather liberalise that formulation to a three-component model for a two-dimensional mixed valence space: one ideal preference response axis  $r_{Jj}$  as rotational combination of the two monotone valence dimensions - one for comparable certainty sensations  $s_{J'}$  and one for comparable value sensations  $s_{J''}$  - and a single-peaked risk valence dimension  $v_{Jj}$  for valence-comparable certainty sensation distances to an individual, ideal risk probability. We conjecture that the portfolio model

under the reformulation by this three-component model for a two-dimensional, mixed valence space will empirically hold. Our three-component portfolio model is a mixed valence model (see sections 5.3.1. and 5.4.4.) that is defined by the earlier specified monotone valences  $r_{Ji}$  as ideal response axis and by single-peaked valences  $v_{Ji}$  for valence-comparable certainty sensation distances to ideal risk level  $q_j$  with comparability weights  $\tau_{Ji}$  defined by  $\tau_{Ji} = \frac{1}{\ln\left(\frac{z_j}{h_j}\right) + 1}$  as the reciprocal sensation distance between ideal certainty stimulus  $z_j = q_j/(1-q_j)$  and certainty-adaptation level stimulus  $z_j = P_j/(1-P_j)$ . The hyperbolic tangent-based, single-peaked valences are defined for comparably weighted distance

$$v_{Ji} = \frac{\tau_{Ji} \cdot d_j}{d_j + 1} = \frac{\ln\left(\frac{p_j}{1-p_j}\right) / \ln\left(\frac{q_j}{1-q_j}\right)}{\ln\left(\frac{p_j}{1-p_j}\right) / \ln\left(\frac{q_j}{1-q_j}\right) + 1}$$

for hyperbolic and Euclidean valence-comparable certainty sensation distances from the ideal risk sensation level, while for arctangent-based valences and Euclidean, valence-comparable certainty sensation distances we have.

$$v_{Ji} = \arctan\left(1 - \frac{d_j}{d_j + 1}\right) \cdot \arctan\left(1 + \frac{d_j}{d_j + 1}\right).$$

Combining single-peaked certainty evaluations with the monotone valences of ideal response axis  $r_{Ji}$  for dependent dimensions of comparable certainty and value sensations, we have a three-component portfolio model for gamble valences in a two-dimensional mixed valence space (see: subsections 5.3 and 5.4.4.), as obtained by

1. individual ideal axes with rotation parameters  $h_{Jc}$  and  $h_{Jx}$

$$r_{Ji} = \tanh\left[h_{Jc} \cdot \frac{1}{2} s_{Jic} + h_{Jx} \cdot \frac{1}{2} s_{Jix}\right]$$

or  $r_{Ji} = \arctan\left[h_{Jc} \cdot s_{Jic} + h_{Jx} \cdot s_{Jix}\right]$

where  $s_{Jic} = \frac{-\ln\left[\frac{p_j}{1-p_j}\right] \ln\left[\frac{p_j}{1-p_j}\right]}{\ln\left[\frac{p_j}{1-p_j}\right] + \ln\left[\frac{p_j}{1-p_j}\right]}$

and  $s_{Jix} = \frac{2 \cdot \ln(x_j/x_j)}{\ln(x_j/x_j)}$

- where  $h_{Jc} \geq 0$  and  $h_{Jx} \geq 0$ , while  $h_{Jc}^2 + h_{Jx}^2 = 1$  for independent probabilities and values and if completely dependent then  $h_{Jc} + h_{Jx} = 2$ , else  $1 < h_{Jc} + h_{Jx} < 2$ ,
2. and single-peaked valences

$$v_{Ji} = \tanh\left[\frac{1}{2} \ln\left\{\frac{\cosh(d_j/d_j)}{\cosh(1)}\right\}\right]$$

for hyperbolic or Euclidean valence-comparable certainty sensation distances or

$$v_{Ji} = \arctan\left(\frac{d_j}{d_j + 1}\right) \cdot \arctan\left(\frac{d_j}{d_j + 1} + 1\right)$$

for Euclidean, valence-comparable certainty sensation distances.

Dimensions  $r_{Ji}$  and  $v_{Ji}$  define a mixed valence space, wherein the vectorial valences are determined by their additively combined valence dimensions. If  $r_{Ji}$  and  $v_{Ji}$  are not fully dependent then the mixed valence space is a two-dimensional, open Finsler space, because if ideal response axis  $r_{Ji}$  is open-Euclidean then single-peaked valence dimension  $v_{Ji}$  is open-hyperbolic with curvature  $\zeta = -1/2$  and if the ideal response axis  $r_{Ji}$  is open non-Euclidean then the single-peaked valence  $v_{Ji}$  is an open Finsler dimension with absolute curvatures that decrease with increasing distances  $d_j/d_j$ , as



shown in chapter 5. Since the monotone and single peaked valences for certainty sensations depend on the same gamble probabilities, we also can combine by individual weights the monotone and single-peaked valence functions to one asymmetrically single-peaked function of certainty sensations. Thus, due to the two-dimensional valence space the three-component portfolio model is equivalently described by monotone utility for value sensations and an asymmetrically single-peaked risk valence for certainty sensations. For hyperbolic tangent-based valences we can define the weighted combinations of monotone and single-peaked certainty valences by the preferential response to the correspondingly weighted combination of the signed certainty sensations  $s_{Jic}$  and the term  $\ln[\cosh(1)/\cosh(dJ/d_J)]$  for hyperbolic or Euclidean certainty-sensation distances  $d_{Ji}/d_J$  to the ideal point with  $d_{Ji}/d_J = 1$  as normalised distance between the adaptation and ideal points, which weighted combination is defined for weight  $I \geq w_J \geq 0$  by

$$\text{whereby } s_{Jiv} = (1 - w_J) \cdot s_{Jic} + w_J \{ \ln[\cosh(1)/\cosh(dJ/d_J)] \}$$

$$t_{Ji} = \tanh[h_{Jv} \cdot s_{Jiv} + h_{Jx} \cdot s_{Jix}]$$

define the mixed valences  $t_{Ji}$  by possibly oblique rotation weights or even completely dependent weights  $h_{Jv}$  and  $h_{Jx}$ . If we assume that subjects have individual adaptation levels  $x_{Ja}$  and  $P_{Ja}$  as well as individual reference levels  $x_{Jr}$  and  $P_{Jr}$  for the monotone valence components of value and certainty sensations then we have to estimate maximally eight parameters per individual, because we also have two possibly oblique, positive rotation parameters  $h_{Jv}$  and  $h_{Jx}$  as well as weight parameter  $w_J$  and ideal probability  $q_J$  for the single-peaked risk component. Assuming positive rotation parameters for appreciated risk and value sensations, then the possibly negative correlation  $P_J$  between sensations  $s_{Jiv}$  and  $s_{Jix}$  determines  $h_{Jx} = \sqrt{1 + \rho_J^2 - h_{Jv}^2}$ . If correlation  $P_J = -1$  for fully dependent probabilities and values then  $h_{Jx} + h_{Jv} = 2$  and if also  $x_{Ja} = x_{Jr}$  and  $P_{Ja} = P_{Jr}$  then also  $p_{Ja} = p_{Jr}$  and  $x_{Jr} = x_{Ja}$  will be dependent on the gamble set and thus common. However, if we assume not that  $\tau = 1$  and also not that  $\tau$  is known then the model requires the estimation of  $3N + 4$  parameters for  $N$  individuals. It reduces to a model with  $2N$  parameters less if no single-peaked risk valences exist or if monotone certainty valences are ignored, while if only single peaked valences determine the preferences then the solution only requires  $N$  parameters for the individual ideal risk levels  $q_{Jr}$ . For  $N$  individuals and  $n$  gamble alternatives in a study on the preference order between all alternative pairs we have  $Y2n(n-1)N$  preference inequalities, whereby the parameters of the mixed valences are solvable, provided that  $1/20(0 - 1)N > 8N + 2$ , which is satisfied for  $n \geq 5$ .

Preference probabilities for gamble alternatives with probabilities  $p_i$  and values  $x_i$  and stimulus-dependent adaptation-level shifts to sensations of target gamble  $j$  in (i-over-j)-preferences or to the midpoint sensations of gambles  $i$  and  $j$  in (i-or-j)-preferences may allow an analysis of preference probabilities by our three-component portfolio model, provided that we can also validly define preference probabilities for pairs of objects with single-peaked valences. As shown in the next subsection, preference probabilities  $p_{Ii|j}$  or  $p_{Jj|i}$  for objects with single-peaked valences are defined by conditional similarity probabilities with respect to the ideal risk point under stimulus-dependent adaptation-level shifts. Thereby, we can specify a preference

probability expression for the three-component portfolio model by the probability transfunction of the preferential response to a weighted combination of signed value and certainty sensations for the monotone value and certainty valences and a distance-difference term of sensation distances to the ideal point for the single-peaked risk valences. That distance-difference term depends on the sensation geometry and the response function and concerns distances to ideal risk  $z_{Jq} = q_J/(1-q_J)$  for ideal probability  $q_J$ . Under adaptation-level shifts to certainty midpoint  $lo(z_{..}) = 1/2 \ln(z_{..})$  we have

$$d_{Jij} = |\ln(z_i/z_{Jq})| = |1/2 \ln(z_i/z_{Jq}) + \ln(z_i/z_{Jq})|/2 = (d_{Ji} + d_{Jq})/2$$

as distance between the shifted adaptation level and the ideal risk level, while distances  $d_{Ji} = |\ln(z_i/z_{Jq})|$  and  $d_{Jq} = |\ln(z_{Jq}/z_{Jq})|$  are the distances between the certainty sensations of alternatives with probability  $p_i$  and  $p_q$  to the ideal risk level  $q_J$ . As shown in the next subsection, the conditional similarity-probability expression for valence-comparable sensation distances to ideal risk level  $\ln(q_J)$  under adaptation-level shifts to midpoint sensations  $\ln(z_{..})$  defines the risk sensation for hyperbolic tangent- and arctangent based valences by Euclidean sensation-distance difference

$$q_{Jij} = 1 - d_{Jij}/d_{Jij}$$

and for hyperbolic tangent-based valences of hyperbolic sensation spaces by

$$q_{Jij} = \ln[\cosh(1)/(\cosh(d_{Jij}/d_{Jij}))]$$

We can add the monotone certainty and single-peaked risk sensation components by weight  $(1-w_J)$  for certainty sensations and weight  $w_J$  for risk sensations  $q_{Jij}$  whereby

$$s_{JIV}lij = (1 - w_J) \cdot 2 \cdot \ln(z_i/z_{Jq}) |\ln(z_i/z_{Jq})| + w_J \cdot q_{Jij}$$

Notice that if  $d_{Ji} < d_{Jq}$  then gamble probability  $p_i$  is closer to ideal risk level  $q_J$  than gamble probability  $p_q$ , whereby then  $s_{JIV}$  increases and else  $s_{JIV}$  decreases by the additional term  $q_J$  for the sensation component of single-peaked risk valences.

The three-J6mponent model for the analysis of the preference probabilities in Tversky's (1969) study becomes then written by

$$P_{Jir}lij = \{1 + \tanh[w_{JIC} \cdot s_{JIV}lij + (2 - w_{JIC}) \cdot \ln(x_i/x_{Jq}) |\ln(x_i/x_{Jq})|]\}^{1/2}$$

for hyperbolic tangent-based valences of Euclidean or hyperbolic sensation spaces with respectively  $q_{Jij}'' = 1 - d_{Jij}/d_{Jij}$  or  $q_{Jij}'' = \ln[\cosh(1)/(\cosh(d_{Jij}/d_{Jij}))]$ , while

$$P_{Jir}lij = \{1 + \arctan[w_{JIC} \cdot s_{JIV}lij + (2 - w_{JIC}) \cdot 2 \cdot \ln(x_i/x_{Jq}) / |\ln(x_i/x_{Jq})|] / (\sqrt{m})\}^{1/2}$$

defines the preference probability for arctangent-based valences of Euclidean sensation spaces with  $q_{Jij}'' = d_{Jij}/d_{Jij}$ . Here again weights  $w_{JIC} = h_J : P_{Jir}lij$  and  $(2 - w_{JIC})$  are defined by fully dependent certainty and value weights  $h_{Jcc} + h_{Jx} = 2$  and respectively

or 
$$P_{Jic}lij = \tanh[|\ln(z_i/z_{Jq})| |\ln(z_{Jq}/z_{J0})|]$$

$$P_{Jic}lij = \arctan[2 \cdot |\ln(z_i/z_{Jq})| / |\ln(z_{Jq}/z_{J0})|] / (\sqrt{2\pi})$$

as the two earlier empirically sustained expressions of the three permissible expressions for the discrimination probabilities of certainty sensation differences, where they here

define the probabilities that certainty and risk sensations are used. The three-component portfolio model requires that we estimate the six parameters of reference probabilities  $P_{Jr}$  and  $P_{Jo}$ , ideal risk  $qJ$ , reference level  $x_{Jr}$ , and component weights  $h_{Jc}$  and  $w_J$ . However, we may assume that either  $P_{Jr} = qJ$  or  $P_{Jr} = P_{Jo}$  holds, where  $y$  we then have a five-parameter model, but if also  $w_J = 1$  or  $w_J = 0$  then we have a two-component model for monotone value and single-peaked risk valences or for monotone value and certainty valences with three parameters  $qJ = P_{Jr} \cdot x_{Jr}$  and  $h_{Jc}$  or  $P_{Jr} = P_{Jo} \cdot x_{Jr}$  and  $h_{Jc}$ , while we have one parameter fewer if weight  $w_J$  is set to  $h_{Jc} = 2$ . We initially fitted the three-component model with six parameters by the arctangent-based model (Euclidean sensation spaces) and by the two hyperbolic tangent-based models (either Euclidean or hyperbolic sensation spaces) for subjects 1 to 6 in Tversky's (1969) study, because subjects 7 and 8 use the one-component model for utility only, as shown earlier. The arctangent-based model and the hyperbolic tangent-based model both with Euclidean risk term  $q_{Jij} = 1 - d_{Jij}$  must be rejected ( $p < .005$  with  $df = 24$  for totals of individual Chi-squares). Only the hyperbolic tangent-based model with risk term  $q_{Jij} = \ln[\cosh(1)/(\cosh(d_{Jij}))]$  for hyperbolic sensation spaces yields an acceptable significance level  $p = .15$  with  $df = 24$  for the total  $Chi^2 = 31.05$  of individual Chi-squares. All individual Chi-squares of the latter model are closer to the expected Chi-square at  $p = .50$  and for subject 4 significantly closer than for the two other three-component models. Moreover, the estimated parameter  $h_{Jc}$  equals or closely approaches maximum  $h_{Jc} = 2$  for the certainty component and the weight  $w_J$  equals or closely approaches either minimum  $w_J = 0$  or maximum  $w_J = 1$  for each subject. By  $h_{Jc} = 2$  and  $w_J = 1$  or  $w_J = 0$  as a priori model parameters the degrees of freedom of the total Chi-square increases to  $df = 36$ , whereby its significance level would be close to  $p = .50$ , if the constraint models hardly increases the Chi-square total. Therefore, we again fitted the model by setting a priori model parameter  $w_J$  to  $w_J = 1$  or  $w_J = 0$  and model parameter  $h_{Jc}$  to maximum  $h_{Jc} = 2$ , while also versions for either  $P_{Jr} = P_{Jo}$  (if  $w_J = 0$ ) or  $qJ = P_{Jo} \cdot c$  (if  $w_J = 1$ ) are fitted. In the table below we give the results of the estimated parameters under adaptation-level shifts to midpoint sensations and minimisation of the Chi-square for the six subjects. Cursive figures specify the a-priori model parameters, whereby the three-component model reduces to a two-component model that equals by  $w_J = 0$  and  $h_{Jc} = 2$  the model for monotone value and certainty valences without or with constraint  $P_{Jr} = P_{Jo}$  or specifies by  $w_J = 1$  and  $h_{Jc} = 2$  another two-component model for monotone value and single-peaked risk valences with additional constraint  $qJ = P_{Jo}$ .

subj.	$h_{Jc}$	$w_J$	$P_{Jr}$	$P_{Jr} = P_{Jo}$	$P_{Jo}$	$qJ = P_{Jo}$	$x_{Jr}$	Chi <sup>2</sup>	df	p
1	2	0		.462			4.16	7.75	8	.46
2	2	1				.501	3.97	7.92	8	.44
3	2	0		.468			4.15	7.49	8	.48
4	2	1				.474	4.06	7.28	8	.51
5	2	0	.008		.373		4.55	7.24	7	.040
6	2	0	.481		.286		4.84	7.90	7	.35

*Results of two-component models with adaptation-level shifts, discrimination probability of gamble probabilities, two a-priori and some constraint parameters.*

Subjects 1, 3, 5 and 6 have  $w_J = 0$  and  $h_{JC} = 2$ , whereby their three-component model reduces to the earlier fitted two-component for monotone value and certainty valences (no significant contribution of the risk component). Thus, these four subjects most likely use the two-component model for monotone value and certainty valences, where by  $h_{JC} = 2$  only the value component is used in case the gamble probabilities are not discriminated and else only the certainty component. The model fit with  $PJ = p_{Jo}$  for subjects 1 and 3 only yields slightly higher Chi-squares than the earlier fitted two-component model for monotone utility and certainty valences with different parameters  $PJ$  and  $PJ_r$ , whereby they have only two estimated (similar) parameters with a cognitive meaning ( $x_{Jr} = 4.16$  or  $4.15$  and  $PJ = p_{Jo} = .462$  or  $.468$  approaches respectively the lower and upper range bounds of value midpoints and probabilities). The three-component model for subjects 5 and 6 reduce to a two-component model for monotone value and certainty valences with three estimated parameters, where the parameters have a psychophysical meaning for subject 5 (since  $PI = .373$  and  $x_{Jr} = 4.55$  are probability and value range midpoints and  $PJ_r = .008$  likely is the absolute perception threshold for probability) and a cognitive meaning for subject 6 (since  $PI = .281$  and  $p_{Jr} = .481$  respectively approach the lower and upper bounds of the probability range and  $x_{Jr} = 4.84$  approaches the upper range bound for value midpoints). The three-component model of subjects 2 and 4 reduces to the two-component model for monotone value and single-peaked risk valences with  $q_J = p_{Jo}$  (no significant contribution of the certainty component and no significant contribution of different parameters), while one intuitively would also expect that ideal risk level  $q_J$  also determines the reference level  $PI$  for the discrimination of gamble probabilities. Below we give their predicted preference probabilities by that two-component model.

gamble_a	b	c	d	e	gamble_a	b	c	d	e
a	.54	.50	.34	.11	a	<b>.54.53.44.25</b>			
b		.56	.47	.15	b		.56	.54	.36
c			.69	.29	c			.60	.54
d				.84	d				.77

Predicted choice probabilities: subj. 4

( $h_{JC} = 2, w_J = 1$ )  $q_J = p_{Jo} = .474, x_{Jr} = 4.06$

$Chi^2 = 7.28$  with  $df = 8$  yields  $p \approx 0.51$

Predicted choice probabilities: subj. 2

( $h_{JC} = 2, w_J = 1$ )  $q_J = p_{Jo} = .501, x_{Jr} = 3.97$

$Chi^2 = 7.92$  with  $df = 8$  yields  $p \approx 0.44$

Their earlier fitted two-component model for monotone value and certainty valences fits also rather well (for subject 2 the respective significance levels are  $p \approx .35$  for the model with  $df = 8$  and  $p \approx .30$  for the model with  $df = 6$ , while for subject 4 the significance levels are  $p \approx .70$  for the model with  $df = 7$  and  $p \approx .80$  for the model with  $df = 6$ ). Nonetheless, the two-component model for monotone value and single-peaked risk valences for subjects 2 and 4 with  $q_J = p_{Jo}$  is more or equal parsimonious ( $df = 8$ ) and their Chi-squares with  $p \approx .44$  or  $p \approx .51$  more closely approaches the expected Chi-square at  $p = .50$  than the two-component model for monotone value and certainty valences. Therefore, subjects 2 and 4 most likely use the two-component model for monotone value and single-peaked risk valences, where only the value component only is used if the gamble probabilities are not discriminated and else only the risk

component. Moreover, the hyperbolic tangent-based two-component model for monotone value and single-peaked risk valences with the risk-evaluation component  $q_{jij} = \ln[\cosh(1)/\cosh(d_j/d_j |ij)]$  for hyperbolic sensations fits significantly better than the hyperbolic tangent- or arctangent-based model with the risk-evaluation component  $q_{jij} = 1 - d_j/d_j |ij$  for Euclidean sensations of these two subjects with estimated parameters  $q_j = PJ$  and  $x_j$ . For subject 4 the observed preference probabilities are presented earlier, but not for subject 2. Below we give the observed preference probabilities of subject 2, where cursive figures concern lexicographic semi-order violations and bold figures again intransitive probabilities.

gamble	a	b	c	d	e
a		.40	.65	.50	.25
b			.70	.40	.35
c				.75	.55
d					.75

*Observed choice probabilities: sub). 2*

In summary: we derive from our psychophysical response and valence theory a metric three-component model for the prediction of gamble preference probabilities and dissimilarity probabilities for the discrimination of hardly perceivable gamble-probability differences. For six individuals out of the eight subjects in Tversky's (1969) study the model reduces to a well-fitting two-component model, while the model reduces for two subjects 7 and 8 to a well-fitting one-component model for monotone value valences with only one estimated parameter. For four subjects the two-component model concerns the model monotone utility and certainty valences with either two estimated parameters (subjects 1 and 3) or three estimated parameters (subjects 5 and 6) and for two subjects the two-component model concerns the model for monotone value and single-peaked risk valences with two estimated parameters (subjects 2 and 4). The ideal risk level is by definition a cognitive reference parameter and the estimated parameters for value and certainty evaluations are also cognitively selected reference levels that relate to upper or lower range bounds of gamble values and probabilities, except for subject 5, while subjects 8 and 7 select for their only value-dependent preferences cognitive reference levels that are respectively located above the upper and below the lower bound of the value range. Only subject 5 seems to use psychophysical parameters as value and probability range midpoints and an absolute just noticeable probability level. More important than these revealed differences between individuals may be that the arctangent- and hyperbolic tangent-based two-component models for monotone value and single-peaked risk valences with Euclidean risk-sensation component  $q_{jij} = 1 - d_j/d_j |ij$  yield significantly higher Chi-square totals than that hyperbolic tangent-based model with hyperbolic risk-sensation component  $q_{jij} = \ln[\cosh(1)/\cosh(d_j/d_j |ij)]$  for the two individuals that use the single-peaked risk component. It might give some empirical evidence for the hyperbolic geometry of sensation spaces and the Euclidean geometry of the stimulus space, while these geometries might theoretically be assumed to hold for the restricted stimulus-intensity range of human perception. The predicted preference probabilities fit quite well the

observed preference probabilities for gambles with hardly perceivable probability differences and completely negative-dependent values and probabilities, where the observed preference probabilities are transitive or intransitive and/or violate the lexicographic semi-order rule. Therefore, our three-component portfolio model of gamble preference probabilities under stimulus-dependent adaptation-level shifts (and discrimination probabilities if gambles have hardly perceivable probability differences) seems more valid than

- any expected utility model,  
any existing subjective expected utility model,
- Coombs' portfolio model, and
- Tversky's additive difference model or elimination-by-aspect model.

#### 7.4.3. Dynamic relativity of preferences with single-peaked valences

Referring to sections 5.2.1. and 5.4.3., the single-peaked valences under adaptation-level shifts towards dimensional midpoints of objects  $i$  and  $j$  in (i-or-j) preference tasks become redefined by sensation space adaptation point of individuals that are shifted to  $a_{ij} = (y_i + y_j)/2$  as midpoint sensation for simultaneously presented choice objects  $i$  and  $j$ , while  $g_j$  remains the fixed ideal sensation space point if no reinforcements are obtained from choices, and then are defined for

$$\text{by } d_{JI} = |a_{ij} - g_J| \quad \text{and} \quad d_{Jj} = |y_i - g_J|$$

$$v_{Jij} = \tanh[-1/2 \ln \{ \cosh(d_J/d_{Jij}) \cosh(1) \}]$$

for valence-comparable, hyperbolic or Euclidean sensations of respectively Euclidean or hyperbolic stimuli and for valence-comparable Euclidean sensations of elliptic stimuli by

$$v_{Jij} = \arctan[1 - d_J/d_{Jij}] - \arctan[1 + d_J/d_{Jij}].$$

In (i-over-j) preference tasks the adaptation level may shift to the sensation of object  $j$ , whereby by  $a_j = y_j$ , while  $g_J$  remains the static ideal sensation space point if no reinforcements are obtained from choices. For complete adaptation to object  $j$ , thus for shifts of  $a_j$  to  $a_j = y_j$ , the hyperbolic tangent-based, single-peaked valences for unidimensional hyperbolic or Euclidean sensation scales is written by

$$\text{which for } v_{Ji|j} = \tanh[-Y/2 \ln \{ \cosh(Y_i - g_J) \cosh(a_j - g_J) \}]$$

$$\text{becomes } z_{Ji|j} = \cosh(a_j - g_J) / \cosh(Y_j - g_J) \quad \left| \begin{array}{l} a_j = a_j = y_j \\ \end{array} \right.$$

$$v_{Ji|j} = (z_{Ji|j} - 1) / (z_{Ji|j} + 1).$$

We remark that  $1/z_{Ji|j}$  relates to the hyperbolic cosine model for the unfolding of polytomous responses for object  $i$  on rating scales (Andrich, 1996) or for the unfolding of dichotomous responses (Andrich and Luo, 1993). In the hyperbolic cosine model the argument  $|a_j - g_J|$  concerns rating category boundary distances  $a_j$  to  $g_J$  as folding point of the rating scale for individual  $J$ , while the argument  $|y_i - g_J|$  concerns the folded rating category position of object  $i$  by individual  $J$ . The difference between the hyperbolic cosine model and our single-peaked valences not only is a matter of parameter interpretation, but also that we measure  $v_{Ji|j}$  as valences on an open-hyperbolic or Finsler dimension with  $a_j$  as shifting locations for zero valence, where

the hyperbolic cosine model measures  $z_{ji}$  as ratings for hyperbolic cosine-transformed distances to  $g_j$  on a rating scale with category boundaries  $a_j$ . Only for open Finsler valence dimensions the hyperbolic cosine-transformed distances specify Euclidean rating scales. Since an open-hyperbolic valence dimension corresponds to a hyperbolic sensation dimension, the hyperbolic cosine model for the unfolding of rating scales may imply that rating scales are hyperbolic, which seems not recognised by Andrich and co-teachers. The hyperbolic cosine model is derived (Andrich, 1982; Wright and Masters, 1982) from the probabilistic Rasch model (Rasch, 1960, 1966a; Stene, 1968) for dichotomous (or polytomous) responses. In the dichotomous Rasch model the probability

$$P_{ji} = 1/[1 + \exp(Y_i - a_j)]$$

is interpreted as the probability that individual  $J$  with capacity  $a_j$  gives the correct answer to item  $i$  with item difficulty  $y_i$ . It equals the logistic discrimination probability for Fechner-Helson sensations if  $y_i$  is a Fechner sensation and  $a_j$  the individual adaptation level. In order to show the relationship with single-peaked valences, we replace  $y_i$  by distances  $|y_i - g_j| = d_{ji}$  and  $a_j$  by distance  $d_j = |a_j - g_j|$  and weigh for comparability of sensation distance by  $d_j$ , where term  $\exp(d_{ji}/d_j - 1)$  concerns either exponents for weighted Euclidean distances  $d_{ji}/d_j$  or Euclidean co-ordinate values of, weighted hyperbolic distances  $d_{ji}/d_j$  but for hyperbolic distances we directly write this as  $\cosh(d_{ji}/d_j)/\cosh(1)$ . In both cases the redefined Rasch model probabilities become similarity probabilities as logistic function of weighted distances  $d_{ji}/d_j$  with respect to ideal points  $g_j$  at normalised distance from the adaptation point  $a_j$  as discussed earlier in subsections 7.2.2. and 7.2.4., where the hyperbolic tangent-based, conditional similarity probabilities concern here conditionally comparable sensation distances between  $y_i$  and ideal point  $g_j$ . For objects with hyperbolic tangent-based, single-peaked valences this indicates that their preference probabilities are derivable from conditional similarity probabilities  $p_{ji}$  for weighted distance  $d_{ji}/d_j$  with respect to distance  $d_j/d_j = 1$ . In subsection 7.2.4. we defined for hyperbolic sensation distances the biased similarity magnitude  $\beta_{ji} = v_{ji}/\cosh(d_{ji}/d_j)$  with similarity magnitude  $v_{ji} = 1/\cosh(2|y_i - y_j/a_j|) = 1/\cosh(2d_{ji}/d_j)$  and bias  $\beta_{ji} = \cosh(d_{ji}/d_j)/\cosh(d_{ji}/d_j)$ , where conditional similarity probability  $p_{ji}$  is defined by response  $r_{ij}$  to  $g_j$  conditional

$$\text{to } r_j = 0 \text{ as } p_{ji} = r_{ij} = (1 + r_{ij})/2 = 1/[1 + \cosh(d_{ji}/d_j)/\cosh(d_j/d_j)].$$

In the same way we define similarity magnitudes for hyperbolic sensation distances

$$z_j = 1/\cosh(d/d_j) = 1/\cosh(1) \quad \text{and} \quad Z_j = 1/\cosh(d_j/d_j),$$

where  $d_{ji}$  is the distance between sensations  $y_i$  and ideal point  $g_j$  and  $d_j$  the distance between adaptation level  $a_j$  and ideal point  $g_j$ . Since  $z_{ji}$  and  $Z_j$  are similarity magnitudes that satisfy the conditional choice axiom for similarities of hyperbolic sensation distances to the ideal point, we also may define conditional choice probabilities  $P_{ji}$  for  $z_{ji}$  with respect to  $Z_j$  as

$$P_{ji} = z_j/[Z_j + z_j] = 1/[1 + z_j/Z_j] = 1/[1 + \cosh(d_j/d_j)/\cosh(1)].$$

It defines quasi-responses

$$r_{ji} = 2p_{ji} - 1 = [1 - \cosh(d_j/d_j)]/\cosh(1) / [1 + \cosh(d_j/d_j)/\cosh(1)],$$

where quasi-response  $v_j$  equals the single-peaked valence for valence-comparable sensations  $y_j$

$$v_j = \tanh[-\frac{1}{2} \ln \{ \cosh(d_{ji}/d_j) / \cosh(1) \}]$$

Thereby

$$P_{ji} = (1 + v_j)/2 = \Pi [ 1 + \cosh(d_j/d_j) / \cosh(1) ]$$

defines by conditional probability  $p_{ji}$  whether sensation  $y_j$  is more or less similar to ideal point  $g_j$  than adaptation point  $a_j$  and, thereby, the probability whether object  $i$  is preferred over the neutral object that coincides with the adaptation point. Since multiplication of dimensional distance terms  $\cosh(d_{jik}/d_{jk})$  define space distance  $\cosh(d_{jj}/d_j)$ , we here have by

$$p_{ji} = \Pi [ 1 + \{ \prod_{k=1}^{k=n} \cosh(d_{jik}/d_{jk}) \} / \cosh(1) ] = \Pi [ 1 + \cosh(d_j/d_j) / \cosh(1) ],$$

a *hyperbolically multiplicative preference probability model* for the preference probability that objects with Euclidean stimulus attributes and hyperbolic sensations are preferred above the status quo as adaptation level. However, if the adaptation point is shifted to sensation point  $j$  then

$$v_{ji}|j = \tanh[-\frac{1}{2} \ln \{ \cosh(d_{ji}/d_j|j) / \cosh(1) \}],$$

where  $d_{ji}|j = d_{ji} - g_j$  and  $d_{ji} = |y_i - g_j|$  as conditional distances to centre point  $g_j$  define by the conditional probability  $p_{ji}|j$

$$P_{ji}|j = \Pi [ 1 + \cosh(d_j/d_j) / \cosh(1) ],$$

whereby

$$p_{ji}|j = (1 + v_{ji}|j)/2.$$

Thus, here the probability that  $y_i$  is more similar to  $g_j$  than  $y_j$  as shifted adaptation level also defines the preference probability that  $i$  is preferred over  $j$  in an (i-over-j)-preference task with stimulus-dependent adaptation-level shifts to sensation  $y_j$ . Thus, the here derived (i-over-j)-preference probability holds for single-peaked valences of valence-comparable, hyperbolic sensation distances  $\cosh(d_{ji}/d_j)$  to ideal points with shifted adaptation points to sensations of target stimulus or object  $j$ . Since multiplication of dimensional terms  $\cosh(d_{jik}/d_{jk})$  define space distance  $\cosh(d_j/d_j)$ , we here have for bias term

$$\beta_{ji}|j = \cosh(d_j/d_j) / \cosh(1)$$

by similarity magnitudes  $Z_{ji}$  and  $Z_j$  with respect to the ideal point

$$p_{ji}|j = \Pi [ 1 + \beta_{ji}|j \cdot (Z_j/Z_{ji}) ] = \Pi [ 1 + \cosh(d_j/d_j) / \cosh(1) ]$$

$$p_{ji}|j = \Pi [ 1 + \beta_{ji}|j \cdot \{ \prod_{k=1}^{k=n} \cosh(d_{jik}/d_{jk}) \} / \cosh(1) ] = \Pi [ 1 + \cosh(d_j/d_j) / \cosh(1) ],$$

a *hyperbolically multiplicative (i-over-j)-preference probability model with multiplicative compound bias* for preference evaluations of objects with Euclidean stimulus-like attributes. In case of (i-or-j)-preference comparisons with adaptation level shifts to midpoints  $a_{ij} = \frac{1}{2}(y_i + y_j)$  we have by

$$d_{ij} = |a_{ij} - g_j| = \frac{1}{2} |y_i - g_j + y_j - g_j| = \frac{1}{2} [d_{ji} + d_{jj}]$$



that  $y_i$  is more similar to  $g_j$  than  $y_j$  if distance  $d_{ji} < \frac{1}{2}[d_{ji} + d_{jj}]$ . Thus, in (i-or-j)-preferences with adaptation-level shifts to midpoint sensations the probability that  $i$  is preferred over  $j$  becomes for similarity magnitude  $z_j = 1/\cosh(d_{ji}/d_j) = 1/\cosh(1)$  also expressed by the conditional similarity probability with respect to the ideal point

where also 
$$P_{ji} | ij = z_{ji} / (z_{ji} + z_j) = 1/[1 + \cosh(d_{ji}/d_j)] / \cosh(1),$$
 Here bias 
$$P_{ji} | ij = (1 + \tanh^{-1} \{ \cosh(d_{ji}/d_j) / \cosh(1) \}) / 2.$$

$$\beta_{ji} | ij = \cosh(d_{ji}/d_j) / \cosh(d_j)$$

and dimensional similarity magnitudes  $I_{jik} = 1/\cosh(d_{jik}/d_{jk})$  define by

$$P_{ji} | ij = 1/[1 + \beta_{ji} | ij \cdot \prod_{k=1}^{k=m} (z_j / z_{jik})] = 1/[1 + \cosh(d_{ji}/d_j) / \cosh(0)]$$

a hyperbolically multiplicative (i-or-j)-preference probability model with multiplicative compound dual bias.

Our psychophysical valence theory (see: chapter 5) defines the single-peaked valences of objects with non-Euclidean attribute spaces and Euclidean sensation spaces by

$$v_{ji} = \tanh[-\gamma \ln(\cosh(d_j/d_j) / \cosh(1))]$$

or

$$v_{ji} = \arctan(1 - d_j/d_j) \cdot \arctan(1 + d_j/d_j).$$

Since these single-peaked valence spaces are open Finsler spaces, their valences can't be transformed to preference probabilities. However, if (i-over-j) preference probabilities are defined by the probability that distance  $d_{ji} = |y_j - g_{ji}|$  is smaller than distance  $d_{jj} = |y_j - g_{jj}|$  under adaptation-level shifts to the sensation of target object  $j$ , whereby  $d_{jj} = d_{ji}$ , then the conditional similarity probability would define (i-over-j) preference probability by

$$P_{ji} | j = \{1 + \tanh[-\gamma \ln(d_{ji} - d_{jj}) / d_j]\} / 2 = 1/[1 + \exp(d_{ji}/d_j - 1)]$$

$$P_{ji} | j = \{1 + \arctan(d_j/d_j - 1) / (\frac{1}{2}\pi)\} / 2$$

where the transformation of the last probability after differentiation and scaling (see subsection 7.2.4.) defines no model for a derived probability. Under adaptation-level shifts to midpoint sensations (i,j), whereby  $d_{ij} = \frac{1}{2}(y_i + y_j) - g_j = \frac{1}{2}(d_{ji} + d_{jj})$ , we would have for conditional similarity probability

$$P_{ji} | ij = \{1 + \tanh[-\gamma \ln(d_{ji} - d_{jj}) / d_j]\} / 2 = 1/[1 + \exp\{(d_{ji} - d_{jj}) / d_{ij}\}]$$

$$P_{ji} | ij = \{1 + \arctan\{(d_{ji} - d_{jj}) / d_{ij}\} / (\frac{1}{2}\pi)\} / 2,$$

that  $P_{ji} | ij$  is smaller than  $P_{ji} | j$ , where differentiation and scaling of the last expression yields again no additive model.

These conditional similarity probabilities may respectively define the (i-over-j)- and (i-or-j)-preference probabilities of hyperbolic tangent- or arctangent-based valences under stimulus-dependent adaptation level shifts. Although not derived from the

respective values of their above defined, single-peaked valences, the expressions for the probability that  $d_{ij}$  is smaller than  $d_{ji}$  may define the probability that alternative  $i$  is preferred over alternative  $j$  for (i-over-1)-preferences with adaptation-level shifts to the sensation of target alternative  $j$  or respectively for (i-or-j)-preferences with adaptation-level shifts to the midpoint sensation of alternatives  $i$  and  $j$ . If this holds then we have for distances to ideal points by the earlier derived, conditional similarity probability models also an *exponentially multiplicative preference probability model with power-raised single or dual bias* for hyperbolic tangent-based, single-peaked valences of Euclidean sensation spaces. For arctangent-based, single-peaked valences of Euclidean sensation spaces we have an *arctangent-based preference probability model with single or dual bias*, but no additive preference probability model with multiplicative single- or dual-bias.

Preference analyses by existing unfolding analysis methods don't account for changing weights of distances to the ideal point by shifted adaptation levels, nor are preference probabilities ever fitted by a metric unfolding model. Therefore, we can't compare existing preference analyses with appropriate analyses of preference probabilities under shifts of adaptation levels. Notice that intransitive preference rank orders or probabilities are sometimes consistently observed and can be predicted by our psychophysical valence theory for objects with single-peaked valences and stimulus-dependent adaptation-level shifts. Such adaptation-level shifts don't influence the preference order for so-called unilateral objects with respect to the ideal point, while such shifts can influence the preference order for bilateral objects and for bilateral-adjacent objects more often than for bilateral-remote objects. It may explain why Coombs (1964) reported significant transitivity violations for bilateral-adjacent choice triples (in his unfolding analysis of individual comparisons of varying grays on the black-white dimension with respect to individually different, but variable-assumed ideal gray levels), while transitivity violations for bilateral-remote choice triples were insignificant and for unilateral choice triples absent. Probabilistic unfolding analyses with wandering ideal points (De Soete, Carrol and DeSarbo, 1986, 1989) and object distributions (Mullen and Ennis, 1991; De Soete and Carroll, 1992) are used for the analysis of preference rank orders and can describe stochastic preference intransitivity. However, we conjecture that intransitive preference rank orders are better analysed by the earlier described (see chapter 5), deterministic analysis methods for hyperbolic tangent-based, single-peaked valences under iterative adjustments of these analysis methods for stimulus-dependent adaptation-level shifts.



## CHAPTERS

### CHOICE CONFLICTS AND DYNAMICS

*"differences/conflicts are inherent in choice, where by conflict is meant incompatibility, i.e. something cannot be obtained without giving up (or expending) something else."*

Hogarth, R. M. (1987). *Judgement and Choice*. (2<sup>nd</sup> ed. p. 66). John Wiley & Sons, New York.

*"Remarquons cependant que, dans les cas de très grands ensembles (refus que celui, justement, présenté par la masse humaine) le processus tend à "s'infaillibiliser", les chances de croissant du côté hasard. et les chances de refus ou d'erreur diminuant du côté libertes, avec la multiplication des éléments engagés."*

Teilhard de Chardin, P. (1955). *Le phénomène humain*. Editions du Seuil, Paris.

*"The human phenomenon"* is written by paleontologist and philosopher Teilhard de Chardin between 1938-1940 in Peking and published posthumously, but the citation is from p. 342-343 of a postscript that is added in 1948.

## CONTENT DETAILS CHAPTER 8

	page
<b>8.1. Personal ambivalence and choice conflict dynamics</b>	401
8.1.1. Introduction	401
8.1.2. <b>Behavioural</b> , developmental, and cultural aspects of choice conflicts	402
8.1.3. Ambivalence and partial indifference	405
8.1.4. Risk-adaptation theory	411
<b>8.2. Time-dependent developments and collective adaptation</b>	418
8.2.1. Time-dependent growth models	419
8.2.2. Risk adaptation as time-dependent collective learning	424
8.2.3. Fatality risk as function of delayed traffic growth	431
<b>8.3. General theory of technological evolution and adaptation</b>	437
8.3.1. Scenario predictions of world developments	443

## 8.1 Personal ambivalence and choice conflict dynamics

### 8.1.1. Introduction

In this chapter we discuss individual and collective aspects of choice that are not explicitly covered in preceding chapters. Nearly all choice realisations require that a preferred object is obtained at the cost of something else, whereby most preferential choices in reality are of a personally conflicting nature. In subsection 8.1.2. we discuss phenomenally different types of choice conflicts that all derive from the combination of forward single-peaked and backward monotone valence functions (see chapter 2, where figures of backward and forward valence functions are shown). Firstly, we argue that this personal conflict occurs often for the behavioural choices in real life, where cognitive preferences from forward single-peaked valence dimensions are counteracted by a backward monotone valence dimension for behavioural realisation difficulty of the cognitive preferences. Secondly, we place behavioural choices in a time perspective, where the personal conflicts between choice realisations now or later are discussed in the context of the adaptation to progressively changing realisation abilities in the course of one's life. Thirdly, the choice conflict may also arise when one's own choice from a single-peaked valence dimension is expected to be depreciated by other relevant persons, where that expected depreciation is represented by an oppositely oriented, monotone valence function. We don't discuss the type of choice conflict that may arise from choices made in social interaction, such as group decisions, because it would require a rather complex reformulation of the interpersonal choice theory of Coombs and Avrunin (1988) in terms of our psychophysical valence theory, which is out of scope for this monograph. The intra-personal conflict from an expected depreciation of one's own choices by other individuals can be based on misunderstanding, because the object space for an individual may not be shared by other individuals when it concerns choices from a cognitive object set. If the objectively measured, cognitive object space is different for individuals then there will inevitably be misunderstanding and incorrect expectations of depreciation or appreciation. The possibility of differing object spaces for cognitive concepts is briefly discussed at the end of subsection 8.1.2., where differences between cognitive object spaces of groups are described as objectively measurable culture differences between groups.

In subsection 8.1.3. we further discuss the combinations of monotone and single-peaked valence functions that depending on their addition weights and equal or opposite orientations describe many forms of manifest, asymmetric mixed valence functions. The combination of backward monotone and forward single-peaked valence functions that are equally weighted even describes a manifest valence function with an indifference for sensations below a point just above the adaptation level and negative valences above that point. If a two-dimensional sensation space has two oppositely oriented, single-peaked valence functions for its dimensions that simultaneously apply to objects or events with completely correlated dimensional sensations then it also defines a manifest, mixed valence function with an ambivalent indifference for a mid range of sensations with zero valences and negative valences for sensations outside that indifference range. This type of choice conflict is illustrated by a few examples and the example of individual risk in road traffic. The latter example is extensively discussed and mathematically described in subsection 8.1.4 as the risk-adaptation theory that is

characterised by a backward single-peaked valence function for sensations of accident fear and a forward single-peaked valence function for arousal sensations of driving, where arousal and fear sensation dimensions generally become completely correlated sensation dimensions in road traffic.

Some collective aspects of choice are discussed in section 8.2., but the discussion only concerns choices and choice conflicts that are determined by the sum of individual choices, again excluding a dependence on social interaction. An extensively discussed example of such collective choice conflict behaviour is collective risk of road users, where the collective risk development over time depends on the cumulative road safety improvements that are inherently connected with traffic growth. In subsection 8.2.1. we discuss models for the S-shaped traffic growth as function of time, while in subsection 8.2.2. it is shown that the macroscopic development of collective traffic risk is described by exponential risk decay as function of time. In subsection 8.2.3. it is demonstrated that the slope of the exponential decay of road user risks and traffic emission rates are mathematically dependent on the slope of the S-shaped traffic growth, which is explained by our risk-adaptation theory. As consequence of the S-shaped growth of road traffic and exponential decay of risk and emission rates in road transport, the macroscopic long term development of self-destructive road transport outcomes (fatalities and polluting emissions) is single-peaked. Road transport growth and its exponential risk decay constitute a specific example of the adaptive evolution of self-organising, technological systems. Therefore, in section 8.3. we generalise the mathematical relationship between traffic growth and risks to a general theory of evolution and adaptation for all kinds of self-organising, technological systems. This general theory contradicts the nowadays still popular and politically influential, but more than 35 years old '*models of doom*' (so-called by Cole, 1973) for environmental world developments of global industry growth. The 'doom theory' is initiated by the so-called Club of Rome in the early seventies of the 20th century with the publication of '*The Limits of Growth*' (Meadows, 1972), further specified by Meadows (1974), and affirmatively reconsidered in '*Beyond the Limits, Confronting Global Collapse*' (Meadows et al. 1991). Evidence from long term time-series analyses that can discriminate between our general theory and such world 'doom' models is either absent or when present seems often more in favour of our general theory. Therefore, we conjecture that these 'doom' predictions are based on unjustified extrapolations of initially exponential growth of industrial production and environmental pollution. Such initially almost exponential growth is also a basic aspect in our general theory of technological system evolution and adaptation, but our general theory predicts a quite different future of gradually saturating growth and single-peaked developments of life-threatening events.

#### *8.1.2. Behavioural, developmental, and cultural aspects of choice conflicts*

Psychological preference studies generally concern the analyses of individual preference rank orders of cognitively presented objects, where individual preference rank orders are represented by the rank order of object distances to imaginary ideal objects of individuals in a common Euclidean space. However, actual choice behaviour also depends on one's ability to realise the cognitively preferred choices. Since the adaptation point represents the centroid of the actual stimuli of an individual, it also

represents what an individual has been able to obtain, while the ideal point of an individual represents what is most highly preferred, but also what has not yet been able to obtain. The differences between behavioural choice realisations and cognitively optimal choices seem hardly researched, but we conjecture that behavioural choices in reality not only depend on object distances to the ideal point, but also on the object differences from the adaptation point. More precisely formulated, actual preferences are conjectured to depend simultaneously on a backward oriented, monotone valence function for the object differences from the adaptation point, reflecting the behavioural choice realisation difficulty, and on a forward single-peaked valence function for the object distances to the ideal point, reflecting the cognitive preference. Consequently, the valence function of the object sensation dimension for actual choice behaviour in reality is specified by a combination of oppositely oriented, monotone and single-peaked valences. This defines behavioural choices in reality to fit our preference analyses in a mixed valence space, described in section 5.4.4. of this monograph. Without loss of generality we may simplify such behavioural preferences to a weighted-additive combination of a backward monotone valence function for choice-realisation difficulty and a forward single-peaked valence function for cognitive preference of choice objects. The result generally is a mixed, asymmetric valence function of the manifest valences for the sensation dimensions of behavioural choice objects. Figure 39a displays a sensation dimension with mixed valences, whereof the rotation weight for underlying forward single-peaked valences of cognitive preference is higher than for underlying monotone valences of choice-realisation difficulty.

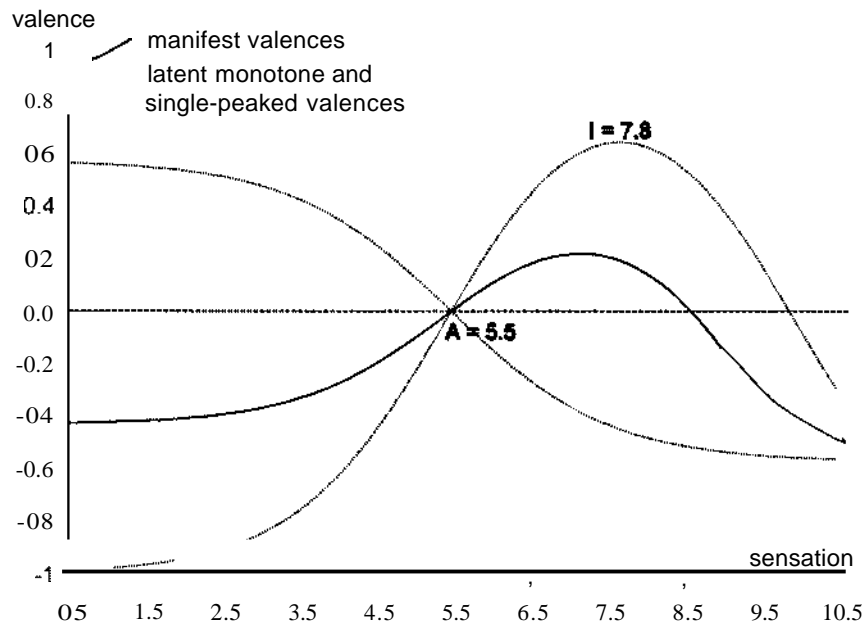

Figure 39a. Asymmetric single-peaked mixed valences from underlying, oppositely oriented, monotone and single-peaked valence junctions.



As figure 39a shows, the sensation location of the manifest maximum valence for realisable choice coincides not with the ideal point for the underlying single-peaked function, but is located between the adaptation and underlying ideal points. Depending on the projection weights for the underlying monotone and single-peaked valences the level and location of the maximum manifest valence vary both. It may be that this is a theoretically and empirically correct model for behavioural choice in reality. It can be regarded as a mathematically specified model for what Simon (1957) might have meant by his 'satisficing principle' of behavioural choices, where individuals actually prefer alternatives that for the time being are satisfactory enough to be realised, without trying to obtain the cognitively ideal choice. The capability of spending money for the realisation of choices may be the main determinant of the monotone valences for behavioural realisation difficulty. A monotone valence function for choice realisation costs (thus backward oriented) could by instruction also be cognitively taken into account in the study of preferences. However, the monotone valence function for the disutility of spending one's money and other realisation difficulties of cognitively preferred choices may still differ from a cognitively evaluated, monotone valence function. Apart from typical examples, no research of systematically gathered data on differences between behavioural choices and cognitively expressed preferences seems to exist, but for progress in behavioural choice theory such research is needed.

In the course of life one realises choices and, thereby, a developmentally determined change of adaptation level will influence the object preferences, although the object attributes remain the same. If that change is progressive in one direction over time, as for example will be the case when one's income increases over time, one also learns to place preferential choices in a time perspective. This can be represented by additional prospect sensation dimensions that changes the adaptation point location on the dimensions of the above described two-dimensional sensation subspace with mixed valences. The backward monotone valence function for realisation difficulty of choices may then get a prospectively lower weight and another prospective adaptation point, whereby the maximal valence point for the two-dimensional prospective sensation subspace then may move towards the cognitive ideal point of the underlying single-peaked valence function. It may contribute to the expectation of gradual future realisation of choices that are not fully realisable now. This may be an appropriate modelling of the often observed, progressively changing choices, where we cognitively postpone optimal choices and satisfy ourselves with realisable, momentary sub-optimal choice objects that also contribute to a future acquirement of more optimal choice objects. Examples are the subsequent choices of initially modest and less expensive choices and later more luxury and expensive choices, such as choices for houses that one may acquire in the course of time when the growth of one's income makes such progressively changing choices realisable. Expectations of negative consequences in the long term of choices that can easily be realised in the short run can also be modelled by prospective backward monotone valence functions for such choice consequences. Such prospectively negative choice consequences then may cause that the negative valences of the backward monotone valences progressively dominate over the positive choice valences of an underlying forward single-peaked valence dimension. Rational choice behaviour would imply that choices with momentary positive maximum valence

and dominating-negative consequences in the future should not be realised, but persons that give low weights to prospective dimensions may still realise such choices. This might be an appropriate modelling of neurotic choice behaviour, but the theory extension to abnormal behaviour exceeds the scope of this monograph.

The underlying, backward oriented, monotone valence function of a sensation dimension with mixed valences may also represent one's expected depreciation by others for one's cognitively preferred ideal choice. It then becomes a fully cognitive preference situation with an internalised social component. Whether this cognitively expected depreciation of others is correct or based on misunderstanding, then depends on whether the individual and the other persons share the space of cognitive objects in the relevant domain. We may assume that physical stimulus spaces are shared by individuals, if no perception deficiencies (for example colour blindness) are present. However, spaces of cognitive objects (the quasi-stimulus space representations of cognitive object attributes) may be different for different individuals, especially when their cognitive learning history is different. Since object spaces can be derived from individual response spaces, as described in chapter 4 and section 7.2 (or from valence spaces of homogeneous subgroups with sufficient number of individuals, as described in chapter 5 and section 7.4), we can assess differences between the cognitive object spaces of individuals or subgroups. If cognitive object spaces differ between subgroups of individuals, while well-fitting common object spaces are obtained for individuals within each subgroup, then this may be caused by cultural differences between subgroups. For example, when groups of Muslims, Hindus, Christians, and Humanists evaluate dissimilarities between cognitive objects, such as between pairs of the concepts Catholicism, Protestantism, Confucianism, Hinduism, Islamism, Humanism, etc., it very well may be that each group has a well-fitting object space, but that there also are marked differences between the object spaces of each group. Such cultural group differences can be measured by the Mahalanobis  $D^2$  (Mahalanobis, 1936; Krzanowski, 1988) between the Euclidean object spaces of groups and their optimally matched object space (Gower, 1975). Since Euclidean object spaces of groups are solved spaces of object-attribute fractions or comparable sensations with dimensional-invariant measurements, their Mahalanobis  $D^2$  becomes an objective measure of cultural group differences. If these cultural differences are significant then individuals of the different groups may mean different things by the same concept words. As a consequence misunderstanding will then be inevitable and expected depreciation or appreciation of one's own cognitive choices by other persons from another cultural background can be misconceived, which may lead to social conflicts. Therefore, an extension of the psychophysical response and valence theory may also contribute to the study of cultural differences and social conflicts.

### 8.1.3. *Ambivalence and partial indifference*

In section 7.4.2. we already discussed mixed valence functions for value- and risk-dependent preferences for gambles. There we discussed the preference effects of monotone valence function of utility for the payoff values of gambles and the simultaneous effects of monotone and/or single-peaked valence functions for certainty sensations of gamble outcome probability. All valence functions of rotated dimensions in a two-dimensional sensation subspace with a single-peaked valence dimension and

an ideal axis with monotone valences are asymmetric valence functions. Their asymmetry can take many forms, depending on the respective rotational weights for the dimensions with underlying monotone and single-peaked valence functions and on whether these underlying valence functions are identically or oppositely oriented, where their combination becomes either:

1. an asymmetrically increased, single-peaked function, if identically oriented,
2. an asymmetrically reduced, single-peaked function, if oppositely oriented and combined by higher weighted single-peaked than monotone valences,
3. an asymmetrically monotone-decreasing function, if oppositely oriented and combined by higher weighted monotone than single-peaked valences,
4. a function with an ambivalent indifference below or above the adaptation point and increasingly negative valences on the other side, if oppositely oriented and combined by equally weighted monotone and single-peaked valences.

In figure 39b below we show the underlying and manifest valence functions for certainty sensations of an individual with equal weights for forward-oriented, monotone and single-peaked valence functions of outcome probability with its adaptation point at  $p = .50$  and an underlying ideal point for the single-peaked function at  $p = .80$ .

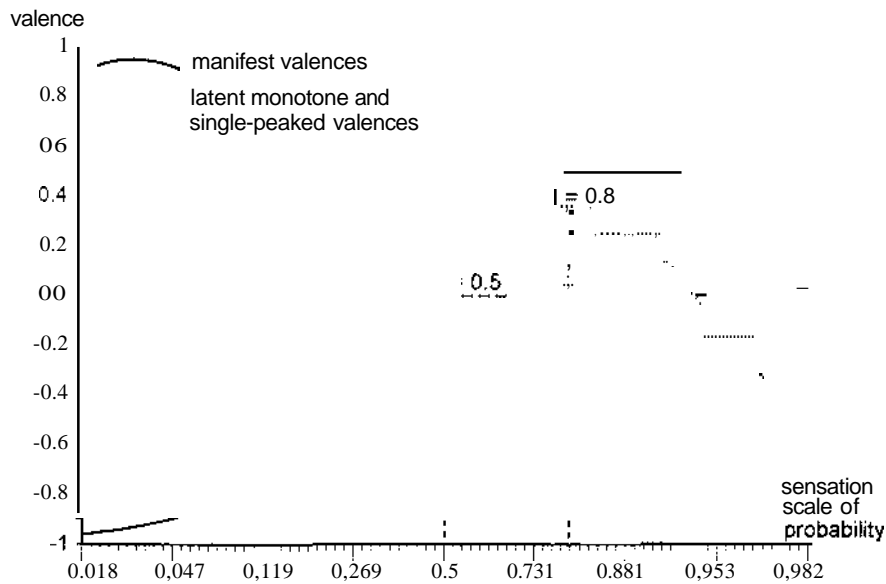

Figure 39b. Asymmetric single-peaked, mixed valences from forward oriented, monotone and single-peaked valences of certainty sensations.

Here the mixed and monotone valences are almost equal below adaptation level, but there above the mixed valences initially increase to a maximum at  $p = .87$ , while the underlying ideal point is located at  $p = .80$ , and then further slowly reduce to the zero valence of infinite certainty sensations for  $p = 1$ . Figure 39c shows another mixed valence function from backward monotone valences that additively combine with equally weighted, forward single-peaked valences.

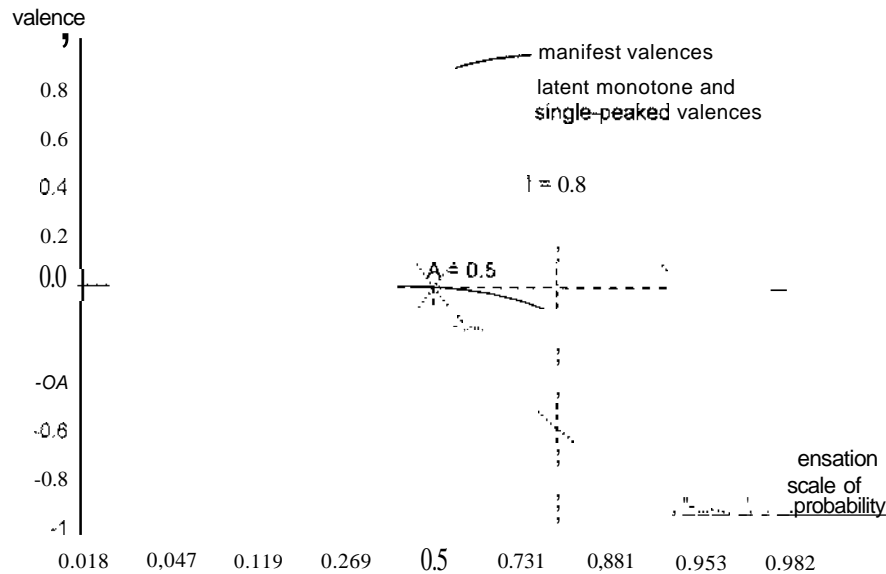

Figure 39c. Manifest *mixed* valences with partial indifference from oppositely oriented equally weighted, monotone and single-peaked valences of risk sensations.

In figure 39c we took again certainty sensations with underlying ideal point  $p = .80$  and adaptation point  $p = .50$ , where the backward monotone and forward single-peaked valences of certainty sensations may represent the monotone valences of accident probability and the single-peaked valences of arousal from risky driving that is positively correlated with accident risk. If completely correlated then their addition by equal weights yields a partial risk indifference as zero mixed valences below a point just above adaptation level and increasingly negative risk valences above that point, as illustrated by figure 39c. As discussed in section 7.1. the adaptation level will shift with presented stimuli and, thus, also with stimuli from the realised choices. One may cognitively weigh the underlying monotone valences of accident risk relatively lower, similar to cognitive weights discussed for the manifest valence in figure 39a. It may change the mixed valence function in figure 39c into a similar function as for the manifest, mixed valences in figure 39a. However, by riskier driving drivers are always able to generate the risk stimuli with a maximal mixed valence, whereby also their adaptation levels will shift towards the average sensation of their newly self-obtained, higher risk stimuli. If the adaptation level moves upward in figure 39a then the distance between the adaptation level and the underlying ideal level will decrease, whereby the underlying maximum valence of the ideal point becomes lower. This in turn counteracts the lower weight for the underlying monotone valence function of accident risk. In such dynamic cases the process of the upward moving adaptation level can only progress up to the point where the relatively lower weight for the monotone valences and the increasingly lower single-peaked valences become balanced and restore a manifest, partial valence indifference. The end result is again the manifest valence curve of figure 39c, where then only the indifference endpoint is moved upward. Notice that relatively higher weighted, monotone valences can have the same result with a lowered

indifference endpoint, if realised lower traffic risks move the adaptation point away from the underlying ideal point, because it would increase the maximum single-peaked valence, which counteracts the higher weight for the monotone valences of accident risk, until the partial indifference is restored. A dynamically self-controlled obtainment of stimuli clearly is not always possible for all kind of choices. For example, not for risky choices that are presented in a psychological experiment, but it often also applies in real life situations. Therefore, indifference below a certain adaptation level with negative valences elsewhere may apply to self-controlled choice situations that are characterised by underlying dimensions with backward monotone valences and forward single-peaked valences. If this would apply for traffic risks then the valence function of traffic risk would adaptively become the manifest valence function of figure 39c. It would mean that individuals are adaptively indifferent to risk in traffic up to a certain risk level, where above the risk evaluation becomes increasingly negative. Referring to the shifting adaptation level and adaptively balanced weights for underlying valence functions, the above hypothesised model resembles the so-called zero-risk theory for traffic risks of Näätänen and Summala (1976; Summala, 1988). The zero-risk theory states that risks below an adaptively changing perception threshold are perceived as zero risk, while risks above that dynamic threshold are the more avoided the higher they are. The perceptual explanation of zero risks below an adaptive threshold differs from our valence indifference for perceivable risks below a changing adaptation level, but both models predict the same dynamic risk behaviour in traffic. We further discuss this and other traffic risk models in the next subsection 8.1.3.

Returning to choice realisation difficulty as a backward monotone valence function that combines with forward single-peaked valences for cognitive preference. we notice that realisation difficulty of choices in real life often mainly depends on the limited expenditures from one's income. If that income has not increased for a long period then realised choices in the past may also establish a life situation with manifest valences that are only zero or negative. Here the dynamics of figure 39c may apply if cognitively preferred, but unrealisable choices cause a cognitively lower weight for the underlying forward single-peaked valences of cognitive preference. If one's income is also not expected to increase in the future then, in view of the discussed time perspective, also no future improvement of one's realisable choices is expected. Such pennant zero or negative valences only can yield feelings of indifference and unhappiness, because no satisfaction from any choice is then obtainable. However, if someone is extremely rich then expenditures are no problem, whereby no backward monotone valence for difficulty of choice realisations may exist and all ideal choices will be realisable. As a consequence of the exposure to realised choices the dimensional adaptation points move to the dimensional ideal points that also in the end will coincide with the dimensional saturation points, as illustrated by figure 18 and discussed in subsection 2.4.2. Thereby, the single-peaked valence space has a maximum of zero valence and negative valences elsewhere, which characterises only feelings of unhappiness. Therefore, it might be conjectured that happiness of people in our capitalistic society depends hardly on the absolute income level, but mainly on regularly obtained income increases and on increased opportunities for limited realisations of cognitive preferences.

Similar preference contours are not present in a two-dimensional sensation subspace that is characterised by independent dimensions with oppositely oriented, single-peaked valence functions, because the single-peaked valence space is the same for a sensation subspace with identically oriented, single-peaked valence functions. The only difference is that one sensation dimension in the former subspace is reflected in the latter subspace. However, preference evaluations in real life may concern an object dimension in subspaces of dependent dimensions with oppositely oriented single-peaked valence functions. The object dimension is then located in a subspace that has either 1) positively correlated dimensions with oppositely oriented, single-peaked valence functions or 2) negatively correlated dimensions with identically oriented, single-peaked valence functions. The latter case equals the former after reflecting one dimension in the latter subspace. If an object dimension is defined by the positively correlated dimensions with opposite valences then the valences of the object dimension are characterised by underlying, oppositely oriented, single-peaked functions. Oppositely oriented, single-peaked valence functions generally concern independent sensation dimensions, but in specific situations choices may be restricted to an object dimension that is perfectly correlated with such dimensions and then that choice dimension simultaneously exhibits these conflicting single-peaked valence functions. In real life actual choices often imply that one obtains something by giving up something else, where each "something" may also be a cognitively preferred attribute value close to the dimensional ideal point of conflicting, single-peaked valence functions. We consider such choice situations as choices between unidimensional objects with forward and backward single-peaked for subject 4 valence functions that have the adaptation point as common zero valence point. If the distances between the adaptation point and the underlying ideal points would not be equal then one of its single-peaked valence functions would have a higher maximum, whereby also the manifest valence function would have some much lower, but positive maximum somewhere between the adaptation point and the underlying, most remotely located, ideal point. The optimal choices are then closely located to the adaptation point, which choices generally are realisable. The stimuli from realised choices would shift the adaptation point towards the underlying ideal point with the higher maximum valence, which reduces the initially higher maximum and increases the initially lower maximum of the other underlying, oppositely oriented, single-peaked valence function. This adaptively shifting adaptation point changes further in that direction until the distances between each underlying ideal point and the adaptation point become equal, which establishes equal shapes of the underlying, single-peaked, valence functions as reflections of each other. If the equal distance between the adaptation point and the underlying, opposite ideal points is relatively large then the valences of the object sensation dimension show a range of zero valences around the adaptation point and outside that indifference range the valences are increasingly negative. This is shown in figure 40 by the manifest valence curve of equally weighted, underlying, reflected single-peaked valence functions. In this figure the underlying, single-peaked valence functions are generated by  $\pm v_{j1} = \tanh[-Y2 \ln / \cosh(d_{j1} / d_j) / \text{COSH}(1)]$  for  $d_{j1}$  as object distance to its underlying ideal point and  $d_j$  as distance between the ideal and adaptation points, but where the valence curves are re-scaled to  $d_j^{-1/2}(a_j - u) = 3$  for

$3_j = 6$  and  $u = 0$  as just noticeable level that coincides with the deprivation point of the underlying, backward oriented, single-peaked valence function. This single-peaked valence expression holds for hyperbolic and Euclidean sensations, where figure 40 present its valences as function of a Euclidean sensation dimension.

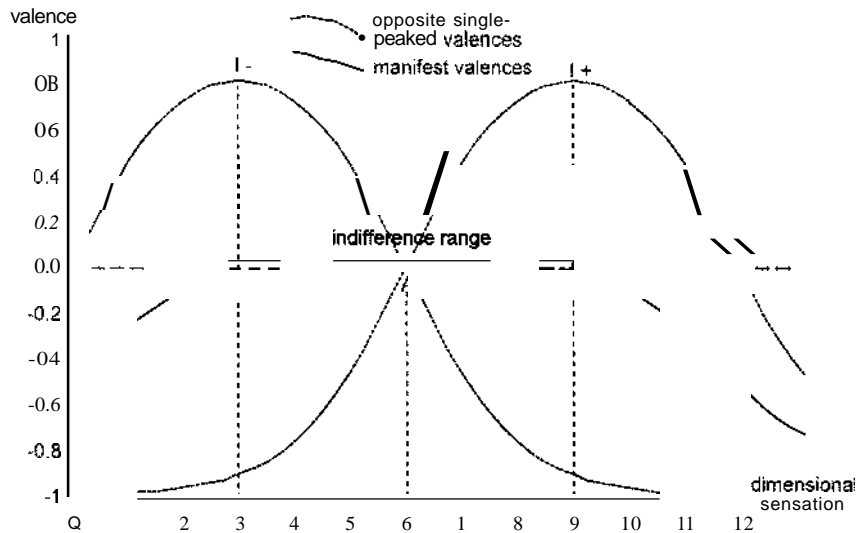

Figure 40. Underlying, oppositely oriented, single-peaked valences and the manifest valence function.

The manifest valence function is the average of the underlying single peaked valence functions, due to by definition equal valence weights for valence functions of comparably weighted, dependent sensation dimensions. Thereby, it shows an indifference range of almost or exactly zero valences, where the adaptation point is the midpoint of the indifference range that becomes the larger the larger the distance between the adaptation and ideal points is. If the indifference range reduces to its midpoint then its valence curve becomes the controlled valence curve of figure 18 in subsection 2.4.2. The indifference range in figure 40 is the intra-personal solution of the valence conflict that is inherent to choices wherein an approach towards the ideal point on one side implies a dilation from the ideal point on the other side. If the opposite valence functions derive from not perfectly correlated sensation dimensions then the angles of the object sensation dimension with the oblique subspace dimensions determine unequal weights for the combination of the opposite, underlying valences to the manifest valence function. Then there is no indifference range, but a manifest, asymmetrically single-peaked valence curve with a positive maximum valence at one side of the adaptation point. However, in that case the sensations of realised choices close to the maximum valence point also decrease the distance between the ideal and adaptation points on the dominantly weighted, oblique subspace dimension and increases that distance on the other dimension, until the projected distances of both dimensional ideal points to the adaptation point on the object dimension become again equal. Therefore, if dependent dimensions with opposite single-peaked valence

functions characterise the choice dimension then self-produced stimulus changes from actual choice behaviour yield choice dynamics that always will establish an indifference range, as pictured in figure 40. Stimuli with valences in the indifference range indicate that no choice or action can provide satisfaction, while stimuli with valences outside the indifference range are to be avoided by actions, since outside the indifference range all valences are negative. An example with such an indifference range is departure time for home-to-work trips during rush hours with congestion (Mahmassani et al. 1986). The indifference range for departure time was observed around congestion peak time, which can be explained by a single-peaked valence function with ideal departure time at the mid point of the rush hours and a conflicting single-peaked valence function with an ideal departure time after or before the rush hours for avoidance of expected traffic congestion. Another example is individual road-risk behaviour, discussed next.

### 8.1.3. *Risk-adaptation theory*

In the 'reference-frame theory of traffic risk' (Koomstra, 1990) it is assumed that the above presented, conflicting single-peaked valence dimensions with a large distance between ideal and adaptation points apply to individual risk behaviour in traffic. Here the underlying, single-peaked valence function with an ideal point far below adaptation level concerns the accident fear dimension in driving. It is comparable to the threat avoidance dimension in Fuller's threat-avoidance theory (Fuller, 1984; 1988) of traffic risk behaviour. The other underlying, single-peaked valence function with an ideal point above adaptation level mainly concerns the arousal dimension of driving risks. An individually fixed ideal level of risk is assumed by Wilde (1982a, 1982b) in his 'risk-homeostasis theory' of single-peaked traffic risk. This positive ambience dimension for driving also can have a mixed valence function as a combination of forward single-peaked valences for arousal, sensation seeking, and fun of driving and forward monotone valences of travel utility and time saving from higher driving speed. It then would represent an asymmetric forward single-peaked valence dimension that combined with single-peaked valences of the highly correlated accident fear dimension also yields by the described choice dynamics a risk indifference range, provided that the distance between adaptation and ideal points remains relatively large. The only difference with respect to the manifest valence curve of figure 40 is that the indifference range is slightly enlarged upwards by the mixed valence of the latter dimension, while the negative risk valences on both sides of the indifference range become asymmetric. This is easily understood by realising that the forward monotone and single-peaked valence curves are almost identical up to a point somewhere above the adaptation and below the upper ideal point, while above the upper ideal point the combination of the positive, mixed valences with the negative valences for accident fear yields manifest valences that become less negatively valued.

The assumption of conflicting valences from backward single-peaked valences for accident fear and forward single-peaked valences for driving arousal is the basis of the 'reference-frame theory of traffic risk' that now is called the risk-adaptation theory. It originally was derived from an integration of the three existing traffic risk theories:

- the *zero-risk theory* of Näätänen and Summala (1976; Summala, 1988), wherein it is assumed that traffic risks are below the perception threshold, unless previous traffic risks have dynamically reduced that threshold below present traffic risks;



- the *risk-homeostasis theory* of Wilde (1982a, 1982b), wherein it is hypothesised that one has a fixed ideal risk level, whereby safer or less safe situations than the ideal level are compensated respectively by more or less risky driving;
- the *threat-avoidance theory* of Fuller (1984), wherein it is assumed that driving risks are judged to be acceptable as long as the positive valences of driving outweigh the negative valences of accident fear and that threat avoidance only guides traffic risk behaviour if accident fear dominates over driving utility.

Each of these theories can be derived from our risk-adaptation theory by setting one of its parameters to zero or to infinity. Although road user actions are assumed to be determined by the manifest valences of the risk dimension with oppositely oriented, single-peaked valence functions, we may combine each single peaked valence function with a respectively oriented monotone valence function, which then only enlarges the indifference range and also may yield an asymmetry of the negative valences on each side of that indifference range.

The zero-risk theory of Näätänen and Summala (1976) can be reformulated as deriving from a combination of a backward monotone valence function for fear and a forward single-peaked valence function for arousal in driving. It yields an indifference of zero manifest valences from the negative infinity of the risk sensations onward up to just above the adaptation point on the risk sensation dimension, as shown in figure 39c. The difference with the original formulation only becomes a matter of interpretation. In the zero-risk theory the risks below an adaptive threshold are perceived as zero, while in our reformulation low risks would only have zero valence, but still are accumulatively perceivable. In the risk-adaptation theory the adaptation level shifts to the experienced risk sensations, which then causes a shifting indifference range, similar to the shifting risk perception threshold in the zero risk model. Thus, by assuming the ideal point for accident fear sensations to be infinitely negative it specifies a special case of our risk-adaptation theory. However, in our risk theory we hypothesise that accident fear is a conditioned (by learning) attribute of driving with a finite deprivation point that coincides with the just noticeable risk level. If so then its backward ideal point is also finite, whereby the fear dimension is characterised by single-peaked valences. Nonetheless, if the ideal point for fear is infinitely negative, then the risk-adaptation theory and the zero-risk theory predict similar risk behaviour. In the zero-risk theory low risks can't be compensated by more risk, but in our risk-adaptation theory this adverse compensation can occur for risks below the indifference range. Since adverse risk compensation is sometimes observed (Evans, 1985), the risk-adaptation theory is to be preferred above the zero-risk theory.

Risk compensation is the kernel of the risk-homeostasis theory of Wilde (1982a, 1982b). The risk-homeostasis theory also can be derived from the risk-adaptation theory by assuming a zero weight for the fear dimension. It then yields one single-peaked risk-valence function or, if monotone valences of driving utility combine with single-peaked valences of driving arousal, one mixed, asymmetric single-peaked valence function of risk. Since more risk can always be generated by one's own traffic behaviour, the dynamics of adaptation to the self-generated risks stimuli guarantee that the adaptation point will in the end coincide with the shifted ideal risk point towards the saturation level of arousal. Thereby, the single-peaked valence curve for risk

becomes zero at the coinciding ideal, adaptation and saturation point with negative valences elsewhere, as already shown by figure 18 in subsection 2.4.2. Since that coinciding ideal and saturation point can be a fixed, psychophysical saturation point, lower or higher risks will indeed be respectively compensated by more or less risky behaviour. For example, if a reconstructed road is made safer than before then the risk-homeostasis theory predicts that the safety on that road will not increase, because compensated by more risky behaviour. Due to actually observed risk compensation and the simplicity of the theory, the risk-homeostasis theory has become very popular. However, in motorised countries the fatality risk tends to reduce more or less exponentially over the years, also if expressed as fatalities per time of traffic participation. This fact and the research evidence that road safety measures often effectively reduce road traffic risks (Evans, 1985, 1986; OeD, 1990) invalidate the risk-homeostasis theory. Risk compensation, however, is sometimes observed, which also is in accordance with our risk-adaptation theory wherein risks above the indifference range are compensated by safer behaviour and risks below that range by less safe behaviour. Our risk-adaptation theory is also in accordance with monotone risk decay, because safety improvements cumulatively shift the adaptation level downward, which also shifts the indifference range to lower levels of risk. Bower (1990) has formulated a traffic risk model that is based on a single-peaked function for risk, but with an ideal level that can be dependent on the level of traffic enforcement. However, Bower's single-peaked function of traffic risk is based on Coombs' assumption of saturating utility (good things satiate) of driving and non-saturating disutility (bad things aggravate) of accident and fine probabilities, which is incompatible with our derivations of single-peaked valence functions, as discussed in chapters 1 (especially subsection 1.3.2.) and 2 of this monograph.

The threat-avoidance theory of Fuller (1984, 1986) can be reformulated a combination of a backward single-peaked valence function for accident fear and a variably lower or higher weighted, forward monotone valence function for driving utility. If driving utility is lower weighted than accident fear then its manifest valence function becomes the reflected curve of figure 39a. If the underlying deprivation level for accident fear is assumed to coincide with the absolute threshold of fear perception then its asymmetrically single-peaked, manifest valence function for risk has an ideal risk sensation at the midpoint of the adaptation level and the absolute just noticeable risk sensation. Risk reduction by one's own traffic behaviour only can be obtained to a limited level, because one's risks are also determined by other drivers. Therefore, in contrast to our interpretation of the risk-homeostasis theory wherein risk adaptation leads in the long run to coinciding saturation and ideal risk levels, adaptation to the experienced risks will never show coinciding deprivation and ideal levels of risk. Thus, in our reformulation of the threat-avoidance theory, there always will be a latent and sometimes manifest tendency to risk avoidance behaviour. Our risk-adaptation theory under the assumption an infinite upper ideal point and variably lower or higher correlation of risk sensations with fear sensations than with utility sensations becomes a reformulation of Fuller's threat-avoidance theory, as another special case of our theory. Each of the three mentioned risk theories derives from our risk-adaptation theory as special cases, by either setting one function weight to zero (risk-homeostasis

theory) or setting one function weight variably lower than the other (threat-avoidance theory) and/or setting one of the underlying two ideal points to infinity (the lower one in zero-risk theory and the upper one in threat-avoidance theory).

Risk-adaptation and risk-homeostasis theories predict both risk compensations. However, the risk-adaptation theory only predicts that risks are partially compensated, because only up to the lower or upper bound of the indifference range, where the risk-homeostasis theory assumes a fixed ideal risk level and full compensation to that fixed ideal risk level. The risk-adaptation theory has changing risk consequences that differ from the risk-homeostasis theory, due to possible shifts of the adaptation level within the existing indifference range, whereby also that indifference range itself will shift. If road infrastructure improvements provide risks below adaptation level then aversive risk compensation only occurs up to the lower bound of the indifference range, which shifts the adaptation level and the indifference range downward, as illustrated by comparison of figures 41a and 41b below.

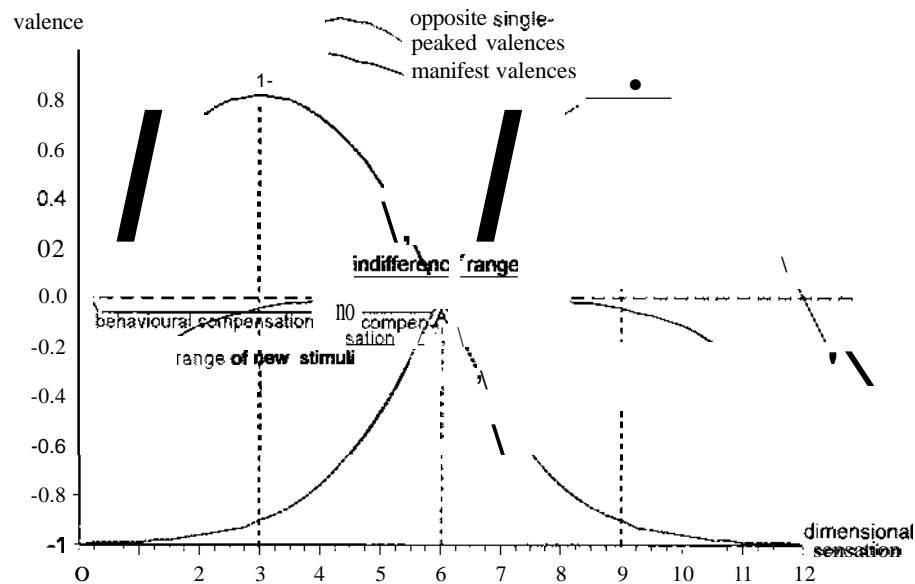

Figure 41a. Provided low risk sensations and their partial compensation.

The next figure illustrates how the downward shift of adaptation level by not-compensated, new lower risk stimuli (in figure 41a between Fechnerian risk sensation levels 4 and 6) influences the indifference range in a dynamic way by shortening and lowering that range simultaneously. Firstly, the provided lower risks move the adaptation point downwards (here from  $a_j = 6$ , to  $a_T = 5$ ). Secondly, the risk-sensation distance between the new adaptation level and the lower ideal point is reduced, due to the fixed risk deprivation level that coincides with the just noticeable risk level (here from  $l^- = 3$  to  $l^- = \frac{1}{2}a_j = 2,5$ ), which implies a downward shift of the lower ideal point by half the shift of the adaptation point. Thirdly the upper ideal point is shifted downwards by  $|V|$  times the adaptation level shift (here from  $l^+ = 9$  to  $l^+ = 7.5$ ).

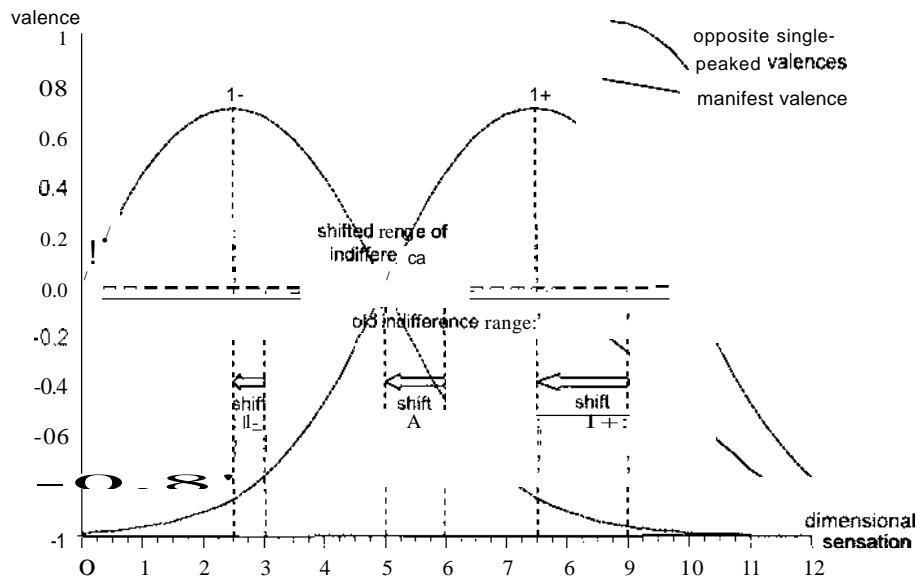

Figure 41b. Shift of indifference range from partial compensation of low risks.

Reduced distances between ideal and adaptation points also reduce the underlying maximum valence level and, thereby, shorten the shifted indifference range, while the shifted adaptation point remains the midpoint of that range. The end effect is that the upper ideal point and the upper indifference range bound are decreased by one and a half of the adaptation level shift and the lower ideal point and the lower indifference bound both by half the adaptation level shift. Thereby, the indifference range not only is shortened, but also shifted downward with respect to the original indifference range. The relatively high risks between the new upper ideal and the old adaptation points are now no longer experienced as indifferent, but become negatively evaluated and, thus, positively influenced by safer behaviour. Also relatively low risks in a short interval just below the old indifference range are now experienced as indifferent and, thus, no longer negatively compensated by riskier behaviour.

Individuals will have different underlying ideal points, whereby all individuals also will show differently located and shifting indifference ranges in the same way as illustrated in figure 41b. Thereby, also the upper limit of the collective indifference range shifts downward by one and a half the average adaptation-level shift and its lower limit by a half of the average adaptation-level shift. It means that the collective accident risk reduces by the risk reduction of the shifted average adaptation level. However, high accident-risk sensations are associated with fatality outcomes, whereby the fatality-risk sensations will be reduced by a one and half times the shifted average adaptation level. If average adaptation level of accident-risk sensations is shifted downwards by  $a < 0$  then the objectively measured fatality risk is reduced by a factor  $\exp(1.5 \cdot a)$ , because risk sensations are logarithmic values of the objective risk values. Since road safety measures are more or less regularly taken over time, while measures with large risk reductions are partially and only initially compensated by riskier behaviour, the annual reduction of the objective accident risk as exponent of the negative shift of the average

adaptation level of accident-risk exposure will be more or less constant over the years. Therefore, risk-adaptation theory predicts that the fatality risk  $R_t$  approximately reduces

$$R_t = \exp(1.5 \cdot a \cdot t + b) \quad \text{for } a < 0, b > 0$$

for  $a$  as average adaptation-level shift for exposure to accident risk per unit of time scale  $t$  with  $b$  as a constant that derives from the arbitrarily defined zero timescale point.

Although risk stimuli in traffic are low, their faint sensations are not unperceivable, as illustrated by ones feelings of danger in some traffic situations. However, due to the generally faint risk sensations, adaptation to lower risks slowly occurs by accumulation of faintly perceived, low risk experience over time. Thus firstly, the risk-adaptation theory predicts that some traffic measure with a large accident risk reduction on a type of the national roads will reduce the actual risk on that road type only to the lower bound of the average risk-indifference range of all road users, because risk reductions below that limit are behaviourally compensated by riskier behaviour. Secondly, it also predicts that the decreased average risk on that road type will more or less stabilise on that level up to the time where the delayed adaptation to reduced risks shifts the indifference range further downwards. Both predictions are verified by the sudden interruption of the regular fatality rate decay on the USA freeways from 1966 to 1986, as shown in figure 42.

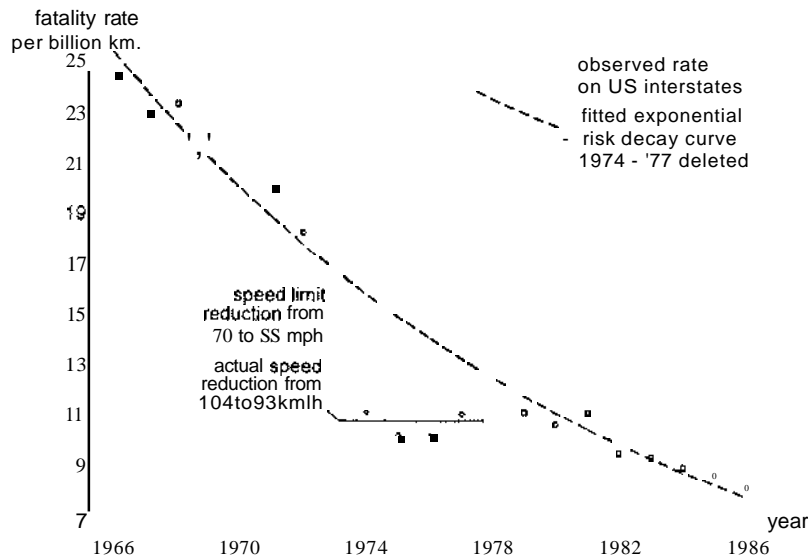

Figure 42. Fatality-rate reduction on the USA interstate system from 1966 to 1986.

Due to the sudden lowering of the speed limit from 70 to 55 mph on the interstate system in the USA after the oil crisis of 1973, the regularly decreasing fatality risks are additionally reduced to an almost stable lower level for about four to five years, but after 1978 they again regularly reduce in the same way as before 1974. As hypothesised from the risk-adaptation theory (and will empirically be shown to hold in section 8.2.2.), long term time-series of annual fatality rates per motor vehicle kilometres tend to decay as exponential function of time, although periodical deviations may also be

also present. Therefore, the fatality rates for the USA interstates in 1966 to 1973 and 1978 to 1986 are fitted by an exponential decay function in figure 42 (under minimisation of the Chi-square of predicted fatalities as product of predicted rates and observed motor vehicle kilometres). Apart from the risks between 1973 and 1978, we indeed see that the risks on the interstate system in the USA tend to reduce in an exponential way (linear risk decay fits almost significantly worse). According our risk-adaptation theory the exponential risk decay is caused by the downwardly shifting indifference range of the average driver on the US roads, while the lowered speed limit and the following period of partial risk compensation cause a risk stabilisation on a lower level in 1974 to 1977/78 on the US interstate system. The further decay of risks along the predicted curve after 1978 is then caused by the delayed adaptation to the markedly reduced risk on the interstate system and the usual risk reductions on other road types. None of the discussed other three risk theories can fairly well predict this actual risk development on the USA interstate system.

As discussed by Koornstra (1990), a similar downward shift for the indifference range as shown in figure 41b can be caused by a cognitively induced, relatively higher weight for fear than arousal valences. This is consistent with observed safety effects from combinations of slightly increased police enforcement and safety campaigns and the usually zero effect of slightly increased police enforcement alone (Koornstra and Christensen, 1990). Conversely, a higher weight for risk arousal than fear valences would shift the indifference range upward. This again is consistent with the higher observed traffic risks for male youngsters than for adults and female youngsters, since male youngsters have higher arousal needs than adults and female youngsters (Zuckennan, 1994). Moreover, the risk-adaptation theory also enables the prediction of the direction and order of magnitude of risk compensation for traffic measures. On the one hand it predicts a negative safety effect for measures that lower the level of arousal and/or threat or potential danger perception, because behaviourally compensated by more risk. On the other hand it also predicts a positive safety effect for measures with more arousal satisfaction and/or with more potential danger stimuli, because inversely compensated by safer behaviour. For 22 road safety measures or changed road circumstances Koornstra (1990) shows a very high rank correlation between the assessed safety effects and independent ratings of positive, neutral or negative effects of changed levels of arousal and danger perception from these road safety measures or altered road circumstances. For example, daytime running lights are judged to provide relatively more arousal satisfaction (by the light stimuli) and to increase sensations of potential dangers (by the lights of other cars), while a pavement by porous drain asphalt is judged to increase the arousal need by the lower intensity of sound stimuli (more tyre sound adsorption by the road) and to reduce the sensation intensity of potential danger (fewer splash and spray on wet roads). Therefore, porous drain asphalt will induce relatively riskier behaviour that produces the stimuli for the needed levels of arousal satisfaction and danger perception, while day time running lights will induce lower risks due to its inherent contribution to arousal satisfaction and potential danger sensations. This is in accordance with observed risk compensations, because daytime running lights have marked safety effects (Elvik, 1996; Koornstra, et al. 1997) and newly paved roads with drain asphalt are shown to be not safer than

before (Trapp, 1994) by increased speeds on dry and wet roads after a pavement by drain asphalt compensate that braking on wet roads is improved by porous asphalt. Thus, it might be concluded that the risk-adaptation theory:

- contains three main traffic-risk theories as special cases,
- explains some fatality risk changes that can't be explained by other risk theories,
- predicts from perceptual aspects of safety measures the direction and order of magnitude of risk compensation,
- predicts exponential risk decay over time from cumulative safety measure effects.

The comparable validity of the qualitative version of the risk-adaptation theory, as the 'reference-frame theory' of traffic risk (Koomstra, 1990), has triggered the search for a metric formulation of the psychophysical response and valence theory of chapters 1 to 5 in this monograph and the risk-adaptation theory in this chapter.

Traffic growth means more new and rehabilitated roads, more new cars and replacements of old cars by recently build cars, whereby generally also the safety of roads and cars becomes enhanced. It also means more road users with more years of traffic experience and accumulative adjustments of traffic laws and road safety regulations, while some safety measures with relatively large risk reductions are predicted to be partially compensated up to the lower indifference limits of individual risk. Therefore, the actual traffic risks generally are reducing gradually over time, where the risk decay is caused by the gradual increase of the cumulatively provided road safety that inherently accompanies the growth of road traffic. This assertion implies an adaptive traffic growth with an inherent dependence of risk decay on traffic growth. Our risk-adaptation theory predicts that slope parameter of the fatality risk decay is a factor  $1\frac{1}{2}$  times larger than the slope parameter for the growth of traffic. These assumptions are further investigated and empirically confirmed by the analyses of time-dependent models for traffic growth and risk development in the next section.

## **8.2. Time-dependent developments and collective adaptation**

The multidimensional stimulus environment is pennanently changing over time, also due to the collective effects of human behaviour. Many changes are cyclically, especially when caused by circumstances that result from seasonal or day-night changes, such as fixed daily work or school hours, social events in evenings, leisure weekends, and holiday periods. Sequentially averaged stimulus patterns can also monotonically change in a time-dependent way, either due to common developments of aging, or due to dominating, socio-economic and technological developments that progressively change stimulus exposure with time. An example is the monotone stimulus-exposure change that results from the transport growth and increasing transport speed that have been brought about by the mechanisation of travel and labour. A more recent example is the monotone stimulus change from the increasing speed of infonnation transfer and gathering by digitalisation and communication technology. Time-dependent models for such monotone developments are presented and further discussed for the modelling of the ever increasing volumes of motorised road transport in the next subsection 8.2.1, while its adaptation effects on traffic risk are discussed and modelled in the following subsections. The decay of traffic risks over time is shown to

be an adaptation effect of the past traffic growth by the quantitative relationship between these two developments, which is theoretically derived from our risk-adaptation theory and empirically studied in subsection 8.2.2. In subsection 8.2.3. we derive from the two related time-dependent models for traffic growth and risk decay an expression that describes the annual traffic fatality risks as function of the delayed annual motor vehicle kilometres. It yields significantly better predictions of annual road fatalities than the product of the time-dependent models for traffic growth and fatality risk decay. In section 8.3. the model relationship between traffic growth and risk decay is generalised to an adaptive evolution theory for the growth and risks of technological systems. This section on the relationship between traffic growth and risk decay and our generalised theory of technological system growth and risk adaptation in the next section summarises what has already been published in research reports, scientific journals, and proceedings (Koornstra, 1987, 1988; Oppe and Koornstra, 1990; Oppe, 1991a,b; Koornstra 1992, 1993, 1995, 1997a,b). Only some illustrated results are updated, while the relationship between traffic growth and risk decay is reconsidered on the basis of the now mathematically formulated risk-adaptation theory and the now verified Gompertz (instead of logistic) function for the S-shaped traffic growth.

#### *8.2.1. Time-dependent growth models*

In this subsection several time-dependent models for system growth are described and specifically discussed for the example of motor-vehicle kilometre growth, while traffic growth and monotone decay of traffic risk are inherently related, as shown in next subsections, but what is discussed for the growth of the traffic volume and traffic risk decay generally may hold for all kinds of self-organising systems that grow monotonically with time. Growth is often modelled by an exponentially increasing function of time, as usually for long term macro-economic growth. Exponential growth approximately holds in the long run for the capital value of a growing national economy, but probably not for inflation-corrected growth of economic subsystems for particular products with a saturating market. Anyhow, long term growth of all physical product systems must level off, because they dissipate energy and are limited by their embedding system. Thereby, any system growth must reduce by to the finitely available energy, area, and other resources on earth. Therefore, long term growth must be modelled as a growth that will level off or will decline in the end if replaced by a more efficient production system. Growth of motorised traffic has been modelled in many ways. Often the models for the prediction of annual motor vehicle kilometres of a country are based on structural regression models with economic variables. However, the long term development of economic variables itself is hardly predictable, whereby the prognostic value of these models is limited. Moreover, if the car ownership and the driven motor vehicle kilometres in the past year are added as time-lag variables in these structural regression models, then the weights for these time-lag variables become dominant, while weights for economic variables decrease to almost zero (Golob and Van Wissen, 1989). It means that growth of motorised traffic can be modelled as a time-dependent process. Since the beginning growth of motor vehicle kilometres seems to be more or less exponential, while exponential growth can't go on forever (driving time and speed as well as inhabitants are limited, as in principle also are the energy supply and road capacity), a S-shaped growth function of time is hypothesised to fit the



macroscopic development of the motor vehicle kilometres. Oppe (1989; 1991 a,b) applied the symmetrically S-shaped, logistic function of time, while Koornstra (1988; Oppe and Koornstra, 1990) used a family of asymmetrically S-shaped functions of time for the growth of traffic volumes. The most general S-shaped function of time is the generalised reciprocal function (Oppe and Koornstra, 1990) that simplifies to

$$V_t = V_{\max} [1 + (a \cdot t + b) \cdot t^{-u}]^{-1/c}$$

for volume  $V_t$  as five parameter function of time  $t$ , where parameter  $V_{\max}$  is the saturation level of growth, parameters  $u$  and  $c$  are reciprocal power exponents, and parameters  $a$  and  $b$  define the linear transformation for the interval scale of time. From the generalised reciprocal function derive four simpler S-shaped functions. If both power exponents are set to unity then that function is reduced to what we called the double-reciprocal linear function (Oppe and Koornstra, 1990), while if one is set to unity and the other to zero or if both approach zero then three other well-known functions are derived. One is the so-called log-reciprocal function, used in economy (Prais and Houthakker, 1955, Johnston, 1963), and the other two are the logistic function (Day, 1966, Maynard Smith, 1968), for the first time derived by Verhulst (1844), and the so-called Gompertz function (Gompertz, 1825), both used in biology and demography. If one power exponent is set to zero and the other not to unity or zero then the asymmetric logistic function (Nelder, 1961) or the generalised log-reciprocal function (Oppe and Koornstra, 1990) is derived from the generalised reciprocal function. All these functions are S-shaped functions that as functions of time are described in the next mathematical section.

The generalised reciprocal function for the S-shaped growth of system volume  $V$  at time  $t$  is defined in Oppe and Koornstra (1990) as

$$V_t = V_{\max} [1 + C(1 + u(x \cdot t + y))^{1/u}]^{-1/C}$$

where  $c$ ,  $u$ ,  $x$  and  $y$  and  $V_{\max}$  are parameters and  $t$  is time with  $V_{\max}$  as maximum growth level for  $t$  approaching infinity. It is simplified by

$$a = c^{-u} \cdot u \cdot x \quad \text{and} \quad b = C^{-u} \cdot (u \cdot y + 1)$$

to

$$V_t = V_{\max} [1 + (a \cdot t + b) \cdot t^{-1/u}]^{-1/c}$$

By the limit definition of the exponent, where  $\lim_{n \rightarrow 0} (1 + n \cdot m)^{1/n} = e^m$ , we obtain from the above expression by  $u \rightarrow 0$  and  $c > 0$  the so-called asymmetric logistic function

$$V_t = V_{\max} [1 + e^{a \cdot t + b}]^{-1/c}$$

where  $a = x < 0$  and  $b = y + \ln(c) > 0$  and if  $c=1$  then it is the symmetric logistic function. Of special interest is an asymmetric logistic function with  $c = \frac{1}{2}$  that derives from the assumption that the momentary maximum of existing system capacity  $V_{\max}$  becomes proportionally time-dependent increased by the same underlying symmetric logistic function for growth within the system of a momentary maximum capacity  $V_{\max, t}$ . Thus for

and

$$V_{\max, t} = V_{\max} \cdot [1 + e^{a(t-b)}]^{-1}$$

it describes the **double logistic** function for system growth by

$$V_t = V_{\max} \cdot [1 + e^{-a(t-b)}]^{-2}$$

where  $lie = 2$ . This double logistic model is due to Bonus (1968), who successfully tested the model for growth of annual television sales.

If  $c$  and  $u$  both approach zero, thus for  $lie$  approaching infinity in the asymmetric logistic function, then we obtain the **Gompertz function** for system growth that is written as

$$V_t = v_{\max} e^{-e^{-a(t+b)}}$$

For  $c \rightarrow 0$  and  $u > 0$  the generalised reciprocal function becomes the generalised **log-reciprocal function** that is defined by

$$V_t = V_{\max} e^{-(a-t+b)^{-k}}$$

where  $a = u'x$ ,  $b = u'y + 1$  and  $k = 1/u$ , while in the **log-reciprocal function** also  $u = 1$ , whereby  $k = 1$ ,  $a = x$  and  $b = y + 1$ .

The inflexion point for the generalised reciprocal can be anywhere, but for the **asymmetric logistic** growth the inflexion occurs at the time where  $t = [b - \ln(c)]/(-a)$ , thus where

$$V_t = (1 + c) / (1 + c + V_{\max}) \quad (\text{asymmetrically logistic})$$

Thus, for  $c = 1$  at  $t = -b/a$  and for  $c = \frac{1}{2}$  at  $t = [-b + \ln(c)]/a$ , whereby

$$V_t = 0.5 \cdot V_{\max} \quad (\text{logistic})$$

and

$$V_t = 0.4444 \cdot V_{\max} \quad (\text{double logistic})$$

For the Gompertz function with  $c \rightarrow 0$  it is reached at  $t = -b/a$ , whereby

$$V_t = \exp(-1) \cdot V_{\max} = 0.3679 \cdot V_{\max} \quad (\text{Gompertz})$$

For the generalised log-reciprocal function the inflexion occurs at time

$$t = [-b + \{k/(k+1)\}^{1/k}] / a$$

whereby

$$V_t = e^{-\{k/(k+1)\}^{1/k}} \cdot V_{\max} \quad (\text{generalised log-reciprocal})$$

and thus for  $k = 1$  at  $t = (b - \frac{1}{2})/(-a)$  where

$$V_t = 0.1353 \cdot V_{\max} \quad (\text{log-reciprocal})$$

while for  $k$  approaching infinity it equals the **Gompertz function**.

For the generalised reciprocal function an inflexion point exists, while its location depends on the values of  $u$  and  $c$ . Since its inflexion point

can be anywhere, it is the most general S-shaped function. But it has five parameters, where the symmetric logistic, the Gompertz and the 109-reciprocal function only have three parameters. It will be noticed that the Gompertz function becomes the lower limit function of the asymmetric logistic function as well as the upper limit function of the generalised log-reciprocal function, where the latter two have four parameters.

Except for the logistic function, all S-shaped growth functions are asymmetric. The simplest S-shaped growth functions have three parameters: two for the transfonnation of time and one for the maximum growth level. They are the symmetric logistic function with its inflexion point at the time where 50% of the maximum level is reached. the Gompertz function with its inflexion point at the time where the growth level is 36.79% of the maximum level, and the log-reciprocal function with its inflexion point at 13.53% of the maximum level. Given some time-series of annual growth data that passed the inflexion point of the underlying growth function without approaching the maximum level, the fit of the growth data by the log-reciprocal function, therefore, predicts the highest maximum growth level and the fit by the symmetric logistic function the lowest. Because of parsimoniousness these three functions are mainly used for the fit and prognosis of market growth for industrial products (Mertens, 1973), but it is often observed that the symmetric logistic function underestimates the maximum level of saturated market growth (Lewandowski, 1970). As will be shown below, this on the one hand also holds for the fit of annual data of national motor vehicle kilometres, while on the other hand the log-reciprocal function overestimates the maximum level of motor vehicle kilometres.

An overestimation of maximum level may also hold for the Gompertz function, but its fit to time-series of motor vehicle kilometres of nations only yields insignificantly larger error variances and maximum level parameters than the asymmetric logistic model with an additional asymmetry parameter. The asymmetric logistic function with the inflexion point below 50% of the maximum level has a finite asymmetry parameter  $lie > 1.0$ . It estimates the maximum level lower than the Gompertz growth function and higher than the symmetric logistic function. If one assumes a logistic function for traffic growth with a momentary existing maximum capacity and an identical logistic function for the proportional growth of that momentary maximum capacity, then the double logistic function with asymmetry parameter  $l/c = 2$  follows, which thus is an asymmetric logistic function with a prior, theoretically determined asymmetry parameter. It seems quite reasonable that the momentary maximum capacity of the traffic system is proportionally increased during the motorisation growth by the same proportional function as for the growth of motor vehicle kilometres within the traffic system with a momentary maximum capacity. This would lead to the double logistic function for the growth of motor vehicle kilometres, if traffic growth within a fixed road capacity is a symmetric logistic function. However, the volume of motor vehicle kilometres not only increases with the growth of the national fleet and the road network length, but also with the improved flow efficiency of the road infrastructure and with the average increase of traffic speed that is enabled by improving technologies for motor vehicles, traffic management, and road infrastructure. This leads to an even more asymmetric logistic growth of motor vehicle

kilometres and if also other traffic efficiency measures cumulatively increase the motor vehicle kilometres then Gompertz growth results from the multiplication of logistic functions for each underlying growth-contribution subsystem improvement. Since the asymmetric logistic function has an additional parameter for its asymmetry, it is a less parsimonious function with four parameters, but the double logistic function has a prior determined asymmetry parameter and, thus, is determined by three parameters, as also are the Gompertz and symmetric logistic functions.

Figure 43 pictures the fits of the exponential, the Gompertz, the double logistic and the symmetric logistic functions for the time series of the annual motor vehicle kilometres in the USA from 1923 to 1999. This time series of 76 years is the longest series of annual motor vehicle kilometres for a country available in 2001.

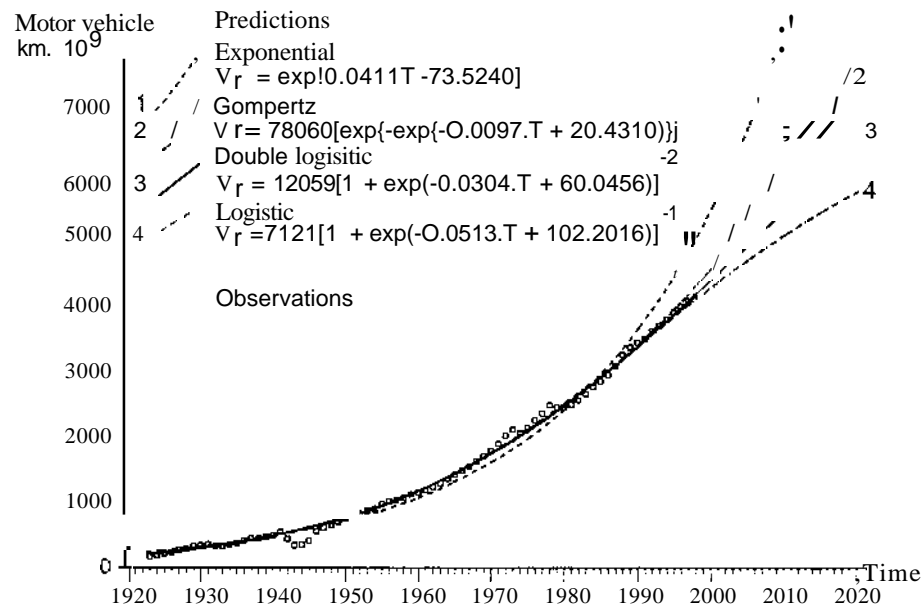

Figure 43. Fit of the exponential and S-shaped models/or traffic growth in the USA.

Figure 43 shows an almost always increasing traffic growth, but with the exceptions of some growth stagnating in the periods of the first and second oil crises of 1973-1974 and 1978-1979 as well as a marked decrease of motor vehicle kilometres after 1941 and a recovering growth at the end of World War II. Therefore, the data from 1942 to 1946 included are omitted from the fit of the growth functions. The fitting procedure that is based on iteratively weighted, alternating linear regressions (Wold, 1966) minimises the sum of squares of the logarithmic deviations for each of the growth models, because it is assumed that traffic-volume data have a constant coefficient of variation, whereby then the logarithm of the data stabilises the variance of the data values. As figure 43 shows, *traffic growth definitely is not exponential*. The error variance for exponential growth ( $ss = 0.751$ ,  $df = 70$ ) is significantly larger ( $F > 3.45$ ,  $P < .001$ ) than for Gompertz growth ( $ss = 0.224$ ,  $df = 69$ ) or double logistic growth ( $ss = 0.220$ ,  $df = 69$ ), while the latter two clearly are not significantly different. A hardly smaller sum of

squares for the logarithmic deviations is obtained for asymmetric logistic growth (optimally estimated asymmetry parameter  $c = 0.4679$ ), but due to the one additional parameter its standard deviation of error is even larger than for double logistic growth. The symmetric logistic growth also is not significantly worse ( $ss = 0.2251$ ,  $df = 69$ ). Although the Gompertz model fits the observed traffic growth data rather well, it predicts a very high saturating growth level of more than 8 times higher than the traffic volume in 1999. In view of the already high motorisation level in the USA, such a high maximum level of saturating traffic growth in the future is not realistic, although further growth will occur due to the ongoing immigration and population growth and the still somewhat further increasing motorisation in the USA. The double logistic model may seem more realistic, because predicting the maximum level to be almost three times higher than the traffic volume in 1999. The also insignificantly different symmetric logistic growth model yields a maximum growth level that is only 66% higher than the traffic volume in 1999. The insignificant differences between different S-shaped models show that the maximum traffic volume in the USA is not yet well determined, despite the significantly non-exponential nature of the traffic growth.

### 8.2.2. *Risk adaptation as time-dependent collective learning*

The volume of a self-organising system grows as long as there is an inherent utility for further growth, whether it is an evolutionary biological system with population growth that is driven by the selective reproduction from the survival of the fittest or a socio-economic, industrial and/or technological system with growth of products and/or services that is driven by the utility of the products or services for the consumer or user. Any growth also has adverse side effects, whether it is the diminishing population of other species by the biological evolution of the dominating species that share food resources or the ecologically adverse effects from industrial growth. For the growing system of motorised road transport the adverse side effects are the road accidents with fatalities and serious injuries as well as the polluting emissions from fossil energy use of motorised transport. In a comparable way to adaptation by selective survival and reproduction effects of random mutations that inherently accompanies the growth of biological evolutions, the adaptation from the replacing of subsystems by improved subsystems with fewer adverse side effects accompanies inherently the growth of socio-economic, industrial and/or technological systems. In road transport the growth is inherently adaptive by: 1) replacing more new for old cars, where new cars are safer and less polluting than the previous cars, 2) road rehabilitations and enlargements, where reconstructed and new roads are safer than previous roads, 3) more efficient traffic management and rules that also increase the safety of the road traffic system, and lastly 4) more drivers that are increasingly controlled by more effective enforcement on dangerous driving aspects and have in average more years of driving experience than in preceding phases of traffic growth.

All these aspects characterise an evolutionary growth of self-organising systems, wherein subsystems are replaced by more and better adapted subsystems (Fisher and Pry, 1971; Eigen and Schuster, 1979; Montroll, 1978; Jantsch 1980b). For the road traffic system and other self-organising systems the subsystem replacements cumulatively contribute to improved safety during the growth of the system. Since these safety improvements take time and are growth-dependent, we hypothesise that

risk decay of destructive subsystem failures is a function of delayed system growth. The cumulative effects of subsystem improvements during the system growth cause a regular decay of the system risk, defined as the number of self-destructive events with respect to the volume of the system. In the next mathematical section it is shown for each of the discussed S-shaped growth functions that their function differentials (ratios of derivative and level) are monotone decay functions of time. Remarkable is the fact that each of these derived monotone decay functions equals one of the mathematical learning models for probability of failures, developed in psychology (Sternberg, 1967), if the number of learning trials in these models is replaced by time. So assuming that system improvements per past period cumulatively define a time-dependent decrease of failure probability, it follows that the adaptation effects of system improvements can be conceived as a collective time-dependent learning process. Thereby, also the road fatality rate should relate to the ratio of the derivative and level of delayed growth of the traffic volume. This relationship has been derived and specified earlier (Koomstra, 1988; Oppe and Koomstra, 1990) by a proportional power function. Hence the rate  $R_t$  of fatal outcomes  $F$  with respect to the system volume  $V_t$  is hypothesised to be a proportional power function of the delayed growth rate with timelag  $\tau$ , as written by

$$R_t = w \{ \Delta[V_{t-\tau} | N_{t-T}] \} q$$

This hypothesis was originally not based on the now metrically formulated risk-adaptation theory, but on the relationships between mathematical learning models and risk models. However, if one assumes that objective risk of fatal outcomes from subsystem failures in the growing system is counteracted by improved subsystem replacements as some function of the experienced growth rate in the past, then the risk decay must be related to the differential of the delayed system growth or the derivative of the logarithm of its delayed growth, because one experiences the growth increase as the increase of the logarithm of the system growth. The risk-adaptation theory defines that the downward shifts of sensory risk-adaptation level causes the decay of the objective risk, while the risk-adaptation level is the logarithm of the average risk level. Consistent with the psychophysics of cross-modality matching, a logarithmic stimulus scale relates to another logarithmic stimulus scale by a linear function, which here applies to the logarithm of the risk level and the logarithm of the growth rate. Thus, in accordance with the psychophysics of the risk-adaptation theory, the logarithm of the risk level linearly relates to the logarithm of the delayed growth rate. In the next mathematical section it is shown for the discussed S-shaped growth functions that the differential of the growth function, defined by the ratio of the derivative and level of the growth function for the growing system, equals the derivative its logarithmic growth, which writes as

$$\Delta[V_{t-\tau} | N_{t-T}] = \Delta[\ln(V_{t-T})]$$

The hypothesis of a linear relationship between the logarithm of the risk level and the logarithm of the growth rate also implies that the risk equals a proportional power function of the derivative of the delayed logarithmic growth. Thus, secondly we obtain a specification of the relationship between traffic risks and delayed traffic-growth increases, which relationship should theoretically be formulated in the first place as

$$R_t = w\{\Delta[\ln(V_{t-\tau})]\}q$$

The empirical question concerns which compatible function types of S-shaped growth and risk decay simultaneously fit the long time series of national data.

since the logarithm of **asymmetric logistic growth** is written by

$$\ln(V_{t-\tau}) = \ln(V_{\max}) - (1/e) \cdot \ln(1 + e^{a \cdot t + b - a \cdot 1}),$$

we obtain for its derivative

$$\delta \ln(V_{t-\tau}) / \delta t = (-a/c) \cdot [1 + e^{-(a \cdot t + b - a \cdot 1)}]^{-1}$$

The derivative of **asymmetric logistic growth** itself is written by

$$\delta V_t / \delta t = (-a/c) \cdot V_{\max} \cdot [1 + e^{a \cdot t + b}]^{-1} \cdot e^{-(a \cdot t + b)}$$

or

$$[\delta V_t / \delta t] / V_t = (-a/c) \cdot [1 + e^{-(a \cdot t + b)}]^{-1}$$

$$[\delta V_{t-\tau} / \delta t] / V_{t-\tau} = \delta \ln(V_{t-\tau}) / \delta t = (-a/c) \cdot [1 + e^{-(a \cdot t + b - a \cdot 1)}]^{-1}$$

For the **Gompertz growth** its delayed logarithmic function becomes

$$\ln(V_{t-\tau}) = \ln(V_{\max}) - e^{a \cdot t + b - a \cdot 1}$$

and then we have for its derivative

$$\delta \ln(V_{t-\tau}) / \delta t = -a \cdot e^{a \cdot t + b - a \cdot 1}$$

while the derivative of the Gompertz growth itself is written by

$$\delta V_t / \delta t = -a \cdot V_{\max} \cdot e^{-e^{a \cdot t + b}} \cdot e^{a \cdot t + b} = -a \cdot V_t \cdot e^{a \cdot t + b}$$

Thus, here the same equivalence is obtained as

$$[\delta V_{t-1} / \delta t] / V_{t-1} = \delta \ln(V_{t-1}) / \delta t = -a \cdot e^{a \cdot t + b - a \cdot c}$$

For the **generalised log-reciprocal growth** one obtains the logarithm as

$$\ln(V_{t-1}) = \ln(V_{\max}) - (a \cdot t + b - a \cdot 1)^{-k}$$

and its derivative as

$$\delta \ln(V_{t-1}) / \delta t = a \cdot k \cdot (a \cdot t + b - a \cdot 1)^{-(k+1)}$$

while

$$\delta V_t / \delta t = a \cdot k \cdot V_{\max} \cdot e^{-(a \cdot t + b - a \cdot 1)^{-k}} \cdot (a \cdot t + b - a \cdot 1)^{-(k+1)}$$

or

$$[\delta V_t / \delta t] / V_t = a \cdot k \cdot (a \cdot t + b - a \cdot 1)^{-(k+1)}$$

Thus, the same equivalence holds and writes here as

$$[\delta V_{t-\tau} / \delta t] / V_{t-\tau} = \delta \ln(V_{t-\tau}) / \delta t = a \cdot k \cdot (a \cdot t + b - a \cdot 1)^{-(k+1)}$$

Notice that these three functions are monotone decay functions of time, which resemble the three functions from mathematical learning theories (Sternberg, 1967) in psychology, if  $n$  as number of learning trials is replaced by  $t$  as time. These well-known classical learning models are the beta-model (Luce, 1959b), the linear operator model (Bush and Mosteller, 1955) and the urn model (Audley and Jonckheere, 1956), where failure probability is defined as function of the number  $n$  of learning trials with a fixed reinforcement schedule by

$$\begin{aligned} \text{or } P_n &= [1 + e^{-(X \cdot n + y)}]^{-1} && \text{(beta-model),} \\ \text{or } P_n &= e^{X \cdot n + y} && \text{(linear operator model),} \\ \text{or } P_n &= (x \cdot n + y)^{-z} && \text{(generalised urn model).} \end{aligned}$$

Substituting  $t = n$ ,  $a = \kappa$ ,  $b - a \cdot \tau = y$ , we see for each of the derived functions that we can write for a differently defined constant  $r$

$$[c \cdot V_t / \delta t] / V_{t-1} = \ln(V_t / V_{t-1}) / \delta t = r \cdot P_t.$$

Growth of a system is defined as the replacement of subsystems by more and improved subsystems. Therefore, the first hypothesis could be that the adaptation process from the improved subsystems defines a collective learning process where the rate  $R_t$  as rate of self-destructive outcomes  $F_t$  with respect to the system volume  $V_t$  is a function of the increase of the growth sensation in the past, which is expressed by

$$R_t = F_t / V_t = \ln[V_t / V_{t-\tau}] / \delta t = r \cdot P_t.$$

The additional hypothesis is that the risk of fatal side effects of the growth, such as the fatality risk from motorised traffic growth, are collectively counteracted by subsystem improvements in a way that average average Fechner risk sensation of fatal side effects with respect to the growth level, written as  $\ln[R_t] = \ln[F_t / V_t]$ , is a linear function of the Fechner sensation of the delayed growth rate, written by means of its derivative definition as  $\ln[(\delta V_t / \delta t) / V_{t-\tau}]$ . Thus

$$\ln(F_t / V_t) = y + q \cdot \ln[(\delta V_t / \delta t) / V_{t-\tau}].$$

Taking exponents it follows that the rate  $R_t = F_t / V_t$  is given by

$$R_t = F_t / V_t = w \cdot [(\delta V_t / \delta t) / V_{t-\tau}]^q,$$

where,  $\tau$  is the time delay with respect to time  $t$  and  $w = \exp(y)$ . For the asymmetrically logistic growth function it becomes written as

$$\begin{aligned} \text{or } R_t &= R_{\max} \cdot [1 + e^{-(a \cdot t + b - a \cdot \tau)}]^{-q} \\ R_t &= R_{\max} \cdot [1 + e^{-(a \cdot t + \beta)}]^{-q} && \text{(asymmetric logistic decay)} \end{aligned}$$

which for  $q = 1$  equals the beta model. It can be rewritten as

$$R_{\max} \cdot (V_t / V_{t-\tau})^{c \cdot q} \cdot e^{\alpha \cdot t + \beta} \cdot V_{t-\tau}^{-\alpha \cdot t + \gamma}$$



where  $\alpha = q \cdot a$ ,  $\beta = q \cdot (b - a \cdot \tau)$ ,  $R_{\max} = w \cdot (-a!c)^q$ ,  $s = C'q$ , as well as  $y = \beta + \ln ER_{\max} / s \cdot \ln(V_{\max})$ .

For Gompertz growth, consistent with  $s = 0$  by  $c = 0$ , we obtain

$$R_t = e^{-\alpha \cdot t + \beta} \quad (\text{exponential decay})$$

where  $\alpha = q \cdot a$  and  $\beta = q \cdot (b - a \cdot \tau) + q \cdot \ln(-a) + \ln(w)$ . It equals the linear operator model.

For the generalised log-reciprocal growth function we obtain

$$R_t = (\alpha \cdot t + \beta)^{-z} \quad (\text{gen. lin. reciprocal decay})$$

where  $z = q \cdot (k+1)$ ,  $\alpha = Y'a$  and  $\beta = y' \cdot (b - a'c)$  for  $y = [w \cdot (a \cdot k)]^{-1/z}$ . It equals the urn model. Notice that the latter two functions are both monotonic decreasing without an inflexion, while the other function is an asymmetric reverse, S-shaped function.

For asymmetric logistic and Gompertz growth it defines the slope of the risk function to depend on the slope for the growth function and for the exponential risk decay also on power exponent  $q$ , where the parameter  $\beta$  in  $R_t$  becomes an arbitrary parameter by the ratio-scale factor for  $V_t$ . These are the two alternatives that fit long term time-series for the growth of annual motor vehicle kilometres of all countries that have been researched better than the log-reciprocal growth function. Also the long time-series of annual fatality rates with respect to the motor vehicle kilometres of countries macroscopically fit the exponential function rather well (Broughton, 1988; Oppe and Koornstra, 1990; Oppe, 1991a,b; Koornstra, 1992, 1993, 1995, 1997a, b).

In the mathematical section above it is shown that the decay of the fatality rates, as ratio of fatalities and the volume of the growing system, can be described on the basis of our hypothesis by a proportional power function of the delayed growth rate for the previously discussed S-shaped growth functions. These decay functions are either reversed, S-shaped functions or decay functions without an inflexion point. If the growth function is the Gompertz function then the correspondingly derived risk decay function is an exponential function. Since road fatality rates of many countries are well described by an exponential decay function, it would imply that their traffic growth should fit the Gompertz function. Based on the risk-adaptation theory and the basic assumption that the cumulative effects of traffic-system improvements make risks proportional to a power function of delayed growth rates, it theoretically follows that the slope of risk decay depends on the slope of the growth function.

Formany countries it is shown that traffic growth is indeed rather well described by the Gompertz growth function of time (Oppe and Koomstra, 1990; Koomstra, 1992, 1993, 1995, 1997a,b) and that the national developments of road fatality rates macroscopically are also well described by an exponential decay function (Chatfield, 1987; Broughton, 1988; Koomstra, 1987, 1988,; Oppe and Koomstra, 1990; Oppe, 1991a,b; Koomstra, 1992, 1993, 1995, 1997a,b, ETSC, 1999,2003). Forthe firsttime Oppe (1991 a,b) empirically found that the slope parameter for exponential decay of the

fatality rate (ratio of fatalities and motor vehicle kilometres) equals half the slope parameter of the symmetric logistic function for motorised traffic growth. The symmetric logistic function for growth of annual motor vehicle kilometres, however, is now known to underestimate the maximum level of traffic growth, while exponential risk decay generally differs insignificantly from other risk decay functions (such as reversed, asymmetric logistic functions with its inflexion point long before the first year of the annual risk data). Below figure 44 shows the fit of two time-dependent risk decay models for fatality rates in the USA, wherein again World War II data are omitted.

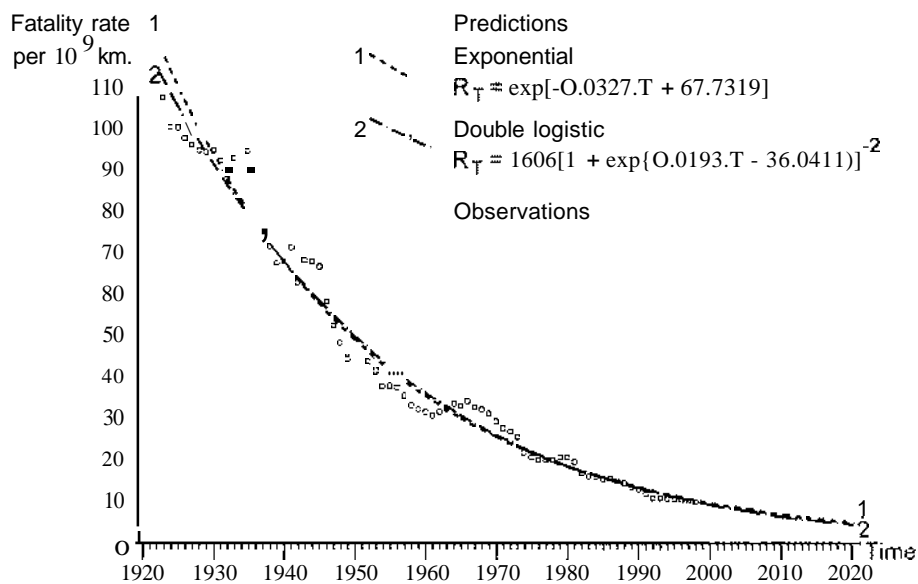

Figure 44. Fit of the exponential and double logistic fatality rate decay in the USA

The risk decay models are fitted without constraints in order to check whether the slope parameter for the risk function is related to the slope parameter for the fitted growth functions, as hypothesised by our derivations for particular combinations of traffic growth and risk decay functions. The fitting of the risk decay function minimises the Chi-square for deviations of predicted fatalities obtained from the product of estimated fatality rates and observed motor vehicle kilometres. Omitting the years 1942-'45, the fit of the exponential risk decay yields a Chi-square of 23678 ( $df = 70$ ), while the double-logistic risk decay shows a somewhat smaller Chi-square of 22590 ( $df = 69$ ). These Chi-squares are very large, due to periodical, marked deviations from the fitted risk trend that are multiplied by billions of kilometres for the estimation of fatalities. In Koomstra (1992, 1997a,b) it is shown that harmonic cosine cycles for deviations around the exponential trend reduce the Chi-square significantly, but here we concentrate on the macro-development trend. The fitted asymmetric logistic decay reduces by its zero approaching asymmetry parameter to a reversed Gompertz decay function with Chi-square of 22359 ( $df = 69$ ), while the fit of the symmetric logistic decay function yields Chi-square of 22776 ( $df = 69$ ). The exponential decay function of risks is to be preferred, since it has only two parameters and is insignificantly

different from the somewhat better fitting asymmetric S-shaped functions with more parameters. As shown in the last mathematical section the risk decay function is a proportional power function of the growth rate, whereby Gompertz growth corresponds to exponential risk decay, where their slope parameters are theoretically related by a proportional factor  $q$ . On the basis of our risk-adaptation theory that proportional factor should be  $q \approx 1.5$  for  $\alpha \approx q \cdot a$  where  $a$  is the slope parameter for the Gompertz growth of traffic exposure and  $\alpha$  the slope parameter for the exponential fatality risk decay. In figure 45 we picture the relationship between slope parameters of Gompertz growth and exponential risk functions that are fitted to seven countries whereof time-series of consistently defined data are available for more than 45 postwar years.

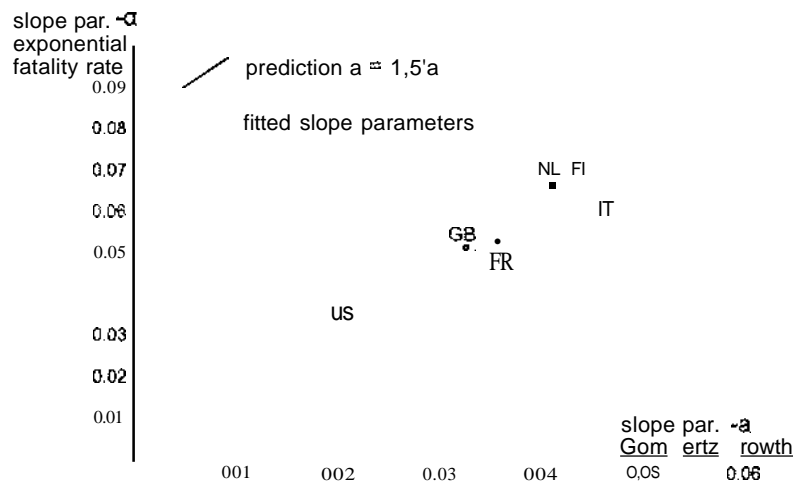

Figure 45. Slope parameters of Gompertz growth and exponential risk decay.

Comparing the slope parameters for risk decay and traffic growth of several countries, it turns out that the slope parameter for the exponential decay of the fatality rate is indeed rather well determined by about 1.5 times the slope parameter of the Gompertz function for traffic growth. However, the slope parameter for Gompertz growth depends on the parameter for the maximum level of growth that is not always well-determined. Except for the USA all countries in figure 45 have growth curves with rather clearly visible inflexion points before 1983, whereby for the other six countries the fitted Gompertz growth functions have estimated maximum levels that are well determined between 54% (Italy) to 74% (Great Britain) higher than their volumes in 1999. Since we have no clear inflexion point for the traffic growth in the USA, a maximum level for its traffic growth is hard to determine in a valid way. For data from 1947 to 1999 of the USA the optimally fitted Gompertz curve estimates an unrealistically high maximum of 19010 billion km<sup>2</sup> which is more than 4 times higher than the traffic volume in 1999. Therefore, we constrained the estimation of the Gompertz function by a maximum level that locates the inflexion point of the Gompertz function just before 2000. It yields a maximum level of 10900 billion kilometres and slope parameter  $a = -0.0203$ , instead of  $a = -0.0160$  for the optimal Gompertz function with its unrealistically high maximum level, but the optimal function (sum of squares

for logarithmic deviations:  $ss = 0.3669$ ,  $df = 50$ ) only shows a just insignificantly smaller error variance ( $F = 1.52$  with  $p = .08$ ) than the constraint function ( $ss = 0.5564$ ,  $df = 49$ ). A proportional relationship between the slope parameters of the risk decay and the traffic growth function has already been verified for six countries by Oppe (199] a), but Oppe fitted traffic growth by symmetric-logistic functions and fatality rates by exponential decay functions. The estimated maximum levels have been underestimated by the fit of the symmetric-logistic growth functions of Oppe, because nowadays five out of six countries (the exception is the USA) have higher traffic volumes than the estimated maximum levels by Oppe and still have markedly growing traffic volumes. Therefore, the Gompertz function likely is the valid growth function with an equal number of parameters. Moreover, our assumption of a proportional power relationship between the fatality and growth rates holds for the Gompertz function and exponential risk decay, while our risk-adaptation theory defines the relationship between their slope parameters to be proportional by factor  $q = 1/2$ . Figure 45 indeed reveals a well fitting proportionality factor of  $1/2$ , which contributes to evidence for our risk-adaptation theory. Taking this proportional relationship as given, the fitted slope parameters of the fatality rate also determine the growth slope parameters, whereby also its maximum levels of Gompertz growth become determined on levels that fit not significantly worse compared to its unconstraint function fits. Therefore, it is concluded that the fatality rate reduction is an exponential decay function and that growth of motor vehicle kilometres is well described by the Gompertz function with  $2/3$  smaller slope parameter than for the exponential risk decay. As discussed next, it not only yields well-fitting maximum growth levels, but also proves that the traffic risk decay depends on traffic growth.

### 8.2.3. *Fatality rate as function of delayed traffic growth*

The next mathematical section describes time-series of annual fatalities as function of delayed traffic growth data, based on the proportionality between the slope parameters for the Gompertz growth and exponential risk decay functions. Since Gompertz growth implies that

$$\Delta[\ln(V_{t-r})] = [\delta V_{\text{tot}} / \delta t] / V_{\text{tot}} = -a \cdot \ln(V_{\text{max}} / V_{t-r}) = e^{a \cdot t + b}, \quad | a < 0$$

where  $a$  is the negatively signed slope parameter of growth, the derived expression for fatality rates as constraint function of delayed motor vehicle kilometres is written by

$$R_t = w \cdot \{\ln[V_{\text{max}} / V_{\text{tot}}]\}^q = e^{\alpha \cdot t + \beta} \quad | \alpha = q \cdot a < 0, q = 1.5$$

If we fit the fatality rate time-series as function of delayed traffic volumes and as exponential function of time then all parameters of the Gompertz function for traffic growth are determined  $\{a = \alpha/q, b = \beta/q - \ln(w) + aT - \ln(-a), \text{ and } V_{\text{max}}\}$  without actually fitting the data time-series for the growth of motor vehicle kilometres. Since the parameters for both fatality rate functions are weB-determined, also the parameters of the Gompertz function become determined, even if traffic growth has not passed its intlexion point. We used an iteratively weighted least squares regression method (Wold, 1966) for both fatality rate functions that minimises the Chi-square for the fatalities as product of predicted fatality rates and observed motor vehicle kilometres,

because a Poisson distribution is assumed for fatalities. The exponential risk decay has two estimated parameters and the risk decay as function of delayed traffic growth that contains also a time-lag parameter has three estimated parameters. If  $q = 1.5$  then the Gompem growth function is determined by these estimated parameters without fitting the traffic growth data. The unconstraint fit of Gompertz growth has by definition a smaller error variance than the Gompertz growth with a-priori parameters, but if the theory holds then their error variances are only insignificantly different.

Based on the assumption that the fatality rate is a proportional power function of the delayed growth rate we obtain for the Gompertz growth and exponential risk functions that

$$-a \cdot \ln(V_{\max} / V_{t-\tau}) = [\delta V_{t-\tau} / \delta t] / V_{t-\tau} = -a \cdot e^{a \cdot (t-\tau)} + b$$

$$\hat{R}_t = \hat{F}_t / \hat{V}_t = r \cdot \{ \ln[V_{\max} / \hat{V}_{t-\tau}] \}^q$$

where  $r = w \cdot (-a) \cdot q$ . For the given value of  $q = 1.5$  we can write the following weighted regression equation for to solve parameters  $y$  and  $x$

for  $w_{t,k} \cdot R_t^{1/q} = w_{t,k} \{ y - x \cdot \ln(V_{\max} / V_{t-\tau}) \} + E_{t,k}$

$$x_k^{1/q} = r_k \quad \text{or} \quad r_k^q = x_k$$

$$y_k = x_k \cdot \ln(V_{\max,k}) \quad \text{or} \quad V_{\max,k} = \exp(y_k / x_k)$$

which is iteratively solved for  $V_{\max}$  and  $r$  by  $w_{t,1} = 1$  and for  $k > 1$  by  $w_{t,k}$  defined as

where  $w_{t,k} = \frac{\hat{F}_{t,k-1} / \sqrt{\hat{F}_{t,k-1}}}{[\hat{R}_{t,k-1}]^{1/q}}$

$$E_{t,k} \cdot w_{t,k} = (F_t - F_{t,k-1}) / \sqrt{F_{t,k-1}}$$

then minimises the Chi-square for deviations from  $F_t$  by the converging weights  $w_t = w_{t,k} \approx w_{t,k-1}$  and solves the improved value of  $V_{\max}$  and  $r$ , while optimal lag  $\tau$  becomes determined by successive values  $\tau = 1, \dots, m$  for the solutions with minimised Chi-squares of  $F_t$ . Next we iteratively solve the following weighted regression equation

$$w_{t,k} \cdot \ln[R_t] = w_{t,k} [\alpha \cdot t + \beta] + E_{t,k}$$

with  $w_{t,1} = 1$  for  $k=1$  and for  $k > 1$  with

where  $w_{t,k} = \frac{(F_t - \hat{F}_{t,k-1}) / \sqrt{\hat{F}_{t,k-1}}}{J \cdot \{ \ln[\hat{R}_{t,k-1}] - \ln[R_t] \}}$

$$E_{t,k} \cdot w_{t,k} = (F_t - F_{t,k-1}) / \sqrt{F_{t,k-1}}$$

which again minimises the Chi-square for deviations from  $F_t$  by converging weight  $w_t = w_{t,k} \approx w_{t,k-1}$  and solves the values of  $\alpha$  and  $\beta$ .

From the solution of  $\alpha$  and  $\beta$  and the solved values of the  $r$  parameter and time lag  $\tau$  we also solve the Gompertz growth function, where

$$a = \alpha/q \text{ and } b = \beta/q - \ln(r) + a \cdot \tau - \ln(-a).$$

Thereby, we solved all parameters for the Gompertz growth function

$$V_t = V_{\max} \cdot e^{-e^{-a \cdot t + b}} + E_t$$

without fitting  $V_t$ . whereby the risk decay function satisfies

$$F_t \cdot IV_t = w \cdot [\delta / \delta t (V_{t-1} / V_{t-1})] \cdot q.$$

The derived traffic growth functions, based on proportionality  $q = 1.5$  between the slope parameters of Gompertz growth and exponential risk decay, are illustrated in the next figures for the development of road fatalities in the USA and The Netherlands, where the annual data from 1946 to 1999 for the USA and from 1947 to 1999 for The Netherlands are used in order to avoid a possible disturbance by the reduced traffic volumes during World War II. In figures 46 for the USA and 47 for The Netherlands we show three curves of differently predicted fatalities and the observed fatalities.

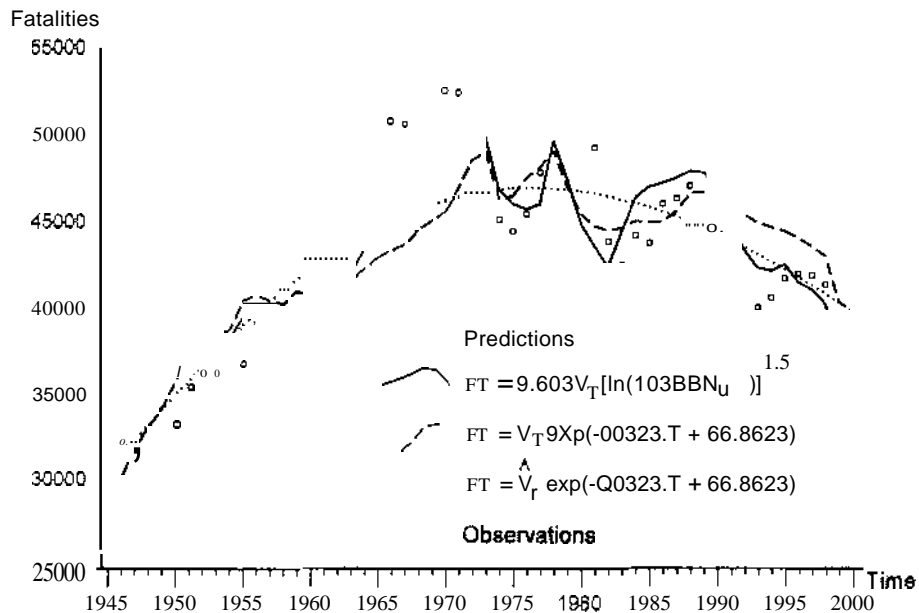

Figure 46. Predictions and observations of road fatalities in the USA.

The exponential equation of predicted fatality rates in the USA for the data from 1946 to 1999 is

$$R_t = Ft/Nt = \exp(-0.0323.t + 66.8623).$$

Multiplied by the observed traffic volumes it gives the estimated fatalities of the segmented line in figure 46 and shows a minimised, but very large Chi-square = 18153 with  $df = 52$ . The predicted fatality rate is alternatively obtained from the described function of delayed traffic volumes as

$$R_t = FtN_t = 9.603[\ln(10388N_{t-4})]^{1.5},$$

where  $V_{\max} = 10388$  billion km. and the optimal time lag four years (five years fits almost as well). Its multiplication by the observed traffic volumes presents the estimated fatalities of the solid line in figure 46 and yields a minimised, smaller Chi-square of 12249 with only 48 degrees of freedom. because by the time lag we have lost four observation years. The latter fits better, as shown in figure 46, but not significantly better ( $F = 1.37$ ;  $p = .15$ ). Combining these equations we obtain the Gompertz function for traffic growth without fitting any parameter as

$$V_t = 10388.\exp[-\exp(-0.0214.t + 44.640)].$$

It yields a sum of squares for logarithmic deviations of  $ss = 0.062$  with  $df = 54$  (no fitted parameter). Compared with the unconstrained fittings in the previous subsection this is relatively good fit, despite the much lower maximum level (although still about twice the volume of 1999). The product of the first and last prediction equations gives the macroscopic fatality development as the dotted line of figure 46.

For The Netherlands we obtained by the described function of delayed traffic volumes a prediction of fatalities (Chi-square = 255 with  $df = 43$  due to time delay of 10 years) that is significantly better than the prediction from the product of observed motor vehicle kilometres and the fitted exponential decay for the fatality rate (Chi-square = 1534,  $df = 51$ ), as can clearly be seen from the better fit of the solid than segmented lines in figure 47 ( $F = 5.4S$ ;  $p < 0.001$ ).

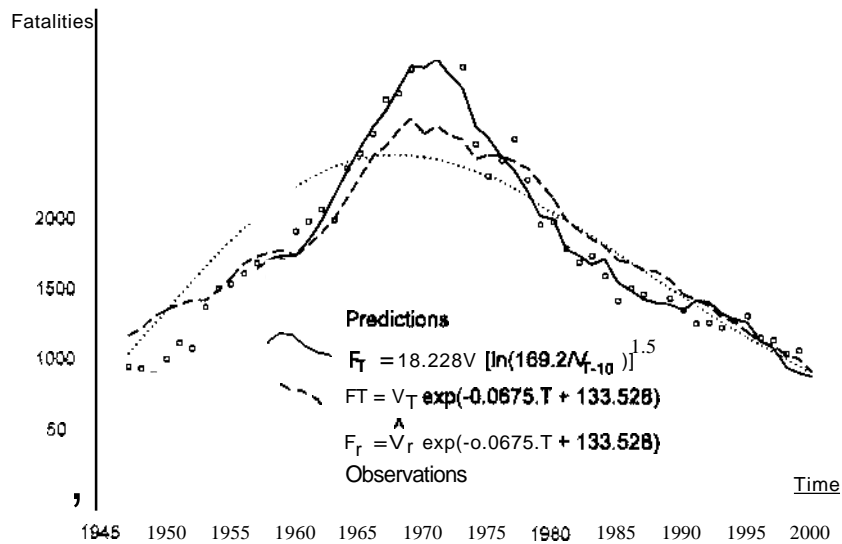

Figure 47. Predictions and observations of the road fatalities in The Netherlands

The exponential equation for the predicted fatality rate in The Netherlands for the data from  $t=1947$  to  $t=1999$  is estimated as

$$R_t = FtN_t = \exp(-0.0657.t + 133.528).$$

Multiplication with the observed traffic volumes gives the estimated fatalities of the segmented line in figure 47 (Chi-square = 1534, df = 51). The Dutch fatality rate obtained from the described function of delayed traffic volumes is described by

$$R_t = F_t N_t = 18.288 [\ln(169 N_t - 10)]^{1.5},$$

where the optimal time lag is 10 years and the estimated maximum level  $V_{\max} = 169$  billion km. Here the multiplication with the observed traffic volumes <sup>max</sup> gives the estimated fatalities of the solid line in figure 47 (Chi-square = 255 with df = 43, due to the time lag of 10 years). Again combining these equations we derive the underlying Gompertz function for the traffic growth in The Netherlands without fitting that function to the data. It writes as

$$V_t = 169 \cdot \exp[-\exp(-0.0438 \cdot t + 85.546)]$$

and yields a sum of squares for logarithmic deviations of  $ss = 0.499$  with  $df = 53$ , because again the theoretically derived expression gives no loss of degrees of freedom. Compared with the sum of squares of 0.361 for the unconstrained fitting of the Gompertz function of time the difference is insignificant ( $F = 1.36$ ,  $p = 0.15$ ), but the maximum level for the unconstrained fit is 15% higher. The product of the first and last prediction equations gives the macroscopic fatality development of the dotted line of figure 47.

The differences between the dotted and segmented lines in figures 46 and 47 are due to alternating periods of positive and negative difference between observed and derived vehicle kilometres (not estimated by fitting the Gompertz function, but theoretically derived). The periods of negative and positive deviations of the observed fatalities from the segmented lines are due to the deviations of the observed fatality rates from the estimated fatality rates by the exponential risk decay function. Close inspection reveals that periods of higher observed volumes than estimated are followed after a number of years by periods of lower observed fatality rates than estimated and that the same holds for succeeding periods with lower observed volumes and higher observed fatality rates than estimated. The time lag between these periods of underestimated and overestimated volumes and respectively overestimated and underestimated fatality rates, however, means also that periods of reduced volume growth and accelerated risk decay overlap during shorter periods and vice versa also, which causes the relatively larger over- and underestimations of the fatalities of the dotted lines in figures 46 and 47. One underestimation period of the fatality rate is clearly visible for the segmented line in the period between 1964 and 1974 in figures 46 and 47. The better fit of the solid line predictions, especially for The Netherlands, proves that the deviations of predicted traffic volumes and fatality rates are negatively delayed-correlated, because their underlying fatality rates are estimated by a linear function of the logarithm of delayed traffic volumes. For the USA that time-lag is four to five years for the fatality predictions that are represented by the solid line in figure 46, but in contrast to the Netherlands this prediction for the USA is not significantly better than the fatality prediction from the exponential fatality rate, represented by the segmented line in figure 46. What we have not used here, due to many more lost years for the prediction, is an also present time-lag of 21 to 22 years that by a weighted combination with the 4 to 5 years time-lag yields a significantly better prediction of the



fatalities for the remaining last 33 years in the USA. The gap between the time-lags of 4 to 5 and 21 to 22 years suggests cyclic deviations with periods of  $17\frac{1}{2}$  and/or 35 years for the Gompertz traffic growth and for the exponential decay of fatality rates in the USA. In Koomstra (1992, 1997a, b) it is shown that the deviations from the exponential fatality rate for the USA can be described by three harmonic cosine cycles with periods of 35, 17.5 and 8.75 years, while the deviations around the logarithm of Gompertz growth for the USA show a similar pattern of shifted cycles with smaller amplitudes. Since we showed that the fatality rate is proportional to a power function of the ratio of derivative and level of the delayed Gompertz growth, while the derivative of cosine cycles are sine cycles that are identically shaped and shifted forward by a quarter of their periods, we regard the fitted prediction time lag of 4 to 5 years to be due to the derivative of the dominating growth deviation cycle of  $17\frac{1}{2}$  years. If this is true then the prediction time lag of 10 years for The Netherlands would mean that there is a dominating deviation cycle of 40 years for Gompertz growth in The Netherlands. Inspection indeed clearly reveals cyclic deviations from Gompertz growth with a 40-year period, which is also visible from the dotted line for predicted fatalities in figure 47 where a 20-year period of overestimation from 1945 to 1965 is followed by 20 years of underestimation from 1965 to 1985, while again overestimation thereafter is present. Time-dependent cosine cycles for the simultaneous fit of periodical deviations around Gompertz growth and exponential risk decay have been used by Koomstra (1992, 1993, 1995, 1997a,b) for description of periodical deviations around the main trends and for short term prognoses of traffic growth and risk in many highly motorised or motorising countries. Although such additional deviation cycles may be useful for the description and short term extrapolation of periodically correlated deviations from the original growth and risk functions, the validity of long their term extrapolations can be doubted.

Nonetheless, not only the exponential decay function follows from the derivative of the Gompertz function, but also the derivatives of deviation cycles around Gompertz growth define cyclic deviations around the exponential fatality, where the amplitudes of the risk-deviation cycles should then be enlarged by  $q = 1.5$  and shifted by a quarter of the cycle periods with respect to the deviation cycles for growth. These actually observed cycle shifts and enlarged cycle amplitudes are to be regarded as further evidence for the hypothesis that fatality rates are proportional to a power function of the growth rate of traffic volumes. The shifts and enlarged amplitudes of risk deviation cycles with respect to cyclic traffic growth deviations cause an overlap of averaged quart-cycle periods with stagnated risk decay and enhanced traffic growth and the reverse overlap for an averaged half-cycle period earlier and later. Thereby, we predict marked fatality deviations around the main single-peaked trend of fatalities as predicted by the product of the fitted Gompertz function for traffic growth and fitted exponential decay function for fatality rates, which is verified by the fit of predicted fatalities as product of the fitted fatality rate and traffic growth functions with deviation cycles (Koomstra, 1992, 1993, 1995, 1997a,b). The relationship between cyclic deviations from their main trend function trends of traffic risk and growth and the fact that the power exponent of the growth rate for the prediction of the fatality rate defines a constant factor ( $q \approx 1.5$ ) for the slope-parameter ratio of their main trend functions can both be seen as evidence for the assumption that the risk development depends on

the traffic growth and as evidence for our risk-adaptation theory. Notice that the dependence of traffic risk decay on traffic growth implies not that the development of traffic risk is an autonomous process, but that cumulative safety improvements are inherent to traffic growth in democratic nations (notice that dictatorial states hardly show any motorisation growth). In democratic countries the national, regional, and local authorities will take actions for further traffic safety and other traffic improvements (reduction of polluting emissions, etc), if the growing economy provides the resources and motorised transport kills and pollutes, because such actions will contribute to the welfare of the inhabitants and to the popularity and reelections of the authorities, which is just one example of the many feedback loops in the socio-economic, technological systems of democratic societies (Laszlo, et al., 1974).

### 8.3. General theory of technological evolution and adaptation

The models for fatality rate and traffic growth are also applied to other adverse outcomes of road traffic, such as injuries (Koomstra, 1988; Oppe and Koomstra, 1990; Commandeur and Koomstra, 2001) and polluting traffic emissions (Koomstra, 1997a,b). We have shown that the rate of slight injuries per volume of traffic may not reduce to zero for time approaching infinity in contrast to fatality rates and rates of serious injuries. While the exponential decay functions of injury and several traffic emission rates (except the carbon dioxide rate that shows no decay) have smaller slope parameters than the fatality rate. The fatality rates per amount of passenger kilometres also decay exponentially for rail and air transport (ETSC, 1999). We have not analysed other data than for transportation systems, but in developed countries also the industrial fatalities markedly reduced from about a hundred and sixty per million inhabitants annually at the end of the 19th century to about five per million inhabitants annually nowadays, while their industrial production multiplied many times. Similarly air quality in the Rotterdam region worsened up to mid seventies of the 20<sup>th</sup> century, due the regionally increasing petrochemical industry, but improved thereafter. Nowadays the air quality in that region is better than in the fifties of the 20<sup>th</sup> century, despite further growth of petrochemical industry. Similar facts hold for air pollution in the Ruhrregion of Germany and in the regions of Paris and London. Therefore, we have assumed that adaptive decay of adverse outcome rates characterise all evolutionary growth of socio-economic, technological systems (Koomstra, 1992). In the same way as for biological system evolutions an adaptive reduction of adverse outcomes is inherent to evolutions of socio-economic, technological systems, whether it is a transport, an industrial, or another technological system, because as for biological systems (Eigen and Schuster, 1979; Jantsch, 1980b) and physical self-organising systems (Nicolis and Prigogine, 1977, Jantsch, 1980a; Prigogine and Stengers, 1984) also socio-economic, technological systems are characterised by self-organising system growth that is based on the replacement of hyper-cyclically interacting subsystems by multiples of identical and/or adapted subsystems. The difference with biological systems only is that their growth and adaptation are driven by survivability-improving selections of random mutations and guided by laws of nature (Eigen and Winkler, 1975), while technological growth and adaptation are driven by the socio-economic utility of purposefully selected,

technological innovations and guided by the control of political authorities in democratic societies. Notice that an adaptive growth of technological systems usually is absent in non-democratic countries, especially for systems of consumer products.

Our constraint model for growth and adaptation in road traffic and research results of similar growth models for other technological systems by other researchers (Fisher and Pry, 1971; Hennan and Montroll, 1972; Montroll, 1978) ask for the formulation of a more general theory. We have formulated a generalisation of our theory for the adaptive transport evolution to a theory for evolution and adaptation of socio-economically self-organising, technological systems, (Oppe and Koomstra, 1990; Koomstra, 1992). Here we reformulate that general theory for the adaptive evolution of technological systems in terms of first principles and restrict the theory formulation on the basis of related Gompertz growth and exponential risk decay, due to now gathered empirical evidence for these related functions. Firstly we define what we mean by adaptive evolution of self-organising systems and then formulate postulates and principles for their system growth and adaptation.

Definition of adaptive evolution of self-organising systems

*Evolution of a system is the result of self-organised replacements of (hypercyclic) interacting subsystems by multiples of identical and/or further adapted subsystems.*

Postulate 1 of adaptive evolution

*In absence of growth-inhibiting and temporarily and/or randomly growth-accelerating or growth-detering factors, the time-dependent volume growth of an evolutionary system (or growth of total system throughput or output) - caused by self-organised, multiple replacements of its subsystems - is defined for time  $t$  by*

$$M_t = e^{a \cdot t + b} \quad | \quad a > 0, b < 0.$$

This clearly is Malthus' law of exponential growth, but we rather characterise it in the spirit of Montroll's Newtonian analysis of social system dynamics (Montroll, 1978) by a constant growth force as defined by the differential of the growth  $a = [\delta M / \delta t] / M_t$ . An uninhibited growth is postulated to occur in absence of any disutility for growth and in absence of temporary and/or randomly growth-disturbing factors, in the same way as Newton's principles of motion postulate a constant acceleration of falling objects in absence of any resistance. Thus, we equivalently formulate:

Principle 1 of adaptive evolution

*In absence of growth-inhibiting and temporarily and/or randomly growth-accelerating or -detering forces the growth force of an evolutionary system, defined by differential of the time-dependent growth function (its derivative divided by its level), is constant.*

Hereby, time-dependent system growth in absence of growth inhibiting and disturbing forces is an exponential function of time. However, an initially almost exponential growth must be followed by diminishing volume increases, because any physical growth asks for more dissipation of energy for the production of more subsystems, while any growing system is embedded in a limited macro-system and also has side effects that reduce the constant force of its underlying uninhibited growth. Energy is not unlimited and system growth asks for space that also is not unlimited, while growth

of a system often has also negative side effects on the growth of its own system, such as self-destructive outcomes by randomly occurring failures in the interactive functioning of its adaptively improved subsystems. Therefore, any system growth is also simultaneously influenced by a growth reducing function that operates on the underlying exponential growth. This has been shown to be the case for the growth of the road transport system, also for the USA where the traffic growth seems not to have passed its inflexion point, but definitely is also lower than exponential growth.

Saturating growth to a stable maximum occurs if the covert exponential growth is reciprocally inhibited by a linear function of that covert exponential growth itself, because then we obtain a symmetric logistic function for  $V_t$  as volume of the growing system at time  $t$  by

$$V_t = M_t / [x + y \cdot M_t] = M_t / \{x \cdot [1 + z \cdot M_t]\} = z \cdot M_t / \{y \cdot [1 + z \cdot M_t]\}.$$

Since function  $M_t = \exp(a \cdot t + b)$  contains an undefined constant  $b$ , we redefine  $b$  by adding  $\ln(z)$  and define  $1/y = Y_{\max}$ , whereby we obtain the usual symmetric logistic function by substitution of  $M_t$  as

$$V_t = e^{a \cdot t + b} \cdot Y_{\max} / [1 + e^{a \cdot t + b}] = Y_{\max} [1 + e^{-(a \cdot t + b)}]^{-1} \quad a > 0, b < 0.$$

The differential of this function as function derivative divided by the function itself is written as

$$Q_t = a \cdot [1 + e^{-(a \cdot t + b)}]^{-1} = a \cdot [1 + M_t^{-1}]^{-1} = a \cdot D_t$$

where  $Q_t$  defines the resulting growth force and  $D_t = [1 + M_t^{-1}]^{-1}$  the growth resistance force that inhibits the underlying Malthusian growth force  $a$  in the same way as the resistance force of a medium inhibits the constant acceleration of a falling object in a vacuum. It allows the symmetric logistic function to be written as

$$V_t = M_t \cdot Y_{\max} \cdot D_t = M_t \cdot U_t$$

where  $U_t = Y_{\max} \cdot D_t$  is the intrinsic inhibition function of the underlying exponential growth and where for  $t$  approaching infinity  $V_{t \rightarrow \infty} = Y_{\max}$  and  $Q_{t \rightarrow \infty} = 0$ .

Symmetric logistic growth may apply if a stabilising system growth is determined by only one type of subsystems with one growth resistance force for its subsystems. However, there generally are many different, interacting micro-subsystems in an evolutionary self-organising system, where growth of each type of micro-subsystems can have a different growth resistance force. Since the product of  $n$  randomly different forces can be written by  $n$  times the average force, we obtain the differential of the growth function for  $c = 1/n$  and  $D_t$  as growth resistance force of the average subsystem of many randomly different subsystems as

$$Q_{tc} = a \cdot [n \cdot D_t] = a \cdot D_{tc} = (a/c) \cdot [1 + M_t]^{-1} = (a/c) \cdot [1 + e^{a \cdot t + b}]^{-1}$$

where the growth resistance force of the total system is defined by

$$D_{tc} = n \cdot D_t = (1/c) \cdot [1 + e^{a \cdot t + b}]^{-1}$$

We defined the resulting growth force as the derivative of the growth function divided by itself, whereby it follows that the stabilising growth function itself must be

$$V_{t|c} = V_{\max} \cdot [1 + e^{-(a \cdot t + b)}]^{-1/c}, \quad |a < 0, b > 0, c = | \ln < 1$$

This is the asymmetric logistic growth function with its inflexion point below 50% of the maximum level if  $0 < c < 1$ . For very many different micro-subsystems  $c \dots 110$  approaches its zero limit, whereby the stabilising growth expression simplifies to the Gompertz function

$$V_{t|0} = Y_{\max} \cdot e^{-e^{-(a \cdot t + b)}}$$

with the function differential as resulting growth force

$$Q_{t|0} = a \cdot e^{-e^{-(a \cdot t + b)}} = a/M_t$$

and where thus the growth resistance force becomes  $D_{t|0} = M_t^{-1}$  for limit  $c = | \ln - 0$ .

Since evolutionary self-organising growth is characterised by the multiple replacements of many kinds of hyper-cyclically interacting micro-subsystems we define:

Postulate 2 of adaptive evolution

*In absence v/temporarily and/or randomly growth-accelerating or growth-detering factors, the volume growth  $V_t$  (or growth of total system throughput or output) of an evolutionary system with stabilising growth - caused by self-organised, multiple replacements of very many different micro-subsystems - is defined at time  $t$  by*

$$V_t = V_{\max} \cdot e^{-e^{-(a \cdot t + b)}} \quad | \quad a > 0; b < 0.$$

We equivalently formulate by the definition of growth force as differential of the growth function (derivative divided by growth level):

Principle 2 of adaptive evolution

*In absence of temporarily and/or randomly growth-accelerating or growth-detering factors, the constant growth force  $a$  of underlying Malthusian growth of any evolutionary self-organising system with stabilising growth is reciprocally inhibited by the underlying Malthusian growth itself, whereby the resulting evolutionary growth force becomes  $a/M_t$ .*

We could generalise the growth resistance force to a more flexible function of  $M_t$  by

$$D_{t\phi}, d = (1/c) \cdot [1 + M_t^d]^{-1}$$

whereby the inhibition function of the underlying exponential growth would become

$$U_{t|c,d} = V_{\max} [1 + e^{d \cdot (a \cdot t + b)}]^{-1/c}$$

By

$$V_{t|c,d} = M_t \cdot U_{t|c,d} = e^{(a \cdot t + b) \cdot d} \cdot V_{\max} [1 + e^{d \cdot (a \cdot t + b)}]^{-1/c},$$

and defining  $x = (1-d) \cdot a \cdot c$ ,  $Y = (1-d) \cdot b/c$  and  $z = d \cdot a$  as well as  $s = d \cdot b$  we obtain

$$Y_{t|c,d} = e^{x \cdot t + y} \cdot V_{\max} [1 + e^{-(z \cdot t + s) \cdot d}]^{-1/c}$$

For  $d > 1$  we have  $x < 0$ , whereby an initially growing system diminishes in the end to a zero volume. For a non-declining system growth we must define  $d = 1$  or  $d < 1$ . But for  $d < 1$  we have  $x > 0$ , which means an ever increasing growth. Since this would violate the law of energy conservation, due to the needed, infinite energy supply for the ever increasing production of multiples of identical or adaptively modified subsystems that replace the existing subsystems (Jantsch, 1980b), we see that  $d < 1$  cannot hold. For  $d = 1$  we have  $x = 0$  and, thus, a stabilising system growth, while for systems with a very large number of different micro-subsystems  $c$  approaches zero. Thus,  $d < 1$  is impossible and  $d > 1$  defines a declining system, whereby  $d = 1$  and  $c$  approaching to zero uniquely leads to our postulate 2 and principle 2 of adaptive evolution.

There may exist temporary growth-accelerating or growth-detering factors for socio-economic, technological systems, such as economic upsurges or depressions. If these accelerating and deterring factors are cyclically operating then we may write the cyclic growth deviations, similar to cyclic processes in time series analyses (Anderson, 1971), by

$$E_t = \exp\left\{\sum_{i=1}^n [h_i \cdot \cos\{g_i(t - \tau_i)\}]\right\}.$$

For cyclic or other time-dependent disturbance functions  $E_t = \exp[f(t)]$  that are multiplicative with respect to the logarithm of Gompertz growth, we formulate

Corollary A of adaptive evolution

*In absence of randomly growth-disturbing factors, the volume growth (or growth of total throughput or output) of an evolutionary system with stabilising growth - caused by self-organised, multiple replacements of very many micro-subsystems - is defined at time  $t$  by*

$$V_{tle} = V_{\max} \cdot e^{(a \cdot t + b) + f(t)} \quad | a > 0; b < 0; \text{cov}\{\ln(V_t), e^{f(t)}\} = 0,$$

where  $f(t)$  represents independently operating, temporary growth-accelerating and growth-detering factors.

The analysis of growth data asks great care in the simultaneous estimation of parameters  $V_{\max}$ ,  $a$  and  $b$  on the one hand and the function  $f(t)$  on the other hand in order to entangle the influence of other independently operating factors that can temporarily deter and accelerate the Gompertz growth of the system. As shown by the fit of Gompertz growth with time-dependent deviations in the analyses of the developments of national traffic volumes (Koomstra, 1993, 1995, 1997a), this can be difficult for time series of growth data that have not passed a visible inflexion point or are not much longer than the longest deviation period around the Gompertz growth.

The evidence on fatality rates and polluting emissions rates of transport systems, shows that the rate of self-destructive outcomes is proportional to a power function of the delayed growth force (the derivative of the delayed growth function divided by its delayed growth level), where the power exponent is larger than unity. Based on this evidence and the plausible conjecture that this holds for self-destructive outcomes in any self-organising evolution system, we formulate:

Postulate 3 of adaptive evolution

In absence of randomly operating factors the development of self-destructive subsystem outcome rates within any evolutionary self-organising system is proportional to an increasing powerfunction of its delayed, resulting growth force

$$RI = w \cdot \left[ \frac{\delta V_{t-T_e}}{\delta t} / V_{t-T_e} \right] I_q,$$

which in absence of temporary and randomly disturbing factors reduces to

$$R_t = w \cdot [a/M_{toT}]^q = e^{\alpha \cdot t + \beta} \quad | q > 1; \alpha = -q \cdot a < 0; \beta > 0.$$

We equivalently formulate by the definition of forces as ratio of derivative and level:

Principle 3 of adaptive evolution

For any evolutionary self-organising system, in absence of temporary and/or randomly disturbing forces, the adaptation force for the decay rate of self-destructive subsystem outcomes is constant and proportionally larger than the constant growth force for the underlying Malthusian growth of the evolutionary system.

Postulate 3 is explicitly formulated for the first time by Teilhard de Chardin (1955, p. 342-343, religious philosopher, palaeontologist, and discoverer of Homo Pekinensis) in 1948, as cited on the front page of this chapter. The citation says in our translation:

*“However, we remark that in case of very large aggregations (such as formed by the mass of men) the process tends towards “infallibility”, where on the one hand the random chances of success increase and on the other hand the chances of refusal or failure at liberty diminish with the increase of the elements involved”*

Notice that Teilhard de Chardin not only refers to biological evolution, since the wording ‘the chances of refusal or failure at liberty’ also refers to man-made evolution processes, such as socio-economic or social and cultural evolutions.

For not self-destructive, adverse outcomes, the power exponent of the growth differential that determines the slope of the decay for these adverse outcome rates will be lower than for the rate of self-destructive outcomes, but still larger than unity. The rate of these adverse outcomes may also not reduce towards zero in the infinity of time. This has been shown to be the case for the analysis of the risk developments of serious and slight road injuries (Koomstra, 1988; Commandeur and Koomstra, 2001) and possibly for the rate of several polluting traffic emissions (for example for NO<sub>x</sub>, but not for carbon dioxide CO<sub>2</sub> and hydrocarbons C<sub>x</sub>H<sub>y</sub> from road traffic, see: Koomstra 1997a,b). Therefore, we formulate:

Corollary B of adaptive evolution

The development of the rate of adverse, but not self-destructive subsystem outcomes within any evolutionary self-organising system, in absence of temporary and/or randomly operating factors, is a linear transformed, powerfunction of its exponential decayfunction for the rate of their self-destructive subsystem outcomes, described by

$$G_t = z \cdot [(1-p) \cdot R_t^S + p] = z \cdot [(1-p) \cdot e^{s \cdot (a \cdot t + \beta)} + p] \quad | a < 0; 1/q \leq s < 1; 1 \geq p \geq 0,$$

where  $z > 1$  defines a higher rate  $G_t$  of not self-destructive outcomes than rate  $R_t^S$  of self-destructive outcomes, while rate  $G_t$  for  $t$  approaching infinity reduce to  $z \cdot p > 0$ .

Denoting the number of not self-destructing, adverse outcomes, such as road injuries or polluting emissions, by  $I$  and self-destructive outcomes, such as road fatalities, by  $F_t$  we have defined

$$R_t = F_t N_t \text{ and } G_t = I_t N_t,$$

whereby

$$I_t = y \cdot F_t^s \cdot V_t^{(1-s)} + x \cdot y_t$$

where  $y = z \cdot (1-p) > 0$ ,  $x = z \cdot p > 0$ , and  $0 < q \leq s < 1$ , which for  $t$  approaching infinity means that  $F_t \rightarrow 0$ , but for  $x > 0$  and  $t$  approaching infinity we see that  $I_t \rightarrow x \cdot y > 0$ . Thereby, we also have defined in absence of any disturbing factors the macroscopic development of

$$F_t = R_t \cdot V_t = e^{\alpha \cdot t + \beta} \cdot V_{\max}^{-e^{-e^{-(a \cdot t + b)}}}$$

$$I_t = G_t \cdot y_t = z \cdot [(1-p)e^{s(\alpha \cdot t + \beta)} + p] \cdot V_{\max}^{-e^{-e^{-(a \cdot t + b)}}}$$

where both are single-peaked functions, because  $\alpha > -q \cdot a > s \cdot \alpha = -s \cdot q \cdot a$  for  $a > 0$ ,  $q > 1$  and  $0 < q \leq s < 1$ . Therefore, we formulate as last corollary:

#### Corollary C of adaptive evolution

*In absence of temporary and/or randomly growth-accelerating or growth-detering factors the development of self-destructive and of not self-destructive, adverse outcomes of subsystems within any evolutionary self-organising system is single-peaked, where in the very long run the number of self-destructive subsystem outcomes approaches the zero level and the number of not self-destructive, adverse subsystem outcomes to a constant level that is the lower the more damaging the adverse subsystem outcomes are for the interactive functioning of the subsystem.*

#### 8.3.1. Scenario predictions a/world developments

Our mathematical theory of technological system evolution and adaptation predicts world developments that differ from the mathematical world models that are used in the politically influential publication of the so-called Club of Rome: "The Limits to Growth" (Meadows, 1972), based on the model specifications in "The dynamics of growth in a finite world" (Meadows, 1974), and more recently still reaffirmed in: "Beyond the limits. Confronting Global Collapse, Envisioning a Sustainable Future" (Meadows et al., 1991). In these and related, politically influential publications, such as the Brundtland report: "Our Common Future" (WCED, 1987), polluting emissions of industrial production are modelled as a lagged proportional function of exponential production growth without adaptation effects. The exponential growth of industrial production and polluting emissions in these models of world developments assumes no growth saturation, while also no decay of polluting emission rates is present in these models. This not only contradicts the inevitably increasing scarcity and price of fossil energy, but also the increasing efficiency of energy use and the emerging replacements of fossil energy sources by other kinds of energy with less or no polluting emissions or by bio-energies that absorb such emissions. As shown in figure 48 below for one



typical scenario of these world developments, such world developments have to collapse by the self-destructive disasters from pollution levels that exceed the carrying capacity of the environment.

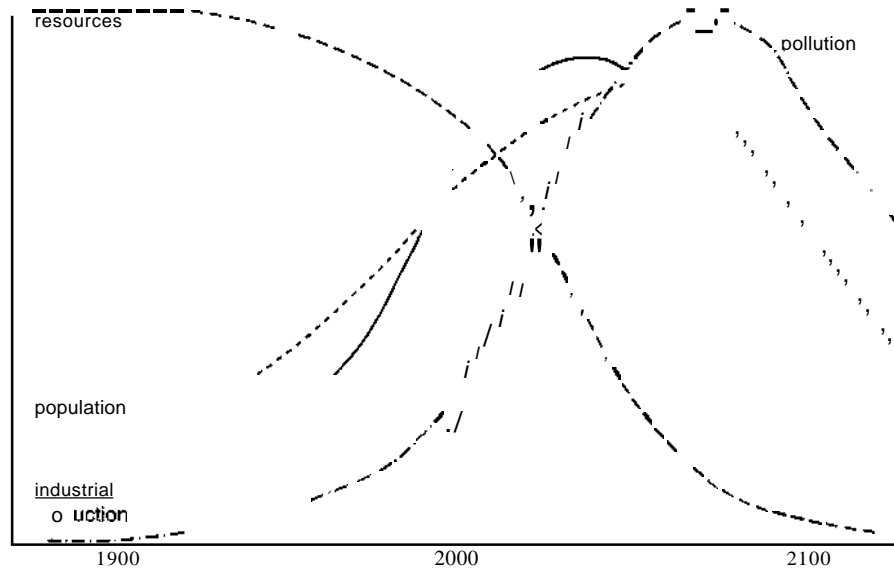

Figure 48. Pessimistic scenario for world developments (adapted Meadows et al., 1991).

Nonetheless, according to our theory of adaptive evolutions of socio-economic, technological systems such doom scenarios will never take place. As the analyses of traffic data show these models for world developments, actually called '*Models of Doom*' by Cole (1973), likely are incorrect, because these models don't take into account the effects of saturating growth and the adaptive decay of self-destructive and adverse outcome rates, which are both inherent to the growth of all self-organising systems. Firstly, long before the system can collapse, the emerging scarcity of energy resources increases the energy prices, which economically reduce the utility of further system growth that dissipates these resources. Secondly, technological innovations for more efficient production of alternative energies already are, and will further be, applied (WBCSD, 2004). These alternative energies must and will replace the use of the increasingly expensive fossil energy by the use of new cleaner and, after some point in time, relatively cheaper, other energy resources, due to the increasing scarcity of the exhausting, fossil energy. Thirdly, already from the time of the early system development onward, thus very long before the time that the system could collapse by environmental disasters, ongoing inventive subsystem adaptations have and also will further improve the operations in the growing system by multiple substitutions of safer, more effective, and less polluting subsystem elements. Such adaptations are generated by their socio-economic utility and are also triggered by societal and normative rules that become enforced by economic penalties, if violated, or rewarded by larger market shares and profits, if applied. It prevents a self-destructive development of self-organising, industrial and technological systems in democratic societies.

In our partially validated theory of adaptive evolution the first evolution phase is characterised by annual growth percentages that are larger than the annual reduction percentages of self-destructive outcome rates per amount of production. This first evolution phase shows an almost exponential growth (comparable to relatively low, but fast-increasing level of motor vehicle kilometres in the early motorisation phase of motorising countries) and, due to the almost absent and lagged adaptation effects for a reduction of self-destructive and adverse outcomes that emerge from side effects of system growth, also a nearly exponential increase of adverse outcomes is observed (comparable to initially low, but increasing levels of road fatalities and polluting emissions of motorised transport). These seemingly exponential developments of growth and self-destructive or adverse outcomes of the first growth phase (comparable to traffic growth and fatality or injury developments in developed countries before the seventies of the 20<sup>th</sup> century) are extrapolated in the environmental doom models. But the assumption of exponential growth without adaptation is not empirically, nor theoretically justified. Our analyses show that the seemingly exponential growth becomes reduced in the mid growth phase to an almost linear growth (comparable to the nearly linear increase of annual motor vehicle kilometres in motorised countries during the last quarter of the 20<sup>th</sup> century). The annual growth percentages initially exceed the annual reduction percentages of the self-destructive or adverse outcomes, but will decrease to a level that first approaches, then matches, and later underscores the annual reduction percentages of the self-destructive or adverse outcomes (as empirically demonstrated for fatality, injury, and emission rates of road traffic). The latter phenomena express the observable adaptation effects during the mid-period of the system evolution with a nearly linear growth. In the first half of the mid-period diminishing increases of self-destructive and of adverse outcomes are observed, while in the second half of the mid-period decreases of the self-destructive outcomes and somewhat later also of adverse outcomes will take place (as demonstrated for road fatalities and injuries and for road transport emissions). After the mid-period of the system evolution our theory predicts that growth will level off further and in the end towards an almost zero annual growth of the stabilising (or oscillating) system volume. Non-exponential, saturating growth is recently confirmed also for the world population and applied for population prognoses by the United Nations (UN, 2003) and the World Bank (WB, 2003). Our theory also predicts that self-destructive outcomes per system volume decrease in an exponential way to an almost zero level, while the not self-destructive outcomes will reduce to an almost stabilised, low level during the last phase of diminishing system growth towards its almost stable maximum level.

Sustained by the validated modelling of motorised transport growth and the adaptation by fatality and injury risk decay and decay of polluting emission rates in road transport, the theory of adaptive evolution for socio-economic, technological, self-organising systems conjectures that the speed of subsystem replacements by multiple and better adapted subsystems not only determines the system growth, but also the speed of the adaptive risk decay of self-destructive and adverse subsystem outcomes. Without growth there is no further adaptation and without adaptation no further growth, because without subsystem substitutions by more and better adapted subsystems further growth can't exist, nor further adaptation. It also follows from our theory that at some

point in time the smoothed, annual percentages of volume growth will become lower than the smoothed, constant reduction percentages of the annual self-destructive or adverse outcomes, whereby a sustainable system growth will be achieved. Just before and after the mid seventies of the 20<sup>th</sup> century traffic growth percentages in all highly motorised countries have declined to a level below the reduction percentages of their fatality rates, while since the mid eighties of the 20<sup>th</sup> century the already existing, almost constant reduction percentages of several polluting emission rates also have become higher than the diminishing traffic growth percentages in highly motorised countries. It demonstrates that a sustainable growth of road traffic can be achieved and, besides emission of carbon dioxide, seems already established in highly motorised countries. Although worldwide this is not the case, due to the recent motorisation in developing countries, it is expected that the same road transport development as in developed countries will evolve delayed in developing countries (WBCSD, 2004).

Similar developments and identical adaptive evolution principles apply to industrial production systems, because the energy efficiency in industry has increased and both the industrial fatality rates and the industrial emission rates are reducing in developed countries, where also the polluting emissions markedly decreased over the last decades, except again for carbon dioxide. However, it must be realised that the carbon dioxide level in the lower atmosphere slowly increased and also periodically decreased and increased in a delayed way with the temperature changes between the nine ice-time periods every 80 to 100 thousand years during the past 950 thousand years. The recent global warming is mainly measured on the earth surface of the northern hemisphere, while only a minor atmosphere warming is observable by satellite measurements. The recent global warming seems to be caused by joint effects of 1) an unusually long period of strongly intensified sun outbursts since 1940 (see: relevant papers in *Physical Review Letters*, 2003 November and *Journal of Geophysical Research*, 2003 May) and 2) a sharply increasing level of carbon dioxide from the additional emissions of the growing use of fossil energy by industry, motorised transport, and households in the course of the last two centuries, but both phenomena likely will not last. Intensification of sun outbursts has always been a temporary phenomenon and most likely will also this time ends before the mid 21<sup>st</sup> century (see: *Nature*, 2004 end October), while all prognoses predict that exploitable fossil energy resources will become almost exhausted before or shortly after the mid of the 21<sup>st</sup> century. Therefore, global warming likely will be a temporary phenomenon. Moreover, the cyclic ice-time periods, caused by cyclic deviations of the earth rotation distance to the sun, and the very slow, but in the long run inevitable overall cooling of the earth, caused by the slow burnout of the inner earth (and in the end also of the sun), predict that a periodic and an overall cooling of the earth climate will occur in the far future. A global cooling will take place at the beginning of the next ice-time period, while human actions can likely never generate the energy and/or greenhouse circumstances that are needed for a lasting compensatory warming of the cooling earth climate.

The adaptive evolution principles mean that growth of technological systems becomes sustainable after the growth increase has become proportionally smaller than the proportionally constant decrease of self-destructive subsystem outcomes that accompanies any growth. One has to be aware that any system growth will always be

a proportionally diminishing growth, due to the inherently diminishing growth rate of any growing system. This even holds for just less than exponential growth to linear growth, because also characterised by reducing growth percentages. However, such non-saturating system growth can't exist forever, due to the energy that needs to be dissipated by the growth of any system (Jantsch, 1980b) and the limit of available energy. Our third principle of adaptive evolution implies a proportionally constant reduction of the rate of self-destructive outcomes, whereby a sustainable growth will be established after some point in time, because the annual products of its constantly **reducing** rates and diminishingly growing system volumes describe a single-peaked development of self-destructive and adverse outcomes, as earlier illustrated for road fatalities. If the environmental doom models (Meadows, 1974; Meadows et al., 1991) are modified by functions of our adaptive system evolution then

- exponential growth of industrial production is replaced by Gompertz growth,
- delayed, exponentially increasing pollution is replaced by an exponential decay rate of polluting emissions per amount of industrial production,
- the function of fossil energy use becomes modified by a logistic function for an increased efficiency of fossil energy use,
- a Gompertz growth of clean alternative energies that gradually replace the exhausting fossil energy is added.

Such a modified world model predicts no collapse of the living world for the present and coming centuries. Figure 49 below shows a typical scenario that is predicted by such a modified modelling that is based on the described, adaptive evolution principles.

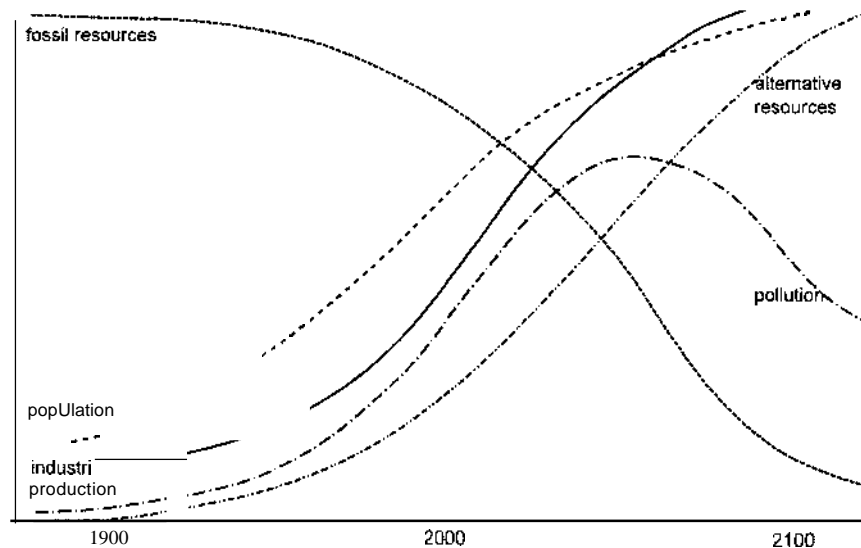

Figure 49. A world development scenario based on evolutionary growth and adaptation.

The predicted development of environmental pollution becomes single-peaked, due to the exponential decay of its rate per unit of production-system growth. In view of the recent evidence for saturating growth of the world population, the absence of convincing evidence from analyses of sufficiently long other time-series of observed

world data for a collapsing world development (apart from local disasters), and the partial evidence from rather long term transport developments (up to 80 years) for our adaptive evolution model, it must be conjectured that real world developments will be more similar to the scenario of figure 49 than to the doom scenario of figure 48. A sustainable growth is yet not observed in developing countries, where safe production and transport infrastructures and enforced environment and safety policies still have to emerge, despite the emerging globalisation of telecommunication, technology, industrial production, and economic policies. The predicted world developments displayed in figure 49, therefore, may need some caution. However, evolutions of self-organising systems, such as the socio-economically driven growth of technological systems, are inherently characterised by adaptively sustainable developments. The call for the implementation of structural changes in the economically driven growth of industrial and technological production systems (Meadows et al., 1991, ch. 7) by adaptive feedback loops overlooks that every self-organising system growth inherently contains already such adaptive feedback loops from the start of its evolution onwards. Adaptive evolution not only holds for biological system growth, but also for industrial and technological production systems in democratic societies. The environmental doom scenarios, based on exponential growth of world population and industrial production with delayed-exponential developments of life-endangering outcomes, don't recognise the evolutionary principles of saturating growth and adaptation. These principles at least apply to developments of the world population and transport systems, since validated by long term time series, and likely also hold for the adaptive growth of industrial and technological systems in developed countries. Therefore, we conclude that one ought to have serious doubts on the validity of the environmental doom models for world developments.

## RETROSPECTIVE SUMMARY

*"I shall consider human actions and appetites just as if it were a question of lines, planes, and bodies."*

Spinoza. *Short Treatise*. This essay is written between 1670-72, but for the first time published in 1855. The citation is taken from the translation in: E. Curley, (Ed.), (1985), *The Collected Works of Spinoza*. Princeton Univ. Press, Princeton, NJ.

*"What is sometimes required is not more data or more refined data, but a different conception of the problem."*

Shepard, R.N. (1987). Toward a universal law of generalization for psychological science. *Science*, 23: p. 1318.

A multidimensional analysis of psychological data requires that the geometry of the relevant psychological space is known. Multidimensional analyses of psychological data generally use Minkowskian or Euclidean geometry, but nothing guarantees that psychological spaces are flat and infinite. Mathematical behaviour theory and experimental psychology tried to specify and verify the distance metric of psychological spaces, but their geometrical nature remained unresolved, while also measurement theory has not solved the geometry problem in psychology. In order to tackle the problem of the geometrical nature of psychological spaces, we have taken a route different from hoping that the problem would be solved by doing more experiments, gathering more crucial psychological data, refining analysis models, and representing analysis results in some, not necessarily flat and infinite, geometry that yields the lowest dimensionality or the most parsimonious data representation.

Firstly, we examined the existing theoretical notions and mathematical models from a century of the choice-relevant, experimental and theoretical research in psychology in order to derive basic properties of metric functions that transform stimulus to sensation spaces and sensation spaces to judgmental or preferential response spaces. Secondly, on the basis of such properties, we uniquely specified the permissible function alternatives for metric space transformations that satisfy transitivity of (conditional) distance rank orders. Thirdly, assuming either Euclidean or non-Euclidean stimulus geometry, the respectively specified functions for the metric stimulus space transformations determine the corresponding alternative geometries of sensation, response and valence spaces.

The universal properties of psychological scales are a zero reference point and bipolarity. The zero reference points are the individual adaptation points that define the individual origins of psychological spaces and the basic transformation function of stimulus to sensation dimensions is Fechner's logarithmic function. Weighted sensation differences from adaptation level define intensity-comparable sensation spaces of perceptual sensations that are matched with cognitive magnitude sensations (chapters

1 to 3) and correspond to subjective stimulus magnitude spaces with power-raised dimensions as defined by Stevens' alternative power function. Given that the geometry of the stimulus space is Euclidean or non-Euclidean, the logarithmic stimulus space transformation defines the geometry of the sensation space to be either hyperbolic and infinite (for Euclidean stimulus spaces) or flat and infinite (for non-Euclidean stimulus spaces), where the curvature of a non-Euclidean stimulus space determines the Minkowski  $r$ -metric of the corresponding flat sensation geometry. Thereby, it also follows that intensity-comparable sensation spaces of Fechner-Helson psychophysics and dimensionally power-raised stimulus spaces of Stevens' psychophysics are different geometric representations of the same (section 3.3). On the basis of the basic properties for judgmental responses or monotone preferences (magnitude and similarity responses or utility and other monotone valences), derived from the existing psychological and econometric research, it is concluded that the transformation function of sensation dimensions to response or monotone valence dimensions must be some symmetric, bipolar, ogival function with the adaptation point as function midpoint and origin (chapter I and sections 2.1 and 2.2). From the basic properties for single-peaked preferences, derived from the existing learning and preferential choice research, it is also concluded that the transformation of sensation dimensions to single-peaked valence dimensions must be based on the intra-dimensional multiplicativity of two oppositely oriented, monotone valence functions with a distance between their respective function origins that are the preferentially neutral adaptation and saturation or deprivation levels of the sensation dimensions (chapter I and section 2.3).

From the further requirement that the response space must be rotation-invariant it followed that the response function has to transform flat or hyperbolic and infinite sensation spaces to open (finite) response spaces with the same distance metric as the stimulus space (how otherwise could humans cope with reality). Thereby, the alternatives for the metric specification for the required symmetric, bipolar, ogival transformation functions of sensations to judgmental or preferential responses are uniquely determined to be either the hyperbolic tangent or the arctangent function (chapter 2 and section 4.2). The alternatives for the metric specification of the transformation function of sensations to single-peaked valences are also determined by the intra-dimensional product of either two hyperbolic tangent or two arctangent functions of sensation dimensions with a distance between their respective function origins (sections 2.3, 2.4, and 5.3). Given the infinite flat or hyperbolic geometry of the sensation space these metric transformation functions define different open projective geometries for judgmental response, monotone valence, and single-peaked valence spaces. It determines the open response and monotone valence spaces as stimulus space involutions that have either a zero or a constant (negative or positive) curvature, while single-peaked valence spaces have either an open-hyperbolic geometry with curvature  $-\frac{1}{2}$  or an open Finsler geometry with varying, negative or positive curvatures that depend on the sensation or valence distance to the ideal sensation or maximum valence space point. These specific open Finsler geometries turned out to be conditionally rotation-invariant with respect to the ideal point as rotation centre. The next overview summarises the theoretically permissible transformations to geometries of psychological spaces for given alternative geometries of the stimulus space.

stimulus geometry	transformation to comparable sensation space	sensation geometry	transformation to response and monotone or single-peaked valence spaces	response space and monotone valence geometry	single-peaked valence geometry
Euclidean	logarithmic (with space translation and weighing of dimensions)	hyperbolic and infinite	hyperbolic tangent	open-Euclidean	open-hyperbolic
hyperbolic		flat and infinite (Euclidean or Minkowskian)	or product of hyperbolic tangent functions	open-hyperbolic	open-Finsler, negative curvatures
double-elliptic			arctangent or product of arctangent functions	single-elliptic	open-Finsler, positive curvatures

*Theoretically permissible transformations to geometries of psychological spaces*

For each of the theoretically permissible alternatives of response and valence space geometries we developed semi-metric methods for the multidimensional analyses of respectively dissimilarity and preference rank order data (chapters 4 and 5). Existing MDS-analyses are partially or fully inappropriate, because the projective response or valence transformations of individually translated and weighted sensation spaces yield individually different object configurations in open response or valence spaces. Appropriate analyses of rank order data with some error might never reveal what the correct geometries of the relevant psychological spaces are, but the permissible response and valence space geometries define also different MDS-based choice models with bias for confusion or categorisation probabilities (section 7.2) and preference probabilities (section 7.4), where in contrast to rank order data the analyses of probability data may more likely determine the correct geometry of the response or valence space. We did not conclude which of the permissible geometries is the valid response or valence geometry. However, one plausible argument -*not relativistic, but Newtonian physics applies to the stimuli of human perception*- some theoretical results -1) ideal axes only diverge in hyperbolic sensation spaces, 2) only single-peaked valences of hyperbolic sensations inherently define comparable sensation distances that have a conformal distance metric in their open-hyperbolic spaces of single-peaked valences - and some empirical evidence -our analysis of intransitive preference probabilities in Tversky's (1969) study- indicate that the stimulus space is Euclidean and the sensation space hyperbolic, whereby we might assume the response space likely is open-Euclidean and the single-peaked valence space open-hyperbolic.

Sensation spaces with dimensions that are individually translated to their adaptation points and weighted by twice the inverse of their dimensional adaptation levels enables an intensity comparison of multidimensional sensations (chapter 3). It is called the intensity-comparable Bower sensation space, because it was Gordon Bower (1971) who for the first time conjectured that sensation comparisons require a weighing of sensation differences from the adaptation point. The intensity-comparable sensation dimensions in Bower spaces become defined by the ratios of dimensional



sensation differences to its adaptation point and half the dimensional distance between its adaptation and just noticeable points and valence-comparable sensation dimensions by the ratios of dimensional sensation distances to the ideal point and their dimensional distance between the dimensional ideal and adaptation points. These ratios are invariant under linear transformations of their underlying Fechnerian sensation scales and, thereby, define dimensional-invariant measurements of individual sensations. Consequently, its isomorphic space transformations to judgmental or preferential response or single-peaked valence spaces define dimensional-invariant measurements of individual responses or valences (chapter 6). Thus, as by-product of the psychophysical response and valence theory, we solved the measurement problem in the psychology of judgment and preference, whereby quantitative judgment and preference theory can be meaningful.

As a result of the psychophysical response theory we further showed that the relativity dynamics from adaptation to presented or memorised target stimuli or to presented pairs or subsets of stimuli (section 7.1.) can lead to asymmetric and/or intransitive similarities and to biased choice models with a power-raised or multiplicative, stimulus-dependent bias, instead of the usually multiplicative, response-dependent bias. We derived new alternative MDS-based choice models with bias for the analysis of confusion or categorisation probabilities in perception and cognition research (section 7.2). We also showed that the relativity dynamics from adaptation to presented stimuli in the psychophysical response theory predicts distance- and context-dependence, asymmetry, and/or intransitivity of similarities, which phenomena have been explained by different models, such as the distance- and density-dependent MDS-model, the feature-contrast model, the general context model, and the hybrid MDS-model, as well as the general recognition theory wherein object distribution overlap defines the similarity measure for a stochastic MDS-analysis model. Moreover, also intransitivity of preference rank orders is predicted by the relativity dynamics in our psychophysical valence theory (section 7.4), while new biased preference probability models are derived for single-peaked valences (subsection 7.4.3.). Observed intransitivity of gamble preference probabilities is well predicted by a metric re-analysis that is based on our three-component portfolio theory for gamble preferences with relativity dynamics of adaptation-level shifts to midpoint sensations of gamble pairs, where our model is shown to fit better than any existing model (subsection 7.4.2).

Lastly, we discussed the personally conflicting nature of preferential choices in reality and their individual and collective choice dynamics (chapter 8). We argued that behavioural preferences are based on conflicting valences that are cognitively determined by single-peaked valences of choice objects and behaviourally by monotone valences for choice realisation difficulties. Thereby, behavioural choices not only depend on the sensation distance between object and ideal points - representing by its smallest distance which object is cognitively most preferred -, but also on the sensation difference between the object and adaptation point - representing by the smallest positive difference which preferred object is behaviourally most easily obtained. Preferential choices in reality then become preferences for objects located between the ideal and adaptation points (subsection 8.1.2.). Behavioural preferences in reality may differ from cognitively assessed preferences in experimental studies. In the mixed

valence spaces of behavioural choice objects the dimensional manifest valence functions become asymmetric, while conflicting valences will lead to a partial preference indifference for choice objects below (or above) a certain dynamic sensation level and to increasingly negative object valences above (or respectively below) that level. We also demonstrated that a similar, dynamically shifting preference indifference range may exist for a dimension in a sensation subspace that is characterised by highly correlated dimensions with oppositely oriented, single-peaked valence functions, where then the dimensional valences outside the indifference range are increasingly negative on both sides of that indifference range (subsection 8.1.3.). We argued that this holds for dynamically changing, individual risk behaviour in road traffic, which is formulated by our risk-adaptation theory (subsection 8.1.3.) that contains three major theories of traffic risk as special cases. Moreover, it is predicted by the risk-adaptation theory that collective road risks will exponentially decay over time with a  $1\frac{1}{2}$  times larger slope parameter than for the traffic growth function. This is empirically shown to hold by the fit of corresponding models for Gompertz traffic growth and exponential risk decay (section 8.2). The inherently related models of traffic growth and risk decay are generalised to a mathematical theory of adaptive evolution for socio-economic, technological systems, because similar matters generally hold for growth of socio-economically driven, technological systems with other kinds of life-endangering side effects that cause similarly conflicting, single-peaked valences for their system risks. This general theory of adaptive system evolution (section 8.3) predicts world developments that markedly differ from the nowadays popular and politically influential 'doom models' of global industrial growth and environmental world developments. In these doom models the growth of technological production systems and the developments of their life-threatening side effects are both mainly modelled by exponentially increasing functions, as if no growth saturation and no adaptive risk reduction are present. Given the partial evidence from long term traffic developments for our theory and the questionable evidence from data analyses of not-long-enough time series for the doom models, we conjecture that the politically influential predictions of disastrous world developments from these doom models are unjustified. We concluded that foremost these doom models must be modified, instead of the criticised technological system growth.

In retrospect overlooking the results of our psychological relativity theory, we could conclude that we might have:

- integrated Stevens' and Fechnerian psychophysics (different geometric presentations of the same) and Helson's adaptation-level theory by our multidimensional theory of psychophysics;
- integrated Luce's response and choice theories, Kapteyn's econometric preference formation theory, subjective expected utility models - including Luce's rank- and sign-dependent utility theory and the prospect theory of Kahneman and Tversky-, Tversky's elimination-by-aspect or additive difference model, and Tucker's vector model for preference analysis by our psychophysical response theory;
- integrated the Lewin/Festinger theory of aspiration level, Berlyne's reward and aversion systems theory, Gray's two-process learning theory, Coombs' unfolding analysis by our multidimensional, psychophysical valence theory;

- integrated or replaced by the psychophysical response theory, Krumhansl's density- and distance-dependent similarity model, Nosofsky's general context model, Tversky's feature-contrast theory of similarity, and several partial theories on the visual space perception, while our psychological valence theory of objects with single-peaked valences metricises and modifies Coombs' unfolding analysis;
- determined the permissible geometries of psychological spaces for sensations, judgmental or preferential responses, and preferences with single-peaked valences as well as developed semi-metric, multidimensional methods for dissimilarity and preference data analyses in each of the permissible geometries;
- bridged several gaps between psychophysics, mathematical behaviour theory, and cognitive psychology;
  - solved, as by-product of substantive theory, the measurement problem in the psychology of judgment and preference, whereby meaningfulness of quantitative theory in the psychology of judgment and preference becomes possible;
  - developed, as an outcome of the relativity dynamics in our psychophysical response theory, several new MDS-based choice models with bias for geometrically appropriate multidimensional analyses of similarity probabilities in perception and cognition as well as derived from our psychophysical valence theory new biased models for preference probabilities of objects with single-peaked valences;
- developed, as an application of dynamics in our psychophysical valence theory of choice conflicts, the risk-adaptation theory for individual traffic risk behaviour;
- generalised a verified model for inherently related, long term developments of road transport growth and collective traffic risk decay to a general theory of adaptive evolution for the growth and risk decay of socio-economic, technological systems.

The partial evidence, discussed in chapters 7 and 8, and the integrative consistency with existing partial theories, summarised above, may contribute to the validity of the psychophysical response and valence theory. Nonetheless, its mathematical formulation and the analysis methods of dissimilarity or preference rank order data and choice probability data:

- a) might be improved, where possible flaws hopefully are of minor importance,
- b) contain still aspects that need additional research (on conditions that guarantee relative constancy of the distance between adaptation and just noticeable levels, the respectively valid geometries of open response and valence spaces, appropriate MDS and unfolding analyses under adaptation-level shifts, etc.).
- c) needs to be validated and related or extended to other domains than judgmental and preferential choice in order to be a contribution to a unifying theory of psychology.

The psychophysical response and valence theory could have been developed about 30 years ago, since all what is needed for its formulation has been published before the mid seventies of the 20<sup>th</sup> century. Developments in psychology thereafter, however, show that the overwhelming evidence of Helson's adaptation-level theory is almost ignored, while after the early seventies of the 20<sup>th</sup> century also substantive progress almost stagnated in mathematical behaviour theory, which caused diverging cognitive approaches in psychology. Learning theory became reduced to connectionistic theory with computational reinforcements in layered quasi-neural networks that may describe cognitive learning, but not motivation-based learning by drive satisfaction or satisfying

rewards and dissatisfying punishments. Connectionistic theory, computerised multidimensional analysis models, and cybernetic models borrowed from information science, flavoured a development of cognitive psychology that largely ignored the results of psychophysics, adaptation-level theory, mathematical response and learning theories, and (neo-)behaviouristic theory. Nonetheless, our application of the psychophysical response theory to results from more recent cognition research, shows that psychophysics, adaptation-level theory, mathematical response and learning theories, and behaviouristic theory are indispensable for cognition theory. It is our opinion that psychophysics can't do without cognition theory (Stevens' psychophysics rely on matching of perceptual sensations with cognitive magnitudes) and cognition and preference theories not without psychophysics and adaptation-level theory (distance and context dependence as well as asymmetry and/or intransitivity of similarities and gamble preferences are caused by Helson's psychophysical adaptation to presented stimuli or objects). Without efforts to integrate and unify partial theories in psychology and without analysis methods that follow from appropriate geometries of relevant psychological spaces, psychology hardly can achieve substantive progress and likely remains a bundle of hardly related or conflicting, alternative models for partial domains in psychology. **If** the psychophysical response and valence theory becomes validated then it might be a potentially unifying theory of psychology if related or extended to other domains than judgment and preference. The relevance of the theory for motivation and achievement theory is **implicit**, while its affective aspects are relevant for emotion theory. With regard to time perspectives and valence conflicts of preference realisations the theory seems also relevant for consumer and investor behaviour, while an extension to neurotic choice behaviour is indicated.

On a philosophical level our theory can be regarded as a mathematically formulated kind of phenomenology. Although this statement may seem far fetched or even contradictory, phenomenology and our theory describe both the differently experienced worlds of individuals as psychological realities that differ from physical reality. For example, much of the existential phenomenology of Merleau-Ponty (1945, 1953) is quite well in line with the psychophysical response and valence theory. The way psychological phenomena are described by Merleau-Ponty and our theory is completely different (elegant French versus dull mathematics), but similar individualised processes of perception and evaluation are described and similar explanations are given by the bodily basis of personal reality experience. Similar matters may even apply to parts of Husserl's idealistic phenomenology (Husserl, 1958, 1964), although this assertion would make Husserl turn in his grave. Nonetheless, the common object space as objective reality, - in our theory to be reconstructed by mathematical analysis from the psychological spaces of individuals -, and Husserl's idealistic concept of an objective world, - according to Husserl to be reconstructed by systematic abstraction from personal experiences -, have much in common. Descriptions of personal realities in phenomenology and our mathematical theory might be comparable, but only meaningful quantitative propositions from mathematical theory can be affirmed or falsified by research.



## REFERENCES

- Adams, E.N. (1960). Survey of Bernoullian utility theory. Part II in: Solomon, H. (Ed). *Mathematical thinking in the measurement of behavior*. Free Press of Glencoe, Illinois.
- Adelman, G. & Smith, B.R. (&Is.). (2004). *Encyclopaedia of neuroscience*. Elsevier, Amsterdam.
- Ajzen, L. & Fishbein, M. (1980). *Understanding attitudes and predicting social behavior*. Prentice-Hall, Englewood Cliffs, NJ.
- Anderson, B.F. (1975). *Cognitive psychology*. Acad. Press, New York.
- Anderson, N.R. (1981). *Foundations of information integration theory*. Acad. Press, New York.
- Andrich, D. (1982). An extension of the Rasch model for ratings providing both location and dispersion parameters. *Psychometrika*, 47: 105-113.
- Andrich, D. (1996). A hyperbolic cosine latent trait model for unfolding polytomous responses: Reconciling Thurstone and Likert methodologies. *Brit. J. Math. Stat. Psychol.* 49: 347-365.
- Andrich, D. & Luo, G. (1993). A hyperbolic cosine latent trait model for unfolding dichotomous single-stimulus responses. *Appl Psycho!. Measurement.* 17: 253-276.
- Appley, M.H. (Ed.). (1971). *Adaptation-level theory*. Acad. Press, New York.
- Arbib, M.A. (Ed.). (2003). *The handbook of brain theory and neural networks*. 2<sup>nd</sup> Ed.. MIT Press, Cambridge, MA
- Aristotle. *The works of Aristotle translated into English*. Vol. I to 12 (incl. *De Anima* and *Politica*). Harvard Univ. Press, Cambridge, MA.
- Asanov, G.S. (1985). *Finsler geometry, relativity and gauge theory*. Riedel, Dordrecht.
- Ashby, F.G. (Ed.). (1992a). *Multidimensional models of perception and cognition*. Erlbaum, Hillsdale, NJ.
- Ashby, F.G. (1992b). Multidimensional models of categorization. Ch. 16 in: Ashby, E.G. (Ed.). *Multidimensional models of perception and cognition*. Erlbaum, Hillsdale, NJ.
- Ashby, F.G. & Perrin, N.A. (1988). Toward a unified theory of similarity and recognition. *Psychol.Rev.* 95: 124-150.
- Atkinson, R.C.; Bower, G.H. & Crothers, E.I. (1965). *An introduction to the theory of learning*. Wiley, New York.
- Attneave, F. (1962). Perception and related areas. Pp.: 619-659 in: Koch, S. (Ed.). *Psychology: a study of a science*. Vol 4.. McGraw-Hill, New York.
- Aubert, H. (1865). *Physiologie der Netzhaut*. Morgenstern, Breslau.
- Audley, R.J. & Jonckheere, A.R. (1956). The statistical analysis of the learning process. *Brit. J. Stat. Psychol.* 9: 12-20.
- Baily, e. (1926). *Epicurus. The extant remains*. Oxford Univ. Press. Oxford.
- Baird, I.e. & Wagner, M. (1982). The moon illusion. I. How high is the sky? *J. Exp. Psychol., General*, 111: 296-303.
- Bakker, I.S. (1978). *Biofeedback*. (in Dutch). Van Lochem Slaterus, Deventer.

- Bandura, A. (1976). Self-reinforcement: Theoretical and methodological considerations. *Behaviorism*, 4: 135-155.
- Sandum, A. (1978). The self system in reciprocal determinism. *Amer. Psychologist*, 33: 344-358.
- Bartley, S.H. (1951). The psychophysiology of vision. Ch. 24 in: Stevens, S.S. (Ed.). *Handbook of experimental psychology*. Wiley, New York.
- Heals, R., Krantz, D.H. & Tversky, A. (1968). Foundations of multidimensional scaling. *Psychol. Rev.*, 75: 127-142.
- Beebe-Center, J.G. (1929). The law of affective equilibrium. *Am J. of Psychol.*, 41: 54-69.
- Beebe-Center, J.G. (1932). *The psychology of pleasantness and unpleasantness*. Reprint 1966, Russell & Russell, New York.
- Beebe-Center, J.G. (1951). Feeling and emotion. Pp.: 254-317 in: Helson, H. (Ed.). (1951). *Theoretical foundations of psychology*. Van Nostrand, New York.
- Bentham, J. (1779). *An introduction to the principles of morals and legislation*. Clarendon Press, Oxford.
- Berlyne, D.E. (1960). *Conflict, arousal, and curiosity*, McGraw-Hill, New York.
- Berlyne, D.E. (1971). *Aesthetics and psychobiology*. Appleton-Century-Crofts, New York.
- Berlyne, O.E. & Madsen, K.B. (Eds.). (1973). *Pleasure, reward, preference*. Acad. Press, New York.
- Bemhard, C.G. & Granit, R. (1946). Nerve as a model temperature end organ. *J. Gen. Physiol.* 29: 257-265.
- Bemoulli, D. (1738), Specimen theoriae novae de mensura sortis. *Commentari Academiae Scientiarum Imperiales Petropolitanae*, 5. English translation: Somer, L. (1954). Exposition of a new theory on the measurement of risk. *Econometrica*, 22: 23-26.
- Bevan, W.; Avant, L.L. & Lankfort, H.G. (1967). Influence of interpolated periods of activity and inactivity upon the vigilance decrement. *J. Appl. Psychol.* 51: 353-356.
- Bevan, W. & Gaylord, S. (1978). Stimuli, the perceiver and perception. Ch.12 in: Walk, R.D., & Prick Jr., H.L. (Eds.). *Perception and experience*. Plenum Press, New York.
- Bezembinder, T.G.G. (1970). *Van rangorde naar continuum*, (From rank order toward continuous metrics - in Dutch). Van Loghum Slaterus. Deventer.
- Bimbaum, M.H. (1992). Violations of monotonicity and contextual effects in choice-based certainty equivalents. *Psychol' Sci.*, 3: 310-314.
- Bloch, A.M. (1885). Experience sur la vision, *Comptes Rendus Hebdomadaires des Seances et Mmoires de la Société de Biologie*, 28: 493-496. Paris.
- Bock, O.O. & Lanes, L.V. (1968). *The measurement and prediction of judgment and choice*. Holden-Day, San Francisco.
- Bok, S.T. (1961), *Cybemica* (in Dutch). Spectrum, Utrecht.
- Bolis, C.L.; Helmreich, E.J.M. & Passow, H. (Eds.). (1984). *Information and energy transduction in biological membranes*. AR. Liss, New York.

- Borg, I. & Groenen, P.J.F. (1997). *Modern multidimensional scaling. Theory and applications*. Springer, New York.
- Boring, E.G. (1950). *Abnormal experimental psychology*. Appleton-Century-Crofts, New York.
- Bower, G.H. (1971). Adaptation level coding of stimuli and serial position effects. Pp.: 175-201 in: Appley, M.H. (Ed.). *Adaptation-level theory*. Acad. Press, New York.
- Bower, G.H. (Ed.). (1976). *The psychology of learning and motivation*. Acad. Press, New York.
- Bower, G.H. (1990). Incentive programs for promoting safer driving. Pp.: 8-16 in: Koomstra, M.J. & Christensen, J. (Eds.). *Enforcement and rewarding: Strategies and effects*. Road Transport Research Program. QED/SWQV, Leidschendam/Paris.
- Bower, G.H. & Hilgard, E.R. (1980). *Theories of learning*. Prentice-Hall, Englewood Cliffs, NJ.
- Brentano, F. (1874). *Psychologie vom empirischen Standpunkt*. Duncker und Humboldt, Leipzig. (Reprint: 1955. Meiner, Hamburg).
- Brickman, P. & Campbell, D.T. (1971). Hedonic relativism and planning the good. Pp.: 175-201 in: Appley, M.H. (Ed.). *Adaptation-level theory*. Acad. Press, New York.
- Broadbent, D.E. (1971). *Decision and stress*. Acad. Press, London.
- Broadhurst, P.L. (1959). The interaction of task difficulty and motivation. The Yerkes-Dodson law revived. *Acta Psychologica*. 16: 321-338.
- Broughton, I. (1988). Predictive models of road accident fatalities. *Traffic Engin. & Control*, 29: 296-300.
- Bryne, J.H. (1987). Cellular analysis of associative learning. *Physiological Rev.*, 67: 329-439.
- Busemann, H. (1942). *Metric methods in Finsler spaces and in the foundations of geometry*. Princeton Univ. Press, Princeton, NJ.
- Busemann, H. (1950a). Non-Euclidean geometry. *Mathematics Magazine*, Sept.-Oct.: 19-34.
- Busemann, H. (1950b). The geometry of Finsler spaces. *Bull. Am. Math. Soc.* 56: 5-16.
- Busemann, H. (1955). *The geometry of geodesics*. Acad. Press, New York.
- Busemann, H. & Kelly, P.I. (1953). *Projective geometry and projective metrics*. Acad. Press, New York.
- Busemeyer, J.R. & Diederich, A. (2002). Survey of decision field theory. *Math. Soc. Sci.*, 43: 345-370.
- Busemeyer, J.R. & Townsend, J.T. (1993). Decision field theory: A dynamic cognition approach to decision making. *Psychol. Rev.* 100: 432-459.
- Busing, F.M.T.A., Groenen, P.J.K. & Heiser, W.J. (2005). Avoiding degeneracy in multi-dimensional unfolding by penalizing on the coefficient of variation. *Psychometrika*, 70: 71-98.
- Bush, R.R. & Mosteller, F. (1955). *Stochastic models for learning*. Wiley, New York.
- Candeal, I.; De Miguel, J.R. & Indurain, E. (1996). Extensive measurement: Continuous additive utility functions on semigroups. I. *Math. Psychol.* 40: 281-286.
- Capehart, J.; Tempone, V.J. & Hebert, J. (1969). A theory of stimulus equivalence. *Psychol. Rev.* 76: 405-418.



- Cauoll I.D. (1972). Individual differences in multidimensional scaling. Pp. 105-155 in: Shepard, R.N.; Romney, A.K. & Nerlove, S.B. (Eds.). *Multidimensional scaling*. Seminar Press. New York.
- Carroll, I.D. (1976). Spatial, non-spatial, and hybrid models for scaling. *Psychometrika*, 41: 439-463.
- Carmel, I.O. & Chang, I.I. (1970). Analysis of individual differences in multidimensional scaling via a new generalization of "Eckart-Young" decomposition. *Psychometrika*. 35: 283-319.
- Carroll, I.D. & Chang, I.J. ([1972). IDIOSCAL (Individual Difference in Orientation Scaling): a generalization of INDSCAL allowing idiosyncratic reference systems. Paper presented at Psychometric Meeting. Princeton, NJ.
- Chatfield, B.V. (1987). System-wide safety improvements: an approach to safety consistency. Transportation Research Board. R-132, Washington, DC.
- Child, I.L & Whiting, J.W.M. (1954). Determinants of level of aspiration: evidence from everyday life. Pp.: 495-508 in: Brand, H. (Ed.). *The study of personality*. Wiley, New York.
- Cho. Y. & Luce. R.D. (1995). Tests of hypotheses about certainty equivalents and joint receipt of gambles. *Organization Behavior and Human Decision processes*. 64: 229-248
- Cobb. P.W. (1932). Weber's law and the Fechnerian muddle. *Psychol. Rev.*. 39: 533-551.
- Cole. H.S.D. (1973). *Models of doom*. Universe Books. New York.
- Commandeur, I.P. & Koornstra. M.J. (1001). Prognosis voor de verkeersveiligheid in 2010. (Prognosis of road safety in 2010- in Dutch). R-1001-9. SWOY, Leidschendam.
- Coombs, C.H. (1950). Psychological scaling without a unit of measurement *Psychol. Rev.*, 57: 145-158.
- Coombs, C.H. (1958). On the use of inconsistency of preferences in psychological measurement. *J. Exp. Psychol.*, 55: 1-7.
- Coombs, CH. (1964). *A theory of data*. Wiley. New York.
- Coombs. CH. (1966). Scaling and data theory. Pp.: 53-107 in: Yan der Kamp, L.J. Th. & Vlek, CA.J. (Eds.). *Psychological measurement theory*. Proc. NUFFIC international summer session in science. The Hague. Psychol. Inst. Univ. Leiden. Leiden.
- Coombs. CH. (1967). Portfolio theory: a theory of risky decision making. Conf. Proc : La Decision. Centre National de la Recherche Scientifique. Paris.
- Coombs, CH. (1972). A review of the mathematical psychology of risk and risk-taking. MMPP-72-6. Department of Psychology. Univ. of Michigan. Ann Arbor.
- Coombs, CH. & Avrunin. G.S. (1977). Single-peaked functions and the theory of preference. *Psychol. Rev.*, 84: 216-230.
- Coombs, CH. & Avrunin. G.S. (1988). *The structure of conflict*. Erlbaum, Hillsdale NJ.
- Coombs. CH.: Dawes. R.M. & Tversky. A. (1970). *Mathematical psychology*. Prentice-Hall, Englewood Cliffs. NJ.
- Coombs. C.H. & Huang, LC (1970). Test of a portfolio theory of risk preference. *J. Exp. Psychol.*, 85: 23-29.
- Coombs, CH. & Pruitt, D.G. (1960). Components of risk and decision making: probability and variance preferences. *J. Exp. Psychol.*. 60: 265-277.

- Corso, I.E. (1971). Adaptation-level theory and psychological scaling. In: Appley, M. H. (Ed.). *Adaptation-level theory*, Pp.: 27-47. Acad. Press, New York.
- Courant, R. (1960). *Differential and integral calculus*. Vol. I. Blackie & Son, London.
- Cox, T.P. & Cox, M.A.A. (1994). *Multidimensional scaling*. Chapman & Hall, London.
- Coxeter, H.S.M. (1957). *Non-Euclidean geometry*. Univ. of Toronto Press, Toronto.
- Cross, D.V. (1965). An application of mean value theory to psychophysical measurement. Rep. 05613-3-P. Behavior analysis laboratory, University of Michigan, Michigan.
- Daalder, H. & Rusk, J.G. (1972). Perceptions of party in the Dutch Parliament. pp.: 143-198 in: Patterson, S.C. & Walke, I.C. (Eds.). *Comparative legislative behavior: Frontiers of research*. Wiley, New York.
- Davidson, D.; Siegel, S & Suppes, P. (1957). *Decision making: An experimental approach*. Stanford Univ. Press, Stanford, CA.
- Day, N.E. (1966). Fitting curves to longitudinal data *Biometrics*, 22: 276-288.
- De Leeuw, J. & Heiser, W. (1977) Convergence of correction matrix algorithms for multidimensional scaling. In: Lingoes, J.E. (Ed.), *Geometric representations of relational data*. Mathesis Press, Ann Arbor, Michigan.
- De Leeuw, J. & Heiser, W. (1980). Multidimensional scaling with restrictions on the configuration. In: Krishnaiah, P.R. (Ed.), *Multivariate analysis V*. North Holland, Amsterdam.
- De Leeuw, J. & Heiser, W. (1982). Theory of multidimensional scaling. Pp.: 285-316. in: Krishnaiah, P.R. & Kanal, L.N. (Eds.). *Handbook of Statistics*, Vol. 2. North Holland, Amsterdam.
- Oember, W.N. & Earl, R.W. (1957). Analysis of exploratory, manipulatory, and curiosity behavior. *Psychol. Rev.*, 64:91-96.
- Oembo, T. (1931). Der Ärger als dynamisches Problem. *Psychol. Forsch.* 15: 1-144.
- De Soete, G.; Carroll, J.O. & De Sarbo, W.S. (1986). The wandering ideal point model: A probabilistic multidimensional unfolding model for paired comparisons data. *J. Math. Psychol.* 30: 28-41.
- De Soete, G.; Carroll, J.O. & De Sarbo, W.S. (1989). The wandering ideal point model for analyzing paired comparisons data. Pp.: 123-137 in: De Soete, G.; Feger, H. & Klauer, K.C. (Eds.). *New developments in psychological choice modelling*. Elsevier/North-Holland, Amsterdam.
- De Soete, G & Carroll, J.O. (1992). Probabilistic multidimensional models of pairwise choice data. Ch. 3 in: Ashby, F.G. (Ed.). *Multidimensional models of perception and cognition*. Erlbaum, Hillsdale, NJ.
- Dröbler, J. (1978). Alternatives in the power law: psychophysics of visual extent recommended. Pp.: 117-138 in: Leeuwenberg, E.L.J. & Buffart, H.F.J.M. (Eds.). *Formal theories of visual perception*. Wiley, New York.
- Drosler, J. (1979). Foundations of multidimensional metric scaling in Cayley-Klein geometries. *Brit. J. Math. Stat. Psychol.*, 32: 185-211.

- Dubrovín, B.A.; Fomenko, A.T. & Novikov, S.P. (1992). Modern geometry - methods and applications. Part I. *The geometry of surfaces, transformation groups, and fields*. Springer. New York.
- Dzhabarov, E.N. & Colonius, H. (1999). Fechnerian metrics in unidimensional and multidimensional stimulus spaces. *Psychonomic Bull. & Rev.*, 6: 239-268.
- Dzhabarov, E.N. & Colonius, H. (2001). Multidimensional Fechnerian Scaling: Basics. I. *Math. Psychol.* 45: 670-719.
- Eccles, I.C. (1966). *Brain and conscious experience*. Springer Verlag, New York.
- Eckart, C. & Young, G. (1936). The approximation of some matrix by another of lower rank. *Psychometrika*. 1: 211-218.
- Edwards, W. (1954). The theory of decision making. *Psychol. Bull.*, 51: 380-417.
- Eigen, M. & Schuster, P. (1979). *The Hypercycle*. Springer, Berlin.
- Eigen, M. & Winkler, R. (1975). *Das Spiel. Naturgesetze steuern den Zellen*. Piper, München.
- Eimas, P.A. & Miller, J.L. (1978). Effects of selective adaptation on perception of speed and visual patterns: evidence for feature detectors. Pp.: 307-336 in: Walk, R.D. & Prick Jr., H.L. (Eds.). *Perception and experience*. Plenum Press. New York.
- Einhorn, H.J. & Hogarth, R.M. (1985). Ambiguity and uncertainty in probabilistic inference. *Psychol. Rev.*, 92: 433-461.
- Eisler, H. & Roskam, E.E. (1977). Multidimensional similarity. An experimental and theoretical comparison of vector, distance, and set-theoretical models. *Acta Psychologica*, 41: 1-46; 335-363.
- Ekman, G. (1964). Is the power law a special case of Fechner's law. *Perc. & Mot. Skills*, 19: 730.
- Ekman, G. (1965). Two methods for the analysis of perceptual dimensionality. *Perc. & Mot. Skills*. 20: 557-572.
- Ellenberger, W. & Faulhaner, G. (2000). Empirical evaluation of axioms fundamental to Steven's ratio-scaling approach. I. Loudness production. *Perception & Psychophysics*, 62: 1505-1511.
- Elsass, A. (1886). *Ober die Psychophysik. Physikalische und erkenntnistheoretische Betrachtungen*. Elwert, Marburg.
- Elvik, R. (1996). A meta-analysis of studies concerning the safety effects of daytime running lights on cars. *Acc. An. & Prev.*, 28: 658-694.
- Engel, R. (1928). Experimentelle Untersuchungen über die Abhängigkeit der Lust und Unlust von der Reizstärke beim Geschmacksinn. *Archiv für die gesamte Psychologie*, 64: 1-36.
- Ennis, D.M. (1988). Confusable and discriminable stimuli: Comment on Nosofsky (1986) and Shepard (1986). *J. Exp. Psychol. General*, 117: 408-411.
- Ennis, D.M. (1992). Modelling similarity and identification when there are momentary fluctuations in psychological magnitudes. Ch. II in Ashby, P.G. (Ed.). *Multidimensional models of perception and cognition*. Erlbaum, Hillsdale, NJ.
- Epicurus. Letter to Menoeceus. In: Bailey, C. (1926). *Epicurus. The extant remains*. Oxford Univ. Press. Oxford.

- Estes, W.K.. (1969). Reinforcement in human learning. In Tapp, J. (Ed.). *Reinforcement and behavior*. Acad. Press. New York.
- Estes, W.K. (1982). *Models of learning, memory, and choice*. Praeger, New York.
- Estes, W.K., Campbell, I.A., Haysmoolus, N. & Hurwitt, B.B. (1989). Base-rate effects in category learning: A comparison of parallel network and memory storage-retrieval models. *J. Exp. Psychol.: Learning, Memory, and Cognition*, 15: 556-571
- ETSe. (2003). *Transport safety performance in the EU: a statistical overview*. European Transport Safety Council. Brussels
- ErSe. (1999). *Exposure data for travel risk assessment: Current practice and future needs in the EU*. European Transport Safety Council. Brussels.
- Evans, L. (1985). Human behavior feedback and traffic safety. *Human Factors*, 27: 55-576.
- Evans, L. (1986). Risk homeostasis theory and traffic accident data. *Risk Anal.*, 6: 81-94.
- Everitt, B.S. (1987). *Introduction to optimization methods and their application in statistics*. Chapman and Hall, New York.
- Eysenck, H.J. (1967). *The biological basis of personality*. Thomas, Springfield.
- Falmagne, J-C. (1976). Random conjoint measurement and loudness summation. *Psychol. Rev.*, 83: 65-79.
- Falmagne, J-C. (1985). *Elements of psychophysical theory*. Oxford Univ. Press, New York.
- Falmagne, J-C., Iverson, G. & Marcovici, S. (1979). Binaural "loudness" summation: Probabilistic theory and data. *Psychol. Rev.*, 83: 25-43.
- Fechner, G.T. (1851). *Zend-Avesta oder über die Dinge des Himmels und des Jenseits*. Voss. Leipzig.
- Fechner, G.T. (1860). *Elemente der Psychophysik*. Breitkopf und Härtel, Leipzig (English translation by Adler, H.E. (1966). *Elements of psychophysics*. Holt Rinehart & Winston, New York.
- Fechner, G.T. (1871). Zur experimentelle Ästhetik. *Abhandlungen der Königl. Sachsische Gesellschaft der Wissenschaften, Mathematisch-physische Klasse*. 9: 555-635.
- Fechner, G. T. (1876). *Vorschule der Ästhetik*. Breitkopf und Härtel, Leipzig.
- Festinger, L. (1942). A theoretical interpretation of shifts in level of aspiration. *Psychol. Rev.*, 49: 235-250.
- Festinger, L. (1957). *A theory of cognitive dissonance*. Stanford Univ. Press, Stanford. CA.
- Finsler, P. (1918). *Über Kurven und Flächen in allgemeinen Räumen*. Dissertation, Göttingen.
- Fisher, J.C. & Pry, R.H. (1971). A simple substitution model of technological change. *Technological Forecasting and Social Change*. 3: 75-88.
- Foley, J.M. (1966). Locus of perceived equidistance as a function of viewing distance. *J. Optical Soc. America*. 56: 822-827.
- Foley, J.M. (1972). The size-distance relation and intrinsic geometry of visual space: Implications for processing. *Vision Res.*, 12: 323-332

- FoM. Val. 1, Ch. 1-10 see: Krantz, et al. (1971); Vol. 2, Ch. 11-17 see: Suppes, et al (1989); Val. 3. Ch. 18- 22 see: Lure, et al. (1990).
- Foss, R.A. ((1989). Theoretical consideration of input transduction at the cell surface based on the development of a cybernetic model. *System Research*, 6: 53-63.
- Frank, J.D. (1941). Recent studies of the level of aspiration. *Psychol. Bull.*, 38: 218-226.
- Freud, S. (191\). Formulations regarding the two principles in mental functioning. Pp.: 13-21 in: Freud, S. (1950). *Collected papers*, IV. Hogarth, London.
- Fuller, R. (1984). A conceptualization of driving behavior as threat avoidance. *Ergonomics*, 11: 1139-1155.
- Fuller, R. (1988). Predicting what a driver will do: implications of the threat-avoidance model of driver behaviour. Pp.: 93-105 in: Rothengatter, I.A & de Bmin, R.A (Eds). *Road user behaviour: Theory and research*. Van Gorcum, Assen.
- Gamer, IW. (1974). *The processing of information and structure*. Wiley. New York.
- Gerretsen, IC.H. (1962). *Lectures on tensor calculus and differential geometry*. Univ. Groningen. Groningen
- Gifi, A. (1990). *Nonlinear multivariate analysis*. Wiley. Chichester.
- Gigerenzer, G. & Strube, G. (1983). Are there limits to binaural additivity of loudness? *J. Exp. Psychol.: Human Perception and Performance*, 9: 126-136.
- Gluck, M.A. (1992). Stimulus sampling and distributed representations in adaptive network theories of learning. Ch. 9 in: Healy, AF.: Kosslyn, S.M. & Shiffrin, R. (Eds.). *From teaming theory to connectionist theory: Essays in honor of William K. Estes*. Erlbaum, Hillsdale, NJ.
- Gluck, M.A. & Bower, G.H. (1988a). From conditioning to category learning: An adaptive network model. 1. *Exp. Psychol: General*. 117: 225-244.
- Gluck, M.A. & Bower, G.H. (1988b). Evaluating an adaptive network model of human learning. *J. of memory and language*, 27: [66- [95.
- Golob, T.F. & Van Wissen, L. (1989). A joint household travel distance and car ownership model. *Transp. Res. B.*, 238: 471-491
- Gomperu, B. (1825). On the nature of the function expressive of the law of human mortality, and on a new mode of determining the value of life contingencies. *Phil. Trans. Ray. Soc. London*, 1: 5[3-585.
- Good, J.J. (1969). Some applications of the singular value decomposition of a matrix. *Technometrics*, [1: 823-831.
- Gower, J.c. (1975). Generalized Procrustes analysis. *Psychometrika*, 40: 33-51.
- Gray, I. (1979). *Ideas of space. Euclidean, non-Euclidean. and relativistic*. Clarendon Press, Oxford.
- Gray, J.A. (1975). *Elements of a two-process theory of learning*. Acad. Press, London.
- Green, PE & Rao, V.R. (1972). *Applied multidimensional scaling*. Holt, Rinehart & Winstan, New York.

- Groenen, P.J.F. (1993). *The majorization approach to multidimensional scaling. Some problems and extensions*. DSWQ Press, Leiden.
- Groenen, P.J.F., Mathar, R. & Heiser, W.J. (1995). The majorization approach to multidimensional scaling for Minkowski distances. *J. of Classification*. [2: 3-19.
- Grossberg, S. (1969). Embedding fields: A theory of learning with physiological implications. *J. Math. Psychol.*, 6: 209-239.
- Grossberg, S. (1971). Embedding fields: Underlying philosophy, mathematics, and applications to Psychology, Physiology, and Anatomy. *Journal of Cybernetics*. I: 28-50.
- Grossberg, S. (1972). A neural theory of punishment and avoidance, I: Qualitative theory. *Moth. Biosciences*. 15: 39-67.
- Grossberg, S. (1982). *Studies of mind and brain: Neural principles of learning, perception, development, cognition, and motor control*. Kluwer Acad. Publ.. Norwell, MA.
- Grossberg, S., Brown, J. & Bullock, D. (1999). How basal ganglia use parallel excitatory and inhibitory learning pathways to selectively respond to unexpected rewarding cues. *J. Neuroscience*, 19: 10502-10511.
- Grossberg, S. & Carpenter. G.A. (2002). A self-organizing neural network for supervised learning, recognition, and prediction. Pp., 288-314 in: Polk, T.A. & Seifert, C.M. (Eds.). *Cognitive modelling*. MIT Press, Cambridge MA.
- Groves. P.M. & Rebec, o.V. (1988). *Introduction to biological psychology*. Brown Publ, Iowa.
- Guilford, I.P. (1954). *Psychometric methods*. McGraw-Hill, New York.
- Guilford, I.P. (1959). *Personality*. McGraw-Hill, New York.
- Guthrie. E.R. (1935). *The psychology of learning*. Harper & Row, New York.
- Guttman, L. (1968). A general nonmetric technique for finding the smallest coordinate space for a configuration of points. *Psychometrika*, 33: 469-506
- Hanken, A.F.G. (1981). *Cybernetics and society*. Abacus Press, Tunbridge Wells.
- Hanken. A.E.G. & Reuver, H.A (1981). *Social systems and learning systems*. Martinus Nijhof, Boston.
- Hardesty, D. & Bevan, W. (1965). Response latency as a function of the temporal pattern of stimulation. *Psychol. Record*, 15: 385-389.
- Hartley, D. (1749). *Observations on man. his frame, his duty, and his expectations*. London.
- Healy, A.F.; Kosslyn, S.M. & Shiffrin, R. (Eds.) (1992). *From learning theory to connectionist theory: Essays in honor of William K. Estes*. Erlbaum, Hillsdale, N.J.
- Hebb, O.O. (1949). *The organization of behavior: A neurophysiological theory*. Wiley, New York.
- Hebb, O.O. (1955). Drive and the CNS. *Psychol. Rev.*, 62: 243- 254.
- Hecht, W.J. (1938). *The nature of the visual process. The Harvey lectures*. Williams & Wilkins. Baltimore.
- Hecht. S.; Haig. C. & Chase. A.M. (1937). The influence of light adaptation on subsequent dark adaptation of the eye. *J. gen. Physiol.*, 20: 83 [1-850.

- Heiser, W.J. (1981). *Unfolding analysis of proximities*. Dep. of Data Theory. Leiden Univ., Leiden.
- Heiser, W.J. (1988). PROXSCAL. multidimensional scaling of proximities. Pp.: 445-462 in: Di Ciaccio, A. & Save, G. (Eds.) *International meeting on the analyses of multiway data matrices, software guide*. E.N.R., Rome.
- Heiser, W.J. (1989). Order invariant unfolding analysis under smoothness restrictions. Pp.: 3-31 in: De Soete, G., Feger, H. and Klauer, K.C. (Eds.). *New developments in psychological choice modelling*. Elsevier, Amsterdam.
- Heiser, W.J. (1995). Convergent computation by iterative majorization: Theory and applications in multidimensional data analysis. Pp.: 157-189 in: Krzanowski, W.J. (Ed.). *Recent advances in descriptive multivariate analysis*. Oxford Univ. Press. Oxford.
- Heiser, W.J. & de Leeuw, J. (1981). Multidimensional mapping of preference data. *Mathematiques et Sciences Humaines*, 73: 39-96.
- Helier, J. (1997). On the psychophysics of binocular space perception. I. *Math. Psychol.*, 41: 29-43.
- Heller, J. (1998). Psychophysical invariances in binocular space perception. *J. Math. Psychol.*, 42: 505.
- Helier, J. (2001). Binocular space perception models. Pp.: 1184-1187 in: Smelser, N.J. & Baltes, P.B. (Eds.). *International encyclopedia of the social and behavioural sciences*. Elsevier, Amsterdam.
- Helmholtz, H. von (1887). *Zählen und Messen erkenntnistheoretisch betrachtet*. *Philosophische Aufsätze Eduard Zeller gewidmet*. Univ. Leipzig, pp.: 356-391 in: Helmholtz, H. von (1895). *Gesammelte Abhandlungen* Vol. 3. Transl.: Brown, C.L. (1930). *Counting and measuring*. Van Nostrand, NJ.
- Helmholtz, H. von (1889). Versuch einer erweiterten Anwendung des Fechnerischen Gesetzes im Farbensystem. *Zeitschrift für die Psychologie und die Physiologie der Sinnesorgane*, 2: 1-30.
- Helson, H. (1938). Fundamental problems in color vision I. The principles governing changes in hue, saturation, and lightness of non-selective samples in chromatic illumination. *J. Exp. Psychol.*, 23: 439-476.
- Helson, H. (1948). Adaptation level as a basis for a quantitative theory. *Psychol. Rev.*, 55: 297-313.
- Helson, H. (1949). Design of equipment and optimal human operation. *Amer. J. Psychol.*, 62: 473-497.
- Helson, H. (1964). *Adaptation-level theory*. Harper & Row, New York.
- Helson, H. (1973). A common model for affectivity and perception: An adaptation-level approach. In: Berlyne, D.E. & Madsen, K.B. (Eds.) *Pleasure, reward, preference*. Acad. Press, New York.
- Hennan, R. & Montroll, E.W. (1972). A manner of characterizing the development of countries. *Proc. Nat. Acad. Sci. USA*, 69: 3019-3023.
- Hilgard, E.R. & Bower, G.H. (1966). *Theories of learning*. Appleton - Century - Crofts, New York.

- Hinckley, E.O. & Rethlingshafer, D. (1951). Value judgements of heights of men by college students. *J. Psychol.*, 3[1]: 257-262.
- Hodge, M.H. & Pollack, I. (1962). Confusion matrix analysis of single and multidimensional auditory displays. *J. Exp. Psychol.*, 63: 129-142.
- Hogarth, R.M. (1987). *Judgment and choice*. Wiley, New York.
- Holder, O. (1901). Die Axiome der Quantität und die Lehre vom Mass. *Ber. Verh. Königl. Sachs. Gesell. Wiss. Leipzig. Math.-Phys. Classe.* 53: 1-64. Translated by Michell, J & Erost, C. (1996). The axioms of quantity and the theory of measurement. *J. Math. Psychol.*, 40: 235-252.
- Holman, E.W. (1979). Monotonic models for asymmetric proximities. *J. Math. Psychol.*, 20: 1-15.
- Hopfield, J.J. (1984). Neurons with graded response have collective computational properties like those of two-state neurons. *Proc. Nat. Acad. Sc.*, 81: 3088-3092.
- Hopfield, J.J. & Tank, D.W. (1985) Neural computation of decisions on optimization problems. *Biological Cybernetics*, 52: 141-152.
- Howard, I.P. (1978). Effects of exposure to spatially distorted stimuli. Pp.: 269-305 in: Walk, R.D. & Prick Jr., H.L. (Eds.). *Perception and experience* Plenum Press. New York.
- Hull, c.L. (1943). *Principles of behavior*. Appleton-Century-Crofts, New York.
- Husserl, E. (1958). *Die Idee der Phänomenologie*. Martinus Nijhoff, The Hague.
- Husserl, E. (1964). *Erfahrung und Urteil*. Claasen Verlag. Hamburg.
- Indow, T. (1974). Applications of multidimensional scaling in perception. Pp 493-531 in: Carterett, E.C. & Friedman, P. (Eds.), *Handbook of perception. Vol. 2. Psychophysical judgment and measurement*. Acad. Press, New York,
- Indow, T. (1982). An approach to geometry of visual space with no a priori mapping functions: Multidimensional mapping according to Riemannian metrics. *J. Math. Psychol.*, 26: 204-236.
- Indow, T. (1993). Indiscriminable regions, color differences, and principal hue vectors in Munsell space. *Die Farbe*, 39: 15-23.
- Indow, T. (1997). Hyperbolic representation of global structure of visual space. *J. Math. Psychol.* 41: 89-98.
- Jantsch, E. (1980a). *The self-organizing universe*. Pergamon Press, Oxford.
- Jantsch, E. (1980b). Autopoiesis: A central aspect of dissipative self-organization. Ch. 5 in: Zeleny, M. (Ed.) *Allopoiesis. A theory of living organization*. North-Holland, New York.
- Johnston, J. (1963). *Econometric methods*. McGraw-Hill, New York.
- Jones, E.N. & Woskow, M.J. (1962). On the relationship between magnitude of loudness and pitch. *Amer. J. Psychol.* 75: 669-671.
- Kadlec, H. & Townsend, J.T. (1992). Signal detection analyses of dimensional interactions. Ch. 8 in: Ashby, F.G. (Ed.). *Multidimensional models of perception and cognition*. Erlbaum, Hillsdale, NJ.



- Kahneman, D. & Tversky, A. (1979). Prospect theory: an analysis of decisions under risk. *Economerrica*, 47: 262-291.
- Kant, I. (1787). *Kritik der reinen Vernunft*. Zweite Auflage. Zehnte neu Herausgabe von Valentiner, Th. (1913). Verlag Felix Mairer, Leipzig.
- Kapteyn, A. (1977). *A theory of preference formation*. Pasmans, The Hague.
- Keeny, R.L. & Raiffa, H. (1976). *Decisions with multiple objectives: Preferences and value tradeoffs*. Wiley, New York.
- Kelley, J.L. (1955). *General topology*. Van Nostrand, Princeton, NJ
- Kendall, M.G. & Stuart A. ([1952]). *The advanced theory of statistics*. Vol.III. Griffin, London.
- Kendler, H.H. & Kendler, T.S. (1962). Vertical and horizontal processes in problem solving. *Psychol. Rev.*, 69: 1-16.
- Klein, F. (1872). *Vergleichende Betrachtungen über neuere geometrische Forschungen*, Deichert, Erlangen
- Konstan, D. (1973). *Some aspects of Epicurean psychology*. Brill, Leiden.
- Koomstra, M.J. (1969). Simulation of learning and learning theory. Pp.: 156-168 in: Bresson, F. & Montmillon de M. (Eds.). *La simulation du compartement humain*. Dunod, Paris.
- Koomstra, M.I. (1987). Ridendo dicere verum. R-87-35. SWOY, Leidschendam.
- Koomstra, M.J. (1988). Development of road safety in some European countries and the USA. R-88-33, SWOY, Leidschendam.
- Koomstra, M.J. (1990). A general system approach to collective and individual risk in road safety. Pp.: 21-45 in: Benjamin, T. (Ed.). *Driving behaviour in a social context*. Paradigme, Caen.
- Koomstra, M.J. (1992). The evolution of road safety and mobility. *IA TSS research*, 16: 129-148.
- Koomstra, M.I. (1993). Future developments of motorized traffic and fatalities in Asia. In: Proc, CARS '93 - Conference on Asian Road Safety, pp: 1-15 of session 10. Min. of Transport, Kuala Lumpur. Revised as report: 0-93-22. SWOV, Leidschendam.
- Koomstra, M.J. (1995). Predicting the development of traffic fatalities in Latin-American and Caribbean countries. In: Proc. OECD conference "Road safety in Latin-American and Caribbean Countries", Sao Paulo. Road Transport Research Program. OECD, Paris.
- Koomstra M.J. (1997a). Analyses and prognoses of developments in kilometrage, road safety, and traffic emissions: an empirical foundation of revised principles for environmental world models. Pp.: 259-270 in: Hakkert, A.S. (Ed). *Safety and the environment in the 21<sup>st</sup> century*. Transport Res. Inst., Technion, Haifa.
- Koomstra, M.J. (1997b). Trends and forecasts in motor vehicle kilometrage, road safety. and environmental quality. Pp.: 21-32 in: Roller, D. (Ed.). *The motor vehicle and the environment - Entering a new century*. Automotive Automation. Croydon.
- Koomstra, M.J. & Christensen, J. (Eds.). (1990). *Enforcement and rewarding: Strategies and effects*. OECD Road Transport Research Program. SWOV, Leidschendam.
- Koomstra M.J.; Bijleveld, F.D, & Hagenzieker, M.P. (1997). The safety effects of daytime running lights. R-97-36. SWOV, Leidschendam.

- Krantz, D.H. (1971). Integration of just-noticeable differences. 1. *Math. Psychol.*, 8: 591-599.
- Krantz, D.H. (1972). A theory of magnitude estimation and cross-modality matching. 1. *Math. Psychol.*, 9: 168-199.
- Krantz, D.H.; Luce R.D.; Suppes, P. & Tversky, A (1971). *Foundations of measurement. Vol. I. Additive and polynomial representations*. Acad. Press, New York.
- Krumhansl, C.L. (1978). Concerning the applicability of geometric models to similarity data: The interrelationship between similarity and spatial density. *Psychol. Rev.*, 85: 445-463.
- Kruskal, I.B. (1964a). Multidimensional scaling by optimizing goodness-of-fit to a nonmetric hypothesis. *Psychometrika*, 29: 1-27.
- Kruskal, J.S. (1964b). Nonmetric multidimensional scaling: a numerical method. *Psychometrika*, 29: 115-129.
- Knanowski, W.J. (1988). *Principles of multivariate analysis*. Clarendon Press, Oxford.
- Laming, D. (1986). *Sensory analysis*. Acad. Press, New York.
- Laming, D. (1997). *The measurement of sensations*. Oxford Univ. Press. Oxford.
- Laszlo, C.A., Levine, M.D. & Milsum, J.M. (1974). A general systems framework for social systems. *Behavioral Science*, 19: 79-92
- Landis, C. (1934). Emotion n. The expression of emotion. Pp.: 312-35 L in: Murchinson, C (Ed.). *A handbook of general experimental psychology*. Clark Univ. Press, Worcester.
- Lehmann, A. (1892). *Hauptgesetze des menschlichen Gefühlslebens*. Reissland, Leipzig.
- Leopold, I.H. (1976). *Vit den tuin van Epicurus*. (From the garden of Epicurus - in Dutch. Reprint 1<sup>st</sup> ed., 1920). Uitgeverij Heureka, Nieuwkoop.
- Levelt, W.J.M.; Van de Geer, J.P. & Plomp, R. (1966). Triadic comparisons of musical intervals. *Brit. J. Math. Stat. Psychol.*, 19: 163-179.
- Levelt, W.J.M.; Riemersma, I.B. & Bunt, A.A. (1971). Binaural additivity of loudness. *Brit. J. Math. & Stat. Psychol.*, 25: 51-68.
- Lewandowski, R. (1970). *Sysematik der langfristigen Prognose*. Monographien zu den modernen Methoden des Management, Nr. 1, Dortmund.
- Lewin, K. (1938). The conceptual representation and measurement of psychological forces. *Contr. Psychol. Theory* 1, no 4.
- Lewin, K. (1942). Field theory and learning. In: *The 41<sup>st</sup> Yearbook of the National Society for the Study of Education*. Public School Publishing Co., Bloomington, Ill.
- Lewin, K., Dembo, T., Festinger, L. & Sears, P.S. (1944). Level of aspiration. In: Hunt, I McV. (Ed.). *Personality and behavior disorders*, Vol. 1. Ronald, New York.
- Licklider, J.C.R. (1951). Basic correlates of the auditory stimulus. Ch. 25 in: Stevens, S.S. (Ed.). *Handbook of experimental psychology*. Wiley, New York.
- Linden, D.J. & Routtenberg, A. (1989). The role of protein kinase C in long-term potentiation: a testable model. *Brain Res. Rev.*, 14: 279-296.
- Lindman, H. & Caelli, T. (1978). Constant curvature Riemannian scaling. *J. Math. Psychol.*, 17: 89-109.

- Lingoes, I.C. (1973). *The Guttman-Lingoes nonmetric program series*. Mathesis Press. Ann Arbor, MI.
- Link, S.W. (1992a). *The wave theory of difference and similarity*. Erlbaum. Hillsdale, NJ.
- Link, S.W. (1992b). Imitatio Estes: Stimulus sampling origins of Weber's law. Ch. 5 in: Healy, A.F.; Kosslyn, S.M. & Shiffrin, R.M, (Eds.). *From learning theory to connectionist theory: Essays in honor of William K. Estes*. Vol. 1. Erlbaum, Hillsdale, NJ.
- Logan, E.A. (1960). *Incentive*. Yale Univ. Press, New Haven
- Luce, R.D. (1956). Semiorders and a theory of utility discrimination. *Econometrica*, 24: 178-191.
- Luce, R.D. (1959a). On the possible psychophysical laws. *Psychol. Rev.* 66: 81-95.
- Luce, R.D. (1959b). *Individual choice behavior*. Wiley, New York.
- Luce, R.D. (1961). A choice theory analysis of similarity judgments. *Psychometrika*, 26: 151-163.
- Luce, R.D. (1963). Detection and recognition. Ch. 3 in: Luce, R.D.; Bush, R.R & Galanter, E. (Eds.). *Handbook of mathematical psychology*, Vol. I. Wiley, New York.
- Luce, R.D. (1977). The choice axiom after twenty years. *J. Math. Psychol.*, 15: 215-233.
- Luce, R.D. (1991). Rank- and sign-dependent linear utility models for binary gambles. *J. Econ. Theory*, 53: 75-100.
- Luce, R.D. (1992). A path taken: Aspects of modern measurement theory. Ch. 3 in: Healy, A.F.; Kosslyn, S.M. & Shiffrin, R.M. (Eds.). *From learning theory to connectionist theory: Essays in honor of William K. Estes*. Vol. 1. Erlbaum, Hillsdale, NJ.
- Luce, R.D. (1995). Joint receipts and certainty equivalents of gambles. *J. Math. Psychol.*, 39: 73-81.
- Luce, R.D. (1996). When four distinct ways to measure utility are the same. *J. Math. Psychol.*, 40: 297-317.
- Luce, R.D. (2000). *Utility of gains and losses: Measurement-theoretical and experimental approaches*. Erlbaum, Mahwah, NJ.
- Luce, R.D. (2002). A psychophysical theory of intensity proportions, joint presentations, and matches. *Psychol. Rev.*, 109: 520-532.
- Luce, R.D. (2004). Symmetric and asymmetric matching of joint presentations. *Psychol. Rev.*, 111: 446-454.
- Luce, R.D., Bush, R.R. & Galanter, E. (Eds.). (1963). *Handbook of mathematical psychology*. Vol. I and II. Wiley, New York.
- Luce, R.D., Bush, R.R. & Galanter, E. (Eds.). (1965). *Handbook of mathematical psychology*. Vol. III. Wiley, New York.
- Luce, R.D., D'Zmura, M., Hoffman, D., Iverson, G.J. & Romney, A.K. (Eds.). (1995). *Geometric representations of perceptual phenomena: Papers in honour of Tarow Indow on his 70<sup>th</sup> birthday*. Erlbaum, Mahwah, NJ.
- Luce, R.D. & Edwards, W. (1958). The derivation of subjective scales from just noticeable differences. *Psychol. Rev.*, 65: 222-237.
- Luce, R.D. & Fishburn, P.C. (1991). Rank- and sign-dependent linear utility models for finite first-order gambles. *J. of Risk and Uncertainty*, 4: 29-59.

- Luce, R.D. & Galanter, E. (1963a). Discrimination. Ch. 4 in: Luce, R.D.; Bush, R.R. & Galanter, E. (Eds.). *Handbook of mathematical psychology*, Vol. I. Wiley, New York.
- Luce, R.D. & Galanter, E. (1963b). Psychophysical scaling. Ch. 5 in: Luce, R.D.; Bush, R.R. & Galanter, E. (Eds.). *Handbook of mathematical psychology*, Vol. I. Wiley, New York.
- Luce, R.D.; Krantz, D.H.; Suppes, P. & Tversky, A. (1990). *Foundations of Measurement. Vol. III. Representation, Axiomatization, and Invariance*. Academic Press, New York.
- Luce, R.D. & Suppes, P. (1965). Preference, utility and subjective probability. Ch. 18 in: Luce, R.D.; Bush, R.R. & Galanter, E. (Eds.). *Handbook of mathematical psychology*, Vol. III. Wiley, New York.
- Luce, R.D. & Tukey, J.W. (1964). Simultaneous conjoint measurement: a new type of fundamental measurement. *J. Math. Psychol.* 1: 1-27.
- Lunenburg, R.K. (1947). *Mathematical analysis of binocular vision*. Princeton Univ. Press. Princeton, NJ.
- MacKay, D.G. & Droge, C. (1990). Extensions of probabilistic perceptual maps with implications for competitive positioning and choice. *Int. J. Res. & Marketing*, 7: 265-282.
- Maddox, W.T. (1992). Perceptual and decisional separability. Ch. 7 in: Ashby, F.G. (Ed.), *Multidimensional models of perception and cognition*. Erlbaum, Hillsdale, NJ.
- Mahalanobis, P.C. (1936). On the generalized distance in statistics. *Proc. Nat. Inst. Sci. India*, 2: 49-55.
- Mahmassani, H.S.; Chang, G.L. & Henny, R. (1986). Individual decisions and collective effects in a simulated traffic system. *Transport. Sci.*, 20: 258-271.
- Malenka R.C.; Kauer, J.A.; Perkel, D.J. & Nicoll, R.A. (1989). The impact of postsynaptic calcium on synaptic transmission: its role in long-term potentiation. *Trends Neurosciences*, 12: 444-450.
- Mannebach, E. (1961). *Arislippi et cyrenaicorum fragmenta*. Brill, Leiden.
- Marley, A.A.J. (1992). Developing and characterizing multidimensional Thurstone and Luce models for identification and preference. Ch. 12 in: Ashby, F.G. (Ed.), *Multidimensional models of perception and cognition*. Erlbaum, Hillsdale, NJ.
- Marschak, J. (1960). Binary-choice constraints and random utility indicators. pp. 312-329 in: Arrow, K.J.; Karlin, S. & Suppes, P. (Eds.). *Mathematical methods in the social sciences*. Stanford Univ. Press, Stanford, CA.
- Mashhour, M. & Hosman, I. (1968). On the new "psychophysical law": A validation study. *Perception & Psychophysics*, 3: 367-375.
- Matsumoto, M. (1986). *Foundations of Finsler geometry and special Finsler spaces*. Kaiseisha Press, Saikawa.
- Matsumoto, M. (1991). Projectively flat Finsler spaces with (a,p)-metric. *Reports on Math. Physics*. 30: 15-20.
- Maynard Smith, J. (1968). *Mathematical ideas in biology*. Cambridge Univ. Press. London.
- McClelland, D.E.; Atkinson, J.W.; Clark, R.A. & Lowell, E.L. (1953). *The achievement motive*. Appleton-Century-Crofts. New York.

- McClelland, J.L. & Rumelhart, D.E. (Eds.). (1986). *Parallel distributed processing: Explorations in the microstructure of cognition. Vol. 2: Psychological and biological models*. MIT Press, Cambridge, MA.
- McDougall, W. (1908). *An introduction to social psychology*. Methuen, London.
- McDougall, W. (1926). *Outline of abnormal psychology*. Methuen, London.
- McGuire, W.J. (1985). Attitudes and attitude change. Ch. 19 in: Lindzey, G. & Arooson, E. (Eds.). *The handbook of social psychology*. Vol. 1. Random House, New York.
- Meadows, D.L. (1972). *The limits of growth*. Universe Books, New York.
- Meadows, D.L. (1974). *Dynamics of growth in a finite world*. Wright-Allen, Cambridge, MA.
- Meadows, D.H.; Meadows, D.L. & Randers, J. (1991). *Beyond the limits. Confronting global collapse; Envisioning a sustainable future*. Earthscan Publ. London.
- Medin, D.L. & Schaffer, M.M. (1978). Context theory of classification learning. *Psychol. Rev.*, 85: 207-238.
- Mertens, P. (1973). Mittel- und langfristige Absatzprognose auf der Basis von Sättigungsmodellen. In: Mertens, P. (Ed.). *Prognoserechnung*. Physica-Verlag, Würzburg.
- Merleau-Ponty, M. (1945). *Phénoménologie de la perception*. Gallimard, Paris.
- Merleau-Ponty, M. (1953). *La structure du comportement*. Gallimard, Paris.
- Meulman, J.J. (1986). *A distance approach to nonlinear multivariate analysis*. DSWO Press. Leiden.
- Michell, J. (1990). *An introduction to the logic of measurement*. Erlbaum, Hillsdale, NJ.
- Michels, W.e. & Helson, H. (1949). A reformulation of the Fechner law in terms of adaptation-level [applied to rating scale data *Amer. J. Psychol.*, 62: 355-368.
- Miller, G.; Galanter, E. & Pribram, K.H. (1960). *Plans and the structure of behavior*. Holt, Rinehart & Winston, New York.
- Miller, N.E. (1951). Learnable drives and rewards. Ch. 13 in: Stevens, S.S. (Ed.). *Handbook of experimental psychology*. Wiley, New York.
- Miller, N.E. (1959). Liberlization of basic S-R concepts: Extensions to conflict behavior, motivation, and social learning. Pp: 196-292 in: Koch, S. (Ed.). *Psychology: A study of a science, Vol. 2*. McGraw-Hill New York.
- Miller, N.E. (1969). Learning of visceral and glandular responses. *Science*, 163: 434-445.
- Minsky, M. & Papert, S. (1969). *Perceptrons*. MIT Press, Cambridge, MA.
- Montroll, E.W. (1978). Social dynamics and the quantifying of social forces. *Proc. Natl. Acad. Sci. USA*, 75: 4633-4637.
- Morgan, C.T. & Stellar, E. (1950). *Physiological psychology*. McGraw-Hill New York.
- Mosteller, F. & Nogee, P. (1951) An experimental measurement of utility. *L. pOUI. Econ.* 59: 371-401.
- Mowrer, H.O. (1960a). *Learning theory and behavior*. Wiley, New York.
- Mowrer, H.O. (1960b). *Learning theory and the symbolic processes*. Wiley, New York.

- Mullen, K. & Ennis, D.M. (1990). A simple multivariate probabilistic model for preferential and triadic choices. *Psychometrika*, 56: 69-75.
- Näätänen, R. and Summala, H. (1976). *Road user behavior and traffic accidents*. North Holland, Amsterdam.
- Narens, L. (1981). On scales of measurement. *J. Math. Psychol.* 24: 249-275.
- Narens, L. (1985). *Abstract measurement theory*. MIT Press, Cambridge MA.
- Narens, L. (1996). A theory of magnitude estimation. *J. Math. Psychol.* 40: 109-129.
- Narens, L. (2002). *Theories of meaningfulness*. Erlbaum, Mahwah, NJ.
- Narens, L. & Luce, R.D. (1976). The algebra of measurement. *J. of pure and applied Algebra*, 8:197-233.
- Narens, L. & Luce, R.D. (1986). Measurement: The theory of numerical assignments. *Psychol. Bull.* 99: 166-180.
- Nelder, J.A. (1961). The fitting of a generalization of the logistic curve. *Biometrics*, 17: 289-296.
- Nicolis, G. & Prigogine, I. (1977). *Self-organization in nonequilibrium systems: From dissipative structures to order through fluctuations*. Wiley, New York.
- Niederée, R. (1992). *Mass und Zahl. Logisch-mathematische Untersuchungen zur Theorie der fundamentalen Messung*. Lang, Frankfurt a. M.
- Nosofsky, R. M. (1986). Attention, similarity, and the identification-categorization relationship. *J. Exp. Psychol. General.*, 115: 39-57.
- Nosofsky, R.M. (1991). Stimulus bias, asymmetric similarity, and classification. *Cognitive Psychol.* 23:94-110.
- Nosofsky, R.M. (1992a). Exemplars, prototypes, and similarity rules. Ch. 8 in: Healy, A.F.; Kosslyn, S.M. & Shiffrin, R. (Eds.). *From learning theory to connectionist theory: Essays in honor of William K. Estes*. Erlbaum, Hillsdale, NJ.
- Nosofsky, R.M. (1992b). Exemplar-based approach to relating categorization, identification, and recognition. Ch. 14 in Ashby, E.G. (Ed.) *Multidimensional models of perception and cognition*. Erlbaum, Hillsdale, NJ.
- Nuttin, J. (1980). *Théorie de la motivation humaine*. Presses Universitaires de France, Paris.
- Dobson, P.A.; Black, A.H. & Di Cara, L.V. (Eds.). (1974). *Cardiovascular psychophysiology*. Aldine, Chicago.
- DECD (1989). *Behavioural adaptations to changes in the road transport system* DECD-Report, Road Transport Research Program. DECD, Paris.
- Olds, I. & Olds, M.E. (1965). Drives, rewards and the brain. In: Baron, F. et al. (Eds.). *New directions in psychology* Vol. 1. Holt, Rinehart, & Winston, New York.
- Olds, J. (1973). Brain mechanisms of reinforcement learning. Ch. 2 in: Berlyne, D.E. & Madsen, K.B. (Eds.). *Pleasure, reward, preference*. Acad. Press, New York.
- Olst, E.H., Kok, A. & Orlebeke, J.F. (1980). *Inleiding in de psychofysiologie*. (Introduction to psychophysiology - in Dutch). Van Loghum Slateros, Deventer.

- Ono, H. (1967). Difference threshold for stimulus length under simultaneous and nonsimultaneous viewing conditions. *Perception and Psychophysics*, 2: 201-207.
- Oppe, S. (1989). Macroscopic models for traffic and traffic safety. *Accid. Anal. & Prev.*, 21: 225-232.
- Oppe, S. (1991 a). Development of traffic and traffic safety in six developed countries. *Ace. An. & Prev.*, 23: 401-412.
- Oppe, S. (1991b). Development of traffic and traffic safety: global trends and incidental fluctuations. *Ace. An. & Prev.* 23: 413-422.
- Oppe, S. & Koomstra, M.J. (1990). A mathematical theory for related long term developments of road traffic and safety. Pp.: 113-132 in: Koshi, M. (Ed.). *Transportation and traffic theory*. Elsevier, Amsterdam.
- Oppe, S.; Koomstra, M.J. & Roszbach, R. (1988). Macroscopic models for traffic and traffic safety: Three related approaches from SWay. In: Traffic safety theory & research methods", Session 5: Time dependent models. SWay. Leidschendam.
- Pavlov, I.P. (1928). *Lectures on conditioned reflexes*. Translation by Gantt. W.H. International, New York.
- Payne, J.W.; Laughhunn, D.J. & Cram, R. (1980). Translation of gambles and aspiration level effects in risky choice behavior. *Management Science*, 26: 1039-1060.
- Payne, R.B. & Hauty, G.T. (1955a). Effect of psychological feedback upon work decrement. *J. Exp. Psychol.*, 50: 343-351.
- Payne, R.B. & Rauty, G.T. (1955b). Factors affecting the endurance of psychomotor skill. *J. Aviation Med.*, 26: 382-389.
- Perrin, N.A. (1992). Uniting identification, similarity and preference: general recognition theory. Ch. 6 in: Ashby, F.G. (&1.). *Multidimensional models of perception and cognition*. Erlbaum Ass. Hillsdale, NJ.
- Pfaffmann, C. (1951). Taste and smell. Ch. 29 in: Stevens, S.S. (&1.). *Handbook of experimental psychology*. Wiley, New York.
- pfaffmann, C. (1960). The pleasures of sensation. *Psychol. Rev.*, 67: 253-268.
- Pfanzagl, J. (1962). Über die stochastische Funderung des psychophyschen Gesetzes. *Biometrische Zeitschrift*, 4: 1-14.
- Pfanzagl, J. (1968). *Theory of measurement*. Wiley, New York.
- Paigel, J. (1963). Le developpement des perceptions en fonction de l'age. In: *Traité de psychologie expérimentale, VI. La perception*. Presses Universitaires de France, Paris.
- Pollatsek, A. & Tversky, A. (1970). A theory of risk. *J. Math. Psychol.*, 7: 540-553.
- Posner, M.I. (1975). Psychobiology of attention. Ch. 15 in: Gazzaniga, M.S. & Blackmore, C. (&Is.). *Handbook of psychobiology*. Acad. Press, New York.
- Poulton, E.C. (1967). Population norms of top sensory magnitudes and S.S. Stevens' exponents. *Perceptions and Psychophysics*, 2: 312-316.
- PouJton, E.C. (1968). The new psychophysics: Six models for magnitude estimation. *Psychol. Bull.*, 69: 1-19.

- Powers, W.T. (1974). *Behaviour - The control of perception*. Wildwood House, London.
- Prais, S.J. & Houthakker, H.S. (1955). *The analysis of family budgets*. Cambridge Univ. Press, Cambridge, MA.
- Premack, D. (1974). Catching up with common sense or two sides of a generalization: Reinforcement and punishment. In: Glaser, R. (Ed.). *The nature of reinforcement*. Acad. Press, New York.
- Pribram, K.H. (1971). *Languages of the brain*. Prentice Hall, Englewood Cliffs.
- Priestley, J. (1775). *Introductory essays to Hartley's theory of the human mind*. J. Johnson, London.
- Prigogine, I. & Stengers, I. (1984). *Order out of chaos*. Heineman, London.
- Ramsay, F.P. (1931). *The foundation of mathematics and other logical essays*. Kegan Paul, London.
- Rasch, G. (1960). Probabilistic models for some intelligence and attainment tests. Danish Institute for Educational Research, Copenhagen.
- Rasch, G. (1961). On general laws and the meaning of measurement in psychology. Pp: 321-334 in: Neyman, J. (Ed.). *Proc. 4th Berkeley Symp. on Math. Stat. and Prob.* IV. Univ. Calif. Press, Berkeley CA.
- Rasch, G. (1966a). An item analysis which takes individual differences into account. *Brit. J. Math. Stat. Psychol.* 19: 49-57.
- Rasch, G. (1966b). An informal report on a theory of objectivity in comparisons. In: Van der Kamp, L.J.Th. & Vlek, C.A.J. (Eds.). *Psychological measurement theory*. Proc. NUFFIC international summer session in science at The Hague. Psychol. Inst. Univ. Leyden, Leyden.
- Restle, F. (1978). Relativity and organization in visual size judgements. Ch. 12 in: Leeuwenberg, E.L.I. & Buffart, H.F.J.M. (Eds.). *Formal theories of visual perception*. Wiley, New York.
- Rethlingshafer, D. & Hinckley, E.O. (1963). Influence of judges' characteristics upon adaptation level. *Am. J. Psychol.* 76: 116-119.
- Robb, A.A. (1921). *The absolute relations of time and space*. Cambridge Univ. Press, London.
- Roberts, F.S. (1979). *Measurement theory with applications to decision making, utility, and the social sciences*. Addison-Wesley, Reading, MA.
- Roberts, F.S. & Rosenbaum, Z. (1986). Scale type, meaningfulness, and the possible psychophysical laws. *Math. Social Sci.*, 12: 77-95.
- Roskam, E.E.Ch.I. (1968). *Metric analysis of ordinal data in psychology*. VAM, Voorschoten.
- Roskam, E.E.Ch.I. (1989). Formal models and axiomatic measurement. Pp.: 49-67 in: Roskam, E.E.Ch.I. (Ed.). *Mathematical psychology in progress*. Springer, Berlin.
- Rule, S.J. (1969). Equal discriminability scale of number. *J. Exp. Psychol.*, 79: 35-38.
- Rule, S.J. (1974). Discriminability scales of number for multiple and fractional estimates. *Acta Psychol.* 9: 328-333.
- Runnelhart, D.E. & McClelland, J.L. (Eds.) (1986). *Parallel distributed processing: Explorations in the microstructure of cognition. Vol. I: Foundations*. MIT Press, Cambridge, MA



- Rund, H. (1959). *The differential geometry of Finsler spaces*. Springer, Berlin.
- Savage. L.J. (1954). *The foundations of statistics*. Wiley, New York.
- Schadé, I.P. (1967). *Definitie van het zenuwstelsel*. (The function of the nerve system - in Dutch). Spectrum, Utrecht.
- Schadé, I.P. & Ford, D. (1965). *Basic neurology*. Elsevier, Amsterdam
- Scheerer, E. (1987). The unknown Fechner. *Psychol. Res.*, 49: 197-207.
- Schonemann, P.H. (1983). Some theory and results for metrics for bounded response scales. *J. Math. Psychol.*, 27: 3 [1-324.
- Schrodinger, E. van (1920). Farbenmetrik. *Zeitschrift für Physik*, 12: 459-466.
- Shakespeare. *The complete works of William Shakespeare*. (1966). Cambridge Univ. Press. London.
- Shepard, R.N. (1957). Stimulus and response generalization: A stochastic model relating generalization to distance in psychological space. *Psychometrika*, 22: 325-345.
- Shepard, R.N. (1958a). Stimulus and response generalization: Deduction of the generalization gradient from a trace model. *Psychol. Rev.*, 65:242-256.
- Shepard, R.N. (1958b). Stimulus and response generalization: Test of a model relating generalization to distance in psychological space. *J. Exp. Psychol.*, 55: 509-523.
- Shepard, R.N. (1962a). The analysis of proximities: Multidimensional scaling with an unknown distance function, I. *Psychometrika*, 27: 125-140.
- Shepard, R.N. (1962b). The analysis of proximities: Multidimensional scaling with an unknown distance function, II. *Psychometrika*, 27: 219-246.
- Shepard, R. N. (1964). Attention and the metric structure of the stimulus space. *J. Math. Psychol.*, 3: 287-315.
- Shepard, R.N. (1974). Presentation of structure in dissimilarity data: Problems and prospects. *Psychometrika*, 37: 373-421.
- Shepard, R.N. (1978). On the status of 'direct' psychophysical measurement. Pp 441-490 in: Savage, C.W. (Ed.). *Minnesota studies in the philosophy of science*. Vol. IX. Univ. of Minnesota Press, Minneapolis, MN.
- Shepard, R.N. (1981). Psychological relations and psychophysical scales: On the status of 'direct' psychophysical measurement. *J. Math. Psychol.*, 24: 21-57.
- Shepard, R.N. (1986). Discrimination and generalization in identification and classification: Comment on Nosofsky. *J. Exp. Psychol. General*, 117: 415-416.
- Shepard, R.N. (1987). Toward a universal law of generalization for psychological science. *Science*. 237:1317-1323.
- Shepard, R.N. (1988). Time and distance in generalization and classification: Comment on Ennis (1988). *J. Exp. Psychol. General*, 117: 415-416.
- Shepard, R.N.; Romney. A.K. & Nerlove. S.8. (1972). *Multidimensional scaling: Theory and applications in the behavioral sciences*. Seminar Press, New York.
- Siegel, S. (1957). Level of aspiration and decision making. *Psychol. Rev.*, 64: 253-262.

- Simon, H. (1955). A behavioral model of rational choice. *Quarterly J. Econ.*, 69: 99-118.
- Sokolnikoff, I.S. (1964). *Tensor Analysis. Theory and applications to geometry and mechanics a/continua*. Wiley, New York.
- Solomon, P.; Kubzansky, P.E.; Leideman, P.H.; Mendelson, J.M.; Tunball, R. & Wexler, D. (Eds.). (1967). *Sensory deprivation*. Harvard Univ. Press, Cambridge MA.
- Spence, K.W. (1951). Theoretical interpretations of learning. Ch. 18 in: Stevens, S.S. (Ed.). *Handbook of experimental psychology*. Wiley, New York.
- Spencer, H. (1870). *Principles of psychology*. Vol. I. William & Norgats, London.
- Spinoza. (1670-'72). *Short Treatise*. (1<sup>st</sup> publication 1855). Contained in: Curley, E. (Ed.). (1985). *The collected works of Spinoza*. Princeton Univ. Press, Princeton, NJ.
- Staats, A.W. (1968). *Learning, language, and cognition*. Holt, Rinehart, and Winston, New York.
- Staats, A.W. & Staats, C.K. (1963). *Complex human behavior. A systematic extension of learning principles*. Holt, Rinehart, and Winston, New York.
- Staddon, J.E.R. (1978). Theory of behavioral power functions. *Psychol. Rev.*, 85: 305-320.
- Staddon, J.E.R. (1983). *Adaptive behavior and learning*. Cambridge Univ. Press, Cambridge MA
- Staddon, J.E.R. & Ried, A. K. (1990). On the dynamics of generalization. *Psychol. Rev.*, 97: 576-578.
- Stene, I. (1968). Einführung in Raschs Theorie psychologischer Messung. Pp.: 229-268 in: Fisher, G.H. (Ed.). *Psychologische Testtheorie*, Band V. Verlag Hans Huber, Bern.
- Steinbuch, K. (1959). Lernende Automaten. *Elektroll. Rechenanlagen I*: 112-118: 172-175.
- Steinbuch, K. (1961 a). Die Lernmatrix. *Kybernetik I*: 36-45.
- Steinbuch, K. (1961b). *Automat und Mensch*. Springer-Verlag, Berlin.
- Sternberg, S. (1963). Stochastic learning theory. Ch. 9 in: Luce, R.D.; Bush, R.R. & Galanter, E. (Eds.). *Handbook of mathematical psychology*, Vol. H. Wiley, New York.
- Stevens, S.S. (1946). On the theory of scales of measurement. *Science*, 103: 677-680.
- Stevens, S.S. (1951). Mathematics, measurement, and psychophysics. Ch. I in: Stevens, S.S. (Ed.) *Handbook of experimental psychology*. Wiley, New York.
- Stevens, S.S. (1957). On the psychophysical law. *Psychol. Rev.*, 64: 153-181.
- Stevens, S.S. (1959). Measurement, psychophysics and utility. Pp.: 18-63 in Churchman, C.W. & Ratoosh, P. (Eds.). *Measurement: Definitions and theories*. Wiley, New York.
- Stevens, S.S. (1960). The psychophysics of sensory function. *Amer. Sci.* 48: 226-253.
- Stevens, S.S. (1961). To honor Fechner and repeal his law. *Science*. 133: 80-86.
- Stevens, S.S. (1975). *Psychophysics: introduction to its perceptual, neural, and social prospects*. Wiley, New York.
- Stevens, S.S. & Galanter, E. (1957). Ratio scales and category scales of a dozen perceptual continua. *J. Exp. Psychol.*, 54: 377-411.

- Stevens, S.S. & Poulton, E.C. (1956) The estimation of loudness by unpracticed observers. *J. Exp. Psychol.* 51: 71-78.
- Stevens, S.S.; Carton, A.S. & Shickman, G.M. (1958). A scale of apparent intensity of electric shock. *J. Exp. Psychol.*, 56: 328-334.
- Slruik, D.J. (1950). *Lectures on classical differential geometry*. Addison-Wesley, Reading, MA.
- Summala, H. (1988), Riskcontrol is not risk adjustment: the zero-risk theory of driver behaviour and its implications. *Ergonomics*, 31: 491-506.
- Summala, H. & Näätänen, R. (1988). The zero-risk theory and ovenaking decisions. Pp.: 82-92 in: Rothengatter, J.A. & de Bruin, R.A. (Eds.) *Road user behaviour: 71 theory and research*. Van Gorcum, Assen.
- Suppes, P. (2002). *Representations and invariance of scientific structures*. CLSI Publications. Stanford, CA.
- Suppes, P.; Krantz, D.H.; Luce, R.D. & Tversky, A. (1989). *Foundations of measurement. Vol. II. Geometrical, threshold, and probabilistic representations*. Acad. Press, New York.
- Suppes, P. & Winet, M. (1955). An axiomatization of utility based on the notion of mild differences. *Management Sci.* 1: 259-270.
- Swets, I.A. (1961). Detection theory and psychophysics: a review. *Psychometrika*, 26: 49-63.
- Takane, Y.; Young, F.W. & De Leeuw, I. (1977). Nonmetric individual differences multidimensional scaling: An alternating least squares method with optimal scaling features. *Psychometrika*, 42: 7-67.
- Tanner, W.P. Jr.; Birdsall, T.G. & Clarke, E.R. (1960). The concept of the ideal observer in psychophysics. T.R.: 98. Electronic Defense Group. Univ. of Mich., Ann. Arbor.
- Tanner, W.P.Jr. & Swets, I.A. (1954). A decision making theory of visual detection. *Psychol. Rev.*, 61: 401-409.
- Teghtsoonian, R. (1971). On the exponents in Stevens' law and the constant in Ekman's law. *Psychol. Rev.*, 78: 71-80.
- Teghtsoonian, R. (1973). Range effects in psychological scaling and a revision of Stevens' law. *Amer. J. Psychol.*, 86: 3-27.
- Teghtsoonian, R. (1974). On facts and theories in psychophysics: does Ekman's law exist. Pp.: 167-176 in: Moskowitz, H.R. et al. (Eds.). *Sensation and measurement*. Riedel, Dordrecht.
- Teilhard de Chardin, P. (1955). *Le phénomène humain*. Éditions du Sueil, Paris.
- Teyler, T.J. & Di Scenna, P. (1987). Long-term potentiation. *Ann. Rev. Neurosci.* 10: 131-161.
- Thomdike, E.L. (1903). *Educational psychology*. Lemcke & Buechner. New York.
- Thomdike, E.L. (1932). *The fundamentals of learning*. Teachers College, New York.
- Thurstone, L.L. (1927a). A law of comparative judgment. *Psychol. Rev.* 34: 273-286.
- Thurstone, L.L. (1927b). Psychophysical analysis. *Amer. J. Psychol.* 38: 368-389.
- Thurstone, L.L. (1959). *The measurement of values*. Univ. of Chicago Press, Chicago.

- Tolman, E.C. (1938). The determiners of behavior at a choice point. *Psychol. Rev.*, 43: 1-41.
- Torgerson, W.S. (1958). *Theory and method of scaling*. Wiley. New York.
- Torgerson, W.S. (1961). Distances and ratios in psychological scaling. *Acta Psychologica*. 19: 201-205.
- Treisman, M. (1964a). Sensory scaling and the psychophysical law. *Quart. J. Exp. Psychol.*, 16: 11-22.
- Treisman, M. (1964b). What do sensory scales measure? *Quart. J. Exp. Psychol.*, 16: 287-391.
- Trapp, I.P.M. (1994). Road safety and drain asphalt ZOAB. Pp.: 163-171 in Proc. Conf. "Road Safety in Europe and Strategic Highway Research Program. VTI Konferens, 2A, Part 4. VTI, Linköping.
- Tucker, L.R. (1960). Dimensions of preference. RM-60-7. Educational Testing Service, Princeton, NJ.
- Tversky, A. (1967). Additivity, utility, and subjective probability. *J. Math. Psychol.*, 4: 175-201.
- Tversky, A. (1969). Intransitivity of preferences. *Psychol. Rev.*, 76: 31-45.
- Tversky, A. ([1972]). Elimination by aspects: A theory of choice. *Psychol. Rev.*, 79: 281-300.
- Tversky, A. (1977). Features of similarity. *Psychol. Rev.*, 84: 327-352.
- Tversky, A. & Gati, I. (1982). Similarity, separability and the triangle inequality. *Psychol. Rev.*, 89: 123-154.
- Tversky, A. & Kahneman, (1986). Rational choice and the framing of decisions. *J. of Business*, 59: 251-278.
- Tversky, A. & Kahneman, (1992). Advances in prospect theory: Cumulative representation of uncertainty. *J. of Risk and Uncertainty*, 5: 297-323.
- Tversky, A. & Krantz, D.H. ([1970]). The dimensional representation and the metric structure of similarity data. *J. Math. Psychol.*, 7: 572-596.
- UN. (2003). United Nation population data base. Website: <www.un.org/popin>
- Van de Geer, J.P. (1970). *The use of non-Euclidean geometry in multidimensional scaling*. Centre for Advanced Study in the Behavioral Sciences, Palo Alto.
- Van de Geer, I.P. (1971). *Introduction to multivariate analysis for the social sciences*. Freeman & Co, San Francisco.
- Van de Geer, I.P. & de Man, H. Analysis of responses to issue statements by members of Dutch parliament. Report RB 001-75, Dep. of Data Theory. Leiden Univ., Leiden.
- Van de Geer, I.P. & Zwaan, E. (1964). Size-constancy as dependent on angle of regard and spatial direction of the stimulus. *Amer. J. Psychol.* 77: 563-575.
- Van de Geer, I.P. & Zwaan, E. (1966). The moon illusion, a mathematical recreation. In: Studies in perception - dedicated to M.A. Bouman. Inst. for Perception Research TNO, Soesterberg.
- Verhulst, P.F. (1844). Sur la loi d'accroissement de la population. *Nouvelles Mem. Acad. Roy. de Bruxelles*, 28: [-38.

- Vlek, CAJ. & Wagenaar, W.A. (1979). Judgment and decision under uncertainty. Ch. 14 in: Michon, I.A.; Eijkman, E.G.J. & de Klerk, L.F.W. (Eds.). *Handbook of psychonomics*. Vol. 2. North-Holland, Amsterdam.
- Von Neumann, J. & Morgenstern, O. (1947). *The theory of games and economic behavior*. Princeton Univ. Press, Princeton NJ.
- Wagenaar, W.A. (1968). Application of Luce's choice axiom to form-discrimination. *Nederlands Tijdschrift voor de Psychologie*, 23 : 1-2.
- Wagenaar, W.A. (1975). Stevens vs Fechner: A plea for dismissal of the case. *Acta Psychologica*, 39: 225-235.
- Wagner, M., (1985). The metric of the visual space. *Perception & Psychophysics*, 38:483-495.
- Walker, E.L. (1973). Psychological complexity and preference: A Hedgehog theory of behavior. Ch. 3. in: Berlyne, D.E. & Madsen, K.B. (Eds.). *Pleasure, reward, preference*. Acad. Press, New York.
- WB. (2003). World Bank. Website: <[www.worldbank.org/prospects](http://www.worldbank.org/prospects)>
- WBCSD (2004). *Mobility 2030: Meeting the challenges to sustainability*. World Business Council for Sustainable Development. Geneva.
- WCED. (1987). *Our common future*. World Commission on Environment and Development. Oxford Univ. Press, Oxford.
- Weber, E.H. (1834). *De pluss, resorptione, tactu et tactu; annotationes anatomicae et physiologicae*. Kolner. Leipzig. Summary: Weber (1835). Ober den Tastsinn. *Arch. Anal. Physiol.*, 152.
- Wertheimer, M. (1912). Experimentelle Studien über das Sehen von Bewegung. *Zschr. f. Psychol.*, 61: 161-265 (English translation in: Shipley, T. (Ed.). (1959). *Classics in modern psychology*. Philosophical Library, New York).
- Wicklund, R.A. & Brehm, J.W. (1976). *Perspectives on cognitive dissonance*. Erlbaum, Hillsdale, NJ.
- Widrow, B. (1960). An adaptive 'Adaline' neuron using chemical 'Memistors'. Technical report nr. 1553-2. Stanford Electronics Laboratories. Stanford, CA.
- Widrow, B. & Haft, M.E. (1960). Adaptive switching circuits. Institute of Radio Engineers, Western Electronic Show and Convention, *WE-Convention Record*. 4: 96-194.
- Wilde, G.J.S. (1982a). The theory of risk homeostasis: implications for safety and health. *Risk Anal.*, 2: 209-225.
- Wilde, G.J.S. (1982b). Critical issues in risk homeostasis theory. *Risk Anal.*, 2: 249-258.
- Wilde, G.J.S. (1989). Accident countermeasures and behavioural compensation: The position of risk homeostasis theory. *J. Occup. Accid.* 10: 267-292.
- Wilks, S.S. (1962). *Mathematical Statistics*, Wiley. New York.
- Wold, H. (1966). Nonlinear estimation by iterative least squares procedures. In: David, F.N. (Ed.). *Research papers in statistics*. *Festschrift for I. Neyman*. Wiley, New York.
- Wright, B.O. & Masters, G.N. (1982). *Rating scale analysis: Rasch measurement*. MESA Press, Chicago.

- Wundt, W. (1874). *Grundzüge der physiologischen Psychologie*. Verlag von Wilhelm Engelmann, Leipzig.
- Yerkes, R.M. & Dodson, J.D. ([ 908). The relation of strength of stimulus to rapidity of habit formation. *J. Comp. neural. Psychol.* 18: 98-121.
- Yellot, If. (1977). The relationship between Luce's choice axiom, Thurstone's theory of comparable judgment, and the double exponential distribution. *J. Moth. Psychol"* [5: 15: [09-144.
- Zinnes, J. L. & MacKay, D.B. (1992). A probabilistic multidimensional scaling approach: properties and procedures. Ch. 2 in Ashby, F.G. (Ed.) *Multidimensional models of perception and cognition*. Erlbaum, Hillsdale, NJ.
- Zucker. R.S. (1989). Short-term synaptic plasticity. *An. Rev. Neurosci.* 12: 13 -31.
- Zuckerman. M. (I 979a). Sensation seeking and risk laking. Ch. 6 in: Ilard, C.E. (&l.). *Emotions in personality and psychopathology*. Plenum Press, New York.
- Zuckennan, M. (1979b). *Sensation seeking: Beyond the optimnllevel ofarousal*. Erlbaum. Hillsdale. NI.
- Zuckennan, M. (1994). *Behavioural expressions and biosocial bases of sensation seeking*. Cambridge Univ. Press, Cambridge MA.



## AUTHOR INDEX

- Adams, EN., 6, 457  
Adelman, G., 31, 457  
Ajzen, I, 9, 457  
Anderson, B.E, 24, 457  
Anderson, N.H., 23, 457  
Andrich, D., 393-394, 457  
Appley, M.H., 22, 24, 457, 459, 461  
Arbib, MA, 31, 457  
Aristotle, 1, 34. 6. 4. 57  
Arrow, K.J., 471  
Asanov, G.S., 51, 100, 187, 213, 457  
Ashby, EG., 96, 13L 132, 154, 338, 353, 359, 364, 365 457, 461, 462, 467, 471, 473, 474, 481  
Atkinson, I.W., 471  
Atkinson, RC, 344, 457  
Attneave, F, 60, 457  
Aronson, E" 472  
Aubert, H. 50, 457  
Aud[ey, R.J., 427, 457  
Avant, LL, 458  
Avrunin, G.S" 12.16-17, 18-19, 19, 36, 78, 40[, 460  
Haif[ly, C, IV, 3, 457, 462  
Baird, IC, 328, 457  
Bakker, IS., 33, 457  
Baltes, P.B., 466  
Bandura, 31, 458  
Bartley, S.H., 59, 458  
Beals, R. 98, 458  
Beebe-Center, IG., 5, 20, 458  
Benjamin, T., 468  
Bentham, I, 4, 458  
Ber[lyne, D.E. 5, 14-[6, 18-19, 23, 31, 33, 35-36, 4[, 458, 466, 473, 480  
Bernhard., CG" 37, 458  
Bemoulli, D" 6, 76, 458  
Bevan, W., 22, 458, 465  
Bezembinder, T.G.G., 97, 458  
Bijleveld, ED., 468  
BirdsaI, T.G" 478  
Bimbaum, M.H., 243, 458  
Black, AH., 473  
B[ackmore, C., 475  
Bloch, AM" 24, 458  
Bock, D.D., 342, 458  
Bok, ST., 37, 458  
BoHs, CL, 24, 458  
Borg, J., 14, 95, 131, 154, 167-168, 205, 459  
Boring, EG., 4, 49-50, 62, 459  
Bower, G.H., 22, 28, 3[, 65, 114-116, 119, 122, 338, 344, 413, 457, 459, 464, 466  
Brehm, IW., 305, 488  
Brentano, E, 62, 459  
Brickman, P, 23, 459  
Bove, G., 466  
Broadbent, D.E., 22-25, 304, 45.  
Broughton, I, 428, 459  
Brown, C. L, 466  
Brown, I, 465  
Brom, RA, 464, 478  
Bryne, IH" 24, 459  
Buffart, HJ.EM., 461, 475  
Bullock, D., 465,  
Busemann, H. 51, 71, 76, 99, 100, 103, 121, 152, 187, 213, 235, 264, 459  
Busemeyer, IR., 31, 459  
Busing, EM.TA, 224, 459  
Bunt, AA, 469  
Bush, RR, 18, 68, 95, 427, 459, 471, 477  
Caelli, T., 99, 154, 155, 469  
Campbell, D.T., 23, 459  
CandeaI, I.C. 241, 459  
Capehart, J, 22, 66, 316, 459  
Carpenter, GA, 3[, 465  
Carroll, ID., 14, 131-133, 135, 154, 168, 205-206, 347, 364, 368, 397, 460- 461  
Carton, AS., 478  
Carterett, EC, 467  
Chang, GL, 471  
Chang, H, 14, 131-133, 135, 154, 168, 205, 460  
Chatfield, RV" 428, 460  
Chase, AM., 465  
Child., IL, 9, 460  
(ho, y. 242, 460  
Christensen, J" 417, 459, 468  
Churchman, C.W., 477  
C[ark, RA, 471  
Clarke, ER., 478  
Cobb, PW., 50, 460  
Cole, H.S.D., 402, 444, 460  
Colonius, H., 50-51, 100, 127, 167, 267, 462  
Commandeur, IF., 437, 442, 460  
Coombs., CH., 12-[3, 16-19, 27, 36, 47, 78, 95, 97, 169, 205, 214, 225, 375-376, 386, 397, 401, 460  
Corso, J.F., 22, 65-66, 117, 123, 461  
Courant, R, 71, 137, 177, 322, 461  
Cox, MAA, 14, 95, 131, 154, 168, 205, 461  
Cox, T.F., 14, 95, 131, 154, 168, 205, 461  
Coxeter, H.S.M., 71, 99, 157, 461  
Cram, R" 474  
Cross, D.V., 255, 461  
Crothers, EJ., 344, 457  
Curley, E., 449, 477  
Daalder, H., 363, 461  
Davidson, D" 9, 374, 461  
Dawes., R.M., [69, 460  
Day, N.E, 420, 461  
De Klerk, LF.W., 480  
De Leeuw, I., 14, 95, 205, 461, 466, 479  
De Man, H., 363, 479  
De Miguel, I.R., 459  
Diederich, A, 31, 459



- Dember, W.N., 5, 461  
 Dembo, T., 8, 461, 469  
 De Sarbo, W.S., 364, 397, 461  
 De Soete, G., 364, 397, 461, 466  
 Dj Cam, L.V., 473  
 Dj Ciaccio, A., 466  
 Dj Scenna, P., 24, 478  
 Dodson, I.O., 8, 481  
 Dröge, C., 361, 471  
 Drösler, J., 22, 99, 154-155, 461  
 Dubrovin, B.A., 99, 100, 137, 213, 462  
 D'Zmura, M., 470  
 Dzhafarov, E.N., 50-51, 100, 127, 167, 267, 462  
  
 Earl, R.W., 5, 461  
 Eccles, Ie", 24, 462  
 Eckart, C., 209, 462  
 Edwards, W., 50, 376, 462, 470  
 Eigen, M., 424, 437, 462  
 Eijkman, E.O.J., 480  
 Eimas, p.a., 22, 462  
 Einhom, K.I., 23, 363, 462  
 EisleT, H., 154, 462  
 Ekman, G., 53, 99, 154, 342, 462  
 Ellenneier, W., 240, 462  
 Elsass, A., 50, 462  
 Elvik, R., 418, 462  
 Engel, R., 5, 462  
 Ennis, D.M., 338, 354, 397, 462, 473  
 EpiCUIUS, IV, 3, 462  
 Ernst, C., 467  
 Estes, w.K., 29, 31, 339, 463  
 ETSe, 428, 437, 463  
 Evans, L., 412, 413, 463  
 Eventt, B.S., 168, 463  
 Eysenck, H.I., 15, 19, 463  
  
 Falmagne, J-C., 50, 246, 264, 378, 463  
 Faulhanuner, G., 240, 462  
 Fechner, G.T" 4, 49-51, 56, 76, 463  
 Feger, H., 461, 466  
 Festinger, L., 8-9, 11, 14, 305, 463, 469  
 Finsler, P., 99, 463  
 Fishbein, M., 9, 457  
 Fishbum, I.e" 241, 470  
 Fischer, G.H., 477  
 Fisher, Ie., 424, 438, 463  
 Foley, IM., 327, 463  
 FoM, 227-232, 237-240, 249-250, 252-253, 256-258, 260-262, 264, 270, 274-275, 280, 288-289, 300, 464  
 Fomenko, AT., 462  
 Ford, D., 34, 476  
 Foss, RA., 24, 464  
 Frank, IO" 8, 464  
 Freud, S. 5, 464  
 Friedman, P., 467  
 Fuller, R., 411-413, 464  
  
 Galanter, E., 49-50, 52-55, 60, 65-66, 68, 72, 93, 143, 280, 309, 344, 470-472, 477  
 Gantt, w.H., 474  
 Gamer, W.R., 368, 464  
 Gati, I., 365, 479  
 Gaylord, S., 22, 458  
 Gazzaniga, M.S., 475  
 Gerretsen, Ie.H., 100, 213, 464  
 Gifi, A., 155, 303, 207, 464  
 Gigerenzer, G., 246, 464  
 Glaser, R., 475  
 Gluck, MA., 18, 31, 35, 338, 464  
 Gompertz, B., 420, 464  
 Good, H., 209, 464  
 Gower, J.e., 153, 157, 218, 405, 464  
 Granit, R., 37, 458  
 Gray, I., 112, 121, 464  
 Gray, IA., 29, 32-33, 464  
 Green, P.E., 14, 464  
 Groenen, P.J.E., 14, 74, 95, 131, 154, 167-168, 203, 224, 459, 465  
 Grossberg, S., 24, 30-31, 35, 465  
 Groves, P.M., 24, 465  
 Gliliford, I.P., 25, 49, 53, 57-58, 465  
 Guthrie, ER, 29, 32, 465  
 Guttman, L., 14, 465  
 Haig, e., 465  
 Hagenzieker, M.P., 468  
 Hakkert, AS., 468  
 Hanken, A.F.G., 24, 89, 465  
 Hardesty, O., 22, 465  
 Hartley, D., 4, 465  
 Hauty, G.T., 28, 474  
 Healy, AF., 21, 25, 464, 465, 470, 473  
 Hebb, O.O., IS, 19, 24, 30, 35, 465  
 Hebert, I., 459  
 Hecht, S., 20, 59, 465  
 Heiser, W., 14, 95, 167-168, 205, 224, 459, 461, 465, 466  
 Helier, I., 326, 329, 466  
 Helmholtz, H. von, 99, 228, 466  
 Helmreich, EIM., 458  
 Helson, H., 20-24, 28, 55-57, 63, 244, 247, 301, 304-306, 325, 458, 466, 472  
 Hennan, R., 438, 466, 471  
 Hilgard, ER., 22, 28, 31, 459, 466  
 Hinckley, EO., 24, 467, 475  
 Hodge, MH., 344, 467  
 Hoff, M.E., 31, 480  
 Hoffman, O., 470  
 Hogarth, RM., 23, 28, 365, 372, 399, 462, 467  
 Holder, O., 241, 467  
 Holman, EW., 346, 467  
 Hopfield, I.I., 31, 467  
 Hosman, J., 60, 471  
 Houthakker, H.S., 420, 475  
 Howard, IP., 22, 467  
 Huang, L.e., 386, 460  
 Hull, CL., 18, 29, 35, 467  
 Hunt IMcV., 469  
 Husserl, E., 455, 467  
 Indow, T., 99, 154-155, 326, 467  
 Induniin, E., 459  
 Iverson, G., 463  
 Iverson, G., I, 470  
 Izard CE., 481

- Jantsch, E., 424, 437, 441, 447, 467  
 Johnston, I., 420, 467  
 lanes, EN., 59, 467  
 lanes, L.V., 342, 458,  
 lonckheere. AR, 427, 457  
 Kadlec. H., 368, 467  
 Kahneman. D, 12,23, 241. 274,  
 283, 376,468, 479  
 Kanal, L.N. 461  
 Kant. I., 129, 468  
 Kapteyn. A, 7, [2.67,76-77,  
 376,468  
 Karlin, S., 471  
 Kauer, I.A. 471  
 Keeny, R.L. 12. 19,82.468  
 Kelley, J.L., 235, 468  
 Kelly, P.J., 71. 76,1003, 459  
 Kendall, M.G.. 142. 144,468  
 Kend[er, H.H., 305, 468  
 Kandler, I.S., 305, 468  
 Klauer, KC., 461, 466  
 KJain, F., 227, 468  
 Koch. S., 457, 472  
 Kok.. A,474  
 Konstan, D., 3, 468  
 Koomstra, M.J., 24, 31,411, 417-  
 420,425,428,429,436,438,  
 441-442,459,460,468,474  
 Koshi, M" 474  
 Kosslyn, S.M" 464, 465, 470.  
 473  
 Krantz. D.H., (see also FoM),  
 50, 65, 98, 192, 227, 280,  
 458, 464, 469. 471, 478,  
 47'  
 Krishniah, PR, 461  
 Krumhansl, C.L., 347,368-370,  
 469  
 Kruskal IB., 14,95, 133,469  
 Kubzansky, P,E, 477  
 Krzanowski, WJ., 131. 154,  
 405,466,469  
 Laming, O" 50, 292, 294, 469  
 Lankfol1, H.O., 458  
 Landis, C., 34, 469  
 Laszlo, CA, 437, 469  
 Laughhunn,DJ., 474  
 Leeuwenberg, ELI., 461, 475  
 Lehmann, A., 5, 469  
 Leideman, P.H., 477  
 Leopald, IH., 3, 469  
 Levelt, WJ.M" 246, 303, 469  
 Levine, MD., 469  
 Lewandowski, R., 422, 469  
 Lewin, K., 6, 8, 49, 91, 469  
 Licklider, Ie.R., 59, 469  
 Linden. DJ., 24, 469  
 Lindman, H, 99, 154,469  
 Lindzey, G., 472  
 lingoies, J,e., 14,461,470  
 Link, S.w., 291, 364, 470  
 Logan, FA, 29, 67, 470  
 Lowell, EL, 471  
 Luce, RD., (see also FoM), 6,  
 11-12,31,49-50,53-55,65-  
 66,68,70,72,93, 143,225,  
 227-228,230-231,241-247,  
 249,251-252,257,270-275,  
 279-280,282-283,285-286,  
 289,309,326,329,337,340,  
 344,375-376, 378, 427, 464,  
 469,470,471,473,477,478  
 Lucretius, 3  
 Lunenburg, RK, 99, 327, 471  
 Luo, G., 393, 457  
 MacKay, O.8., 359, 3608, 471,  
 481  
 Maddox., W.T" 368, 471  
 Madsen, K8., 5, 15, 23, 36,  
 458,466,473,480  
 Mahalanobis, P.e., 400, 471  
 Mahmassani, H.S., 411, 471  
 Malenka, Re., 24, 471  
 Mannebach, E., 3. 471  
 Marcovici, S. 463  
 Marley, AAJ., 364, 471  
 Marschak, J., 6, 471  
 Mashhour, M., 60. 471  
 Masters, G.N., 394, 480  
 Mathar, R, 167,465  
 Matsumoto, M., 51, 100, 101.  
 187,213,214,471  
 Maynard Smith, J., 420, 471  
 McClelland, D.C" 22, 471  
 McClelland, J.L, 31, 472, 475  
 McDougall, W., 5, 472  
 McGuirie, W.J., 305, 472  
 Meadows, D.L, 402, 443-444,  
 447-448,472  
 Meadows, D.H., 402, 443-444,  
 447-448,472  
 Medin, D.L., 338, 472  
 Mendelson, J.M., 477  
 Mertens, P" 422 472  
 Merlau-Ponty, M" 455, 472  
 Meulman, JJ., 95, 472  
 Michell, J" 227. 467, 472  
 Michels, W,e., 56, 472  
 Michon, IA, 450  
 Miller, G, 31, 472  
 Miller, IL, 22, 462  
 Miller, NE, 18, 29,33,472  
 Milsum, J.M., 469  
 Minsky, M., 31, 472  
 Montroll, E.w., 424, 438, 466,  
 472  
 Morgan, e.T., 34, 37, 472  
 Morgenstem, D" 6, 480  
 Moskowitz, HR, 478  
 Mosteller, E, 18, 371, 427, 459,  
 472  
 Mowrer, HD" 29, 31, 472  
 Mullen, K, 397,473  
 Murchinson. C., 469  
 Näätänen. R, 408, 411-412,  
 473,478  
 Narens, L, 227-228, 230, 240-  
 241,246,252,270-271,473  
 Nelder, IA, 420, 473  
 Nerlove, S.B., 460, 476  
 Nicoli, R.A, 471  
 Nicolis, G., 437, 473  
 Niederée, R, 227, 473  
 Noguee, P., 374, 472  
 Nosofsky. RM" 301, 338-339,  
 341,344,346-347,353-354,  
 366, 368, 473  
 Novikov, S.P., 462  
 Nuttin, J., 23, 473

- Ohrist, P.A., 33, 473  
 DECD, 413, 473  
 Olds, 118, 31, 33, 65, 473  
 Olds, *ME*, 31, 33, 473  
 Dlst, E.H., 31, 429  
 Ono, H., 60, 474  
 Oppe, S., 419-420, 3425, 428, 431, 437-438, 474  
  
 Passow, H., 458  
**Papert, S.**, 31, 472  
 Patterson, S.c., 461  
 Pavlov, I.P., 28, 474  
 Payne, I.W., 18, 474  
 Payne, R.B., 28, 474  
 Perkel, D.J., 471  
 Perrin, N.A., 131-132, 205, 353, 359, 364-365, 457, 471  
 Pfaffmann, C., 5, 33, 59, 474  
 Pfanzagl, I., 50, 227, 255, 474  
 Piaget, J., 60, 474  
 Plomp, R., **469**  
 Pollack, L., 334, 467  
 Pollatsek, A., 240, 474  
 Polk, T.A., 465  
 Posner, M.J., 24, 474  
 Poulton, E.C., 59, 62, 474, 478  
 Powers, 24, 475  
 Prais, S.J." 420, 475  
 Premack, D., 67, 475  
 Pribram, K.H., 67, 472, 475  
 Priestly, I., 4, 475  
 Prick, H.L. Jr., 458, 462, 467  
 Prigogine, I., 437, 473, 475  
 Pruitt, D.G., 376, 386, 460  
 Pry, R.H., 424, 438, 463  
  
 Raiffa, H., 12, 14, 82, 448  
 Ramsay, E.P., 6, 475  
 Randers, I., 472  
 Rao, V.R., 14, 464  
 Rasch, G., 228, 249, 394, 475  
 Ratoosh, P., 477  
 Rebec, G.Y., 24, 465  
 Reuver, H.A., 20, 89, 465  
 Restle, F., 22, 475  
 Rethlingshafer, D., 24, **467**, 475  
 Ried, A.K., 354, 477  
  
 Riemersma, I.B., **469**  
 Robb, A.A., 108, 475  
 Roberts, E.S., 227, 228, 475  
 Roller, D., 468  
 Romney, A.K., 460, 470, 476  
 Rothenganer, I.A., 464, 478  
 Rosenbaum, Z., 228, 475  
 Roskam, E.ECh.I" 97, 131, 154, 203, 207, 240, 462, 475  
 Roszbach, R., 474  
 Routtenberg, A., 24, 469  
 Rule, S.I" 60, 475  
 Rummelhart, D.E., 31, **472**, 475  
 Rund, H., 51, 100, 187, 213, 476  
 Rusk, I.G., 363, **461**  
 Savage, L.J., 6, 476  
 Savage, C.W., 476  
 Schädé, I.P" 34, 476  
 Schaffer, M.M., 338, 472  
 Scheerer, E., 49, 476  
 Schonemarm, P.H., 167, 467  
 Schrödinger, E von, 99, **467**  
 Schuster, P., 424, 437, 462  
 Sears, P.S" 469  
 Seifert, C.M., 465  
 Shakespeare, W., 225, 476  
 Shepard, R.N., 14, 65, 67-68, 70, 97, 131, 154, 205, 280, 338, 354, 449, 460, 476  
 Shiffrin, R., 464, **465**, 470, 473  
 Shickman, G.M" 478  
 Siegel" S., 6, 9-12, 14, 374, 461, 47.  
 Simon, H., 11, 404, 477  
 Smelser, N.J., **466**  
 Smith, H.H., 32, 457  
 Sokolnikoff, I.S., 100, 213, 477  
 Solomon, H., 457  
 Solomon, P., 24, 37, 41, 477  
 Somer, L" 458  
 Spence, K.W., 29, 477  
 Spencer, H., 1, 4, 477  
 Spinoza, 449, 477  
 Staats, A.W., 31, 477  
 Staats, C.K., 31, 477  
 Staddon, I.E.R., 62, 67, 354, 477  
 Steinbuch, K., 31, 477  
 Stellar, E., 34, 37, 472  
 Stene, I., 228, 394, 477  
 Stengers, I., 437, 475  
 Sternberg, S" 18, 31, **66-67**, 425, 427, 477  
 Stevens, S.S" 52, 54-55, 57, 60, 62, 85, 114, 117, 119, 123, 228, 232, 295, 458, 469, 472, 474, 477, 478  
 Slrube, G" 246, 469  
**Struik, DJ"** 99, 478  
**Stuart, A, 142**, 144, 468  
 SummaJa, H., 408, 411-412, 473, 478  
 Suppes, P., (see also FoM), 6, 9, 11, 66, 98-99, **227**, 229, 236, 251, 329, 374, 376, 378, 380, 461, 464, 469, 471, 478  
 Swets, I.A., 359, 478  
  
 Takane, Y., 14, 478  
 Tank, D.W., 31, 467  
 Tanner, W.P, Jr., 359, 478  
 Teghtsoonian, R., 59-63, 244, 247, 294-295, 303, 328, 478  
 Teilhard de Chardin, P., 399, 442, 478  
 Ternpone, V.J., 459  
 Teyler, T.I., 24, 478  
 Thomdike, E.L., 28, 478  
 Thurstone, L.L., 66, 142, 333, 478  
 Tolman, E.C., 29, 479  
 Torgerson, 54, 162-163, 166, 261-262, 339, 479  
 Townsend, I.T., 31, 368, 459, 467  
 Treisman, M., 52, 479  
 Tramp, I.P.M" 418, 479  
 Tucker, L.R., 182, 203, 207, 479  
 Tukey, I.W., 251, 471  
 Tunball, R., 477  
 Tversky, A., (see also FoM), 11, 12, 23, 98, 169, 240, 241, 243, 274, 283, 347, 354-355, 365, 368, 370, 372, 376, 379-380, 382-386, 389-390, 392, 451, 458, 460, 468, 469, 471.

- 474, 478, 479
- UN, 445, 479
- Van de Geer, IP., 78, ~~99~~, [46, 154-155, 157, 162, 220, 222, 303, 328, 363, 461, 479
- Van der Kamp, U. Th., ~~460~~, 477
- Verhulst, P.P., 420, 479
- Vlek, CA 1, 372, 460, 475, 480
- Von Neumann, I, 6, ~~480~~
- Wagenaar, WA, 52-53, 344, 372, 480
- Wagner, M., 327, 328, 457, ~~480~~
- Walk, R.D., 458, 462, 467
- Walke, IC., 461
- Walker, E.L, 5, 480
- WB, 446, 480
- WBCSD, 404, 446, 480
- WCED, 444, 480
- Weber, 50, 51, 62, 292, ~~480~~
- Wertheimer, M., 20, ~~480~~
- Wexler, D., 477
- Whiting, IW.M., 9, 460
- Wicklund, RA, 305, 480
- Widrow, B., 31, 480
- Wilde, G.J.S., 411412, ~~480~~
- Wilks, S.S., 50, 144, 332, 480
- Winkler, R, 437, 462
- Winet, M., 25 [, 478
- Wold, H., 423, 432, 480
- Woskow, MJ., 59, 467
- Wright, D.B., 394, 480
- Wundt, W., 4, 481
- Yerkes, R.M., 8, 481
- Yellot, H, 330, 333, 481
- Young, F.W., 478
- Young, G., 209, 462
- Zeleny, M., 467
- Zinnes, J.L., 359, 481
- Zucker, RS., 24, 481
- Zuckennan, M., 5, 24, 35, 43, 386, 417, 481
- Zwaan, E., 328, 479



## SUBJECT INDEX

- Adaptation**  
 evolutionary, see: *evolution*  
 psychophysical, [7-18,24-25. 38, 88-80]
- Adaptation level (adaptation point)**  
 shifts, see: *dynamic relativity*  
 individually different 13 [-135, [83-184,208  
 relationship with Stevens' power exponent,  
 see: *power exponent - dimensional*  
 theory. 2D-IS, 63-67, S0-81, 86-88, 245, 247
- Ambivalence, see: *conflict*
- Angular transformation of probability, 342
- Anxiety, 40, 43-45, 179
- Arctangent,**  
 product as single-peaked valence function, 178,  
 186-187, 189-191, 194-196,206-207,216-  
 2[8,387,389,393,396  
 response (ideal axis) function, 136, 138, 141-  
 147,171. 174, 181,210,212,234-35,279,  
 281,287-88,293,331-332,341-341,348-  
 349,351-352,356,377,379,381
- Arousal, [4-15,36,40-41 402.407,411-412,417
- Aspiration level. 6-12. 28, 85  
 see also: *ideal point*
- Automorphism,** 234, 235-236, 275
- Aversion, 36-40  
 expectancy, 26, 70, 79, 244  
 dominance, 17-[8,33,79  
 system, 14-16,29,79-81
- Behavioural preference control, 89-91
- Bipolarity, see: *hedonic scale properties*
- Bower sensations,** see: *sensations - comparable*  
 space, 115-116. [20, 122, 127, 131, 145, 150-  
 [55, 179-182, 185-186, 196-197, 199,202,  
 205-206, 210, 223. 271. 274, 280, 282, 284,  
 286. 289-290. 303. 312, 315, 317-318
- Canonical analysis, 207, 220-224
- Categorisation,** see: *similarity - asymmetric similarity*
- Choice**  
 axiom, 68, 329-330, 340-341  
 conditional, 330-336. 340, 349-350, 394  
 irrelevance of other alternatives, 330-333.34[,346  
 conflict, see: *conflict*  
 dynamics, see: *dynamic relativity*  
 judgmental, see: *response*  
 preferential, see: *valence*,  
 probability,  
 similarity, see: *similarity - probability*  
 preference, see: *preference - probability*
- Cognitive (cognition)**  
 common object space  
 see: *common object space*  
 complexity, 320-321, 323-324  
 familiarity (unfamiliarity), 320-321, 323  
 magnitude sensation, 53-56, 58, 60, 63, 85,  
 [14-[7,119, 122-123, [25-126,240,  
 245-247,283,293,303,327,373,375  
 reference level, 19, 23-24, 26, 35-36, 40, 67-68  
 70,74-79,81. 90, [17,241,247.304-305.  
 308-309, 347, 365-368, 377, 382, 388, 392  
 theory, 3. 22, 25, 85, 320, 362-371
- Common Euclidean object space,** ICD-I01. 127,  
 13\, 137, 146.152-157, [64, 168, 171-172,  
 182, 184, 200. 203-204, 207-209, 2[3-215,  
 220-224,266-269,273.361. 371  
 cultural dependence. 404-405  
 sensation, 96. 100-101, 112, 133, 137, [S0,  
 154-165, 167, 17[, 178, 18t-L82, 188-189,  
 194. 196, 200-204, 207, 209, 212, 214-  
 2[5,218,220-222,268.282" 290, 293,  
 341-342,360,371  
 stimulus.96. 100-101, 149, 151-155, [62, [64-  
 165,167, [71 [83-184,188.196,202-204,  
 207, 214-215, 218-224, 268, 282, 364,  
 368.371
- Conflict (ambivalence, dilemma),** 18.43,45, 78,  
 86, 179, 399, 401-411  
 cognitive vs realisable preferences. 405-409  
 mixed valences, 404-409  
 partial indifference, 406-408  
 single-peaked valences, 401, 409-410  
 see: *road traffic - risk - adaptation theory*  
 indifference range, 179, 409-410
- Confusion probability, see: *similarity - probability*
- Cosine transformation of probability, 341
- Cross-modality matching,** see: *matching*
- Cumulative probability function**  
 Cauchy, 50, 77, 80. 142-146,276.289.332,  
 333.336,340,342  
 folded and scaled, 332-333, 341  
 integration of distribution, 332  
 double-exponential, 330, 334  
 log-nonnal. 7, 77  
 logistic, 16.50. 66-68, 70-71, 77. 79-80, 142-  
 143. 145. 167,279.289.330-331. 333, 337  
 folded and scaled, 336-337, 342, 344. 349  
 normal (Gaussian). 7, 16. 66-67, 77, 79-80.  
 142-143.333

## Curvature

- constant, 77, 80, 99, 106, 108, 117, 124-125, 140, 145, 167, 187, 196, 235-237, 264-272, 274-279, 285, 287, 289, 333, 363
  - elliptic, 102-103, 107, 124, 146, 282
  - hyperbolic, 102-103, 106, 112, 124, 176, 245, 270-273, 276, 282, 286-287
  - minusahalf, 188, 193, 195-1%, 201, 206, 213, 273, 276, 283-285, 299, 335, 387
  - iso-valent contour, 180-181, 185, 195-1%
  - unit (+1, -1), 102, 108-110, 112, 118, 138, 148-150, 152, 158, 161-162, **m**, 201
  - r-metric relationship, see: *Minkowskifan) geometry - r-metric*
  - variable, 93, 105, 185, 189, 244
    - distance-dependent, 93, 171-172, 174-175, 180-183, 196, 215-216, 245, 248, 265
  - zero, 77, 80, 99, 124, 167, 201, 235-237, 264, 272, 274-279, 282, 285, 287, 289, 333, 363
- Deprivation (sensory), 15, 19, 24, 37-38, 41-42
- level (**point**), 27, 35-42, 45, 49, 74-81, 83, 91, 186, 190, 195, 197, 202, 217, 238, 261, 299, 327, 409, 412-414
  - coinciding, see: *just noticeable - sensation*
  - reflected saturation level, 41-42, 185-186
- Dilemma, see: *conflict*
- Discrimination probability, 50, 66-68, 71, 77, 142-145, 167, 279, 330-332, 336-337, 344
- see: *response - probability function*
- Dissimilarity, see: *similarity*
- Distance
- axioms,
    - triangular inequality, 98-99, 113, 152, 235, 264-265
    - quadrangular monotonicity, 264-265, 276-277, 279, 285, 287, 289
    - conditional **quaternary monotonicity**, 266-267, 273, 277, 290
  - conformal **metric**
    - stimulus and response spaces, 137-138, 141, 150, 248, 279-280, 335
    - hyperbolic sensation and **single-peaked** valence spaces, 190, 199, 280
  - elliptic, 99-100, 107, 131, 136, 138-141, 146, 151-158, 161-162, 168, 178, 213, 287, 298, 322, 332, 340-341, 348, 356, 369
  - EucJidean, 100, 131, 138, 141, 147-148, 151-153, 163, 167-168, 172, 177, 184, 187, 190-194, 1%, 206, 213-215, 287, 290, 298, 313-318, 335-339, 341-342, 345-346, 348-349, 355-356, 369, 382, 387, 394-395

Finsler, 99-100, 167, 187, 267

- hyperbolic, 99-100, 113, 121, 131, 138-141, 147-148, 151-155, 161-165, 168, 178, 188, 191-197, 206, 213-217, 287, 290, 297-298, 321, 330, 333-336, 339-340, 345-346, 349-350, 355-356, 369, 382, 387, 394-395
- invariance (**rotation** and **translation**), 98-99, **metric**, 95-%
- Minkowski**, see: *Minkowski geometry - r-metric*
- permissible geometries, 236-237, 263-270, 277
- rational, 99, 169, 206, 213

## Dynamic relativity

- adaptation-level** shift, 21-26, 36, 49, 66, 76, 86-91, 301, 329, 379-384, 388-397, 415-416
    - to target stimulus, 308-316, 335, 348-353, 355, 357, 366-367, 372, 395-396
    - to stimulus-pair midpoint, 314-320, 322, 324, 339-343, 355-357, 370-372, 379, 381-385, 388, 396
    - to stimulus-subset centroid, 320-325, 358, 366, 370, 378
    - to subspace (lower dimensionality), 318, 324-325, 366, 370, 378
  - cognitive reference-level, 23, 40, 76, 320, 322-325, 359, 361-368, 374, 377, 392
  - memory **dependence**, 304-305, 308, 320, 323-324, 357-558
  - stimulus and task dependence, 308, 311, 322, 325, 366-367
  - conflict, 408-409
  - (dis)similarity (**categorisation, confusion**), 325, 344-353, 355-357, 359, 366-367
    - see also: *similarity - probability - model*
  - ideal point (distance to **adaptation** point), 81-85, 324-325, 371, 392-393, 411-415
  - preference (valence), 324-325
    - monotone valence, 76-77, 372-379
    - single-peaked** valence, 81-85, 374, 390-392
  - risk, see: *risk behaviour - dynamics*
- Eigenvalues and vectors see: *principal components*
- Elliptic,
- distance, see: *distance*
  - geometry, see: *geometry*
  - projectivity, 71, 146, 150
    - see also: *involution - space - quasi-elliptic*
- Environmental development,
- global warming, 446-447
  - pollution, 179, 402, 437, 443-444, 447
    - industrial emissions, 402, 444, 446-447
    - road traffic** emission, 437, 442, 445-446
  - world (doom) model, 402, 443-448

- Euclidean  
 co-ordinate embedding of  
   hyperbolic spaces, 56, [02, 104-105, [08-112, 118, [25-[26,138, [47, 152, 161, 330, 333-335, 340, 342-343, 369  
   single-elliptic space, [02, 106-[07, 125, 138, 145, 152, 157-158, 341, 369  
 distance, *see: distance*  
 geometry, *see: common object space*  
   *sensation, space geometry-flat*  
   *stimulus - space geometry*  
 open, *see: response - space geometry*  
   *involution - space*
- Evo[ution  
 adaptive self-organising system, 402, 424, 437, 445-446, 448  
   growth, 438-441, 444, 448  
   self-destructive outcome rate, 402, 416, 442-444, 446  
 biological systems, 424, 437, 442  
 general theory of technological systems, 402, 419, 437, 443  
   sustainable world developments, 446-448  
 transport system, *see: road traffic - growth*
- Exchange value, 3, 6, 44
- Fai[ure probability, 8-10, 435-427, 442
- Fechner (Fechner's, Fechnerian)  
 law (function), 21-22, 49-58, 75, 76, 117, 123  
 scaling, 100, 127, 167, 267  
 space (plane), 102, 114-122-124, 127, 186, 197, 215, 263, 271, 280, 347, 350  
 psychophysics, *see: psychophysics*
- Fechner-Helson  
 function, 57-58, 64-65, 101-103, 106, 108-110, 112-114, 122, 124, 126, [42-144, 146, 149  
 inverse function, 101, 113  
 sensations, 56-58, 61-63, 288, 2%, 313, 316  
 space, 106, 108, III, 115, 118, 122
- Generalisation  
 exponential, 68-69, 245, 338, 354, 369  
 Gaussian, 338, 345, 348, 354, 369
- Geometry  
 curvature, *see: curvature*  
 differential, *see: geometry - non-Euclidean*  
 elliptic, 99-100, 106-108, 113, 137, 140-141, [45, [49-[50, 190, 238, 248, 266, 272, 280, 282, 285-286, 293, 2%, 299, 327, 336, 348, 353, 363, 382  
   *see: stimulus - space geometry*  
 Euclidean, *see: Euclidean*
- Finsler, 51, 99-[00, 114, 116-117, 126, 167, 187, 213" 235, 267, 271  
 projectively flat, 10[, 214
- flat, *see: Euclidean*  
 Minkowski geometry  
 hyperbolic, 92-93, 102, 104, 247  
   *see: sensation - space geometry*  
   *stimulus - space geometry*  
 involution, *see: involution - space*  
 non-Euclidean, 93, %, 98-103, 108, 113, 152, 154-155, 270  
   *see: stimulus - space geometry*  
 Minkowskian, *see: Minkowski geometry*  
 open, 96, 99, 138, 148, 232, 267-268, 371  
   Finsler, *see: single-peaked valence*  
   *mixed valence*  
   hyperbolic, *see: response - space*  
   *single-peaked valence*  
   Euclidean, *see: response - space*  
   single-elliptic, *see: response - space*  
 permissible distance,  
   *see: distance - permissible geometries*  
 projective, 71, 98-100  
   *see: projection - space transformation*  
   *involution, space*
- Hedonic function properties (of sensation scales),  
 asymptotic level, 15, 19  
 bipolarity, [1, 14, 26, 34-36, 44, 49, 56, 70, 78  
 congenital, 36-39, 79, 81, 86  
 cognitive, 41-44, 86  
 distance (between function origins), 6, 14, 17-[9, 35, 36, 44-45, 49, 78-82, 85  
 dominance, 33- 35, 79,  
 multiplicity, 14, 35-36, 44-45, 49, 78, 81, 290  
 ogival (S-shaped), 8-9, 14-[6, 18, 31, 35-36, 40, 44-45, 49, 70, 81, 279, 290  
 opposite orientation (relection, anti-symmetry), 9, 14, 19, 32, 35, 49, 77-80, 290  
 reference levels, 26, 35-36, 40, 49, 67-68, 70, 74-79, 81  
 relativity, *see: relativity - psychological*  
 single-peakedness, *see: single-peakedness*  
 slope equality vs difference, 16, 18-19, 36, 74  
 symmetry, 19, 32, 35, 40, 44-45, 49, 70, 77, 79, 279, 290
- Hedonic sensation, 27, 34-45, 49, 69, 76, 37}  
 value (tone), 4, 14-15, 19, 26-27, 30, 49, 69, 72, 74-75  
 scale typology, 40
- Hedonism, 3-4



- Hyperbolic**  
**additivity**, 188, [92-93, 195,200,243,245,289  
 cosine model, 393-394  
**distance**, see: *distance*  
 geometry, see: *geometry*  
 horocycle (**horosphere**), [13, 120-121  
 involution, see: *involution -space*  
**parallels** (diverging), 113, [20-123, 184, 327  
 tangent  
   **product as single-peaked valence function**,  
   80-82, 186-196,213-219,272.284-286,  
   299-300,387-388,292,397  
   response(ideal axis)function 70-72, 74-77,  
   80, 13\, 137-139, 141, L47-149, 163,  
   [74-176, 179- 182, IID-211, 245-246,  
   248, 272, 279, **286-288**, 292-294, 298,  
   330,336,369,373,377-379
- Ideal axis**, see: *monotone valence*  
*mixed valence*
- Ideal point**, 12-13,27-28,37-40,78-79,8 [-85, 185-  
 198, 204-206, 214-220, 233, 237, 260-261,  
 263-264, 266, 268-269, **276-279**, 283-285,  
 290-291,297-300, 3m-305J71, 386-391,415  
 dynamics, see: *dynamic relativity*
- Indifference**  
**axis**, see: *InDnotone valence*  
 contour, see: *mixed valence*  
   *single-peaked valence*  
 range, see: *conflict - single-peaked valences*
- Intransitivity**, see: *similarity - asymmetric*  
*similarity - symmetric*  
*preference*
- Invariance**  
 dimensional, see: *measurement - invariance*  
 distance, see: *distance*  
 geomtric, 238  
 measurement, see: *measurement*  
 metric, 238  
**reference**, 232-241, 262, 265, 270, 275-278  
 structure, 234-235, 275-276  
 space (**scale**) transfonnation  
   **dilation (central)**, 235-236, 265, 275  
   linear, 51, 61, 65, 115,231-232,250,260-  
   263.271,274,280,286,296-297.329  
   **translation**, 98-99, 235-236, 265, 275  
   **rotation**, see: *rotation invariance*
- Inverse transformation**  
 response, 72, IO!. 127, 144, 146, 148, 152.  
 155-157,162-163.174.180,266  
 ideal response **axis**, 177, 179, **183, 205-209**  
**single-peaked valence**, 101, 188-189,214-220
- Involution space (geometry)**, 137, 148, 15L-152.  
 174,233.272,279,287.289.297  
 Euclidean, 149-153.155 163, 174  
 hyperbolic, 71, 76,137, 149-151, 153, 165.  
 172.174.177.181192.291  
 quasi-elliptic, 146, ISO, 152-151 174
- Iso-distant contour**  
**iso-valent**, **198-199, 204, 206**  
 response, 133-136, 146, 150-151, 161.181  
 r-metric,97-98, **102, 193**, 197-199.205
- Isoroorphism (isomorphic spaces)**, 234-238, 265,  
 275-280,289.291, 299-300, 325  
 asymmetric, **269, 276-278, 282, 284-286, 299**  
 symmetric **269, 276-278, 286**
- Iso-valent contour**  
 mixed valence space  
 representation in:  
   Euclidean Bower space, 201  
   hyperbolic Bower space, 202  
   **quasi-response space**, 202  
   Euclidean stimulus space, 202, 212.  
 roonOlone valence space, 172-174, 177-178.  
 18D-181  
 representation in:  
   Euclidean Bower space, 180-181  
   Euclidean stimulus space, 172, **178-**  
   177.181-183.204  
   hyperbolic Bower space, L8D-181.183  
   open **response space**, 172-173, 177,  
   180-182, 204  
**single-peaked valence space**, 187-188, 193,  
 195-196,199,205,268  
 representation in:  
   Euclidean Bower space, 185, 195,  
   197-199.205-206.215,268  
   Euclidean stimulus space, 199.205-  
   206,215  
   hyperbolic Bower space, (93, 195,  
   197-199,205-206,215,268  
   open quasi-response **space**, 196-197
- Just noticeable sensation**  
 absolute level, 41-42, 5D-52, 61, 120.294  
 differences (jod), 5CI-52, 55-56, 62-63, 99  
**increments**, 5CI-5L 292  
 level (point), 37, 41-43, 80, **56, 61, 64-66.**  
 85,102,115-116,120,122-123,144,  
 151, 183, 186.215,231, 233, 250,  
 259, 261, 263, **276, 281-282, 287,**  
 295, 303-304, 306, 308, 310, 319,  
 324.366,373,375,381, **392, 412-414**

- adaptation-level dependence**, 4142, 50, 56, 6\, 65, 250\ 281, 295, 309  
**coinciding deprivation-level**, 37,66, 83-86, 190. 197.237.261, 303.324.371,4D9  
**space origin**, liS, 151, 186, 197, 215, 259  
**stimulus**  
**threshold**, 50, 56, 59, 61, 64, 66, 83. 246-248,289. 294-296. 306-307  
**absolute**, 50, 59, 61, 295-296
- Learning**,  
**association**, 4, 28-29, 41, 72, 245  
**categorisation**, 338  
**collective**, 424-425,427  
**conditioning**, 28, 412  
**discrimination**, 28-29, 67  
**generalisation**, 42, 67-68. 284  
**mathematical models**, 425, 427  
**reinforcement**, 28-29, 291  
**theory**, [8,28-35.66,80,85, 184-185, 283, 338,427  
**hedonic properties**, 28-35, 72, 78-81, 245
- L...emiscate**,  
*see: monotone valence - space geometry*
- L...ewin's field theory**, 49, 91
- Unlimited/unlimited desire**, 34, 6, 45, 89
- Linear vector model**, 167-169, 187-188, 191
- Logistic probability function**  
*see: cumulative probability function*  
*response-probability function*
- discrimination**, 65-68, 142, [67,330,336-337,
- Matching**,  
**cross-modality**, 22, 53, 55, 65-66,115-116, 118-119,280,425  
**magnitude sensation**, 53-56, 58, 60-62, 66, [14-117, 119, 122, [25-126,240,245, 247.250,262,293,296,303  
**space configuration**, 100, 152-153, 155-156, 160, 166, 405  
**Procrustes procedure**, [53, 157, 159-160, [66.168,2[9,325,342-343
- MDS (Multi-dimensional scaling, non-metric)**, 14, 73,95-96. 131, 135, 153-156, 167-168,263-265,267-269.303,338-339  
**applicability**, 154-156,263-269,326,343  
**artifacts**, 362-370  
**choice models**, *see: similarity-probability model*  
**individual difference**, [31, 133, 154,168,265, 341  
**metric (Euclidean)**, 162-163, 166.339.341-342. 345,348,351.353.356
- probabilistic (stochastic)**, 96, 131, 338, 353, 359-365  
**semi-metric**,  
*see: response - Im/tridimensional analysis*
- Meaningfulness**,  
*see: measurement - invariance - dimensional*
- quantitative relationships**, 227-228, 230-232. 235-237.257,259,285-286  
**impossibility in psychology**, 227-228, 23 [, 239-240,244.249.263-265,269,274  
**possibility in psychology**, 228. 231, 248, 250-251, 259, 263, 266, 269, 274, 284,300
- rotation- and translation-invariance**, 92
- Measurement (fundamental theory)**,  
**bisection**, 254-256.  
**by-product of theory**, 285-290, 296  
**classical scale types**  
**absolute**, 228. 230  
**interval**, 13, 51, 54, 229-232, 235, 249-250,252,254,256  
**log-interval**, 228, 230-231, 239, 252-253, 258,271  
**nominal**, 228-229  
**ordered-metric (hyper-ordinal)**, 13,229, 263  
**ordinal**, 227-228. 236, 266, 268  
**ratio**, 52-53, 57, 65, 149, 227-232, 236, 239,251-258,271,282-283
- conjoint component structures (ordered)**  
**associative**, (additive, multiplicative) 231-232,245-246.251-254,256-258,259, 272,274  
**polynomial additive**, 230. 252  
**non-associative (non-additive, generalised-associative)**, 232. 239-240, 243, 253-257,259,270,285,288-289  
**hyperbolic additive**, 232 243, 245, 288
- equivalence structure**, 227-228, 232, 242-243, 246,248,257,288
- extensive**, 227-228, 230-23\, 239-241, 251, 256,270,288-289  
**derived**, 228, 230-231, 239-240. 251-252  
**inferred**, 228, 242, 244, 246. 249, 257, 282-283,286,375  
**ostensive**, 228, 239-240, 251-252  
**transformed**, 228, 246, 249, 256. 270, 272-273.283,284,291,2%-301. 375
- difference or distance structure**, 230, 239-240, 251-252
- dual-homogeneous**, 273, 281-284, 286, 299-300  
**geometric foundation**, 98, 227, 245, 264-270

- homogeneous,
  - between singular maximum and minimum 271-273,279,282-283,286-289,298
  - between zero and unit points, 274, 279
  - between singular minimum and distinct maximum, 270, 273, 283-284, 298, 299
  - infinite, 255-256, 270-273, 295-297
- invariance, 232, 236, 243-244, 246, 248, 250
  - dimensional, 231, 236-239, 249, 258, 260-261, 263-266, 270, 280
  - comparable sensations, 250, 260-261, 263, 269, 271, 275, 280, 284, 286, 289
- monotone valences, 251, 263, 286
- power-raised fraction scale,
  - physical, 238-239, 249, 258-259, 261-262, 271, 274, 280, 289
  - psychophysical, 262, 269, 275, 280, 286
  - responses, 251, 263, 269, 275, 286, 289
  - single-peaked valences, 251, 263, 269, 275, 284, 286
- non-hologeneous, 271, 273, 286, 296
- scale uniqueness (definition), 229
  - (0,0,1)-, absolute probability, 230
  - (0,1,0)-, fraction scale, 231, 251-252
  - (0,1,1)-, dimensionless power-raised fraction scale, 231, 258, 263, 271, 280
  - (0,1,1)-, random Poisson variable, 230
  - (0,[1,1]-, utility (monotone valence  $r = 1$ ), 246, 283
  - (0,2,0)-, distinctly power-raised stimulus-fraction scale, 231, 257-259, 272, 280, 286, 2%
  - (0,2,0)-, comparable sensation scale, 231, 236, 250, 259, 261-263, 271-272, 275, 280-281, 283-284, 286, 297-297, 300
  - (0,2,1)-, monotone valence scale, 281-283, 289, 298
  - (0,2,1)-, random variable probability, 230
  - (0,2,1)-, response scale, 273, 275, 281-282, 284, 286-287, 296
  - (0,2,2)-, single-peaked valence scale, 273, 275, 283-284, 286, 290, 299-300
  - (0,3,1)-, random variable probability, 230
  - ([,0,0)-, ratio scale, 230, 232, 257-258, 271
  - ([,0,1)-, dimensionless, power-mixed ratio scale, 231, 258, 271, 280
  - (1,0,1)-, log-interval scale, 230-231, 258, 271
  - (1,1,0)-, distinctly power-raised ratio scale, 257, 259
  - (1,1,1)-, inferred-extensive utility, 244, 258, 283
  - (2,0,0)-, interval scale, 230-232, 258, 264, 280
  - (2,1,0)-, dual-bilinear utility, 257, 283
- Minkowski geometry
  - r-metric, 96-98, 102-103, 124-126, 136-138, 167, 192-193, 235, 353
  - related to curvature of non-Euclidean representations, 103-108, 113, 125, 140, 145-146, 158, 179, 213
  - variable (distance-dependent), 197-198, 206
- sensation space, see: *sensation - space - flat*
- Mixed valence
  - additive (rotation-dependent weights), 44, 200, 387-388, 401, 403, 406-407
  - function (asymmetric), 202, 226, 401-407, arctangent-based, 207, 387
  - hyperbolic tangent-based, 207, 387
  - hyperbolically additive, 200, 224
  - ideal axis, 201-202
  - indifference, 202, 401, 407
  - iso-valent contour, see: *iso-valent contour*
  - multidimensional analysis, non-metric, 207
  - semi-metric, 200-201, 207, 220-224
  - open Finsler geometry, related to sensation space, Euclidean, 200-202, 207, 221
  - hyperbolic, 200, 202, 207, 222
  - theory, 200-203, 207, 220-221, 387-386, 405-407, 411
- Monotone valence
  - additive, 175-179, 210, 298, 374-375, 377, 387
  - function derivation, 70-76
  - arctangent, 174, 176, 184, 210, 212, 233, 374-375, 377, 378
  - hyperbolic tangent, 71, 75, 172-174, 176-177, 180, 210-212, 233, 245, 374-375, 377, 387
  - ideal axis
    - response space, 172-179, 181, 183-185, 201, 203, 209-212, 245, 282-283, 377, 387
    - sensation space, 172, 174, 176-177, 180-182, 204, 208-210
    - stimulus space, 177, 182-184, 204, 208-209, 211
  - indifference axis, 173, 179-183, 204, 208

- iso-valent contour, see: *iso-valent contour*  
 measurement. see: *measurement*  
   - *by-product of theory*  
   - *scale uniqueness* - (0,2,1)
- multidimensional analysis,  
   non-metric, see: *linear vector model*  
   semi-metric, 207-213
- space geometry, 101,172-178,213  
   *lemniscate*, 173-174, 177-178  
   *theory*, 7-10,45, 70-76, WI,172-179,184-185,  
   207-209, 387-388  
   see also: *utility* - *axiomatic theory*
- Network (adaptive learning, *neural*), 30-32, 35, 354
- Optimal scaling, see: *scaling*
- Oversaturation, 7, 15-16, 19,26,36-37,77
- Pain, 3-5, 19, 36-37, 39-40, 43, 45, 86, L79, 184
- Perceptual decision  
   independence vs dependence, 368-369  
   separability vs integrality, 363-369
- Pleasantness / unpleasantness, 3-7, 11, 15, 17, 27,  
 32,34,37-44,49,74-75,84-86,90
- Portfolio theory, 386  
   *three-component model*, 386-392
- Power exponent  
   bias (choice probability models,)  
     see: *similarity* - *probability model*  
       *preference* - *probability model*
- conjoint measurement parameter, 239, 254-257
- dimensionless (physical), 230-231, 237, 239,  
 249,258,262,271,274,284-285,296
- dimensional (psychophysical), 52-55, 57, 65,  
 71-72,77,100,102, IW, 116, 151, 163,  
 167,208-209,214-215,231-232,238., 241,  
 247,249-250,252,261-262,267,271\_278,  
 280-281,286,289,291-297,300, 330
- constancy, 66, L17, 122, 246-247, 250, 259-  
 260,262,281. 294-295, 303  
   estimation, 294-296  
   matching, 53-55, 114-117, 119-123, 126  
   rotational, 100, IW, 114-116, 118, 122,  
   124-127,167,231,238,258,262
- relationship  
   *adaptation level*, 56-61, 63-66, 115,  
   120-126,154,233,241,250,259,  
   281, 290-296, 303, 309, 312  
   range, 59-61, 122, 244, 294-295  
   Weber fraction, 62-63, 247, 292
- ideal stimulus space axes, 184, 208
- growth function relation with risk decay, 420,  
 428,436,442
- ratio scale (space), 52, 62,126,230,246,250,  
 253, 258-259, 262, 270, 274, 280  
   see: *measurement* - *scale uniqueness* - (1,0, J),  
       *measurement* - *scale iff/ill/mess* - (J, 1,0),
- stimulus-fraction scale (space),  
   see: *measurement* - *scale uniqueness* - (0,2,0)
- Power law, see: *power exponent* - *dimensional*
- Preference,  
   asymmetric (i-over-j), 372, 379, 388, 393-396  
   asymmetric function, see: *mixed valence*  
   conflict (dilemma), see: *conflict*  
   data (bipolar rank order), 171, 189, 200, 208,  
   211, 216, 218, 221, 224  
   dynamics, see: *dynamic relativity*  
   function, see: *monotone valence* - *function*  
       *single-peaked valence* - *junction*
- formation theory, 7, 12,76-77,376
- intransitivity, 243, 371, 378, 386, 392, 397
- probability model (with bias), 395-397
- symmetric (i-or-j), 379, 388, 395-396
- Principal components (eigen-vectors-values)  
   cosines of distances, 157-159, 162-163  
   *hyperbolic* cosines of distances, 163, 165-166,  
   335,340,342-343,350,396  
   vector cross-product matrix, 160, 163-164,  
   166,209-211, 217, 222-223
- Probability  
   function. see: *cumulative probability junction*  
   subjective, 6, 9, 373-37n
- Procrustes, see: *matching* - *space configuration*
- Projection  
   circular, 172-174, In-178,267  
   inverse radial, 80, 131, 138-139  
   inverse stereographic, 181  
   orthogonal,173-174, 178.180-182.184,201,  
   203-204  
   radial, 135-140, 146, 157, 181  
   space transformation, 77,98,100-102, 131-133,  
   138, 140, 146, ISO, 154-155, 172, 188,  
   196,214,268-269,272, 275, 300, 313,  
   316,321,324,329,333  
   see also: *geometry* - *projective*  
       *involution space*  
   stereographic, 137-141, 147, 162  
   see also: *hyperbolic tangent*
- Prospect theory, 11-12, 241-142, 274, 283, 376-377
- Psychometric response function, 292-293
- Psychophysical function,  
   see: *psychophysics* - *11dimensional*  
       *power exponent* - *dimensional*  
       *Fechner* - *law*

- controversy / consistency of alternatives, 52-55,  
85, 117-118, 126, 238, 247, 281  
measurement, 240, 246-248, 292-293  
scaling, see: *scaling* - *W*lidimensional
- Psychophysics**,  
unidimensional, 49-66, 291-292  
multidimensional, [01-110], 114-127, 231, 238
- Quantity** [8-19, 29-34  
expected, 69-72, 78, 86, 245  
aversion (process) system, 14-16, 19, 32-34
- Pythagorean expression**,  
Euclidean, 97, 102, 109  
Minkowskian, 97, 103  
hyperbolic, 103, 106, 109-111, 118, 243  
elliptic, 103, 107, 145
- Quantity** (subjective volume/area magnitude), 60
- Ratio scale**,  
see: *measurement* - *extensive*  
- *classical scale types*  
- *scale uniqueness* - (1,0,0)
- Reference**,  
invariance, see: *invariance*  
levels, see: *hedonic properties*
- Relativity**  
dynamics, see: *dynamic* - *relativity*  
psychological, 12, 20-23, 26-27, 35, 49, 56-57,  
67-70, 72, 74, 135, 234, 300, 303-393  
physical, 96, 99, 108, 227, 229, 238-239, 243,  
249, 257, 270, 274, 280, 288-289
- Response**  
anticipatory, 29-30, 32, 49, 69, 79  
dissimilarity, see: *similarity*  
function, 67-76, 80, 140-145, 288, 342  
see also: *arctangent*  
*hyperbolic tangent*  
**uniqueness**, 101, 131, 142, 145, 279, 282  
iso-distant contour:  
see: *iso-distant* - *response contour*  
measurement,  
see: *measurement* - *scale uniqueness* - (0,2,1)  
multidimensional analysis  
data specification, 167-168  
non-metric, see: *MDS*  
semi-metric (of response spaces)  
open-Euclidean  $\leftrightarrow$  common Euclidean  
stimulus space, 156, 162-165  
open-hyperbolic  $\leftrightarrow$  common Euclidean  
sensation space, 161, 163, 165-166  
single-elliptic  $\leftrightarrow$  common Euclidean  
sensation space, 156-162
- probability function, 61-62, 74, 131-134, 279  
see: *cumulative probability function*  
- *Cauchy*  
- *logistic*
- preferential, see: *monotone valence*
- theory**  
multidimensional, 131-152, 267, 281-282,  
286-288  
unidimensional, 66-73, 136-139
- similarity, see: *similarity*
- space **geometry** (open alternatives), 95, 140,  
154-156, 174, 179, 267-270, 272, 282-283,  
285, 287, 298, 326, 371  
open-Euclidean, related to:  
monotone valence space, 172-173,  
176-178, 181, 298  
hyperbolic sensation space, 140, 149-  
150, 276, 280, 286, 288, 298,  
313, 321, 333, 339, 361, 368  
Euclidean stimulus space, 133-134,  
149-151, 155, 167, 277, 280, 298,  
343, 368  
open-hyperbolic, related to:  
monotone valence space, 174, 176,  
178-181, 245, 298  
Euclidean sensation space, 134, 149-  
150, 152, 161-162, 166-167, 179-  
181, 265, 277, 287, 298, 321,  
339, 348, 355, 368-369  
hyperbolic stimulus space, 149-152,  
287, 298  
single-elliptic, related to:  
monotone valence space, 171, 174-  
178, 181, 282-283, 298  
Euclidean sensation space, 137-138,  
140, 142, 144-147, ISO, 152-153,  
158-162, 268, 272, 286-287, 297,  
322, 340-341, 348, 356, 369  
double-elliptic stimulus space, 137,  
146, 150-152, 287, 297, 353
- Reward**, 28-29,  
expectancy, 32, 34, 49, 67-70, 72, 81, 244-245  
process/system, 14-16, 32-34, 78-79
- Risk-adaptation theory**,  
see: *road traffic* - *risk* - *adaptation theory*
- Risk-homeostasis theory**,  
see: *road traffic* - *risk* - *homeostasis theory*
- Risk preference**  
gamble risk (single-peaked), 371, 386-392  
road traffic risk (single-peaked or mixed), 407-  
408, 411-414

- Road traffic,  
 growth,  
 adaptive evolution aspects, 418, 424  
 limited (non-exponential), 419-420, 423  
 S-shaped function of time, 419-424,  
 Gompertz, 421-422, 428  
 USA, 423-424, 433-434  
 The Netherlands, 434-435  
 risk (individual), 407-408, 411-415  
 adaptation theory, 411-415  
 compensation, 412-414, 417-418  
 indifference-range shifts, 414-415  
 homeostasis theory, 412-413  
 threat-avoidance theory, 413-414  
 zero-risk theory, 408, 412  
 risk (collective)  
 time-dependent decay, 427-428, 436-437  
 exponential decay, 415-416  
 fatality risk, 390, 395-396  
 relationships with  
 mathematical learning models, 425,  
 427-428  
 risk-adaptation theory, 415-416, 418-  
 419, 430-431, 437  
 traffic growth, 416, 425-428  
 Rotation invariance, 98, 101-102, 106-107, 110,  
 114-116, 118, 124-127, 172, 175, 234, 236-  
 237, 258, 262-263, 275  
 conditional, 98, 187, 191, 196, 299-300  
 Satiation, 6-7, 16-18, 51, 77-78, 413  
 Saturation level, 26-28, 32, 35-45, 49, 74-91, 179,  
 185-186, 189, 195, 202, 215, 233, 293, 299,  
 309, 324, 412-413  
 reflected deprivation level, see: *deprivation*  
 Scaling  
 multidimensional see: *MDS*  
*Illjofding*  
 optimal (alternated data scaling and analysis),  
 155-156, 160-161, 165-166, 168, 171,  
 188-189, 191, 205, 207, 209-210, 212-215,  
 218-221, 224, 335, 358  
 Wldimensional magnimdes  
 direct or fractionation, 53-55, 60-62, 65-  
 66, 115, 117, 119, 122, 262  
 mean category, 52-55, 57-58, 292-293  
 response, 292-295  
 Sensation.  
 comparable  
 intensity, 58-66, 81, 102, 263, 291-293,  
 296-298, 312-321, 323-325, 330-331,  
 355, 366, 370  
 valence, 81, 185, 200, 215-220, 235, 260-  
 263, 283, 290, 297, 299-300, 324-325,  
 371, 386-387, 393-396  
 equivalence with intensity-comparable,  
 81, 186, 190, 197, 261  
 measurement, see: *measurement - scale*  
*Illjofding - (0,2,0)*  
 just noticeable, see: *just noticeable*  
 relativity, see: *relativity - psychological*  
 scale invariance, 61, 64-65, 115, 321, 236, 250,  
 260, 263, 271, 274, 280, 284.  
 see: *invariance - transformation - linear*  
*measurement - invariance*  
 space geometry  
 flat (Euclidean/Minkowskian), related to:  
 monotone valence space, 174, 176-  
 182, 184, 245-246  
 response space, 138, 140-146, [48-  
 150-153, 157-162, 165-166, 181,  
 265, 277, 287, 297-298, 321, 330,  
 347-349, 351-353, 355-356, 369  
 single-peaked valence space, 187-188,  
 190-191, 195-196, 199, 201, 216-  
 218, 284, 299, 273, 393, 396-397  
 stimulus space, %, 100-108, 113, 149-  
 151, 165, 191, 277, 287, 290,  
 297-299, 330-331, 343, 393  
 hyperbolic, related to:  
 monotone valence space, 174, 177,  
 180-181, 245-246  
 response space, 138, 140, 149-150, 152,  
 155, 161, 163-165, 181, 245, 276-  
 277, 280, 282, 286-288, 279-298,  
 333-335, 343, 349-351, 353, 356,  
 368-369  
 single-peaked valence space, 186,  
 188, 188, 191-193, 195-196, 198-  
 199, 218-220, 284, 287, 393, 395  
 stimulus space, 108-110, 112, 114,  
 116-122, 147, 149-152, 155, 163-  
 165, 191, 199, 218-220, 223, 239,  
 276-277, 280, 282, 290, 297, 299,  
 313, 321, 326-329, 333-335, 339,  
 343, 353, 355, 361, 368  
 Signal (neural)  
 facilitation/inhibition, 24-25, 29-32, 291  
 transduction (transmission), 25, 29-34, 81, 291  
 Similarity (dissimilarity, confusion)  
 asymmetric and intransitive [(i-to-j), target-  
 biased] 308, 314, 319, 337-339, 343-355,  
 357-358, 365-367

- dynamics, see: *dynamic relativity* - (dis)similarity
- magnitude**, 332, 334-336, 338-340, 344-350, 352-353, 356, 394
- multidimensional analysis  
*see: MDS*  
*response - multidimensional analyses*  
*similarity - probability nux/el*
- model**,  
deterministic vs stochastic, 357-359  
distance- and density-dependent, 347, 368-370  
**feature-contrast**, 347, 354-355, 365, 368, 370  
general context" 339, 347, 366, 368  
general recognition, 132, 364-365  
*see also: MDS - probabilistic*  
hybrid spatial and hierarchical, 347, 368, 370
- probability model (biased, MDS-based)  
**additive**, 341-342  
multiplicative bias, 345-346, 349, 352-353  
multiplicative dual bias, 356  
**arctangent-based**, 332, 351-352  
multiplicative bias, 349, 352-353  
multiplicative dual bias, 356  
exponentially additive, 339-340, 342-343  
multiplicative bias, 345-346  
power-raised bias, 350, 353, 368  
power-raised dual bias, 356  
exponentially multiplicative, 309  
multiplicative bias, 314-315, 321  
power-raised bias, 317, 320-322  
power-raised dual bias, 324  
hyperbolically multiplicative, 340, 343  
multiplicative bias, 345-346, 352  
**multiplicative compound bias**, 350, 353, 368  
multiplicative compound dual-bias, 356  
symmetric (between i and j),  
transitive distance representation, 74, 96, 98, 113, 131-133, 135, 152, [54-[68, 235, 251, 264, 267, 273, 279, 285-287, 317, 332, 338, 389  
intransitive, 267, 308, 317, 321-322, 339, 343, 356-358, 364-366, 370
- relativity**, see: *dynamic relativity* - (dis)similarity
- Single-peakedness,  
foundation properties  
adaptation-level theory, 20-28  
aspiration theory, 7-11  
arousal potential theory, 14- [6  
unfolding theory, 16-19  
learning theory, 28-35  
integrated foundation, 28, 35-36, 38-45, 70-85
- Single-peaked valence  
**dynamics**, see: *dynamic relativity* - preference function.  
asymmetric, see: *mixed valence*  
arctangent-based, [86-186, 189-[91, 194-195, 290  
**hyperbolic tangent-based**, 78-85, 186-196, 272, 290  
indifference contour, 191, 196, 198, 205, 284  
iso-valent contour, see: *iso-valent contour*  
measurement,  
*see: measurement - scale uniqueness* - (0,2,2)
- multidimensional analysis,  
non-metric, see: *unfolding*  
semi-metric,  
open Finsler spaces  $\leftrightarrow$  common  
Euclidean sensation space, 213-2 [8  
open-hyperbolic spaces  $\leftrightarrow$  common  
Euclidean stimulus space, 214, 218-220
- product of quasi-response spaces, 186-187, 190, 195-197, 273, 283, 290
- space geometry,  
open-hyperbolic, related to:  
sensation space, 101, 186, 188, [91-193, 195-[%, [99, 214, 240, 278, 284, 290, 299  
stimulus space, 199, 214, 218-220, 290, 299  
open Finsler, related to:  
sensation space, 101, 186-189, 190-197, 205, 214-218, 284, 290, 299-300  
stimulus space, 196, 290, 299-300
- theory**  
**unidimensional**, see: *single-peakedness*  
**multidimensional**, 185-199
- Singular value decomposition, 209, 213
- Stevens(')  
**magnitude scaling**:  
*see: scaling - unidimensional magnitudes*  
*- direct or fractionation*  
*subjective - stimulus magnitudes*
- power function,  
*see: power exponent - dimensional*  
*psychophysics - unidimensional*  
space, 115, 120, [22  
*see also: psychophysics - multidimensional*

- Stimulus
- fraction scale,
    - see: *measurement - scale uniqueness (0,1,0)*
  - ratio-scale, see: *ratio scale*
  - subjective magnitude, see: *subjective*
  - space geometry
    - double-elliptic, related to:
      - response space, 137, 146, 150-152, 248, 272, 287, 297, 299, 353
      - sensation space, 103, 108, 124-126, 137, 141, 145-146, 150, 153, 187, 190, 331, 333, 340, 393
      - single-peaked valence space, 187, 190, 1%, 207, 290, 299, 393
    - Euclidean, related to:
      - monotone valence space, 176-177, 182-184, 204, 208-212.
      - response space, 133, 138, 148-151, 153, 155, [62-167, 176, 245, 248, 272, 277, 280, 287, 298, 32&329, 334-335, 343, 349-350, 364
      - sensation space, [08-[20, 127, 133, 137, 141, 147, [49-153, 191, 203-207, 211, 214, 238, 245, 268, 280-287, 290, 297-299, 343, 349-350, 369, 392-393, 395
      - single-peaked valence space, 188- [89, 192-[93, 1%, 199, 205, 2Cfl, 214-215, 218-219, 290, 299-300, 393, 395
    - hyperbolic, related to:
      - responsespace, 138, 149-150, 163, [65-167, 277, 287-288, 298, 330-331
      - sensation space, 102-105, 112, 124-125, 138, 149-150, 214, 277, 287-288, 298, 330-331, 393
      - single-peaked valence space, [86-187, 189-[91, 1%, 2Cfl, 210, 214, 21&218, 298, 300, 393
    - non-Euclidean, 96, 100-103, 108, 116-117, 124-126, 137, [42, 151-152, [87, [97, 230, 238, 281, 290, 297, 3%
  - Subjective
    - expected utility, see: *utility - subjective expected*
    - probability, see: *probability*
    - stimulus magnitude, 52-63, 72, 100, 1[3-117, 122-126, 233, 238, 24-241, 24&248, 250, 258, 262, 284, 286, 291, 293-296, 330
  - Threat avoidance theory, see: *road traffic - risk*
  - Traffic growth, see: *road traffic - growth*
  - Transitivity violations
    - see: *similarity - asymmetric - intransitive*  
*similarity - symmetric - intransitive*  
*preference - intransitive*
  - Underdeprivation, 27, 36-37, 77, 83, 85
  - Unfolding analysis.
    - unidimensional, 12-13, 266, 397
    - multidimensional
      - non-metric, ,13-14, 74, 95, 204-207, 214-215, 221, 224, 249, 264, 266, 268-269, 397
      - individual difference, 194, 205-206, 278
      - probabilistic (stochastic), 205, 397
      - semi-metric, see: *single-peaked valence - multidimensional analysis*
  - Uniqueness
    - metric / geometric, 238, 263, 269-270, 284
    - response function alternatives, 279
    - scale, see: *measurement - scale uniqueness*
  - Utility,
    - asymmetry of losses and gains, 12, 70, 241, 245, 283, 293
    - axiomatic theory, 228, 241, 256-257, 283
    - rank- and sign-dependent, 70, 241-244, 257-258, 283
    - expected, 6-11, 23, 372-374
    - dynamics, 7-9, 12, 76, 371-379, 381-389
    - monotone function, 6-7, 67, 69, 72, 77, 243-244
    - multi-attribute theory, 12, 14, 82
    - subjective expected 6, 9-11, 376
      - additive (conjoint measurement), 376
      - additive difference model, 378-379
      - psychophysical response theory, 244-246, 248, 377-381, 387-388
  - Valence. see: *mixed valence*  
*monotone valence*  
*single-peaked valence*
  - Visual vs optic-Euclidean space, 326-329
  - Weber('s)
    - fraction (modified), 50-51, 55, 62-63, 247, 292, 308-309, 311
    - law, 50
  - Zero-risk theory, see: *road traffic - n'sk*





Matthijs J. Koomstra (1941) graduated in psychology at Leiden University, where he worked from 1961 to 1986. The first five years as research-assistant and the next five years as researcher at the Computer Centre and the Psychological Institute, subsequently from 1971 to 1978 as senior researcher at the Department of Data Theory in the Faculty of Social and Behavioural Sciences, and from 1978 to 1986 as (crown-appointed) vice-president of Leiden University. In 1986 he was appointed as director of SWOV (*Research Institute for Road Safety, The Netherlands*) and after 1999 as director of SARA (*National Centre for Advanced Supercomputing and Networking, Amsterdam*). Meanwhile he lectured road safety for 10 years at Delft University of Technology and was or is president or member of governing boards for scientific foundations, academic visiting committees, and (inter)national scientific councils. Since 2002 he works as independent research advisor for international organisations (ED, ETSC, OEeD, ECMT, WB, WHO, and WBCSD). He obtained his PhD at Leiden University and is co-author or co-editor of several books or congress proceedings on road safety as well as author or co-author of more than 120 scientific articles or reports on data analysis methods, road safety, and diverse domains in applied and theoretical psychology.

e-mail: [matthijs.koomstra@insightconsult.nl](mailto:matthijs.koomstra@insightconsult.nl)

