



CLAUDIO borri
MICHELE betti
ENZO marino

LECTURES ON SOLID MECHANICS



MANUALI
SCIENZE TECNOLOGICHE

- 4 -

CLAUDIO BORRI
MICHELE BETTI, ENZO MARINO

Lectures on solid mechanics

Firenze University Press
2008

Lectures on solid mechanics / Claudio Borri, Michele Betti, Enzo Marino. – Firenze : Firenze university press, 2008.
(Manuali Scienze Tecnologiche ; 4)

<http://digital.casalini.it/9788884538543>

ISBN 978-88-8453-854-3 (online)
ISBN 978-88-8453-853-6 (print)

This publication has been supported by the DEREK Tempus Project with the contribution of the European Commission Directorate General for Education and Culture and by Ente Cassa di Risparmio di Firenze.



ENTE
CASSA DI RISPARMIO
DI FIRENZE

Progetto grafico di Alberto Pizarro Fernández

© 2008 Firenze University Press
Università degli Studi di Firenze
Firenze University Press
Borgo Albizi, 28
50122 Firenze, Italy
<http://www.fupress.com/>

Printed in Italy

Contents

List of Figures	IX
Foreword	XIII
Part I	
Theory of elasticity	1
Chapter 1 – Outline of linear algebra	3
1.1 Vector spaces and linear mappings	3
1.1.1 Vector spaces	3
1.1.2 Linear mappings	4
1.2 Euclidean spaces	8
1.2.1 Euclidean metric tensor and scalar product	9
1.2.2 Eigenvalues and eigenvectors	10
1.3 Tensors	11
1.3.1 Tensors and linear mappings	11
1.4 Coordinate systems	13
1.4.1 Linear mappings and the metric tensor	14
1.4.2 Linear mappings and the metric tensor	15
1.4.3 Examples of coordinate systems	17
1.4.4 Volumes and the vector product	21
1.5 Covariant differentiation	24
1.5.1 Grad, div, curl and Laplace's operator	25
1.6 Affine space	29
1.6.1 Free and applied vectors	29
1.7 Surfaces	32
Chapter 2 – Analysis of strain	37
2.1 Introduction	37
2.2 Deformation	38
2.3 Strain tensor in general coordinates	38
2.3.1 Examples of strain in Cartesian coordinates	44
2.3.2 Infinitesimal deformations	48
2.3.3 Deformation and rigid body motion	49
2.4 Shell continuum	51

2.4.1	General assumptions	51
2.4.2	Strain tensor	52
Chapter 3 – Analysis of stress		57
3.1	Body and surface forces	57
3.2	State of stress	58
3.2.1	Stress vector components	61
3.2.2	Stress tensor	61
3.3	Equations of equilibrium	64
3.3.1	Translational equilibrium	64
3.3.2	Rotational equilibrium	65
3.4	Principal stresses and principal directions	67
3.4.1	Normal and tangential components of the stress vector	69
3.4.2	Mohr's circles	70
3.5	Stress quadric of Cauchy	77
3.6	Stress-deviator and spherical components of the stress tensor	78
3.7	Stress in shell continuums	79
3.7.1	Shifters	79
3.7.2	Contraction of surface forces	80
3.7.3	Body forces and load density	84
3.7.4	Eulero's equations	85
3.7.5	Membrane state of stress	88
Chapter 4 – Equations of elasticity		89
4.1	The material law	89
4.1.1	Generalized Hooke's law	90
4.2	The linear elastic problem	95
4.2.1	Boundary value problem in terms of stresses	96
4.2.2	Boundary value problem in terms of displacements	98
4.3	Constitutive equation for shell continuums	100
Chapter 5 – Principle of Virtual Work		103
5.1	Virtual work	103
5.1.1	A simple example	107
5.2	PVW, Compatibility conditions, Equilibrium	109
Chapter 6 – Energy principles and variational methods		111
6.1	The strain-energy function and Hooke's law	111
6.1.1	Superposition principle	116
6.1.2	Uniqueness of the solution	117
6.1.3	Theorem of reciprocity	119

6.2 Variational methods	120
6.2.1 Potential energy	120
6.2.2 Complementary energy	122
6.2.3 Theorems of Castigliano	124
Chapter 7 – Strength of materials	129
7.1 Introduction	129
7.2 Maximum stress theory	130
7.3 Maximum strain theory	131
7.4 Beltrami’s theory	132
7.5 Von Mises’ criterion	132
7.6 Criteria comparison	134
7.6.1 Maximum stress	134
7.6.2 Maximum strain	135
7.6.3 Beltrami’s criterion	136
7.6.4 Von Mises’ criterion	137
7.6.5 Comparison	138
Part II. Theory of elastic beams	141
Chapter 8 – Saint-Venant’s problem	143
8.1 Statement of the problem	143
8.1.1 External and internal forces	148
8.2 Four fundamental cases	153
8.3 Beam under axial force	154
8.3.1 State of stress	154
8.3.2 State of strain	155
8.3.3 Displacement field	155
8.3.4 Strain energy	157
8.4 Beam under terminal couples	158
8.4.1 Introductory sketch	158
8.4.2 State of stress	159
8.4.3 State of strain	162
8.4.4 Displacement field	164
8.4.5 Strain energy	167
8.5 Beam under torsional couples	169
8.5.1 Circular bar	169
8.5.2 Cylindrical bar	172
8.5.3 State of strain	176
8.5.4 Displacement field	176
8.5.5 Strain energy	178
8.5.6 Torsion of tubular beams: Bredt’s theory	181
8.6 Bending and shear	184

8.6.1	External forces	184
8.6.2	State of normal stress	185
8.6.3	State of tangential stress: Jourawski's theory	187
8.6.4	Tangential stress for symmetrical cross-sections	189
8.6.5	State of strain	193
8.6.6	Total strain energy	197
8.6.7	Rectangular cross-section	198
Part III. Appendix		201
A – Applications of the shell theory		203
A.1	Spherical dome	203
A.1.1	Geometry	203
A.1.2	Displacements and strains	204
A.1.3	Equilibrium and constitutive law	205
A.2	Cylindrical shell	208
A.2.1	Geometry	208
A.2.2	Displacements and strains	209
A.2.3	Equilibrium and constitutive law	209
A.3	Hyperboloid of one sheet	211
A.3.1	Geometry	211
A.3.2	Equilibrium	215

List of figures

1.1	Contravariant and covariant bases related to a 2D curvilinear coordinate system	14
1.2	Cylindrical coordinate system	18
1.3	Spherical coordinate system	20
1.4	Addition of two applied vectors	30
1.5	Subtraction of two applied vectors	31
1.6	Vector product for Cartesian applied vectors	32
2.1	Unstrained and strained body states	40
2.2	Measure of strain	42
2.3	Angular dilatation	45
2.4	Area dilatation	46
2.5	Two dimensional sketch of the displacement field for Kirchho-Love shells	53
3.1	Body and surface forces	58
3.2	Body \mathcal{V} being in an equilibrium state	59
3.3	Splitting of the continuous media \mathcal{V}	60
3.4	Stress vectors: the sketch of <i>Cauchy's</i> theorem	62
3.5	Stress tensor components	63
3.6	Stress tensor components acting on an infinitesimal volume element	64
3.7	Plane (y, z) . Components of the stress tensor acting on the volume element	66
3.8	Normal and tangential components of the stress vector	69
3.9	Normal and tangential components of the stress vector in two dimensions	71
3.10	Normal and tangential components of the stress vector for in two dimensions	73
3.11	Graphical determination of principal directions	74
3.12	Mohr's circles	76
3.13	Stress quadratic of Cauchy	77
3.14	Local bases in $G(\epsilon)$ and in Q	81

4.1	Hooke's law	90
5.1	Forces and constraints acting on the continuous	103
5.2	Elemental volume element	106
5.3	Virtual deformation	106
5.4	Example	108
6.1	Density of strain energy in the case of axial state of stress	114
6.2	The simplest application of Clapeyron's theorem	115
6.3	Forces and displacements acting on the body \mathcal{V} lying in the equilibrium state	121
6.4	Concentrated loads acting on the body \mathcal{V}	125
6.5	Example of Castigliano's theorems	127
7.1	Rupture domain for the maximum stress criterion	135
7.2	Rupture domain for the maximum strain criterion	136
7.3	Elastic domain for Beltrami's criterion	137
7.4	Elastic domain for the Mises' criterion	138
8.1	Prototype of beam	145
8.2	Unit normal vectors on the bases of the cylinder	147
8.3	Equilibrated components of force and couple resultants acting on the ends of the beam	150
8.4	Strained state of a beam subjected to an axial force	157
8.5	Strained state of a beam subjected to an axial force: radial contraction	158
8.6	Beam under terminal couples	158
8.7	Projection of the couples and rotation axis	161
8.8	Neutral axis and flexural axis	163
8.9	Circular bar under torsional couples	169
8.10	Rotation of a point p lying on a generic cross section of the circular beam	170
8.11	The sub-domain A_c bounded by the curve c	181
8.12	Stress flux within a small region included by two closed curves and two generic transversal sections	182
8.13	Stress resultants	183
8.14	Shear regions	187
8.15	Beam splitting	188
8.16	Symmetrical cross section	190
8.17	Maximum shear stress for symmetrical cross section	191
8.18	σ_{3x} distribution for symmetrical cross sections	193
8.19	Bending strain for an infinitesimal beam segment	194
8.20	Shear strain for an infinitesimal beam segment	195

8.21 Two contributions to the state of strain for a beam subjected to terminal forces	197
A.1 Hyperbolic coordinate system	212

Foreword

These Lecture Notes introduce the theoretical basics of solid mechanics to environmental engineering students. Born out of and supported by the European Project DEREK TEMPUS JEP Development of Environmental and Resources Engineering Curriculum, it collects the lectures held by the Authors during the course of Mechanic of Solids at the University of Florence, Degree of Environmental Engineering and Resources. Although the course is extended to basic structural engineering principles, such as mechanics, statics, kinematics and fundamental equations of beam structures, inertia, iso static and hyper static solution methods, these Lecture Notes reflect only the content of the lectures of continuum mechanics.

Several approaches are possible to the subject depending on the concern, either mathematically or physically oriented. The volume aims to provide a synthesis of both approaches, presenting in an organic whole the classical theory of solid mechanics and a more direct engineering approach. It is the Authors' opinion that a top-down learning process may offer to the engineering students those critical and autonomy tools necessary to gain awareness of that continuous learning process that is required; it characterizes the cultural and technical personality of an engineer. An ongoing learning is all the more necessary today, where the rapid development of powerful computers and computer solving methods (finite element methods, discrete volume methods, boundary methods, etc.) have opened up the way to new horizons that the classical approaches were only able to formulate. This fast and impressive growth of computer methods seems to be replacing the importance of gaining a consolidated knowledge of solid mechanics background. On the contrary, the Authors believe that only a conscious knowledge of theory can be that cultural instrument through which an engineer can really hope to control the use of computer methods. With this aim, the Reader addressed by this volume is mainly the undergraduate student in Engineering Schools: it is organized in eight Chapters: Chapter 1 proposes a synthesis of the basic concepts of mathematics and geometry that the readers need in the following chapters. Chapter 2 and Chapter 3 are devoted to the elementary framework of strain and stress in an elastic body. The concept of finite strain and Cauchy stress state is introduced, together with Mohr's representation of a general state of stress. Chapter 4 focuses on the classical law of linear elasticity. Chapter 5 deals with the Principle of Virtual Works. Chapter 6 treats the energy principles and provides a basic introduction to the variational methods.

Finally, Part I ends with a chapter introducing the notion of strength of materials. At the end of each chapter of the first part the basics of the tensor-based shell theory are also presented and then an application to some standard shell geometries is provided in appendix A.

The second part, Chapter 8, is dedicated to De Saint-Venant's problem where the classical beam theory is presented focusing on the four fundamental cases: beam under axial forces, terminal couples, torsion, bending and shear.

The volume, that consolidates the Lecture Notes prepared by the Authors for the second-year undergraduate students in environmental engineering, proposes a widening of the classical theories approached, giving a list of references used during its preparation as a possible suggestion to the Reader.

The Authors wish to express their heartfelt gratitude to professor Marco Modugno for the inspiring discussions and stimulating suggestions.

It is also our pleasure to thank Eng. Seymour Milton John Spence for kindly revising the English text.

The publication of this book has been possible thanks to the financial support of the European Commission (DEREC Tempus Project) and Ente Cassa di Risparmio di Firenze to whom the Authors are extremely grateful.

CLAUDIO BORRI, MICHELE BETTI, ENZO MARINO

PART I
Theory of elasticity

Chapter 1

Outline of linear algebra

This chapter briefly presents some preliminary mathematics necessary to understand continuum mechanics. To this end the basic concepts of linear algebra and tensor analysis will be introduced. At the end of the chapter an overview of the theory of surfaces will be exposed in order to make the reader familiar with some background required for the mechanics of shell continuums, even though the latter is not the key theme of this book.

This introduction is neither exhaustive nor complete; indeed for any further insight the reader is warmly recommended to refer to the main sources from which this summary has been derived: Modugno, [4] and [5]; Sokolnikoff, [1]; Green-Zerna, [3].

1.1 Vector spaces and linear mappings

1.1.1 Vector spaces

We define *vector space* a set \bar{V} equipped with the following operations

$$+ : \bar{V} \times \bar{V} : (\bar{u}, \bar{v}) \mapsto \bar{u} + \bar{v} \quad (1.1)$$

$$\cdot : \mathbb{R} \times \bar{V} : (\lambda, \bar{v}) \mapsto \lambda \bar{v}. \quad (1.2)$$

Elements belonging to \bar{V} are named *vectors* and are characterized by the following properties

1. $\bar{u} + (\bar{v} + \bar{w}) = (\bar{u} + \bar{v}) + \bar{w} \quad \forall \bar{u}, \bar{v}, \bar{w} \in \bar{V}$
2. $\bar{u} + \bar{v} = \bar{v} + \bar{u} \quad \forall \bar{u}, \bar{v} \in \bar{V}$
3. $\bar{u} + \bar{0} = \bar{u} \quad \forall \bar{u} \in \bar{V}$
4. $\forall \bar{u} \in \bar{V} \exists = -\bar{u} \in \bar{V}$ so that $\bar{u} + (-\bar{u}) = \bar{0}$

where $\bar{0}$ is called null vector.

Every vector space admits the existence of a subset

$$\mathcal{B} = \{\bar{b}_1, \dots, \bar{b}_n\} \subset \bar{V}$$

called the *basis* of \bar{V} . Thus, each vector $\bar{v} \in \bar{V}$ can be univocally represented through the basis \mathcal{B} as follows

$$\bar{v} = v^i \bar{b}_i \quad i = 1, \dots, n \quad (1.3)$$

where $v^i \in \mathbb{R}$ are the components of \bar{v} related to the basis \mathcal{B} and n is a number which defines the dimension of \bar{V} , namely the number of vectors in any basis of \bar{V} .

Notice that in equation (1.3) the Einstein's summation convention has been used. It is a notational convenience where any term in which an index appears twice will stand for the sum of all such terms as the index assumes all of a preassigned range of values, hence

$$\bar{v} = v^i \bar{b}_i = \sum_{i=1}^n v^i \bar{b}_i \quad (1.4)$$

1.1.2 Linear mappings

Functions between two vector spaces assume a crucial importance in linear algebra. In particular, we define a linear map as a linear transformation between two vector spaces that preserves the operations of vector addition and scalar multiplication.

Let \bar{V} and \bar{V}' be two vector spaces equipped with the bases

$$\mathcal{B} = \{\bar{b}_1, \dots, \bar{b}_n\}, \quad \mathcal{B}' = \{\bar{b}'_1, \dots, \bar{b}'_m\}$$

respectively.

We define a *linear mapping* as the transformation

$$f: \bar{V} \rightarrow \bar{V}', \quad \bar{v} \mapsto \bar{v}' \quad (1.5)$$

if the two following conditions are satisfied

1. $f(\bar{u} + \bar{v}) = f(\bar{u}) + f(\bar{v}) \quad \forall \bar{u}, \bar{v} \in \bar{V}$: additivity;
2. $f(\lambda \bar{u}) = \lambda f(\bar{u}) \quad \forall \bar{u} \in \bar{V} \text{ e } \lambda \in \mathbb{R}$: homogeneity.

The set of all linear maps from \bar{V} to \bar{V}' , denoted by $L(\bar{V}, \bar{V}')$, represents a $n \times m$ -dimensional vector space, where n and m are the dimensions of \bar{V} and \bar{V}' , respectively.

$$\{f : \bar{V} \rightarrow \bar{V}'\} =: L(\bar{V}, \bar{V}') \quad (1.6)$$

For linear mappings the following properties hold

1. $(f + g)(\bar{u}) = f(\bar{u}) + g(\bar{u}), \quad \forall f, g \in L(\bar{V}, \bar{V}'); \bar{u} \in \bar{V}$
2. $(\lambda f)(\bar{u}) = \lambda f(\bar{u}), \quad \forall f \in L(\bar{V}, \bar{V}'); \bar{u} \in \bar{V}$

Matrix representation

Notions so far introduced allow us to assert that if f is a linear mapping from \bar{V} to \bar{V}' , then $f(\bar{v})$ is a vector in \bar{V}' . Consequently, by recalling the expression in components for \bar{v} , (1.3), we have

$$f(\bar{v}) = f(\bar{v})^i \bar{b}'_i \quad i = 1, \dots, m \quad (1.7)$$

and accounting for the fact that $\bar{v} = v^j \bar{b}_j$, with $j = 1, \dots, n$, and by using the homogeneity property for linear mappings, the latter equation leads to

$$f(v^j \bar{b}_j)^i \bar{b}'_i = v^j f(\bar{b}_j)^i \bar{b}'_i \quad j = 1, \dots, n \quad i = 1, \dots, m. \quad (1.8)$$

In a shorter form the components of $f(\bar{v})$ are then

$$(f(\bar{v}))^i = f_j^i v^j \quad (1.9)$$

so that the $m \times n$ -dimensional matrix $f_j^i = f(\bar{b}_j)^i$ is the matrix representation of the linear mapping f referred to the bases \mathcal{B} e \mathcal{B}' .

Linear forms and the dual space

Linear forms are a special case of linear mappings. Let \bar{V} be a vector space and $\mathcal{B} = \{\bar{b}_i\}$ its basis. A *linear form* ω is a linear transformation from \bar{V} to a scalar field

$$\omega : \bar{V} \rightarrow \mathbb{R} \quad (1.10)$$

Hence, we define \bar{V}^* as the set of linear forms from \bar{V} to \mathbb{R}

$$\bar{V}^* =: \{\omega : \bar{V} \rightarrow \mathbb{R}\} =: L(\bar{V}, \mathbb{R}) \quad (1.11)$$

\bar{V}^* and \bar{V} have the same dimension.

The dual space \bar{V}^* admits a basis $\mathcal{B}^* = \{\underline{\beta}^i\}$ whose elements are linear forms operating as follows

$$\underline{\beta}^i(\bar{b}_j) = \delta_j^i = \begin{cases} 1 & i = j \\ 0 & i \neq j \end{cases} \quad (1.12)$$

By the definition, we can state that the element $\underline{\beta}^i$ belonging to \mathcal{B}^* , applied to the vector \bar{u} , yields a scalar that is the i -th component of \bar{u} . In fact we write

$$\underline{\beta}^i(\bar{u}) = \underline{\beta}^i(u^j \bar{b}_j) = u^j \underline{\beta}^i(\bar{b}_j) = u^j \delta_j^i = u^i \quad (1.13)$$

We highlight that, as done for vectors, each linear form, chosen the n -dimensional basis \mathcal{B}^* , can be written in components as follows

$$\omega = \omega_j \underline{\beta}^j \quad j = 1, \dots, n \quad (1.14)$$

Bilinear forms

We can define a *bilinear form* \underline{f} as a mapping

$$\underline{f} : \bar{V} \times \bar{V} \rightarrow \mathbb{R}, \quad (\bar{v}, \bar{v}') \mapsto \lambda \quad (1.15)$$

where $\bar{v}, \bar{v}' \in \bar{V}$ and $\lambda \in \mathbb{R}$, and such that it is linear in each argument separately. That is

1. $\underline{f}(\bar{v} + \bar{w}, \bar{v}') = \underline{f}(\bar{v}, \bar{v}') + \underline{f}(\bar{w}, \bar{v}')$;
2. $\underline{f}(\bar{v}, \bar{v}' + \bar{w}) = \underline{f}(\bar{v}, \bar{v}') + \underline{f}(\bar{v}', \bar{w})$;
3. $\underline{f}(\lambda \bar{v}, \bar{v}') = \underline{f}(\bar{v}, \lambda \bar{v}') = \lambda \underline{f}(\bar{v}, \bar{v}')$.

$$\forall \underline{f} \in L(\bar{V} \times \bar{V}, \mathbb{R}); \bar{v}, \bar{v}', \bar{w} \in \bar{V}; \lambda \in \mathbb{R}.$$

Endomorphisms

Frequently in the field of solid mechanics we will meet special linear mappings from a vector space into itself, i.e. $\underline{f} \in L(\bar{V}, \bar{V})$. These are defined *endomorphisms*

$$\underline{f} : \bar{V} \rightarrow \bar{V}, \quad \bar{v} \mapsto \bar{v}' \quad \bar{v}, \bar{v}' \in \bar{V} \quad (1.16)$$

The set of linear mappings from \bar{V} into itself forms a $n \times n$ -dimensional vector space, where n is the dimension of \bar{V} .

$$\{\underline{f} : \bar{V} \rightarrow \bar{V}\} =: L(\bar{V}, \bar{V}) =: \text{End}(\bar{V}) \quad (1.17)$$

Change of basis for endomorphisms

Let \mathcal{B} be a fixed basis for \bar{V} , we are interested in evaluating how the endomorphism $f \in \text{End}(\bar{V})$ changes when passing to a new basis \mathcal{B}' of \bar{V} . The following transformation rules are established

$$\bar{b}_i = a_i'^h \bar{b}'_h \quad (1.18)$$

$$\bar{b}'_h = a_h^j \bar{b}_j \quad (1.19)$$

that, by replacing (1.19) into (1.18), yield

$$\bar{b}_i = a_i'^h a_h^k \bar{b}_k \quad (1.20)$$

and so

$$\left(a_i'^h a_h^k - \delta_i^k \right) \bar{b}_k = 0 \Rightarrow a_i'^h a_h^k = \delta_i^k \quad (1.21)$$

therefore, each change of basis for \bar{V} is characterized by a square invertible matrix $n \times n$.

Likewise vectors, the following rules hold for dual elements

$$\underline{\beta}^i = a_h^i \underline{\beta}^h \quad (1.22)$$

$$\underline{\beta}^i = a_h^i \underline{\beta}^h \quad (1.23)$$

When both bases are orthogonal, then the transformation matrices are also orthogonal, that is

$$a_i'^h = a_h^i \quad (1.24)$$

where $a_i'^h = (a_h^i)^{-1}$, and

$$a_j'^i = \cos(\bar{b}'_i, \bar{b}_j) \quad (1.25)$$

$$a_k^h = \cos(\bar{b}_h, \bar{b}'_k) \quad (1.26)$$

The change of basis implies a change of the vector components. In fact we have

$$v^k = a_j^k v'^j \quad (1.27)$$

$$v'^k = a_j'^k v^j \quad (1.28)$$

The proof of the above equations can be easily provided. For instance, for equation (1.27) we have that a vector \bar{v} can be expressed with respect to two basis \mathcal{B} and \mathcal{B}' as $\bar{v} = v^i \bar{b}_i = v'^j \bar{b}'_j$. Hence

$$v^i \bar{b}_i = v'^j a_j^k \bar{b}_k \Rightarrow v'^j a_j^k \bar{b}_k - v^i \bar{b}_i = 0 \Rightarrow \quad (1.29)$$

$$v'^j a_j^k \bar{b}_k - v^i \delta_i^k \bar{b}_k = 0 \Rightarrow \left(v'^j a_j^k - v^i \delta_i^k \right) \bar{b}_k = 0 \quad (1.30)$$

finally, by putting zero the coefficient in brackets, we obtain relation (1.27).

Covector components change by the the following rules

$$v_k = a_k^i v'_i \quad (1.31)$$

$$v'_k = a_k^i v_i \quad (1.32)$$

Furthermore, recalling equation (1.9), via some manipulations, we get the rule to transform the endomorphism f , that is¹

$$f_j^i = a_h^i f_k^{lh} a_j'^k \quad (1.33)$$

and

$$f_j'^i = a_h^i f_k^{lh} a_j^k \quad (1.34)$$

Similar relationships can be found for higher order matrices, for instance for a mixed fourth-order tensor we have

$$f_{hk}^{ij} = a_l^i a_m^j f_{no}^{lm} a_h^m a_k'^o \quad (1.35)$$

and likewise

$$f_{hk}^{'ij} = a_l^i a_m^j f_{no}^{lm} a_h^n a_k^o \quad (1.36)$$

1.2 Euclidean spaces

A Euclidean vector space is a space which admits a Euclidean metric, that is a structure inducing some special relationships between distances and angles. In particular, fixed a Cartesian coordinate system (that will be better defined later on) and its standard basis, in a Euclidean space the distance between two points can be computed by means of *Pitagora's* formula.

¹Often, within an engineering context, it is convenient to represent equations (1.33) and (1.34) in the matrix form, such as $F' = R^T F R$ and $F = R F' R^T$, where R^T and R are nothing but a_j^i and a_k^n , respectively.

1.2.1 Euclidean metric tensor and scalar product

Let \bar{V} be a n -dimensional vector space and $\mathcal{B} = \{\bar{b}_i\}$ be its basis. We define *Euclidean metric* the symmetric positive definite bilinear mapping

$$g : \bar{V} \times \bar{V} \rightarrow \mathbb{R} \quad (1.37)$$

that, given a pair of vectors $\bar{u}, \bar{v} \in \bar{V}$, gives a real number $g(\bar{u}, \bar{v})$ as follows

$$\bar{u} \cdot \bar{v} =: g(\bar{u}, \bar{v}) \quad (1.38)$$

The number $g(\bar{u}, \bar{v})$ is termed **scalar product**. The Euclidean metric allows us to compute distances. Indeed, we define *length* (or *modulus*, or *norm*) of $\bar{v} \in \bar{V}$ the real number

$$\|\bar{v}\| = \sqrt{g(\bar{v}, \bar{v})} \geq 0 \quad (1.39)$$

The angle ϑ amid vectors \bar{u} and \bar{v} is given by the following equation

$$\cos \vartheta = \frac{g_{ij} u^i v^j}{\sqrt{|g_{ij} u^i v^j| |g_{ij} u^i v^j|}} \quad (1.40)$$

To compute the components of the metric tensor, i.e. the matrix representing the mapping g , given the basis $\mathcal{B} = \{\bar{b}_i\}$ of \bar{V} , the following general rule is adopted

$$g_{ij} = g(\bar{b}_i, \bar{b}_j) = \bar{b}_i \cdot \bar{b}_j \quad (1.41)$$

that in the expanded form becomes

$$g_{ij} = \begin{pmatrix} \bar{b}_1 \cdot \bar{b}_1 & \cdots & \bar{b}_1 \cdot \bar{b}_n \\ \vdots & \ddots & \vdots \\ \bar{b}_n \cdot \bar{b}_1 & \cdots & \bar{b}_n \cdot \bar{b}_n \end{pmatrix} \quad (1.42)$$

In the light of the above general expression for the metric tensor, the scalar product between two vectors becomes

$$\bar{u} \cdot \bar{v} = u^i \bar{b}_i \cdot v^j \bar{b}_j = u^i u^j \bar{b}_i \cdot \bar{b}_j = g_{ij} u^i v^j \quad (1.43)$$

Expression (1.43) includes, of course, the special case when, fixed a Cartesian coordinate system, the metric matrix equals the identity matrix δ_{ij} and consequently the scalar product can be carried out multiplying component by component, i.e. $\bar{u} \cdot \bar{v} = u^1 v^1 + \cdots + v^n u^n$.

Now we want to point out that between the n -dimensional vector space \bar{V} and its dual \bar{V}^* there exists an isomorphism. Note that we are using some special words, e.g. *isomorphism*, without giving the formal mathematical definition. This lies beyond the purpose of this book, so that, also in this case, we will restrict the current exposition to an intuitive concept. From this point of view, an isomorphism is a one-to-one mapping of an algebraic structure, e.g. vector space, into another of the same type, preserving all algebraic relations.

Thus we define the *musical isomorphisms: flat* and *sharp*, respectively, as follows

$$g^b : \bar{V} \rightarrow \bar{V}^* : \bar{v} \mapsto \underline{v} \quad (1.44)$$

$$g^\sharp : \bar{V}^* \rightarrow \bar{V} : \underline{v} \mapsto \bar{v} \quad (1.45)$$

where

$$\underline{u}(\bar{v}) = \underline{g}(\bar{u}, \bar{v}), \quad \forall \bar{u} \in \bar{V} \quad (1.46)$$

The isomorphism between \bar{V} and \bar{V}^* implies the existence of a metric tensor

$$\bar{g} : \bar{V}^* \times \bar{V}^* \rightarrow \mathbb{R} \quad (1.47)$$

so that

$$\bar{u} \cdot \bar{v} = \underline{g}(\bar{u}, \bar{v}) := \bar{g}(\underline{u}, \underline{v}) = \underline{u} \cdot \underline{v} \quad (1.48)$$

For further details the reader is referred to [4].

Both g^b and g^\sharp are particularly helpful when carrying out computations it is necessary to switch from the contravariant form to the covariant form (and vice versa); namely when we need to lower or raise the indices.

1.2.2 Eigenvalues and eigenvectors

Let \bar{V} be a n dimensional vector space and $\mathcal{B} = \{\bar{b}_1, \dots, \bar{b}_n\}$ the vector basis. Given $f \in \text{End}(\bar{V})$, we define the *eigenvector* a nonzero vector \bar{v} whose direction does not change under the effect of f . Formally

$$f(\bar{v}) = \lambda \bar{v}, \quad \lambda \in \mathbb{R} \quad (1.49)$$

When equation (1.49) holds we can also define the real number λ as the *eigenvalue* for \bar{v} .

The eigenvalues of f represent the real roots of the following polynomial

$$p_n(\lambda) = \det(f_j^i - \lambda\delta_j^i) \quad (1.50)$$

where $p_n(\lambda)$ is called the *characteristic polynomial* of degree n and f_j^i is the matrix representation of the endomorphism f .

1.3 Tensors

This section is devoted to a short outline of tensor analysis.

Given two vector spaces \bar{U} and \bar{V} it is possible to construct a new structure, i.e. a third vector space, called *tensor product* of \bar{U} times \bar{V} that is symbolically denoted by $\bar{U} \otimes \bar{V}$. This vector space is made up of elements called *tensors*. It is possible to demonstrate that if

$$\begin{aligned} \mathcal{B}_{\bar{U}} &= \{\bar{u}_1, \dots, \bar{u}_n\} \\ \mathcal{B}_{\bar{V}} &= \{\bar{v}_1, \dots, \bar{v}_m\} \end{aligned}$$

are bases for \bar{U} and \bar{V} , respectively, then

$$\mathcal{B}_{\bar{U} \otimes \bar{V}} = \{\bar{u}_i \otimes \bar{v}_j\}, \quad i = 1, \dots, n; \quad j = 1, \dots, m$$

is a basis of the vector space $\bar{U} \otimes \bar{V}$. Therefore, each tensor $\bar{\tau} \in \bar{U} \otimes \bar{V}$ can be univocally expressed by

$$\bar{\tau} = \bar{\tau}^{ij} (\bar{u}_i \otimes \bar{v}_j) \quad (1.51)$$

where again the Einstein's summation convention has been used, in fact (1.51) can also be written

$$\bar{\tau} = \sum_{i=1}^n \sum_{j=1}^m \bar{\tau}^{ij} \bar{u}_i \otimes \bar{v}_j$$

1.3.1 Tensors and linear mappings

The definition of tensors does not alter the structure of \bar{U} and \bar{V} , and, since the dual space \bar{V}^* preserves the structure of a vector space, we can introduce tensors belonging to spaces such as $\bar{U}^* \otimes \bar{V}^*$

and $\bar{U}^* \otimes \bar{V}$. In other words we distinguish the following second order tensors:

$$\begin{aligned}\bar{U}^* \otimes \bar{V} &: && \text{mixed tensors} \\ \bar{U}^* \otimes \bar{V}^* &: && \text{covariant tensors} \\ \bar{U} \otimes \bar{V} &: && \text{contravariant tensors}\end{aligned}$$

Mixed tensors: given the n -dimensional vector spaces \bar{V} and \bar{V}^* , let $\underline{\alpha} \in \bar{V}^*$ be a dual form and $\bar{v} \in \bar{V}$ a vector, then the tensor $\underline{\alpha} \otimes \bar{v} \in \bar{V}^* \otimes \bar{V}$ can be identified by the endomorphism $\underline{\alpha} \otimes \bar{v} \in \text{End}(\bar{V}) = L(\bar{V}, \bar{V})$ defined as

$$\underline{\alpha} \otimes \bar{v} : \bar{V} \rightarrow \bar{V} : \bar{u} \mapsto (\underline{\alpha} \otimes \bar{v}) \bar{u} = \underline{\alpha}(\bar{u}) \bar{v} \in \bar{V} \quad (1.52)$$

Hence, a natural isomorphism has been obtained

$$\bar{V}^* \otimes \bar{V} \cong L(\bar{V}, \bar{V}) \quad (1.53)$$

Covariant tensors: Let $\underline{\alpha}, \underline{\beta}$ be two linear forms belonging to \bar{V}^* . We can identify the tensor $\underline{\alpha} \otimes \underline{\beta} \in \bar{V}^* \otimes \bar{V}^*$ by the bilinear form $\underline{\alpha} \otimes \underline{\beta} \in L^2(\bar{V}, \mathbb{R})$ defined as

$$\underline{\alpha} \otimes \underline{\beta} : \bar{V} \times \bar{V} \rightarrow \mathbb{R} : (\bar{u}, \bar{v}) \mapsto \underline{\alpha}(\bar{u}) \underline{\beta}(\bar{v}) \in \mathbb{R} \quad (1.54)$$

Therefore we can realize another isomorphism, which is

$$\bar{V}^* \otimes \bar{V}^* \cong L^2(\bar{V}, \mathbb{R}) \quad (1.55)$$

Vectors, linear forms and tensors so far discussed can be summarized in the following scheme

Vectors

$$\bar{v} \in \bar{V} \quad (1.56)$$

Linear forms

$$\underline{\alpha} \in \bar{V}^* \cong L(\bar{V}, \mathbb{R}) \quad (1.57)$$

II-order mixed tensors

$$\underline{\alpha} \otimes \bar{v} \in \bar{V}^* \otimes \bar{V} \cong \text{End}(\bar{V}) \quad (1.58)$$

II-order covariant tensors

$$\underline{\alpha} \otimes \underline{\beta} \in \bar{V}^* \otimes \bar{V}^* \cong L^2(\bar{V}, \mathbb{R}) \quad (1.59)$$

1.4 Coordinate systems

Within the three-dimensional affine Euclidean space E it is possible to define a *coordinate system* through the following bijections

$$X : E \rightarrow \mathbb{R}^3 \quad X^{-1} : \mathbb{R}^3 \rightarrow E \quad (1.60)$$

where $X = (x^1, x^2, x^3)$. The injectivity of X assures the one-to-one correspondence between points belonging to E and their coordinates. Namely, given a point $p \in E$ there exists the triplet (x^1, x^2, x^3) which identifies such a point. The mapping X is assumed to be differentiable as many times as required.

The coordinate system X is made up of *coordinate functions*

$$x^i : E \rightarrow \mathbb{R} \quad i = 1, 2, 3 \quad (1.61)$$

Moreover, we define the *coordinate curves* as the following mappings

$$x_{ip} : \mathbb{R} \rightarrow E \quad i = 1, 2, 3 \quad (1.62)$$

such as

$$\begin{aligned} x_{1p}(\lambda) &= X^{-1}(x^1(p) + \lambda, x^2(p), x^3(p)) \\ x_{2p}(\lambda) &= X^{-1}(x^1(p), x^2(p) + \lambda, x^3(p)) \\ x_{3p}(\lambda) &= X^{-1}(x^1(p), x^2(p), x^3(p) + \lambda) \end{aligned}$$

that in a shorter form become

$$x^j(x_{ip}(\lambda)) = x^j(p) + \delta_i^j \lambda \quad p \in E, \quad \lambda \in \mathbb{R} \quad (1.63)$$

Given a point $p \in E$, there are three coordinate curves passing through it.

It is possible to demonstrate that the derivatives of the *coordinate curves*, computed for a fixed λ , are vectors forming a basis $\mathcal{B} = \{\bar{\partial}_i\}$ in p .

Analogously, it can be proved that the derivatives of the *coordinate functions* $\{x^i\}$ computed in p form a covariant basis $\mathcal{B}^* = \{\mathfrak{d}^i\}$ in such a point.

The above two bases satisfy the following relation

$$\mathfrak{d}^j(\bar{\partial}_i) = \delta_i^j \quad (1.64)$$

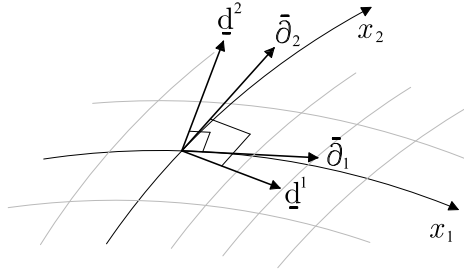

Figure 1.1: Contravariant and covariant bases related to a 2D curvilinear coordinate system.

See [4] for further details.

Bases $\mathcal{B} = \{\bar{\partial}_1, \bar{\partial}_2, \bar{\partial}_3\}$ and $\mathcal{B}^* = \{\underline{d}^1, \underline{d}^2, \underline{d}^3\}$ related to X allow the representation of vectors, linear forms and tensor fields. For example we write

$$\bar{v} = v^i \bar{\partial}_i, \quad \forall \bar{v} : E \rightarrow \bar{E} \quad (1.65)$$

$$\underline{w} = w_i \underline{d}^i \quad \forall \underline{w} : E \rightarrow \bar{E}^* \quad (1.66)$$

where \bar{v} and \underline{w} are vector and covector fields, respectively.

1.4.1 Linear mappings and the metric tensor

In order to represent an endomorphism f by means of the coordinate system X we can write

$$\underline{f} = f_i^j \underline{d}^i \otimes \bar{\partial}_j, \quad \forall \underline{f} : E \rightarrow L(\bar{E}, \bar{E}) \cong \bar{E}^* \otimes \bar{E} \quad (1.67)$$

where

$$f_i^j = \underline{d}^j (f(\bar{\partial}_i)) : E \rightarrow \mathbb{R} \quad (1.68)$$

and likewise, for the bilinear form we write

$$\underline{f} = f_{ij} \underline{d}^i \otimes \underline{d}^j, \quad \forall \underline{f} : E \rightarrow L^2(\bar{E}, \mathbb{R}) \cong \bar{E}^* \otimes \bar{E}^* \quad (1.69)$$

where

$$f_{ij} = \underline{f}(\bar{\partial}_i, \bar{\partial}_j) : E \rightarrow \mathbb{R} \quad (1.70)$$

It is straightforward now to realize that the metric tensor \underline{g} is nothing but the following bilinear form

$$\underline{g} : E \rightarrow L^2(\bar{E}, \mathbb{R}) \cong \bar{E}^* \otimes \bar{E}^* \quad (1.71)$$

indeed

$$\underline{g} = g_{ij} \underline{d}^i \otimes \underline{d}^j \quad (1.72)$$

where

$$g_{ij} = \underline{g}(\bar{\partial}_i, \bar{\partial}_j) \quad (1.73)$$

As a concluding remark of this section we point out the fact that once the coordinate system is fixed it is possible to find its vector basis, i.e. the covariant basis, and therefore the covariant expression of the metric tensor can be directly computed.

1.4.2 Components of the metric tensor

Suppose that $X_c = \{x_c^i\}$, $i = 1, 2, 3$ is a Cartesian coordinate system, with the origin $o \in E$, which describes the affine Euclidean space E and $\{\bar{e}_i\}$, $i = 1, 2, 3$ its unit normal basis. Moreover, let $X = \{x^j\}$, $j = 1, 2, 3$ be a generic curvilinear coordinate and $\{\bar{\partial}_j\}$, $j = 1, 2, 3$ its basis. Suppose that the functions x_c^i and x^i are single-valued and continuously differentiable with respect to each of their variables as many times as required, we can therefore write

$$x_c^i = x_c^i(x^1, x^2, x^3) \quad i = 1, 2, 3 \quad (1.74)$$

$$x^i = x^i(x_c^1, x_c^2, x_c^3) \quad i = 1, 2, 3 \quad (1.75)$$

and the rules for changing basis (1.18) and (1.19) on page 7, become

$$\bar{\partial}_i = \frac{\partial x_c^h}{\partial x^i} \bar{e}_h; \quad \underline{d}^i = \frac{\partial x_c^i}{\partial x_c^h} \underline{e}^h \quad (1.76)$$

and

$$\bar{e}_i = \frac{\partial x_c^h}{\partial x_c^i} \bar{\partial}_h; \quad \underline{e}^i = \frac{\partial x_c^i}{\partial x_c^h} \underline{d}^h \quad (1.77)$$

where equations (1.76) transform the covariant and contravariant elements of the Cartesian basis into the elements of the curvilinear basis while expressions (1.77) perform the vice-versa.

Now, according to equation (1.41), it is possible to compute the covariant components of the metric tensor related to the curvilinear coordinate system

$$g_{ij} = \bar{\partial}_i \cdot \bar{\partial}_j = \frac{\partial x_c^h}{\partial x^i} \bar{e}_h \cdot \frac{\partial x_c^k}{\partial x^j} \bar{e}_k = \quad (1.78)$$

$$= \frac{\partial x_c^h}{\partial x^i} \frac{\partial x_c^k}{\partial x^j} \delta_{hk} = \frac{\partial x_c^h}{\partial x^i} \frac{\partial x_c^h}{\partial x^j} \quad (1.79)$$

Moreover, the contravariant components are

$$g^{ij} = \underline{d}^i \cdot \underline{d}^j = \frac{\partial x^i}{\partial x_c^h} \underline{e}^h \cdot \frac{\partial x^j}{\partial x_c^k} \underline{e}^k = \quad (1.80)$$

$$= \frac{\partial x^i}{\partial x_c^h} \frac{\partial x^j}{\partial x_c^k} \delta^{hk} = \frac{\partial x^i}{\partial x_c^h} \frac{\partial x^j}{\partial x_c^h} \quad (1.81)$$

and finally the mixed components of the metric tensor are

$$g_j^i = \underline{d}^i (\bar{\partial}_j) = \frac{\partial x^i}{\partial x_c^h} \underline{e}^h \cdot \frac{\partial x_c^k}{\partial x^j} \bar{e}_k = \quad (1.82)$$

$$= \frac{\partial x^i}{\partial x_c^h} \frac{\partial x_c^k}{\partial x^j} \delta_k^h = \frac{\partial x^i}{\partial x_c^h} \frac{\partial x_c^h}{\partial x^j} \quad (1.83)$$

Christoffel symbols

The *Christoffel*²'s symbol are defined as follows

$$\Gamma_{ij}^k = \underline{d}^k (\nabla_i \bar{\partial}_j) : E \rightarrow \mathbb{R} \quad (1.84)$$

so that $\nabla_i \bar{\partial}_j = \Gamma_{ij}^k \bar{\partial}_k$. Hence, Γ_{ij}^k is the k -th component of the derivative of the basis element $\bar{\partial}_j$ along the i -th direction. Analytically they can be computed by the following formula

$$\Gamma_{ij}^k = \frac{1}{2} g^{kh} (\partial_i g_{hj} + \partial_j g_{hi} - \partial_h g_{ij}) \quad (1.85)$$

where ∂_i denotes the partial derivatives.

Moreover, it can be proved that

$$\Gamma_{ij}^k = (\nabla_i \bar{\partial}_j)^k = - \left(\nabla_i \underline{d}^k \right)_j \quad (1.86)$$

For proofs and more details the reader is referred to [4], [5] and [1].

²Elwin Bruno Christoffel (November 10, 1829 Montjoie, now called Munschau - March 15, 1900 Strasbourg) was a German mathematician and physicist.



1.4.3 Examples of coordinate systems

Cartesian coordinates

The Cartesian coordinate system introduces considerable simplifications with respect to other curvilinear systems, e.g. cylindrical, spherical, hyperbolic, etc.

Therefore, let us begin by defining a *Cartesian coordinate system* as the triplet of coordinate functions

$$X_c = (x, y, z) \equiv (x^1, x^2, x^3) : E \rightarrow \mathbb{R}^3 \quad (1.87)$$

with an origin in $o \in E$ and equipped with the unit normal basis, also called standard basis, $\{\bar{e}_1, \bar{e}_2, \bar{e}_3\}$. Given $p \in E$, the coordinate functions are such that

$$x^i(p) =: (p - o) \cdot \bar{e}_i \quad (1.88)$$

The coordinate curves of a Cartesian system are

$$x_{ip}(\lambda) = p + \lambda \bar{e}_i \quad (1.89)$$

Notice that for rectangular coordinate systems the symbols denoting the bases will turn into

$$\bar{d}_i = \bar{e}_i \quad (1.90)$$

$$\underline{d}^i = e^i \quad (1.91)$$

The covariant form of the metric tensor can be readily computed as follows

$$g_{ij} = \bar{e}_i \cdot \bar{e}_j = \delta_{ij} \quad (1.92)$$

Elements of the standard basis related to the Cartesian coordinate system do not vary with the point $p \in E$. As a consequence, the Christoffel symbols are identically null.

$$\Gamma_{ij}^k = 0 \quad (1.93)$$

In addition to that we also highlight that here the upper or lower position of the indices does not influence the structure of the field we are dealing with. Namely, vectors and linear forms are the same and the unit normal basis equals its dual.

$$g^b(\bar{e}_i) = \underline{e}^i = \bar{e}_i \quad (1.94)$$

For this reason whenever given two sets of numbers having the same dimension, they can be ordered in a row and a column, respectively, and by using the multiplication rule row-by-column a scalar is always yielded without taking any care whether we are dealing with vectors or linear forms.

Cylindrical coordinates

We define a cylindrical coordinate system the functions

$$X = (\rho, \vartheta, z) : E \rightarrow \mathbb{R}^3 \quad (1.95)$$

In this case, with the help of figure 1.2, equation (1.74) becomes

$$\begin{aligned} x &= \rho \sin \vartheta \\ y &= \rho \cos \vartheta \\ z &= z \end{aligned}$$

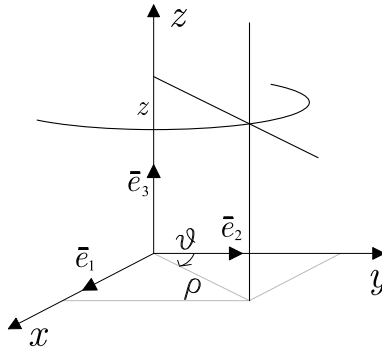

Figure 1.2: Cylindrical coordinate system.

Now, through equation (1.76), it is easy to compute the basis related to the cylindrical system

$$\begin{aligned} \bar{\partial}_\rho &= \frac{\partial x}{\partial \rho} \bar{e}_1 + \frac{\partial y}{\partial \rho} \bar{e}_2 + \frac{\partial z}{\partial \rho} \bar{e}_3 \\ \bar{\partial}_\vartheta &= \frac{\partial x}{\partial \vartheta} \bar{e}_1 + \frac{\partial y}{\partial \vartheta} \bar{e}_2 + \frac{\partial z}{\partial \vartheta} \bar{e}_3 \\ \bar{\partial}_z &= \frac{\partial x}{\partial z} \bar{e}_1 + \frac{\partial y}{\partial z} \bar{e}_2 + \frac{\partial z}{\partial z} \bar{e}_3 \end{aligned}$$

Hence, the covariant components of the metric tensor is

$$\begin{aligned} g_{\rho\rho} &= 1 \\ g_{\vartheta\vartheta} &= \rho^2 \\ g_{zz} &= 1 \\ g_{\vartheta z} = g_{\rho z} = g_{\rho\vartheta} &= 0 \end{aligned}$$

that in the matrix form can be written as follows

$$g_{ij} = \begin{pmatrix} 1 & 0 & 0 \\ 0 & \rho^2 & 0 \\ 0 & 0 & 1 \end{pmatrix} \quad (1.96)$$

The contravariant form of the metric tensor is

$$g^{ij} = (g_{ij})^{-1} = \begin{pmatrix} 1 & 0 & 0 \\ 0 & \frac{1}{\rho^2} & 0 \\ 0 & 0 & 1 \end{pmatrix} \quad (1.97)$$

Using equation (1.85), the Christoffel symbols are

$$\Gamma_{\vartheta\vartheta}^{\rho} = -\rho, \quad \Gamma_{\vartheta\rho}^{\vartheta} = \Gamma_{\rho\vartheta}^{\vartheta} = \frac{1}{\rho} \quad (1.98)$$

Spherical coordinates

We define a spherical coordinate system by the functions

$$X = (r, \vartheta, \varphi) : E \rightarrow \mathbb{R}^3 \quad (1.99)$$

In this case, with the help of figure 1.3, equation (1.74) becomes

$$\begin{aligned} x &= r \sin \varphi \cos \vartheta \\ y &= r \sin \varphi \sin \vartheta \\ z &= r \cos \varphi \end{aligned}$$

Now, through equation (1.76), it is easy to compute the basis related to the spherical system

$$\begin{aligned} \bar{\partial}_r &= \frac{\partial x}{\partial r} \bar{e}_1 + \frac{\partial y}{\partial r} \bar{e}_2 + \frac{\partial z}{\partial r} \bar{e}_3 \\ \bar{\partial}_\vartheta &= \frac{\partial x}{\partial \vartheta} \bar{e}_1 + \frac{\partial y}{\partial \vartheta} \bar{e}_2 + \frac{\partial z}{\partial \vartheta} \bar{e}_3 \\ \bar{\partial}_\varphi &= \frac{\partial x}{\partial \varphi} \bar{e}_1 + \frac{\partial y}{\partial \varphi} \bar{e}_2 + \frac{\partial z}{\partial \varphi} \bar{e}_3 \end{aligned}$$

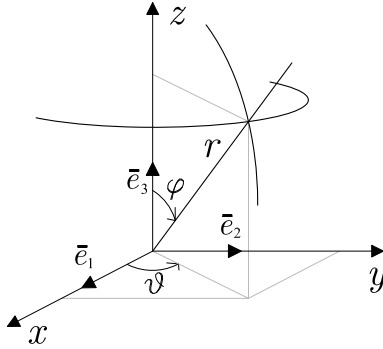

Figure 1.3: Spherical coordinate system.

Hence, the covariant components are

$$\begin{aligned} g_{rr} &= 1 \\ g_{\vartheta\vartheta} &= r^2 \sin^2 \varphi \\ g_{\varphi\varphi} &= r^2 \\ g_{r\vartheta} &= g_{r\varphi} = g_{\vartheta\varphi} = 0 \end{aligned}$$

which in the matrix form are written as follows

$$g_{ij} = \begin{pmatrix} 1 & 0 & 0 \\ 0 & r^2 \sin^2 \varphi & 0 \\ 0 & 0 & r^2 \end{pmatrix} \quad (1.100)$$

The contravariant form of the metric tensor is

$$g^{ij} = (g_{ij})^{-1} = \begin{pmatrix} 1 & 0 & 0 \\ 0 & \frac{1}{r^2 \sin^2 \varphi} & 0 \\ 0 & 0 & \frac{1}{r^2} \end{pmatrix} \quad (1.101)$$

Using equation (1.85), the Christoffel symbols are

$$\begin{aligned} \Gamma_{\varphi\varphi}^r &= -r & \Gamma_{\vartheta\vartheta}^r &= -r \sin^2 \varphi \\ \Gamma_{r\varphi}^\varphi &= \Gamma_{\varphi r}^\varphi = \frac{1}{r} & \Gamma_{\vartheta\vartheta}^\varphi &= -\sin \varphi \cos \varphi \\ \Gamma_{r\vartheta}^\vartheta &= \Gamma_{\vartheta r}^\vartheta = \frac{1}{r} & \Gamma_{\vartheta\varphi}^\vartheta &= \Gamma_{\varphi\vartheta}^\vartheta = \frac{\cos \varphi}{\sin \varphi} \end{aligned}$$

1.4.4 Volumes and the vector product

In the three-dimensional Euclidean space a *volume element* η is defined as a three-linear form such as

$$\eta := \bar{E} \times \bar{E} \times \bar{E} \rightarrow \mathbb{R}, \quad (1.102)$$

$$(\bar{v}_1, \bar{v}_2, \bar{v}_3) \mapsto \eta(\bar{v}_1, \bar{v}_2, \bar{v}_3) \in \mathbb{R} \quad (1.103)$$

When the set of three vectors forms a basis $\{\bar{b}_1, \bar{b}_2, \bar{b}_3\}$, for any other basis $\{\bar{b}'_1, \bar{b}'_2, \bar{b}'_3\}$, the volume element changes with the following expression

$$\eta(\bar{b}'_1, \bar{b}'_2, \bar{b}'_3) = |a_j^i| \eta(\bar{b}_1, \bar{b}_2, \bar{b}_3) \quad (1.104)$$

where $|a_j^i|$ is the determinant of the endomorphism for basis changing already seen in equation (1.18).

The application η can be expressed by a third order skew-symmetric tensor η_{ijk} with the following properties. If two of the subscripts $\{i, j, k\}$ equal each other the volume element vanishes. Any odd permutation of the subscripts changes the sign of the element, any even permutation of the subscripts does not alter the volume element.

For a Cartesian system of coordinates we shall denote the volume form by ϵ_{ijk} and the above properties become clearer in the following scheme

$$\epsilon_{ijk} = \epsilon^{ijk} = \begin{cases} 0 & \text{when any two of the indices are equal;} \\ 1 & \text{when } i, j, k \text{ is an even permutation of the numbers } 1, 2, 3; \\ -1 & \text{when } i, j, k \text{ is an odd permutation of the numbers } 1, 2, 3; \end{cases}$$

that means, for example

$$\begin{aligned} \epsilon^{112} &= \epsilon_{112} = \epsilon^{133} = \epsilon_{133} = \epsilon^{222} = \epsilon_{222} = 0 \\ \epsilon^{123} &= \epsilon_{123} = \epsilon^{231} = \epsilon_{231} = \epsilon^{312} = \epsilon_{312} = 1 \\ \epsilon^{132} &= \epsilon_{132} = \epsilon^{321} = \epsilon_{321} = \epsilon^{213} = \epsilon_{213} = -1 \end{aligned}$$

In addition, the operator ϵ_{ijk} satisfies the following identity

$$\epsilon_{ijk}\epsilon_{ilh} = \delta_{jl}\delta_{kh} - \delta_{jh}\delta_{kl} \quad (1.105)$$

Suppose that $\{\bar{\partial}_i, \bar{\partial}_j, \bar{\partial}_k\}$ is a basis related to a curvilinear coordinate system, we want to evaluate the volume element in this

system through the volume element expressed in the Cartesian axes.

$$\begin{aligned} \eta(\bar{\partial}_i, \bar{\partial}_j, \bar{\partial}_k) &= \eta\left(\frac{\partial x_c^r}{\partial x_i} \bar{e}_r, \frac{\partial x_c^s}{\partial x_j} \bar{e}_s, \frac{\partial x_c^t}{\partial x_k} \bar{e}_t\right) = \\ &= \frac{\partial x_c^r}{\partial x_i} \frac{\partial x_c^s}{\partial x_j} \frac{\partial x_c^t}{\partial x_k} \epsilon_{rst} = \eta_{ijk} \end{aligned} \quad (1.106)$$

which, by means of equation (1.104), we find that the coefficient of the volume element in the Cartesian coordinates ϵ on the left-hand side of the latter equation equals the determinant of the endomorphism of the basis changing, namely

$$\frac{\partial x_c^r}{\partial x_i} \frac{\partial x_c^s}{\partial x_j} \frac{\partial x_c^t}{\partial x_k} = |a_m^p| = \det\left(\frac{\partial x_c^p}{\partial x_m}\right) \quad (1.107)$$

It is easy to prove that the above determinant is the square root of the determinant of the metric tensor related to the generic coordinate system $\{x^i\}$, $i = 1, 2, 3$. So we have

$$\eta(\bar{\partial}_i, \bar{\partial}_j, \bar{\partial}_k) = \sqrt{|g_{pq}|} \epsilon_{ijk} \quad (1.108)$$

and in the same way the following contravariant expression can be derived

$$\bar{\eta}(\bar{\mathbf{d}}^i, \bar{\mathbf{d}}^j, \bar{\mathbf{d}}^k) = \sqrt{|g^{pq}|} \epsilon^{ijk} \quad (1.109)$$

where $|g_{pq}| = \det(g_{pq})$ and $|g^{pq}| = \frac{1}{\det(g_{pq})} = \det(g^{pq})$.

The skew-symmetric tensor η defines the **vector product** as follows

$$\bar{\mathbf{u}} \times \bar{\mathbf{v}} = u^i \bar{\partial}_i \times v^j \bar{\partial}_j = u^i v^j \bar{\partial}_i \times \bar{\partial}_j = u^i v^j \eta_{ijk} \bar{\mathbf{d}}^k \quad (1.110)$$

and also

$$\underline{\mathbf{u}} \times \underline{\mathbf{v}} = u_i \bar{\mathbf{d}}^i \times v_j \bar{\mathbf{d}}^j = u_i v_j \bar{\mathbf{d}}^i \times \bar{\mathbf{d}}^j = u_i v_j \eta^{ijk} \bar{\partial}_k \quad (1.111)$$

We can use the tensor η to compute infinitesimal volume, area and line elements. Let us begin putting the infinitesimal vector along the j -th coordinate curve as follows

$$d\bar{l}_j = dx^j \bar{\partial}_j \quad (j \text{ not summed}) \quad (1.112)$$

so that the infinitesimal volume is given by

$$d\mathcal{V} = \eta(d\bar{l}_1, d\bar{l}_2, d\bar{l}_3) \quad (1.113)$$

hence

$$\begin{aligned} d\mathcal{V} &= \eta (\bar{\partial}_1, \bar{\partial}_1, \bar{\partial}_1) dx^1 dx^2 dx^3 = \\ \sqrt{g} \epsilon_{123} dx^1 dx^2 dx^3 &= \sqrt{g} dx^1 dx^2 dx^3 \end{aligned} \quad (1.114)$$

The above expression for the volume element can also be written as

$$d\mathcal{V} = [d\bar{l}_1 \times d\bar{l}_2] \cdot d\bar{l}_3 \quad (1.115)$$

that allows us to attain the same equation expressed in (1.114), indeed we have

$$\begin{aligned} [d\bar{l}_1 \times d\bar{l}_2] \cdot d\bar{l}_3 &= dx^1 dx^2 \eta_{123} d\bar{\mathbf{d}}^3 (dx^3 \bar{\partial}_3) = \\ dx^1 dx^2 dx^3 \sqrt{g} \epsilon_{123} d\bar{\mathbf{d}}^3 (\bar{\partial}_3) &= dx^1 dx^2 dx^3 \sqrt{g} \epsilon_{123} \delta_3^3 = \\ \sqrt{g} dx^1 dx^2 dx^3 & \end{aligned} \quad (1.116)$$

Infinitesimal area element

Taken two infinitesimal vectors along two coordinate curves respectively, the infinitesimal area normal to the vector along the third coordinate curve is given by

$$\begin{aligned} d\mathcal{A}_3 &= |d\bar{l}_1 \times d\bar{l}_2| = \eta_{123} |d\bar{\mathbf{d}}^3| dx^1 dx^2 = \\ \sqrt{g} \sqrt{d\bar{\mathbf{d}}^3 \cdot d\bar{\mathbf{d}}^3} dx^1 dx^2 &= \sqrt{g g^{33}} dx^1 dx^2 \end{aligned} \quad (1.117)$$

and it is easy to obtain the general expression for any area element

$$d\mathcal{A}_i = \sqrt{g g^{ii}} dx^j dx^k \quad (1.118)$$

where i is not summed and $i \neq j \neq k$.

Infinitesimal line element

A generic infinitesimal line element $d\bar{l}^2$ is defined by

$$\begin{aligned} d\bar{l}^2 &= |d\bar{l}|^2 = d\bar{l} \cdot d\bar{l} = \\ dx^i \bar{\partial}_i \cdot dx^j \bar{\partial}_j &= dx^i dx^j g_{ij} \end{aligned} \quad (1.119)$$

whereas, a line element taken along the i -th coordinate curve can be represented by the vector

$$d\bar{l}_i = dx^i \bar{\partial}_i \quad (i \text{ not summed}) \quad (1.120)$$

and it measures

$$\sqrt{g (d\bar{l}_i, d\bar{l}_i)} = g_{ii} dx^i \quad (1.121)$$

1.5 Covariant differentiation

In this section we shall briefly introduce some notions concerning the derivatives of objects so far discussed, i.e. vectors and tensors. In order to differentiate these fields the concept of *manifold* is required. However, in this context it will be restricted to a rough and informal description.

A *manifold* is an abstract space locally Euclidean so that, for each point belonging to the manifold, there is a neighborhood that can be described as the Euclidean vector space. When we deal with manifolds, the intuitive idea of vectors obtained by simply subtracting two points in the affine space might no longer be valid. Keep in mind, for instance, a curved surface $Q \in E$, i.e. a two dimensional manifold, and try to define a vector entirely belonging to the surface by subtracting two points. It is easy to see that the vector cannot belong to the curved surface Q .

For this reason we need an additional space named *tangent space* $\bar{T}E$ that allows us to extend the concept of vector spaces so far discussed to manifolds. The tangent space is a Euclidean vector space consisting of the tangent vectors of the curves through the point of the manifold itself.

In order to use tools for computing volume, area and line elements, i.e. to define the metric tensor, we shall suppose that we always deal with differentiable Riemannian manifolds. For a formal mathematical definition see [5].

Given a general coordinate system $X = \{x^i\}$, $i = 1, 2, 3$, let \bar{u} be a vector field $\bar{u} : E \rightarrow \bar{T}E$ and $\tau : E \rightarrow \otimes^k \bar{T}E$ a k -order contravariant tensor, we define the covariant derivative $\nabla_{\bar{u}}\tau$ of the field τ with respect to the field \bar{u} as

$$\nabla_{\bar{u}}\tau = u^j (\partial_j \tau^{i_1 \dots i_k} + \Gamma_{jh}^{i_1} \tau^{hi_2 \dots i_k} + \dots + \Gamma_{jh}^{i_k} \tau^{i_1 \dots i_{k-1} h}) \bar{\partial}_{i_1} \otimes \dots \otimes \bar{\partial}_{i_k} \quad (1.122)$$

Analogously, for a k -order covariant tensor $\tau : E \rightarrow \otimes^k \bar{T}E^*$ the covariant derivative becomes

$$\nabla_{\bar{u}}\tau = u^j (\partial_j \tau_{i_1 \dots i_k} - \Gamma_{j_1}^h \tau_{hi_2 \dots i_k} - \dots - \Gamma_{j_k}^h \tau_{i_1 \dots i_{k-1} h}) \underline{d}^{i_1} \otimes \dots \otimes \underline{d}^{i_k} \quad (1.123)$$

where $\bar{T}E^*$ is the cotangent space, namely the space that contains the dual forms related to the vectors belonging to $\bar{T}E$.

The above expressions are presented only for the sake of completeness, while, the covariant derivative of vector fields and second

order tensors, will be often used in the mechanics of shell continuuums. In fact, for a second order covariant tensor $\tau = \tau^{hk} \bar{\partial}_h \otimes \bar{\partial}_k$ the derivative is

$$\nabla_{\bar{u}} \tau = u^j \left(\partial_j \tau^{hk} + \Gamma_{jt}^h \tau^{tk} + \Gamma_{jt}^k \tau^{ht} \right) \bar{\partial}_h \otimes \bar{\partial}_k \quad (1.124)$$

while, for covariant tensors $\tau = \tau_{hk} \underline{d}^h \otimes \underline{d}^k$ the derivative becomes

$$\nabla_{\bar{u}} \tau = u^j \left(\partial_j \tau_{hk} - \Gamma_{jh}^t \tau_{tk} - \Gamma_{jk}^t \tau_{ht} \right) \underline{d}^h \otimes \underline{d}^k \quad (1.125)$$

and for a mixed tensor $\tau = \tau_k^h \underline{d}^k \otimes \bar{\partial}_h$ the derivative is

$$\nabla_{\bar{u}} \tau = u^j \left(\partial_j \tau_k^h + \Gamma_{jt}^h \tau_k^t - \Gamma_{jk}^t \tau_t^h \right) \underline{d}^k \otimes \bar{\partial}_h \quad (1.126)$$

Finally, for a vector field we have

$$\nabla_{\bar{u}} \bar{v} = u^j \left(\partial_j v^i + \Gamma_{jh}^i v^h \right) \bar{\partial}_i \quad (1.127)$$

and for the dual form

$$\nabla_{\bar{u}} \underline{v} = u^j \left(\partial_j v_i - \Gamma_{ij}^h v_h \right) \underline{d}^i \quad (1.128)$$

1.5.1 Grad, div, curl and Laplace's operator

Gradient. Consider a scalar field $f : E \rightarrow \mathbb{R}$, we define the *gradient* of f as the the vector

$$\text{grad } f = g^{ij} \frac{\partial f}{\partial x^j} \bar{\partial}_i \quad (1.129)$$

In a Cartesian coordinate system the above operator simplifies in the following expression

$$\text{grad } f = \frac{\partial f}{\partial x^i} \bar{e}_i \quad (1.130)$$

Divergence. We define the *divergence* of a vector field \bar{v} as the following scalar

$$\text{div } \bar{v} = \text{tr} (\nabla \bar{v}) = v_{,i}^i + \Gamma_{ij}^i v^j \quad (1.131)$$

In a Cartesian coordinate system the divergence is written as

$$\text{div } \bar{v} = \text{tr} (\nabla \bar{v}) = v_{,i}^i \quad (1.132)$$

Curl. For the sake of simplicity, to define this operator let us denote by ∇ a symbolic operator defined as $\nabla = \frac{\partial}{\partial x^i} \mathbf{d}^i$. Now the *curl* of a vector field \bar{v} can be defined as the following vector

$$\begin{aligned} \text{curl } \bar{v} &= \nabla \times g^b(\bar{v}) = \\ &= \frac{\partial}{\partial x^i} \mathbf{d}^i \times v_j \mathbf{d}^j = \mathbf{d}^i \times \frac{\partial}{\partial x^i} (v_j \mathbf{d}^j) = \eta^{ijk} v_{j|i} \bar{\partial}_k \end{aligned} \quad (1.133)$$

where η^{ijk} is the skew-symmetric tensor related to the vector product (1.111) and $v_{i|j}$ stands for the covariant derivative $v_{i|j} = v_{i,j} - \Gamma_{ij}^h v_h$.

Hence, for a rectangular coordinate system, the curl assumes the straightforward expression

$$\text{curl } \bar{v} = \nabla \times \underline{v} = v_{j,i} \epsilon^{ijk} \bar{e}_k = \bar{\omega} \quad (1.134)$$

where $\bar{\omega} = \omega_k \bar{e}_k$ and $\omega_k = v_{j,i} \epsilon^{ijk}$. Expanding the latter expression leads to the following equivalent form

$$\text{curl } \bar{v} = \det \begin{pmatrix} \bar{e}_1 & \bar{e}_2 & \bar{e}_3 \\ \frac{\partial}{\partial x^1} & \frac{\partial}{\partial x^1} & \frac{\partial}{\partial x^1} \\ v_1 & v_2 & v_3 \end{pmatrix} \quad (1.135)$$

Laplace's operator. We define the *Laplace* operator of a scalar field f the following scalar

$$\nabla^2 f = g^{ij} \left(\partial_i \partial_j f - \Gamma_{ij}^h \partial_h f \right) \quad (1.136)$$

In a rectangular Cartesian coordinate system the Laplacian is written as

$$\nabla^2 f = \frac{\partial^2 f}{\partial x_1^2} + \frac{\partial^2 f}{\partial x_2^2} + \frac{\partial^2 f}{\partial x_3^2} \quad (1.137)$$

A useful remark

For practical uses of the above expressions concerning the differential operators it is necessary to consider a unit system. Attention to this aspect must be especially payed when curvilinear coordinate systems are involved in our computations. For clarity's sake we recall both expressions for a vector

$$\bar{v} = v^i \bar{\partial}_i \quad (1.138)$$

$$\underline{v} = v_i \mathbf{d}^i \quad (1.139)$$

and we point out that vectors (forms) forming the covariant (contravariant) basis $\{\bar{\partial}_i\}$ ($\{\underline{d}^i\}$) are not dimensionless. Hence, the vector components do not represent a physical quantity, even though their geometric properties are correct. So, in order to give vector components a physical meaning a normalization of the basis is required. To this end we introduce the so called **physical basis** $\{\bar{\partial}_{\langle i \rangle}\}$ such as

$$\bar{v} = v^{\langle i \rangle} \bar{\partial}_{\langle i \rangle} \quad (1.140)$$

Next we normalize the covariant basis as follows

$$\bar{\partial}_{\langle i \rangle} = \frac{\bar{\partial}_i}{|\bar{\partial}_i|} = \frac{\bar{\partial}_i}{\sqrt{g_{ii}}} \quad (i \text{ not summed}) \quad (1.141)$$

which, replaced into equation (1.138), allows us to define the **physical components** of \bar{v} as follows

$$v^{\langle i \rangle} = \sqrt{g_{ii}} v^i \quad (i \text{ not summed}) \quad (1.142)$$

On the other hand for the dual basis we have

$$\underline{d}^{\langle i \rangle} = \frac{\bar{d}^i}{\sqrt{g^{ii}}} \quad (i \text{ not summed})$$

$$v_{\langle i \rangle} = v_i \sqrt{g^{ii}} \quad (i \text{ not summed})$$

As an example, in the following we present the expressions of the differential operators discussed in section 1.5.1 for a cylindrical coordinate system.

- Gradient

$$\begin{aligned} \text{grad } f &= g^{\rho\rho} \frac{\partial f}{\partial x^\rho} \bar{\partial}_\rho + g^{\vartheta\vartheta} \frac{\partial f}{\partial x^\vartheta} \bar{\partial}_\vartheta + g^{zz} \frac{\partial f}{\partial x^z} \bar{\partial}_z = \\ &= \frac{\partial f}{\partial x^\rho} \bar{\partial}_\rho + \frac{1}{\rho^2} \frac{\partial f}{\partial x^\vartheta} \bar{\partial}_\vartheta + \frac{\partial f}{\partial x^z} \bar{\partial}_z = \\ &= \frac{\partial f}{\partial x^\rho} \bar{\partial}_{\langle \rho \rangle} + \frac{1}{\rho} \frac{\partial f}{\partial x^\vartheta} \bar{\partial}_{\langle \vartheta \rangle} + \frac{\partial f}{\partial x^z} \bar{\partial}_{\langle z \rangle} \end{aligned}$$

- Divergence

$$\begin{aligned} \text{div } \bar{v} &= \text{tr}(\nabla \bar{v}) = v^{\rho}_{,\rho} + v^{\theta}_{,\theta} + v^z_{,z} + \frac{1}{\rho} v^\rho = \\ &= \frac{1}{\rho} \left(v^{\langle \rho \rangle} + v^{\langle \theta \rangle} \right) + v^{\langle \rho \rangle}_{,\rho} \end{aligned}$$

- Curl

$$\begin{aligned}
 \operatorname{curl} \bar{v} &= \underbrace{\eta^{11k} v_{1|1} \bar{\partial}_k}_{=0} + \eta^{12k} v_{2|1} \bar{\partial}_k + \eta^{13k} v_{3|1} \bar{\partial}_k \\
 &\quad + \eta^{21k} v_{1|2} \bar{\partial}_k + \underbrace{\eta^{22k} v_{2|2} \bar{\partial}_k}_{=0} + \eta^{23k} v_{3|2} \bar{\partial}_k \\
 &\quad + \eta^{31k} v_{1|3} \bar{\partial}_k + \eta^{32k} v_{2|3} \bar{\partial}_k + \underbrace{\eta^{33k} v_{3|3} \bar{\partial}_k}_{=0} = \\
 &= \sqrt{|g^{ij}|} ((v_{3|2} - v_{2|3}) \bar{\partial}_1 + (v_{1|3} - v_{3|1}) \bar{\partial}_2 + (v_{2|1} - v_{1|2}) \bar{\partial}_3)
 \end{aligned}$$

which by making use of the cylindrical notation as stated in section 1.4.3 (i.e. $1 = \rho$, $2 = \vartheta$, $3 = z$), taking into account that $v_{i|j} = v_{i,j}$ due to the symmetry of Christoffel symbols in equation (1.98) and considering the physical components, allows the above expression to become

$$\begin{aligned}
 \operatorname{curl} \bar{v} &= \left(\frac{1}{\rho} v_{\langle z \rangle, \vartheta} - v_{\langle \vartheta \rangle, z} \right) \bar{\partial}_{\langle \rho \rangle} + \\
 &+ (v_{\langle \rho \rangle, z} - v_{\langle z \rangle, \rho}) \bar{\partial}_{\langle \vartheta \rangle} + \frac{1}{\rho} (v_{\langle \vartheta \rangle, \rho} - v_{\langle \rho \rangle, \vartheta}) \bar{\partial}_{\langle z \rangle}
 \end{aligned}$$

- Laplacian

$$\nabla^2 f = \frac{\partial^2 f}{\partial \rho^2} + \frac{1}{\rho^2} \frac{\partial^2 f}{\partial \vartheta^2} + \frac{\partial^2 f}{\partial z^2} + \frac{1}{\rho} \frac{\partial f}{\partial \rho}$$

Note that in the latter expression no normalization has been used.

The divergence theorem

Consider a generic region $\mathcal{V} \subset E$ bounded by the smooth closed surface \mathcal{S} . Given a continuously differentiable vector field $\bar{v} \in \mathcal{V}$, we have

$$\int_{\mathcal{V}} \operatorname{div} \bar{v} \, d\mathcal{V} = \int_{\mathcal{S}} \bar{v} \cdot \bar{n} \, dS \quad (1.143)$$

where \bar{n} is the outward pointing unit normal vector of the boundary \mathcal{S} .

In components the above theorem becomes

$$\int_{\mathcal{V}} \left(v^j_{,j} + \Gamma^j_{jh} v^h \right) d\mathcal{V} = \int_{\mathcal{S}} v^i n_i dS \quad (1.144)$$

The divergence theorem holds for tensor fields. For a mixed II-order tensor $\tau = \tau_k^h (\mathfrak{d}^k \otimes \bar{\partial}_h)$, for example, the theorem states

$$\int_{\mathcal{V}} \operatorname{div} \tau d\mathcal{V} = \int_{\mathcal{S}} \tau(\underline{n}) dS \quad (1.145)$$

where the k -th covariant component is

$$\int_{\mathcal{V}} \left(\tau_{k,h}^h + \Gamma_{ht}^h \tau_k^t - \Gamma_{hk}^t \tau_t^h \right) d\mathcal{V} = \int_{\mathcal{S}} \tau_k^h n_h dS \quad (1.146)$$

While for a II-order contravariant tensor $\tau = \tau^{hk} (\bar{\partial}_h \otimes \bar{\partial}_k)$ it becomes

$$\int_{\mathcal{V}} \left(\tau_{,h}^{hk} + \Gamma_{ht}^h \tau^{tk} + \Gamma_{ht}^k \tau^{ht} \right) d\mathcal{V} = \int_{\mathcal{S}} \tau^{hk} n_h dS \quad (1.147)$$

1.6 Affine space

Here we shortly introduce the notion of *affine space*.

Let \bar{E} be a n -dimensional vector space. We define the *affine space* associated to \bar{E} the set of *points* E equipped with the *translation* $+$, such as

$$+ : E \times \bar{E} \rightarrow E : (p, \bar{u}) \mapsto p + \bar{u} = p' \in E \quad (1.148)$$

where $\bar{u} = (p' - p) \in \bar{E}$ represents a *free vector*, while the pairs (p, \bar{u}) form applied vectors.

1.6.1 Free and applied vectors

This section is restricted to the geometrical interpretation of vectors belonging to the Euclidean space and expressed through the rectangular coordinate system. So that we have

$$g_{ij} = g^{ij} = g_j^i = \delta_{ij} \quad (1.149)$$

and

$$\eta_{ijk} = \epsilon_{ijk} \quad (1.150)$$

From a geometric point of view an applied vector is represented by a line segment \overrightarrow{AB} from point A to point B , where, with respect to equation (1.148), $A = p$ and $B = p'$. If B is moved to the position C , then the whole translation from A to C represents the sum of the partial translations \overrightarrow{AB} and \overrightarrow{BC} .

Putting $\overrightarrow{AB} = \bar{a}$ and $\overrightarrow{BC} = \bar{b}$ we notice that if they were applied in the same point, see figure 1.4, then a practical rule can be used to carry out the addition $\bar{a} + \bar{b}$. It consists in moving the vector \bar{b} , in such a way to be kept parallel to itself, into a new position so that its starting point coincides with the ending point of \bar{a} . Thus, the line segment from A to the end point of \bar{b} (in the new position) represents the addition $\bar{a} + \bar{b}$. See figure 1.4. This rule is known as *parallelogram rule* because \bar{a} and \bar{b} form the sides of a parallelogram and $\bar{a} + \bar{b}$ is one of the diagonals.

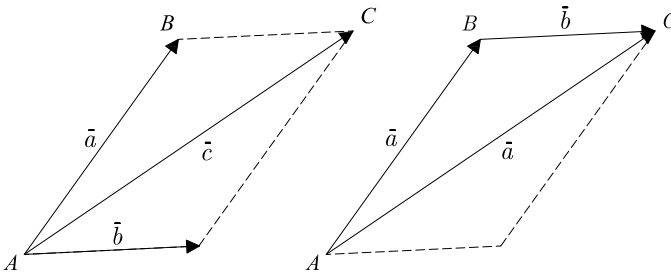

Figure 1.4: Addition of two applied vectors.

The subtraction of two vectors applied in the same point can be seen as $\bar{c} = \bar{a} + (-\bar{b})$ and so it is carried out by means of the procedure described for the addition. The vector $\bar{c} = \bar{a} - \bar{b}$ will be given by the line joining the starting point of \bar{a} to the end point of $-\bar{b}$. See figure 1.5.

The addition of two applied vectors has the following properties

1. $\bar{a} + \bar{b} = \bar{b} + \bar{a}$;
2. $(\bar{a} + \bar{b}) + \bar{c} = \bar{a} + (\bar{b} + \bar{c})$;
3. $(\lambda + \mu)\bar{a} = \lambda\bar{a} + \mu\bar{a}$;
4. $\lambda(\mu\bar{a}) = (\lambda\mu)\bar{a}$;
5. $\lambda(\bar{a} + \bar{b}) = \lambda\bar{a} + \lambda\bar{b}$;

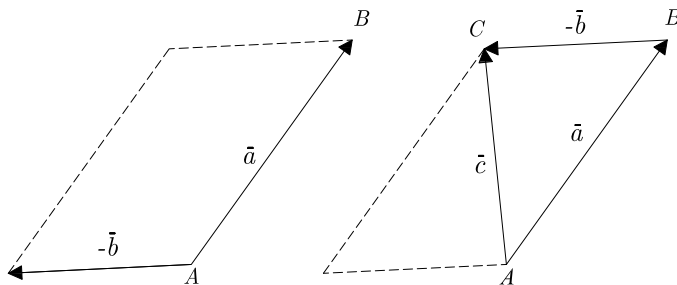

Figure 1.5: Subtraction of two applied vectors.

where $\bar{a}, \bar{b}, \bar{c}$ are applied vectors in \bar{E} and $\lambda, \mu \in \mathbb{R}$.

For an applied vector it is possible to define *norm*, *direction*, *sign*:

norm (modulus or length): is the length, measured by a fixed unit system, of the line segment \overrightarrow{AB} ;

direction: is the direction of the line passing through A and B ;

sign: specifies the sign, i.e. $\overrightarrow{AB} = -\overrightarrow{BA}$.

From the preceding discussion about the metric tensor it is known that the length (modulus) of a vector \bar{a} ($= \overrightarrow{AB}$) is the square root of the scalar product by itself

$$\|\bar{a}\| = \sqrt{g(\bar{a}, \bar{a})} = \sqrt{\bar{a} \cdot \bar{a}} \quad (1.151)$$

Recalling that the metric tensor is a bilinear symmetric positive definite form, the following properties can be derived

1. $\bar{a} \cdot \bar{a} = \|\bar{a}\|^2 > 0$ se $\bar{a} \neq \bar{0}$;
2. $\bar{a} \cdot \bar{b} = \bar{b} \cdot \bar{a}$;
3. $\bar{c} \cdot (\bar{a} + \bar{b}) = \bar{c} \cdot \bar{a} + \bar{c} \cdot \bar{b}$;
4. $\lambda (\bar{a} \cdot \bar{b}) = (\lambda \bar{a}) \cdot \bar{b} = \bar{a} \cdot (\lambda \bar{b})$;

The cross product of two applied vectors $\bar{a}, \bar{b} \in \bar{E}$ in a Cartesian coordinate system is carried out by using the general rule given in equation (1.110), so that

$$\bar{w} = \bar{a} \times \bar{b} \quad \bar{w} \in \bar{V} \quad (1.152)$$

where

modulus: $\|\bar{w}\| = \|\bar{a}\| \|\bar{b}\| \sin \theta$, where θ denotes the angle between \bar{a} and \bar{b} ;

direction: normal to the plane to which \bar{a} and \bar{b} belong;

sign: follows the right hand rule.

Moreover, by virtue of the skew-symmetric tensor ϵ_{ijk} , the vector product vanishes when either one of the two vectors vanishes or when the two vectors are parallel. See figure 1.6.

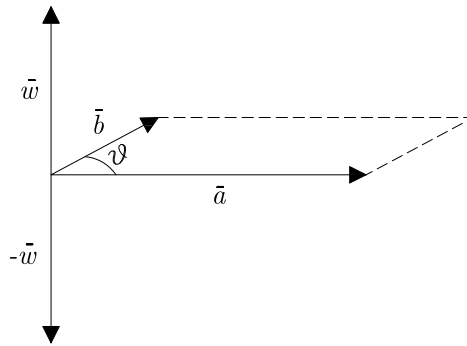

Figure 1.6: Vector product for Cartesian applied vectors.

The following properties can be also enunciated

1. $\bar{a} \times \bar{b} = -\bar{b} \times \bar{a}$;
2. $(\lambda \bar{a} + \mu \bar{b}) \times \bar{c} = \lambda (\bar{a} \times \bar{c}) + \mu (\bar{b} \times \bar{c})$.

1.7 Surfaces

Let E be the affine Euclidean space. The submanifold $Q \subset E$ is a surface if $\dim Q = 2$.

Suppose $Q \subset E$ is a surface which can be described by an induced coordinate system of dimension $q = m - k$, where m is the dimension of E and k denotes the number of constraints (codimension of Q). Since Q is a surface we have $m = 3$, $k = 1$, $q = 2$. The induced coordinate system is given by

$$X^\dagger : Q \rightarrow \mathbb{R}^q : p \mapsto x^\alpha(p) \quad (1.153)$$

From now on the quantities living on Q will be distinguished by the symbol \dagger and the components will be written using superscripts and subscripts, running from 1 to 2, in Greek letters. The Latin indices will denote components of quantities that are applied on Q but lie out, namely belonging to the vector space $T\bar{Q}E$.

The unit normal vector is defined as follows

$$\bar{n} : Q \rightarrow T\bar{Q}^\perp \text{ so that } g(\bar{n}, \bar{n}) = 1. \quad (1.154)$$

where g is the metric tensor defined on $T\bar{E}$ and $T\bar{Q}^\perp$ is the orthogonal space.

Analogously, on the surface Q we can define the induced metric as

$$g^\dagger : T\bar{Q} \times T\bar{Q} \rightarrow \mathbb{R}$$

that in components³ becomes

$$g^\dagger = g_{\alpha\beta} \mathbf{d}^\alpha \otimes \mathbf{d}^\beta$$

Given two vectorial fields $\bar{u} : Q \rightarrow T\bar{Q}$ and $\bar{v} : Q \rightarrow T\bar{Q}$, the covariant derivative of \bar{v} with respect to \bar{u} can be split as follows

$$\nabla_{\bar{u}} \bar{v} = \nabla_{\bar{u}}^\parallel \bar{v} + \nabla_{\bar{u}}^\perp \bar{v} \quad (1.155)$$

where

$$\nabla^\parallel : T\bar{Q} \times T\bar{Q} \rightarrow T\bar{Q} \quad (1.156)$$

$$\nabla^\perp : T\bar{Q} \times T\bar{Q} \rightarrow T\bar{Q}^\perp \quad (1.157)$$

The application ∇^\parallel is called *second fundamental form* of the surface. For further details see [5] and [3].

We now define the *Weingarten*⁴ map L as the following endomorphism

$$L := \nabla \bar{n} : T\bar{Q} \rightarrow T\bar{Q} : \bar{u} \mapsto \nabla_{\bar{u}} \bar{n} \quad (1.158)$$

³In some books the covariant components of the metric tensor g^\dagger are also denoted as $g_{11} = E$, $g_{12} = F$, $g_{22} = G$.

⁴Julius Weingarten (March 2, 1836 Berlin - June 16, 1910 Freiburg) was a German mathematician.



In addition to that, we define the *total curvature* (*Gauss curvature*) K and the *mean curvature* H of a surface Q as follows

$$K := \det L : Q \rightarrow \mathbb{R} \quad (1.159)$$

$$H := \operatorname{tr} L : Q \rightarrow \mathbb{R} \quad (1.160)$$

Finally, eigenvalues of L are defined *principal curvatures*. See [5].

Let \underline{L} be the second order covariant tensor related to the Weingarten endomorphism L by the metric tensor g^\dagger , so that

$$\underline{L} := \nabla_{\underline{n}} : T\bar{Q} \times T\bar{Q} \rightarrow \mathbb{R} : (\bar{u}, \bar{v}) \mapsto g(L(\bar{u}), \bar{v}) = \nabla_{\bar{u}} \bar{n} \cdot \bar{v} \quad (1.161)$$

where $\underline{n} = g^\flat(\bar{n})$.

The following differentiation

$$0 = \nabla_{\bar{u}}(g(\bar{v}, \bar{n})) = g(\nabla_{\bar{u}} \bar{v}, \bar{n}) + g(\bar{v}, \nabla_{\bar{u}} \bar{n}) \Rightarrow \quad (1.162)$$

$$g(\nabla_{\bar{u}} \bar{v}, \bar{n}) = -g(\bar{v}, \nabla_{\bar{u}} \bar{n}) \quad (1.163)$$

proves that the scalar quantity $\underline{L}(\bar{u}, \bar{v})$ represents the normal component to the surface Q of the covariant derivative, namely

$$\nabla_{\bar{u}} \bar{v} = \nabla_{\bar{u}}^{\parallel} \bar{v} - \underline{L}(\bar{u}, \bar{v}) \bar{n} \quad (1.164)$$

Dealing with mechanics of shell continuums, equation (1.164) will be often used. Hence, in the following we expand its expression in components.

Suppose $\{\bar{\partial}_\alpha\}$, $\alpha = 1, 2$ is a basis related to the induced coordinate system describing the surface, we have

$$\nabla_{\bar{\partial}_\beta} \bar{\partial}_\alpha = \nabla_{\bar{\partial}_\beta}^\dagger \bar{\partial}_\alpha - \underline{L}(\bar{\partial}_\beta, \bar{\partial}_\alpha) \bar{n} \quad (1.165)$$

and for both right hand terms we have, respectively

$$\nabla_{\bar{\partial}_\beta}^\dagger \bar{\partial}_\alpha = \underline{d}^\gamma(\bar{\partial}_\beta) \left(\partial_\gamma(\underline{d}^\omega(\bar{\partial}_\alpha)) + \Gamma_{\gamma\lambda}^\omega \underline{d}^\lambda(\bar{\partial}_\alpha) \right) \bar{\partial}_\omega \quad (1.166)$$

$$= \delta_\beta^\gamma \left(\Gamma_{\gamma\lambda}^\omega \delta_\alpha^\lambda \right) \bar{\partial}_\omega = \Gamma_{\beta\alpha}^\omega \bar{\partial}_\omega \quad (1.167)$$

$$\underline{L}(\bar{\partial}_\beta, \bar{\partial}_\alpha) = (L(\bar{\partial}_\beta) \cdot \bar{\partial}_\alpha) = \nabla_{\bar{\partial}_\beta} \bar{n} \cdot \bar{\partial}_\alpha \quad (1.168)$$

$$= L_{\beta\alpha}^\omega \bar{\partial}_\omega \cdot \bar{\partial}_\alpha = L_{\beta\alpha}^\omega g_{\omega\alpha} = L_{\beta\alpha} \quad (1.169)$$

Finally, equation (1.165) in components becomes

$$\nabla_{\beta}\bar{\partial}_{\alpha} = \Gamma_{\beta\alpha}^{\omega}\bar{\partial}_{\omega} - L_{\beta\alpha}\bar{n} \quad (1.170)$$

Note that in the remainder of this book, for the sake of brevity, we will use $\nabla_{\beta}\cdot$ instead of $\nabla_{\bar{\partial}_{\beta}}\cdot$.

Analogously, for an element of the contravariant basis, recalling the general equation for covariant derivatives, and considering the above Gauss splitting, we have the following expression

$$\nabla_{\beta}\bar{\mathbf{d}}^{\alpha} = -\Gamma_{\beta\lambda}^{\alpha}\bar{\mathbf{d}}^{\lambda} - L_{\beta}^{\alpha}\bar{\mathbf{n}} \quad (1.171)$$

Often, for instance in the case of shell theory, we will deal with vector fields that do not belong to the tangent space, so it is useful to present an example of derivative of vectors applied in Q but lying out of the tangent space. Namely, suppose that $\bar{\mathbf{v}} \in T_Q^*E$. We can decompose the field $\bar{\mathbf{v}}$ into the tangent and orthogonal component as follows

$$\bar{\mathbf{v}} = \bar{\mathbf{v}}^{\parallel} + \bar{\mathbf{v}}^{\perp} \quad (1.172)$$

that in components is written as

$$\bar{\mathbf{v}} = v^{\alpha}\bar{\partial}_{\alpha} + v^{\xi}\bar{\mathbf{n}} \quad (1.173)$$

Hence, given $\bar{\mathbf{u}} \in T_Q^*E$ the derivative of $\bar{\mathbf{v}}$ with respect to $\bar{\mathbf{u}}$ is

$$\nabla_{\bar{\mathbf{u}}}\bar{\mathbf{v}} = \nabla_{\bar{\mathbf{u}}}\bar{\mathbf{v}}^{\parallel} + \nabla_{\bar{\mathbf{u}}}\bar{\mathbf{v}}^{\perp} = \nabla_{\bar{\mathbf{u}}}^{\dagger}\bar{\mathbf{v}}^{\parallel} - \underline{L}(\bar{\mathbf{u}}, \bar{\mathbf{v}}^{\parallel})\bar{\mathbf{n}} + \nabla_{\bar{\mathbf{u}}}\bar{\mathbf{v}}^{\perp} \quad (1.174)$$

that in components turns into

$$\nabla_{\bar{\mathbf{u}}}\bar{\mathbf{v}} = u^{\beta}\left(\partial_{\beta}v^{\alpha} + \Gamma_{\beta\gamma}^{\alpha}v^{\gamma} + v^{\xi}L_{\beta}^{\alpha}\right)\bar{\partial}_{\alpha} + u^{\beta}\left(v_{,\beta}^{\xi} - L_{\alpha\beta}v^{\alpha}\right)\bar{\mathbf{n}} \quad (1.175)$$

In the same way, the dual form $\underline{\mathbf{v}} \in T_Q^*E$ can be differentiated as follows

$$\nabla_{\bar{\mathbf{u}}}\underline{\mathbf{v}} = \nabla_{\bar{\mathbf{u}}}\underline{\mathbf{v}}^{\parallel} + \nabla_{\bar{\mathbf{u}}}\underline{\mathbf{v}}^{\perp} = \nabla_{\bar{\mathbf{u}}}^{\dagger}\underline{\mathbf{v}}^{\parallel} - \underline{L}(\bar{\mathbf{u}}, \underline{\mathbf{v}}^{\parallel})\bar{\mathbf{n}} + \nabla_{\bar{\mathbf{u}}}\underline{\mathbf{v}}^{\perp} \quad (1.176)$$

that in components becomes

$$\nabla_{\bar{\mathbf{u}}}\underline{\mathbf{v}} = u^{\beta}\left(\partial_{\beta}v_{\alpha} - \Gamma_{\alpha\beta}^{\gamma}v_{\gamma} + v_{\xi}L_{\beta\gamma}\right)\bar{\mathbf{d}}^{\gamma} + u^{\beta}\left(v_{\xi,\beta} - L_{\beta}^{\alpha}v_{\alpha}\right)\bar{\mathbf{n}} \quad (1.177)$$

Examples of surfaces will be provided in appendix A, where, within the application of the shell theory, the above results will be applied to some well known geometries.

Chapter 2

Analysis of strain

This chapter is devoted to the classical strain theory for deformable continuums. In order to offer a comprehensive approach, the first part will be treated in curvilinear coordinates, then results in Cartesian coordinates will be obtained as a special case.

2.1 Introduction

Before introducing the definition of strain it is useful to give some preliminary concepts and definitions.

Let us begin with the definition of *body*.

A *body* $\mathcal{C} \subset E$ consists of a set of particles embedded in the three-dimensional Euclidean space. Each particle $p \in \mathcal{C}$, i.e. a material point, can be put in one-to-one correspondence with a triplet of scalars that univocally determine the position of such a point. Namely, for any point p included in the body there exists a coordinate system $X : \mathcal{C} \subset E \rightarrow \mathbb{R}^3$. See also the more general expression (1.60) on section 1.4.

From the notions of body and time we can derive the concept *configuration*. Configurations are regions \mathcal{V} of the three-dimensional Euclidean space E that can be occupied by the body in a particular instant. Thus we have

$$\mathcal{V} \equiv (\mathcal{C}, t) = \{(p, t) | p \in \mathcal{C}\} \quad (2.1)$$

where \mathcal{V} is also called a *spacial domain* for fixed t .

It is assumed that:

- *Configurations* are open connected sets or domains in the Euclidean space.
- On varying of the *time* t , the configurations of one and the same body maintain a continuous one-to-one correspondence between different positions of one and the same particle.

2.2 Deformation

Now, beginning with an intuitive statement, we can introduce the definition of *strain*. When the relative position of two points included in a continuous media is altered, we say that the body is strained. Hence, *analysis of strains* means to evaluate the change of the relative distance between points; this is also called *deformation*¹.

2.3 Strain tensor in general coordinates

Let \mathcal{V} be the region taken by an unstrained state of a body at time t , so that

$$\mathcal{V} \equiv (\mathcal{C}, t) \quad (2.2)$$

and \mathcal{V}' the configuration of the body in the strained state at instant t' , that is

$$\mathcal{V}' \equiv (\mathcal{C}, t') \quad (2.3)$$

Consider a Cartesian coordinate system equipped with the unit normal basis $\{\bar{e}_i\}$, so that for any point p in \mathcal{V} and p' in \mathcal{V}' the positional vectors can be written respectively as

$$\bar{r} = (p - o) = x_c^i \bar{e}_i \quad (2.4)$$

$$\bar{r}' = (p' - o) = y_c^i \bar{e}_i \quad (2.5)$$

We assume that each point in \mathcal{V}' is related to its original position in \mathcal{V} , and vice versa, by the following relations

$$y_c^i = y_c^i(x_c^1, x_c^2, x_c^3, t) \quad (2.6)$$

$$x_c^i = x_c^i(y_c^1, y_c^2, y_c^3, t) \quad (2.7)$$

In order to avoid penetrations or separations of the material particles it is necessary that the transformation of points in \mathcal{V} into points in \mathcal{V}' is one-to-one. Namely, to ensure the existence of the single-valued inverse of equation (2.6) (or (2.7)) it is sufficient to

¹We know that in nature all materials are deformable, but sometimes we will refer to the abstraction of *non-deformable* (or *rigid*) *body*. This abstraction assumes that for every pair of points belonging to the continuum, the relative distance remains unvaried throughout the history of the motion.

assume that the functions y_c^i and x_c^i are continuous and differentiable as many times as required and the Jacobian is greater than zero². We write, accordingly

$$\left| \frac{\partial y_c^i}{\partial x_c^j} \right| > 0$$

Consider now a generic curvilinear coordinates system $X = \{x^i\}$ so that

$$\bar{r} = x^i \bar{\partial}_i = x_i \underline{d}^i \quad (2.8)$$

where $\{\bar{\partial}_i\}$ and $\{\underline{d}^i\}$ are the covariant and contravariant bases related to the curvilinear system and $x^i = r^i$, $r_i = x_i$. See figure 2.1.

Points belonging to the initial configuration \mathcal{V} can also be related to the curvilinear system of coordinates as follows

$$x_c^i = x_c^i(x^1, x^2, x^3) \quad (2.9)$$

where x_c^i are single-valued and differentiable as many times as required³.

Moreover, we can use the curvilinear coordinates to describe the body in the strained configuration \mathcal{V}' , so that

$$y_c^i = y_c^i(x^1, x^2, x^3) \quad (2.10)$$

According to section 1.4.2, through the Jacobian matrices, we can compute the metric tensors g and g' associated to the curvilinear coordinate system for both configurations, respectively.

For the unstrained configuration the covariant components of the metric tensor are

$$g_{ij} = \bar{\partial}_i \cdot \bar{\partial}_j = \frac{\partial x_c^h}{\partial x^i} \bar{e}_h \cdot \frac{\partial x_c^k}{\partial x^j} \bar{e}_k = \quad (2.11)$$

$$= \frac{\partial x_c^h}{\partial x^i} \frac{\partial x_c^k}{\partial x^j} \delta_{hk} = \frac{\partial x_c^h}{\partial x^i} \frac{\partial x_c^h}{\partial x^j} \quad (2.12)$$

²The Jacobian of the function $y_c^i = y_c^i(x^j)$ is the determinant of the matrix whose i - th row lists all the first-order partial derivatives of y_c^i .

³With the exception of singular points, curves, surfaces.

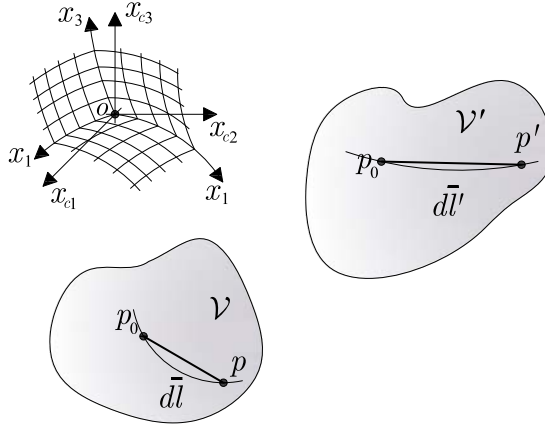

Figure 2.1: Unstrained and strained body states.

while the contravariant components are

$$g^{ij} = \mathbf{d}^i \cdot \mathbf{d}^j = \frac{\partial x^i}{\partial x_c^h} \mathbf{e}^h \cdot \frac{\partial x^j}{\partial x_c^k} \mathbf{e}^k = \quad (2.13)$$

$$= \frac{\partial x^i}{\partial x_c^h} \frac{\partial x^j}{\partial x_c^k} \delta^{hk} = \frac{\partial x^i}{\partial x_c^h} \frac{\partial x^j}{\partial x_c^h} \quad (2.14)$$

and finally the mixed components are

$$g_j^i = \mathbf{d}^i (\bar{\partial}_j) = \frac{\partial x^i}{\partial x_c^h} \mathbf{e}^h \cdot \frac{\partial x_c^k}{\partial x^j} \bar{\mathbf{e}}_k = \quad (2.15)$$

$$= \frac{\partial x^i}{\partial x_c^h} \frac{\partial x_c^k}{\partial x^j} \delta_k^h = \frac{\partial x^i}{\partial x_c^h} \frac{\partial x_c^h}{\partial x^j} \quad (2.16)$$

For the strained configuration the covariant components of the metric tensor are

$$g'_{ij} = \bar{\partial}_i \cdot \bar{\partial}_j = \frac{\partial y_c^h}{\partial x^i} \bar{\mathbf{e}}_h \cdot \frac{\partial y_c^k}{\partial x^j} \bar{\mathbf{e}}_k = \quad (2.17)$$

$$= \frac{\partial y_c^h}{\partial x^i} \frac{\partial y_c^k}{\partial x^j} \delta_{hk} = \frac{\partial y_c^h}{\partial x^i} \frac{\partial y_c^h}{\partial x^j} \quad (2.18)$$

the contravariant components are

$$g'^{ij} = \mathbf{d}'^i \cdot \mathbf{d}'^j = \frac{\partial x^i}{\partial y_c^h} \mathbf{e}^h \cdot \frac{\partial x^j}{\partial y_c^k} \mathbf{e}^k = \quad (2.19)$$

$$= \frac{\partial x^i}{\partial y_c^h} \frac{\partial x^j}{\partial y_c^k} \delta^{hk} = \frac{\partial x^i}{\partial y_c^h} \frac{\partial x^j}{\partial y_c^h} \quad (2.20)$$

and finally the mixed components are

$$g_j^i = \underline{d}^i (\bar{\partial}_j) = \frac{\partial x^i}{\partial y_c^h} e^h \cdot \frac{\partial y_c^k}{\partial x^j} \bar{e}_k = \quad (2.21)$$

$$= \frac{\partial x^i}{\partial y_c^h} \frac{\partial y_c^k}{\partial x^j} \delta_k^h = \frac{\partial x^i}{\partial y_c^h} \frac{\partial y_c^h}{\partial x^j} \quad (2.22)$$

At the beginning of this chapter we said that the aim of the analysis of strain is to evaluate the change of length between two points in a continuous medium. We are now mathematically able to evaluate this difference

$$dl'^2 - dl^2 \quad (2.23)$$

where $dl'^2 = |d\bar{l}'|^2$ and $dl^2 = |d\bar{l}|^2$ are the arc lengths of the strained and unstrained states, respectively. Namely, the vector $d\bar{l}$, joining the points p_0 and p , during the the transformation, is carried into another vector $d\bar{l}'$. These two vectors differ in direction and magnitude. See figure 2.2.

By using equation (1.119) on page 23, we can write the above line elements with the help of the metric tensors for both configurations as

$$dl^2 = g_{ij} dx^i dx^j \quad (2.24)$$

$$dl'^2 = g'_{ij} dx^i dx^j \quad (2.25)$$

then, the difference

$$dl'^2 - dl^2 = (g'_{ij} - g_{ij}) dx^i dx^j \quad (2.26)$$

We now define a symmetric tensor named the *strain tensor*, as

$$\gamma_{ij} = \frac{1}{2} (g'_{ij} - g_{ij}) \quad (2.27)$$

so that

$$dl'^2 - dl^2 = 2\gamma_{ij} dx^i dx^j \quad (2.28)$$

The strain tensor is obtained by subtracting two bilinear forms so that it is still a bilinear form. Therefore, given two vectors \bar{p}_0 and \bar{q}_0 at a fixed time t_0 (let us say the initial unstrained state), the strain tensor just measures the difference between the scalar

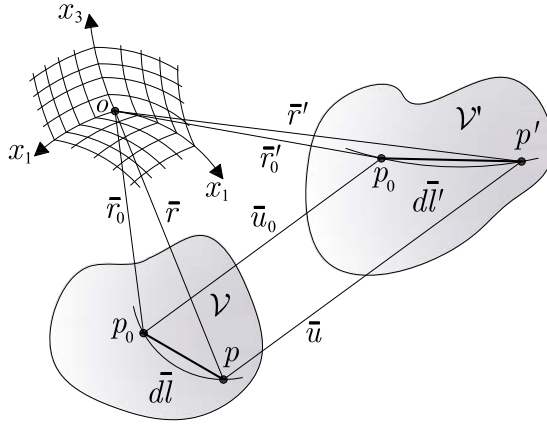

Figure 2.2: Measure of strain.

product of the vectors \bar{p} and \bar{q} at a generic time t (that identifies the strained state) and the scalar product at the initial state.

$$\gamma : \bar{E} \times \bar{E} \rightarrow \mathbb{R} \quad (2.29)$$

$$(\bar{p}, \bar{q}) \mapsto \gamma(\bar{p}, \bar{q}) = g'(\bar{p}, \bar{q}) - g(\bar{p}, \bar{q}) \quad (2.30)$$

so that

$$\begin{aligned} \gamma(\bar{p}, \bar{q}) &= p^h q^k \gamma_{ij} (\underline{d}^i \otimes \underline{d}^j) (\bar{\delta}_h, \bar{\delta}_k) = \\ &= p^h q^k \gamma_{ij} \delta_h^i \delta_k^j = \gamma_{ij} p^i q^j. \end{aligned} \quad (2.31)$$

Points in \mathcal{V} and \mathcal{V}' are univocally determined by the positional vectors \bar{r} and \bar{r}' respectively. With respect to the generic curvilinear coordinate system X we have

$$\bar{r} = x^i \bar{\partial}_i \quad (2.32)$$

$$\bar{r}' = y^i \bar{\partial}_i \quad (2.33)$$

hence, the position p' relative to p is denoted \bar{u} and it is called the displacement vector

$$\bar{u} = \bar{r}' - \bar{r} \quad (2.34)$$

Considering now that the basis related to the curvilinear coordinates is given using equation (1.76), we have in the following an

equivalent expression

$$\bar{\partial}_i = \frac{\partial \bar{r}}{\partial x^i} \quad (2.35)$$

$$\bar{\partial}'_i = \frac{\partial \bar{r}'}{\partial x^i} \quad (2.36)$$

and by considering the relation (2.34) it becomes

$$\bar{\partial}'_i = \bar{r}'_{,i} = \bar{r}_{,i} + \nabla_i \bar{u} \quad (2.37)$$

where the comma denotes the partial derivative and ∇ indicates the covariant derivative.

$$\gamma_{ij} = \frac{1}{2} (\bar{\partial}'_i \cdot \bar{\partial}'_j - \bar{\partial}_i \cdot \bar{\partial}_j) = \quad (2.38)$$

$$= \frac{1}{2} ((\bar{\partial}_i + \nabla_i \bar{u}) \cdot (\bar{\partial}_j + \nabla_j \bar{u}) - \bar{\partial}_i \cdot \bar{\partial}_j) = \quad (2.39)$$

$$= \frac{1}{2} (\bar{\partial}_i \cdot \nabla_j \bar{u} + \bar{\partial}_j \cdot \nabla_i \bar{u} + \nabla_i \bar{u} \cdot \nabla_j \bar{u}) \quad (2.40)$$

In fact, recalling the general expression (1.122) for this differentiation, the above equation turns into

$$\bar{\partial}'_i = \bar{r}'_{,i} = \bar{\partial}_i + \left(u^m_{,i} + \Gamma_{ih}^m u^h \right) \bar{\partial}_m \quad (2.41)$$

where the Christoffel symbols are referred to the metric tensor related to the curvilinear coordinates for the original configuration \mathcal{V} of the body.

Finally, using the definition of strain tensor, with some calculations we can obtain the expression of the *finite strain tensor* in general coordinates as

$$\gamma_{ij} = \frac{1}{2} \left(\nabla_j u^i + \nabla_i u^j + \nabla_i u^h \nabla_j u^h \right) \quad (2.42)$$

Expanding the above derivatives the strain tensor assumes the following expression

$$\begin{aligned} \gamma_{ij} = & \frac{1}{2} \left(u_{i,j} + u_{j,i} + 2\Gamma_{ji}^h u_h \right) + \\ & \frac{1}{2} \left(u_{k,i} u^k_{,j} + u_{k,i} \Gamma_{js}^k u^s + u_{k,j} \Gamma_{is}^k u^s + \Gamma_{ih}^p u_p \Gamma_{js}^h u^s \right) \end{aligned} \quad (2.43)$$

For Cartesian coordinate systems we could repeat exactly the above procedure to obtain the strain tensor, but this is equivalent to putting zero all the Christoffel symbols in equation (2.43). So that for rectangular coordinate systems the strain tensor assumes the following expression

$$\gamma_{ij} = \frac{1}{2} (u_{i,j} + u_{j,i} + u_{k,i}u_{k,j}) \quad (2.44)$$

where we remind the reader again that in the rectangular coordinates the position of the indices does not make any difference because $g_{ij} = \delta_{ij}$.

2.3.1 Examples of strain in Cartesian coordinates

Stretching ratio

Let us define the stretching ratio δ_l as follows

$$\delta_l = \frac{dl' - dl}{dl} = \frac{dl'}{dl} - 1 \quad (2.45)$$

Namely, suppose we have two points in the unstrained state the difference of which gives a vector $d\bar{l} = dx^i \bar{e}_i$. The corresponding vector in the strained state is $d\bar{l}' = dx'^i \bar{e}'_i$. Therefore the *stretching ratio* δ_l gives the relative difference between the length of the vectors $d\bar{l}$ and $d\bar{l}'$.

By means of the definition (2.28) we have

$$2 \frac{\gamma_{ij} dx^i dx^j}{dx^k dx^k} = \frac{dl'^2}{dl^2} - 1 \quad (2.46)$$

then

$$\delta_l + 1 = \sqrt{1 + 2 \frac{\gamma_{ij} dx^i dx^j}{dx^k dx^k}} \quad (2.47)$$

so that the stretching ratio can be written as follows

$$\delta_l = \sqrt{1 + 2 \frac{\gamma_{ij} dx^i dx^j}{dx^k dx^k}} - 1 \quad (2.48)$$

Considering a simple extension along one of the x_i -axis we have $d\bar{l} = \bar{e}_i$, the stretching turns into

$$\delta_i = \sqrt{1 + 2\gamma_{ii}} - 1 \quad (2.49)$$

Angular dilatation

Let us consider the vectors $\bar{d}\bar{l}$ and $d\bar{s}$ at a position p in the unstrained state which are deformed into vectors $d\bar{l}'$ and $d\bar{s}'$, respectively. The difference between the angle amid the deformed vectors and the unstrained vectors is called *angular dilatation*. For the sake of simplicity, suppose that $\bar{d}\bar{l} = \bar{e}_1$ and $d\bar{s} = \bar{e}_2$. We define the *angular dilatation* the following difference

$$\omega_{12} = \frac{\pi}{2} - \varphi'_{12} \quad (2.50)$$

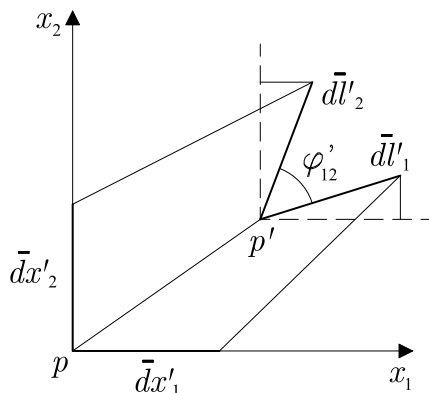

Figure 2.3: Angular dilatation.

See figure 2.3.

The scalar product of the strained vectors is

$$d\bar{l}' \cdot d\bar{s}' = dl' ds' \cos \varphi'_{12} \quad (2.51)$$

and the modulus of both strained vectors can be written by means of the preceding result for the linear dilatation

$$dl' = (1 + \delta_1) dl = 1 + \delta_1 \quad (2.52)$$

$$ds' = (1 + \delta_2) ds = 1 + \delta_2 \quad (2.53)$$

so that equation (2.51) becomes

$$d\bar{l}' \cdot d\bar{s}' = (1 + \delta_1)(1 + \delta_2) \cos \varphi'_{12} \quad (2.54)$$

The left hand term of the latter expression can be written with the help of the strain tensor, so that by recalling equation (2.27) we have

$$d\bar{l}' \cdot d\bar{s}' = (\delta_{ij} + 2\gamma_{ij}) dl^i ds^j = 2\gamma_{12} \quad (2.55)$$

Finally equation (2.54) turns into

$$2\gamma_{12} = (1 + \delta_1)(1 + \delta_2) \cos \varphi'_{12} \quad (2.56)$$

By virtue of the identity $\sin \omega_{12} = \cos \varphi_{12}$, the angular dilatation becomes

$$\sin \omega_{12} = \frac{2\gamma_{12}}{(1 + \delta_1)(1 + \delta_2)} \quad (2.57)$$

and naturally the above formula can be used to compute also the dilatations ω_{23} and ω_{31} .

Area dilatation

Vectors $d\bar{l}$ and $d\bar{s}$ at a position p in the unstrained state define an area element dA which is deformed into the area element dA' defined by the strained vectors $d\bar{l}'$ and $d\bar{s}'$. We define the *area dilatation ratio* the following coefficient

$$\alpha = \frac{dA' - dA}{dA} \quad (2.58)$$

We may suppose for simplicity that $d\bar{l} = \bar{e}_1$ and $d\bar{s} = \bar{e}_2$. See figure 2.4.

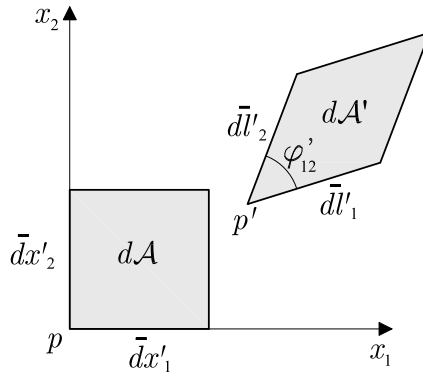

Figure 2.4: Area dilatation.

As well known, we have

$$d\mathcal{A}' = |d\bar{l}' \times \bar{s}'| = dl' ds' \sin \varphi'_{12} \quad (2.59)$$

and, recalling equations (2.52) and (2.53), the latter expression becomes

$$d\mathcal{A}' = dl' ds' \sin \varphi'_{12} = (1 + \delta_1)(1 + \delta_2) \sin \varphi'_{12} \quad (2.60)$$

finally, through the geometrical relation $\cos \omega_{12} = \sin \varphi_{12}$ it is easy to reach the following expression for the finite area dilatation ratio

$$\alpha = (1 + \delta_1)(1 + \delta_2) \cos \omega_{12} - 1 \quad (2.61)$$

that can be alternatively written as

$$\begin{aligned} \alpha &= (1 + \delta_1)(1 + \delta_2) \sqrt{1 - \sin^2 \omega_{12}} - 1 = \\ &= \sqrt{(1 + \delta_1)(1 + \delta_2) - 4\gamma_{12}^2} \end{aligned} \quad (2.62)$$

Volume dilatation

We define the *volume dilatation ratio* the coefficient

$$\nu = \frac{d\mathcal{V}' - d\mathcal{V}}{d\mathcal{V}} \quad (2.63)$$

As in the preceding cases, let us suppose that the initial unstrained volume is given by the following unit vectors

$$d\mathcal{V} = [\bar{e}_1 \times \bar{e}_2] \cdot \bar{e}_3 = \epsilon_{123} = 1 \quad (2.64)$$

Thus, the volume dilatation turns into

$$\nu = d\mathcal{V}' - 1 \quad (2.65)$$

For the strained volume we have

$$d\mathcal{V}' = [d\bar{l}'_1 \times d\bar{l}'_2] \cdot d\bar{l}'_3 = \quad (2.66)$$

$$= dl'_1 dl'_2 dl'_3 = \quad (2.67)$$

$$= (1 + \delta_1)(1 + \delta_2)(1 + \delta_3) \quad (2.68)$$

Finally, the volume dilatation ratio becomes

$$\nu = (1 + \delta_1)(1 + \delta_2)(1 + \delta_3) - 1 \quad (2.69)$$

2.3.2 Infinitesimal deformations

In the preceding section we have discussed the theory of finite deformations. Now, if all the components of the displacements \bar{u} and the displacement gradient tensor $u_{i,j}$ are very small we may neglect the squares and the product of these quantities in comparison with the first order derivatives themselves. So equation (2.99) becomes

$$\varepsilon_{ij} = \frac{1}{2} (u_{i,j} + u_{j,i}) \quad (2.70)$$

where ε denotes a symmetric second-order tensor named *infinitesimal strain tensor*.

Explicit compatibility equations

Now we want to know if any state of given strain ε_{ij} yields a displacement field u_j at every point $p \in \mathcal{V}$. To ensure that we have found equations (2.70) and to solve the differential equations system we discard the components of displacements u_i as follows

$$2\varepsilon_{ij,hk} = u_{i,jhk} + u_{j,ihk} \quad (2.71)$$

$$2\varepsilon_{hk,ij} = u_{h,kij} + u_{k,hij} \quad (2.72)$$

$$-2\varepsilon_{ih,jk} = -u_{i,hjk} + u_{h,ijk} \quad (2.73)$$

$$-2\varepsilon_{jk,ih} = -u_{j,kih} + u_{k,jih} \quad (2.74)$$

Summing equations (2.71) to (2.74) yields the necessary condition to ensure the existence of the field \bar{u} .

$$\varepsilon_{ij,hk} + \varepsilon_{hk,ij} - \varepsilon_{ih,jk} - \varepsilon_{jk,ih} = 0 \quad (2.75)$$

Infinitesimal stretching ratio

When we work in the frame of linear deformations, i.e with the infinitesimal strain tensor, the stretching ratio is given by the first order approximation of the ratio in (2.49), namely

$$\delta_i = \sqrt{1 + 2\varepsilon_{ii}} - 1 \simeq 1 + \frac{2\varepsilon_{ij}}{2} - 1 = \varepsilon_{ii} \quad (2.76)$$

Infinitesimal angular dilatation

We invoke again the first order approximation of expression (2.57), so that, by replacing the finite strain tensor with the infinitesimal strain tensor and by using the latter result for the stretching ratio, the angular dilatation assumes the following expression

$$\omega_{12} \simeq \frac{2\varepsilon_{12}}{\sqrt{1+2\varepsilon_{11}}\sqrt{1+2\varepsilon_{22}}} \simeq 2\varepsilon_{12} \quad (2.77)$$

With the proper subscripts shifting we can also write the angular dilatations ω_{23} and ω_{31} .

Infinitesimal area dilatation

Recalling equation (2.60), that is

$$\alpha = (1 + \delta_1)(1 + \delta_2) \cos \varphi'_{12}$$

the infinitesimal area dilatation is obtained, as usual, by neglecting the second order terms, so that

$$\alpha \simeq \delta_1 + \delta_2 = \varepsilon_{11} + \varepsilon_{22} \quad (2.78)$$

Infinitesimal volume dilatation

From equation (2.69), the first order approximation leads to the following expression for the infinitesimal volumetric dilatation ratio

$$\nu \simeq \delta_1 + \delta_2 + \delta_3 \simeq \varepsilon_{11} + \varepsilon_{22} + \varepsilon_{33} = \varepsilon_{ij} \delta^{ij} \quad (2.79)$$

2.3.3 Deformation and rigid body motion

It is rather intuitive to understand that the motion of a flexible body can be made up of rigid translations and rotations as well as deformations. To see that from a mathematical point of view, consider the displacement field \bar{u} in a point p , as defined in (2.34), being defined by the first order approximation from the displacement \bar{u}_0 on p_0 .

$$u_j = u_{0j} + u_{j,i} dx_i$$

where it is clear that the translational component of the motion is wholly yielded by u_{0j} . Consequently the remaining part must store the deformation and rigid rotation components.

By observing that the gradient of \bar{u} may be also written as follows

$$u_{j,i} = \frac{1}{2}(u_{j,i} + u_{i,j}) + \frac{1}{2}(u_{j,i} - u_{i,j}) \quad (2.80)$$

the displacement field becomes

$$\begin{aligned} u_j &= u_{0j} + \frac{1}{2}(u_{j,i} + u_{i,j}) dx_i + \frac{1}{2}(u_{j,i} - u_{i,j}) dx_i = \\ &= u_{0j} + \varepsilon_{ji} dx_i + \omega_{ji} dx_i \end{aligned} \quad (2.81)$$

where it has been put $\omega_{ji} = \frac{1}{2}(u_{j,i} - u_{i,j})$.

So, through the latter expression, the splitting of the displacement field \bar{u} appears clear:

- u_{0j} : pure translation;
- $\varepsilon_{ij} = \frac{1}{2}(u_{j,i} + u_{i,j})$: pure deformation;
- $\omega_{ji} = \frac{1}{2}(u_{j,i} - u_{i,j})$: rigid body rotation.

In order to give a physical meaning to the operator curl introduced by equation (1.133) on page 26, we can observe that

$$\begin{aligned} \text{curl } \bar{u} &= \varepsilon_{kij} u_{j,i} \bar{e}_k = \\ &= \frac{1}{2} \underbrace{\varepsilon_{kij} (u_{j,i} + u_{i,j})}_{=0} + \left(\frac{1}{2} \varepsilon_{kij} (u_{j,i} - u_{i,j}) \right) \bar{e}_k = \\ &= \varepsilon_{kij} \omega_{ji} \bar{e}_k = \omega_k \bar{e}_k \end{aligned} \quad (2.82)$$

Using the identity (1.105) it is possible to prove⁴ that the skew-symmetric component of a tensor is given by

$$\omega_{ji} = \frac{1}{2} \varepsilon_{kij} \omega_k \quad (2.83)$$

thus the rigid rotation turns into

$$\omega_{ji} dx_i = \frac{1}{2} \varepsilon_{kij} \omega_k dx_i = \frac{1}{2} \bar{\omega} \times d\bar{l} \quad (2.84)$$

where $\bar{\omega} = \text{curl } \bar{u}$ and $d\bar{l} = dx_i \bar{e}_i$.

⁴ $\varepsilon_{klp} \omega_k = \varepsilon_{klp} \varepsilon_{kij} \omega_{ji} = (\delta_{li} \delta_{pj} - \delta_{lj} \delta_{pi}) \omega_{ji} = 2\omega_{pl}$.

2.4 Shell continuum

We define a shell-shaped region modeled on a surface Q and with thickness 2ϵ as a continuous medium $G(\epsilon)$ embedded in the Euclidean space E each point of which is determined through a coordinate system $\{x^\alpha, \xi\} : G(\epsilon) \rightarrow \mathbb{R}^3$. Therefore, given $p^* \in G(\epsilon)$ it is defined by its position p normally projected on Q - by using the surface coordinate system introduced in (1.153) - and by the normal coordinate ξ taken along the unit normal vector \bar{n} . In fact we have

$$p^* \mapsto (x^\alpha(p), \xi(p)) \quad (2.85)$$

The basis induced by the coordinate system $\{x^\alpha, \xi\}$ is $\{\bar{\partial}_\alpha, \bar{n}\}$.

It is worthwhile pointing out that mechanics of shells - by virtue of such above statements - is traced back to the theory of surfaces, in fact vectors and tensors fields belonging to $T_{\bar{Q}}E$ will always be split into the parallel and normal components.

Note also that the symbol \star denotes quantities belonging to the shell continuum.

2.4.1 General assumptions

The shell theory here introduced is based on the following hypotheses

Hypothesis 1 *The shell is sufficiently thin, so that*

$$\frac{2\epsilon}{L} \ll 1 \quad L = \min \{R_{\min}, L_{\min}\} \quad (2.86)$$

where R_{\min} and L_{\min} are the minimum radius and a typical dimension of the shell structure, respectively.

Hypothesis 2 (LINEAR THEORY) *Displacements are infinitesimally small such that their products can be neglected in the kinematic expressions. This assumption allows us to write the equilibrium equations in the unstrained shell configuration.*

Hypothesis 3 *The material filaments along the coordinate ξ remain straight throughout the deformation and no length change is allowed. Namely, the distance between $p^* \in G(\epsilon)$ and the surface Q is unaltered*

$$\xi = \text{const.} \quad (2.87)$$

Hypothesis 4 (KIRCHHOFF–LOVE THEORY) *The line elements initially normal to the shell's mid-surface remain normal to it during the deformation.*

$$\bar{g}(\bar{\partial}_{\alpha_d}, \bar{n}_d) = 0 \quad (2.88)$$

where the subscript d denotes quantities related to deformed configuration.

Note that the last hypothesis is nothing but the extension to a two-dimensional model of the Bernoulli theory for beams.

2.4.2 Strain tensor

A generic point $p^* \in G(\epsilon)$ is determined by the vector \bar{r}^* referred to the global Cartesian axes, so that

$$\bar{r}^* = \bar{r} + \xi \bar{n} \quad (2.89)$$

where $\xi \in (-\epsilon, \epsilon)$. See figure 2.5.

Let us suppose now that a quasi-static motion produces a deformed shell configuration points of which are univocally determined by the vector

$$\bar{r}_d^* = \bar{r}_d + \xi_d \bar{n}_d \quad (2.90)$$

where $\xi_d \in (-\epsilon, \epsilon)$.

The displacement field is obtained by subtracting equations (2.89) and (2.90), so that

$$\bar{r}_d^* - \bar{r}^* = \bar{r}_d - \bar{r} + \xi(\bar{n}_d - \bar{n}) \quad (2.91)$$

where we have made use of hypothesis 3. Equation (2.91) allows us to define the positional field as a function of two vector fields

$$\bar{v} = \bar{r}_d - \bar{r} \quad v \in T_{\bar{Q}} \bar{E} \quad (2.92)$$

$$\bar{w} = \bar{n}_d - \bar{n} \quad w \in T_{\bar{Q}} \bar{E} \quad (2.93)$$

To obtain the strain tensor no more theoretical concepts are required. We already know the definition and we just need to compute the metric tensors associated to the coordinate systems in the strained and the original configurations, so we have

$$\gamma_{ij} = \begin{pmatrix} \gamma_{\alpha\beta} & \gamma_{\alpha 3} \\ \gamma_{3\alpha} & \gamma_{33} \end{pmatrix}$$

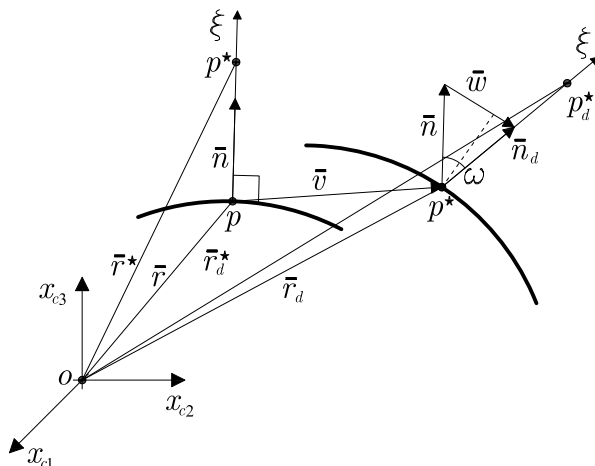

Figure 2.5: Two dimensional sketch of the displacement field for Kirchhoff–Love shells.

where

$$\gamma_{\alpha\beta} = \frac{1}{2} (g_{\alpha\beta_d}^* - g_{\alpha\beta}^*) \quad (2.94)$$

$$\gamma_{\alpha 3} = \gamma_{3\alpha} = \frac{1}{2} (g_{\alpha 3_d}^* - g_{\alpha 3}^*) \quad (2.95)$$

$$\gamma_{33} = \frac{1}{2} (\bar{n}_d \cdot \bar{n}_d - \bar{n} \cdot \bar{n}) = 0 \quad (2.96)$$

According to equation (1.79) we have

$$g_{\alpha\beta_d}^* = \bar{\partial}_{\alpha_d}^* \cdot \bar{\partial}_{\beta_d}^* \quad (2.97)$$

and

$$g_{\alpha\beta}^* = \bar{\partial}_{\alpha}^* \cdot \bar{\partial}_{\beta}^* \quad (2.98)$$

where, recalling equation (1.76), we can write

$$\begin{aligned} \gamma_{\alpha\beta} &= \frac{1}{2} [\bar{\partial}_{\alpha_d}^* \cdot \bar{\partial}_{\beta_d}^* - \bar{\partial}_{\alpha}^* \cdot \bar{\partial}_{\beta}^*] = \\ &= \frac{1}{2} [(\bar{\partial}_{\alpha_d} + \xi \nabla_{\alpha} \bar{n}_d) \cdot (\bar{\partial}_{\beta_d} + \xi \nabla_{\beta} \bar{n}_d)] + \\ &\quad - \frac{1}{2} [(\bar{\partial}_{\alpha} + \xi \nabla_{\beta} \bar{n}) \cdot (\bar{\partial}_{\beta} + \xi \nabla_{\alpha} \bar{n})] = \\ &= \frac{1}{2} [\bar{\partial}_{\alpha_d} \cdot \bar{\partial}_{\beta_d} + \bar{\partial}_{\alpha_d} \cdot \xi \nabla_{\beta} \bar{n}_d + \bar{\partial}_{\beta_d} \cdot \xi \nabla_{\alpha} \bar{n}_d + \xi^2 \nabla_{\alpha} \bar{n}_d \cdot \nabla_{\beta} \bar{n}_d] \\ &\quad - \frac{1}{2} [\bar{\partial}_{\alpha} \cdot \bar{\partial}_{\beta} + \bar{\partial}_{\alpha} \cdot \xi \nabla_{\beta} \bar{n} + \bar{\partial}_{\beta} \cdot \xi \nabla_{\alpha} \bar{n} + \xi^2 \nabla_{\alpha} \bar{n} \cdot \nabla_{\beta} \bar{n}] \quad (2.99) \end{aligned}$$

where we realize that the tensor $\gamma_{\alpha\beta}$ can be split in three parts as follows

$$\gamma_{\alpha\beta} = \alpha_{\alpha\beta} + \xi\omega_{\alpha\beta} + \xi^2\varphi_{\alpha\beta} \quad (2.100)$$

We define the *stretching strain tensor* as

$$\alpha_{\alpha\beta} = \frac{1}{2} [\bar{\partial}_{\alpha d} \cdot \bar{\partial}_{\beta d} - \bar{\partial}_{\alpha} \cdot \bar{\partial}_{\beta}] = \frac{1}{2} (g_{\alpha\beta d} - g_{\alpha\beta}) \quad (2.101)$$

next, the *first bending strain tensor* as

$$\omega_{\alpha\beta} = \frac{1}{2} [\bar{\partial}_{\alpha d} \cdot \nabla_{\beta} \bar{n}_d + \bar{\partial}_{\beta d} \cdot \nabla_{\alpha} \bar{n}_d - \bar{\partial}_{\alpha} \cdot \nabla_{\beta} \bar{n} - \bar{\partial}_{\beta} \cdot \nabla_{\alpha} \bar{n}] \quad (2.102)$$

and the *second bending strain tensor* as

$$\varphi_{\alpha\beta} = \frac{1}{2} [\nabla_{\alpha} \bar{n}_d \cdot \nabla_{\beta} \bar{n}_d - \nabla_{\alpha} \bar{n} \cdot \nabla_{\beta} \bar{n}] \quad (2.103)$$

Considering now that the displacements are small enough to be negligible the second order terms

$$\begin{aligned} \nabla_{\alpha} \bar{v} \cdot \nabla_{\beta} \bar{v} &\simeq 0 \\ \nabla_{\alpha} \bar{v} \cdot \nabla_{\beta} \bar{w} &\simeq 0 \end{aligned}$$

and recalling equations (2.92) and (2.93), the stretching and the bending strain tensors become, respectively

$$\alpha_{\alpha\beta} = \frac{1}{2} (\bar{\partial}_{\alpha} \nabla_{\beta} \bar{v} \cdot \bar{\partial}_{\beta} \nabla_{\alpha} \bar{v}) = \frac{1}{2} (v_{\alpha|\beta} + v_{\beta|\alpha} + 2v^{\xi} L_{\alpha\beta}) \quad (2.104)$$

$$\begin{aligned} \omega_{\alpha\beta} &= \frac{1}{2} (\bar{\partial}_{\alpha} \cdot \nabla_{\beta} \bar{w} + \bar{\partial}_{\beta} \cdot \nabla_{\alpha} \bar{w}) + \\ &+ \frac{1}{2} (\nabla_{\alpha} \bar{v} \cdot \nabla_{\beta} \bar{n} + \nabla_{\beta} \bar{v} \cdot \nabla_{\alpha} \bar{n}) = \\ &= \frac{1}{2} (w_{\alpha|\beta} + w_{\beta|\alpha} + v_{|\alpha}^{\gamma} L_{\gamma\beta} + v_{|\beta}^{\gamma} L_{\gamma\alpha}) + \\ &+ \frac{1}{2} (v^{\xi} (L_{\alpha}^{\gamma} L_{\gamma\beta} + L_{\beta}^{\gamma} L_{\gamma\alpha})) \end{aligned} \quad (2.105)$$

$$\varphi_{\alpha\beta} = \frac{1}{2} (w_{|\alpha}^{\gamma} L_{\gamma\beta} + w_{|\beta}^{\gamma} L_{\gamma\alpha}) \quad (2.106)$$

where we have put

$$\nabla_{\alpha} \bar{v} = (v_{|\alpha}^{\gamma} + v^{\xi} L_{\alpha}^{\gamma}) \bar{\partial}_{\gamma} + (v_{,\alpha}^{\xi} - v^{\gamma} L_{\alpha\gamma}) \bar{n} \quad (2.107)$$

$$v_{|\alpha}^{\gamma} = v_{,\alpha}^{\gamma} + v^{\omega} \Gamma_{\alpha\omega}^{\gamma} \quad (2.108)$$

and

$$\nabla_\alpha \bar{w} = w_{|\alpha}^\gamma \bar{\partial}_\gamma - w^\gamma L_{\alpha\gamma} \bar{n} \quad (2.109)$$

$$w_{|\alpha}^\gamma = w_{,\alpha}^\gamma + w^\omega \Gamma_{\alpha\omega}^\gamma \quad (2.110)$$

and

$$\nabla_\alpha \bar{n} \cdot \nabla_\beta \bar{w} = L_\alpha^\gamma \bar{\partial}_\gamma \cdot \left(w_{|\beta}^\omega d\bar{e}r_\omega - w^\omega L_{\beta\omega} \bar{n} \right) = L_{\omega\alpha} w_{|\beta}^\omega \quad (2.111)$$

Finally, the strain tensor assumes the following form

$$\begin{aligned} \gamma_{\alpha\beta} &= \frac{1}{2} \left(v_{\alpha|\beta} + v_{\beta|\alpha} + 2v^\xi L_{\alpha\beta} \right) + \\ &+ \frac{1}{2} \xi \left(w_{\alpha|\beta} + w_{\beta|\alpha} + v_{|\alpha}^\gamma L_{\gamma\beta} + v_{|\beta}^\gamma L_{\gamma\alpha} \right) + \\ &+ \frac{1}{2} \left(v^\xi \left(L_\alpha^\gamma L_{\gamma\beta} + L_\beta^\gamma L_{\gamma\alpha} \right) \right) + \\ &+ \frac{1}{2} \xi^2 \left(w_{|\alpha}^\gamma L_{\gamma\beta} + w_{|\beta}^\gamma L_{\gamma\alpha} \right) \end{aligned} \quad (2.112)$$

The stretching strain tensor does not depend on the thickness, in fact it describes the deformation of the mid-surface Q . The bending strain tensors describe the deformation along the thickness.

The transversal components of the strain are

$$\gamma_{3\alpha} = \gamma_{\alpha 3} = \frac{1}{2} \left(\bar{n}_d \cdot \bar{\partial}_{\alpha_d} - \bar{n} \cdot \bar{\partial}_\alpha \right) = v_{,\alpha}^\xi - v^\gamma L_{\alpha\gamma} + w_\alpha \quad (2.113)$$

Kirchhoff–Love strain theory

If we take into account the *Kirchhoff-Love* hypothesis, see hypothesis 4, we have

$$\bar{\partial}_{\alpha_d} \cdot \bar{n}_d = 0 \Rightarrow (\bar{n} + \bar{w}) \cdot (\bar{\partial}_\alpha + \nabla_\alpha \bar{v}) = 0 \Rightarrow \quad (2.114)$$

$$\bar{w} \cdot \partial_\alpha + \bar{n} \cdot \nabla_\alpha \bar{v} = 0 \Rightarrow w_\alpha = v^\gamma L_{\alpha\gamma} - v_{,\alpha}^\xi \quad (2.115)$$

and we observe that the variables reduce just to the field \bar{v} . Thus, the strain tensor turns into

$$\alpha_{\alpha\beta} = \frac{1}{2} \left(v_{\alpha|\beta} + v_{\beta|\alpha} + 2v^\xi L_{\alpha\beta} \right) \quad (2.116)$$

$$\omega_{\alpha\beta} = v_{|\alpha}^\gamma L_{\gamma\beta} + v_{|\beta}^\gamma L_{\gamma\alpha} + v^\gamma L_{\gamma\alpha|\beta} - v_{,\alpha\beta}^\xi + v^\xi L_\alpha^\gamma L_{\gamma\beta} \quad (2.117)$$

$$\begin{aligned}
2\varphi_{\alpha\beta} = & \xi^2 \left(v_{|\alpha}^{\delta} L_{\delta\gamma} L_{\beta}^{\gamma} + v^{\delta} L_{\delta\gamma|\alpha} L_{\beta}^{\gamma} - v_{\gamma\alpha}^{\xi} L_{\beta}^{\gamma} \right) + \\
& + \xi^2 \left(v_{|\beta}^{\delta} L_{\delta\gamma} L_{\alpha}^{\gamma} + v^{\delta} L_{\delta\gamma|\beta} L_{\alpha}^{\gamma} - v_{\gamma\beta}^{\xi} L_{\alpha}^{\gamma} \right) \quad (2.118)
\end{aligned}$$

In the linear theory the second bending strain tensor can be neglected because ξ is very small and its square makes the contribution of $\varphi_{\alpha\beta}$ insignificant.

Finally, we have

$$\gamma_{33} = \gamma_{\alpha 3} = \gamma_{3\alpha} = 0 \quad (2.119)$$

Consider now a Cartesian coordinate system where all the Christoffel symbols vanish, we immediately realize the well known expression of the strain tensor for bending plates

$$\gamma_{\alpha\beta} = \frac{1}{2} \left(v_{\alpha,\beta} + v_{\beta,\alpha} - 2v_{,\alpha\beta}^{\xi} \right) \quad (2.120)$$

Chapter 3

Analysis of stress

This chapter presents the classical stress analysis of a three-dimensional continuum subjected to both body and surface forces. It begins with the notions of stress vector and stress tensor which bring to enunciate the famous Cauchy's theorem, then the static equilibrium equations will be derived.

Next, the graphical representation through Mohr's circle and the principal directions associated with the state of stress will be also analyzed.

Curvilinear coordinate systems will be introduced only in the last section, where the analysis of stress for shell continuums will be shortly introduced.

3.1 Body and surface forces

Let \mathcal{V} be the configuration of the continuous medium. We suppose that \mathcal{V} is bounded by the closed surface \mathcal{S} . Consider a small region $\Delta\mathcal{V}$ subset of \mathcal{V} and a small surface element $\Delta\mathcal{S}$ of \mathcal{S} . To analyze the forces acting on the volume element $\Delta\mathcal{V}$ it is necessary to account for two types of forces:

Body forces (or volume forces). These are the forces which are proportional to the mass contained in the volume element $\Delta\mathcal{V}$.

Surfaces forces. These are the forces being measured as force per unit area of surface $\Delta\mathcal{S}$ on which they act.

A good example of body forces is gravity: $\rho g \Delta\mathcal{V}$ - where ρ is the density of the continuum and g is the gravitational acceleration - or inertia.

Examples of surface forces are: pressure and tension $\bar{t}_n(p, \bar{n})$ (discussed in depth later on), which two parts of a continuum mutually exchange.

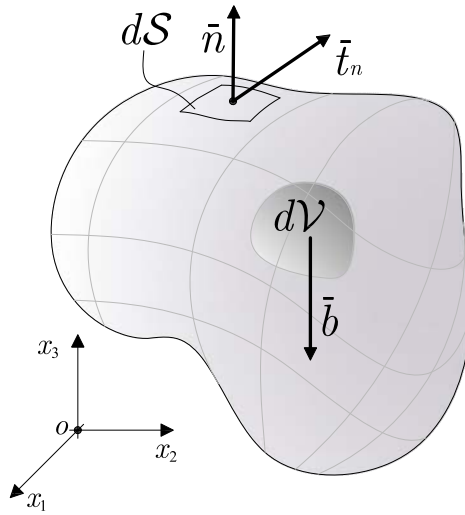

Figure 3.1: Body and surface forces.

If we imagine that the continuous medium \mathcal{V} , equilibrium of which we are searching, is a subset of a bigger imaginary continuous body, then the tensions exchanged between these two portions can be assumed as external force loads.

In order to write the equations of equilibrium we consider both body forces $\bar{b} = b^i \bar{e}_i$ and surface forces \bar{t}_n . See figure 3.1.

The body forces also produce a resultant moment $\bar{M} = M^i \bar{e}_i$, where

$$\bar{M} = \int_{\mathcal{V}} (\bar{r} \times \bar{b}) dV \quad (3.1)$$

3.2 State of stress

Let \mathcal{V} be the configuration of a continuous medium, whose points are referred to a rectangular coordinate system

$$x^i : E \rightarrow \mathbb{R} : p \mapsto g((p - o), \bar{e}_i) \quad (3.2)$$

where p and o are points of E and $\{\bar{e}_i\}$ is the unit normal basis of \bar{E} .

Suppose on the body \mathcal{V} surface and body forces, e.g. \bar{b} , \bar{S}_j , \bar{M}_k , \hat{f} act in such a way to assure the equilibrium state. See figure 3.2. Due

to these forces throughout the body internal reactions are activated between the material points.

To understand the stress condition created at generic point p within the body \mathcal{V} , we suppose to cut the continuous medium by means of a generic plane π_n , so that two portions \mathcal{V}_1 and \mathcal{V}_2 are produced.

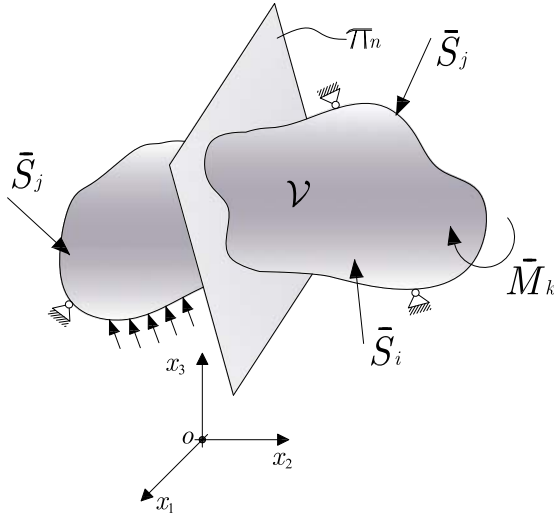

Figure 3.2: Body \mathcal{V} being in an equilibrium state.

After splitting, the portions of the body on the left and on the right side of the section plane π_n lose their equilibrium state. In fact, before parting, both \mathcal{V}_1 and \mathcal{V}_2 were in equilibrium due to the mutual forces exchanged through the plane.

Cauchy enunciated the principle that, within a body, the forces that an enclosed volume imposes on the remainder of the body must be in equilibrium with the forces from the remainder of the body itself.

We denote by $\Delta\mathcal{A}_n$ the small area surrounding p and by $\Delta\bar{S}_n$ and $\Delta\bar{M}_n$ the force and the couple resultants in p stemmed from the internal force distribution acting through $\Delta\mathcal{A}_n$. See figure 3.3.

Cauchy's principles implies the following limits

1. $\lim_{\Delta\mathcal{A}_n \rightarrow 0} \frac{\Delta\bar{S}_n}{\Delta\mathcal{A}_n} = \bar{t}_n(p, \bar{n}) = -\bar{t}_n(p, -\bar{n})$
2. $\lim_{\Delta\mathcal{A}_n \rightarrow 0} \frac{\Delta\bar{M}_n}{\Delta\mathcal{A}_n} = 0$

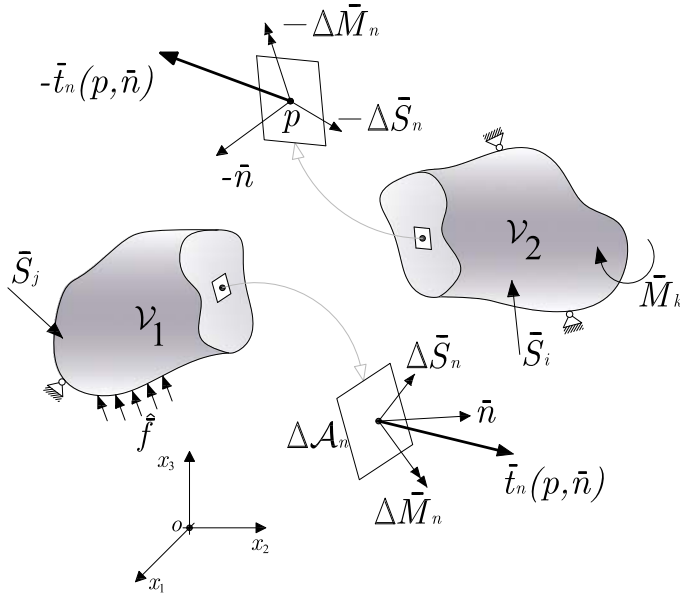

Figure 3.3: Splitting of the continuous media \mathcal{V} .

The vector $\bar{t}_n(p, \bar{n})$ is called the *Cauchy stress vector* and represents the surface force per unit of area acting at point p . The second limit assures that the entire state of stress for a fixed point p is only defined by the forces, that is the couples are infinitesimal in comparison with them.

It's important to observe that \bar{t}_n is a linear mapping defined as follows

$$\bar{t}_n : E \times \bar{E} \rightarrow \bar{E} \quad (3.3)$$

so that

$$\bar{t}_n(p) \in L(\bar{E}, \bar{E}) \quad (3.4)$$

and we recognize $\bar{t}_n(p)$ to be an endomorphism which is associated to a tensor belonging to $\bar{E}^* \otimes \bar{E}$.

In the following paragraphs this tensor will be thoroughly analyzed.

3.2.1 Stress vector components

Let \bar{n} be the unit normal vector of the surface $\Delta\mathcal{A}_n$ located at p . We can write the components of stress vector¹ $\bar{t}_n(p, \bar{n})$ as follows

$$\bar{t}_n(p, \bar{n}) = t_n^i(p, \bar{n}) \bar{e}_i \quad (3.5)$$

so that the normal components of $\bar{t}_n(p)$ can be easily written as

$$t_n^n(p, \bar{n}) = \bar{n} \cdot \bar{t}_n(p, \bar{n}) = t_n^i(p, \bar{n}) n_i \quad (3.6)$$

Let us observe that the stress vector, which represents the entire state of stress at p , is completely known if the three coordinate components $t_n^i(p, \bar{n})$ are known.

3.2.2 Stress tensor

Now we want to show that the state of stress at any point of the continuum is entirely characterized specifying a linear mapping, i.e. endomorphism, represented by the nine quantities called *components of stress tensor*.

As usual, p is a point in the medium and $\bar{t}_n(p, \bar{n})$ is the stress vector acting on the surface element passing for p with the unit normal \bar{n} . Imagine to have four planar elements, three of which are parallel to the coordinate planes, the fourth one is supposed passing normal to \bar{n} , at a very small distance to p . We obtain a small tetrahedron. See figure 3.4

We shall denote by \bar{t}_i , with $i = 1, 2, 3$, the stresses vector² acting on the planar surface element orthogonal to the coordinate curves x_i , namely $\bar{t}_i = \bar{t}_i(p, \bar{e}_i)$. Evidently, every stress vector can be written by its components in the following way

$$\bar{t}_i = t_i^j \bar{e}_j \quad i, j = 1, 2, 3 \quad (3.7)$$

where

$$t_i^j = \bar{e}_j \cdot \bar{t}_i \quad (3.8)$$

The forces acting on the tetrahedron are both surface and body forces:

¹It must be noted that in general the stress vector $\bar{t}_n(p, \bar{n})$ is not in the direction of \bar{n} .

²Rigorously \bar{t}_i should be write as $\bar{t}_{\bar{e}_i}(p)$.

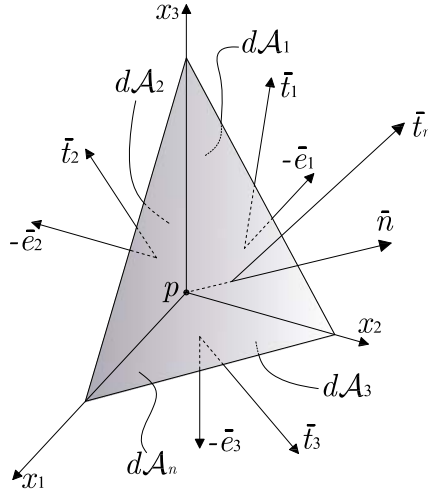

Figure 3.4: Stress vectors: the sketch of *Cauchy's* theorem.

- Body forces: $\bar{b}d\mathcal{V}$
- Surface forces: $-\bar{t}_i(p, -\bar{e}_i)d\mathcal{A}_i + \bar{t}_n(p, \bar{n})d\mathcal{A}_n$, with $i = 1, 2, 3$.

thus the translational equilibrium of the tetrahedron can be readily written as

$$-\bar{t}_i(p, -\bar{e}_i)d\mathcal{A}_i + \bar{t}_n(p, \bar{n})d\mathcal{A}_n + \bar{b}d\mathcal{V} = 0 \quad (3.9)$$

that taking into account that $d\mathcal{A}_i = d\mathcal{A}_n n_i$, indeed we have $n^i = \bar{n} \cdot \bar{e}_i = \cos(\bar{n}, \bar{e}_i)$, the above expression turns into

$$-\bar{t}_i(p, -\bar{e}_i)d\mathcal{A}_n n_i + \bar{t}_n(p, \bar{n})d\mathcal{A}_n + \frac{1}{3}\rho gh d\mathcal{A}_n = 0 \Rightarrow \quad (3.10)$$

$$-\bar{t}_i(p, -\bar{e}_i)n_i + \bar{t}_n(p, \bar{n}) + \frac{1}{3}\rho gh = 0 \quad (3.11)$$

and, for h approaching zero, i.e. the infinitesimal volume surrounding p , the equilibrium becomes

$$\bar{t}_n(p, \bar{n}) = \bar{t}_i(p, -\bar{e}_i)n_i \quad (3.12)$$

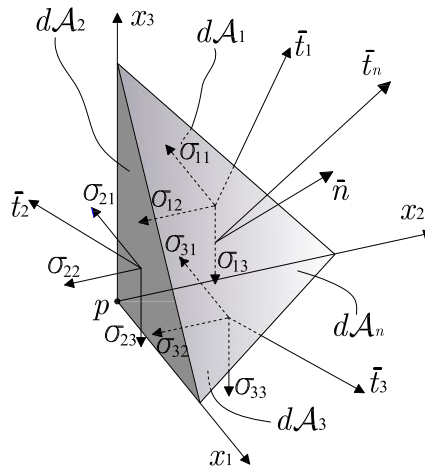

Figure 3.5: Stress tensor components.

Equation (3.12) represents *Cauchy*³'s theorem which states that the stress state $\bar{t}_n(p, \bar{n})$ can be completely determined by the stress vectors $\bar{t}_i(p, -\bar{e}_i)$, acting on the face with outward unit normal vector $-\bar{e}_i$, where \bar{n} is considered known. This result also proves that we are really dealing with a tensor as introduced by the endomorphism (3.4).

It will be convenient to use the customary notation, so that equation (3.12) may be rewritten in components as follows

$$t_n^j(p, \bar{n}) \bar{e}_j = t_i^j(p, -\bar{e}_i) n_i \bar{e}_j \quad (3.13)$$

from which the stress tensor σ is defined as

$$t_n^j(p, \bar{n}) = \sigma_{ij} n_i \quad (3.14)$$

*The tensor σ_{ij} is called the **stress tensor**, it completely defines the state of stress at point p and repre-*

³Augustin Louis Cauchy (August 21, 1789 - May 23, 1857) was a French mathematician.



sents the component of the vector \bar{t}_i working in direction of x^j .

See figure 3.5.

We can summarize saying that

$$\sigma : E \rightarrow L(\bar{E}, \bar{E}), \quad p \mapsto \sigma(p) \in \bar{E}^* \otimes \bar{E} \quad (3.15)$$

so

$$\sigma(p)(\bar{n}) = \bar{t}_n(p, \bar{n}) \quad (3.16)$$

that in components, (3.16), becomes

$$t_n^j = \sigma_h^j n^h \quad (3.17)$$

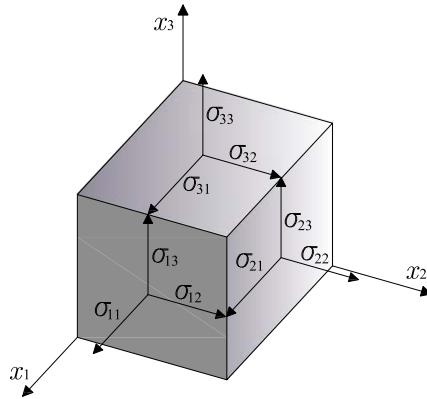

Figure 3.6: Stress tensor components acting on an infinitesimal volume element.

We remind the reader again that the lower and upper indices, in this context, can mutually be exchanged; moreover, they can be placed both upper and lower. So, generally, we shall also write

$$t_{nj} = \sigma_{hj} n_h \quad (3.18)$$

3.3 Equations of equilibrium

3.3.1 Translational equilibrium

With respect to the body \mathcal{V} , bounded by the closed surface \mathcal{S} , the condition of equilibrium requires that

$$\int_{\mathcal{V}} \bar{b} d\mathcal{V} + \int_{\mathcal{S}} \bar{t}_n d\mathcal{S} = 0 \quad (3.19)$$

Making use of (3.16), equation (3.19) becomes

$$\int_{\mathcal{V}} \bar{b} d\mathcal{V} + \int_{\mathcal{S}} \sigma(p) (\bar{n}) d\mathcal{S} = 0 \quad (3.20)$$

The divergence theorem can be applied to integral (3.20), so that

$$\int_{\mathcal{V}} \bar{b} d\mathcal{V} + \int_{\mathcal{V}} \operatorname{div} \sigma(p) d\mathcal{V} = \int_{\mathcal{V}} (\bar{b} + \operatorname{div} \sigma(p)) d\mathcal{V} = 0 \quad (3.21)$$

Since the region of integration \mathcal{V} is arbitrary, i.e. each part of the medium is in equilibrium, integral (3.21) vanishes, thus, at every point of \mathcal{V} we have

$$\operatorname{div} \sigma + \bar{b} = 0 \quad (3.22)$$

that in components becomes

$$\sigma_{ij,i} + b_j = 0 \quad (3.23)$$

3.3.2 Rotational equilibrium

As well as the translational equilibrium, we require that the moments acting on the body are also in equilibrium, so

$$\int_{\mathcal{V}} (\bar{r} \times \bar{b}) d\mathcal{V} + \int_{\mathcal{S}} (\bar{r} \times \bar{t}_n) d\mathcal{S} = 0 \quad (3.24)$$

which in components, by virtue of the skew-symmetric tensor ϵ , becomes

$$\begin{aligned} \int_{\mathcal{V}} (r^i b^j \epsilon_{kij} \bar{e}_k) d\mathcal{V} + \int_{\mathcal{S}} (r^i \bar{e}_i \times \sigma_{jh} n_h \bar{e}_j) d\mathcal{S} = 0 \Rightarrow \\ \int_{\mathcal{V}} (r^i b^j \epsilon_{kij} \bar{e}_k) d\mathcal{V} + \int_{\mathcal{S}} (r^i \sigma_{jh} n_h \epsilon_{kij} \bar{e}_k) d\mathcal{S} = 0 \end{aligned}$$

With the aid of the divergence theorem, for the k -th component we can write

$$\begin{aligned} \epsilon_{kij} \int_{\mathcal{V}} (r^i b^j) d\mathcal{V} + \epsilon_{kij} \int_{\mathcal{V}} (r^i \sigma_{jh})_{,h} d\mathcal{V} = 0 \Rightarrow \\ \epsilon_{kij} \int_{\mathcal{V}} (r^i b^j + r_{i,h} \sigma_{jh} + r_i \sigma_{jh,h}) d\mathcal{V} = 0 \end{aligned}$$

Recalling equation (3.23), and that $r_{i,h} = \delta_{ih}$ and since the volume \mathcal{V} is arbitrary, the rotational equilibrium produces

$$\epsilon_{kij}\sigma_{ij} = 0 \quad (3.25)$$

Therefore equation (3.25) imposes the symmetry of the components of the stress tensor:

$$\sigma_{ij} = \sigma_{ji} \quad (3.26)$$

The symmetry of the stress tensor can be also seen considering the volume element taken in shape of a rectangular parallelepiped, with faces parallel to the coordinate planes and with stress vector \bar{t}_i acting on the face perpendicular to the x_i -axis. Denoting the coordinates $\{x_1, x_2, x_3\}$ with $\{x, y, z\}$ - as often happens in literature - for the (y, z) -plane the rotational equilibrium becomes

$$(\sigma_{yz}dxdy) dz = (\sigma_{zy}dxdy) dz \Rightarrow \sigma_{yz} = \sigma_{zy} \quad (3.27)$$

See figure 3.7.

If we write the equilibrium for all planes, we obtain again the result in (3.26).

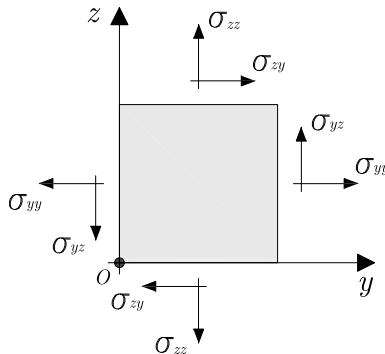

Figure 3.7: Plane (y, z) . Components of the stress tensor acting on the volume element.

3.3.3 Boundary equations

Let \hat{f} be the external force acting on the surface \mathcal{S}_σ and \hat{u} the displacement field imposed on the remaining portion \mathcal{S}_u , so that

$\mathcal{S} = \mathcal{S}_\sigma \cup \mathcal{S}_u$. Each point of \mathcal{V} lying on the boundary \mathcal{S} must satisfy the equilibrium and kinematic conditions as follows

$$\bar{t}_n dS = \hat{f} dS, \quad \forall p \in \mathcal{S}_\sigma \quad (3.28)$$

$$\bar{u} = \hat{u}, \quad \forall p \in \mathcal{S}_u \quad (3.29)$$

that in components is

$$\sigma_{hj} n_h = f_j, \quad \forall p \in \mathcal{S}_\sigma \quad (3.30)$$

$$u_i = \hat{u}_i, \quad \forall p \in \mathcal{S}_u \quad (3.31)$$

3.4 Principal stresses and principal directions

Let us consider now the sheaf of planes passing through $p \in \mathcal{V}$. Among the infinite planes there are some for which all the stress components vanish except the normal one. These planes are said *principal planes* and their normal directions are said *principal directions*. Hence, if \bar{n} is a principal directions, by definition, we have at p

$$\bar{t}_n = \sigma \bar{n}, \quad \sigma \in \mathbb{R} \quad (3.32)$$

To find the three principal stresses we impose

$$\bar{t}_n = \sigma_{ih} n_h \bar{e}_i = \sigma \bar{n} \Rightarrow \sigma_{ih} n_h \bar{e}_i = \sigma n_i \bar{e}_i \quad (3.33)$$

so that

$$\sigma_{ih} n_h - \sigma \delta_{ih} n_h = 0 \Rightarrow (\sigma_{ih} - \sigma \delta_{ih}) n_h = 0 \quad (3.34)$$

Expression (3.34) is a set of three homogeneous equations in the unknown direction \bar{n} . The solution is nonvanishing if, and only if, the determinant of the coefficients matrix is equal to zero; that is

$$|\sigma_{ij} - \sigma \delta_{ij}| = 0 \quad (3.35)$$

Solving the determinant above we obtain the cubic equation called *secular equation* in the unknown stresses σ

$$\sigma^3 - I_1 \sigma^2 - I_2 \sigma - I_3 = 0 \quad (3.36)$$

The (3.35), (or (3.36)) has three real roots $\sigma_I, \sigma_{II}, \sigma_{III}$, which are called *principal stresses*. If σ in equation (3.34) is replaced by

any one of these eigenvalues, the resulting set of equations may be solved for the corresponding direction \bar{n} . These directions, \bar{n}_I , \bar{n}_{II} , \bar{n}_{III} are called *principal directions*. The planes normal to the principal directions are termed *principal planes of stresses*. In other words we say that along the principal planes of stresses there is no shearing stress.

Generally there are only three mutually orthogonal principals directions.

The three scalars in (3.36) are invariants as regards to the coordinate system. They are

$$\begin{aligned} I_1 &= \text{tr}\sigma \\ I_2 &= \frac{1}{2} (\sigma_{ii}\sigma_{jj} - \sigma_{ij}\sigma_{ij}) \\ I_3 &= \det (\sigma_{ij}) \end{aligned}$$

These invariants are physically very important, they in fact allow us to characterize the stress state as follows

$$\begin{aligned} &\text{if } I_3 = 0 : \text{triaxial state of stress} \\ &\text{if } I_3 = 0 \text{ and } I_2 \neq 0 : \text{biaxial stete of stress} \\ &\text{if } I_3 = I_2 = 0 \text{ and } I_1 \neq 0 : \text{axial stete of stress} \end{aligned}$$

Now we want to point out that the principal stresses found solving equation (3.35) represent the maximum and minimum stress. To see this we make use of the Lagrange multipliers method in order to find the extremes of a function of several variables subjected to one or more constraints. In this case recalling formulae (1.33) and (1.34) we can write the stress tensor in a generic unknown coordinate system rotated with respect the initial system as follows

$$\sigma'_{ij} = a_h^i \sigma_k^h a_j'^k \quad (3.37)$$

and we also impose the constraint on the unknown matrices a and a' such as they are effectively two orthogonal transformations, i.e. the condition (1.21). Hence we have

$$\mathcal{L}(a_h^i, \lambda) = a_h^i \sigma_k^h a_j'^k - \lambda (a_h^i a_j'^h - \delta_j^i) \quad (3.38)$$

and the stationary conditions are

$$\frac{\partial \mathcal{L}}{\partial a_h^i} = \sigma_k^{ih} a_j^{ik} - \lambda a_j^{ih} = \left(\sigma_k^{ih} - \lambda \delta_k^h \right) a_j^{ik} = 0 \quad (3.39)$$

$$\frac{\partial \mathcal{L}}{\partial a_h^i} = a_h^i a_j^{ih} - \delta_j^i = 0 \quad (3.40)$$

The first equation, (3.39), yields the following condition

$$|\sigma_k^{ih} - \lambda \delta_k^h| = 0 \quad (3.41)$$

that is exactly the condition (3.35), hence we can derive that given a generic state of stress σ_{ij} , the principal stresses $\sigma_I, \sigma_{II}, \sigma_{III}$ are extrem values.

3.4.1 Normal and tangential components of the stress vector

The last equations of the previous section enable us to know the components of the stress vector for every direction we want. Let \bar{n} be the unit normal vector and $\bar{\nu}$ the unit tangent vector. It follows that the normal and tangent components of the stress vector, σ and τ , respectively, are readily computed through the usual scalar product as follows

$$\sigma = \bar{t}_n(p, \bar{n}) \cdot \bar{n} = t_{jn}(p, \bar{n}) n_j = \sigma_{ij} n_i n_j \quad (3.42)$$

$$\tau = \bar{t}_n(p, \bar{n}) \cdot \bar{\nu} = t_{jn}(p, \bar{n}) \nu_j = \sigma_{ij} n_i \nu_j \quad (3.43)$$

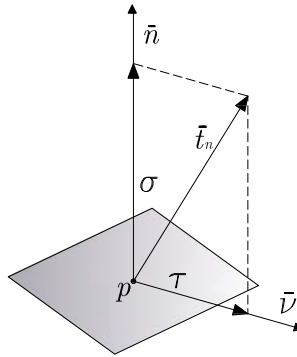

Figure 3.8: Normal and tangential components of the stress vector.

From figure 3.8 on the preceding page it is also clear that the square tangent component of the stress vector can be written as follows

$$\tau^2 = |\bar{t}_n|^2 - \sigma \quad (3.44)$$

3.4.2 Mohr's circles

Two dimensional state of stress

An important graphical interpretation of the above results is due to O. Mohr⁴. Following [10], [9] and [12] let us begin considering the above relations (3.42) and (3.43) for a two dimensional problem, so that

$$\sigma_{ij} = \begin{pmatrix} \sigma_{11} & \sigma_{12} \\ \sigma_{21} & \sigma_{22} \end{pmatrix} \quad (3.45)$$

The unit vectors \bar{n} and $\bar{\nu}$, with respect to figure 3.9, have the following components

$$\bar{n} = \begin{pmatrix} \cos \varphi \\ \sin \varphi \end{pmatrix}; \quad \bar{\nu} = \begin{pmatrix} -\cos(\pi/2 - \varphi) \\ \sin(\pi/2 - \varphi) \end{pmatrix} = \begin{pmatrix} -\sin \varphi \\ \cos \varphi \end{pmatrix}$$

Hence, the normal and tangent components of $\bar{t}_n(p, \bar{n})$ are

$$\sigma = \sigma_{11} \cos^2 \varphi + \sigma_{22} \sin^2 \varphi + 2\sigma_{12} \sin \varphi \cos \varphi \quad (3.46)$$

$$\tau = -\sigma_{11} \cos \varphi \sin \varphi + \sigma_{22} \sin \varphi \cos \varphi + \sigma_{12} \cos^2 \varphi - \sigma_{21} \sin^2 \varphi \quad (3.47)$$

that through some trigonometric manipulations⁵ turn respectively

⁴Christian Otto Mohr October 8, 1835 - October 2, 1918 was a German civil engineer.



Source: <http://en.wikipedia.org/wiki/Otto-Mohr>.

⁵In particular these two identities have been used:

i) $2 \sin \varphi \cos \varphi = \sin 2\varphi$,

ii) $\cos^2 \varphi - \sin^2 \varphi = \cos 2\varphi$.

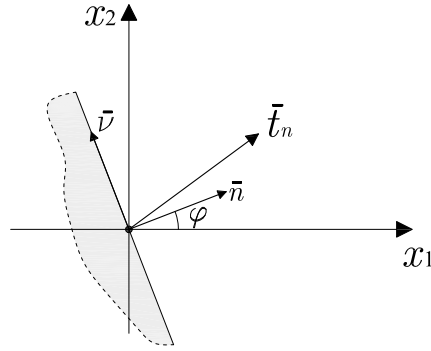

Figure 3.9: Normal and tangential components of the stress vector in two dimensions.

into

$$\begin{aligned}\sigma &= \frac{1}{2}\sigma_{11}\cos^2\varphi + \frac{1}{2}\sigma_{11}(1 - \sin^2\varphi) + \\ &+ \frac{1}{2}\sigma_{22}\sin^2\varphi + \frac{1}{2}\sigma_{22}(1 - \cos^2\varphi) + \sigma_{12}\sin 2\varphi = \\ &= \frac{1}{2}(\sigma_{11} + \sigma_{22}) + \frac{1}{2}(\sigma_{11} - \sigma_{22})\cos 2\varphi + \sigma_{12}\sin 2\varphi\end{aligned}\quad (3.48)$$

$$\begin{aligned}\tau &= -\sigma_{11}\cos\varphi\sin\varphi + \sigma_{22}\sin\varphi\cos\varphi + \sigma_{12}\cos^2\varphi - \sigma_{21}\sin^2\varphi = \\ &= -\frac{1}{2}(\sigma_{11} - \sigma_{22})\sin 2\varphi + \sigma_{12}\cos 2\varphi\end{aligned}\quad (3.49)$$

Next, by squaring both terms of the latter equations and summing term by term, the variable 2φ disappears, hence

$$\left(\sigma - \frac{1}{2}(\sigma_{11} + \sigma_{22})\right)^2 + \tau^2 = \left(\frac{1}{2}(\sigma_{11} - \sigma_{22})\right)^2 + \sigma_{12}^2\quad (3.50)$$

If we represent the above equation in a two dimensional Cartesian system with σ and τ as abscissa and ordinate, respectively, we realize it represents the equation of a circle in the form $(x - x_C)^2 + (y - y_C)^2 = R^2$ where

$$x_C = \frac{1}{2}(\sigma_{11} + \sigma_{22})\quad (3.51)$$

$$y_C = 0\quad (3.52)$$

are the coordinates of the center and

$$R = \sqrt{\left(\frac{1}{2}(\sigma_{11} - \sigma_{22})\right)^2 + \sigma_{12}^2}\quad (3.53)$$

is the radius of the circle. This circle is known as *Mohr's circle* and it represents all the possible states of stress in p . Namely, there exists a one-to-one relationship between each state of stress $\bar{t}_n(p, \bar{n})$, i.e. σ and τ , and points belonging to the circle. To show that, let us assume γ is the angle between the x_1 -axis and the stress vector \bar{t}_n , as figure 3.10 depicts. To find the correspondence between the stress state and the circle let us observe that γ defines a principal direction so, by definition $\tau = 0$, and we have

$$\tan 2\gamma = \frac{2\sigma_{12}}{\sigma_{11} - \sigma_{22}} \quad (3.54)$$

and with the aid of picture 3.10 in the above equation we recognize that $\overline{P_1P^*} = 2\sigma_{12}$ and $\overline{P_2P^*} = \sigma_{11} - \sigma_{22}$. Consequently the following expressions hold

$$r \cos 2\gamma = \frac{1}{2} (\sigma_{11} - \sigma_{22}) \quad (3.55)$$

$$r \sin 2\gamma = \sigma_{12} \quad (3.56)$$

$$(3.57)$$

that substituted into (3.48) and (3.49) and making use of some trigonometric identities⁶ yield, respectively

$$\sigma = \frac{1}{2} (\sigma_{11} + \sigma_{22}) + r \cos 2(\gamma - \varphi) \quad (3.58)$$

$$\tau = r \sin 2(\gamma - \varphi) \quad (3.59)$$

Thus, given a generic plane oriented as φ equations (3.58) and (3.59) are a parametric representation of a circle and so a one-to-one relationship between the state of stress and the Mohr's circle is established. See figure 3.10.

We define $P^* \equiv (\sigma_{11}, -\sigma_{12})$ as the *pole* of the circle. The line passing through P^* having inclination φ with respect to the vertical

⁶In particular these identities have been used:

i) $\cos 2\gamma \cos 2\varphi = \frac{1}{2} (\cos 2(\gamma + \varphi) + \cos 2(\gamma - \varphi))$,

ii) $\sin 2\gamma \sin 2\varphi = \frac{1}{2} (\cos 2(\gamma - \varphi) - \cos 2(\gamma + \varphi))$,

iii) $\sin 2\varphi \cos 2\varphi = \frac{1}{2} (\sin 2(\gamma + \varphi) + \sin 2(\gamma - \varphi))$.

and the directions can be computed putting zero the following derivative

$$\frac{d\tau}{d\gamma} = 0 \Rightarrow \cos 2(\gamma - \varphi) = \frac{\pi}{2} \Rightarrow \gamma = \varphi + \frac{\pi}{4} \quad (3.62)$$

Let us summarize now the key items to draw and use the Mohr's circle when a plane state of stress σ_{ij} , with $i, j = 1, 2$ is known with respect to a generic system $\{x_1, x_2\}$. See figure 3.11.

1. Compute the radius R and the abscissa of the center C of the circle, equations (3.51) and (3.53);
2. Identify the pole P^* ;
3. Identify the principal direction drawing a line from P^* to both S_1 and S_2 . The inclination of the latter defines the principal directions;
4. Compute the principal stresses σ_I and σ_{II} at the extreme points S_1 and S_2 , respectively;
5. Compute the maximum and minimum shear stresses τ_{\min} and τ_{\max} .

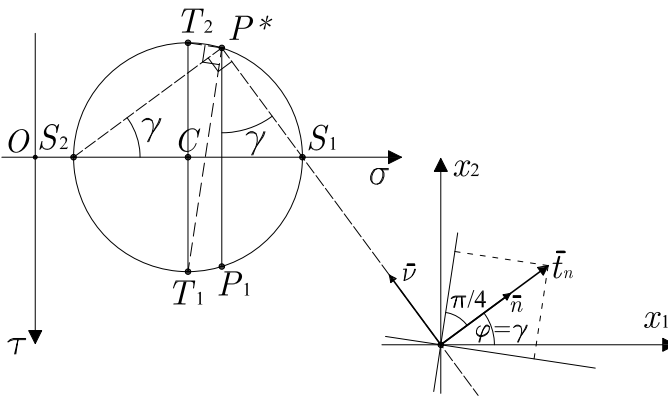

Figure 3.11: Graphical determination of principal directions.

Three dimensional state of stress

Consider again the state of stress in p referenced to the principal axes and let the principal stresses be ordered according to $\sigma_I > \sigma_{II} > \sigma_{III}$. Assume the three principal stresses are known, so that, in accordance with equations (3.42) and (3.44), we write

$$\begin{aligned}\sigma &= \sigma_I n_1^2 + \sigma_{II} n_2^2 + \sigma_{III} n_3^2 \\ \tau^2 + \sigma^2 &= (\sigma_I n_1)^2 + (\sigma_{II}^2 n_2)^2 + (\sigma_{III} n_3)^2\end{aligned}$$

and being $\bar{n} \cdot \bar{n} = n_1^2 + n_2^2 + n_3^2 = 1$, by solving for the directions n_i , we obtain

$$n_1^2 = \frac{\tau^2 + (\sigma - \sigma_{II})(\sigma - \sigma_{III})}{(\sigma_I - \sigma_{II})(\sigma_I - \sigma_{III})} \quad (3.63)$$

$$n_2^2 = \frac{\tau^2 + (\sigma - \sigma_{III})(\sigma - \sigma_I)}{(\sigma_{II} - \sigma_{III})(\sigma_{II} - \sigma_I)} \quad (3.64)$$

$$n_3^2 = \frac{\tau^2 + (\sigma - \sigma_I)(\sigma - \sigma_{II})}{(\sigma_{III} - \sigma_I)(\sigma_{III} - \sigma_{II})} \quad (3.65)$$

In the above equations $\sigma_I, \sigma_{II}, \sigma_{III}$ are known; σ and τ are functions of n_i .

In order to interpret these equations graphically we note that in equation (3.63) $\sigma_I - \sigma_{II} > 0$ and $\sigma_I - \sigma_{III} > 0$, and n_i^2 is positive. Therefore

$$(\sigma - \sigma_{II})(\sigma - \sigma_{III}) + \tau^2 \geq 0 \quad (3.66)$$

When the equality sign holds, this equation may be rewritten as

$$\left[\sigma - \frac{1}{2}(\sigma_{II} + \sigma_{III}) \right]^2 + \tau^2 = \left[\frac{1}{2}(\sigma_{II} - \sigma_{III}) \right]^2 \quad (3.67)$$

which is the equation of a circle in the (σ, τ) -plane, where we assume σ as abscissa and τ as ordinate. The circle in figure 3.12 is termed C_1 and has the center in $\frac{1}{2}(\sigma_{II} + \sigma_{III})$ on the σ axis, and radius $\frac{1}{2}(\sigma_{II} - \sigma_{III})$.

Examining equation (3.64) we observe that $\sigma_{II} - \sigma_{III} > 0$ and $\sigma_{II} - \sigma_I < 0$, so we have

$$(\sigma - \sigma_{III})(\sigma - \sigma_I) + \tau^2 \leq 0 \quad (3.68)$$

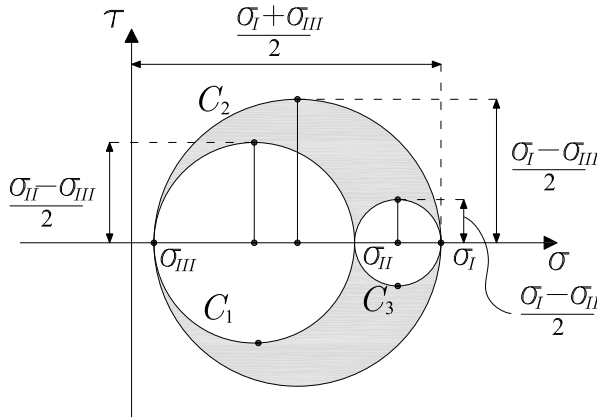

Figure 3.12: Mohr's circles.

The boundary of the area of this equation, i.e. in the case of equality sign, defines a circle as before in the (σ, τ) -plane

$$\left[\sigma - \frac{1}{2} (\sigma_I + \sigma_{III}) \right]^2 + \tau^2 = \left[\frac{1}{2} (\sigma_I - \sigma_{III}) \right]^2 \quad (3.69)$$

named C_2 . See figure 3.12.

The same procedure allows us to obtain from equation (3.65) the circle C_3 , indeed, we have the following condition

$$(\sigma - \sigma_I)(\sigma - \sigma_{II}) + \tau^2 \geq 0 \quad (3.70)$$

that at the boundary yields

$$\left[\sigma - \frac{1}{2} (\sigma_I + \sigma_{II}) \right]^2 + \tau^2 = \left[\frac{1}{2} (\sigma_I - \sigma_{II}) \right]^2 \quad (3.71)$$

Finally, from inequalities (3.66), (3.68), (3.70), it follows that admissible values of σ and τ lie in the shaded region of figure 3.12 bounded by the circles C_1 , C_2 , C_3 . The value τ_{\max} and σ_{\max} can be readily provided from figure 3.12, so that

$$\tau_{\max} = \frac{1}{2} (\sigma_I - \sigma_{III}) \quad (3.72)$$

$$\sigma_{\max} = \frac{1}{2} (\sigma_I + \sigma_{III}) \quad (3.73)$$

and as a consequence, the surface elements supporting these stresses are found replacing the above values into equations (3.63) to (3.65). For further details the reader is referred to [1].

3.5 Stress quadric of Cauchy

Consider an elements of area $d\mathcal{A}$ with a normal vector \bar{n} . As previously stated, the stress vector $\bar{t}_n(p, \bar{n})$ can be decomposed into a *normal* component σ and a *tangential* component τ .

Let us introduce now a local system of axes ξ_i with origin in p equipped with the unit normal basis $\{\bar{e}_i\}$. See figure 3.13.

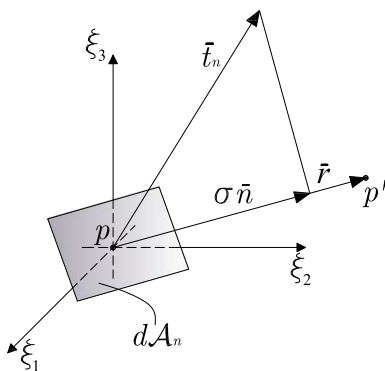

Figure 3.13: Stress quadratic of Cauchy.

Let \bar{r} be the vector taken along \bar{n} joining p with a generic point p' , namely $(p' - p) = r\bar{n}$. This vector can be equivalently expressed by the following expressions

$$\bar{r} = r\bar{n} \quad (3.74)$$

$$\bar{r} = \xi_i \bar{e}_i \quad (3.75)$$

The first equation provides the j -th component of \bar{r} as follows

$$\xi_j = \bar{r} \cdot \bar{e}_j = rn_j \quad (3.76)$$

that, replaced into the expression of the normal component of the stress vector, yields the following relation

$$r^2 \sigma = \sigma_{ij} \xi_i \xi_j \quad (3.77)$$

We recognize equation (3.77) as a quadric form⁷.

⁷We remind that any quadric form F can be expressed as

$$F(\bar{v}) = M_{ij} v_i v_j \quad (3.78)$$

where $\bar{v} = (v_1, v_2, v_3)^T$ is a vector expressed with respect to the chosen basis, and M_{ij} is a certain symmetric matrix that depends on F and on the basis.

So we restrict the coordinates of ξ_i by requiring the end point p' of \bar{r} to lie on the quadric surface

$$F(\xi_1, \xi_2, \xi_3) = \sigma_{ij}\xi_i\xi_j = \pm k^2 \quad (3.79)$$

where k is an arbitrary real constant and where the sign is chosen in such a way to make the surface real. As a result we have

$$\sigma = \pm \frac{k^2}{r^2} \quad (3.80)$$

Since r^2 is a positive quantity, k^2 will be taken with the positive sign whenever the normal component σ is a tension and with negative sign when it represents compression.

Next, deriving equation (3.79) and by using equation (3.76), we obtain

$$\frac{\partial F}{\partial \xi_i} = \sigma_{ij}\xi_j = \sigma_{ij}rn_j = rt_n^i(p, \bar{n}) \quad (3.81)$$

which allows us to realize that the quadric form (3.79) has some properties of a potential function, indeed the partial derivative of F with respect the i -th coordinate gives, except for the constant r , the force component (i.e. the component of the stress vector) right in the i -th direction.

Furthermore we observe that the above derivatives, equation (3.81), denote the direction of the normal \bar{n} to the plane tangent to the quadric surface (3.79) at point p' , so that the right-hand term of equation (3.81) just establishes the stress vector $\bar{t}_n(p, \bar{n})$ is also normal to this tangent plane.

The above results have been directly taken from [1], to which the reader is referred for any further detail.

3.6 Stress-deviator and spherical components of the stress tensor

Every state of stress σ_{ij} may be decomposed into a spherical portion and into a portion s_{ij} known as *stress-deviator* by the following equation

$$\sigma_{ij} = \sigma_M \delta_{ij} + s_{ij} \quad (3.82)$$

where $\sigma_M = \frac{1}{3}\sigma_{ii}$ is the arithmetic mean of the normal stress, i.e. spherical stress component (or hydrostatic stress). Equation (3.82)

may be solved for s_{ij}

$$s_{ij} = \sigma_{ij} - \sigma_M \delta_{ij} \quad (3.83)$$

where the latter components are termed *stress-deviations*.

Namely,

$$s_{ij} = \begin{pmatrix} \sigma_{11} - \sigma_M & \sigma_{12} & \sigma_{13} \\ \sigma_{21} & \sigma_{22} - \sigma_M & \sigma_{23} \\ \sigma_{31} & \sigma_{32} & \sigma_{33} - \sigma_M \end{pmatrix}$$

It is possible to prove that both the stress tensor σ and the deviator tensor s have the same principal directions. The characteristic equation for the deviator is

$$s^3 + J_2 s + J_3 = 0 \quad (3.84)$$

where the deviator invariants are

$$J_2 = -\frac{1}{2} s_{ij} s_{ij}$$

$$J_3 = \det s_{ij}$$

3.7 Stress in shell continua

3.7.1 Shifters

Before reasoning upon the stress state characterizing a shell continuum it is worth introducing some geometrical relations linking points belonging to the mid-surface Q with corresponding points belonging to the shell thought as a three-dimensional continuum.

Therefore, let us recall the relation already met to compute the components of the metric tensor $g_{\alpha\beta}^*$, see equation (2.99) on page 53, between the basis in $p^* \in G(\epsilon)$ and the basis in p projection of p^* on Q along the normal coordinate curve ξ . So we have

$$\bar{\partial}_\alpha^* = \bar{\partial}_\alpha + \xi L_\alpha^\beta \bar{\partial}_\beta \quad (3.85)$$

$$\bar{n} = \bar{n}^* \quad (3.86)$$

which in a short notation assumes the following form

$$\bar{\partial}_i^* = S_i^h \bar{\partial}_h \quad (3.87)$$

Hence, with respect to the basis associated to the coordinate system $\{x^\alpha, \xi\}$ the tensor \mathbf{S} has the following components

$$S_i^h = \begin{pmatrix} 1 + \xi L_1^1 & \xi L_1^2 & 0 \\ \xi L_2^1 & 1 + \xi L_2^2 & 0 \\ 0 & 0 & 1 \end{pmatrix}$$

Therefore, the superficial part of \mathbf{S} can be expressed by the following tensor product

$$\mathbf{S}^\dagger = \mathbf{d}^\gamma \otimes \bar{\partial}_\gamma^\star \quad (3.88)$$

so that

$$\mathbf{S}^\dagger (\bar{\partial}_\beta) = (\mathbf{d}^\gamma \otimes \bar{\partial}_\gamma^\star) (\bar{\partial}_\beta) = \bar{\partial}_\beta^\star \quad (3.89)$$

In the same way we define \mathbf{F}^\dagger as follows

$$\mathbf{F}^\dagger = \bar{\partial}_\gamma \otimes \mathbf{d}^{\star\gamma} \quad (3.90)$$

so that

$$\mathbf{F}^\dagger (\mathbf{d}^\beta) = (\bar{\partial}_\gamma \otimes \mathbf{d}^{\star\gamma}) (\mathbf{d}^\beta) = \mathbf{d}^{\star\beta} \quad (3.91)$$

Tensors \mathbf{S}^\dagger and \mathbf{F}^\dagger are called *shifter* tensors.

3.7.2 Contraction of surface forces

Consider now a curve $c : \mathbb{R} \rightarrow Q$ representing the intersection of the surface Q_c normal to Q which splits the shell continuum $G(\epsilon)$ into two portions.

Let $\bar{\nu} \in \bar{T}Q$ be the unit normal vector applied in p outward pointing from c and let $\bar{l} \in \bar{T}Q$ be the unit vector tangent to c applied in the same point. Then the three unit vectors $\{\bar{\nu}, \bar{l}, \bar{n}\}$ form a local basis in p . A similar triplet of vectors can be defined in p^\star as $\{\bar{\nu}^\star, \bar{l}^\star, \bar{n}\}$. Note that the symbol \star denotes as usual quantities belonging to the shell thickness. See figure 3.14.

In order to ensure the equilibrium condition, the portion of the shell included by Q_c must exert on the remaining part of the continuum a tension such as for each point p^\star is entirely described by the stress vector \bar{t}^\star . Moreover the stress vector t^\star can be equivalently expressed by Cauchy stress tensor as follows

$$\bar{t}^\star(p^\star, \nu^\star) = \sigma^\star(p^\star) \nu^\star \quad (3.92)$$

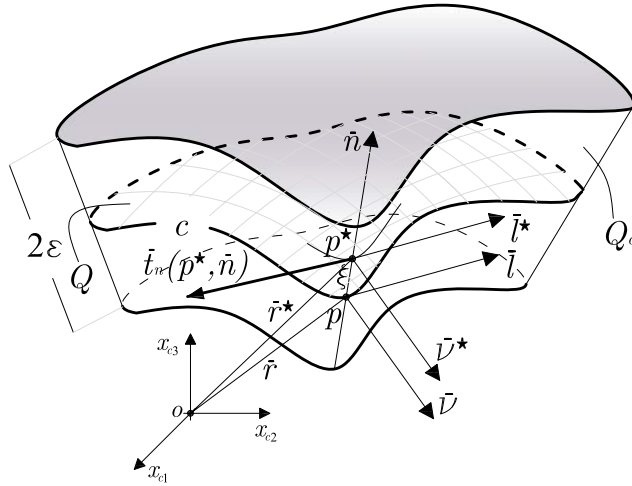

Figure 3.14: Local bases in $G(\epsilon)$ and in Q .

where σ^* is the contravariant form of the stress tensor defined in p^* . For the sake of brevity hereafter $\sigma^*(p^*)$ will be denoted simply by σ .

Now our goal is to establish a relation between the stress state distributed along the surface Q_c and the stress state along the boundary of the mid-surface of the shell. This can be done by means of a reduction, i.e. a contraction, of the stress per unit area to a stress per unit line.

Therefore, let us define two vector fields \mathbf{n} and \mathbf{m} such as

$$\int_c \mathbf{n}(p, \underline{\nu}) dl = \int_{Q_c} \bar{t}^*(p^*, \underline{\nu}^*) dA^* \quad (3.93)$$

$$\int_c \mathbf{m}(p, \underline{\nu}) dl = \int_{Q_c} ((p^* - p) \times \bar{t}^*(p^*, \underline{\nu}^*)) dA^* \quad (3.94)$$

Equalities (3.93) and (3.94) guarantee that the stress system \mathbf{n} and \mathbf{m} is statically equivalent to the stress system \bar{t}^* along the fiber ξ passing through p .

The oriented elemental area in equations (3.93) and (3.94) with respect to the local basis $\{\bar{\nu}^*, \bar{l}^*, \bar{n}\}$ is given by the following vectorial product

$$\underline{\nu}^* dA^* = dl \bar{l}^* \times d\xi \bar{n} \quad (3.95)$$

and since $d\bar{l}^* = dl^\alpha \bar{\partial}_\alpha^*$, equation (3.95) can be equivalently expressed as follows

$$\nu d\mathcal{A}^* = dl^\alpha \bar{\partial}_\alpha^* \times d\xi \bar{n} = \eta_{\alpha\beta}^* dl^\alpha d\xi \bar{\mathbf{d}}^{\star\beta} = \epsilon_{\alpha\beta} \sqrt{g^*} dl^\alpha d\xi \bar{\mathbf{d}}^{\star\beta} \quad (3.96)$$

where $g^* = \det(g_{\alpha\beta}^*)$.

Moreover, back to the mid-surface we notice it is possible to write

$$d\bar{l} \times \bar{n} = \nu dl \quad (3.97)$$

which in the coordinate system $\{x^\alpha, \xi\}$ becomes

$$dl^\alpha \bar{\partial}_\alpha \times \bar{n} = \eta_{\alpha\beta} dl^\alpha \bar{\mathbf{d}}^\beta = \epsilon_{\alpha\beta} \sqrt{g} dl^\alpha \bar{\mathbf{d}}^\beta \quad (3.98)$$

where $g = \det(g_{\alpha\beta})$.

Equation (3.92) and (3.96) allow us to rewrite equations (3.93) and (3.94) as follows

$$\int_c \mathbf{n}(p, \nu) dl = \int_{Q_c} \sigma \epsilon_{\alpha\beta} \sqrt{g^*} dl^\alpha d\xi \bar{\mathbf{d}}^{\star\beta} \quad (3.99)$$

$$\int_c \mathbf{m}(p, \nu) dl = \int_{Q_c} (p^* - p) \times \sigma \epsilon_{\alpha\beta} \sqrt{g^*} dl^\alpha d\xi \bar{\mathbf{d}}^{\star\beta} \quad (3.100)$$

Next, by virtue of the *shifter* F^\dagger , the latter equations become

$$\int_c \mathbf{n}(p, \nu) dl = \int_{Q_c} \sigma \epsilon_{\alpha\beta} \sqrt{g^*} dl^\alpha d\xi (\bar{\partial}_\gamma \otimes \bar{\mathbf{d}}^{\star\gamma}) \bar{\mathbf{d}}^\beta \quad (3.101)$$

$$\int_c \mathbf{m}(p, \nu) dl = \int_{Q_c} \xi \bar{n} \times \sigma \epsilon_{\alpha\beta} \sqrt{g^*} dl^\alpha d\xi (\bar{\partial}_\gamma \otimes \bar{\mathbf{d}}^{\star\gamma}) \bar{\mathbf{d}}^\beta \quad (3.102)$$

which, taking into account equations (3.97) and (3.98), become

$$\int_c \mathbf{n}(p, \nu) dl = \int_c \int_{-\epsilon}^{+\epsilon} \sqrt{\frac{g^*}{g}} \sigma (\bar{\partial}_\gamma \otimes \bar{\mathbf{d}}^{\star\gamma}) \nu dl d\xi \quad (3.103)$$

$$\int_c \mathbf{m}(p, \nu) dl = \int_c \int_{-\epsilon}^{+\epsilon} \xi \bar{n} \times \sqrt{\frac{g^*}{g}} \sigma (\bar{\partial}_\gamma \otimes \bar{\mathbf{d}}^{\star\gamma}) \nu dl d\xi \quad (3.104)$$

and finally

$$\mathbf{n}(p, \nu) = \int_{-\epsilon}^{+\epsilon} \mathbf{g} \sigma (\bar{\partial}_\gamma \otimes \bar{\mathbf{d}}^{\star\gamma}) \nu d\xi \quad (3.105)$$

$$\mathbf{m}(p, \nu) = \bar{n} \times \int_{-\epsilon}^{+\epsilon} \xi \mathbf{g} \sigma (\bar{\partial}_\gamma \otimes \bar{\mathbf{d}}^{\star\gamma}) \nu d\xi \quad (3.106)$$

where we have put $\mathbf{g} = \sqrt{g^*/g}$

Both integrands in (3.105) and (3.106) can be further simplified just substituting $\sigma = \sigma^{ij} (\bar{\partial}_i^* \otimes \bar{\partial}_j^*)$ and $\underline{\nu} = \nu_\alpha \underline{d}^\alpha$ as follows

$$\mathbf{n}(p, \underline{\nu}) = \left(\int_{-\epsilon}^{+\epsilon} \mathbf{g} \sigma^{\alpha j} \bar{\partial}_j^* d\xi \right) \nu_\alpha \quad (3.107)$$

$$\mathbf{m}(p, \underline{\nu}) = \bar{n} \times \left(\int_{-\epsilon}^{+\epsilon} \mathbf{g} \xi \sigma^{\alpha j} \bar{\partial}_j^* d\xi \right) \nu_\alpha \quad (3.108)$$

and using once again equations (3.85) and (3.86) they assume the following form

$$\begin{aligned} \mathbf{n}(p, \underline{\nu}) &= \left(\int_{-\epsilon}^{+\epsilon} \mathbf{g} \sigma^{\alpha \gamma} d\xi + \int_{-\epsilon}^{+\epsilon} \mathbf{g} \sigma^{\alpha \beta} \xi d\xi L_\beta^\gamma \right) \bar{\partial}_\gamma \nu_\alpha + \\ &+ \left(\int_{-\epsilon}^{+\epsilon} \mathbf{g} \sigma^{\alpha \xi} d\xi \right) \bar{n} \nu_\alpha \end{aligned} \quad (3.109)$$

$$\mathbf{m}(p, \underline{\nu}) = \bar{n} \times \left(\int_{-\epsilon}^{+\epsilon} \mathbf{g} \sigma^{\alpha \gamma} \xi d\xi + \int_{-\epsilon}^{+\epsilon} \mathbf{g} \sigma^{\alpha \gamma} \xi^2 d\xi L_\beta^\gamma \right) \bar{\partial}_\gamma \nu_\alpha \quad (3.110)$$

where we can finally define two tensors N and M

$$N = N^{\alpha\beta} (\bar{\partial}_\alpha \otimes \bar{\partial}_\beta) + N^{\alpha\xi} (\bar{\partial}_\alpha \otimes \bar{n}) \quad (3.111)$$

$$M = M^{\alpha\beta} (\bar{\partial}_\alpha \otimes \bar{\partial}_\beta) \quad (3.112)$$

respectively as

$$N^{\alpha\beta} = \int_{-\epsilon}^{+\epsilon} \mathbf{g} \sigma^{\alpha\beta} d\xi + \int_{-\epsilon}^{+\epsilon} \mathbf{g} \sigma^{\alpha\gamma} \xi d\xi L_\gamma^\beta \quad (3.113)$$

$$N^{\alpha\xi} = \int_{-\epsilon}^{+\epsilon} \mathbf{g} \sigma^{\alpha\xi} d\xi \quad (3.114)$$

and

$$M^{\alpha\beta} = \int_{-\epsilon}^{+\epsilon} \mathbf{g} \sigma^{\alpha\beta} \xi d\xi + \int_{-\epsilon}^{+\epsilon} \mathbf{g} \sigma^{\alpha\gamma} \xi^2 d\xi L_\gamma^\beta \quad (3.115)$$

such as

$$\mathbf{n}(p, \underline{\nu}) = N \underline{\nu} = N^{\alpha\beta} \nu_\alpha \bar{\partial}_\beta + N^{\alpha\xi} \nu_\alpha \bar{n} \quad (3.116)$$

$$\mathbf{m}(p, \underline{\nu}) = \bar{n} \times M \underline{\nu} = \bar{n} \times M^{\alpha\beta} \nu_\alpha \bar{\partial}_\beta \quad (3.117)$$

Two fields \mathbf{n} and \mathbf{m} are called *surface stress vector* and *surface couple vector* respectively; while the fields N and M are termed *surface stress tensor* and *surface couple tensor*.

From the above results it is immediate to notice that the surface stress vector \mathbf{n} belongs to $T_Q \bar{E}$, consequently it can be split into a superficial part and an orthogonal part as follows

$$\mathbf{n} = \mathbf{n}^{\parallel} + \mathbf{n}^{\perp} \quad (3.118)$$

where

$$\mathbf{n}^{\parallel} = N^{\alpha\beta} \nu_{\alpha} \bar{\partial}_{\beta} \quad (3.119)$$

$$\mathbf{n}^{\perp} = N^{\alpha\xi} \nu_{\alpha} \bar{n} \quad (3.120)$$

while the surface couple vector \mathbf{m} belongs to $T_Q \bar{Q}$ so that

$$\mathbf{m} = \mathbf{m}^{\parallel} \quad (3.121)$$

As the last remark we point out that the coefficient \mathbf{g} involved in the integration of Cauchy stress tensor along the thickness depends only on the geometrical features of the mid-surface Q , in fact it is easy to prove the following expression

$$\mathbf{g} = \det \left(S_i^h \right) = 1 + \xi H + \xi^2 K \quad (3.122)$$

where H and K are the *mean curvature* and the *total curvature* of the surface Q defined in equations (1.160) and (1.159).

3.7.3 Body forces and load density

Suppose that the curve $c : \mathbb{R} \rightarrow Q$ is closed in such a way as to capture a surface portion $Q' \subset Q$ bounded by $\partial Q \equiv c$. Assuming c to be a directrix, that is a curve through which a line generating a given ruled surface always passes, the generatrices directed along \bar{n} define a cylinder $G_c(\epsilon) \subset G(\epsilon)$ with thickness 2ϵ and also bounded by the surface $Q_c \cup Q^{\epsilon} \cup Q_{-\epsilon}$.

We assume that the volume forces acting at every point belonging to the cylinder $G_c(\epsilon)$ and the load density acting at every point on the upper and lower surfaces Q^{ϵ} and $Q_{-\epsilon}$ can be integrated along

the thickness to yield a new force system defined on the mid-surface Q' as follows

$$\bar{q} : Q' \rightarrow T\bar{Q}'E \quad (3.123)$$

$$\bar{s} : Q' \rightarrow T\bar{Q}' \quad (3.124)$$

where $\bar{q} = q^\beta \bar{\partial}_\beta + q^\xi \bar{n}$ represents the load vector and $\bar{s} = \bar{n} \times s^\beta \bar{\partial}_\beta$ represents the load-moment vector.

See [13] for details.

3.7.4 Eulero's equations

The equilibrium equations for the mid surface portion Q' can be written as follows

$$\int_{\partial Q'} \mathbf{n}(p, \nu) dl + \int_{Q'} \bar{q} dQ' = 0 \quad (3.125)$$

$$\int_{\partial Q'} (\mathbf{m}(p, \nu) + \bar{r} \times \mathbf{n}(p, \nu)) dl + \int_{Q'} (\bar{r} \times \bar{q} + \bar{s}) dQ' = 0 \quad (3.126)$$

which yield

$$\int_{\partial Q'} N_\nu dl + \int_{Q'} \bar{q} dQ' = 0 \quad (3.127)$$

$$\int_{\partial Q'} (\bar{n} \times M_\nu + \bar{r} \times N_\nu) dl + \int_{Q'} (\bar{r} \times \bar{q} + \bar{s}) dQ' = 0 \quad (3.128)$$

Making use of the divergence theorem enounced in equation (1.145) on page 29, and due to the arbitrariness of Q' , the above equations become

$$\operatorname{div} N + \bar{q} = 0 \quad (3.129)$$

$$\operatorname{div} (\bar{n} \times M^{ah} \bar{\partial}_h + \bar{r} \times N^{ah} \bar{\partial}_h) + \bar{r} \times \bar{q} + \bar{s} = 0 \quad (3.130)$$

Equations (3.129) and (3.130) can be written in components as follows

$$\nabla_\alpha^\dagger N^{\alpha\beta} + L_\alpha^\beta N^{\alpha\xi} + q^\beta = 0 \quad (3.131)$$

$$\nabla_\alpha N^{\alpha\xi} + L_{\alpha\gamma} N^{\alpha\gamma} + q^\xi = 0 \quad (3.132)$$

$$\nabla_\alpha^\dagger M^{\beta\alpha} - N^{\xi\beta} + s^\beta = 0 \quad (3.133)$$

$$\eta_{\alpha\beta} \left(L_\gamma^\alpha M^{\beta\gamma} - N^{\alpha\beta} \right) = 0 \quad (3.134)$$

where equations (3.131) assure the translational equilibrium in the tangent plane, while (3.132) represents the translational equilibrium along the normal direction. Next, two equations in (3.133) impose the rotational equilibrium about the surface axes, respectively. Finally, the last equilibrium condition (3.134) gives the symmetry to the tensor $L_\gamma^\alpha M^{\beta\gamma} - N^{\alpha\beta}$.

PROOF

Here we want to show all steps we made to pass from the equilibrium equations (3.129) and (3.130) to the corresponding expressions in components (3.131) to (3.134).

Let us start from equation (3.129). We invoke the definition of divergence for second order contravariant tensors already used in equation (1.147), so we have

$$\begin{aligned} (\operatorname{div} N)^h &= N_{,\alpha}^{\alpha h} + \Gamma_{\alpha\gamma}^\alpha N^{\gamma h} + \Gamma_{\alpha t}^h N^{\alpha t} = \\ &= N_{,\alpha}^{\alpha\beta} + N_{,\alpha}^{\alpha\xi} + \Gamma_{\alpha\gamma}^\alpha N^{\gamma\beta} + \Gamma_{\alpha\gamma}^\alpha N^{\gamma\xi} + \Gamma_{\alpha t}^\beta N^{\alpha t} + \Gamma_{\alpha t}^\xi N^{\alpha t} = \\ &= N_{,\alpha}^{\alpha\beta} + N_{,\alpha}^{\alpha\xi} + \Gamma_{\alpha\gamma}^\alpha N^{\gamma\beta} + \Gamma_{\alpha\gamma}^\alpha N^{\gamma\xi} + \\ &\quad + \Gamma_{\alpha\gamma}^\beta N^{\alpha\gamma} + \Gamma_{\alpha\xi}^\beta N^{\alpha\xi} + \Gamma_{\alpha\gamma}^\xi N^{\alpha\gamma} + \Gamma_{\alpha\xi}^\xi N^{\alpha\xi} \end{aligned}$$

Now we just need to separate the tangential and normal components as follows

$$(\operatorname{div} N)^\beta = N_{,\alpha}^{\alpha\beta} + \Gamma_{\alpha\gamma}^\alpha N^{\gamma\beta} + \Gamma_{\alpha\gamma}^\beta N^{\alpha\gamma} + \Gamma_{\alpha\xi}^\beta N^{\alpha\xi} \quad (3.135)$$

$$(\operatorname{div} N)^\xi = N_{,\alpha}^{\alpha\xi} + \Gamma_{\alpha\gamma}^\alpha N^{\gamma\xi} + \Gamma_{\alpha\xi}^\xi N^{\alpha\xi} + \Gamma_{\alpha\gamma}^\xi N^{\alpha\gamma} \quad (3.136)$$

By virtue of the identity $(\nabla_\alpha \bar{n})^\beta = L_\alpha^\beta = \Gamma_{\alpha\xi}^\beta$ equation (3.135) becomes

$$(\operatorname{div} N)^\beta = \nabla_\alpha^\dagger N^{\alpha\beta} + L_\alpha^\beta N^{\alpha\xi} \quad (3.137)$$

where we have just collected the surface divergence⁸ terms into

$$\nabla_\alpha^\dagger N^{\alpha\beta} = N_{,\alpha}^{\alpha\beta} + \Gamma_{\alpha\gamma}^\alpha N^{\gamma\beta} + \Gamma_{\alpha\gamma}^\beta N^{\alpha\gamma} \quad (3.138)$$

Equation (3.137) proves the in-plane translational equilibrium expressed in (3.131).

Concerning equation (3.136), the translational equilibrium along the normal direction is readily proved remembering both $\Gamma_{\alpha\gamma}^\xi = L_{\alpha\gamma}$ and⁹

$$\nabla_\alpha N^{\alpha\xi} = N_{,\alpha}^{\alpha\xi} + \Gamma_{\alpha\gamma}^\alpha N^{\gamma\xi} + \Gamma_{\alpha\xi}^\xi N^{\alpha\xi} \quad (3.139)$$

⁸In literature the divergence of the surface tensor $N^{\alpha\beta}$ is often denoted by $N_{|\alpha}^{\alpha\beta}$.

⁹In literature the divergence $\nabla_\alpha^\dagger N^{\alpha\xi}$ is often denoted by $N_{|\alpha}^{\alpha\xi}$.

Hence we obtain

$$(\operatorname{div} N)^\xi = \nabla_\alpha N^{\alpha\xi} + L_{\alpha\gamma} N^{\alpha\gamma} \quad (3.140)$$

which finally proves equation (3.132)

In order to prove equations (3.133) and (3.134), first we simplify equation (3.130) by taking into account equation (3.129). So it becomes

$$\operatorname{div} \bar{n} \times M^{\alpha h} \bar{\partial}_h + \bar{n} \times \operatorname{div} (M^{\alpha h} \bar{\partial}_h) + \operatorname{div} \bar{r} \times N^{\alpha h} \bar{\partial}_h + \bar{s} = 0 \quad (3.141)$$

We can split the divergence of the tensor $M^{\alpha h}$ in accordance with the results in (3.137) and (3.140), thus we have

$$\begin{aligned} & \nabla_\alpha \bar{n} \times M^{\alpha h} \bar{\partial}_h + \bar{n} \times (\nabla_\alpha^\dagger M^{\alpha\beta} + L_\gamma^\beta M^{\gamma\xi}) \bar{\partial}_\beta + \\ & + \bar{n} \times (\nabla_\alpha^\dagger M^{\alpha\xi} + L_{\alpha\gamma} M^{\alpha\gamma}) \bar{n} + \bar{r}_{,\alpha} \times N^{\alpha h} \bar{\partial}_h + \bar{s} = 0 \end{aligned} \quad (3.142)$$

which after further algebra becomes

$$\begin{aligned} & L_\alpha^\gamma \bar{\partial}_\gamma \times M^{\alpha\omega} \bar{\partial}_\omega + L_\alpha^\gamma \bar{\partial}_\gamma \times M^{\alpha\xi} \bar{n} + \bar{n} \times (\nabla_\alpha^\dagger M^{\alpha\beta} + L_\gamma^\beta M^{\gamma\xi}) \bar{\partial}_\beta + \\ & + \bar{\partial}_\alpha \times N^{\alpha\omega} \bar{\partial}_\omega + \bar{\partial}_\alpha \times N^{\alpha\xi} \bar{n}_\omega + \bar{n} \times s^\beta \bar{\partial}_\beta = 0 \end{aligned} \quad (3.143)$$

Collecting the normal and tangential terms we obtain the following three scalar equations

$$\eta_{\gamma\omega} (L_\alpha^\gamma M^{\alpha\omega} + N^{\gamma\omega}) = 0 \quad (3.144)$$

and

$$\bar{n} \times (\nabla_\alpha^\dagger M^{\alpha\beta} - N^{\beta\xi} + s^\beta) \bar{\partial}_\beta = 0 \quad (3.145)$$

which finally proves the rotational equilibrium (3.133) about the surface axes. \diamond

Usually a new variable is introduced to make easier possible further calculations; in fact we define the **pseudo-stress tensor** the symmetric tensor

$$\tilde{N}^{\alpha\beta} = N^{\alpha\beta} - L_\gamma^\alpha M^{\beta\gamma} \quad (3.146)$$

It is straightforward to notice that $\tilde{N} \equiv N$ only when either a membrane stress state holds or for flat shells, namely when *Weingarten's* tensor is identically zero.

3.7.5 Membrane state of stress

In this last section we introduce an hypothesis on the state of the stress that enables us to derive a closed form solution for several shell geometries without invoking the constitutive law. Examples of these closed form solutions will be provided in appendix A.

A shell continuum is subjected to a membrane stress state when both the following condition hold

$$N^{\alpha\xi} = 0 \quad (3.147)$$

$$M^{\alpha\beta} = 0 \quad (3.148)$$

Hence, the equilibrium equations become

$$\nabla_{\alpha} N^{\alpha\beta} + q^{\beta} = 0 \quad (3.149)$$

$$L_{\alpha\gamma} N^{\alpha\gamma} + q^{\xi} = 0 \quad (3.150)$$

$$\eta_{\alpha\beta} N^{\alpha\beta} = 0 \quad (3.151)$$

where equation (3.149) represents the translational equilibrium along the tangent plane; equation (3.150) represents the equilibrium along \bar{n} and finally equation (3.151) states the rotational equilibrium about \bar{n} and establishes the symmetry of N .

Chapter 4

Equations of elasticity

Chapters 2 and 3 of these notes do not specifically concern with the elastic media, in fact they can be understood for a generic continuum and studied independently. In this section we shall combine the previous results in order to investigate the response of elastic bodies under the action of forces.

A body is called elastic if it has the property of recovering its original shape when the forces which produce the deformations are removed. This property can be characterized mathematically by certain relationships connecting force and displacement, that are also called constitutive laws. In particular we will analyze the linear constitutive law as a generalization of the Hooke's law.

4.1 The material law

It was Robert Hooke¹ who in 1676 gave the first rough law of proportionality between forces and displacements for an elastic body. In order to understand the key features of elasticity, let us consider a thin rod with an initial cross section \mathcal{A}_0 , which is subjected to a variable tensile force F . We suppose that the stress is distributed uniformly over the area \mathcal{A}_0 and the initial cross-sectional area stays constant. The stress is obtained by dividing the force at any stage by the area \mathcal{A}_0 . So, $\sigma = F/\mathcal{A}_0$. The relationship between F and the axial strain ε is plotted in figure 4.1 on the next page.

Figure 4.1 shows that until the point P the relationship $\sigma - \varepsilon$

¹Robert Hooke (July 18, 1635 Freshwater (Isle of Wight) - March 3, 1703 London) was an English scientist.



Source: <http://turnbull.mcs.st-and.ac.uk/history/Biographies/Hooke.html>.

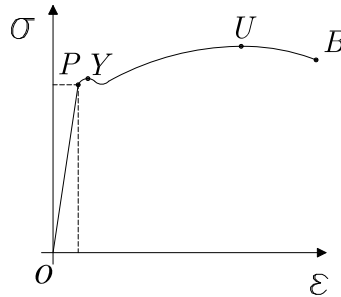

Figure 4.1: Hooke's law.

is nearly a straight line with the following equation

$$\sigma = E\varepsilon \quad (4.1)$$

where the constant of proportionality E is known as *modulus of elasticity* or *Young's modulus*.

The greatest stress that can be applied to the rod without producing a permanent deformation is called *elastic limit* of the material. When the force F is increased beyond this limit the material goes in the elastic-plastic field. Namely, firstly the material reaches the *yield-point* Y at which the rod suddenly stretches, then the material reaches the *ultimate stress* at U where it offers the maximum stress. If the elongation increases again both the cross sectional area \mathcal{A}_0 and the stress decrease until the rod breaks at B .

From now on we shall study only the *elastic range*.

4.1.1 Generalized Hooke's law

Here we want to extend the results of Hooke's law to a multidimensional state of stress and strain. So, in accordance with equation (4.1), let us write a linear relation

$$\sigma_{ij} = C_{ijhk}\varepsilon_{hk} \quad i, j, h, k = 1, 2, 3 \quad (4.2)$$

The coefficients C_{ijhk} are independent from the position of the reference point in the continuous medium, in other words we require the homogeneity of the body, that means uniformity in structure and composition. It can also be shown that the elastic constants

C_{ijhk} are 81 components of a fourth order tensor which is termed *elasticity tensor*.

Since the stress tensor σ_{ij} is symmetric, an interchange of the first two indices in (4.2) does not alter its meaning. In addition to that, the symmetry of the strain tensor ensures also the symmetry of the last two indices, so that

$$C_{ijhk} = C_{jihk} \quad (4.3)$$

$$C_{ijhk} = C_{ijkh} \quad (4.4)$$

That means that the 3^4 components of C reduce to 36 independent constants. Let us show the expansion of a generic component of the stress tensor, that is

$$\begin{aligned} \sigma_{11} = & C_{1111}\varepsilon_{11} + C_{1112}\varepsilon_{12} + C_{1113}\varepsilon_{13} + \\ & C_{1121}\varepsilon_{21} + C_{1122}\varepsilon_{22} + C_{1123}\varepsilon_{23} + \\ & C_{1131}\varepsilon_{31} + C_{1132}\varepsilon_{32} + C_{1133}\varepsilon_{33} \end{aligned} \quad (4.5)$$

Equations (4.3) and (4.4) allow (4.5) to be rewritten as follows

$$\begin{aligned} \sigma_{11} = & C_{1111}\varepsilon_{11} + C_{1122}\varepsilon_{22} + C_{1133}\varepsilon_{33} + \\ & 2C_{1112}\varepsilon_{12} + 2C_{1113}\varepsilon_{13} + 2C_{1123}\varepsilon_{23} \end{aligned}$$

Thus, the whole elastic matrix can be written as

$$\begin{pmatrix} \sigma_{11} \\ \sigma_{22} \\ \sigma_{33} \\ \sigma_{12} \\ \sigma_{23} \\ \sigma_{31} \end{pmatrix} = \begin{pmatrix} C_{1111} & C_{1122} & C_{1133} & 2C_{1112} & 2C_{1123} & 2C_{1131} \\ & C_{2222} & C_{2233} & 2C_{2212} & 2C_{2223} & 2C_{2231} \\ & & C_{3333} & 2C_{3312} & 2C_{3323} & 2C_{3331} \\ & & & 2C_{1212} & 2C_{1223} & 2C_{1231} \\ & \text{sym.} & & & 2C_{2323} & 2C_{2331} \\ & & & & & 2C_{3131} \end{pmatrix} \begin{pmatrix} \varepsilon_{11} \\ \varepsilon_{22} \\ \varepsilon_{33} \\ \varepsilon_{12} \\ \varepsilon_{23} \\ \varepsilon_{31} \end{pmatrix}$$

which, making use of the symmetry relationships expressed in (4.3) and (4.4), simplifies as follows

$$\begin{pmatrix} \sigma_{11} \\ \sigma_{22} \\ \sigma_{33} \\ \sigma_{12} \\ \sigma_{23} \\ \sigma_{31} \end{pmatrix} = \begin{pmatrix} c_{11} & c_{12} & c_{13} & c_{14} & c_{15} & c_{16} \\ & c_{22} & c_{23} & c_{24} & c_{25} & c_{26} \\ & & c_{33} & c_{34} & c_{35} & c_{36} \\ & & & c_{44} & c_{45} & c_{46} \\ & \text{sym.} & & & c_{55} & c_{56} \\ & & & & & c_{66} \end{pmatrix} \begin{pmatrix} \varepsilon_{11} \\ \varepsilon_{22} \\ \varepsilon_{33} \\ \varepsilon_{12} \\ \varepsilon_{23} \\ \varepsilon_{31} \end{pmatrix}$$

Later on, see equation (6.10), we will also introduce another symmetry condition that has been assumed in the above. Namely, the condition

$$C_{ijhk} = C_{hki j} \quad (4.6)$$

that further reduces the independent elastic constant from 36 to 21. So, the latter material equation represents the constitutive law for an *anisotropic* elastic material. However, most of the engineering materials have some symmetry properties which allow further reductions of the elastic constants.

The highest degree of symmetry leads to the so called *isotropic* material. We define an isotropic material an elastic continuum which has the same response in any direction, so that the elastic tensor is not influenced by any rotation of the references axes.

Let the elastic tensor be represented by C_{ijhk} with respect to the cartesian coordinate $\{x^i\}$ whose basis is $\mathcal{B} = \{\bar{e}_i\}$. With respect to a rotated system $\{x'^i\}$ with basis $\mathcal{B}' = \{\bar{e}'_i\}$ the elasticity tensor is C'_{ijhk} . By the definition of isotropic material, we expect that the elasticity tensor does not change. In order to show this, let us recall the transformation relations (1.36) on chapter 1. Here we are dealing with a Cartesian coordinate system, hence it does not matter if the indices are all subscripts. So, we have

$$\begin{aligned} C'_{ijhk} &= a'_{il}a'_{jm}C_{lmno}a_{oh}a_{nk} \\ &= a'_{il}a'_{jm}a'_{ho}a'_{kn}C_{lmno} \end{aligned} \quad (4.7)$$

but to ensure the immunity against the rotation of the reference system, we impose

$$C'_{ijhk} = C_{lmno} \quad (4.8)$$

that is only satisfied if the elasticity tensor assumes the following form

$$C_{lmno} = \lambda\delta_{lm}\delta_{no} + \mu\delta_{ln}\delta_{mo} + \kappa\delta_{lo}\delta_{mn} \quad (4.9)$$

where λ , μ , κ are elastic constants².

²This can be proved by replacing equation (4.9) into (4.7), as follows

$$\begin{aligned} C'_{ijhk} &= a'_{il}a'_{jm}a'_{ho}a'_{kn}(\lambda\delta_{lm}\delta_{no} + \mu\delta_{ln}\delta_{mo} + \kappa\delta_{lo}\delta_{mn}) = \\ &= \lambda a'_{im}a'_{jm}a'_{ho}a'_{ko} + \mu a'_{in}a'_{jo}a'_{hn}a'_{ko} + \kappa a'_{io}a'_{jn}a'_{hn}a'_{ko} = \\ &\quad \lambda\delta_{ij}\delta_{hk} + \mu\delta_{ih}\delta_{jk} + \kappa\delta_{ik}\delta_{jh} \end{aligned}$$

that is exactly the expression (4.9). Note that we have used the identity $a'_{ps}a'_{qs} = \delta_{pq}$ provided by equations (1.21) and (1.24) on page 7.

In equations (4.3) and (4.4) we have already noticed the symmetry of C in relation to the two front and two back indices, let us show now that one more reduction is possible

$$C_{ijhk} = \lambda \delta_{ij} \delta_{hk} + \mu \delta_{ih} \delta_{jk} + \kappa \delta_{ik} \delta_{jh} \quad (4.10)$$

$$C_{ijkh} = \lambda \delta_{ij} \delta_{kh} + \mu \delta_{ik} \delta_{jh} + \kappa \delta_{ih} \delta_{jk} \quad (4.11)$$

where, subtracting term by term and considering the symmetry of the unit tensor δ_{ij} , equations (4.10) and (4.11) lead to the only possible condition

$$\begin{aligned} \mu (\delta_{ih} \delta_{jk} - \delta_{ik} \delta_{jh}) + \kappa (\delta_{ik} \delta_{jh} - \delta_{ih} \delta_{jk}) &= 0 \Rightarrow \\ \mu (\delta_{ih} \delta_{jk} - \delta_{ik} \delta_{jh}) - \kappa (\delta_{ih} \delta_{jk} - \delta_{ik} \delta_{jh}) &= 0 \Rightarrow \\ (\mu - \kappa) (\delta_{ih} \delta_{jk} - \delta_{ik} \delta_{jh}) &= 0 \end{aligned} \quad (4.12)$$

which is only true if $(\mu - \kappa) = 0$. So, the relationship between κ and μ further reduces the number of elastic constants to 2. Namely, we have

$$C_{ijhk} = \lambda \delta_{ij} \delta_{hk} + \mu (\delta_{ih} \delta_{jk} + \delta_{ik} \delta_{jh}) \quad (4.13)$$

The Hooke's law becomes

$$\begin{aligned} \sigma_{ij} &= C_{ijhk} \varepsilon_{hk} = \lambda \delta_{ij} \delta_{hk} \varepsilon_{hk} + \mu (\delta_{ih} \delta_{jk} + \delta_{ik} \delta_{jh}) \varepsilon_{hk} = \\ &= \dots \\ &= \lambda \delta_{ij} \varepsilon_{hh} + 2\mu \varepsilon_{ij} \end{aligned} \quad (4.14)$$

where we have used $\delta_{hk} \varepsilon_{hk} = \varepsilon_{hh} = \text{tr} \varepsilon_{hk}$.

Equation (4.14) is the generalized form of Hooke's law, valid for homogeneous, isotropic, elastic bodies. λ and μ are called *Lamé constants*³.

³Gabriel Lamé (July 22, 1795 Tours - May 1, 1870 Paris) was a French mathematician and engineer.



The trace of the stress tensor is readily computed by contracting the indices, so that

$$\sigma_{ii} = 3\lambda\varepsilon_{hh} + 2\mu\varepsilon_{ii} \Rightarrow \quad (4.15)$$

$$\sigma_{ii} = (2\mu + 3\lambda)\varepsilon_{hh} \Rightarrow \quad (4.16)$$

$$\varepsilon_{hh} = \frac{\sigma_{ii}}{(2\mu + 3\lambda)} \quad (4.17)$$

where we can put $\text{tr}\sigma_{ij} = \sigma_{ii} = \Sigma$ and $\text{tr}\varepsilon_{ij} = \varepsilon_{ii} = \Theta$.

The above expression (4.17) is useful if we solve (4.14) for ε_{ij} . In fact, we have

$$\varepsilon_{ij} = \frac{1}{2\mu}\sigma_{ij} - \frac{\lambda}{2\mu}\delta_{ij}\Theta \quad (4.18)$$

and in observance of (4.17) we obtain

$$\varepsilon_{ij} = \frac{1}{2\mu}\sigma_{ij} - \frac{\lambda}{2\mu(3\lambda + 2\mu)}\delta_{ij}\Sigma \quad (4.19)$$

Now, let us consider an axial state of stress. The stress tensor is

$$\sigma_{ij} = \begin{pmatrix} \sigma_{11} & 0 & 0 \\ 0 & 0 & 0 \\ 0 & 0 & 0 \end{pmatrix}$$

form (4.19) we have

$$\begin{aligned} \varepsilon_{11} &= \frac{1}{2\mu} \left(1 - \frac{\lambda}{(3\lambda + 2\mu)} \right) \sigma_{11} = \\ &= \dots \\ &= \frac{\lambda - \mu}{\mu(3\lambda + 2\mu)} \sigma_{11} \end{aligned} \quad (4.20)$$

$$\varepsilon_{22} = \varepsilon_{33} = -\frac{\lambda}{2\mu(3\lambda + 2\mu)} \sigma_{11} \quad (4.21)$$

$$(4.22)$$

Let us define *Poisson's ratio* ν as follows

$$\nu = -\frac{\varepsilon_{11}}{\varepsilon_{22}} = -\frac{\varepsilon_{11}}{\varepsilon_{33}} = \frac{\lambda}{2(\mu + \lambda)} \quad (4.23)$$

	λ	$\mu \equiv G$	E	ν
λ, μ	-	-	$\frac{\mu(3\lambda+2\mu)}{\lambda+\mu}$	$\frac{\lambda}{2(\lambda+\mu)}$
λ, ν	-	$\frac{\lambda(1-2\nu)}{2\nu}$	$\frac{\lambda(1+\nu)(1-2\nu)}{\nu}$	-
μ, E	$\frac{\mu(E-2\mu)}{3\mu-E}$	-	-	$\frac{E-2\mu}{2\mu}$
μ, ν	$\frac{2\mu\nu}{1-2\nu}$	-	$2\mu(1+\nu)$	-
E, ν	$\frac{E\nu}{(1+\nu)(1-2\nu)}$	$\frac{E}{2(1+\nu)}$	-	-

Table 4.1: Relationships between the main elastic constants.

According to Hooke's law in the original form, see equation (4.1), we can see that

$$\frac{1}{E} = \frac{\lambda - \mu}{\mu(3\lambda + 2\mu)} \Rightarrow E = \frac{\mu(3\lambda + 2\mu)}{\lambda - \mu} \quad (4.24)$$

So, we have proved that Lamé constants can be replaced by E and ν which lead to writing the alternative expressions of the constitutive law

$$\varepsilon_{ij} = \frac{1}{E} ((1 + \nu) \sigma_{ij} - \nu \delta_{ij} \Sigma) \quad (4.25)$$

$$\sigma_{ij} = \frac{E}{1 + \nu} \left(\varepsilon_{ij} + \frac{\nu}{1 - 2\nu} \delta_{ij} \Theta \right) \quad (4.26)$$

Table 4.1 shows the relationships between elastic constants.

4.2 The linear elastic problem

In this section we are going to sum up equations and unknown quantities which define the classical linear elastic problem. Then we will estimate the distribution of stresses and strain as well as displacements at all points of the body when certain boundary conditions are given. Let us balance the unknowns and the equations, we have fifteen unknowns (6 stress components + 6 strain components + 3 displacement components) for all points in the continuous and just fifteen equations (6 equilibrium + 6 compatibility + 3

boundary conditions). So, for a given linear elastic body \mathcal{V} we have

$$C = \text{const.} \quad (4.27)$$

$$\bar{b} = \bar{b}(p) \quad \forall p \in \mathcal{V} \quad (4.28)$$

$$\bar{f} = \hat{f}(p) \quad \forall p \in \mathcal{S}_\sigma \quad (4.29)$$

$$\bar{u} = \hat{u}(p) \quad \forall p \in \mathcal{S}_u \quad (4.30)$$

In order to solve the linear elastic problem we start from the known quantities (4.27) to (4.30), and through the following available equations

- compatibility equations

$$\varepsilon_{ij} = \frac{1}{2}(u_{i,j} + u_{j,i}) \quad \text{on } \mathcal{V} \quad (4.31)$$

- equilibrium equations

$$\sigma_{ij,j} + b_i = 0 \quad \text{on } \mathcal{V} \quad (4.32)$$

- constitutive laws

$$\sigma_{ij} = \frac{E}{1+\nu} \left(\varepsilon_{ij} + \frac{\nu}{1-2\nu} \delta_{ij} \varepsilon_{ij} \right) \quad \text{on } \mathcal{V} \quad (4.33)$$

- boundary conditions

$$\sigma_{ij} n_j = \hat{f}_i \quad \text{on } \mathcal{S}_\sigma \quad (4.34)$$

$$u_i = \hat{u}_i \quad \text{on } \mathcal{S}_u \quad (4.35)$$

we will formulate two boundary-value problems.

4.2.1 Boundary value problem in terms of stresses

This first boundary value problem can be stated as follows:

Determine the distribution of stresses and displacements in the interior of an elastic body in equilibrium when the body forces are prescribed and the distribution of the forces acting on the surface of the body is known⁴.

⁴Sokolnikoff [1].

Following the above formulation, the procedure for solving the problem would suggest writing the available equations entirely in terms of stress. To this aim let us start from equation (2.75)

$$\varepsilon_{ij,hk} + \varepsilon_{hk,ij} - \varepsilon_{ih,jk} - \varepsilon_{jk,ih} = 0 \quad (4.36)$$

and consider the constitutive law (4.25), so that

$$\begin{aligned} & \frac{1+\nu}{E} (\sigma_{ij,hk} + \sigma_{hk,ij} - \sigma_{ih,jk} - \sigma_{jk,ih}) = \\ & = \frac{\nu}{E} (\delta_{ij}\sigma_{nn,hk} + \delta_{hk}\sigma_{nn,ij} - \delta_{ih}\sigma_{nn,jk} - \delta_{jk}\sigma_{nn,ih}) \end{aligned} \quad (4.37)$$

Equation (4.37) represents a set $3^4 = 81$ equations since all the four indices i, j, h, k run from 1 to 3. Not all of these equations are independent, indeed the system (4.37) contains only 6 independent equations. A first reduction of equations is due to the contraction $h = k$ that yields

$$\begin{aligned} & \sigma_{ij,kk} + \sigma_{kk,ij} - \sigma_{ik,jk} - \sigma_{jk,ik} = \\ & = \frac{\nu}{1+\nu} (\delta_{ij}\sigma_{nn,kk} + \delta_{kk}\sigma_{nn,ij} - \delta_{ik}\sigma_{nn,jk} - \delta_{jk}\sigma_{nn,ik}) \end{aligned} \quad (4.38)$$

that, by denoting $\Sigma = \text{tr}\sigma_{ij} = \sigma_{ii}$ and $\sigma_{ij,kk} = \nabla^2\sigma_{ij}$, becomes

$$\nabla^2\sigma_{ij} + \Sigma_{,ij} - \sigma_{ik,jk} - \sigma_{jk,ik} = \frac{\nu}{1+\nu} (\delta_{ij}\nabla^2\Sigma + \nabla^2\Sigma_{ij}) \quad (4.39)$$

By virtue of the equilibrium equations (4.32), the above expression can be rewritten as follows

$$\nabla^2\sigma_{ij} + \frac{1}{1+\nu}\Sigma_{,ij} = - \left(b_{i,j} + b_{j,j} - \frac{\nu}{1+\nu}\delta_{ij}\nabla^2\Sigma \right) \quad (4.40)$$

which is a set of 6 independent equations.

Next, in order to express $\nabla^2\Sigma$ as a function of the body force \bar{b} , we put $h = i$ and $k = j$ in equation (4.37), so that, after a bit of algebra, we have

$$\begin{aligned} \sigma_{ij,ij} &= \nabla^2\Sigma - 2\frac{\nu}{1+\nu}\nabla^2\Sigma \\ &= \dots \\ &= \frac{1-\nu}{1+\nu}\nabla^2\Sigma \end{aligned} \quad (4.41)$$

and finally, by invoking the derivative of the equilibrium equation that provides the relationships $b_{i,i} = \sigma_{ij,ij}$, we get

$$\nabla^2 \Sigma = -\frac{1+\nu}{1-\nu} b_{i,i} \quad (4.42)$$

Now, going back to equation (4.40) and making use of the latter result, it is not a difficult task to obtain the following expression

$$\nabla^2 \sigma_{ij} + \frac{1}{1+\nu} \Sigma_{,ij} = -\left(b_{i,j} + b_{j,i} + \frac{\nu}{1-\nu} \delta_{ij} \operatorname{div} \bar{b} \right) \quad (4.43)$$

Equations (4.43) were derived by *Michell*⁵ in 1900 and by *Beltrami*⁶ in the 1892 for the special case when the body forces are absent. Nevertheless, it is common to refer to equation (4.43) as *Beltrami-Michell* equations.

In case of missing or constant volume forces equation (4.43) assumes the straightforward form

$$\nabla^2 \sigma_{ij} + \frac{1}{1+\nu} \Sigma_{ij} = 0 \quad (4.44)$$

4.2.2 Boundary value problem in terms of displacements

The second boundary value problem can be stated as follows:

Determine the distribution of stresses and displacements in the interior of an elastic body in equilibrium

⁵John Henry Michell (October 26, 1863 - February 3, 1940) was an Australian mathematician.



Source: <http://en.wikipedia.org/wiki/>

⁶Eugenio Beltrami (November 16, 1835 Cremona - February 18, 1900 Rome) was an Italian mathematician.



Source: <http://www-groups.dcs.st-and.ac.uk/history/Biographies/Beltrami.html>.

when the body forces are prescribed and the displacements of the points on the surface are prescribed functions⁷.

By replacing the constitutive law in the form of (4.14) into equilibrium equation, we obtain

$$(\lambda\delta_{ij}\varepsilon_{kk})_{,j} + 2\mu\varepsilon_{ij,j} + b_i = 0 \quad (4.45)$$

that is

$$\lambda\varepsilon_{kk,i} + 2\mu\varepsilon_{ij,j} + b_i = 0 \quad (4.46)$$

and in accordance with the compatibility equations we have

$$\lambda u_{k,ki} + \mu(u_{i,jj} + u_{j,ij}) + b_i = 0 \quad (4.47)$$

$$\lambda u_{k,ki} + \mu\nabla^2 u_i + \mu u_{k,ik} + b_i = 0 \quad (4.48)$$

$$(\lambda + \mu) u_{k,ki} + \mu\nabla^2 u_i + b_i = 0 \quad (4.49)$$

that in the vectorial form reads

$$(\lambda + \mu) \text{grad div } \bar{u} + \mu\nabla^2 \bar{u} + \bar{b} = 0 \quad (4.50)$$

Equation (4.49) (or equivalently equation (4.50)) is called *Lamé-Navier* equation and together with the boundary conditions expressed by equation (4.35) define the boundary problem in terms of displacements.

Once the first boundary value problem has been solved, i.e. when the displacements are known, the state of strain and hence the state of stress can be found through equations (4.31) and (4.33), respectively.

Further attention should be focused on the case when body forces do not occur or they are constant. First, consider the divergence of equation (4.49)

$$(\lambda + \mu) u_{k,kii} + \mu\nabla^2 u_{i,i} + b_{i,i} = 0 \quad (4.51)$$

that yields

$$\lambda\nabla^2 u_{k,k} + 2\mu\nabla^2 u_{k,k} + b_{i,i} = (\lambda + 2\mu) \nabla^2 u_{k,k} + b_{i,i} = 0 \quad (4.52)$$

⁷Sokolnikoff [1].

which, under the hypothesis of $b_i = \text{const.}$, so that $b_{i,i} = 0$, gives

$$\nabla^2 u_{k,k} = \nabla^2 \Theta = 0 \quad (4.53)$$

where we have set $\Theta = \text{tr} \varepsilon_{ij} = \varepsilon_{ii}$.

Moreover, recalling (4.17) it is also proved that

$$\nabla^2 \sigma_{kk} = 0 \quad (4.54)$$

We can finally say that if the volume forces are constant, the boundary linear elastic problem in terms of displacements turns into a general boundary values problem of a biharmonic differential equation.

4.3 Constitutive equation for shell continuums

The Kirchhoff–Love hypothesis and the inextensibility of material fibers along \bar{n} allows one to consider the shear stress components $N^{\xi\alpha}$ unrelated to strains, so that the constitutive problem can be solved through the plane stress model. Thus, components $N^{\xi\alpha}$ are found only by means of the equilibrium equations. The analytical derivation of the constitutive equations is beyond the scope of this book, so we will just present the final equations that will be used in the appendix A in order to solve some case studies. However, readers can find thorough discussions in [3] and [16].

Suppose a membrane state of stress, the constitutive equations are the following

$$\tilde{N}^{\alpha\beta} = DH^{\alpha\beta\lambda\mu} \alpha_{\lambda\mu} \quad (4.55)$$

$$M^{\alpha\beta} = BH^{\alpha\beta\lambda\mu} \omega_{\lambda\mu} \quad (4.56)$$

where

$$H^{\alpha\beta\lambda\mu} = \frac{1-\nu}{2} (g^{\alpha\lambda} g^{\beta\mu} + g^{\alpha\mu} g^{\beta\lambda} + \frac{2\nu}{1-\nu} g^{\alpha\beta} g^{\lambda\mu}) \quad (4.57)$$

The fourth-order tensor $H^{\alpha\beta\lambda\mu}$ has the following symmetries

$$H^{\alpha\beta\lambda\mu} = H^{\beta\alpha\lambda\mu} = H^{\alpha\beta\mu\lambda} = H^{\lambda\mu\alpha\beta} \quad (4.58)$$

Finally, coefficients D and B are the in-plane and the bending stiffness, respectively, defined as

$$D = \frac{E(2\varepsilon)}{1 - \nu^2} \quad (4.59)$$

$$B = \frac{E(2\varepsilon)^3}{12(1 - \nu^2)} \quad (4.60)$$

Chapter 5

Principle of Virtual Work

This chapter is entirely devoted to the Principle of the Virtual Work. In particular the relations between equilibrium, compatibility conditions, and virtual work will be highlighted.

5.1 Virtual work

Virtual work can be defined as the work done on a deformable continuum by all the forces acting on it when the body is subjected to a small hypothetical displacement field - unrelated to the forces - which is consistent with the constraints present. The latter is named *virtual displacement* and is denoted by an asterisk.

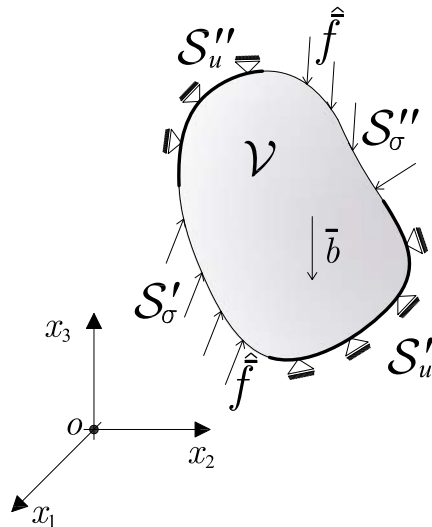

Figure 5.1: Forces and constraints acting on the continuum.

As figure 5.1 shows, let us suppose to split the surface \mathcal{S} into two separated boundary surfaces, in such a way that surface forces are

prescribed on \mathcal{S}_σ and a boundary displacement field \bar{u} is prescribed over the remaining boundary surface denoted by \mathcal{S}_u . Namely, the entire surface results as the sum $\mathcal{S} = \mathcal{S}_u \cup \mathcal{S}_\sigma$, where $\mathcal{S}_u = \mathcal{S}'_u \cup \mathcal{S}''_u$ and $\mathcal{S}_\sigma = \mathcal{S}'_\sigma \cup \mathcal{S}''_\sigma$.

Consider now a virtual displacement field u_i^* which yields the deformation

$$\varepsilon_{ij}^* = \frac{1}{2} (u_{i,j}^* + u_{j,i}^*) \quad (5.1)$$

In order to calculate the virtual work done by the volume and surface forces we write

$$W^* = \int_{\mathcal{S}_\sigma} f_i u_i^* d\mathcal{S}_\sigma + \int_{\mathcal{V}} b_i u_i^* d\mathcal{V} \quad (5.2)$$

and we recall also the equilibrium equations discussed in chapter 3

$$\sigma_{ij,i} + b_j = 0, \quad \forall p \in \mathcal{V} \quad (5.3)$$

$$\sigma_{ij} n_j = f_i, \quad \forall p \in \mathcal{S}_\sigma \quad (5.4)$$

$$\sigma_{ij} = \sigma_{ji} \quad \forall p \in \mathcal{V} \quad (5.5)$$

By replacing both equations (5.3) and (5.4) into equation (5.2) we have

$$W^* = \int_{\mathcal{S}_\sigma} \sigma_{ij} n_j u_i^* d\mathcal{S}_\sigma - \int_{\mathcal{V}} \sigma_{hi,h} u_i^* d\mathcal{V} \quad (5.6)$$

Next, consider the following identity

$$\int_{\mathcal{V}} (\sigma_{hi} u_i^*)_{,h} d\mathcal{V} = \int_{\mathcal{V}} \sigma_{hi,h} u_i^* d\mathcal{V} + \int_{\mathcal{V}} \sigma_{hi} u_{i,h}^* d\mathcal{V} \quad (5.7)$$

that through some simple algebra yields the following equations

$$\begin{aligned} \int_{\mathcal{V}} (\sigma_{hi} u_i^*)_{,h} d\mathcal{V} &= \int_{\mathcal{V}} \sigma_{hi,h} u_i^* d\mathcal{V} + \\ + \frac{1}{2} \int_{\mathcal{V}} \sigma_{hi} (u_{i,h}^* + u_{h,i}^*) d\mathcal{V} &+ \underbrace{\frac{1}{2} \int_{\mathcal{V}} \sigma_{hi} (u_{i,h}^* - u_{h,i}^*) d\mathcal{V}}_{=0} = \\ &= \int_{\mathcal{V}} \sigma_{hi,h} u_i^* d\mathcal{V} + \int_{\mathcal{V}} \sigma_{hi} \varepsilon_{hi}^* d\mathcal{V} \Rightarrow \\ \int_{\mathcal{V}} \sigma_{hi,h} u_i^* d\mathcal{V} &= \int_{\mathcal{V}} (\sigma_{hi} u_i^*)_{,h} d\mathcal{V} - \int_{\mathcal{V}} \sigma_{hi} \varepsilon_{hi}^* d\mathcal{V} \end{aligned} \quad (5.8)$$

where we have split the virtual displacement gradient $u_{i,j}^* = \varepsilon_{ij}^* + \omega_{ij}^*$, see equation (2.81), and used the fact that the product of a symmetric tensor σ_{ij} by a skew-symmetric tensor $\omega_{ij} = \frac{1}{2} (u_{i,j}^* - u_{j,i}^*)$ always vanishes. Moreover, the divergence theorem allows us to write

$$\int_{\mathcal{V}} (\sigma_{hi} u_i^*)_{,h} d\mathcal{V} = \int_{\mathcal{S}_\sigma \cup \mathcal{S}_u} \sigma_{hi} u_i^* n_h d\mathcal{S} \quad (5.9)$$

so finally equation (5.8), provided that $u^* = 0$ on \mathcal{S}_u , becomes

$$W^* = \underbrace{\int_{\mathcal{S}_\sigma} \sigma_{ij} n_j u_i^* d\mathcal{S} - \int_{\mathcal{S}_\sigma} \sigma_{hi} u_i^* n_h d\mathcal{S}}_{=0} + \int_{\mathcal{V}} \sigma_{hi} \varepsilon_{hi}^* d\mathcal{V} \quad (5.10)$$

As a result we have proved the following expression, also known as *principle of virtual work*, holds

$$\int_{\mathcal{S}_\sigma} f_i u_i^* d\mathcal{S}_\sigma + \int_{\mathcal{V}} b_i u_i^* d\mathcal{V} = \int_{\mathcal{V}} \sigma_{ij} \varepsilon_{ij}^* d\mathcal{V} \quad (5.11)$$

In equation (5.11) we shall define the left-hand side group of terms as *external work*, and the right-hand side one as *internal work*, the reason why the following alternative names are often used

$$\begin{aligned} W^* &= L_e^* = \int_{\mathcal{S}_\sigma} f_i u_i^* d\mathcal{S}_\sigma + \int_{\mathcal{V}} b_i u_i^* d\mathcal{V} \\ W^* &= L_i^* = \int_{\mathcal{V}} \sigma_{ij} \varepsilon_{ij}^* d\mathcal{V} \end{aligned}$$

To obtain the above results we started from the equilibrium and compatibility conditions and it is interesting to notice that we have never used any constitutive laws. So the PVW can be applied to all continuous material with the only limitation of small displacements.

Let us take a look to the physical meaning of the internal work. Consider an infinitesimal volume element $d\mathcal{V}$, shown in figure 5.2.

In a two dimensional case the work done by forces acting on $d\mathcal{V}$ for each deformation ε_{ij}^* can be seen in sketches 5.3, where the axial virtual dilatation along the x_2 direction and the angular dilatation in (x_1, x_2) -plane are depicted.

Thus, the infinitesimal virtual work done by $\sigma_{22} dx_1 dx_3$ is

$$dL_{i22}^* = \sigma_{22} dx_1 dx_3 \varepsilon_{22}^* dx_2 = \sigma_{22} \varepsilon_{22}^* d\mathcal{V}$$

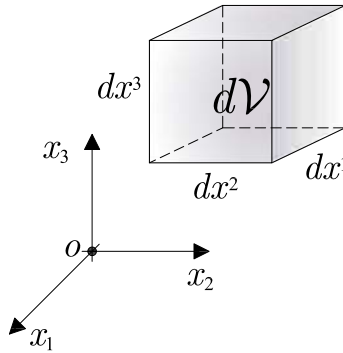

Figure 5.2: Elemental volume element.

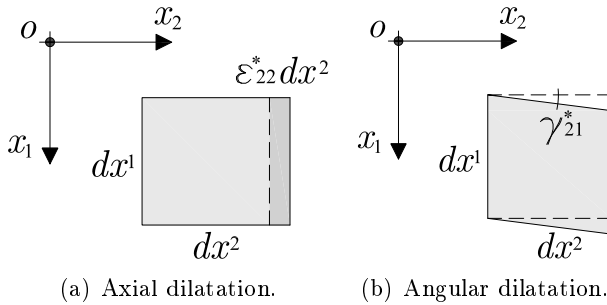

Figure 5.3: Virtual deformation.

In the same way from figure 5.3(b) the work done by the force $\sigma_{21} dx_1 dx_3$ is

$$dL_{i_{21}}^* = \sigma_{21} dx_1 dx_3 \gamma_{21}^* dx_2 = 2\sigma_{21} \varepsilon_{21}^* dx_1 dx_2 dx_3 = 2\sigma_{21} \varepsilon_{21}^* d\mathcal{V}$$

Computing the infinitesimal work dL^* done for each deformation and integrating on the entire volume \mathcal{V} we obtain

$$L_i^* = \int_{\mathcal{V}} \sigma_{ij} \varepsilon_{ij} d\mathcal{V} \quad (5.12)$$

The principle of the virtual work for rigid bodies can be readily derived from the general expression (5.11) where, since $\varepsilon_{ij} = 0$, yields

$$L_e^* = 0 \quad (5.13)$$

5.1.1 A simple example

As an application of the virtual work principle let us consider a simple system of bars¹

All the forces are summed in a resultant force F applied to the end point of two bars, as shown in figure 5.4. The external force provides only an axial state of stress in the bars.

F	150 kN
E	$206 \times 10^3 \text{ N/mm}^2$
A	15 cm^2
l	2 m
l_1	4.47 m
l_2	4 m
α	63.435°

By means of the PVW we want to find the magnitude of the real displacement at point **A** along x_1 and x_2 -directions under the effect of F . To this end we consider first a unit explorer load in x_1 -direction (to compute u_1^* , then a unit explorer load in the x_2 direction (to compute u_2^*).

First of all we solve the equilibrium problem, so that

	real case	a case	b case
N_1	$2F/\sin \alpha$	$2/\sin \alpha$	0
N_2	$-2F$	-2	1

Consider case **a** in which we shall compute u_1^* . PVW reads as follows

$$L_e^* = 1u_1^* = \int_{l_1} N_1 \varepsilon_1^* dl + \int_{l_2} N_2 \varepsilon_2^* dl = L_i^*$$

where

$$\varepsilon_1^* = \frac{N_1^{a*}}{EA} = \frac{2}{EA \sin \alpha}$$

$$\varepsilon_2^* = \frac{N_2^{a*}}{EA} = -\frac{2}{EA}$$

¹Although no notions on mechanics of beams or frame structures have been introduced so far, the intuitive meaning the reader can assign to some quantities, like the unit axial deformation ε , could be enough to get the main idea of this example. Moreover, after reading chapter 8, the reader will be able to have a more comprehensive view of this application.

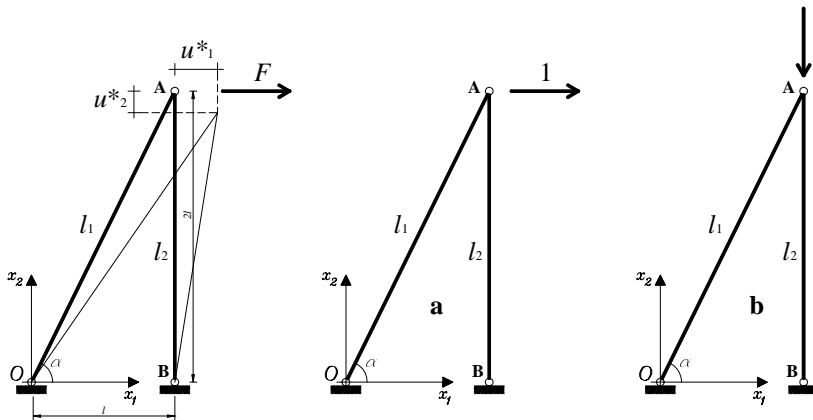

Figure 5.4: Example.

So we have

$$1u_1^* = \frac{4F}{EA \sin \alpha} l_1 + \frac{4F}{EA} l_2$$

For case **b** we write

$$L_e^* = 1u_2^* = \int_{l_2} N_2 \varepsilon_2^* dl = L_i^*$$

where

$$\varepsilon_2^* = \frac{N_2^{b*}}{EA} = -\frac{1}{EA}$$

So we have

$$1u_2^* = \frac{2F}{EA} l_2$$

Finally, with respect to the cartesian positive direction, using the above expressions we easily obtain

$$\begin{aligned} u_1^* &= 18.62 \text{ mm} \\ u_2^* &= -3.88 \text{ mm} \end{aligned}$$

5.2 PVW, Compatibility conditions, Equilibrium

In the previous section we showed that the equilibrium and the compatibility conditions lead to PVW. Now in this section we shall prove that two of three conditions are enough to obtain the third one.

PVW + Compatibility \Rightarrow Equilibrium. Let us start from the PVW and the compatibility equations

$$\int_S f_i u_i^* dS + \int_V b_i u_i^* dV = \int_V \sigma_{ij} \varepsilon_{ij}^* dV$$

$$\varepsilon_{ij}^* = \frac{1}{2} (u_{i,j}^* + u_{j,i}^*)$$

By splitting the displacement gradient the PVW can be rewritten as follows

$$\int_S f_i u_i^* dS + \int_V b_i u_i^* dV = \int_V \sigma_{ij} u_{i,j}^* dV - \int_V \sigma_{ij} \omega_{ij} dV$$

Now, making use once again of the identity (5.7), the latter equation becomes

$$\int_S f_i u_i^* dS + \int_V b_i u_i^* dV =$$

$$\int_V (\sigma_{ij} u_i^*)_{,j} dV - \int_V \sigma_{ij,j} u_i^* dV - \int_V \sigma_{ij} \omega_{ij} dV \Rightarrow$$

$$\int_V (\sigma_{ij,j} + b_i) u_i^* dV = \int_S (\sigma_{ij} n_j - f_i) u_i^* dS - \int_V \sigma_{ij} \omega_{ij} dV$$

where the divergence theorem has been used.

Due to the arbitrariness of the displacement field, if compatible, the latter equation is only satisfied if each argument vanishes, therefore

$$\sigma_{ij,j} + b_i = 0, \quad \forall p \in V$$

$$\sigma_{ij} n_j - f_i = 0, \quad \forall p \in S_\sigma$$

$$\sigma_{ij} \omega_{ij} = 0 \Rightarrow$$

$$\sigma_{ij} = \sigma_{ji} \quad \forall p \in V$$

PVW + Equilibrium \Rightarrow Compatibility. To prove this statement consider the expression of the PVW (5.11)

$$\int_{\mathcal{S}_\sigma} f_i u_i^* d\mathcal{S}_\sigma + \int_{\mathcal{V}} b_i u_i^* d\mathcal{V} = \int_{\mathcal{V}} \sigma_{ij} \varepsilon_{ij}^* d\mathcal{V}$$

and the equilibrium equations

$$\begin{aligned} \sigma_{ij,i} + b_j &= 0, & \forall p \in \mathcal{V} \\ \sigma_{ij} n_j &= f_i, & \forall p \in \mathcal{S}_\sigma \end{aligned}$$

that replaced into the equation of the PVW lead to

$$\int_{\mathcal{S}_\sigma} \sigma_{ij} n_j u_i^* d\mathcal{S}_\sigma - \int_{\mathcal{V}} \sigma_{ji,j} u_i^* d\mathcal{V} = \int_{\mathcal{V}} \sigma_{ij} \varepsilon_{ij}^* d\mathcal{V}$$

and by using again the divergence theorem the above equation becomes

$$\int_{\mathcal{V}} (\sigma_{ij} u_i^*)_{,j} d\mathcal{V} - \int_{\mathcal{V}} \sigma_{ji,j} u_i^* d\mathcal{V} = \int_{\mathcal{V}} \sigma_{ij} \varepsilon_{ij}^* d\mathcal{V}$$

and by expanding the first integral on the left-hand side we obtain

$$\begin{aligned} \int_{\mathcal{V}} \sigma_{ij} u_{i,j}^* d\mathcal{V} &= \int_{\mathcal{V}} \sigma_{ij} \varepsilon_{ij}^* d\mathcal{V} \Rightarrow \\ \int_{\mathcal{V}} \sigma_{ij} \frac{1}{2} (u_{i,j}^* + u_{j,i}^*) d\mathcal{V} &+ \underbrace{\int_{\mathcal{V}} \sigma_{ij} \frac{1}{2} (u_{i,j}^* - u_{j,i}^*) d\mathcal{V}}_{=\sigma_{ij}\omega_{ij}=0} = \\ &\int_{\mathcal{V}} \sigma_{ij} \varepsilon_{ij}^* d\mathcal{V} \end{aligned}$$

that proves the compatibility condition of the virtual displacement field

$$\varepsilon_{ij}^* = \frac{1}{2} (u_{i,j}^* + u_{j,i}^*)$$

Chapter 6

Energy principles and variational methods

This chapter deals with some of the most important results concerning energy principles in elasticity. Firstly, we will start introducing the strain energy and how it is related to the work done by the external forces (Clapeyron's theorem), secondly we will introduce two important theorems which make use of the strain energy: uniqueness of the solution for the elastic boundary-value problem and the theorem of reciprocity.

Finally, the equilibrium condition will be interpreted as the stationary condition of the potential energy and accordingly some energetic theorems will be enounced.

6.1 The strain-energy function and Hooke's law

Suppose the body \mathcal{V} lies in a natural state at time $t = 0$. Under the effect of surface and body forces, the continuum has at time t the strained configuration. With respect to the usual cartesian system each point of \mathcal{V} is found by $x_i + u_i(x_j, t)$. Where $\{x_j\}$ denotes the coordinates in the unstrained configuration at $t = 0$. The displacement fields may be derived as follows

$$\frac{\partial u_i}{\partial t} dt = \dot{u}_i dt$$

During the deformation the work done by all the forces acting on the body is denoted by W . The rate of W is given by

$$\frac{dW}{dt} = \int_S f_i \dot{u}_i dS + \int_{\mathcal{V}} b_i \dot{u}_i dV \quad (6.1)$$

By making use of equilibrium boundary equation (3.3.3) in chap-

ter 3 and the divergence theorem, equation (6.1) becomes

$$\begin{aligned}
 \frac{dW}{dt} &= \int_{\mathcal{V}} b_i \dot{u}_i d\mathcal{V} + \int_{\mathcal{V}} (\sigma_{ij} \dot{u}_i)_{,j} d\mathcal{V} = \\
 &= \int_{\mathcal{V}} b_i \dot{u}_i d\mathcal{V} + \int_{\mathcal{V}} \sigma_{ij,j} \dot{u}_i d\mathcal{V} + \int_{\mathcal{V}} \sigma_{ij} \dot{u}_{i,j} d\mathcal{V} = \\
 &= \int_{\mathcal{V}} b_i \dot{u}_i d\mathcal{V} + \int_{\mathcal{V}} \sigma_{ij,j} \dot{u}_i d\mathcal{V} + \int_{\mathcal{V}} \sigma_{ij} (\dot{\varepsilon}_{ij} + \dot{\omega}_{ij}) d\mathcal{V} = \\
 &= \int_{\mathcal{V}} b_i \dot{u}_i d\mathcal{V} + \int_{\mathcal{V}} \sigma_{ij,j} \dot{u}_i d\mathcal{V} + \int_{\mathcal{V}} \sigma_{ij} (\dot{\varepsilon}_{ij} + \dot{\omega}_{ij}) d\mathcal{V}
 \end{aligned}$$

Due to the equilibrium condition, and remembering that $\sigma_{ij} \dot{\omega}_{ij} = 0$, the latter equation may be written as follows

$$\frac{dW}{dt} = \int_{\mathcal{V}} \sigma_{ij} \dot{\varepsilon}_{ij} d\mathcal{V} = \int_{\mathcal{V}} \sigma_{ij} \frac{\partial \varepsilon_{ij}}{\partial t} d\mathcal{V} \quad (6.2)$$

Now let us suppose that there exists a function $\phi = \phi(\varepsilon_{ij})$ such that

$$\frac{\partial \phi}{\partial \varepsilon_{ij}} = \sigma_{ij} \quad (6.3)$$

so, (6.2) becomes

$$\frac{dW}{dt} = \int_{\mathcal{V}} \frac{\partial \phi}{\partial \varepsilon_{ij}} \frac{\partial \varepsilon_{ij}}{\partial t} d\mathcal{V} = \frac{d}{dt} \int_{\mathcal{V}} \phi(\varepsilon_{ij}) d\mathcal{V} \quad (6.4)$$

Let us define *strain energy* the following integral

$$\Phi = \int_{\mathcal{V}} \phi(\varepsilon_{ij}) d\mathcal{V} \quad (6.5)$$

where ϕ is said *volume density of strain energy* or *elastic potential*.

Hence, since we are considering the instant t when the body lies in an equilibrium configuration, so that the kinetic energy vanishes, equation (6.4) states that the work W done by the external forces in altering the configuration of the natural state to the equilibrium state at the instant t is equal to the strain energy Φ . Therefore, the latter can be considered as the energy stored in the deformable body when it is brought from an initial natural state to the equilibrium state.

We assume now that the strain energy density function ϕ can be expanded in a Mc Laurin series

$$\phi(\varepsilon_{ij}) = \phi(0) + \left(\frac{\partial\phi}{\partial\varepsilon_{ij}}\right)_0 + \frac{1}{2} \left(\frac{\partial^2\phi}{\partial\varepsilon_{ij}\partial\varepsilon_{hk}}\right)_0 \varepsilon_{ij}\varepsilon_{hk} + \dots \quad (6.6)$$

where we discard all terms of order 3 or higher. The constant $\phi(0)$ is the energy density associated with the initial stress state while

$$\left(\frac{\partial\phi}{\partial\varepsilon_{ij}}\right) = \sigma_{ij}^0$$

is the initial stress state.

Now recalling the Hooke's generalized law (4.2), and taking into account equation (6.3), we obtain

$$\frac{\partial\sigma_{ij}}{\partial\varepsilon_{hk}} = C_{ijhk} \quad (6.7)$$

and

$$\frac{\partial\sigma_{ij}}{\partial\varepsilon_{hk}} = \frac{\partial^2\phi}{\partial\varepsilon_{hk}\partial\varepsilon_{ij}} \quad (6.8)$$

so from equations (6.7) and (6.8) we have that

$$C_{ijhk} = \frac{\partial^2\phi}{\partial\varepsilon_{hk}\partial\varepsilon_{ij}} \quad (6.9)$$

and due to Schwartz's theorem the symmetry of the elasticity tensor has also been proved

$$C_{ijhk} = C_{hki j} \quad (6.10)$$

This important result can be substituted into equation (6.6), where, by assuming that both the energy density at initial state of stress and prestresses vanish, we obtain

$$\phi(\varepsilon_{ij}) = \frac{1}{2} C_{ijhk} \varepsilon_{ij} \varepsilon_{hk} \quad (6.11)$$

hence

$$\Phi = \int_{\mathcal{V}} \phi(\varepsilon_{ij}) d\mathcal{V} = \frac{1}{2} \int_{\mathcal{V}} C_{ijhk} \varepsilon_{ij} \varepsilon_{hk} \quad (6.12)$$

In the case of a simple axial state of stress the density of strain energy is

$$\phi = \frac{1}{2} C_{1111} \varepsilon_{11} \varepsilon_{11} = \frac{1}{2} \sigma_{11} \varepsilon_{11}$$

therefore the dashed area in figure 6.1 represents the density of strain energy for an axial state of stress.

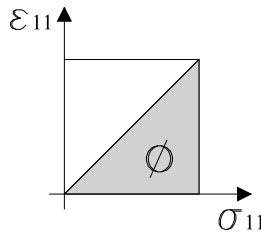

Figure 6.1: Density of strain energy in the case of axial state of stress.

Theorem 1 (CLAPEYRON'S THEOREM) *If a body is in equilibrium under a given system of body forces b_i and surface forces f_i , then the strain energy Φ is equal to one-half the work done by the external forces (of the equilibrium state) acting through the displacements u_i from the initial state to the equilibrium state.*

To prove Clapeyron's theorem let us recall the PVW expression. See equation (5.11) in chapter 5. To do this it is necessary to require the equilibrium state of the body and the consistency of displacement and strain fields, thus

$$\int_{S_\sigma} f_i u_i dS_\sigma + \int_{\mathcal{V}} b_i u_i d\mathcal{V} = \int_{\mathcal{V}} \sigma_{ij} \varepsilon_{ij} d\mathcal{V} \quad (6.13)$$

where replacing the expression of the strain energy (6.12) we have

$$2\Phi = \int_{S_\sigma} f_i u_i dS_\sigma + \int_{\mathcal{V}} b_i u_i d\mathcal{V} \quad (6.14)$$

On the right-hand side of equation (6.14) we recognize what we have defined as *external forces work*. Therefore we have proved that

$$\Phi = \frac{1}{2} L_e \quad (6.15)$$

As done in equation (6.3) we suppose now the existence of the *conjugate strain energy density*

$$\phi^* = \phi^*(\sigma_{ij}) \quad (6.16)$$

such as

$$\frac{\partial \phi^*}{\partial \sigma_{ij}} = \varepsilon_{ij} \quad (6.17)$$

so we define

$$\Phi^* = \int_{\mathcal{V}} \phi^*(\sigma_{ij}) d\mathcal{V} \quad (6.18)$$

as the *conjugate strain energy*.

Through equations similar to the strain energy case, we can write

$$\phi^*(\sigma_{ij}) = \frac{1}{2} C_{ijhk}^* \sigma_{ij} \sigma_{hk} \quad (6.19)$$

where $C_{ijhk}^* = C_{ijhk}^{-1}$ and $\varepsilon_{ij} = C_{ijhk}^* \sigma_{hk}$. We can also prove that

$$\phi(\varepsilon_{ij}) = \phi^*(\sigma_{ij}) = \frac{1}{2} \varepsilon_{ij} \sigma_{ij} \quad (6.20)$$

in fact, we have

$$\phi^*(\sigma_{ij}) = \frac{1}{2} C_{ijhk}^* \sigma_{ij} \sigma_{hk} = \frac{1}{2} \varepsilon_{ij} \sigma_{ij} = \phi(\varepsilon_{ij}) \quad (6.21)$$

Often it is useful to know the whole strain energy of a deformable body without knowing the internal state of stress. Figure 6.2 shows the deformation of a beam under a concentrated external load¹.

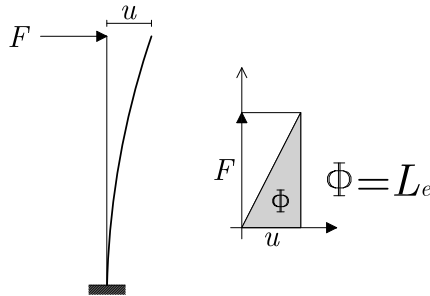

Figure 6.2: The simplest application of Clapeyron's theorem.

We can compute the strain energy easily as

$$\Phi = \frac{1}{2} Fu$$

¹We suppose the self weight vanishes.

6.1.1 Superposition principle

We set the elastic equilibrium boundary-value problem as follows

$$\operatorname{div} \sigma + \bar{b} = 0 \quad \forall p \in \mathcal{V} \quad (6.22)$$

$$\varepsilon = \operatorname{sym} \nabla \bar{u} \quad \forall p \in \mathcal{V} \quad (6.23)$$

$$\sigma = \frac{E}{1 + \nu} \left(\varepsilon + \frac{\nu}{1 - 2\nu} \operatorname{tr} \varepsilon \right) \quad \forall p \in \mathcal{V} \quad (6.24)$$

and

$$\sigma \bar{n} = \bar{f} \quad \forall p \in \mathcal{S}_\sigma \quad (6.25)$$

$$\bar{u} = \hat{u} \quad \forall p \in \mathcal{S}_u \quad (6.26)$$

Superposition principle is a general tool that can be applied to many physical linear systems. It states that *if a number of independent influences act on the system, then the resultant influence is the sum of the individual influences acting separately.*

Namely, let us suppose to have two systems of body and surface forces

$$\{\bar{b}^{(1)}, \bar{f}^{(1)}\} \quad (6.27)$$

$$\{\bar{b}^{(2)}, \bar{f}^{(2)}\} \quad (6.28)$$

Every force system is related to the following strain and stress state, respectively

$$\{\bar{u}^{(1)}, \varepsilon^{(1)}, \sigma^{(1)}\} \quad (6.29)$$

$$\{\bar{u}^{(2)}, \varepsilon^{(2)}, \sigma^{(2)}\} \quad (6.30)$$

Formally the the principle of influence superposition allows us to state that for all $\lambda_1, \lambda_2 \in \mathbb{R}$, given the following forces system

$$\{\lambda_1 \bar{b}^{(1)} + \lambda_2 \bar{b}^{(2)}, \lambda_1 \bar{f}^{(1)} + \lambda_2 \bar{f}^{(2)}\} \quad (6.31)$$

then the following set of displacement, strain and stress

$$\{\lambda_1 \bar{u}^{(1)} + \lambda_2 \bar{u}^{(2)}, \lambda_1 \varepsilon^{(1)} + \lambda_2 \varepsilon^{(2)}, \lambda_1 \sigma^{(1)} + \lambda_2 \sigma^{(2)}\} \quad (6.32)$$

is the solution of the equilibrium boundary-value problem.

To prove that it is enough to substitute the above fields in the elastic problem equations.

However, there are some special cases for which the superposition principle does not hold. Indeed, let us consider the strain energy Φ and put $\varepsilon_{ij} = \varepsilon_{ij}^{(1)} + \varepsilon_{ij}^{(2)}$. We obtain

$$\Phi(\varepsilon_{ij}) = \frac{1}{2} \int_{\mathcal{V}} C_{ijhk} \varepsilon_{ij} \varepsilon_{hk} d\mathcal{V} = \quad (6.33)$$

$$= \frac{1}{2} \int_{\mathcal{V}} C_{ijhk} \left(\varepsilon_{ij}^{(1)} + \varepsilon_{ij}^{(2)} \right) \left(\varepsilon_{hk}^{(1)} + \varepsilon_{hk}^{(2)} \right) d\mathcal{V} = \quad (6.34)$$

$$= \frac{1}{2} \int_{\mathcal{V}} C_{ijhk} \varepsilon_{ij}^{(1)} \varepsilon_{hk}^{(1)} d\mathcal{V} + \frac{1}{2} \int_{\mathcal{V}} C_{ijhk} \varepsilon_{ij}^{(2)} \varepsilon_{hk}^{(2)} d\mathcal{V} + \quad (6.35)$$

$$+ \frac{1}{2} \int_{\mathcal{V}} C_{ijhk} \varepsilon_{ij}^{(1)} \varepsilon_{ij}^{(2)} d\mathcal{V} + \frac{1}{2} \int_{\mathcal{V}} C_{ijhk} \varepsilon_{ij}^{(2)} \varepsilon_{ij}^{(1)} d\mathcal{V}$$

Finally, due to the symmetry of the elasticity tensor we have

$$\Phi(\varepsilon_{ij}) = \Phi\left(\varepsilon_{ij}^{(1)} + \varepsilon_{ij}^{(2)}\right) = \quad (6.36)$$

$$= \Phi\left(\varepsilon_{ij}^{(1)}\right) + \Phi\left(\varepsilon_{ij}^{(2)}\right) + \int_{\mathcal{V}} C_{ijhk} \varepsilon_{ij}^{(1)} \varepsilon_{hk}^{(2)} d\mathcal{V} \quad (6.37)$$

The last term in equation (6.37) represents the coupling contribution to the strain energy which disproves the superposition principle for the strain energy.

6.1.2 Uniqueness of the solution

The solution of the boundary-value problems formulated in sections 4.2.1 and 4.2.2 is unique. To show that let us assume, by absurd, that it is possible to obtain two solutions for the boundary-value problem expressed by equations (6.22) to (6.26)

$$\{\bar{u}^{(1)}, \varepsilon^{(1)}, \sigma^{(1)}\} \quad (6.38)$$

$$\{\bar{u}^{(2)}, \varepsilon^{(2)}, \sigma^{(2)}\} \quad (6.39)$$

Equation (6.22) allows us to put

$$\sigma_{ij,j}^{(1)} = \sigma_{ij,j}^{(2)} + b_i = 0 \quad (6.40)$$

while equation (6.25) allows to write

$$\sigma_{ij}^{(1)} n_j = \sigma_{ij}^{(2)} n_j = \hat{f}_i \quad (6.41)$$

Now, by virtue of the superposition principle, it is clear that the following function

$$\begin{aligned}\bar{u} &= \bar{u}^{(1)} - \bar{u}^{(2)} \\ \varepsilon &= \varepsilon^{(1)} - \varepsilon^{(2)} \\ \sigma &= \sigma^{(1)} - \sigma^{(2)}\end{aligned}$$

represent a special solution fulfilling the equilibrium equation provided that $b_i = 0$ and $\hat{f}_i = 0$. In fact we have

$$\sigma_{ij,j} = \left(\sigma_{ij}^{(1)} - \sigma_{ij}^{(2)} \right)_{,j} = 0 \quad (6.42)$$

$$\sigma_{ij,j} n_j = \left(\sigma_{ij}^{(1)} - \sigma_{ij}^{(2)} \right) n_j = 0 \quad (6.43)$$

Thus, for this special solution Clapeyron's theorem (6.14) writes as follows

$$2\Phi = 0 \quad (6.44)$$

that is

$$\int_{\mathcal{V}} \phi(\varepsilon_{ij}) d\mathcal{V} = \int_{\mathcal{V}} C_{ijhk} \varepsilon_{ij} \varepsilon_{hk} d\mathcal{V} = 0 \quad (6.45)$$

But since ϕ is a positive definite quadratic form, the above integral can vanish only when $\varepsilon_{ij} = 0$ and so the following identity has been proved

$$\varepsilon_{ij}^{(1)} = \varepsilon_{ij}^{(2)} \quad (6.46)$$

Therefore, if the components of the strain tensor for two solutions must be identical, then, by means of the constitutive law, it follows that the components of the stress tensor must be identical as well

$$\sigma_{ij}^{(1)} = \sigma_{ij}^{(2)}$$

Finally we want to remark that the equality $\varepsilon^{(1)} = \varepsilon^{(2)}$ does not exclude rigid body motion \bar{u}_0 . In fact $\bar{u}^1 = \bar{u}^2 + \bar{u}_0$ satisfies the uniqueness of deformation since it does not produce any deformation, i.e. $\varepsilon_0 = 0$. But we shall suppose the constraints along \mathcal{S}_u are able to inhibit all rigid displacements, so that

$$\bar{u}_i^{(1)} = \bar{u}_i^{(2)} \quad (6.47)$$

6.1.3 Theorem of reciprocity

Now we introduce a general reciprocal expression relating the equilibrium states of a body under different loads. To do this let us consider two equilibrium states of an elastic body one of which subjected to displacement field \bar{u} due to the body and surface forces \bar{b} and \bar{f} , respectively; the other equilibrium state is characterized by the displacement field \bar{u}' due to the body and surface forces \bar{b}' and \bar{f}' , respectively. The work that would be done by the forces b_i and f_i if they acted through the displacements u'_i can be written as follows

$$\int_S f_i u'_i dS + \int_V b_i u'_i dV = \int_V \sigma_{ij} \varepsilon'_{ij} dV \quad (6.48)$$

and in the same way, the work that would be done by the forces b'_i and f'_i if they acted through the displacements u_i can be written as follows

$$\int_S f'_i u_i dS + \int_V b'_i u_i dV = \int_V \sigma'_{ij} \varepsilon_{ij} dV \quad (6.49)$$

Through the symmetry of the tensor of elasticity we notice that

$$\begin{aligned} \sigma_{ij} &= C_{ijhk} \varepsilon_{hk} \\ \sigma'_{ij} &= C_{ijhk} \varepsilon'_{hk} \end{aligned}$$

hence,

$$\int_V \sigma'_{ij} \varepsilon_{ij} dV = \quad (6.50)$$

$$= \int_V C_{ijhk} \varepsilon'_{hk} \varepsilon_{ij} dV = \int_V C_{hki j} \varepsilon_{ij} \varepsilon'_{hk} dV = \quad (6.51)$$

$$= \int_V \sigma_{hk} \varepsilon'_{hk} dV. \quad (6.52)$$

Equations (6.50) and (6.52) prove that (6.48) and (6.49) are identical, so

$$\int_S f_i u'_i dS + \int_V b_i u'_i dV = \int_S f'_i u_i dS + \int_V b'_i u_i dV \quad (6.53)$$

Equation (6.53) can be enunciated in the following theorem

Theorem 2 (BETTI'S THEOREM) *If an elastic body is subjected to two systems of body and surface forces, then the work that would be*

done by the first system b_i and f_i acting through the displacements u'_i due to the second system of forces is equal to the work that would be done by the second system of forces b'_i and f'_i acting through the displacements u_i due to the first system of forces.

Theorem of Betti is also termed theorem of reciprocity.

6.2 Variational methods

In this section we present an alternative approach aimed at finding the state of stress in a continuous elastic body. This method basis itself on some minimum principles that characterize the equilibrium state of bodies. Namely we shall see that it is possible to construct some integrals relating the work done by the forces acting throughout the deformation and to show that these integrals have their minimum values when the distribution of stress in the body corresponds to the equilibrium states. So searching for equilibrium state is reduced to certain standard problems of calculus of variations.

This method is strongly used in computational mechanics to solve the equilibrium problem in the finite elements method.

6.2.1 Potential energy

Let us start by introducing the functional \mathcal{U} called *potential energy of deformation*. We shall show that this potential attains an absolute minimum value when the displacements of the body \mathcal{V} are those of the equilibrium configuration. As usual, see also figures 5.1 on page 103 and figure 6.3, let b_i be the body forces and f_i the surface forces prescribed on \mathcal{S}_σ .

We suppose that over the remaining part of \mathcal{S} , i.e. \mathcal{S}_u , the displacements \hat{u}_i are known. We denote the displacements which satisfy the equilibrium configuration as u_i and consider an arbitrary small² displacements δu_i only if consistent with respect to the compatibility conditions imposed over \mathcal{S}_u . To the field $\delta \bar{u}$ is also requested to belong to class C^3 and to be zero over \mathcal{S}_u . We shall term $\delta \bar{u}$ as *virtual displacement field*³.

²Compatible with the hypothesis of linear elasticity, $\delta \varepsilon_{ij} = \frac{1}{2} (\delta u_{i,j} + \delta u_{j,i})$.

³Note that in chapter 5 the virtual displacement $\delta \bar{u}$ was denoted by \bar{u}^* .

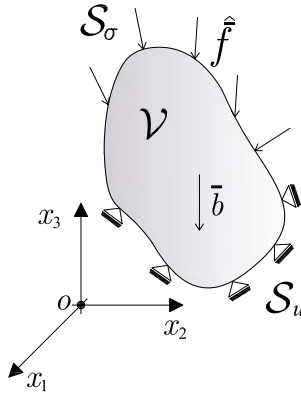

Figure 6.3: Forces and displacements acting on the body \mathcal{V} lying in the equilibrium state.

The elastic problem is given as follows

$$\operatorname{div} \sigma + \bar{b} = 0 \quad \forall p \in \mathcal{V} \quad (6.54)$$

$$\varepsilon = \operatorname{sym} \nabla \bar{u} \quad \forall p \in \mathcal{V} \quad (6.55)$$

$$\sigma = \frac{E}{1 + \nu} \left(\varepsilon + \frac{\nu}{1 - 2\nu} \operatorname{tr} \varepsilon \right) \quad \forall p \in \mathcal{V} \quad (6.56)$$

and

$$\bar{u} = \hat{u} \quad \forall p \in \mathcal{S}_u \quad (6.57)$$

We define the *potential energy of deformation* \mathcal{U} as follows

$$\mathcal{U}(\varepsilon_{ij}, u_i) = \Phi(\varepsilon_{ij}) - \Psi(u_i) \quad (6.58)$$

where

$$\Phi(\varepsilon_{ij}) = \int_{\mathcal{V}} \phi(\varepsilon_{ij}) d\mathcal{V} \quad (6.59)$$

$$\Psi(u_i) = \int_{\mathcal{V}} b_i u_i d\mathcal{V} + \int_{\mathcal{S}} f_i u_i d\mathcal{S} \quad (6.60)$$

The potential energy \mathcal{U} is the sum of the strain energy Φ and

the conservative loads potential Ψ . The first variation of \mathcal{U} is

$$\delta\mathcal{U} = \mathcal{U}(\bar{u} + \delta\bar{u}, \varepsilon + \delta\varepsilon) - \mathcal{U}(\bar{u}, \varepsilon) \quad (6.61)$$

$$= \Phi(\varepsilon + \delta\varepsilon) - \Psi(u_i + \delta u_i) - \Phi(\varepsilon) + \Psi(u_i) = \quad (6.62)$$

$$\begin{aligned} &= \Phi(\varepsilon + \delta\varepsilon) - \int_{\mathcal{V}} b_i(u_i + \delta u_i) d\mathcal{V} - \int_{\mathcal{S}} f_i(u_i + \delta u_i) d\mathcal{S} + \\ &- \Phi(\varepsilon) + \int_{\mathcal{V}} b_i u_i d\mathcal{V} + \int_{\mathcal{S}} f_i u_i d\mathcal{S} \end{aligned} \quad (6.63)$$

In equation (6.37) we have just seen that

$$\Phi(\varepsilon + \delta\varepsilon) = \Phi(\varepsilon) + \Phi(\delta\varepsilon) + \int_{\mathcal{V}} C_{ijkl} \varepsilon_{hk} \delta\varepsilon_{ij} \quad (6.64)$$

so neglecting $\Phi(\delta\varepsilon_{ij})$ as a second order infinitesimal, we obtain

$$\delta\mathcal{U} = \int_{\mathcal{V}} \sigma_{ij} \delta\varepsilon_{ij} d\mathcal{V} - \int_{\mathcal{V}} b_i \delta u_i d\mathcal{V} - \int_{\mathcal{S}} f_j \delta u_j d\mathcal{S} \quad (6.65)$$

We recognize in the right-hand side terms of the above expression the Principle of Virtual Work (5.11). So it is easy to notice that the stationary point for potential energy \mathcal{U} corresponds to the equilibrium condition. We know, in fact, that the PVW and the compatibility conditions of displacements δu_i result in the same thing and that is equilibrium state.

Theorem 3 (STATIONARY VALUE OF POTENTIAL ENERGY) *The total potential energy \mathcal{U} of an elastic body has a stationary value in the class of the geometrically permissible displacements for the true displacements which correspond to the state of equilibrium.*

It is also possible to prove the following stronger theorem.

Theorem 4 (MINIMUM POTENTIAL ENERGY) *Of all displacements satisfying the given boundary conditions those which satisfy the equilibrium conditions make the potential energy an absolute minimum.*

6.2.2 Complementary energy

Now we proceed to prove another important minimum theorem. As usual, see also figure 5.1 on page 103, let \mathcal{V} be a body in an

equilibrium state under the volume forces b_i and surface forces f_i prescribed on \mathcal{S}_σ .

The elastic problem is given as follows

$$\operatorname{div} \sigma + \bar{b} = 0 \quad \forall p \in \mathcal{V} \quad (6.66)$$

$$\varepsilon = \operatorname{sym} \nabla \bar{u} \quad \forall p \in \mathcal{V} \quad (6.67)$$

$$\sigma = \frac{E}{1+\nu} \left(\varepsilon + \frac{\nu}{1-2\nu} \operatorname{tr} \varepsilon \right) \quad \forall p \in \mathcal{V} \quad (6.68)$$

and

$$\sigma \bar{n} = \bar{f} \quad \forall p \in \mathcal{S}_\sigma \quad (6.69)$$

$$(6.70)$$

We term \mathcal{U}^* *conjugate potential energy of deformation* or *complementary energy* and we shall show that this potential reaches an absolute minimum value when the displacements of the body \mathcal{V} are those of the equilibrium configuration. We define the *complementary energy of deformation* \mathcal{U}^* as follows

$$\mathcal{U}^*(\sigma_{ij}, f_i) = \Phi^*(\sigma_{ij}) - \Psi^*(f_i) \quad (6.71)$$

where

$$\Phi^*(\sigma_{ij}) = \int_{\mathcal{V}} \phi^*(\sigma_{ij}) dV \quad (6.72)$$

$$\Psi^*(f_i) = \int_{\mathcal{S}} f_i u_i dS \quad (6.73)$$

We suppose that over the remaining part \mathcal{S}_u the displacements \hat{u}_i are known. We denote the displacements which satisfy the equilibrium configuration as u_i and consider an arbitrary small variations of σ and \bar{f} : $\delta\sigma$ and $\delta\bar{f}$, respectively. It is required that the fields $\sigma + \delta\sigma$ and $\bar{f} + \delta\bar{f}$ assures the equilibrium state, so that, by virtue of equations (6.22) and (6.25), we easily obtain

$$\delta\sigma_{ij,i} = 0 \quad \text{in } \mathcal{V} \quad (6.74)$$

$$\delta\sigma_{ij} n_i = 0 \quad \text{on } \mathcal{S}_\sigma \quad (6.75)$$

The first variation of \mathcal{U}^* is

$$\delta\mathcal{U}^* = \mathcal{U}^*(\bar{f} + \delta\bar{f}, \sigma + \delta\sigma) - \mathcal{U}^*(\bar{f}, \sigma) \quad (6.76)$$

$$= \Phi^*(\sigma + \delta\sigma) - \Phi^*(\sigma) - \Psi^*(\bar{f}) + \Psi^*(\bar{f} + \delta\bar{f}) \quad (6.77)$$

which in components becomes

$$\delta\mathcal{U}^*(\sigma_{ij}) = \Phi^*(\sigma_{ij}) + \int_{\mathcal{V}} C_{ijhk}^* \sigma_{hk} \delta\sigma_{ij} \quad (6.78)$$

$$-\Phi^*(\sigma_{ij}) - \int_{\mathcal{S}} \delta f_i u_i d\mathcal{S} \quad (6.79)$$

finally,

$$\delta\mathcal{U}^*(\sigma_{ij}) = \int_{\mathcal{V}} \delta\sigma_{ij} \varepsilon_{ij} - \int_{\mathcal{S}} \delta f_i u_i d\mathcal{S} \quad (6.80)$$

where we recognize on the right-hand side of the above expression the Principle of Virtual Work (5.11). So it is easy to notice that the stationary point for complementary energy \mathcal{U}^* corresponds to the equilibrium condition. We know, in fact, that the PVW and the compatibility conditions of displacements δu_i lead to the same result: the equilibrium state.

Theorem 5 (STATIONARY VALUE OF COMPLEMENTARY ENERGY) *The total complementary energy \mathcal{U}^* of an elastic body has a stationary value in the class of the statically permissible state of stress for the true state of stress corresponding to the equilibrium.*

It is also possible to prove the following stronger theorem.

Theorem 6 (MINIMUM COMPLEMENTARY ENERGY) *The complementary energy \mathcal{U}^* has an absolute minimum when the stress tensor σ_{ij} is that of the equilibrium state and fulfills the conditions (6.74) and (6.75).*

6.2.3 Theorems of Castigliano

Results discussed in the previous sections give us the means to find some other important results which go by the name of theorems of Castigliano. Therefore, let us suppose that a body \mathcal{V} is subjected only to concentrated loads F_k as figure 6.4 shows.

The potential energy and the complementary energy are, respectively

$$\mathcal{U} = \Phi(\varepsilon_{ij}) - \sum_{k=1}^n F_i^k u_i \quad (6.81)$$

$$\mathcal{U}^* = \Phi^*(\sigma_{ij}) - \sum_{k=1}^n F_i^k u_i \quad (6.82)$$

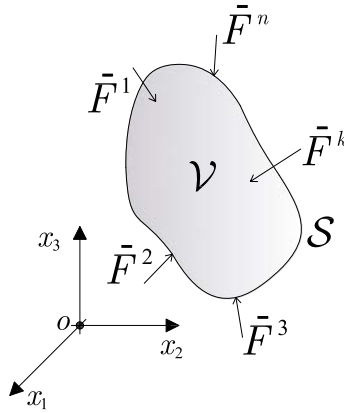

Figure 6.4: Concentrated loads acting on the body \mathcal{V} .

Rearranging the scalar product on the right-hand side of equations (6.81) and (6.82) we obtain

$$\mathcal{U} = \Phi(\varepsilon_{ij}) - F^k u_k \quad (6.83)$$

$$\mathcal{U}^* = \Phi^*(\sigma_{ij}) - F^k u_k \quad (6.84)$$

where u_k is the component of the displacement vector at the point of application of F^k in the direction of this force. Now we suppose that the potential energy \mathcal{U} results only from the displacements u_k and the complementary energy \mathcal{U}^* results only from the external concentrated loads F^k , therefore the energies above can be written as follows

$$\mathcal{U}(u_1, \dots, u_n) = \Phi(u_1, \dots, u_n) - F^k u_k \quad (6.85)$$

$$\mathcal{U}^*(F^1, \dots, F^n) = \Phi^*(F^1, \dots, F^n) - F^k u_k \quad (6.86)$$

where the first variations are

$$\begin{aligned} \delta\mathcal{U} &= \Phi(u_1, u_k + \delta u_k, u_n) - \Phi(u_1, u_k, u_n) - F^k \delta u_k = \\ &= \frac{\partial\Phi(u_k)}{\partial u_k} \delta u_k - F^k \delta u^k = \left(\frac{\partial\Phi(u_k)}{\partial u_k} - F^k \right) \delta u_k \end{aligned} \quad (6.87)$$

$$\begin{aligned} \delta\mathcal{U}^* &= \Phi^*(F^1, F^k + \delta F^k, F^n) - \Phi^*(F^1, F^k, F^n) - \delta F^k u_k = \\ &= \frac{\partial\Phi^*(F^k)}{\partial F^k} \delta F^k - \delta F^k u_k = \left(\frac{\partial\Phi^*(F^k)}{\partial F^k} - u_k \right) \delta F^k \end{aligned} \quad (6.88)$$

and by means of the principles of stationary value, equations (6.87) and (6.88) vanish, and discarding the trivial solutions $\delta u^k = 0$ and $\delta F^k = 0$, we obtain

$$\frac{\partial \Phi^*}{\partial F^k} = u^k \quad (6.89)$$

$$\frac{\partial \Phi}{\partial u_k} = F^k \quad (6.90)$$

where F^k is a generic centred load and u_k is its corresponding displacement.

Equation (6.90) may also be enounced in the following form

Theorem 7 (CASTIGLIANO'S THEOREM) *If an elastic body is subjected to centred loads and supported in such way that each rigid body motion is inhibited, then the displacement component u_k of the point of application of F^k towards its direction, is obtained from the partial derivative of the complementary energy with respect to the particular force.*

Menabrea's theorem is a particular case of Castigliano's theorem. In fact, if F^k is a reaction due to a constraint which does not allow any displacement, then equation (6.89) will become

$$\frac{\partial \Phi^*}{\partial F^k} = 0 \quad (6.91)$$

Equation (6.90) represents the second Castigliano's theorem, which states

Theorem 8 (II CASTIGLIANO'S THEOREM) *If an elastic body is subjected to centred displacements u_k and supported in such a way that each rigid body motion is inhibited, then the component of a concentrated load acting in the direction of such displacement is obtained by the partial derivative of the potential energy with respect to the particular displacement component.*

Illustrative example

Let us consider the simple system showed in figure 6.5. We have a rigid body which is supported by means of two elastic devices.

The entire elasticity of the system is concentrated in **A** and **B**, where we have a rotational stiffness with spring modulus k_m and a

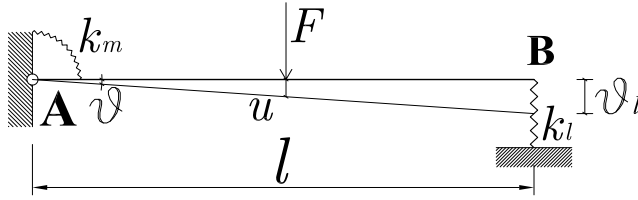

Figure 6.5: Example of Castigliano's theorems.

translational stiffness with spring modulus k_l , respectively. So, the constitutive relationships are

$$M = k_m \vartheta \quad (6.92)$$

$$R = k_l \vartheta l \quad (6.93)$$

and we may also set the following geometric relation

$$u = \frac{1}{2} l \vartheta$$

According to equations (6.5) and (6.11), through the above constitutive relationships, we can compute the strain energy Φ as follows

$$\Phi = \frac{1}{2} M \vartheta + \frac{1}{2} R l \vartheta = \frac{1}{2} k_m \vartheta^2 + \frac{1}{2} k_l l^2 \vartheta^2 = 2u^2 \left(\frac{k_m}{l^2} + k_l \right) \quad (6.94)$$

Now, by virtue of second theorem of Castigliano, we can find the external load

$$F = \frac{\partial \Phi}{\partial u} = 4u \left(\frac{k_m}{l^2} + k_l \right)$$

so that

$$u = \frac{F}{4} \frac{l^2}{k_m + l^2 k_l}$$

Chapter 7

Strength of materials

This section is intended to give only an overview about some selected criteria aimed at determining whether the state of stress characterizing an elastic continuum is secure compared with conventional material limits derived from experimental tests.

For a thorough investigation on the strength of materials the reader is recommended to referred to [7], [9], [10], [12].

7.1 Introduction

Usually the mechanical properties of materials are investigated by simple experimental tests, for example the tensile test and compression test offer the two failure stresses σ'_0 and σ''_0 which allow the evaluation of the riskiness of a combined state of stress resulting from the solution of the linear–elastic problem.

When the real state of stress is simply tension or compression, we can directly compare the results with the experimental values σ'_0 and σ''_0 and easily evaluate if the working stress is lower or higher than the *yielding point* (or *rupture point* for fragile materials).

The problem becomes more complicated when the actual state of stress is combined, hence various theories have been developed in order to find laws which, from the behavior of the materials in simple compression or tension, predict the condition of failure under any kind of combined stresses. The following sketch is rappresentative of this statement

$$\begin{array}{ccc}
 \textit{analytical} & \text{How to compare?} & \textit{experimental} \\
 \{\sigma_{ij}\} & \Longleftrightarrow & \{\sigma'_0, \sigma''_0\} \\
 & f = ? &
 \end{array}$$

It is known that the whole state of stress is defined by three principal stresses, so according to equation (3.36) in chapter 3, we assume that $I_3 \neq 0$. Furthermore, suppose the eigenvalue problem

(3.35) yields the three principal stresses ordered as follows

$$\sigma_I > \sigma_{II} > \sigma_{III}$$

where tensions are taken positive and compressions negative.

The law we are looking for assumes the following general form

$$f(\sigma_I, \sigma_{II}, \sigma_{III}) = \text{constant} \quad (7.1)$$

where $f(\sigma_I, \sigma_{II}, \sigma_{III})$ is a comparable quantity and the *constant* can be found applying the criterion f to the simple state of stress $f(0, 0, \sigma_0)$.

7.2 Maximum stress theory

This theory, also called Rankine's criterion, assumes the maximum stress as the criterion for the material failure. Accordingly we write

$$\sigma'_{id} = |\sigma_I| \quad (7.2)$$

$$\sigma''_{id} = |\sigma_{III}| \quad (7.3)$$

where σ_{id} is the *ideal stress*, that is the comparable stress.

In case of ductile materials the theory assumes that the yielding starts when the maximum stress becomes equal to the yield point stress of the material in simple tension or when the minimum stress becomes equal to the yield point stress of the material in simple compression. Namely, the failure conditions are

$$|\sigma_I| = \sigma'_0 \quad (7.4)$$

$$|\sigma_{III}| = \sigma''_0 \quad (7.5)$$

Whereas, the safety side is ensured by the following conditions

$$|\sigma_I| < \sigma'_0 \quad (7.6)$$

$$|\sigma_{III}| < \sigma''_0 \quad (7.7)$$

This theory is not comprehensive and presents some limits. Consider a specimen under simple tension, sliding occurs along the plane where the stress does not attain the maximum value. Moreover, consider an homogeneous isotropic material weak in simple compression, it can sustain very large hydrostatic pressure without yielding. That proves the magnitude of the maximum tensile or compressive stress alone does not define the yielding condition.

7.3 Maximum strain theory

In this theory, historically attributed to Grashof, it is assumed that the yielding of a ductile material starts when either the maximum strain, i.e. elongation, equals the strain σ'_0/E at which yielding occurs in the simple tension or when the minimum strain, i.e. compressive strain, equals the strain σ''_0/E at which the yielding occurs in simple compression. Therefore, by recalling constitutive equations (4.25) and (4.26) on page 95, the criterion is stated as follows

$$\varepsilon_{max} = \varepsilon'_0 \quad (7.8)$$

$$|\varepsilon_{min}| = \varepsilon''_0 \quad (7.9)$$

that is

$$\varepsilon_{max} = \frac{1}{E} (\sigma_I - \nu (\sigma_{II} + \sigma_{III})) = \frac{\sigma'_0}{E} \quad (7.10)$$

$$\varepsilon_{min} = \frac{1}{E} (\sigma_{III} - \nu (\sigma_I + \sigma_{II})) = \frac{\sigma''_0}{E} \quad (7.11)$$

keeping the order $\sigma_I \leq \sigma_{II} \leq \sigma_{III}$. The *ideal stresses* to be compared to the experimental values σ'_0 and σ''_0 are

$$\sigma'_{id} = \sigma_I - \nu (\sigma_{II} + \sigma_{III}) \quad (7.12)$$

$$\sigma''_{id} = \sigma_{III} - \nu (\sigma_I + \sigma_{II}) \quad (7.13)$$

The failure conditions are

$$|\sigma_I - \nu (\sigma_{II} + \sigma_{III})| = \sigma'_0 \quad (7.14)$$

$$|\sigma_{III} - \nu (\sigma_I + \sigma_{II})| = \sigma''_0 \quad (7.15)$$

where σ'_0 and σ''_0 are, as said before, the failure point stresses in tension and compression, respectively. The safety side is ensured by the following conditions

$$|\sigma_I - \nu (\sigma_{II} + \sigma_{III})| < \sigma'_0 \quad (7.16)$$

$$|\sigma_{III} - \nu (\sigma_I + \sigma_{II})| < \sigma''_0 \quad (7.17)$$

7.4 Beltrami's theory

For the first time in 1885 Beltrami proposed an energetic approach to make comparable a combined state of stress with a simple tension or compression state of stress. Indeed, the *quantity of strain energy* stored per unit of volume of the material has been assumed as a basis to define the stresses at which the yielding starts.

The *elastic potential* or the *volume density of strain energy*, as defined in chapter 6 (equation (6.5) on page 112) for the principal state of stress and strain assumes the following form

$$\phi = \frac{1}{2E} (\sigma_I^2 + \sigma_{II}^2 + \sigma_{III}^2 - 2\nu (\sigma_I \sigma_{II} + \sigma_I \sigma_{III} + \sigma_{II} \sigma_{III})) \quad (7.18)$$

Beltrami stated that the failure of a body under a combined state of stress occurs when its *volume density of strain energy* equals the elastic potential at the yielding point for a simple tension, so that

$$\phi = \frac{\sigma_0^2}{2E} \quad (7.19)$$

where it is assumed that the material has the same behavior both in compression and tension, i.e. $\sigma'_0 = \sigma''_0 = \sigma_0$.

Therefore, taking into account the previous expression for ϕ , we obtain

$$\sigma_I^2 + \sigma_{II}^2 + \sigma_{III}^2 - 2\nu (\sigma_I \sigma_{II} + \sigma_I \sigma_{III} + \sigma_{II} \sigma_{III}) = \sigma_0^2 \quad (7.20)$$

Finally, the linear elastic behavior of the material is ensured when the comparable stress σ_{id} , given as follows

$$\sigma_{id} = \pm \sqrt{\sigma_I^2 + \sigma_{II}^2 + \sigma_{III}^2 - 2\nu (\sigma_I \sigma_{II} + \sigma_I \sigma_{III} + \sigma_{II} \sigma_{III})} \quad (7.21)$$

is lower than the yielding point stress. So we have

$$|\sigma_{id}| \leq \sigma_0 \quad (7.22)$$

7.5 Von Mises' criterion

Following Beltrami's approach, in 1913 R. von Mises proposed a new method to evaluate the failure state for materials. In this theory not the whole *elastic potential* is assumed as responsible for yielding but only the potential energy Φ_D due to the *deviator*

stresses. Namely, Mises' criterion assumes negligible the hydrostatic state of stress to evaluate when the yielding starts.

Recalling equation (3.82) on page 78, any state of stress and strain can be split as follows

$$\sigma_{ij} = \sigma_M \delta_{ij} + s_{ij} \quad (7.23)$$

$$\varepsilon_{ij} = \varepsilon_M \delta_{ij} + e_{ij} \quad (7.24)$$

where σ_M and ε_M are the spherical state of stress and strain respectively, while s_{ij} and e_{ij} are the deviator stresses and strains, respectively. Hence, the total potential energy can be written as follows

$$\begin{aligned} \Phi(\varepsilon_{ij}) &= \frac{1}{2} \sigma_{ij} \varepsilon_{ij} = \frac{1}{2} (\sigma_M \delta_{ij} + s_{ij}) (\varepsilon_M \delta_{ij} + e_{ij}) = \\ &= \frac{1}{2} s_{ij} e_{ij} + \frac{3}{2} \sigma_M \varepsilon_M \end{aligned} \quad (7.25)$$

Let us now define

$$\Phi_M = \frac{3}{2} \sigma_M \varepsilon_M \quad (7.26)$$

as the *spherical energy*, that is the potential energy associated to the volumetric variation of the body and

$$\Phi_D = \frac{1}{2} s_{ij} e_{ij} \quad (7.27)$$

as the *deviator energy*, that is the potential energy associated to the shape variation of the body.

As assumed in Beltrami's criterion, the material is supposed to have the same behavior both in simple tension and compression.

Now, evaluating the deviator energy depending only on the stresses, we have

$$\Phi_D = \frac{1}{2} s_{ij} \frac{s_{ij}}{2G} = \frac{1}{4G} s_{ij} s_{ij} \quad (7.28)$$

The limit value for yielding is obtained by applying the criterion to the simple tension σ_0 which can also be split as follows

$$\begin{aligned} \begin{pmatrix} 0 & 0 & 0 \\ 0 & 0 & 0 \\ 0 & 0 & \sigma_0 \end{pmatrix} &= \begin{pmatrix} \sigma_0/3 & 0 & 0 \\ 0 & \sigma_0/3 & 0 \\ 0 & 0 & \sigma_0/3 \end{pmatrix} + \\ &+ \begin{pmatrix} -\sigma_0/3 & 0 & 0 \\ 0 & -\sigma_0/3 & 0 \\ 0 & 0 & 2\sigma_0/3 \end{pmatrix} \end{aligned} \quad (7.29)$$

consequently, the limit value for the deviator energy results

$$\Phi_D^0 = \frac{1}{4G} \frac{2}{3} \sigma_0^2 \quad (7.30)$$

Finally, imposing the criterion (7.1), that here becomes

$$\Phi_D = \Phi_D^0 \Rightarrow \frac{1}{4G} s_{ij} s_{ij} = \frac{1}{4G} \frac{2}{3} \sigma_0^2 \quad (7.31)$$

the *ideal stress* assumes the following expression

$$\sigma_{id} = \sqrt{\frac{3}{2} s_{ij} s_{ij}} \quad (7.32)$$

The above expression can also be given through the principal stresses as follows

$$\begin{aligned} \sigma_{id} &= \sqrt{\frac{3}{2} s_{ij} s_{ij}} = \\ &= \sqrt{\frac{3}{2} (s_{11}^2 + s_{22}^2 + s_{33}^2 + 2s_{12}^2 + 2s_{13}^2 + 2s_{23}^2)} = \\ &= \sqrt{\frac{3}{2} (s_I^2 + s_{II}^2 + s_{III}^2)} = \\ &= \sqrt{\frac{3}{2} ((\sigma_I - \sigma_M)^2 + (\sigma_{II} - \sigma_M)^2 + (\sigma_{III} - \sigma_M)^2)} = \\ &= \sqrt{\sigma_I^2 + \sigma_{II}^2 + \sigma_{III}^2 - \sigma_I \sigma_{II} - \sigma_{II} \sigma_{III} - \sigma_I \sigma_{III}} \quad (7.33) \end{aligned}$$

7.6 Criteria comparison

To highlight out the differences among the four methods above discussed let us consider the graphical interpretation for each of them. For the sake of simplicity consider the case where $\sigma_{III} = 0$. Thus, the whole state of stress is given by the two principal stresses $\{\sigma_I, \sigma_{II}\}$ not necessarily sorted as equation (7.1) shows. Moreover, we shall assume the material has the same behavior in simple tension and compression.

7.6.1 Maximum stress

By the preceding assumptions the comparable stress in this case turns into

$$\sigma_{id} = \max\{|\sigma_I|, |\sigma_{II}|\} \quad (7.34)$$

and the rupture limits are

$$\sigma_I = \pm\sigma_0 \quad (7.35)$$

$$\sigma_{II} = \pm\sigma_0 \quad (7.36)$$

that on a Cartesian plane depict a square domain. See figure 7.1.

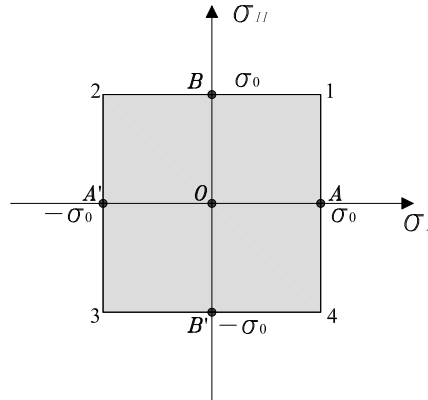

Figure 7.1: Rupture domain for the maximum stress criterion.

The lines in the figure represent the values of σ_I and σ_{II} at which yielding starts. The lengths OA and OB represent the yield points in simple tension along the directions of σ_I and σ_{II} , respectively. In the same way A' and B' represent the yielding points for simple compression. Moreover, the four conditions above ensure that any point within the square 1234 define an elastic configuration. Hence, we can define lines 1234 as rupture (or yielding, for ductile material) boundaries.

7.6.2 Maximum strain

Here the ideal stress assumes the form

$$\sigma_{id} = \max\{|\sigma_I - \nu\sigma_{II}|, |\sigma_{II} - \nu\sigma_I|, |-\nu(\sigma_I + \sigma_{II})|\} \quad (7.37)$$

and the yielding limits are

$$\sigma_I - \nu\sigma_{II} = \pm\sigma_0 \quad (7.38)$$

$$\sigma_{II} - \nu\sigma_I = \pm\sigma_0 \quad (7.39)$$

$$-\nu(\sigma_I + \sigma_{II}) = \pm\sigma_0 \quad (7.40)$$

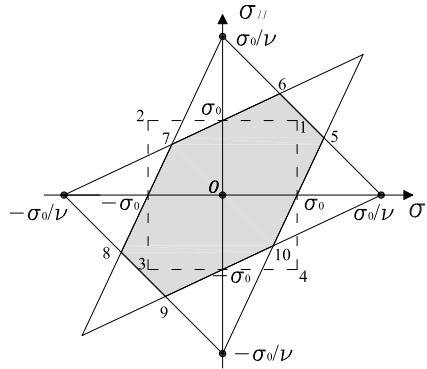

Figure 7.2: Rupture domain for the maximum strain criterion.

that on a Cartesian plane form a domain as shown in figure 7.2.

Note that the drawing in figure 7.2 has only an illustrative intention, in fact, in the reality, points 5–6 and 8–9 are much closer each other when ν approaches values around 0.3.

Figure 7.2 also shows that if two principal stresses are equal and opposite in sign, the maximum strain theory indicates that the yielding starts at a lower value than the maximum stress theory would indicate, see points 4 and 10, for instance.

On the other hand, since a tension in one direction reduces the strain in the perpendicular direction, two equal tension can have higher values at yielding than the maximum stress theory.

7.6.3 Beltrami’s criterion

Here the ideal stress assumes the form

$$\sigma_{id} = \sqrt{\sigma_I^2 + \sigma_{II}^2 - 2\nu\sigma_I\sigma_{II}} \tag{7.41}$$

and the yielding boundary is described by the ellipse

$$\sigma_I^2 + \sigma_{II}^2 - 2\nu\sigma_I\sigma_{II} = \sigma_0^2 \tag{7.42}$$

that intersects the σ_I and σ_{II} axes at points

$$\sigma_I = \pm\sigma_0 \tag{7.43}$$

$$\sigma_{II} = \pm\sigma_0 \tag{7.44}$$

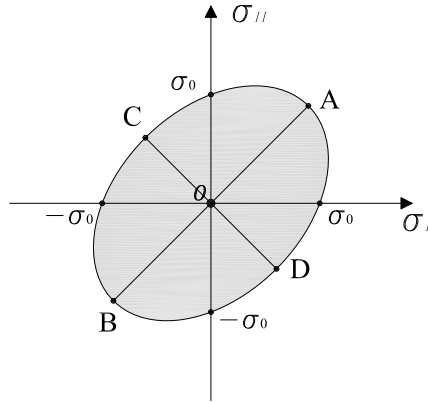

Figure 7.3: Elastic domain for Beltrami's criterion.

The intersections with the bisector $\sigma_{II} = \sigma_I$, passing through the first and third quadrants, occurs at points A and B , see figure 7.4, which have coordinates respectively

$$\sigma_I = \sigma_{II} = \pm \frac{\sigma_0}{\sqrt{2(1-\nu)}} \quad (7.45)$$

while the intersections of the ellipse with the bisector $\sigma_{II} = -\sigma_I$, passing through the second and fourth quadrants, occurs at C and D having the following coordinates

$$\sigma_I = -\frac{\sigma_0}{\sqrt{2(1+\nu)}} \quad \sigma_{II} = +\frac{\sigma_0}{\sqrt{2(1+\nu)}} \quad (7.46)$$

$$\sigma_I = +\frac{\sigma_0}{\sqrt{2(1+\nu)}} \quad -\sigma_{II} = \frac{\sigma_0}{\sqrt{2(1+\nu)}} \quad (7.47)$$

respectively. See figure 7.3.

7.6.4 Von Mises' criterion

From equation (7.33) we derive the expression of the ideal stress when a two-dimensional state of stress occurs

$$\sigma_{id} = \sqrt{\sigma_I^2 + \sigma_{II}^2 - \sigma_I \sigma_{II}} \quad (7.48)$$

hence, the yielding limit is found when $\sigma_{id} = \sigma_0$ so that

$$\sigma_0 = \sqrt{\sigma_I^2 + \sigma_{II}^2 - \sigma_I \sigma_{II}} \quad (7.49)$$

The latter represents in the (σ_I, σ_{II}) -plane the following ellipse

$$\sigma_0^2 = \sigma_I^2 + \sigma_{II}^2 - \sigma_I \sigma_{II} \quad (7.50)$$

having as the major axis the bisector of the first and third quadrants and as minor axis the bisector of the second and fourth quadrant.

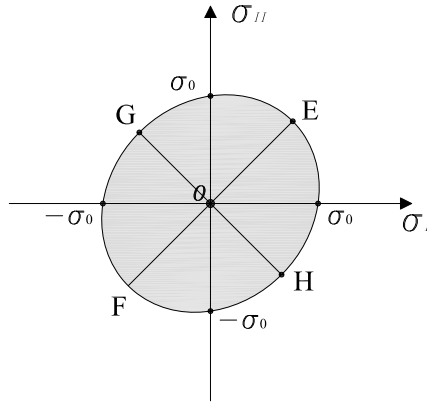

Figure 7.4: Elastic domain for the Mises' criterion.

The intersections with bisector line $\sigma_{II} = \sigma_I$ occurs in points E and F , see figure 7.4, which have coordinates

$$\sigma_I = \sigma_{II} = \pm\sigma_0 \quad (7.51)$$

while the intersection points with the bisector $\sigma_{II} = -\sigma_I$ are G and H which have coordinates

$$\sigma_I = -\frac{\sigma_0}{\sqrt{3}} \quad \sigma_{II} = +\frac{\sigma_0}{\sqrt{3}} \quad (7.52)$$

$$\sigma_I = +\frac{\sigma_0}{\sqrt{3}} \quad -\sigma_{II} = \frac{\sigma_0}{\sqrt{3}} \quad (7.53)$$

respectively. See figure 7.4.

7.6.5 Comparison

In order to compare all the above criteria let us consider a two-dimensional state of stress defined as follows

$$\sigma_{ij} = \begin{pmatrix} 0 & \sigma_{12} \\ \sigma_{12} & 0 \end{pmatrix} \quad (7.54)$$

It is straightforward to represent this stress state through Mohr's circle where we find

$$\begin{aligned}x_C &= 0 \\y_C &= 0 \\R &= \sigma_{12}\end{aligned}$$

and the coordinates of the pole in the (σ, τ) -plane are $P^* \equiv (0, -\sigma_{12})$. For further detail on Mohr's circles see section 3.4.2.

Moreover, the principal stresses located at points S_1 and S_2 , see figure 3.10, are respectively

$$\sigma_I = -\sigma_{II} = \sigma_{12}$$

Thus, if we define the following general expression for the yielding point

$$\sigma_{12} = \alpha \sigma_0$$

then for each criterion we can readily evaluate the coefficient α considering the equations above discussed. For the sake of clarity the relevant results are collected in table 7.1.

CRITERION	α	α ($\nu = 0.3$)
Maximum Stress	1	1
Maximum Strain	$\frac{1}{1+\nu}$	0.77
Beltrami's	$\frac{1}{\sqrt{2(1+\nu)}}$	0.62
Mises'	$\frac{1}{\sqrt{3}}$	0.58

Table 7.1: Criteria comparison.

PART II
Theory of elastic beams

Chapter 8

Saint-Venant's problem

This section is devoted to the theory of the beam. We will first introduce some necessary adjustments of the three-dimensional theory of elasticity in order to provide an ad hoc mathematical model for prismatic structural elements. Then the mechanical behavior of the beam will be analyzed considering separately four fundamental cases.

8.1 Statement of the problem

The solution of the general boundary-value problem presented in section 4.2 often presents some mathematical difficulties because of the complicated form of the boundary conditions. Frequently it is necessary to introduce some simplifications in order to ensure solutions for technological applications of the theory of elasticity, so that the mathematical solutions of the problem represents only an approximation to the actual situation.

In order to simplify the boundary conditions let us assume the following principle on which the theory of beams is founded.

If some distribution of forces acting on a portion of a body is replaced by a different distribution of forces acting on the same portion of the body, then the effects of two different distributions on the parts of the body sufficiently far from the region of application of the forces are essentially the same, provided that the two distributions of forces are statically equivalent.

where “statically” equivalent means that two distributions of forces have the same resultant force and the same resultant moment. This

principle was proposed in 1885 by *J. C. B. de Saint Venant*¹.

First of all we declare the fundamental hypothesis which define a method of solution.

Shape of solid. We define a *beam* as a particular body bounded by a cylindrical surface called the *lateral surface* and by a pair of planes normal to the lateral surface called the *bases* of the cylinder. We shall also suppose the cross section is constant and the beam's length is much larger than the cross section's linear dimension: $l \gg r$, see figure 8.1. The Cartesian coordinate system is positioned having the x_3 -axis taken along the length of beam and parallel to the lateral surface. This axis usually coincides with the axis of the beam passing through the centers of gravity of the bases. The cylinder is assumed to be of length l so that one of its bases belongs to the (x_1, x_2) -plane and the other is taken at $x_3 = l$.

Loads. It is supposed that the lateral surface of the cylinder is load free and that the loads act only on its bases $x_3 = 0$ and $x_3 = l$. Moreover, the forces at the ends assure the equilibrium condition of the cylinder. It is also supposed that the body forces \bar{b} are zero.

Constraints. According to the previous point, we shall suppose that the cylinder is unconstrained, and the forces acting on the bases fulfill the global equilibrium equations. However, to assure that no rigid displacement is allowed, at least one point of the beam, say G , must be fixed. So we will assume that to inhibit any translation, at $x_1 = x_2 = x_3 = 0$, the following constraints hold

$$u_1 = u_2 = u_3 = 0 \quad (8.1)$$

¹Adhémar Jean Claude Barré de Saint-Venant (August 23, 1797 Seine-et-Marne - January 6, 1886 Seine-et-Marne) was a French engineer.



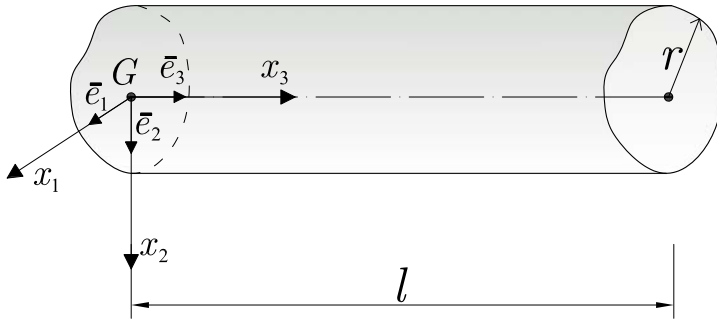

Figure 8.1: Prototype of beam.

and to avoid any rotation we require that

$$u_{2,1} = \varphi_3 = 0 \quad (8.2)$$

$$u_{2,3} = \varphi_1 = 0 \quad (8.3)$$

$$u_{1,3} = \varphi_2 = 0 \quad (8.4)$$

Material. Let us assume an homogeneous isotropic linear elastic material.

State of stress. We shall assume the stress vector normal to the lateral surface is zero. So, for such a unit vector $n = n^i \bar{e}_i = n^1 \bar{e}_1 + n^2 \bar{e}_2$ normal to the lateral surface, in accordance with the location of the coordinate system, we have

$$\sigma_{nn} = \sigma_{ij} n^i n^j = \sigma_{11} n^1 n^1 + \sigma_{22} n^2 n^2 + 2\sigma_{12} n^1 n^2 = 0 \quad (8.5)$$

only if

$$(n^1)^2 + (n^2)^2 = 1 \quad (8.6)$$

Hence, equations (8.5) and (8.6) induce² a particular form of the stress tensor

$$\sigma_{ij} = \begin{pmatrix} 0 & 0 & \sigma_{13} \\ 0 & 0 & \sigma_{23} \\ \sigma_{31} & \sigma_{32} & \sigma_{33} \end{pmatrix}$$

²It can be immediately proved putting first $n^1 = 1$ and $n^2 = 0$, then $n^1 = 0$ and $n^2 = 1$.

The equilibrium problem of an elastic beam with a free lateral surface subjected to loads only on the bases can be formulated as follows: *determine the three components of stress $\sigma_{13}, \sigma_{23}, \sigma_{33}$ and the displacements u_i that satisfy equations*

$$\sigma_{ij,j} = 0 \quad \text{on } \mathcal{V}$$

By virtue of stresses and loads assumptions, the above problem becomes

$$\sigma_{13,3} = 0 \quad (8.7)$$

$$\sigma_{23,3} = 0 \quad \text{on } \mathcal{V} \quad (8.8)$$

$$\sigma_{31,1} + \sigma_{32,2} + \sigma_{33,3} = 0 \quad (8.9)$$

Next, in accordance with the hypotheses, the boundary equations are

$$\sigma_{ij}n_j = \hat{f}_i \quad \text{on } x_3 = 0, x_3 = l \quad (8.10)$$

that can be expanded as follows

$$x_3 = 0, \bar{n} = (0, 0, -1)$$

$$\sigma_{13}n_3 = -\sigma_{13} = \hat{f}_1 \quad (8.11)$$

$$\sigma_{23}n_3 = -\sigma_{23} = \hat{f}_2 \quad (8.12)$$

$$\sigma_{33}n_3 = -\sigma_{33} = \hat{f}_3 \quad (8.13)$$

$$x_3 = l, \bar{n} = (0, 0, 1)$$

$$\sigma_{13}n_3 = \sigma_{13} = \hat{f}_1 \quad (8.14)$$

$$\sigma_{23}n_3 = \sigma_{23} = \hat{f}_2 \quad (8.15)$$

$$\sigma_{33}n_3 = \sigma_{33} = \hat{f}_3 \quad (8.16)$$

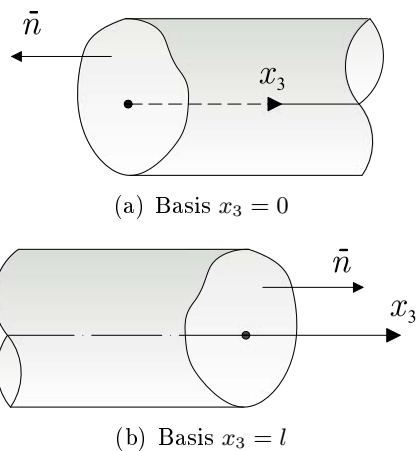

Figure 8.2: Unit normal vectors on the bases of the cylinder.

Constitutive equations (4.25) become

$$\varepsilon_{11} = -\frac{1}{E}\nu\sigma_{33} \quad (8.17)$$

$$\varepsilon_{22} = -\frac{1}{E}\nu\sigma_{33} \quad (8.18)$$

$$\varepsilon_{33} = \frac{1}{E}((1 + \nu)\sigma_{33} - \nu\sigma_{33}) = \frac{\sigma_{33}}{E} \quad (8.19)$$

$$\varepsilon_{12} = 0 \quad (8.20)$$

$$\varepsilon_{13} = \frac{(1 + \nu)}{E}\sigma_{13} \quad (8.21)$$

$$\varepsilon_{23} = \frac{(1 + \nu)}{E}\sigma_{23} \quad (8.22)$$

Now, making use of *Beltrami-Michell's* equations (4.44), it is

possible to write

$$\sigma_{33,11} = 0 \quad (8.23)$$

$$\sigma_{33,12} = 0 \quad (8.24)$$

$$\sigma_{33,22} = 0 \quad (8.25)$$

$$\sigma_{33,11} + \sigma_{33,22} + \sigma_{33,33} + \frac{1}{1+\nu}\sigma_{33,33} = 0 \quad (8.26)$$

$$\sigma_{23,11} + \sigma_{23,22} + \sigma_{23,33} + \frac{1}{1+\nu}\sigma_{33,23} = 0 \quad (8.27)$$

$$\sigma_{13,11} + \sigma_{13,22} + \sigma_{13,33} + \frac{1}{1+\nu}\sigma_{33,13} = 0 \quad (8.28)$$

and by means of equations (8.7) and (8.8), the above expressions turn into

$$\sigma_{33,33} + \frac{1}{1+\nu}\sigma_{33,33} = 0 \Rightarrow \sigma_{33,33} = 0 \quad (8.29)$$

$$\sigma_{23,11} + \sigma_{23,22} + \frac{1}{1+\nu}\sigma_{33,23} = 0 \quad (8.30)$$

$$\sigma_{13,11} + \sigma_{13,22} + \frac{1}{1+\nu}\sigma_{33,13} = 0 \quad (8.31)$$

Equations (8.23), (8.25) and (8.29) suggest that the component σ_{33} must vary linearly with x_1, x_2, x_3 , while equation (8.24) imposes that it cannot contain the product x_1x_2 . Hence, $\sigma_{33} = \sigma_{33}(x_1, x_2, x_3)$ must assume the following form

$$\sigma_{33} = a + bx_1 + cx_2 - (d + ex_1 + fx_2)x_3 \quad (8.32)$$

See also [9] and [11].

8.1.1 External and internal forces

In this section we point out that in most of the practical circumstances we know the resultant force \hat{F} and the resultant moment \hat{M} acting on the ends of a beam rather than the real external surface force distribution \hat{f} . Indeed, if we accept the *Saint Venant's* principle, we could not care about the nature of the stress distribution which produces the resultants \hat{F} and \hat{M} , just because we are interested in portions of beam sufficiently far from the ends where the influences of boundary stress distribution is not decisive.

Let us fix our attention on the bases of the cylinder. Firstly, on the basis $x_3 = 0$, denoted by \mathcal{A}_0 , we assume a distribution of surface forces given by \hat{f}^0 , next, on the basis $x_3 = l$, denoted by \mathcal{A}_l , we assume a distribution of surface forces \hat{f}^l .

For the basis $x_3 = l$ the resultant external force are related to the external surface forces as follows

$$\hat{T}_1^l = \int_{\mathcal{A}_l} \hat{f}_1^l d\mathcal{A} \quad (8.33)$$

$$\hat{T}_2^l = \int_{\mathcal{A}_l} \hat{f}_2^l d\mathcal{A} \quad (8.34)$$

$$\hat{N}^l = \int_{\mathcal{A}_l} \hat{f}_3^l d\mathcal{A} \quad (8.35)$$

and, of course, we can do the same for the basis $x_3 = 0$

$$\hat{T}_1^0 = \int_{\mathcal{A}_0} \hat{f}_1^0 d\mathcal{A} \quad (8.36)$$

$$\hat{T}_2^0 = \int_{\mathcal{A}_0} \hat{f}_2^0 d\mathcal{A} \quad (8.37)$$

$$\hat{N}^0 = \int_{\mathcal{A}_0} \hat{f}_3^0 d\mathcal{A} \quad (8.38)$$

where \hat{T}_1 and \hat{T}_2 , lying in the plane of the basis, are responsible for bending and shearing of the beam, while \hat{N} , taken in x_3 -direction, is responsible for tension or compression. See figure 8.3.

The couple \hat{M} , analogously, may be split into a component \hat{M}_3 along the x_3 -axis which provides the twisting for the beam and the components \hat{M}_1 and \hat{M}_2 which are responsible for bending. Thus, for both bases we have

$$\hat{M}_1^l = \int_{\mathcal{A}_l} \hat{f}_3^l x_2 d\mathcal{A} \quad (8.39)$$

$$\hat{M}_2^l = - \int_{\mathcal{A}_l} \hat{f}_3^l x_1 d\mathcal{A} \quad (8.40)$$

$$\hat{M}_3^l = \int_{\mathcal{A}_l} \left(-\hat{f}_1^l x_2 + \hat{f}_2^l x_1 \right) d\mathcal{A} \quad (8.41)$$

and

$$\hat{M}_1^0 = \int_{\mathcal{A}_0} \hat{f}_3^0 x_2 d\mathcal{A} \quad (8.42)$$

$$\hat{M}_2^0 = - \int_{\mathcal{A}_0} \hat{f}_3^0 x_1 d\mathcal{A} \quad (8.43)$$

$$\hat{M}_3^0 = \int_{\mathcal{A}_0} \left(-\hat{f}_1^0 x_2 + \hat{f}_2^0 x_1 \right) d\mathcal{A} \quad (8.44)$$

where the moments have been computed with respect to the centers of gravity for \mathcal{A}_l and \mathcal{A}_0 , respectively. See figure 8.3.

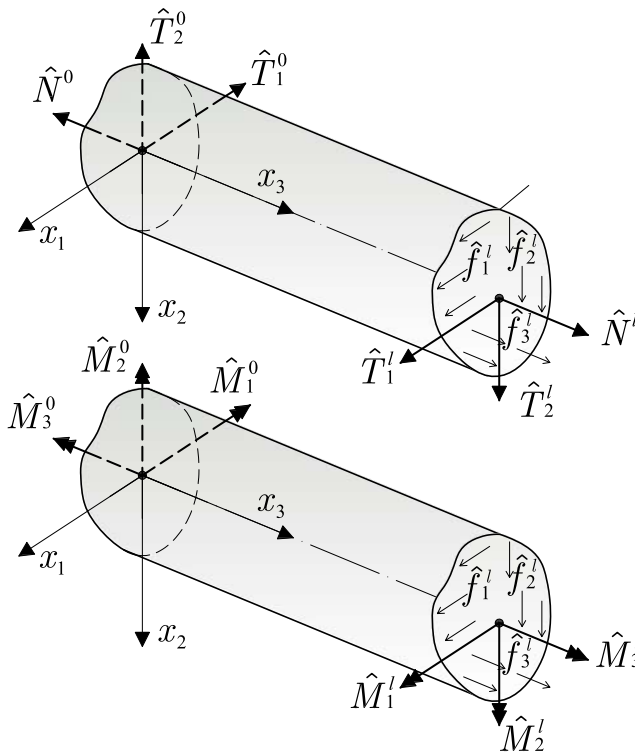

Figure 8.3: Equilibrated components of force and couple resultants acting on the ends of the beam.

As already mentioned, the readers should be aware that in many actual problems we shall know just the components of resultants \hat{F} and \hat{M} rather than the actual distribution of surface forces \hat{f} , so, usually, we will solve an inverse problem. To this end in the following

we want to find how the resultant forces are transmitted inside the beam.

From the end $x_3 = l$, towards the opposite basis $x_3 = 0$, the external actions propagate in such a way that, for any cross-section taken at the distance x_3 from the origin of the coordinate system, the components of resultant forces and moments are, respectively

$$N^+(x_3) = \hat{N}^l \quad (8.45)$$

$$T_1^+(x_3) = \hat{T}_1^l \quad (8.46)$$

$$T_2^+(x_3) = \hat{T}_2^l \quad (8.47)$$

and

$$M_1^+(x_3) = \hat{M}_1^l - \hat{T}_2^l(l - x_3) \quad (8.48)$$

$$M_2^+(x_3) = \hat{M}_2^l + \hat{T}_1^l(l - x_3) \quad (8.49)$$

$$M_3^+(x_3) = \hat{M}_3^l \quad (8.50)$$

where the sign convention has been established by the following rule: on the “positive side” of a generic cross section whenever the forces orientation and the coordinate axes are concordant, then the positive sign is assigned; concerning the components of the couples, the positive sign is ascribed whenever the moments are concordant with the following rotations: $x_2 \rightarrow x_3$, $x_3 \rightarrow x_1$, $x_1 \rightarrow x_2$.

Here the reader will also realize that by virtue of the equilibrium condition of the cylinder, taking into account the external actions from the opposite side, here crudely named “negative side”, for the same generic cross section considered above, the local equilibrium condition must be assured. In this view, the sign convention assumed when the “negative side” of a generic cross section is taken into account, is: the external forces have positive sign if they are discordant with the coordinate axes and, concerning the moments, they will be assumed with a positive sign if they induce the following rotations: $x_3 \rightarrow x_2$, $x_1 \rightarrow x_3$, $x_2 \rightarrow x_1$. In the light of this sign convention, we notice that equations (8.45) to (8.50) can be equivalently written, for the same generic cross section at x_3 , considering the external actions on the “negative part”, that means

$$N^-(x_3) = \hat{N}^0$$

$$T_1^-(x_3) = \hat{T}^0$$

$$T_2^-(x_3) = \hat{T}_2^0$$

and

$$\begin{aligned} M_1^- (x_3) &= \hat{M}_1^0 + \hat{T}_2^0 x_3 \\ M_2^- (x_3) &= \hat{M}_2^0 - \hat{T}_1^0 x_3 \\ M_3^- (x_3) &= \hat{M}_3^0 \end{aligned}$$

Naturally, for each cross section the external actions on the right-hand side (“positive part”) must equal those on the left-hand side (“negative part”)³, indeed we can write

$$\begin{aligned} N^- (x_3) &= N^+ (x_3) \\ T_1^- (x_3) &= T_1^+ (x_3) \\ T_2^- (x_3) &= T_2^+ (x_3) \end{aligned}$$

and

$$\begin{aligned} M_1^- (x_3) = M_1^+ (x_3) &\Rightarrow \hat{M}_1^0 + \hat{T}_2^0 x_3 = \hat{M}_1^l - \hat{T}_2^l (l - x_3) \\ M_2^- (x_3) = M_2^+ (x_3) &\Rightarrow \hat{M}_2^0 - \hat{T}_1^0 x_3 = \hat{M}_2^l + \hat{T}_1^l (l - x_3) \\ M_3^- (x_3) = M_3^+ (x_3) &\Rightarrow \hat{M}_3^0 = \hat{M}_3^l \end{aligned}$$

When $x_3 = 0$ the first set of the above equations remains unaltered, while the second, i.e. the bending forces, becomes

$$\begin{aligned} M_1^- (0) = M_1^+ (0) &\Rightarrow \hat{M}_1^0 = \hat{M}_1^l - \hat{T}_2^l l \\ M_2^- (0) = M_2^+ (0) &\Rightarrow \hat{M}_2^0 = \hat{M}_2^l + \hat{T}_1^l l \\ M_3^- (0) = M_3^+ (0) &\Rightarrow \hat{M}_3^0 = \hat{M}_3^l \end{aligned}$$

In order to pass from $M_i^- (0)$ to \hat{M}_i^0 the signs must be corrected in accordance with the global sign convention, that is

$$\begin{aligned} \hat{N}^0 &= -N^- (0) = -\hat{N}^l \\ \hat{T}_1^0 &= -T_1^- (0) = -\hat{T}_1^l \\ \hat{T}_2^0 &= -T_2^- (0) = -\hat{T}_2^l \end{aligned}$$

and

$$\begin{aligned} \hat{M}_1^0 &= -M_1^- (0) = -\hat{M}_1^l + \hat{T}_2^l l \\ \hat{M}_2^0 &= -M_2^- (0) = -\hat{M}_2^l - \hat{T}_1^l l \\ \hat{M}_3^0 &= -M_3^- (0) = -\hat{M}_3^l \end{aligned}$$

³For this reason hereafter we will omit the primes $(\cdot)^+$ or $(\cdot)^-$.

Now, imagine to cut the beam at the cross section located at x_3 . The set of forces $\{T_1, T_2, N, M_1, M_2, M_3\}$ can be seen as external forces, thus, for this section - that is assumed being seen from the right-hand side - the well known boundary condition $\sigma_{ij} = \hat{f}_i$ holds. This justifies the following expressions

$$T_1 = \int_{\mathcal{A}} \sigma_{31} d\mathcal{A} \quad (8.51)$$

$$T_2 = \int_{\mathcal{A}} \sigma_{32} d\mathcal{A} \quad (8.52)$$

$$N = \int_{\mathcal{A}} \sigma_{33} d\mathcal{A} \quad (8.53)$$

and

$$M_1 = \int_{\mathcal{A}} \sigma_{33} x_2 d\mathcal{A} \quad (8.54)$$

$$M_2 = - \int_{\mathcal{A}} \sigma_{33} x_1 d\mathcal{A} \quad (8.55)$$

$$M_3 = \int_{\mathcal{A}} (-\sigma_{31} x_2 + \sigma_{32} x_1) d\mathcal{A} \quad (8.56)$$

8.2 Four fundamental cases

Now we are ready to present the four fundamental cases that, by virtue of the superposition principle, allow us to entirely solve the problem of elastic beams. They are

- Extension of a beam by axial force applied at the ends.
- Bending of a beam by couples whose moments lie in the plane of its bases.
- Torsion of a beam by a couples whose moment is normal to its basis.
- Flexure of a beam by transverse forces applied at one end of the cylinder, while on the other end it is acting an opposite transverse force and a couple in such a way the equilibrium condition is fulfilled.

8.3 Beam under axial force

8.3.1 State of stress

Consider the basis $x_3 = l$, and assume that the \hat{N}^l is the only nonzero external force

$$\hat{N}^l \neq 0 \quad (8.57)$$

$$\hat{T}_1^l = \hat{T}_2^l = \hat{M}_1^l = \hat{M}_2^l = \hat{M}_3^l = 0 \quad (8.58)$$

therefore, in accordance with equations (8.45) to (8.50), for a generic cross section at x_3 , the external forces are

$$N = \hat{N}^l \quad (8.59)$$

$$T_1 = T_2 = M_1 = M_2 = M_3 = 0 \quad (8.60)$$

Making use of equations (8.51) to (8.53) and the boundary equations (8.14) to (8.16), the surface forces are

$$\hat{f}_3 \neq 0 \quad (8.61)$$

$$\hat{f}_1 = \hat{f}_2 = 0 \quad (8.62)$$

So, considering expression (8.32) for the normal stress we can write

$$N = \int_{\mathcal{A}} (a + bx_1 + cx_2 - (d + ex_1 + fx_2)x_3) d\mathcal{A} \quad (8.63)$$

and recalling equation (8.9), where $\sigma_{31} = \hat{f}_1 = 0$ and $\sigma_{32} = \hat{f}_2 = 0$, the above equation turns into

$$N = \int_{\mathcal{A}} (a + bx_1 + cx_2) d\mathcal{A} = \quad (8.64)$$

$$= a \int_{\mathcal{A}} d\mathcal{A} + b \underbrace{\int_{\mathcal{A}} x_1 d\mathcal{A}}_{=0} + c \underbrace{\int_{\mathcal{A}} x_2 d\mathcal{A}}_{=0} \quad (8.65)$$

so we have proved that

$$a = \frac{N}{\mathcal{A}} \quad (8.66)$$

Equations (8.39), (8.40), through condition (8.58), represent a linear system whose solution yields

$$b = c = 0$$

hence, the expression of the normal stress is finally

$$\sigma_{33} = \frac{N}{\mathcal{A}} \quad (8.67)$$

and the stress tensor assumes the following form

$$\sigma_{ij} = \begin{pmatrix} 0 & 0 & 0 \\ 0 & 0 & 0 \\ 0 & 0 & N/\mathcal{A} \end{pmatrix}$$

8.3.2 State of strain

The deformation of a beam under an axial force results directly from the constitutive laws (8.17) to (8.22), so that

$$\varepsilon_{11} = -\nu \frac{N}{E\mathcal{A}} \quad (8.68)$$

$$\varepsilon_{22} = -\nu \frac{N}{E\mathcal{A}} \quad (8.69)$$

$$\varepsilon_{33} = \frac{N}{E\mathcal{A}} \quad (8.70)$$

and the strain tensor is

$$\varepsilon_{ij} = \begin{pmatrix} -\nu N/E\mathcal{A} & 0 & 0 \\ 0 & -\nu N/E\mathcal{A} & 0 \\ 0 & 0 & N/E\mathcal{A} \end{pmatrix}$$

8.3.3 Displacement field

In order to compute the displacement field $u_i = u_i(x_j)$ of the cylindrical body we have to solve the system of differential equations obtained from compatibility relationships. Hence, the equations are

$$\begin{cases} u_{1,1} = \varepsilon_{11} = -\nu \frac{N}{E\mathcal{A}} \\ u_{2,2} = \varepsilon_{22} = -\nu \frac{N}{E\mathcal{A}} \\ u_{3,3} = \varepsilon_{33} = \frac{N}{E\mathcal{A}} \end{cases} \quad \text{and} \quad \begin{cases} u_{1,2} + u_{2,1} = 2\varepsilon_{12} = 0 \\ u_{1,3} + u_{3,1} = 2\varepsilon_{13} = 0 \\ u_{2,3} + u_{3,2} = 2\varepsilon_{23} = 0 \end{cases}$$

The integration of the first group of equations gives

$$\begin{cases} u_1 = -\nu \frac{N}{E\mathcal{A}} x_1 + \alpha(x_2, x_3) \\ u_2 = -\nu \frac{N}{E\mathcal{A}} x_2 + \beta(x_1, x_3) \\ u_3 = \frac{N}{E\mathcal{A}} x_3 + \gamma(x_1, x_2) \end{cases}$$

where α, β, γ are unknown functions. Replacing the above expressions in the second group of differential equations, and assuming inhibited any rigid body motion, some calculations drive us to write the following solution

$$u_1 = -\nu \frac{N}{EA} x_1 \quad (8.71)$$

$$u_2 = -\nu \frac{N}{EA} x_2 \quad (8.72)$$

$$u_3 = \frac{N}{EA} x_3 \quad (8.73)$$

Through the above results we are able to know the strained shape of a beam subjected to an axial force. Let p be a point inside the beam, so that $p \equiv (x_1, x_2, x_3)$, we notice that the displacement u_3 of p does not depend on the position of p in the cross section area, so we have constant displacements along x_3 -axis for each cross section. Let $p' \equiv (x'_1, x'_2, x'_3)$ be the position of p after the deformation, so that

$$x'_1 = x_1 + u_1 \quad (8.74)$$

$$x'_2 = x_2 + u_2 \quad (8.75)$$

$$x'_3 = x_3 + u_3 \quad (8.76)$$

we can define *unit axial strain* as

$$\frac{(u_3 + du_3) - u_3}{dx_3} = \varepsilon_{33} = \frac{N}{EA} \quad (8.77)$$

that integrated along the entire length of the beam gives the axial elongation

$$\Delta l = \int_l \varepsilon_{33} dx_3 = \varepsilon_{33} l \quad (8.78)$$

To the elongation Δl corresponds a cross-section contraction $\bar{\rho}$ that can be measured by the vector sum of u_1 and u_2 as follows

$$\bar{\rho} = u_1 \bar{e}_1 + u_2 \bar{e}_2 \quad (8.79)$$

The magnitude of $\bar{\rho}$ is

$$\rho = \sqrt{u_1^2 + u_2^2} = \frac{\nu N}{EA} \sqrt{x_1^2 + x_2^2} \quad (8.80)$$

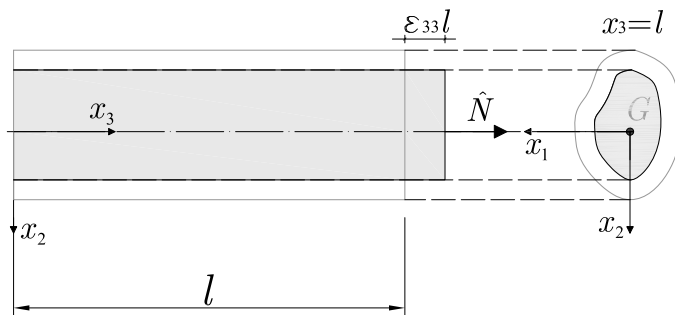

Figure 8.4: Strained state of a beam subjected to an axial force.

Equation (8.80) shows that the displacement of a point $p \in \mathcal{A}$ depends solely on its distance from the center of gravity of \mathcal{A} . We say also that each point p moves towards G along radial direction. In fact, by considering a polar coordinate system $\{r, \vartheta\}$ with the origin in the centroid G , the related basis is obtained by making use of the well known transformations, see page 20 in chapter 1,

$$\bar{\partial}_r = \frac{\partial x_1}{\partial r} \bar{e}_1 + \frac{\partial x_2}{\partial r} \bar{e}_2 = \sin \vartheta \bar{e}_1 + \cos \vartheta \bar{e}_2 \quad (8.81)$$

$$\bar{\partial}_\vartheta = \frac{\partial x_1}{\partial \vartheta} \bar{e}_1 + \frac{\partial x_2}{\partial \vartheta} \bar{e}_2 = r \cos \vartheta \bar{e}_1 - r \sin \vartheta \bar{e}_2 \quad (8.82)$$

hence, to ensure the radial direction, it is enough to prove that $\bar{\partial}_\vartheta \cdot \bar{\rho} = 0$. Indeed we have

$$\bar{\partial}_\vartheta \cdot \bar{\rho} = u_1 \sin \vartheta - u_2 \cos \vartheta = x_2 \cos \vartheta \frac{\nu N}{EA} \left(-\frac{x_1}{x_2} + \tan \vartheta \right) \quad (8.83)$$

but since it is also known that $x_1/x_2 = \tan \vartheta$, (8.83) always vanishes. See figure 8.5.

8.3.4 Strain energy

By virtue of Clapeyron's theorem, see equation (6.15) on page 114, the strain energy is

$$\Phi = \frac{1}{2} \hat{N}^l \Delta l = \frac{1}{2} N \varepsilon_{33} l = \frac{1}{2} \frac{N^2 l}{EA} \quad (8.84)$$

or, in the same way, by using the PLV, we have

$$\Phi = \frac{1}{2} \int_{\mathcal{V}} \sigma_{33} \varepsilon_{33} d\mathcal{V} = \frac{1}{2} \mathcal{A} \int_l \frac{N}{\mathcal{A}} \frac{N}{EA} dx_3 = \frac{1}{2} \frac{N^2 l}{EA} \quad (8.85)$$

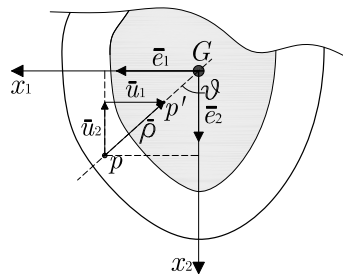

Figure 8.5: Strained state of a beam subjected to an axial force: radial contraction.

8.4 Beam under terminal couples

8.4.1 Introductory sketch

Before going ahead it is useful to consider an idealized model of beam made up of long filaments parallel to the axis of the cylinder. By virtue of *Saint Venant's* hypotheses we know that the stresses are zero on the lateral surfaces, in the direction perpendicular to filaments' length, and act only on the ends of the filaments.

Let us consider now a beam subjected to a pair of equilibrated couples at the ends. See figure 8.6. Because of the couples, the lower longitudinal filaments, those towards the center of curvature, will be contracted and the extrados, the upper portion of filaments, will be extended. We shall assume that the *central line*, i.e. the line passing through the centroid of all cross sections, is unaltered in length and the cross sections lie always in a plane normal to the central line.

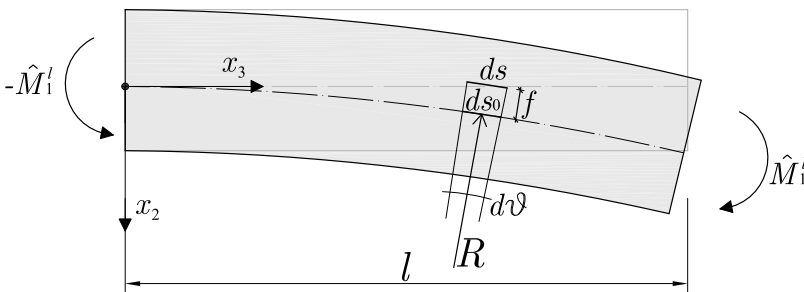

Figure 8.6: Beam under terminal couples.

The upper longitudinal filaments, initially parallel to the x_3 -

axis, under the effects of the couples, at a distance f from the central line, turn from ds_0 into ds

$$ds = (R + f) d\vartheta \quad (8.86)$$

where R is the radius of curvature of the central line. Now we are interested in evaluating the elongation of a generic material fibre, so we define the extension e as

$$e = \frac{ds - ds_0}{ds_0} = \frac{(R + f) d\vartheta - R d\vartheta}{R d\vartheta} = \frac{f}{R} \quad (8.87)$$

This linear elongation may be thought to be produced by a longitudinal stress σ_{33} which in accordance with equation (8.19) is given by

$$\sigma_{33} = \frac{E}{R} f \quad (8.88)$$

These intuitive considerations allow us to understand that the normal stress produced by the flexure of a beam is not constant along the cross section and is proportional to the distance from the central line.

8.4.2 State of stress

In this case we assume that the external forces acting at the end of a beam are couples whose moments lie in the plane of the cylinder. So that

$$\hat{M}_1^l \neq 0, \quad \hat{M}_2^l \neq 0 \quad (8.89)$$

$$\hat{N}^l = \hat{T}_1^l = \hat{T}_2^l = \hat{M}_3^l = 0 \quad (8.90)$$

therefore, in accordance with equations (8.45) to (8.50), for a generic cross section located at x_3 the external forces propagate as follows

$$M_1 = \hat{M}_1^l \quad (8.91)$$

$$M_2 = \hat{M}_2^l \quad (8.92)$$

$$N = T_1 = T_2 = M_3 = 0 \quad (8.93)$$

The boundary conditions (8.14), (8.15), (8.16) on page 146 in this case are

$$\hat{f}_3 \neq 0 \quad (8.94)$$

$$\hat{f}_1 = \hat{f}_2 = 0 \quad (8.95)$$

Hence, we can write

$$\int_{\mathcal{A}} \sigma_{33} d\mathcal{A} = 0 \quad (8.96)$$

$$M_1 = \int_{\mathcal{A}} \sigma_{33} x_2 d\mathcal{A} \quad (8.97)$$

$$M_2 = - \int_{\mathcal{A}} \sigma_{33} x_1 d\mathcal{A} \quad (8.98)$$

which become

$$\int_{\mathcal{A}} (a + bx_1 + cx_2) d\mathcal{A} = 0 \quad (8.99)$$

$$M_1 = \int_{\mathcal{A}} (a + bx_1 + cx_2 x_2) d\mathcal{A} \quad (8.100)$$

$$M_2 = - \int_{\mathcal{A}} (a + bx_1 + cx_2) x_1 d\mathcal{A} \quad (8.101)$$

By integrating equation (8.99) we find $a = 0$, therefore equations (8.100) and (8.101) become

$$M_1 = \int_{\mathcal{A}} bx_1 x_2 d\mathcal{A} + \int_{\mathcal{A}} cx_2^2 d\mathcal{A} \quad (8.102)$$

$$M_2 = - \int_{\mathcal{A}} bx_1^2 d\mathcal{A} + \int_{\mathcal{A}} cx_2 x_1 d\mathcal{A} \quad (8.103)$$

that can be written in matrix form as follows

$$\begin{pmatrix} J_{12} & J_1 \\ J_2 & J_{12} \end{pmatrix} \begin{pmatrix} b \\ c \end{pmatrix} = \begin{pmatrix} M_1 \\ -M_2 \end{pmatrix}$$

In order to simplify the solution of the above linear system, we may rewrite the system with respect to the axes of inertia (ξ, η) , so it becomes

$$\begin{pmatrix} 0 & J_{\xi} \\ J_{\eta} & 0 \end{pmatrix} \begin{pmatrix} b \\ c \end{pmatrix} = \begin{pmatrix} M_{\xi} \\ -M_{\eta} \end{pmatrix}$$

that resolved for b, c , gives

$$c = \frac{M_{\xi}}{J_{\xi}} \quad (8.104)$$

$$b = -\frac{M_{\eta}}{J_{\eta}} \quad (8.105)$$

and finally, the stress induced by the couples is

$$\sigma_{33} = -\frac{M_\eta}{J_\eta}\xi + \frac{M_\xi}{J_\xi}\eta \quad (8.106)$$

By means of equation (8.106) we are able to find the line of zero stress below of which all the fibers are in tension and above of which they are in compression. This line is termed *neutral axis*. We shall denote it by $\mathbf{n} - \mathbf{n}$. See figure 8.7. In the (ξ, η) -plane, the equation of the neutral axis is provided as follows

$$\sigma_{33} = -\frac{M_\eta}{J_\eta}\xi + \frac{M_\xi}{J_\xi}\eta = 0 \Rightarrow \quad (8.107)$$

$$\eta = \frac{M_\eta}{M_\xi} \left(\frac{\rho_\xi}{\rho_\eta} \right)^2 \xi \quad (8.108)$$

where we have set $J_\xi = \rho_\xi^2 \mathcal{A}$ and $J_\eta = \rho_\eta^2 \mathcal{A}^4$. Now if γ is the angle between the axes $(\xi, \mathbf{n} - \mathbf{n})$, we can put

$$\tan \gamma = \frac{M_\eta}{M_\xi} \left(\frac{\rho_\xi}{\rho_\eta} \right)^2 \quad (8.109)$$

which, if $\tan \delta = M_\eta/M_\xi$, see figure 8.7, becomes

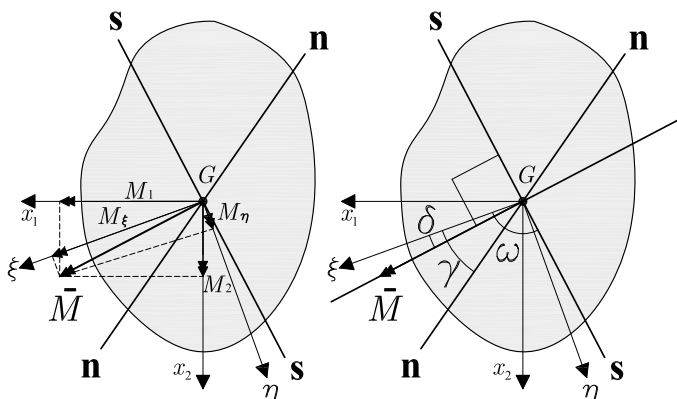

Figure 8.7: Projection of the couples and rotation axis.

$$\frac{\tan \gamma}{\tan \delta} = \left(\frac{\rho_\xi}{\rho_\eta} \right)^2 \quad (8.110)$$

⁴Note that ρ_ξ and ρ_η are the radius of gyration taken along η and ξ respectively. They satisfy the equation $\xi^2/\rho_\eta^2 + \eta^2/\rho_\xi^2 = 1$.

Furthermore, let ω be the angle between the axes $(\xi, \mathbf{s} - \mathbf{s})$, see figure 8.7 on the preceding page, we notice that $\frac{\pi}{2} + \delta = \omega$ so we can write

$$\cot \omega = \cot \left(\frac{\pi}{2} + \delta \right) = -\tan \delta \quad (8.111)$$

while equation (8.110) becomes

$$\tan \gamma \tan \omega = - \left(\frac{\rho_\xi}{\rho_\eta} \right)^2 \quad (8.112)$$

The latter equation allows us to find the neutral axis given any bending pair M_1 and M_2 . In fact, we can summarize the procedure to find the neutral axis in the following items

- find the axis $\mathbf{s} - \mathbf{s}$, orthogonal to the bending vector $\bar{M} = M_1 \bar{e}_1 + M_2 \bar{e}_2$;
- find the principal axes of inertia, i.e. rotate the system $\{x_1, x_2\}$ into $\{\xi, \eta\}$ and compute the radii of gyration;
- ω is now known;
- γ , i.e. the position of the neutral axis, can be computed by equation (8.112).

The axis $(\mathbf{f} - \mathbf{f})$ orthogonal to the neutral axis $\mathbf{n} - \mathbf{n}$ is called *flexural axis* and the angle it forms with the axis $\mathbf{s} - \mathbf{s}$ gives a measure of the bending deviation.

8.4.3 State of strain

The state of strain results directly from constitutive laws (8.17) to (8.22). Hence, chosen the system of principal axes (ξ, η, x_3) , with respect to the origin G , we can write

$$\varepsilon_{\xi\xi} = -\frac{\nu}{E} \sigma_{33} \quad (8.113)$$

$$\varepsilon_{\eta\eta} = -\frac{\nu}{E} \sigma_{33} \quad (8.114)$$

$$\varepsilon_{33} = \frac{\sigma_{33}}{E} \quad (8.115)$$

A simpler solution is obtained by introducing a new coordinate system $\{x, y, z\}$ where, as showed on figure 8.8, x is the neutral axis,

y is the flexural axis, and $z = x_3$. The advantage of this coordinate system is that the normal stress can be written as

$$\sigma_{zz} = my \quad (8.116)$$

and the constant m is readily computed by

$$M_x = \int_{\mathcal{A}} \sigma_{zz} y d\mathcal{A} = m \int_{\mathcal{A}} y^2 d\mathcal{A} = mJ_x \quad (8.117)$$

hence

$$m = \frac{M_x}{J_x} \quad (8.118)$$

Finally, equation (8.106) assumes the following monomial expression

$$\sigma_{zz} = \frac{M_x}{J_x} y \quad (8.119)$$

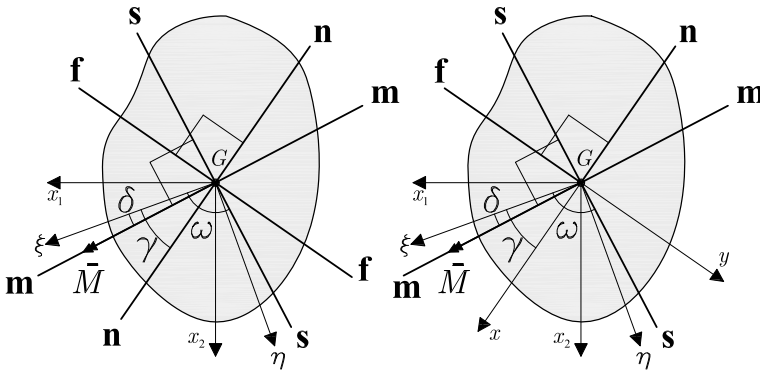

Figure 8.8: Neutral axis and flexural axis.

Equation (8.119) is also known as *Navier formula*. See also [9] and [11] for a proof based on geometric considerations.

The state of strain associated with the following state of stress

$$\sigma_{ij} = \begin{pmatrix} 0 & 0 & 0 \\ 0 & 0 & 0 \\ 0 & 0 & (M_x/J_x) y \end{pmatrix} \quad (8.120)$$

assumes the form

$$\varepsilon_{ij} = \begin{pmatrix} -\nu\kappa y & 0 & 0 \\ 0 & -\nu\kappa y & 0 \\ 0 & 0 & \kappa y \end{pmatrix} \quad (8.121)$$

where

$$\kappa = \frac{M_x}{EJ_x} \quad (8.122)$$

κ has an important geometric interpretation which will be discussed in the next paragraph.

Now, recalling equations (2.78) and (2.79) on page 49, it is possible to prove that

$$\Delta\mathcal{A} = \int_{\mathcal{A}} (\varepsilon_{xx} + \varepsilon_{yy}) d\mathcal{A} = -2\nu\kappa \underbrace{\int_{\mathcal{A}} y d\mathcal{A}}_{=0} = 0 \quad (8.123)$$

$$\begin{aligned} \Delta\mathcal{V} &= \int_{\mathcal{V}} (\varepsilon_{xx} + \varepsilon_{yy} + \varepsilon_{zz}) d\mathcal{V} = \int_l dz \int_{\mathcal{A}} \kappa y (1 - 2\nu) d\mathcal{A} \\ &\quad (1 - 2\nu) l \underbrace{\int_{\mathcal{A}} y d\mathcal{A}}_{=0} = 0 \end{aligned} \quad (8.124)$$

So we notice that throughout the deformation the initial volume and the area of every cross-section is unaltered.

8.4.4 Displacement field

As the foregoing case, the field of displacement \bar{u} can be found by integrating the system of differential equations (2.70) on page 48. Let us rename the displacement components with respect to the $\{x, y, z\}$ coordinate system, as $u_1 = u$, $u_2 = v$, $u_3 = w$. Hence, the compatibility equations are

$$\left\{ \begin{array}{l} u_{,x} = \varepsilon_{xx} = -\nu\kappa y \\ v_{,y} = \varepsilon_{yy} = -\nu\kappa y \\ w_{,z} = \varepsilon_{zz} = \kappa y \end{array} \right. \quad \text{and} \quad \left\{ \begin{array}{l} u_{,y} + v_{,x} = 2\varepsilon_{xy} = 0 \\ u_{,z} + w_{,x} = 2\varepsilon_{xz} = 0 \\ v_{,z} + w_{,y} = 2\varepsilon_{yz} = 0 \end{array} \right.$$

By integrating the first group of the above differential equations we find

$$\left\{ \begin{array}{l} u = -\nu\kappa yx + \alpha(y, z) \\ v = -\nu\kappa \frac{y^2}{2} + \beta(x, z, y) \\ w = \kappa yz + \gamma(x, y, z) \end{array} \right.$$

that replaced into the second group of differential equations yield

$$\left\{ \begin{array}{l} -\nu\kappa x + \alpha(y, z)_{,y} + \beta(x, z)_{,x} = 0 \\ \alpha(y, z)_{,z} + \gamma(x, y)_{,x} = 0 \\ \beta(x, z)_{,z} + \kappa z + \gamma(x, y)_{,y} = 0 \end{array} \right.$$

The first of the above equations can be derived with respect to y and then to x ; the second with respect to z and then to x ; finally the third with respect to z , then to y . So we obtain

$$\alpha(y, z)_{,yy} = 0 \quad (8.125)$$

$$-\nu\kappa + \beta(x, z)_{,xx} = 0 \quad (8.126)$$

$$\alpha(y, x)_{,zz} = 0 \quad (8.127)$$

$$\gamma(x, y)_{,xx} = 0 \quad (8.128)$$

$$\beta(x, z)_{,zz} + \kappa = 0 \quad (8.129)$$

$$\gamma(x, y)_{,yy} = 0 \quad (8.130)$$

where equations (8.125) and (8.127) yield

$$\alpha(y, z) = A + A'y + A''z + A'''yz \quad (8.131)$$

equations (8.126) and (8.129) yield

$$\beta(x, z) = \nu\kappa\frac{x^2}{2} - \kappa\frac{z^2}{2} + B + B'x + B''z + B'''xz \quad (8.132)$$

while equations (8.128) and (8.130) yield

$$\gamma(x, y) = C + C'x + C''y + C'''xy \quad (8.133)$$

where $A, A', A'', A''', B, B', B'', B''', C, C', C'', C'''$ are unknown constants.

Equations (8.131), (8.132), (8.133) can be replaced into the second group of the initial differential equations to obtain the following system

$$\begin{cases} A' + B' + (A''' + B''')z = 0 \\ A'' + C' + (A''' + C''')y = 0 \\ C'' + B'' + (B''' + C''')x = 0 \end{cases}$$

from which we can derive the solution

$$\begin{cases} A' + B' = 0 \\ A'' + C' = 0 \\ C'' + B'' = 0 \end{cases} \quad \text{and} \quad \begin{cases} A''' + B''' = 0 \\ A''' + C''' = 0 \\ B''' + C''' = 0 \end{cases}$$

where the left-hand group imposes the conditions that $A' = -B'$, $A'' = -C'$ and $C'' = -B''$, while the right-hand group assures that $A''' = B''' = C''' = 0$.

In the light of the latter results and making use of the boundary conditions which inhibit any rigid body motion, see equations (8.1) and (8.3), we finally obtain the components of the displacement field related to a beam under terminal couples

$$u = -\nu\kappa yx \quad (8.134)$$

$$v = -\frac{\kappa}{2} (\nu (y^2 - x^2) + z^2) \quad (8.135)$$

$$w = \kappa yz \quad (8.136)$$

Equations (8.134), (8.135) and (8.136) show that the filaments lying in the *neutral plane*, i.e. $y = 0$, do not suffer any extension. The longitudinal material fibres on the side of $y > 0$ are extended, whereas the filaments on the side $y < 0$ are contracted.

Now we are able to know the strained shape of the beam. Let p and p' be the positions of a point within the beam before and after the deformation, respectively. Hence, the coordinates of such positions are $p \equiv (x_1, x_2, x_3)$ and $p' \equiv (x'_1, x'_2, x'_3)$. By virtue of the above displacement field, we can relate the initial coordinate to the strained one as follows

$$x' = x + u = x - \nu\kappa xy \quad (8.137)$$

$$y' = y + v = y - \frac{\kappa}{2} (z^2 - \nu (x^2 - y^2)) \quad (8.138)$$

$$z' = z + w = z + \kappa yz \quad (8.139)$$

Focusing on the central line $x = y = 0$ the above equations become

$$x' = 0 \quad (8.140)$$

$$y' = -\frac{\kappa}{2} z^2 \quad (8.141)$$

$$z' = z \quad (8.142)$$

where we notice that the points on the central line, after the deformation, go into the points

$$y' = -\frac{\kappa}{2} z'^2 \quad (8.143)$$

that describes a parabola whose radius of curvature is given by the

following formula

$$\frac{1}{R} = \frac{\left| \frac{d^2 y'}{dz'^2} \right|}{\left(1 + \left(\frac{dy'}{dz'} \right)^2 \right)^{3/2}} \quad (8.144)$$

which can be approximated by

$$\frac{1}{R} \simeq \left| \frac{d^2 y'}{dz'^2} \right| \quad (8.145)$$

assuming $\left(\frac{dy'}{dz'} \right)^2$ to be small.

Thus, equation (8.145) leads us to write

$$\frac{1}{R} = |\kappa| = \frac{|M_x|}{EJ_x} \quad (8.146)$$

where the constant EJ_x is termed *modulus of flexural rigidity*.

Points belonging to the central line, i.e. $x = y = 0$, are subjected to the following displacements

$$u = 0 \quad (8.147)$$

$$v = -\frac{\kappa}{2} z^2 \quad (8.148)$$

$$w = 0 \quad (8.149)$$

where in this case v is called the *elastic curve* (or *deflection line*) and describes the plane curve, i.e. a parabola, that the center line assumes when the beam is subjected to pure bending.

8.4.5 Strain energy

We have three equivalent tools to compute the strain energy.

Work done by the external forces. By virtue of the Clapeyron's theorem, see equation (6.15) on page 114, the strain energy is

$$\Phi = \frac{1}{2} \hat{M}_x^l \varphi_x^l \quad (8.150)$$

where \hat{M}_x^l is the only external force and φ_x^l is the rotation in the (y, z) -plane at the point of application of the couple, i.e. at the end $z = l$, with $x = y = 0$. See figure 8.6 on page 158.

The rotation φ_x^l is the first derivative of the displacement v and the sign is assumed through the right-hand rule, so that

$$\varphi_x^l = -v_{,z}|_l = \kappa l = \frac{\hat{M}_x}{EJ_x} l \quad (8.151)$$

hence,

$$\Phi = \frac{1}{2} \frac{(\hat{M}_x^l)^2}{EJ_x} l \quad (8.152)$$

As figure 8.6 shows, both \hat{M}_x^l and φ_x are negative with respect to the Cartesian axes.

Work done by the internal stresses. By recalling the equation 6.5 on chapter 6, we can set

$$\Phi = \frac{1}{2} \int_{\mathcal{V}} \sigma_{ij} \varepsilon_{ij} d\mathcal{V} \quad (8.153)$$

that in the current application becomes

$$\begin{aligned} \Phi &= \frac{1}{2} \int_{\mathcal{V}} \frac{M_x}{J_x} y \kappa y = \frac{l}{2E} \int_{\mathcal{A}} \left(\frac{M_x}{J_x} \right)^2 y^2 d\mathcal{A} \\ &= \frac{l}{2E} \left(\frac{M_x}{J_x} \right)^2 \int_{\mathcal{A}} y^2 d\mathcal{A} = \frac{M_x^2 l}{2EJ_x} \end{aligned} \quad (8.154)$$

where we have just used the tensors (8.120) and (8.121).

Work done by the internal forces. Note that here the sign convention is taken in accordance with that assumed in section 8.1.1, so we have for a generic cross section

$$d\Phi = M_x(z) d\varphi_x = M_x(z) \kappa dz \quad (8.155)$$

hence, by integrating along the entire beam we find the following expression

$$\Phi = \frac{1}{2} \int_0^l M_x(z) \kappa dz = \frac{1}{2} \frac{M_x^2 l}{EJ_x} \quad (8.156)$$

that due to the well known relation for forces transmitted along the beam, it is nothing but equation (8.152).

In equation (8.155) we just used the relationship between the curvature and the rotation of the section, in fact

$$\frac{d\varphi_x}{dz} = \kappa$$

that stems from

$$\varphi_x = -\left.\frac{dv(z)}{dz}\right|_{x=y=0} = \kappa z$$

8.5 Beam under torsional couples

8.5.1 Circular bar

To capture the basic ideas on the torsional problem let us start from the simple case of a circular bar with one end fixed in the plane (x_1, x_2) . At the other end, i.e. $x_3 = l$, suppose there to be applied a torsional couple lying around the x_3 -axis.

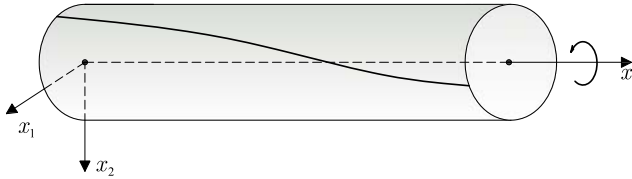

Figure 8.9: Circular bar under torsional couples.

Under the hypothesis that all cross-sections parallel to the plane (x_1, x_2) remain plane, we can intuitively assume that the magnitude of the rotation in a generic section perpendicular to the x_3 -axis depends proportionally solely on the distance from the fixed end, see figure 8.9. Such as

$$\vartheta = kx_3 \tag{8.157}$$

where k is the twist rotation per unit of length, i.e. the relative angular displacement of a pair of cross-sections that are unit distance apart.

Consider now a generic cross-section, as figure 8.10 shows.

The hypothesis of plane sections means that $u_3(p) = 0 \quad \forall p$ of the bar, moreover the circular shape ensures that a generic point p lying on a cross-section can just rotate keeping unaltered the distance r from the origin.

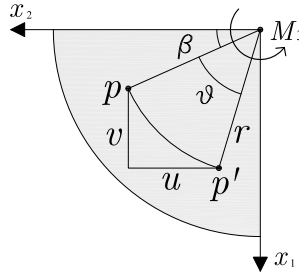

Figure 8.10: Rotation of a point p lying on a generic cross-section of the circular beam.

Hence, with respect to figure 8.10, we can write

$$u_1 = -(r \cos \beta - r \cos (\vartheta + \beta)) \quad (8.158)$$

$$u_2 = r \sin (\beta + \vartheta) - r \sin \beta \quad (8.159)$$

that by means of equation (8.157) and considering that

$$x_1 = r \cos \beta \quad (8.160)$$

$$x_2 = r \sin \beta \quad (8.161)$$

becomes

$$\begin{aligned} u_1 &= r \cos (kx_3 + \beta) - x_1 = \\ &= r (\cos kx_3 \cos \beta - \sin kx_3 \sin \beta) - x_1 \end{aligned} \quad (8.162)$$

$$\begin{aligned} u_2 &= r \sin (\beta + kx_3) - x_2 \\ &= r (\sin kx_3 \cos \beta + \cos kx_3 \sin \beta) - x_2 \end{aligned} \quad (8.163)$$

Next, under the assumption that ϑ is small such that

$$\sin kx_3 \simeq kx_3$$

$$\cos kx_3 \simeq 1$$

we finally get the expressions of the displacements

$$u_1 = -kx_3x_2 \quad (8.164)$$

$$u_2 = kx_3x_1 \quad (8.165)$$

Now, making use of compatibility and constitutive equations governing the linear static problem, see section 4.2, we can obtain

the strain and the stress tensors as follows

$$\varepsilon_{ij} = \frac{1}{2} \begin{pmatrix} 0 & 0 & -kx_2 \\ 0 & 0 & kx_1 \\ -kx_2 & kx_1 & 0 \end{pmatrix} \quad (8.166)$$

$$\sigma_{ij} = \frac{E}{2(1+\nu)} \begin{pmatrix} 0 & 0 & -kx_2 \\ 0 & & kx_1 \\ -kx_2 & kx_1 & 0 \end{pmatrix} \quad (8.167)$$

In order to verify whether the state of stress stemming from the assumption on the displacement field is consistent with the hypotheses on which the Saint Venant's model is founded, we want to be sure that on the lateral surface the external forces vanish. To verify this consider the unit normal vector $\bar{n} = \cos \beta \bar{e}_1 + \sin \beta \bar{e}_2$, and hence the stress state is

$$\sigma_{31}n_1 + \sigma_{32}n_2 = -\frac{1}{2}k \underbrace{(x_2 \cos \beta - x_1 \sin \beta)}_{=0} = 0 \quad (8.168)$$

The above is the proof the solution is right.

On the other hand, the boundary condition at $x_3 = l$, where $\bar{n} = \bar{e}_3$, requires that

$$\sigma_{j3}n_3 = \hat{f}_j \quad (8.169)$$

thus, $\hat{f}_3 = 0$ and by virtue of equations (8.39) and (8.40), the only non vanishing component which produces the above state of stress is

$$\begin{aligned} \hat{M}_3 &= \int_{\mathcal{A}} (\hat{f}_2 x_1 - \hat{f}_1 x_2) d\mathcal{A} = \int_{\mathcal{A}} (\sigma_{23} x_1 - \sigma_{13} x_2) d\mathcal{A} \\ &= \frac{kE}{2(1+\nu)} \int_{\mathcal{A}} (x_1^2 + x_2^2) d\mathcal{A} = \frac{kE}{2(1+\nu)} J_o = k\mu J_o \end{aligned} \quad (8.170)$$

where $\mu = \frac{E}{2(1+\nu)}$, see table 4.1 on page 95, and J_o is the polar moment of inertia for a circular cross-section.

Usually in practical applications the problem presents an inverse formulation, namely, the unknown is the state of the stress and the given datum is the external couple \hat{M}_3 , so we can easily derive

$$\sigma_{13} = -\frac{E}{2(1+\nu)} \frac{\hat{M}_3}{\mu J_o} x_2 = -\frac{\hat{M}_3}{J_o} x_2 \quad (8.171)$$

$$\sigma_{23} = -\frac{E}{2(1+\nu)} \frac{\hat{M}_3}{\mu J_o} x_1 = \frac{\hat{M}_3}{J_o} x_1 \quad (8.172)$$

8.5.2 Cylindrical bar

The hypothesis of plane cross-sections, i.e. $u_3(x_1, x_2) = 0$ is solely allowed for circular cylinder. It can be proved, in fact, that a generic-shaped cross-section under a torsional couple warps. This can be seen, for example, looking at equation (8.168) which would not be satisfied if the unit normal vector were not given with respect to a circular cylinder.

Therefore, to remove the plane sections hypothesis we shall assume the following displacement field

$$u_1 = -kx_3x_2 \quad (8.173)$$

$$u_2 = kx_3x_1 \quad (8.174)$$

$$u_3 = k\varphi(x_1, x_2) \quad (8.175)$$

where φ is an unknown function that must be determined in order to satisfy all the required conditions.

The strain and stress tensors become

$$\varepsilon_{ij} = \frac{k}{2} \begin{pmatrix} 0 & 0 & \varphi_{,1} - x_2 \\ 0 & 0 & \varphi_{,2} + x_1 \\ \varphi_{,1} - x_2 & \varphi_{,2} + x_1 & 0 \end{pmatrix} \quad (8.176)$$

$$\sigma_{ij} = k\mu \begin{pmatrix} 0 & 0 & \varphi_{,1} - x_2 \\ 0 & 0 & \varphi_{,2} + x_1 \\ \varphi_{,1} - x_2 & \varphi_{,2} + x_1 & 0 \end{pmatrix} \quad (8.177)$$

The equilibrium condition on \mathcal{V} leads to

$$\sigma_{13,3} = 0 \quad (8.178)$$

$$\sigma_{23,3} = 0 \quad (8.179)$$

$$\sigma_{31,1} + \sigma_{32,2} = 0 \quad (8.180)$$

hence

$$\sigma_{13} = \sigma_{13}(x_1, x_2) \quad (8.181)$$

$$\sigma_{23} = \sigma_{23}(x_1, x_2) \quad (8.182)$$

$$\varphi_{,11} + \varphi_{,22} = 0 \quad (8.183)$$

Moreover, the boundary condition on the lateral surface imposes

$$\sigma_{31}n_1 + \sigma_{32}n_2 = 0 \quad (8.184)$$

and considering the tensor in (8.177), the above condition becomes

$$\varphi_{,1}n_1 - x_2n_1 + \varphi_{,2}n_2 + x_1n_2 = 0 \Rightarrow \quad (8.185)$$

$$\nabla\varphi \cdot \bar{n} = x_2n_1 - x_1n_2 \quad (8.186)$$

So, let \mathcal{A} and $\partial\mathcal{A}$ be the cross-section of the beam and its boundary, respectively, the torsional problem of a cylindrical beam can be stated as follows

$$\begin{cases} \nabla^2\varphi = 0 & \forall p \in \mathcal{A} \\ \nabla\varphi \cdot \bar{n} = x_2n_1 - x_1n_2 & \forall p \in \partial\mathcal{A} \end{cases} \quad (8.187)$$

where the first equation stems from (8.183) and the boundary condition is provided by (8.186)⁵.

The function $\varphi = \varphi(x_1, x_2)$ is named the *torsion function*.

The problem (8.187) is known as *Neumann's problem* and consists in determining a function which is harmonic in a given region and whose normal derivative is prescribed on the boundary of the region.

Here we will not give the entire analytical solution for *Neumann's problem*, but we shall just give some general statements. The whole problem is solved in [1].

Stress function

Since $\varphi(x_1, x_2)$ is harmonic on \mathcal{A} it is possible to construct the analytic function $\varphi + i\psi$ of complex variable $x_1 + ix_2$, where $\psi(x_1, x_2)$ is the conjugate harmonic function linked to $\varphi(x_1, x_2)$ through the following Cauchy-Riemann equations

$$\varphi_{,1} = \psi_{,2} \quad (8.188)$$

$$\varphi_{,2} = -\psi_{,1} \quad (8.189)$$

The theoretical background of the above statements is beyond the scope of this book, anyhow the reader can find a comprehensive formulation of the torsion problem in [1], [2] and [6].

⁵Note that $\nabla\varphi$ is the gradient of the scalar field φ and the scalar product with the unit vector \bar{n} gives its normal derivative as follows

$$\frac{\partial\varphi}{\partial\bar{n}} = \nabla\varphi \cdot \bar{n} = \text{grad}\varphi \cdot \bar{n} = \frac{\partial\varphi}{x_i}\bar{e}_i \cdot \bar{n} = \varphi_{,i}n_i$$

Suppose that the boundary of the cross-section \mathcal{A} is described by a curve $c : \mathbb{R} \rightarrow \mathbb{R}^2$ such as $s \mapsto (x_1(s), x_2(s))$. We can find the tangent vector \bar{t} to the curve as $\bar{t} = \dot{x}_i \bar{e}_i$, where $\dot{x}_i = \frac{dx_i}{ds}$ and $i = 1, 2$. Hence, the conditions $\bar{n} \cdot \bar{n} = 1$ and $\bar{n} \cdot \bar{t} = 0$ allow us to compute the component of \bar{n} as

$$n_1 = \frac{\dot{x}_2}{\sqrt{\dot{x}_1^2 + \dot{x}_2^2}} \quad (8.190)$$

$$n_2 = -\frac{\dot{x}_1}{\sqrt{\dot{x}_1^2 + \dot{x}_2^2}} \quad (8.191)$$

Replacing the above expressions into the second equation of (8.187) and by expanding the gradient of the torsion function we have

$$(\varphi_{,1} \bar{e}_1 + \varphi_{,2} \bar{e}_2) \cdot \bar{n} = x_2 \frac{\dot{x}_2}{\sqrt{\dot{x}_1^2 + \dot{x}_2^2}} + x_1 \frac{\dot{x}_1}{\sqrt{\dot{x}_1^2 + \dot{x}_2^2}} \quad (8.192)$$

that is

$$\begin{aligned} \varphi_{,1} n_1 + \varphi_{,2} n_2 &= x_2 \frac{\dot{x}_2}{\sqrt{\dot{x}_1^2 + \dot{x}_2^2}} + x_1 \frac{\dot{x}_1}{\sqrt{\dot{x}_1^2 + \dot{x}_2^2}} \Rightarrow \\ \varphi_{,1} \dot{x}_2 - \varphi_{,2} \dot{x}_1 &= x_2 \dot{x}_2 + x_1 \dot{x}_1 \end{aligned} \quad (8.193)$$

and now, making use of equations (8.188) and (8.189), the latter becomes

$$\psi_{,2} \dot{x}_2 + \psi_{,1} \dot{x}_1 = x_2 \dot{x}_2 + x_1 \dot{x}_1 \quad (8.194)$$

then

$$\frac{d}{ds} \psi(x_1, x_2) = \frac{1}{2} \frac{d}{ds} (x_1^2 + x_2^2) \quad (8.195)$$

so that we finally obtain the expression of the function ψ as

$$\psi(x_1, x_2) = \frac{1}{2} (x_1^2 + x_2^2) + \text{const.} \quad (8.196)$$

The arbitrary integration constant does not affect the final solution in terms of stresses and deformations, in fact two different constants will lead to two solutions which differ from one another only by a rigid motion.

Moreover, from Cauchy–Riemann equations (8.188) and (8.189) it follows

$$\psi_{,22} = \varphi_{,12} \quad (8.197)$$

$$\psi_{,11} = -\varphi_{,21} \quad (8.198)$$

and by summing member by member it becomes

$$\nabla^2 \psi = 0 \quad (8.199)$$

Hence, Neumann's problem (8.187) turns into the following Dirichlet's problem

$$\begin{cases} \nabla^2 \psi(x_1, x_2) = 0 & \forall p \in \mathcal{A} \\ \psi(x_1, x_2) = \frac{1}{2}(x_1^2 + x_2^2) & \forall p \in \partial \mathcal{A} \end{cases} \quad (8.200)$$

The function $\psi = \psi(x_1, x_2)$ is named the *stress function*.

Suppose we are able to solve the problem (8.200). The stress tensor then becomes

$$\sigma_{ij} = k\mu \begin{pmatrix} 0 & 0 & \psi_{,2} - x_2 \\ 0 & 0 & -\psi_{,1} + x_1 \\ \psi_{,2} - x_2 & -\psi_{,1} + x_1 & 0 \end{pmatrix} \quad (8.201)$$

thus, by virtue of equations (8.50), (8.56) and (8.41) and by considering the boundary conditions (8.14) and (8.15), we can set

$$\begin{aligned} \hat{M}_3 &= k\mu \int_{\mathcal{A}} (-(\psi_{,2} - x_2)x_2 + (\psi_{,1} + x_1)x_1) d\mathcal{A} \\ &= k\mu \int_{\mathcal{A}} ((x_1^2 + x_2^2) - (\psi_{,1}x_1 + \psi_{,2}x_2)) d\mathcal{A} \\ &= k\mu \left(J_o - \int_{\mathcal{A}} (\psi_{,1}x_1 + \psi_{,2}x_2) d\mathcal{A} \right) \end{aligned} \quad (8.202)$$

that solved for the elastic constant gives

$$k = \frac{\hat{M}_3}{\mu (J_o - \int_{\mathcal{A}} (\psi_{,1}x_1 + \psi_{,2}x_2) d\mathcal{A})} \quad (8.203)$$

Finally the state of stress in a generic cross section x_3 , given an external twisting action, is

$$\sigma_{31} = \frac{\hat{M}_3}{\varrho J_o} (\psi_{,2} - x_2) \quad (8.204)$$

$$\sigma_{32} = -\frac{\hat{M}_3}{\varrho J_o} (\psi_{,1} - x_1) \quad (8.205)$$

where we have defined

$$\varrho = \frac{J_o - \int_{\mathcal{A}} (\psi_{,1}x_1 + \psi_{,2}x_2) d\mathcal{A}}{J_o} \quad (8.206)$$

8.5.3 State of strain

Making use of equation (4.25) and table 4.1 we can write the strain tensor as follows

$$\begin{aligned}
 \varepsilon_{ij} &= \frac{1}{2G} \begin{pmatrix} 0 & 0 & \sigma_{13} \\ 0 & 0 & \sigma_{23} \\ \sigma_{31} & \sigma_{32} & 0 \end{pmatrix} = \\
 &= \frac{M_3}{2G\rho J_o} \begin{pmatrix} 0 & 0 & (\psi_{,2} - x_2) \\ 0 & 0 & -(\psi_{,1} - x_1) \\ (\psi_{,2} - x_2) & -(\psi_{,1} - x_1) & 0 \end{pmatrix} = \\
 &= \frac{M_3}{2G\rho J_o} \begin{pmatrix} 0 & 0 & (\varphi_{,1} - x_2) \\ 0 & 0 & (\varphi_{,2} + x_1) \\ (\varphi_{,1} - x_2) & (\varphi_{,2} + x_1) & 0 \end{pmatrix} \quad (8.207)
 \end{aligned}$$

8.5.4 Displacement field

At the beginning of section 8.5.2 we already introduced the displacement field associated to the torsion problem. However, we implicitly assumed that the rotation axis for the point $p \in \mathcal{A}$ is coincident with the axis x_3 . It is possible to show that this restriction does not affect the validity of the results in terms of stress.

Anyhow, if we repeated an integration procedure similar to that we made to compute the displacement fields in the axial force and pure bending cases, we would find that here the displacement field assumes the following general form

$$u_1 = -kx_3(x_2 - x_2^c) \quad (8.208)$$

$$u_2 = kx_3(x_1 - x_1^c) \quad (8.209)$$

$$u_3 = k\varphi^c(x_1, x_2) \quad (8.210)$$

where $c \equiv (x_1^c, x_2^c)$ is the point about which the rotation occurs and φ^c is the torsion function relative to the rotation point c .

The state of stress consistent with the above displacement components is

$$\varepsilon_{ij} = \frac{k}{2} \begin{pmatrix} 0 & 0 & \varphi_{,1}^c - x_2 + x_2^c \\ 0 & 0 & \varphi_{,2}^c + x_1 - x_1^c \\ \varphi_{,1}^c - x_2 + x_2^c & \varphi_{,2}^c + x_1 - x_1^c & 0 \end{pmatrix} \quad (8.211)$$

and consequently it becomes

$$\sigma_{ij} = Gk \begin{pmatrix} 0 & 0 & \varphi_{,1}^c - x_2 + x_2^c \\ 0 & 0 & \varphi_{,2}^c + x_1 - x_1^c \\ \varphi_{,1}^c - x_2 + x_2^c & \varphi_{,2}^c + x_1 - x_1^c & 0 \end{pmatrix} \quad (8.212)$$

By using the above state of stress instead of that in (8.177) the equilibrium equation (8.180) assures the following condition

$$\nabla^2 \varphi^c = 0 \quad (8.213)$$

Moreover, the boundary condition on the lateral surface implies

$$(\varphi_{,1}^c - x_2 + x_2^c) n_1 + (\varphi_{,2}^c + x_1 - x_1^c) n_2 = 0 \quad (8.214)$$

which can be also written as

$$(\varphi_{,1}^c + x_2^c) n_1 + (\varphi_{,2}^c - x_1^c) n_2 = x_2 n_1 - x_1 n_2 \quad (8.215)$$

which is equivalent to the following expression

$$(\varphi^c + x_2^c x_1 - x_1^c x_2)_{,1} n_1 + (\varphi^c + x_2^c x_1 - x_1^c x_2)_{,2} n_2 = x_2 n_1 - x_1 n_2 \quad (8.216)$$

From the latter it is straightforward to realize that the new torsion function $\hat{\varphi}^c = \varphi^c + x_2^c x_1 - x_1^c x_2$ must satisfy the same condition on $\partial\mathcal{A}$ that φ must satisfy. In addition to that, condition (8.213) guarantees that the Laplacian of $\hat{\varphi}^c$ vanishes. Thus, Neumann's problem assumes the following form

$$\begin{cases} \nabla^2 \hat{\varphi}^c = 0 & \forall p \in \mathcal{A} \\ \nabla \hat{\varphi}^c \cdot \bar{n} = x_2 n_1 - x_1 n_2 & \forall p \in \partial\mathcal{A} \end{cases} \quad (8.217)$$

Due to the uniqueness of Neumann's problem the two torsion functions φ and $\hat{\varphi}^c$ can only differ each other by a constat value, so that

$$\hat{\varphi}^c = \varphi + t \quad (8.218)$$

from which

$$\varphi^c = \varphi - x_2^c x_1 + x_1^c x_2 + t \quad (8.219)$$

If we use the torsion function in (8.219) to compute the state of strain in (8.211), we will immediately find that the state of strain

remains unaltered compared to that obtained by using the torsion function φ . That means that the kinematics related to φ and φ^c only differ one another by a rigid body motion which does not alter the results in term of stress.

By virtue of these remarks we can state that the hypothesis of assuming the torsional axis coincident with x_3 -axis was reasonable and acceptable.

As the last point of this section we want to find the position of the point c called the *center of twist* obtained by the intersection of the *axis of twist*, that is the axis parallel to the generators of a cylinder undergoing torsion - located so that the displacement of any point on the axis is not affected by any rotation, and a generic cross section.

From equations (8.208) to (8.210) it is possible to put zero the mean value of the displacement u_3 and the mean value of the rotations of a given point $p \in \mathcal{A}$ by putting

$$\int_{\mathcal{A}} \varphi^c(x_1, x_2) d\mathcal{A} = 0 \quad (8.220)$$

$$\int_{\mathcal{A}} \varphi^c(x_1, x_2) x_2 d\mathcal{A} = 0 \quad (8.221)$$

$$\int_{\mathcal{A}} \varphi^c(x_1, x_2) x_1 d\mathcal{A} = 0 \quad (8.222)$$

which, making use of equation (8.219), give

$$t = 0 \quad (8.223)$$

$$\int_{\mathcal{A}} \varphi(x_1, x_2) x_2 d\mathcal{A} + x_1^c J_x = 0 \quad (8.224)$$

$$\int_{\mathcal{A}} \varphi(x_1, x_2) x_1 d\mathcal{A} - x_2^c J_y = 0 \quad (8.225)$$

and finally

$$x_1^c = -\frac{1}{J_x} \int_{\mathcal{A}} \varphi(x_1, x_2) x_2 d\mathcal{A} \quad (8.226)$$

$$x_2^c = \frac{1}{J_y} \int_{\mathcal{A}} \varphi(x_1, x_2) x_1 d\mathcal{A} \quad (8.227)$$

8.5.5 Strain energy

We can equivalently use three tools to compute the strain energy associated to a beam undergoing torsion:

Work done by the external forces. By virtue of the Clapeyron's theorem, see equation (6.15) on page 114, the strain energy is

$$\Phi = \frac{1}{2} \hat{M}_3^l \vartheta^l \quad (8.228)$$

where \hat{M}_3^l is the only external force and ϑ^l is the rotation in the (x_1, x_2) -plane at the point of application of the torque, i.e. at the end $x_3 = l$.

As already stated, the twist rotation θ per unit length is given in accordance with equation (8.157) as follows

$$\theta = \frac{d\vartheta}{dx_3} = k \quad (8.229)$$

thus, the whole twist rotation all along the beam is readily given by the integral

$$\vartheta^l = \int_l \vartheta dx_3 = \int_l \frac{\hat{M}_3^l}{G \varrho J_o} dx_3 = \frac{\hat{M}_3^l}{G \varrho J_o} l \quad (8.230)$$

and finally

$$\Phi = \frac{1}{2} \frac{\hat{M}_3^l{}^2 l}{G \varrho J_o} \quad (8.231)$$

Work done by the internal stresses. By recalling equation 6.5 on chapter 6, we can set

$$\Phi = \frac{1}{2} \int_{\mathcal{V}} \sigma_{ij} \varepsilon_{ij} d\mathcal{V} \quad (8.232)$$

which in this specific case becomes

$$\begin{aligned} \Phi &= \frac{1}{2} \int_{\mathcal{V}} (\sigma_{31} \varepsilon_{31} + \sigma_{32} \varepsilon_{32}) d\mathcal{A} = \\ &= \frac{1}{2G} \int_{\mathcal{V}} (\sigma_{31}^2 + \sigma_{32}^2) d\mathcal{A} = \\ &= \frac{M_3^2}{2G \varrho^2 J_o^2} \int_{\mathcal{V}} \left((\varphi_{,1} - x_2)^2 + (\varphi_{,2} + x_1)^2 \right) d\mathcal{V} = \\ &= \frac{M_3^2 l}{2G \varrho^2 J_o^2} \int_{\mathcal{A}} (\varphi_{,1}^2 - \varphi_{,1} x_2 + \varphi_{,2}^2 + \varphi_{,2} x_1) d\mathcal{A} + \varrho J_o \end{aligned} \quad (8.233)$$

The above integral can be rewritten taking into account the following identities

$$\varphi_{,1}^2 - \varphi_{,1}x_2 = (\varphi(\varphi_{,1} - x_2))_{,1} - \varphi\varphi_{,11} \quad (8.234)$$

$$\varphi_{,2}^2 + \varphi_{,2}x_1 = (\varphi(\varphi_{,2} + x_1))_{,2} - \varphi\varphi_{,22} \quad (8.235)$$

hence

$$\int_{\mathcal{A}} (\varphi_{,1}^2 - \varphi_{,1}x_2 + \varphi_{,2}^2 + \varphi_{,2}x_1) d\mathcal{A} = \quad (8.236)$$

$$\begin{aligned} \int_{\mathcal{A}} \left((\varphi(\varphi_{,1} - x_2))_{,1} + (\varphi(\varphi_{,2} + x_1))_{,2} \right) d\mathcal{A} + \\ - \int_{\mathcal{A}} \varphi \nabla^2 \varphi d\mathcal{A} \end{aligned} \quad (8.237)$$

Now we can realize that the last integral contains the first condition of Neumann's problem so that on the domain \mathcal{A} it vanishes. Moreover, by using the divergence theorem for the first integral at the second member we obtain

$$\int_{\mathcal{A}} (\varphi_{,1}^2 - \varphi_{,1}x_2 + \varphi_{,2}^2 + \varphi_{,2}x_1) d\mathcal{A} = \quad (8.238)$$

$$\int_{\partial\mathcal{A}} ((\varphi(\varphi_{,1} - x_2)) n_1 + (\varphi(\varphi_{,2} + x_1)) n_2) ds = \quad (8.239)$$

$$\int_{\partial\mathcal{A}} \varphi (\nabla\varphi \cdot \bar{n} - x_1 2n_1 + x_2 2n_2) ds \quad (8.240)$$

The latter integral includes the boundary condition of Neumann's problem that is identically zero.

Finally we have proved that

$$\int_{\mathcal{A}} (\varphi_{,1}^2 - \varphi_{,1}x_2 + \varphi_{,2}^2 + \varphi_{,2}x_1) d\mathcal{A} = 0 \quad (8.241)$$

and so the strain energy can be expressed as follows

$$\Phi = \frac{M_3^2 l}{2G\rho^2 J_o^2} \rho J_o \quad (8.242)$$

where since $\hat{M}_3 = M_3$ we obtain

$$\Phi = \frac{\hat{M}_3^2 l}{2G\rho J_o} \quad (8.243)$$

that is the same result we found through the previous method.

Work done by the internal forces. Note that here the sign convention is taken in accordance with that assumed in section 8.1.1, so for a generic cross section we have

$$d\Phi = \frac{1}{2}M_3d\theta \quad (8.244)$$

and, by integrating along the entire beam, we obtain

$$\Phi = \frac{1}{2} \int_l M_3\theta dx_3 = \frac{1}{2} \frac{\hat{M}_3^2 l}{G\rho J_o} \quad (8.245)$$

8.5.6 Torsion of tubular beams: Bredt's theory

To solve the problem of tubular beams under torsional couples we can make use of an approximate theory that requires just the equilibrium equations. Consider a generic domain \mathcal{A} and a closed curve c within that domain. See figure 8.11.

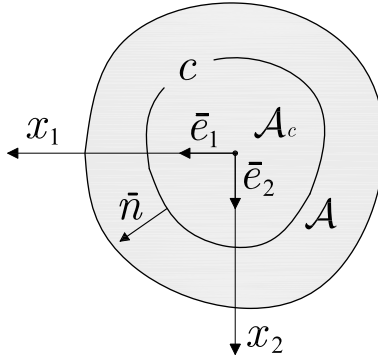

Figure 8.11: The sub-domain \mathcal{A}_c bounded by the curve c .

Let $\bar{\tau}$ be the tangential stress vector lying in the domain \mathcal{A} so that

$$\bar{\tau} = \sigma_{31}\bar{e}_1 + \sigma_{32}\bar{e}_2 \quad (8.246)$$

The equilibrium condition (8.9) leads to the following alternative expression

$$\tau_{i,i} = 0 \quad i = 1, 2 \quad (8.247)$$

that is nothing more than $\text{div } \bar{\tau} = 0$.

Now let $\mathcal{A}_c \subset \mathcal{A}$ be the area included by the curve c , invoking the divergence theorem (1.143), we have

$$\int_{\mathcal{A}_c} \operatorname{div} \bar{\tau} d\mathcal{A}_c = \int_c (\bar{\tau} \cdot \bar{n}) dc = 0 \quad i = 1, 2 \quad (8.248)$$

Equation (8.248) proves that given a generic region \mathcal{A}_c the stress flux through its boundary c always vanishes.

Consider now two curves c_1 and c_2 as shown in figure 8.12.

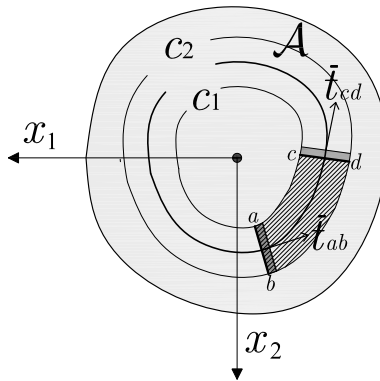

Figure 8.12: Stress flux within a small region included by two closed curves and two generic transversal sections.

Due to the result in (8.248), no stress flux passes through the arches $a - c$ and $b - d$, so for the closed area $abcd$ the flux balance is given as follows

$$\begin{aligned} - \int_{s_{ab}} \bar{\tau} \cdot \bar{t}_{ab} ds + \int_{s_{cd}} \bar{\tau} \cdot \bar{t}_{cd} ds &= 0 \Rightarrow \\ - \int_{s_{ab}} \tau_{ab}(s) ds + \int_{s_{cd}} \tau_{cd}(s) ds &= 0 \end{aligned} \quad (8.249)$$

where \bar{t} is the unit vector normal to the transversal sections $a - b$ and $c - d$, respectively, while s_{ab} and s_{bc} are the lengths of the transverse sections, i.e. the thickness of the tubular section.

Assuming that s is sufficiently thin, we can consider the average value τ^m instead of $\tau = \tau(s)$, so the above integral can turn into

$$\tau_{ab}^m s_{ab} = \tau_{cd}^m s_{cd} \quad (8.250)$$

where

$$\tau_{ab}^m = \frac{1}{s_{ab}} \int_{s_{ab}} \bar{\tau} \cdot \bar{t}_{ab} ds \quad (8.251)$$

Finally, since the sections s_{ab} and s_{bc} have been arbitrarily chosen along the all tubular section, equation (8.250) provides the following result

$$\tau^m s = \text{constant} \quad (8.252)$$

and moreover, if we suppose that the flux lines are parallel to the midline c , i.e $\tau = |\bar{\tau}| = \tau^m$, we have that the tangential resultant for unit length is given as follows

$$dF_\tau = \tau s dc \quad (8.253)$$

Now suppose a generic equilibrium direction is fixed by the angle α as showed in figure 8.13,

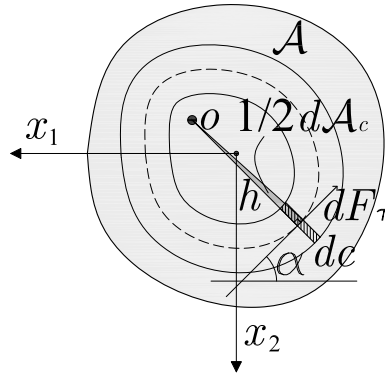

Figure 8.13: Stress resultants.

the resultant force acting on the cross-section has the following expression

$$\oint_c \tau s \cos \alpha dc = \tau s \oint_c \cos \alpha dc = 0 \quad (8.254)$$

Accordingly, the in-plane rotational equilibrium is satisfied by imposing

$$M_3 = \oint_c \tau s h(s) dc = \tau s \oint_c h(s) dc = 2\tau s \mathcal{A}_c \quad (8.255)$$

where o is a generic point with respect to which we compute the moments, \mathcal{A}_c is the area included by the midline c .

Hence, the inverse problem is solved as follows

$$\tau = \frac{M_3}{2s\mathcal{A}_c} \quad (8.256)$$

8.6 Bending and shear

8.6.1 External forces

The external forces acting on the base $x_3 = l$ are

$$\hat{T}_1^l \neq 0, \quad \hat{T}_2^l \neq 0 \quad (8.257)$$

$$\hat{N}^l = \hat{M}_1^l = \hat{M}_2^l = \hat{M}_3^l = 0 \quad (8.258)$$

hence, the equilibrium condition imposes

$$\hat{T}_1^l = \int_{\mathcal{A}} \hat{f}_1^l d\mathcal{A} \neq 0 \quad (8.259)$$

$$\hat{T}_2^l = \int_{\mathcal{A}} \hat{f}_2^l d\mathcal{A} \neq 0 \quad (8.260)$$

$$\hat{N}^l = \int_{\mathcal{A}} \hat{f}_3^l d\mathcal{A} = 0 \quad (8.261)$$

so that

$$\hat{f}_1^l \neq 0 \quad (8.262)$$

$$\hat{f}_2^l \neq 0 \quad (8.263)$$

$$\hat{f}_3^l = 0 \quad (8.264)$$

and the following condition has to be satisfied

$$\hat{M}_3^l = \int_{\mathcal{A}} \left(-\hat{f}_1^l x_2 + \hat{f}_2^l x_1 \right) d\mathcal{A} = 0 \quad (8.265)$$

On the other hand, the rigid body equilibrium requires that on the base $x_3 = 0$ the external forces acting are

$$\hat{T}_1^0 = -\hat{T}_1^l, \quad \hat{T}_2^0 = -\hat{T}_2^l \quad (8.266)$$

$$\hat{M}_1^0 = \hat{T}_2^l l, \quad \hat{M}_2^0 = -\hat{T}_1^l l \quad (8.267)$$

$$\hat{N}^0 = \hat{N}^l = 0 \quad (8.268)$$

$$\hat{M}_3^0 = -\hat{M}_3^l = 0 \quad (8.269)$$

Consequently the boundary conditions are

$$\hat{f}_1^0 \neq 0 \quad (8.270)$$

$$\hat{f}_2^0 \neq 0 \quad (8.271)$$

$$\hat{f}_3^0 \neq 0 \quad (8.272)$$

8.6.2 State of normal stress

Let us start from a generic form of σ_{33} as stated in equation (8.32). The condition $\sigma_{33} = 0$ at $x_3 = l$ allows us to reduce the six unknowns to three, in fact we have

$$\sigma_{33}|_{x_3=l} = a + bx_1 + cx_2 + (d + ex_1 + fx_2)l = 0 \quad (8.273)$$

$$\sigma_{33}|_{x_3=0} = a + bx_1 + cx_2 = \hat{f}_3^0 \quad (8.274)$$

and the following expression could be a solution

$$\sigma_{33} = (\alpha + \beta x_1 + \gamma x_2)(l - x_3) \quad (8.275)$$

where α, β, γ are the unknown constants.

To compute the above constants we shall impose the equilibrium condition on the base $x_3 = 0$, so we have

$$\hat{N}^0 = - \int_{\mathcal{A}} \sigma_{33} d\mathcal{A} = - \int_{\mathcal{A}} (\alpha + \beta x_1 + \gamma x_2) l d\mathcal{A} = 0 \quad (8.276)$$

$$\hat{M}_1^0 = - \int_{\mathcal{A}} \sigma_{33} x_2 d\mathcal{A} = - \int_{\mathcal{A}} (\alpha + \beta x_1 + \gamma x_2) l x_2 d\mathcal{A} = \hat{T}_2^l \quad (8.277)$$

$$\hat{M}_2^0 = - \int_{\mathcal{A}} \sigma_{33} x_1 d\mathcal{A} = - \int_{\mathcal{A}} (\alpha + \beta x_1 + \gamma x_2) l x_1 d\mathcal{A} = -\hat{T}_1^l \quad (8.278)$$

where we have made use of equation (8.275).

Equations (8.276), (8.277), (8.278) represent a linear system in the unknowns α, β, γ , that is

$$\begin{cases} \alpha l \mathcal{A} & = & 0 \\ -\beta J_{12} - \gamma J_2 & = & \hat{T}_2^l \\ -\beta J_1 - \gamma J_{12} & = & -\hat{T}_1^l \end{cases} \quad (8.279)$$

In the same way as made for the pure flexure case we may write the above system with respect to the axes of inertia (ξ, η) , so it becomes

$$\begin{pmatrix} 0 & -J_\eta \\ J_\xi & 0 \end{pmatrix} \begin{pmatrix} \gamma \\ \beta \end{pmatrix} = \begin{pmatrix} \hat{T}_\eta^l \\ -\hat{T}_\xi^l \end{pmatrix}$$

$$\beta = -\frac{\hat{T}_\xi^l}{J_\xi} \quad (8.280)$$

$$\gamma = -\frac{\hat{T}_\eta^l}{J_\eta} \quad (8.281)$$

and accordingly the stress produced by the couples is

$$\sigma_{33} = -\left(\frac{\hat{T}_\eta^l}{J_\eta} \xi + \frac{\hat{T}_\xi^l}{J_\xi} \eta \right) (l - x_3) \quad (8.282)$$

Taking into account that the bending moment due to the external forces \hat{T}_ξ and \hat{T}_η propagates along the beam as

$$M_\xi = -\hat{T}_\eta^l (l - x_3) \quad (8.283)$$

$$M_\eta = \hat{T}_\xi^l (l - x_3) \quad (8.284)$$

then, the state of stress normal to a generic cross-section assumes the following expression

$$\sigma_{33} = \frac{M_\xi}{J_\xi} \eta - \frac{M_\eta}{J_\eta} \xi \quad (8.285)$$

where we want to remark that the above expression is similar to equation (8.106), but here M_ξ and M_η are not constant, they depend on the cross-section position, i.e. x_3 .

A simpler solution is obtained by introducing the coordinate system (x, y, z) where x is the neutral axis $\mathbf{n} - \mathbf{n}$, y is the flexural axis $\mathbf{f} - \mathbf{f}$

$$\sigma_{33} = \frac{M_x}{J_x} y = -\frac{\hat{T}_y^l (l - z)}{J_x} y \quad (8.286)$$

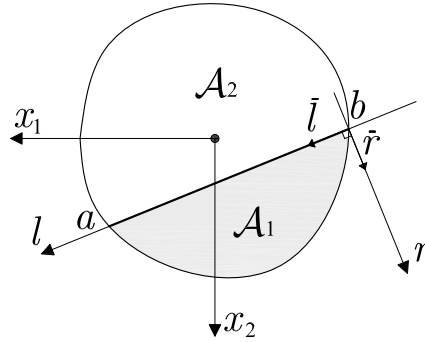

Figure 8.14: Shear regions.

8.6.3 State of tangential stress: Jourawski's theory

This section is devoted to an approximate shear theory widely applied in practical cases, it is named Jourawski's shear theory.

Consider a generic cross-section of the beam and suppose to split the area \mathcal{A} in two regions \mathcal{A}_1 and \mathcal{A}_2 . See figure 8.14.

We call l the line that divides the section and r the line normal to l . So it is possible to define a local coordinate system assuming $\{l, r\}$ as Cartesian axes. Hence, \bar{l} and \bar{r} form a two-dimensional basis for the system. Let us consider now a three-dimensional portion of the solid included by two surfaces normal to the x_3 axis, at x_3 and $x_3 + dx_3$, respectively, and the plane π_l . See figure 8.15.

Let $\bar{\tau}_3$ be the tangential stress vector lying in the domain \mathcal{A}_1 so that

$$\bar{\tau} = \sigma_{31}\bar{e}_1 + \sigma_{32}\bar{e}_2 \quad (8.287)$$

The stress flux τ_{3r} passing through the line l is given by the scalar product $\bar{\tau}_3 \cdot \bar{r}$, so that the equilibrium condition of the portion \mathcal{V}_1 is

$$-\int_{\mathcal{A}_1} \sigma_{33} d\mathcal{A}_1 + \int_{\mathcal{A}_1} (\sigma_{33} + \sigma_{33,3}) d\mathcal{A}_1 - \int_{l_{ab}} \tau_{r3} dl = 0 \quad (8.288)$$

then

$$\int_{\mathcal{A}_1} \sigma_{33,3} d\mathcal{A}_1 = \int_{l_{ab}} \tau_{r3} dl \quad (8.289)$$

By using the result in (8.286), the latter equation becomes

$$\frac{\hat{T}_y^l}{J_x} \int_{\mathcal{A}_1} y d\mathcal{A}_1 = \int_{l_{ab}} \tau_{r3} dl \quad (8.290)$$

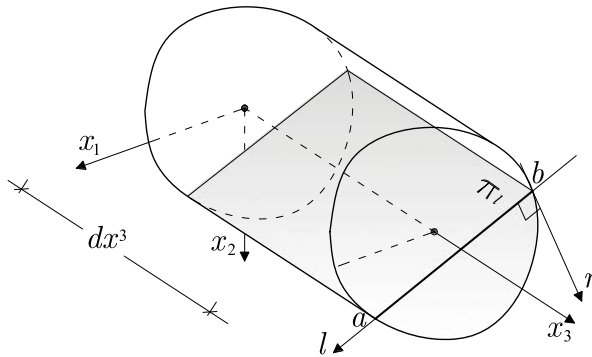

Figure 8.15: Beam splitting.

Invoking the mean value theorem, we can set the mean stress τ_{r3}^m along the chord l_{ab} as follows

$$\tau_{r3}^m = \frac{1}{l_{ab}} \int_a^b \tau_{r3} dl \quad (8.291)$$

hence we can state that

$$\begin{aligned} \frac{T_y}{J_x} \int_{\mathcal{A}_1} y d\mathcal{A}_1 &= l_{ab} \tau_{r3}^m \Rightarrow \\ \tau_{r3}^m &= \frac{T_y S_{1x}}{J_x l_{ab}} \end{aligned} \quad (8.292)$$

where $T_y = \hat{T}_y^l$ is the shear force acting along the flexural axis; S_{1x} is the static moment of the area \mathcal{A}_1 with respect to the neutral axis; J_x is the entire cross-section moment of inertia with respect to the neutral axis; l_{ab} is the length of the chord.

Equation (8.292) allows us to compute the mean value of the shear stress acting in the \bar{r} direction normal to a generic chord which splits the section in two portions. Jourawski's theory does not depend on the chord position, it is just required that it separates the cross-section in two parts. Moreover, the chord l_{ab} can be a polygonal line and in the case of tubular section it can cut the section more than once.

The practical application of Jourawski's theory is allowed when the chord length is sufficiently small, so under this condition we

can approximate the mean stress with the actual one without loss of accuracy

$$\tau_{r3}^m \simeq \tau_{r3} \quad (8.293)$$

Furthermore, equation (8.5) on page 145 ensures the no-stress condition along the normal to the lateral surface of the cylinder. So in points a and b , see figure 8.14, the stress τ_{r3} must be tangent to the boundary lines of the cross-section. Considering the above condition on the smallness of l_{ab} , if the boundaries and the chord are orthogonal we can write that $\bar{\tau} = \tau_{3r}\bar{r}$, i.e. there are no other components of the shear stress vector except the one along the r -axis. More details will be given later on symmetrical sections.

As a concluding remark we want to show that the shear stress τ_{3r} does not depend on which portion of the section we choose. In fact, if we consider the flux towards the area \mathcal{A}_2 we have

$$\bar{\tau} \cdot (-\bar{r}) = -\tau_{3r} \quad (8.294)$$

moreover, we know that

$$S_{1x} + S_{2x} = 0 \Rightarrow S_{1x} = -S_{2x} \quad (8.295)$$

so the shear stress equals

$$\begin{aligned} -\tau_{r3}^m &= -\frac{T_y S_{2x}}{J_x l_{ab}} \Rightarrow \\ \tau_{r3}^m &= \frac{T_y S_{1x}}{J_x l_{ab}} = \frac{T_y S_{2x}}{J_x l_{ab}} \end{aligned} \quad (8.296)$$

8.6.4 Tangential stress for symmetrical cross-sections

Consider now a symmetrical cross-section under a shear force passing along the axis of symmetry that coincides with the flexural axis. See figure 8.16.

Suppose that the section width is sufficiently small to consider valid Jourawski's theory, then the shear stress along the chord l_{ab} is given by the following expression

$$\tau_{3y} = \frac{T_y S_{1x}}{J_x l_{ab}} \quad (8.297)$$

On the left side of figure 8.16 is showed the distribution of the static moment related to the portion \mathcal{A}_1 computed with respect to

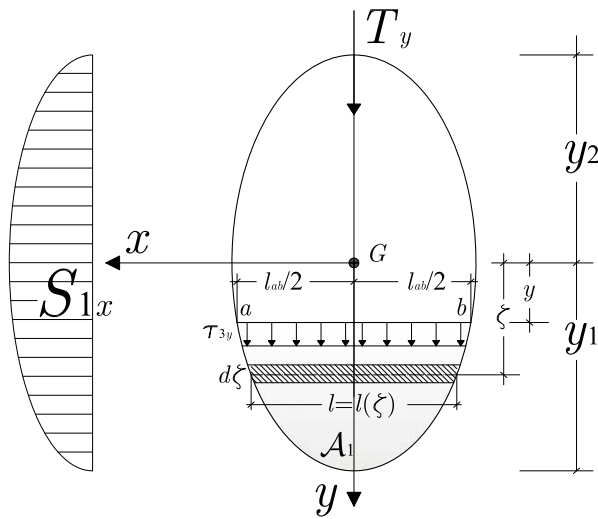

Figure 8.16: Symmetrical cross-section.

the x -axis, namely

$$S_{1x}(y) = \int_{\mathcal{A}_1} y d\mathcal{A}_1 = \int_y^{y_1} \zeta l(\zeta) d\zeta \quad (8.298)$$

Often in the practical application it is required to compute the maximum shear stress, so it easy to observe that since

$$\tau_{3y} = \tau_{3y}(y) \quad (8.299)$$

then the maximum value is found by imposing the following condition

$$\tau_{3y,y} = 0$$

which implies

$$\left(\frac{S_x}{l} \right)_{,y} = \frac{1}{l} \frac{dS_{1x}}{dy} - \frac{S_{1x}}{l^2} \frac{dl}{dy} = 0 \quad (8.300)$$

Moreover, equation (8.298) assures that $dS_{1x} = lyd\zeta$, therefore the latter equation becomes

$$ly - \frac{S_{1x}}{l} \frac{dl}{dy} = 0 \quad (8.301)$$

that is

$$y = \frac{S_{1x}^2}{l} \frac{dl}{dy} \quad (8.302)$$

This result implies that along the x -axis, i.e. when $y = 0$, the chord l has either an extreme value or is constant and that is sufficient to assure the condition expressed by equation (8.300). In fact we have

$$\frac{dl}{dy} = 0, \quad \text{if } y = 0 \quad (8.303)$$

therefore

$$(\tau_{3y})_{\max} = \frac{T_y S_{1x}}{J_x l_0} \quad (8.304)$$

where l_0 denotes the length of the chord at $y = 0$.

Now we can split the moment of inertia into the sum $J_x = J_{1x} + J_{2x} = S_x h_1 + S_x h_2$, where h_1 and h_2 are the distances between the centers of area C_1 and C_2 of the two portions separated by means of the chord l_0 and the center of the whole section G , respectively. Hence, if $h_1 + h_2 = h_0$, we can write

$$J_x = S_x h_0 \quad (8.305)$$

which leads us to write

$$(\tau_{3y})_{\max} = \tau_{3y}(0) = \frac{T_y}{l_0 h_0} \quad (8.306)$$

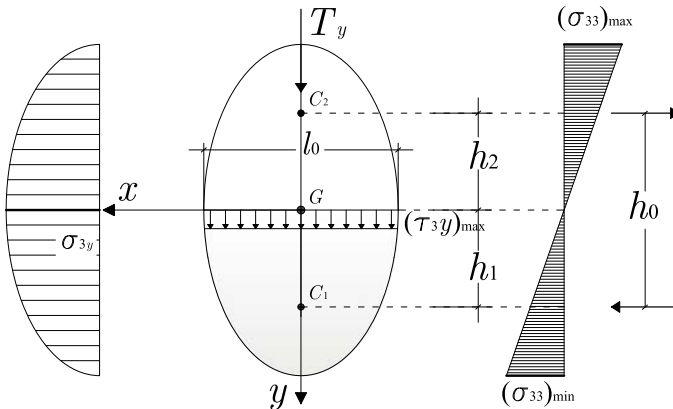

Figure 8.17: Maximum shear stress for symmetrical cross-section.

As showed in figure 8.17 the centers C_1 and C_2 coincide with the points of applications of the resultant forces produced by the normal state of stress $\sigma_{33} = \sigma_{33}(y)$.

As a concluding remark of this section we want to show that by using the equilibrium equation in (8.9), which has not been used yet, it is possible to know the distribution of the stress along the x -axis. To this end let us write equation (8.9) with respect to the neutral and symmetry axes, respectively

$$\tau_{3x,x} + \tau_{3y,y} + \sigma_{33,3} = 0 \quad (8.307)$$

and the derivative with respect of x allows us to write

$$\tau_{3x,xx} = 0 \quad (8.308)$$

because equations (8.297) and (8.286) tell us that the first two terms of equation (8.307) vanish, so that

$$\tau_{3x} = \alpha x + \beta \quad (8.309)$$

where α and β are two integration constants that must be found by means of the boundary conditions. The stress boundary conditions are known due to equation (8.5) that ensures the tangency condition of the shear stress vector $\bar{\tau}_3$ to the boundary of the cross-section. See figure 8.18.

It should also be noted, as made clear in figure 8.18, that for any point on the chord l the shear stress vector is always lying on the line towards the point O that belongs to the symmetrical axis and is determined by the intersection of two tangent lines passing through a and b .

Hence it is very easy to prove that the shear stress component along the neutral axis x is given by

$$\tau_{3x} = -\frac{2 \tan \alpha}{l_{ab}} \tau_{3y} x \quad (8.310)$$

where we have imposed the conditions

$$\tau_{3x} \left(\frac{l_{ab}}{2} \right) = -\tau_{3y} \tan \alpha \quad (8.311)$$

$$\tau_{3x} \left(-\frac{l_{ab}}{2} \right) = \tau_{3y} \tan \alpha \quad (8.312)$$

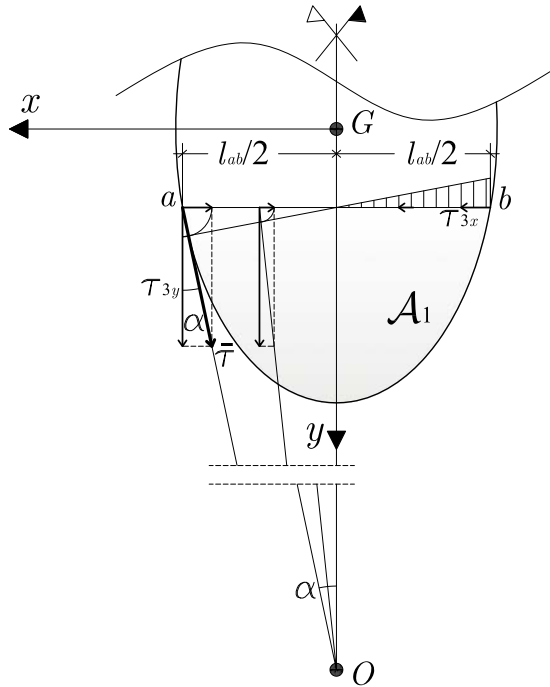

Figure 8.18: σ_{3x} distribution for symmetrical cross-sections.

Finally, for a generic point within a symmetric cross-section we know the whole state of shear stress

$$\tau_{3y} = \frac{T_y S_x}{J_x l} \quad (8.313)$$

$$\tau_{3x} = -\frac{2 \tan \alpha}{l} \tau_{3y} x \quad (8.314)$$

where l is a generic chord that splits the section.

8.6.5 State of strain

With the same approach followed for the state of stress, the strained configuration of a beam under terminal forces, which produce shear and bending forces along the whole beam, will be investigated separately. Namely, by using the superposition principle, the deformation concerning a generic cross-section will be obtained as sum of the contribution due to the bending state of strain and the contribution due to the shear state of strain.

It must be observed that in this section we shall investigate only the global strain of the cross-section assumed remaining plane, instead of the local strain tensor ε_{ij} .

Bending strain

Likewise the pure bending case analyzed in section 8.4.3 for a generic cross-section we have

$$\varphi_x = \kappa z = \frac{M_x}{EJ_x} z \quad (8.315)$$

where φ_x is the rotation in the (y, z) -plane at the point of application of the internal couple $M_x = -\hat{T}_y^l (l - z)$ that is the bending moment produced by the external force \hat{T}_y^l . The key difference with respect to the pure bending case is that here the rotation φ_x is no longer constant, but varies linearly with z .

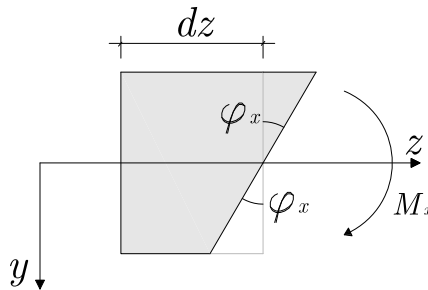

Figure 8.19: Bending strain for an infinitesimal beam segment.

Let us define now the rotation per unit of length as follows

$$\kappa = \frac{d\varphi_x}{dz} = \frac{M_x}{EJ_x} = -\frac{\hat{T}_y^l (l - z)}{EJ_x} \quad (8.316)$$

Shear strain

The natural consequence of the shear state of stress discussed before is the shearing strain that causes a sliding of the cross-sections that, initially plane, become warped. See figure 8.20.

We shall focus our attention only on the sliding of the cross-section in order to describe its global deformation. Furthermore,

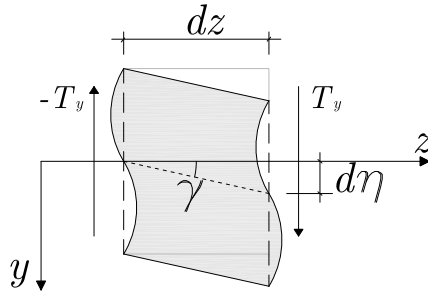

Figure 8.20: Shear strain for an infinitesimal beam segment.

we shall also show that the contribute of the sliding to the *deflection line* defined as $v = v(z)|_{x=y=0}$ will be sometimes neglected, sometimes not, depending on the geometrical features of the cross-section.

With respect to figure 8.20 we can set

$$d\eta = \gamma dz \quad (8.317)$$

where, chosen two cross-sections dz apart from each other, $d\eta$ represents the strain due to the shear force. We can easily write the shear strain energy⁶ Φ_s as follows

$$\Phi_s = \frac{1}{2} \int_{\mathcal{V}} (2\tau_{zy}\varepsilon_{zy} + 2\tau_{zx}\varepsilon_{zx}) d\mathcal{V} \quad (8.318)$$

so that for a small beam's portion dz , considering the constitutive law, the above energy becomes

$$d\Phi_s = \frac{dz}{2G} \int_{\mathcal{A}} (\tau_{zy}^2 + \tau_{zx}^2) d\mathcal{A} \quad (8.319)$$

which, recalling equations (8.313) and (8.314), turns into

$$d\Phi_s = \frac{dz}{2G} \int_{\mathcal{A}} \tau_{zy}^2 \left(1 + \frac{4 \tan^2 \alpha}{l^2} x^2 \right) d\mathcal{A} \quad (8.320)$$

The shear stress τ_{zy} depends only on y , so that the above integral

⁶Notice that the subscript s denotes the portion of the energy associated to the shear force alone.

can be rewritten as

$$\begin{aligned}
 d\Phi_s &= \frac{dz}{2G} \int_{y_2}^{y_1} \tau_{zy}^2 dy \int_{-l/2}^{l/2} \left(1 + \frac{4 \tan^2 \alpha}{l^2} x^2 \right) dx = \\
 &= \frac{dz}{2G} \int_{y_2}^{y_1} \tau_{zy}^2 dy \left[\left(x + \frac{4 \tan^2 \alpha}{3l^2} x^3 \right) \right]_{-l/2}^{l/2} = \\
 &= \frac{T_y^2 dz}{2G J_x^2} \int_{y_2}^{y_1} \frac{S_x^2}{l} \left(1 + \frac{\tan^2 \alpha}{3} \right)
 \end{aligned} \tag{8.321}$$

Finally, Clapeyron's theorem allows us to equilibrate the strain energy computed by means of the internal stresses with half of the work done by the external forces

$$d\Phi_s = \frac{1}{2} T_y d\eta \tag{8.322}$$

so that equation (8.322) equals equation (8.321) as follows

$$\begin{aligned}
 d\Phi_s = \frac{1}{2} T_y d\eta &= \frac{T_y^2 dz}{2G J_x^2} \int_{y_2}^{y_1} \frac{S_x^2}{l} \left(1 + \frac{\tan^2 \alpha}{3} \right) dy \Rightarrow \\
 d\eta &= \frac{T_y}{G} \frac{dz}{J_x^2} \int_{y_2}^{y_1} \frac{S_x^2}{l} \left(1 + \frac{\tan^2 \alpha}{3} \right) dy
 \end{aligned} \tag{8.323}$$

and finally the relevant result is that the deflection of an infinitesimal portion of beam due only to the shear force is given by the following expression

$$d\eta = \frac{\chi_\gamma T_y}{G \mathcal{A}} dz \tag{8.324}$$

where we have defined the *shear factor* χ_γ as follows

$$\chi_\gamma = \frac{\mathcal{A}}{J_x^2} \int_{y_2}^{y_1} \frac{S_x^2}{l} \left(1 + \frac{\tan^2 \alpha}{3} \right) dy \tag{8.325}$$

Equation (8.324) leads in the end to write the sliding angle γ as

$$\gamma = \frac{d\eta}{dz} = \frac{\chi_\gamma T_y}{G \mathcal{A}} \tag{8.326}$$

8.6.6 Total strain energy

Now we are able to compute the total strain energy for a beam subjected to shear and bending forces. Keeping unaltered the hypotheses of symmetrical cross-section with respect to the y -axis as symmetry line and x -axis as neutral axis, we can state that the total strain energy is given by two terms

$$\Phi = \Phi_b + \Phi_s \quad (8.327)$$

where Φ_b is the strain energy concerning the bending state of strain and Φ_s the energy related to the shear state of strain. See figures 8.21(a) and 8.21(b), respectively.

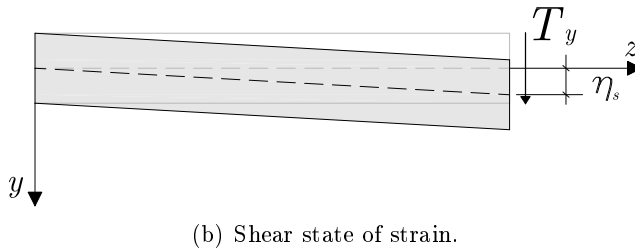
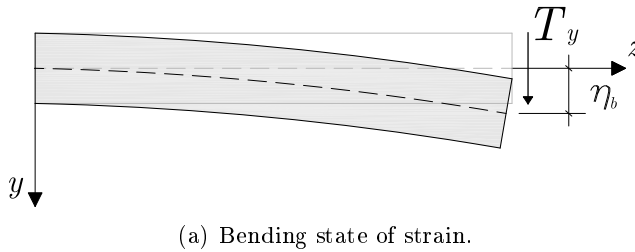

Figure 8.21: Two contributions to the state of strain for a beam subjected to terminal forces.

Clapeyron's theorem allows us to write easily both the contributions as

$$\Phi_b = \frac{1}{2} T_y \eta_b \quad (8.328)$$

$$\Phi_s = \frac{1}{2} T_y \eta_s \quad (8.329)$$

where the first contribution is easily obtained replacing the constitutive relationship for the normal stress, see equation (8.19) on page 147, and making use of equation (8.286) such as

$$\begin{aligned}\Phi_b &= \frac{1}{2} \int_{\mathcal{V}} \sigma_{zz} \frac{\sigma_{zz}}{E} d\mathcal{V} = \frac{1}{2} \int_{\mathcal{V}} \frac{T_y^2 (l-z)^2}{E J_x^2} y^2 d\mathcal{V} = \\ &= \frac{1}{2} \frac{T_y^2}{E J_x^2} \underbrace{\int_{\mathcal{A}} y^2 d\mathcal{A}}_{=J_x} \int_l (l-z)^2 dz = \frac{T_y^2 l^3}{6 E J_x}\end{aligned}\quad (8.330)$$

To compute the shear strain energy we recall the expression obtained in the preceding section, see equation (8.324), and we use Clapeyron's theorem

$$\Phi_s = \frac{1}{2} T_y \eta_s = \frac{1}{2} T_y \int_l d\eta_s = \frac{1}{2} T_y \frac{\chi_\gamma T_y}{G A} \int_l dz = \frac{1}{2} \frac{\chi_\gamma T_y^2 l}{G A}\quad (8.331)$$

In the end, the strain energy for the linear elastic beam with a symmetrical cross-section subjected to forces at its ends is

$$\Phi = \frac{T_y^2 l^3}{6 E J_x} + \frac{1}{2} \frac{\chi_\gamma T_y^2 l}{G A}\quad (8.332)$$

and consequently the total deflection at the point of application of the external force, in the direction of the force itself, is

$$T_y \eta = T_y (\eta_b + \eta_s) = 2\Phi = \frac{T_y^2 l^3}{3 E J_x} + \frac{\chi_\gamma T_y^2 l}{G A}\quad (8.333)$$

hence

$$\eta = \eta_b + \eta_s = \frac{T_y l^3}{3 E J_x} + \frac{\chi_\gamma T_y l}{G A}\quad (8.334)$$

8.6.7 Rectangular cross-section

Consider a rectangular cross-section $\mathcal{A} = wh$ where w is the width and h is the height. The cross-section area is assumed to be constant, so that we can easily compute the moment of inertia and the static moment with respect to axes $x - y$ assumed as above to be the neutral and flexural axes, respectively.

$$J_x = \frac{wh^3}{12}\quad (8.335)$$

$$S_x = \frac{w}{2} \left(\frac{h^2}{4} - y^2 \right)\quad (8.336)$$

Moreover, the tangential stress $\tau_{3x} = 0$, so that in this case the stress state is completely defined by

$$\sigma_{33} = -\frac{T_y(l-z)}{EJ_x} \quad (8.337)$$

$$\tau_{3y} = \frac{T_y S_x}{wJ_x} = \frac{3T_y}{2wh} \left(1 - 4\frac{y^2}{h^2}\right) \quad (8.338)$$

The *shear factor* χ_γ can be directly computed by using the expression (8.325) which yields $\chi_\gamma = \frac{6}{5}$.

PART III
Appendix

Appendix A

Applications of the shell theory

This appendix contains some applications of the shell theory discussed at the ends of the first four chapters. For all cases presented the external load ensures a membrane state of stress and consequently some analytical closed-form solutions can be reached.

A.1 Spherical dome

A.1.1 Geometry

The spherical dome is a shell modeled on a portion of sphere having radius r and aperture $\pi/2$ (hemisphere). Given the geometry, the first step is to identify the simplest coordinate system able to describe such a geometry. Of course it is a spherical system, see section 1.4.3 on page 19.

Let X be the spherical coordinate system¹ so that

$$X = (\varphi, \vartheta, \rho) : E \rightarrow \mathbb{R}^3 \quad (\text{A.1})$$

where E is the affine Euclidean space in which the surface Q is embedded. The origin of the system is located at the center of the hemisphere. With respect to a Cartesian coordinate system, the following transformations hold

$$x = \rho \sin \varphi \sin \vartheta \quad (\text{A.2})$$

$$y = \rho \sin \varphi \cos \vartheta \quad (\text{A.3})$$

$$z = \rho \cos \varphi \quad (\text{A.4})$$

The adapted coordinate system X induces the surface coordinate system X^\dagger by imposing the constraint $\rho = r$. Therefore, the

¹Note that this coordinate system has been slightly changed compared with that depicted in figure 1.3.

induced coordinate system is

$$X^\dagger = (\varphi^\dagger, \vartheta^\dagger) : Q \rightarrow \mathbb{R}^2 \quad (\text{A.5})$$

The covariant and contravariant expressions of the metric tensor g^\dagger associated with the induced coordinate system are, respectively

$$g = r^2 \underline{\mathbf{d}}^\varphi \otimes \underline{\mathbf{d}}^\varphi + r^2 \sin^2 \varphi \underline{\mathbf{d}}^\vartheta \otimes \underline{\mathbf{d}}^\vartheta \quad (\text{A.6})$$

$$\bar{g} = \frac{1}{r^2} \bar{\partial}_\varphi \otimes \bar{\partial}_\varphi + \frac{1}{r^2 \sin^2 \varphi} \bar{\partial}_\vartheta \otimes \bar{\partial}_\vartheta \quad (\text{A.7})$$

The nonvanishing Christoffel symbols on Q are

$$\begin{aligned} \Gamma_{\vartheta\vartheta}^\varphi &= -\sin \varphi \cos \varphi \\ \Gamma_{\varphi\vartheta}^\vartheta &= \Gamma_{\vartheta\varphi}^\vartheta = \frac{\cos \varphi}{\sin \varphi} \end{aligned}$$

The unit normal vector of Q is

$$\bar{\mathbf{n}} = \bar{\partial}_\rho \quad (\text{A.8})$$

The Weingarten tensor and the second fundamental form for Q are, respectively

$$L = \frac{1}{r} (\underline{\mathbf{d}}^\varphi \otimes \bar{\partial}_\varphi + \underline{\mathbf{d}}^\vartheta \otimes \bar{\partial}_\vartheta) \quad (\text{A.9})$$

$$L = r (\underline{\mathbf{d}}^\varphi \otimes \underline{\mathbf{d}}^\varphi + \sin^2 \varphi \underline{\mathbf{d}}^\vartheta \otimes \underline{\mathbf{d}}^\vartheta) \quad (\text{A.10})$$

A.1.2 Displacements and strains

To compute the in-plane state of stress only the stretching strain tensor α is required

$$\alpha_{\varphi\varphi} = v_{\varphi,\varphi} + r v^\xi \quad (\text{A.11})$$

$$\alpha_{\theta\theta} = v_{\vartheta,\vartheta} + \sin \varphi \cos \varphi + r \sin^2 \varphi v^\xi \quad (\text{A.12})$$

$$\alpha_{\vartheta\varphi} = \frac{1}{2} (v_{\varphi,\theta} + v_{\vartheta,\phi}) - \frac{\cos}{\sin} v_{\vartheta} \quad (\text{A.13})$$

A.1.3 Equilibrium and constitutive law

The equilibrium equations (3.149) to (3.151) for a spherical shell assume the following form

$$N^{\varphi\varphi}_{,\varphi} + \cot \varphi N^{\varphi\varphi} - \sin \varphi \cos \varphi N^{\vartheta\vartheta} + q^\varphi = 0 \quad (\text{A.14})$$

$$-N^{\varphi\varphi} r - N^{\vartheta\vartheta} r \sin^2 \varphi + q^\xi = 0 \quad (\text{A.15})$$

$$N^{\vartheta\varphi}_{,\varphi} + 3 \cot \varphi N^{\vartheta\varphi} + q^\vartheta = 0 \quad (\text{A.16})$$

The constitutive equations are

$$\begin{aligned} N^{\varphi\varphi} = & D \frac{1}{r^4} \left(v_{\varphi,\varphi} + r v^\xi \right) + \\ & + D \left(\frac{\nu}{r^4 \sin^2 \varphi} (v_{\vartheta,\vartheta} + \sin \varphi \cos \varphi v_\varphi + r \sin^2 \varphi v^\xi) \right) \end{aligned} \quad (\text{A.17})$$

$$\begin{aligned} N^{\vartheta\vartheta} = & D \frac{1}{r^4 \sin^4 \varphi} \left(v_{\vartheta,\vartheta} + \sin \varphi \cos \varphi v_\varphi + r \sin^2 \varphi v^\xi \right) + \\ & + D \frac{\nu}{r^4 \sin^2 \varphi} \left(v_{\varphi,\varphi} + r v^\xi \right) \end{aligned} \quad (\text{A.18})$$

$$N^{\vartheta\varphi} = D \left(\frac{1-\nu}{r^4 \sin^2 \varphi} \frac{1}{2} (v_{\varphi,\vartheta} + v_{\vartheta,\varphi}) - \frac{\cos \varphi}{\sin \varphi} v_\vartheta \right) \quad (\text{A.19})$$

Load case: self weight

The dead load due to the self weight provides, of course, a symmetrical action so that the expected solution will not depend on ϑ .

Suppose the load per unit area is \bar{q} , uniformly distributed throughout the shell. The vector has only the vertical component

$$\bar{q} = -q^z \bar{e}_z \quad (\text{A.20})$$

whereas, with respect to the basis $\{\bar{\partial}_\varphi, \bar{\partial}_\vartheta, \bar{n}\}$ the vector load \bar{q} is written follows

$$q^{<>} = -q^z \cos \varphi \bar{n} + q^z \sin \varphi \bar{\partial}_\varphi \quad (\text{A.21})$$

By multiplying equation (A.14) by $\sin \varphi$ we obtain

$$(\sin \varphi N^{\varphi\varphi})_{,\varphi} - \sin^2 \varphi \cos \varphi N^{\vartheta\vartheta} + \sin \varphi q^\varphi = 0 \quad (\text{A.22})$$

Let us introduce now the physical components of the stress tensor N , so that

$$N^{<\alpha\beta>} = \frac{N^{\alpha\beta}}{|\mathbf{d}^\alpha||\mathbf{d}^\beta|} = N^{\alpha\beta}|\bar{\partial}_\alpha||\bar{\partial}_\beta| \quad (\text{A.23})$$

Hence, equation (A.22) becomes

$$(\sin \varphi N^{<\varphi\varphi>})_{,\varphi} - \cos \varphi N^{<\vartheta\vartheta>} + r \sin \varphi q^{<\varphi>} = 0 \quad (\text{A.24})$$

Analogously, by multiplying equation (A.16) by $\sin^2 \varphi$, considering the physical components and noticing that $q^\vartheta = 0$, we obtain

$$(\sin \varphi N^{<\vartheta\varphi>})_{,\varphi} + \cos \varphi N^{<\vartheta\varphi>} = 0 \quad (\text{A.25})$$

The remaining equilibrium equation becomes

$$-\frac{N^{<\varphi\varphi>}}{r} - \frac{N^{<\vartheta\vartheta>}}{r} + q^{<\xi>} = 0 \quad (\text{A.26})$$

where, resolving equation (A.26) for $N^{<\vartheta\vartheta>}$, equation (A.24) turns into

$$(\sin^2 \varphi N^{<\varphi\varphi>})_{,\varphi} = (q^{<\xi>} r \cos \varphi - q^{<\varphi>} r \sin \varphi) \sin \varphi \quad (\text{A.27})$$

which can be integrated as follows

$$\sin^2 \varphi N^{<\varphi\varphi>} = \int_{\bar{\varphi}}^{\varphi} r (q^{<\xi>}(\phi) \cos \phi - q^{<\varphi>}(\phi) \sin \phi) \sin \phi d\phi + K \quad (\text{A.28})$$

Equation (A.28) represents the equilibrium of a spherical cap included by latitude $\bar{\varphi}$ and $\varphi \in [\bar{\varphi}, \pi/2]$. In particular the quantity $2\pi r K$, excepting the sign, equilibrates the resultant acting on the cap identified by the aperture $\bar{\varphi}$.

Considering now equation (A.21)

$$\sin^2 \varphi N^{<\varphi\varphi>} = -r q^z [-\cos \phi]_{\bar{\varphi}}^{\varphi} \quad (\text{A.29})$$

for the latitude φ the whole meridian stress when $\bar{\varphi} = 0 \Rightarrow K = 0$ is

$$N^{<\varphi\varphi>} = -\frac{r q^z (1 - \cos \varphi)}{\sin \varphi} = -\frac{r q^z}{1 + \cos \varphi} \quad (\text{A.30})$$

so that equation (A.26) becomes

$$N^{<\vartheta\vartheta>} = rq^z \left(\frac{\sin^2 \varphi - \cos \varphi}{1 + \cos \varphi} \right) \quad (\text{A.31})$$

The third equilibrium equation does not depend on the two latter results, therefore, since $q^\vartheta = 0$, we have

$$N^{<\vartheta\varphi>} = 0 \quad (\text{A.32})$$

Load case: uniform load on the horizontal projection of the shell

This load case keeps unaltered the simplifications regarding the symmetry already discussed in the preceding case. Indeed, here too we are looking for a solution not depending on ϑ .

The load q^z is now projected on the horizontal plane

$$q = -q^z \cos \varphi \bar{e}_z \quad (\text{A.33})$$

therefore with respect to the local basis, the physical components are

$$q^{<>} = -q^z \cos^2 \varphi + q^z \bar{n} \sin \varphi \cos \varphi \bar{d}_\varphi \quad (\text{A.34})$$

By means of a procedure similar to that formerly used we obtain that equation (A.28) now becomes

$$\begin{aligned} \sin^2 \varphi N^{<\varphi\varphi>} &= \int_{\bar{\varphi}}^{\varphi} r (q^{<\xi>}(\phi) \cos \phi - q^{<\varphi>}(\phi) \sin \phi) \sin \phi d\phi + K \\ &= \int_{\bar{\varphi}}^{\varphi} -rq^z \sin \varphi \cos \varphi + K \end{aligned} \quad (\text{A.35})$$

from which

$$\sin^2 \varphi N^{<\varphi\varphi>} = -\frac{1}{2} [\cos^2 \varphi]_{\bar{\varphi}}^{\varphi} \quad (\text{A.36})$$

Next, if $\bar{\varphi} = 0 \Rightarrow K = 0$, the whole meridian stress is

$$N^{<\varphi\varphi>} = -\frac{1}{2} rq^z \quad (\text{A.37})$$

Finally, from equation (A.26) we obtain

$$N^{<\vartheta\vartheta>} = -\frac{1}{2} rq^z \cos 2\varphi \quad (\text{A.38})$$

A.2 Cylindrical shell

In this example we want to compute the stress state for a cylindrical shell subjected to some of the most typical load conditions, e.g. uniform pressure, dead weight, hydrostatic pressure.

A.2.1 Geometry

Obviously we choose as an adapted coordinate system a cylindrical one with a little rearrangement compared with the one introduced in section 1.4.3 on page 18,

$$X = (\vartheta, z, \rho) : E \rightarrow \mathbb{R}^3 \quad (\text{A.39})$$

where, as usual, E is the affine Euclidean space in which the cylindrical surface Q is embedded. The relationships between the Cartesian system, with the origin along the axis of the cylinder, and the cylindrical coordinates are

$$x = \rho \sin \vartheta \quad (\text{A.40})$$

$$y = \rho \cos \vartheta \quad (\text{A.41})$$

$$z = z \quad (\text{A.42})$$

The above adapted coordinate system induces the surface system X^\dagger due to the constraint $\rho = r$, where r is the radius of the cylinder. So we have

$$X^\dagger = (\theta^\dagger, z^\dagger) : Q \rightarrow \mathbb{R}^2 \quad (\text{A.43})$$

The covariant and contravariant forms of the surface induced metric are, respectively

$$g = r^2 \underline{d}^\vartheta \otimes \underline{d}^\vartheta + \underline{d}^z \otimes \underline{d}^z \quad (\text{A.44})$$

$$\bar{g} = \frac{1}{r^2} \bar{\partial}_\vartheta \otimes \bar{\partial}_\vartheta + \bar{\partial}_z \otimes \bar{\partial}_z \quad (\text{A.45})$$

All Christoffel symbols vanish on Q .

The unit normal vector of Q is

$$\bar{n} = \bar{\partial}_\rho \quad (\text{A.46})$$

The Weingarten tensor and the second fundamental form are, respectively

$$L = \frac{1}{r} \underline{d}^\vartheta \otimes \bar{\partial}_\vartheta \quad (\text{A.47})$$

$$\underline{L} = r \underline{d}^\vartheta \otimes \underline{d}^\vartheta \quad (\text{A.48})$$

A.2.2 Displacements and strains

To compute the in-plane state of stress only the stretching strain tensor α is required

$$\alpha_{\vartheta\vartheta} = v_{\vartheta,\vartheta} + rv_\xi \quad (\text{A.49})$$

$$\alpha_{\vartheta z} = \frac{1}{2}(v_{\vartheta,z} + v_{z,\vartheta}) \quad (\text{A.50})$$

$$\alpha_{zz} = v_{z,z} \quad (\text{A.51})$$

A.2.3 Equilibrium and constitutive law

For a cylindrical shell subjected to a membrane state of stress the equilibrium equations in the scalar form are

$$N^{\vartheta\vartheta}_{,\vartheta} + N^{\vartheta z}_{,z} + p^\vartheta = 0 \quad (\text{A.52})$$

$$N^{z,\vartheta} + N^{zz}_{,z} + p^z = 0 \quad (\text{A.53})$$

$$-N^{\vartheta\vartheta} L_{\vartheta\vartheta} + p^\xi = 0 \quad (\text{A.54})$$

$$N^{\vartheta z} = N^{z\vartheta} \quad (\text{A.55})$$

The constitutive equations assume the following form

$$N^{\vartheta\vartheta} = \frac{D}{r^2} \left(\frac{1}{r^2} (v_{\vartheta,\vartheta} + rv_\xi) + v_{z,z} \right) \quad (\text{A.56})$$

$$N^{\vartheta z} = D \left(\frac{1-\nu}{2r^2} (v_{\vartheta,z} + v_{z,\vartheta}) \right) \quad (\text{A.57})$$

$$N^{zz} = D \left(\frac{\nu}{r^2} (v_{\vartheta,\vartheta} + rv_\xi) + v_{z,z} \right) \quad (\text{A.58})$$

Load case: uniform pressure and self weight

This load condition is characterized by two load components, namely q^ξ and q^z . The symmetry around the z -axis permits to delate all terms containing the derivatives with respect to ϑ .

The equilibrium equations become accordingly

$$N^{\vartheta\theta} = \frac{q^\xi}{r} \quad (\text{A.59})$$

$$N^{\vartheta z},z = 0 \quad (\text{A.60})$$

$$N^{zz},z + p^z = 0 \quad (\text{A.61})$$

Next, taking into account the boundary conditions (at $z = 0$) related to the particular load condition and using the physical components, we obtain

$$N^{<\vartheta\theta>} = q^\xi r \quad (\text{A.62})$$

$$N^{<\vartheta z>},z = 0 \Rightarrow N^{<\vartheta z>} = 0 \quad (\text{A.63})$$

$$\begin{aligned} N^{zz},z + q^z = 0 &\Rightarrow N^{zz} = \int_0^z -q^z d\zeta + K \Rightarrow \\ N^{zz} = N^{<zz>} &= -q^z (z - h) \end{aligned} \quad (\text{A.64})$$

Thus, the only nonzero components of \bar{v} are those along ξ and z due to the self load and to the Poisson effect, which are respectively

$$v^\xi = \frac{r^2 q^\xi + r\nu q^z (z - h)}{E(2\epsilon)} \quad (\text{A.65})$$

$$v^z = \frac{1}{E(2\epsilon)} \left(-q^z \left(\frac{z^2}{2} - hz \right) - \nu r q^\xi z \right) \quad (\text{A.66})$$

Hydrostatic pressure and self weight

In this case the load vector \bar{q} is made up of two components: q^ξ and q^z and the equilibrium equations are

$$N^{\vartheta\theta} = \frac{q^\xi}{r} \quad (\text{A.67})$$

$$N^{\vartheta z},z = 0 \quad (\text{A.68})$$

$$N^{zz},z + q^z = 0 \quad (\text{A.69})$$

Furthermore, by taking into account the boundary conditions (at $z = 0$) related to the particular load condition and using the

physical components, we obtain

$$N^{<\vartheta\theta>} = q^\xi r \quad (\text{A.70})$$

$$N^{<\vartheta z>},z = 0 \Rightarrow N^{<\vartheta z>} = 0 \quad (\text{A.71})$$

$$\begin{aligned} N^{zz},z + q^z = 0 &\Rightarrow N^{zz} = \int_0^z -q^z d\zeta + K \Rightarrow \\ N^{zz} = N^{<zz>} &= -q^z(z - h) \end{aligned} \quad (\text{A.72})$$

The nonzero components of \bar{v} are

$$v^\xi = \frac{h - z}{E} r \left(\frac{\gamma L r}{2\epsilon} + \nu \gamma \right) \quad (\text{A.73})$$

$$v^z = \frac{r\nu\gamma l - q^z}{E2\epsilon} \left(\frac{z^2}{2} - hz \right) \quad (\text{A.74})$$

A.3 Hyperboloid of one sheet

The last example we propose concerns an hyperboloid of one sheet, that is the geometry of shell structures usually adopted for cooling towers. The structure is supposed to be loaded by the self weight lone so that the axial symmetry is preserved.

A.3.1 Geometry

The adapted coordinate system is $X = (f, \vartheta, z)$. Here, as made for the preceding geometries, we will begin computing the metric tensors and the Christoffel symbols for such system. Then we will consider the surface Q , i.e. the hyperboloid, described by the induced coordinate system $X^\dagger = (\vartheta^\dagger, z^\dagger)$ obtained by imposing the constraint $f|_Q = 0$. For this system the metric and the Christoffel symbols will also be computed.

The hyperbolic coordinate system is

$$(f, \vartheta, z) : E \rightarrow \mathbb{R}^3 \quad (\text{A.75})$$

with the origin in $o \in E$ that coincides with the origin of a Cartesian coordinate system. See figure A.1.

We use the coordinate function f to define the surface Q , i.e. $f = 0$, that is characterized by the following implicit expression

$$\frac{x^2 + y^2}{a^2} - \frac{z^2}{b^2} - 1 = 0 \quad (\text{A.76})$$

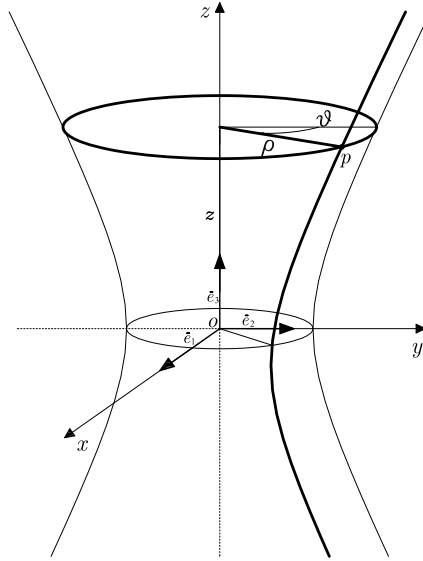

Figure A.1: Hyperbolic coordinate system.

The function f is defined as

$$f = \rho - \rho(z) \quad (\text{A.77})$$

where $\rho(z) = \frac{a}{b} \sqrt{b^2 + z^2} = \sqrt{x^2 + y^2}$.

With respect to the Cartesian system the following coordinate transformations hold

$$x = \left(f + \frac{a}{b} \sqrt{b^2 + z^2}\right) \cos \vartheta \quad (\text{A.78})$$

$$y = \left(f + \frac{a}{b} \sqrt{b^2 + z^2}\right) \sin \vartheta \quad (\text{A.79})$$

$$z = z \quad (\text{A.80})$$

The covariant and contravariant expressions of the metric tensor are, respectively

$$\begin{aligned} g = & \mathbf{d}^f \otimes \mathbf{d}^f + \left(f + \frac{a}{b} \sqrt{b^2 + z^2}\right)^2 \mathbf{d}^\vartheta \otimes \mathbf{d}^\vartheta + \\ & + \left(\frac{a}{b} \frac{z}{\sqrt{b^2 + z^2}}\right) (\mathbf{d}^f \otimes \mathbf{d}^z + \mathbf{d}^z \otimes \mathbf{d}^f) + \\ & + \left(\frac{a^2 z^2}{b^2 (b^2 + z^2)} + 1\right) \mathbf{d}^z \otimes \mathbf{d}^z \end{aligned} \quad (\text{A.81})$$

$$\begin{aligned}
\bar{g} &= \left(\frac{a^2 z^2}{b^2(b^2 + z^2)} + 1 \right) \bar{\partial}_f \otimes \bar{\partial}_f + \\
&- \left(\frac{a}{b} \frac{z}{\sqrt{b^2 + z^2}} \right) (\bar{\partial}_f \otimes \bar{\partial}_z + \bar{\partial}_z \otimes \bar{\partial}_f) + \\
&+ \frac{1}{\left(f + \frac{a}{b} \sqrt{b^2 + z^2} \right)^2} \bar{\partial}_\vartheta \otimes \bar{\partial}_\vartheta + \bar{\partial}_z \otimes \bar{\partial}_z \quad (\text{A.82})
\end{aligned}$$

The nonzero Christoffel symbols for the adapted coordinate system are

$$\Gamma_{zz}^f = \frac{ab}{(\sqrt{b^2 + z^2})^3} \quad (\text{A.83})$$

$$\Gamma_{\vartheta\vartheta}^f = -\left(f + \frac{a}{b} \sqrt{b^2 + z^2} \right) \quad (\text{A.84})$$

$$\Gamma_{f\vartheta}^\vartheta = \Gamma_{\vartheta f}^\vartheta = \frac{1}{f + \frac{a}{b} \sqrt{b^2 + z^2}} \quad (\text{A.85})$$

$$\Gamma_{z\vartheta}^\vartheta = \Gamma_{\vartheta z}^\vartheta = \frac{az}{b\left(f + \frac{a}{b} \sqrt{b^2 + z^2}\right)\sqrt{b^2 + z^2}} \quad (\text{A.86})$$

Consider now the constraint $\rho = \frac{a}{b} \sqrt{b^2 + z^2}$, i.e. $f = 0$, in such a way we pass from the adapted coordinate system $X = (f, \vartheta, z)$ to the induced one $X^\dagger = (\vartheta^\dagger, z^\dagger)^2$.

With respect to the surface coordinate system the expressions of the covariant and contravariant metric tensor are, respectively

$$g^\dagger = \frac{a^2}{b^2} (b^2 + z^2) \underline{d}^\vartheta \otimes \underline{d}^\vartheta + \left(\frac{a^2 z^2}{b^2(b^2 + z^2)} + 1 \right) \underline{d}^z \otimes \underline{d}^z \quad (\text{A.87})$$

$$\bar{g}^\dagger = \frac{b^2}{a^2} \frac{1}{(b^2 + z^2)} \bar{\partial}_\vartheta \otimes \bar{\partial}_\vartheta + \frac{b^2 (b^2 + z^2)}{a^2 z^2 + b^2 (b^2 + z^2)} \bar{\partial}_z \otimes \bar{\partial}_z \quad (\text{A.88})$$

and the nonzero Christoffel symbols Γ^\dagger are

$$\Gamma_{z\vartheta}^{\dagger\vartheta} = \Gamma_{\vartheta z}^{\dagger\vartheta} = \frac{z}{(b^2 + z^2)} \quad (\text{A.89})$$

$$\Gamma_{zz}^{\dagger z} = \frac{a^2 b^2 z}{[a^2 z^2 + b^2 (b^2 + z^2)](b^2 + z^2)} \quad (\text{A.90})$$

$$\Gamma_{\vartheta\vartheta}^{\dagger z} = -\frac{a^2 z (b^2 + z^2)}{a^2 z^2 + b^2 (b^2 + z^2)} \quad (\text{A.91})$$

²From now on we will omit the symbol \dagger to denote the entities on Q when it is not ambiguous.

Next, the unit normal vector is

$$\bar{n} = \sqrt{\frac{a^2 z^2 + b^2 (b^2 + z^2)}{b^2 (b^2 + z^2)}} \bar{\partial}_f - \frac{az}{\sqrt{a^2 z^2 + b^2 (b^2 + z^2)}} \bar{\partial}_z \quad (\text{A.92})$$

and the Weingarten tensor and the second fundamental form are, respectively

$$\begin{aligned} L &= \frac{b^2}{a\sqrt{a^2 z^2 + b^2 (b^2 + z^2)}} \mathbf{d}^\vartheta \otimes \bar{\partial}_\vartheta + \\ &\quad - \frac{ab^4}{(a^2 z^2 + b^2 (b^2 + z^2))^{\frac{3}{2}}} \mathbf{d}^z \otimes \bar{\partial}_z \end{aligned} \quad (\text{A.93})$$

$$\begin{aligned} L &= \frac{a(b^2 + z^2)}{\sqrt{a^2 z^2 + b^2 (b^2 + z^2)}} \mathbf{d}^\vartheta \otimes \mathbf{d}^\theta + \\ &\quad - \frac{ab^2}{(b^2 + z^2) \sqrt{a^2 z^2 + b^2 (b^2 + z^2)}} \mathbf{d}^z \otimes \mathbf{d}^z \end{aligned} \quad (\text{A.94})$$

The total curvature of the surface, i.e. the Gauss curvature, and the mean curvature are, respectively

$$K = -\frac{b^6}{[a^2 z^2 + b^2 (b^2 + z^2)]^2} \quad (\text{A.95})$$

$$H = \frac{a^2 b^2 (z^2 - b^2) + b^4 (b^2 + z^2)}{a[a^2 z^2 + b^2 (b^2 + z^2)]^{\frac{3}{2}}} \quad (\text{A.96})$$

Moreover, from the Weingarten tensor, the principal curvatures are readily obtained

$$\lambda_1 = \frac{b^2 (b^2 + z^2)}{a(b^2 + z^2) \sqrt{a^2 z^2 + b^2 (b^2 + z^2)}} \quad (\text{A.97})$$

$$\lambda_2 = -\frac{ab^4}{[a^2 z^2 + b^2 (b^2 + z^2)]^{\frac{3}{2}}} \quad (\text{A.98})$$

The surface coordinate system $X^\dagger = (\vartheta, z)$ is definitely comfortable to describe and identify points on the hyperboloid, however to solve the in-plane equilibrium problem for the symmetrical load condition it is more convenient to chose instead of the z coordinate, the angle φ that the segment line along \bar{n} forms with the vertical axis z . This new variable is related to the former one by the

following relationship

$$\varphi = \sin^{-1} \left(\frac{\sqrt{b^2 + z^2}}{\sqrt{b^2 + k^2 z^2}} \right) \quad (\text{A.99})$$

where k is a dimensionless geometric factor

$$k = \sqrt{1 + \frac{a^2}{b^2}} \quad (\text{A.100})$$

A.3.2 Equilibrium

By making use of the coordinate φ , the solution of the equilibrium equations allows us to write the expressions of the stress tensor as

$$N^{<\varphi\varphi>} = \frac{qa\sqrt{k^2 \sin^2 \varphi - 1}}{\sin^2 \varphi \sqrt{k^2 - 1}} (\zeta(\varphi) - \zeta(\varphi_t)) \quad (\text{A.101})$$

$$N^{<\vartheta\vartheta>} = \frac{a\sqrt{k^2 - 1}}{k^2 \sin^2 \varphi - 1} \left(-q \cos \varphi + \frac{N^{<\varphi\varphi>} (k^2 \sin^2 \varphi - 1)^{\frac{3}{2}}}{a\sqrt{k^2 - 1}} \right) \quad (\text{A.102})$$

where q is the dead load per unit of area (assumed to be constant along the thickness) while the function ζ equals

$$\zeta = \frac{-\cos \varphi}{2(k^2 \sin^2 \varphi - 1)} + \frac{1}{4k\sqrt{k^2 - 1}} \ln \left(\frac{\sqrt{k^2 - 1} - k \cos \varphi}{\sqrt{k^2 - 1} + k \cos \varphi} \right) \quad (\text{A.103})$$

Further details on the derivation of the above expressions are available in [17].

Bibliography

- [1] I. S. SOKOLNIKOFF. *Mathematical Theory of Elasticity*. McGraw–Hill Book Company, Inc. 1956.
- [2] H. LEIPHOLZ. *Theory of Elasticity*. Noordhoff International, Inc. 1974.
- [3] A. E. GREEN, W. ZERNA. *Theoretical Elasticity*. Oxford, at the Clarendon press, 1968.
- [4] M. MODUGNO. *Introduzione alla Meccanica dei Sistemi Continui*. (<http://www.dma.unifi.it/~modugno/1-didattica/>)
- [5] M. MODUGNO. *Notes on Geometry of Surfaces*. (<http://www.dma.unifi.it/~modugno/1-didattica/>)
- [6] A. E. H. LOVE. *A Treatise on the Mathematical Theory of Elasticity*. Dover Publications, Inc. Fourth Edition, 1927.
- [7] S. P. TIMOSHENKO. *Strength of Material. Part II*. D. Van Nostrand Company, Inc. 1940.
- [8] P. VILLAGGIO. *Qualitative Methods in Elasticity*. Noordhoff International, 1977.
- [9] F. ANGOTTI, A. BORRI. *Lezioni di Scienza delle Costruzioni*. Ed. DEI, Roma 2005.
- [10] M. CAPURSO. *Lezioni di Scienza delle Costruzioni*. Pitagora Editrice, Bologna 1971.
- [11] R. BALDACCI *Fondamenti di Meccanica dei Solidi*. UTET, Torino 1970.
- [12] A. SOLLAZZO, S. MARZANO. *Elementi di Meccanica dei Continui e Resistenza dei Materiali*. Unione Tipografico–Editrice Torinese, 1988.
- [13] P. P. GUIDUGLI. *Lezioni sulla Teoria Lineare dei Gusci Elastici Sottili*. Ed. Masson, Milano 1991.

- [14] P. G. CIARLET. *Mathematical Elasticity. Volume I: Three-dimensional Elasticity*. Elsevier, 1968.
- [15] C. DAVINI. *Lezioni sulla Teoria dei Gusci*. Dispense, 1993.
- [16] Y. BASAR, E.H. WILFRIE B. KRÄTZIG. *Theory of Shell Structures*. Fortschritt-Berichte VDI, Reihe 18, Mechanik/Bruchmechanik, Nr.258, 2001.
- [17] P. L. GOULD. *Static Analysis of Shells*. Toronto, Lexington Book, 1977.
- [18] W. FLUGGE. *Stress in Shells*. Berlin, Springer-Verlag 1966.
- [19] L. FISCHER. *Theory and Practice of Shell Structures*. Berlin, Ernst, 1968.

Index

- affine space, 24, 29
- angular dilatation, 45
- anisotropic material, 92
- area dilatation, 46
- area element, 23, 46

- Beltrami-Michell's equations, 98
- Betti
 - theorem of, 120
- bilinear form, 6
- body and surface forces, 57, 116, 119
- Bredt, 181

- Castigliano, 124, 126
- Cauchy, 63
 - principle, 59
 - stress quadric, 78
 - stress tensor, 80
 - stress vector, 60
- characteristic polynomial, 11
- Christoffel symbols, 16, 19, 20, 28, 43, 204, 208, 211, 213
- Clapeyron, 157
 - theorem of, 111, 114, 167, 179, 196–198
- complementary energy, 122
 - stationarity of, 124
 - theorem of minimum, 124
- contravariant components, 10, 16, 40
- contravariant tensors, 12, 24, 29, 86
- coordinate system, 13
 - Cartesian, 9, 17, 25, 26, 31, 38, 44, 56
 - curvilinear, 39, 42, 57
 - cylindrical, 18, 27, 208
 - hyperbolic, 211
 - induced, 32, 34
 - spherical, 19, 203
- covariant components, 10, 15, 19, 20, 33, 39, 40
- covariant tensors, 12, 24, 25, 34
- curl, 26, 28, 50
- curvature
 - Gauss, 34, 84, 214
 - mean, 34, 84, 214
 - principal, 34
- divergence, 25, 27, 29
- divergence theorem, 28, 65, 105, 109, 110, 112, 182
- dual space, 5, 11

- eigenvalue, 10
- eigenvector, 10
- elastic range, 90
- elasticity tensor, 91, 92, 117
- endomorphism, 6, 8, 11, 12, 14, 21, 33, 34, 60
- equilibrium

- boundary equation, 67, 111, 146, 154
- rotational, 65, 66, 86–88, 183
- translational, 62, 64, 86, 88
- Euclidean metric, 9
- flexural rigidity, 167
- gradient, 25, 27, 173, 174
- homogeneity, 5, 90
- Hooke
 - generalized law, 90, 93
 - law, 89
 - Robert, 89
- infinitesimal deformations, 48
- isotropic material, 92
- Jacobian, 39
- Jourawski, 187
- Lamé, 99
 - constants, 93, 95
- Laplace operator, 26
- line element, 23, 24, 41, 52
- linear form, 5, 6, 12
- linear mapping, 4
- Menabrea, 126
- mixed tensors, 12
- Mohr's circles, 70
- musical isomorphisms, 10
- Navier, 99, 163
- Neumann, 173, 175, 177, 180
- physical basis, 27
- physical components, 27
- Poisson's ratio, 94
- potential energy, 120, 122, 124, 132, 133
 - of deformation, 121
 - stationarity of, 122
 - theorem of minimum, 122
- principal planes of stress, 68
- reciprocity
 - theorem of, 120
- rigid body, 38
- rigid body motions, 50, 118, 126, 156, 178
- scalar product, 9, 31, 42, 45, 69, 125, 173, 187
- second fundamental form, 33
- strain tensor, 41
 - bending, 54, 55
 - bending II, 54, 56
 - finite, 43, 44
 - infinitesimal, 176, 194
 - infinitesimal, 48, 155
 - stretching, 54, 55, 204, 209
- stress
 - characteristic equation, 67
 - principal, 67
 - tensor, 64
 - vector components, 61
- stress function, 175
- stress tensor
 - deviator, 78
 - spherical, 78
- stress vector
 - normal component, 69
 - tangential component, 69
- stretching ratio, 44
- superposition principle, 116
- torsion function, 173
- uniqueness of solution, 117

MANUALI

BIOMEDICA

Rossetti R., *Manuale di batteriologia clinica. Dalla teoria alla pratica in laboratorio*

Rucci L., *Testo Atlante di embriologia clinica della Laringe. La chirurgia conservativa compartimentale della regione glottica*

SCIENZE

Bart J.C.J., *Polymer Additive Analytics. Industrial Practice and Case Studies*

Scialpi A., Mengoni A. (a cura di), *La PCR e le sue varianti. Quaderno di laboratorio*

Simonetta M.A., *Short history of Biology from the Origins to the 20th Century*

Spinicci R., *Elementi di chimica*

SCIENZE SOCIALI

Ciampi F., *Fondamenti di economia e gestione delle imprese*

Maggino F., *L'analisi dei dati nell'indagine statistica. Volume 1. La realizzazione dell'indagine e l'analisi preliminare dei dati*

Maggino F., *L'analisi dei dati nell'indagine statistica. Volume 2. L'esplorazione dei dati e la validazione dei risultati*

Magliulo A., *Elementi di economia del turismo*

SCIENZE TECNOLOGICHE

Borri C., Pastò S., *Lezioni di ingegneria del vento*

Borri C., Betti, M., Marino E., *Lectures on Solid Mechanics*

Gulli R., *Struttura e costruzione / Structure and Construction*

Policicchio F., *Lineamenti di infrastrutture ferroviarie*

UMANISTICA

Bertini F., *Risorse, conflitti, continenti e nazioni. Dalla rivoluzione industriale alle guerre irachene, dal Risorgimento alla conferma della Costituzione repubblicana*

Bombi A.S., Pinto G., Cannoni E., *Pictorial Assessment of Interpersonal Relationships (PAIR). An analytic system for understanding children's drawings*

Borello E., Mannori S., *Teoria e tecnica delle comunicazioni di massa*

Brandi L., Salvadori B., *Dal suono alla parola. Percezione e produzione del linguaggio tra neurolinguistica e psicolinguistica*

Marcialis N., *Introduzione alla lingua paleoslava*

Michelazzo F., *Nuovi itinerari alla scoperta del greco antico. Le strutture fondamentali della lingua greca: fonetica, morfologia, sintassi, semantica, pragmatica*

Peruzzi A., *Il significato inesistente. Lezioni sulla semantica*

Trisciuzzi L., Zappaterra T., Bichi L., *Tenersi per mano. Disabilità e formazione del sé nell'autobiografia*

Finito di stampare presso
la tipografia editrice Polistampa