

We are IntechOpen, the world's leading publisher of Open Access books Built by scientists, for scientists

5,300

Open access books available

130,000

International authors and editors

155M

Downloads

Our authors are among the

154

Countries delivered to

TOP 1%

most cited scientists

12.2%

Contributors from top 500 universities



WEB OF SCIENCE™

Selection of our books indexed in the Book Citation Index
in Web of Science™ Core Collection (BKCI)

Interested in publishing with us?
Contact book.department@intechopen.com

Numbers displayed above are based on latest data collected.
For more information visit www.intechopen.com



Development of Josephson Voltage Standards

Johannes Kohlmann and Ralf Behr
Physikalisch-Technische Bundesanstalt (PTB)
Germany

1. Introduction

Exciting applications of superconductivity are based on the macroscopic quantum state which exists in a superconductor. In this chapter we investigate the behaviour of junctions consisting of two weakly coupled superconductors. These junctions are nowadays called Josephson junctions¹ (Josephson, 1962). The macroscopic quantum state results in an exceptional behaviour of these Josephson junctions. They are the basis for various applications in superconductive electronics (cf. Anders et al, 2010), e.g. in the field of metrology for high-precision measurements. The most significant representative of a metrological application is the Josephson voltage standard. This quantum standard enables the reference of the unit of voltage, the volt, just to physical constants. It is nowadays used in many laboratories worldwide for high-precision voltage measurements. The main component of each modern Josephson voltage standard is the highly integrated series array consisting of tens of thousands of Josephson junctions fabricated in thin-film technology.

While Josephson junctions are conceptually simple, nearly 50 years of developments were needed to progress from single junctions delivering a few millivolt at most to highly integrated series arrays containing more than 10,000 or even 100,000 junctions. These large series arrays enable the generation of dc and ac voltages at the 10 V level, which is relevant for most applications. Conventional Josephson voltage standards based on underdamped Josephson junctions are used for dc applications. The increasing interest in highly precise ac voltages has stimulated different attempts to develop measurement tools on the basis of Josephson arrays for ac applications, namely programmable Josephson voltage standards containing binary-divided arrays and pulse-driven Josephson voltage standards both based on overdamped Josephson junctions. This chapter describes the development of these modern dc and ac Josephson voltage standards as well as their fundamentals and applications. The development and use of Josephson voltage standards have also been described recently in several review papers (amongst others: Niemeyer, 1998; Hamilton, 2000; Yoshida, 2000; Behr et al., 2002; Kohlmann et al., 2003; Benz & Hamilton, 2004; Jeanneret & Benz, 2009).

¹ When Brian D. Josephson was a 22-year-old graduate student at Trinity College in Cambridge, UK, he theoretically derived equations for the current and voltage across a junction consisting of two weakly coupled superconductors in 1962. His discovery won him a share of the 1973 Nobel Prize in Physics.

2. Fundamentals - the Josephson effects

A superconductor as a macroscopic object is quantum mechanically described by a macroscopic wavefunction. This macroscopic wavefunction is an important aspect of the BCS theory of superconductivity named after the authors Bardeen, Cooper, and Schrieffer² (1957). Brian Josephson investigated the behaviour of two weakly coupled superconductors on the basis of the BCS theory a few years after its publication (Josephson, 1962). He predicted two effects due to the tunnelling of Cooper pairs across the connection, i.e. a coupling of the macroscopic wavefunction of the two superconductors: (1) a dc supercurrent $I = I_c \sin \phi$ can flow across this junction (I_c denotes the critical current and ϕ the phase between the macroscopic wavefunction of the two superconductors); (2) an ac supercurrent of frequency $f_j = (2e/h) \cdot V$ occurs if the junction is operated at a non-zero voltage V , i.e. a Josephson junction is an oscillator (e is the elementary charge and h is Planck's constant). Irradiation of the junction by external microwaves of frequency f vice versa produces constant-voltage steps due to the phase locking of the Josephson oscillator by the external oscillator: $V_n = n \cdot (h/2e) \cdot f$ ($n = 1, 2, 3, \dots$ denotes the integer step number). As an illustration, the generation of constant-voltage steps can also be described as a specific transfer of flux quanta $\Phi_0 = h/2e$ through the Josephson junction. The irradiation of the Josephson junctions with external microwaves of frequency f effects this specific transfer and produces constant-voltage steps V_n :

$$V_n = n \cdot \Phi_0 \cdot f \quad (1)$$

The Josephson effect thus reduces the reproduction of voltages to the determination of a frequency, which can be finely controlled with high precision and accurately referenced to atomic clocks. The constant-voltage steps were observed soon after by Shapiro (1963). A single Josephson junction operated at the first-order constant-voltage step generates about 145 μV , when irradiated by 70 GHz microwaves. Highly integrated junction series arrays are therefore needed to achieve practical output voltages up to 1 V or 10 V.

The frequency range for the best operation of Josephson junctions is determined by their dynamic characteristics. The most important parameter is the characteristic voltage $V_c = I_c \cdot R_n$ (R_n denotes the normal state resistance of the junctions). The characteristic voltage is related to the characteristic frequency by equation (1): $f_c = (2e/h) \cdot V_c = (2e/h) \cdot I_c \cdot R_n$.

The dynamics of a Josephson junction is often investigated using the resistively-capacitively-shunted-junction (RCSJ) model (Stewart, 1968; McCumber, 1968). Within this model, the real Josephson junction is described as a parallel shunting of an ohmic resistance R , a capacitance C , and an ideal Josephson element. In the linear approximation, the resonance frequency is given by the plasma frequency $f_p = (e \cdot j_c / \pi \cdot h \cdot C_s)^{1/2}$ (j_c denotes the critical current density, $C_s = C/A$ the specific junction capacitance, and A the junction area). Details of the behaviour depend on the kind of junction, which can be characterized by the dimensionless McCumber parameter $\beta_c = Q^2$ being equal to the square of the quality factor $Q = 2\pi \cdot f_p \cdot R \cdot C$ of the junction. Underdamped junctions with $\beta_c > 1$ show a hysteretic current-voltage characteristic, overdamped junctions with $\beta_c \leq 1$ a non-hysteretic one as schematically shown in Fig. 1. Detailed descriptions of the Josephson effects and Josephson junctions have been

² Bardeen, Cooper, and Schrieffer were awarded the 1972 Nobel Prize in Physics for their theory of superconductivity.

given in several reviews (e.g. Josephson, 1965; Kautz, 1992; Rogalla, 1998) and textbooks (e.g. Barone & Paternò, 1982; Likharev, 1986; Kadin, 1999).

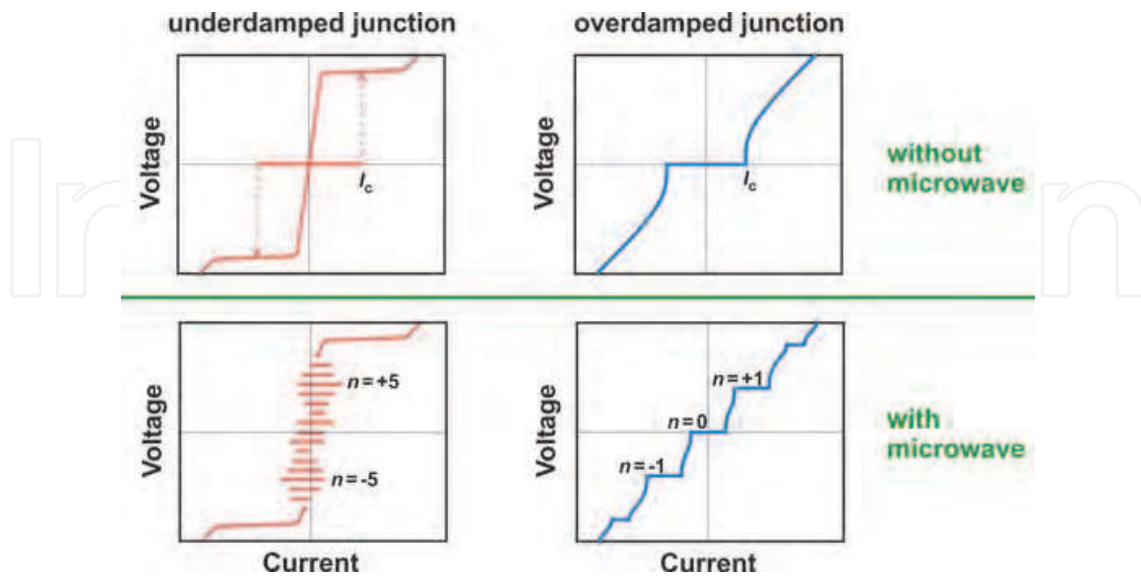

Fig. 1. Schematic current-voltage characteristic of underdamped (left) and overdamped (right) Josephson junctions without (top) and with (bottom) microwave irradiation. Some constant-voltage steps are marked.

3. Realization of Josephson junctions and series arrays

A Josephson junction is composed of two weakly coupled superconductors. While Josephson (1962) originally investigated the tunnelling of Cooper pairs through a barrier, i.e. an insulator, he also mentioned that similar effects should occur when two superconductors are separated by a thin normal region. These two junction types are nowadays indeed the most important ones for Josephson junctions, namely the so-called SIS junctions and SNS junctions, respectively (S: Superconductor, I: Insulator, N: Normal metal). SIS junctions are typically underdamped junctions, while SNS junctions are overdamped ones. Moreover, further possibilities for the realization of Josephson junctions exist such as e.g. SINIS junctions, grain boundary junctions (especially for high-temperature superconductors), and junctions consisting of two superconductors connected by a narrow constriction. As junctions for Josephson voltage standards are mainly based on SIS, SNS, or SINIS junctions, these types will be described in more detail in the following. The fabrication of the integrated circuits containing these junctions is based on the same main steps; the fabrication processes differ only in detail.

3.1 Fabrication process

The development of Josephson voltage standards is intimately connected with improvements of the fabrication technology for series arrays. The fabrication process should be as simple and reliable as possible, and must be realized in thin-film technology, in order to enable the fabrication of highly integrated circuits containing thousands of junctions in a similar way to in the semiconductor industry. Josephson junctions and the first series arrays in the 1980s were fabricated in lead/lead alloy technology (cf. Niemeyer et al, 1984); but the

main problem was the susceptibility to damage of the lead alloy circuits by humidity and thermal cycling. The main important breakthrough in the development of a more robust fabrication process was the invention of the Nb/Al-Al₂O₃ technology by Gurvitch et al (1983). This technology combines the use of the durable and chemically stable metal Nb with the high critical temperature of about 9.2 K, the outstanding covering of thin Al layers on Nb, and the formation of a very homogeneous and stable oxide of Al by thermal oxidation. The adaptation of this process and several improvements made possible the fabrication of voltage standard arrays consisting of Nb/Al-Al₂O₃/Nb Josephson junctions in 1986 (Niemeyer et al, 1986). Nowadays, all Josephson arrays for voltage standard applications are fabricated in processes fundamentally based on this invention.

Sputtered Nb is typically used at present for the superconducting layers and NbN in case of operation at 10 K, respectively. Dielectric layers are realized by SiO₂. Lithography is made optically or by electron-beam depending on the dimensions of the structure and its complexity. The different layers are patterned by adapted fluorine-based dry etching processes. For a reliable process, the trilayer or multilayer defining the junctions are deposited as a sandwich structure without breaking the vacuum. This process requires an additional wiring layer for connecting neighbouring junctions by a window technology. The barrier material is also sputtered; if the barrier includes an oxide, a metallic layer is thermally oxidized. SIS junctions contain an Al₂O₃ barrier realized by thermal oxidation of the Al layer. SINIS junctions consist of a multilayer of Nb/Al₂O₃/Al/Al₂O₃/Nb. SIS junctions are typically operated at around 70 GHz. The characteristic voltage of SINIS junctions can be tuned over a wide range enabling operation either at frequencies around 15 GHz or around 70 GHz.

Different materials have been investigated and used for the N layer of SNS junctions. As the specific resistance of most metals is rather low, high-resistive materials are preferred in order to increase the characteristic voltage. Most SNS junctions are therefore operated at frequencies between 10 GHz and 20 GHz. The high resistivity for the N layer is reached by binary alloys as PdAu (Benz et al, 1997), HfTi (Hagedorn et al, 2006), or MoSi₂ (Chong et al, 2005). Junctions containing an N layer of Ti (Schubert et al, 2001a) or TiN (Yamamori et al, 2008) have also been realized. Recently, a new type of junction has increasingly gained in importance: its barrier consists of a semiconductor such as Si doped with a metal and being near a metal insulator transition (Baek et al, 2006). Although these junctions behave like SNS junctions, they are more their own class of junctions and sometimes called SI'S junctions. A promising version of these SI'S junctions is realized by an amorphous Si barrier doped by Nb. Nb and Si are co-sputtered from two sputter targets; the Nb content is varied by adjusting the power for sputtering.

The thickness of the superconducting layers is typically above about 150 nm and therefore roughly twice the superconducting penetration depth at least. The superconducting layers are consequently both thick enough, to ensure appropriate microwave behaviour, and thin enough, to allow reliable thin-film processes. The barrier is between 10 nm and 30 nm thick depending on the details of the material. Stacked junctions have also been investigated in order to increase the integration density of junctions. They contain multilayers of superconducting Nb and barrier material. Adapted etching processes guarantee vertical edges and thus an identical size of each individual junction in order to yield homogeneous electrical parameters of the junction stacks. Arrays of double- and triple-stacked junctions have successfully been fabricated delivering output voltages between a few volts and even 10 V (Chong et al, 2005; Yamamori et al, 2008).

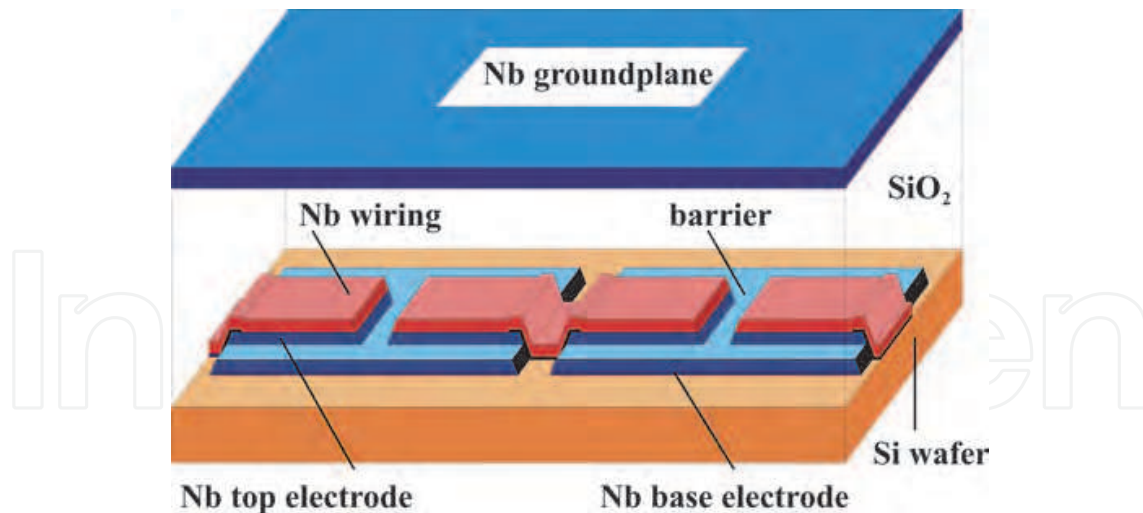

Fig. 2. Cross section of a microstripline.

3.2 Designs - a brief survey

An important requirement for the design of the circuits is the uniform microwave power distribution over all Josephson junctions in order to generate wide and stable constant-voltage steps. The step width of the constant-voltage steps depends on the applied microwave power; in some cases, the dependence is given by a Bessel function (Kautz, 1992 & 1995). A uniform power distribution is achieved by the integration of the Josephson junctions into adapted microwave transmission lines. Most modern Josephson voltage standards are based on one of three different microwave lines: a low-impedance microstrip line (cf. Fig. 2), a $50\ \Omega$ coplanar waveguide transmission line (CPW) (cf. Fig. 9), and a $50\ \Omega$ coplanar stripline (CPS). The microstrip line caused the breakthrough for the first version of modern voltage standards, i.e. the conventional Josephson voltage standard (cf. Niemeyer et al, 1984), and is mainly used to date for circuits operated in the frequency range around 73 GHz. Circuits based on CPWs have been introduced for programmable Josephson voltage standards operated in the frequency range from 10 GHz to 20 GHz (cf. Benz, 1995). Coplanar strip-lines were first used for conventional voltage standards operated at 75 GHz (Schubert et al, 2001b). CPW and CPS offer the advantage of a rather simple required fabrication technology compared to the microstrip line that needs an additional ground plane and a dielectric layer. An advantage of the microstrip line is that it enables a rather simple possibility of splitting a single high-frequency line in two parallel ones; this splitting can be performed several times. Each microwave branch is terminated by a matched lossy microwave line that serves as a load. Microwave reflections are therefore suppressed, which consequently provides a uniform microwave distribution by avoiding standing waves.

Most conventional dc Josephson voltage standards are based on microstrip line designs. The design of programmable Josephson voltage standards depends on the frequency range for their operation. Most programmable standards operated around 73 GHz are also based on microstrip line designs. Circuits for operation between 10 GHz and 20 GHz use CPWs (cf. Benz et al, 1997; Dresselhaus et al, 2009). The design is determined in detail by the high-frequency behaviour of the Josephson junctions.

Fig. 3 shows, as an example, the PTB design of a 10 V SNS array for operation at 70 GHz and this is briefly described in the following. An antipodal finline taper serves as an antenna. It connects the microstrip line, containing the Josephson junctions, to the E-band rectangular

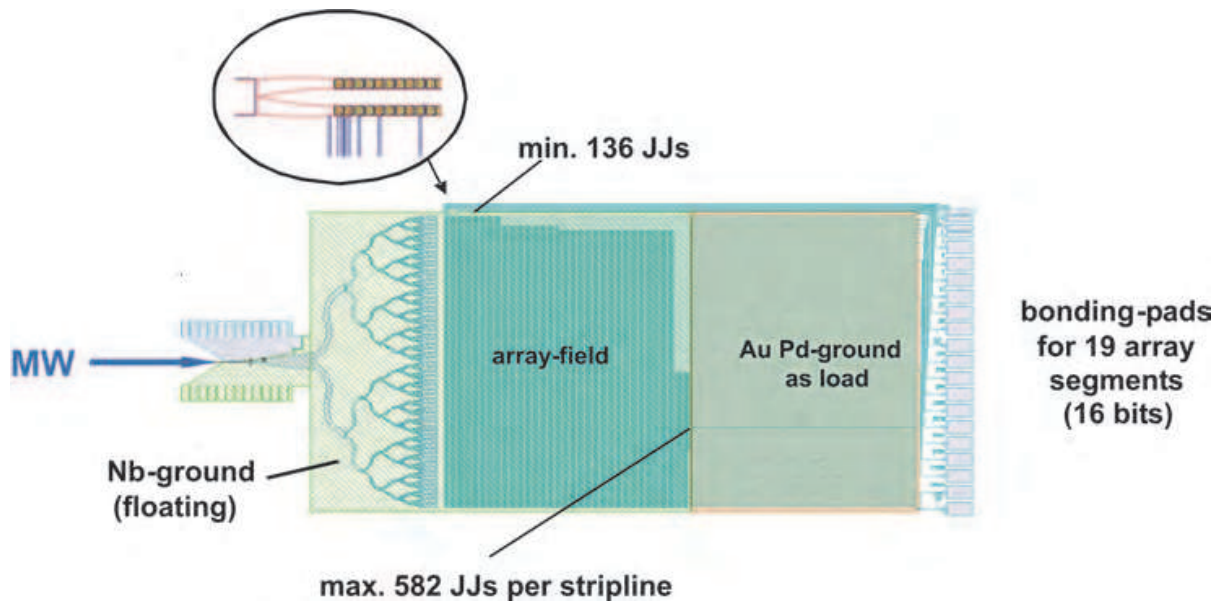

Fig. 3. Design of a 10 V SNS Josephson series array developed at PTB. The array consists of 69,632 junctions embedded into 128 parallel low-impedance microstriplines. The length and width of a single junction is $6\ \mu\text{m} \times 20\ \mu\text{m}$. The size of the total chip is $24\ \text{mm} \times 10\ \text{mm}$.

waveguide while simultaneously matching the impedance of the waveguide (about $520\ \Omega$) to that of the microstrip line (about $5\ \Omega$). The microstrip line is split in several stages forming parallel branches. The design of conventional 10 V circuits contains two stages resulting in four parallel branches. The design of programmable 1 V (10 V) circuits consists of 6 (7) stages forming 64 (128) parallel branches. The reason for these differences can be understood by using the RCSJ model (cf. section 2). For SIS junctions, the ohmic resistance R_n is of the order of $50\ \Omega$, while the impedance of the capacitive branch $Z_d = 1/(2\pi f C)$ is of the order of $50\ \text{m}\Omega$ for a junction capacitance of $50\ \text{pF}$. High-frequency currents therefore flow mainly capacitively resulting in a very low attenuation of the microwave power from about 1 dB/1,000 junctions to 2 dB/1,000 junctions. Each branch can therefore contain a lot of junctions (about 3,500 junctions in the real design) without losing a uniform microwave power distribution to each junction. The conditions are completely different for overdamped SINIS junctions. Now, R_n and Z_d are comparable (about $50\ \text{m}\Omega$ each) leading to the significant dissipation of the microwave current and thus to a significant attenuation of the microwave power of about 50 dB/1,000 junctions (Schulze et al, 1999). The high attenuation is, however, compensated in part by an active contribution of the junctions; the junctions act as oscillators. The single branches of programmable series arrays consist therefore of 128 junctions (1 V design) and up to 582 junctions (10 V design), respectively. Overdamped SNS junctions integrated into a low-ohmic microstrip line show similar behaviour, as a significant part of the microwave is dissipated resistively.

Another situation is found for overdamped SNS junctions embedded into the centre line of a CPW. The ratio of the low junction impedance to the $50\ \Omega$ impedance of the CPW leads to a situation which is similar to that of the microstrip line for conventional SIS arrays: Attenuation of the microwave power is low, because the junctions are loosely linked to the CPW. Each branch can therefore contain more junctions than in the microstrip line designs. Typical numbers for 1 V (10 V) arrays are 8 (32) branches with 4096 (8400) junctions each (Benz et al, 1997; Burroughs et al, 2009a).

4. DC measurements - conventional Josephson voltage standards

While at the beginning of Josephson voltage standards the voltage of a single junction in the millivolt range was used as a reference (cf. Niemeyer, 1998; Hamilton, 2000), the chapter of modern Josephson voltage standards was opened by two new ideas: First, Levinson et al (1977) suggested the use of highly underdamped junctions with hysteretic current-voltage characteristics producing constant-voltage steps whose current ranges overlap one another for small bias currents. A single bias current source can consequently be used to bias all junctions of a series array on the quantized constant-voltage steps. Secondly, the Josephson junctions are embedded into an adapted microwave transmission line resulting in first 1 V arrays realized by Niemeyer et al (1984). Because of this arrangement, the Josephson junction series array is connected in series for the dc bias and acts as a microstrip line at rf frequencies. As the microwave power is mainly capacitively coupled to the underdamped junctions, the rf attenuation of the series array is very low, therefore, enabling uniform rf bias of all junctions.

Since the mid 1980s Josephson voltage standards based on these concepts have been available. Underdamped Josephson junctions are typically realized by SIS junctions (S: Superconductor, I: Insulator). Large series arrays of Josephson junctions are needed to reach the voltage level essential for real applications, namely 1 V or especially 10 V. A 10 V series array typically contains between about 14,000 and 20,000 Josephson junctions depending on the details of the specific design. The circuits developed and fabricated at PTB consist of about 14,000 junctions distributed to four parallel low-impedance microstrip-lines. Typical arrays show under 70 GHz microwave irradiation a step width above 20 μ A, best arrays up to 50 μ A. This kind of so-called conventional Josephson voltage standard has been successfully operated to date for dc applications in many national, industrial, and military standards labs around the world. They are now commercially offered by two companies.³ In spite of their very successful use for dc applications, conventional Josephson voltage standards have two important drawbacks due to the ambiguity of the constant-voltage steps: First, they do not enable switching rapidly and reliably between different specific steps. Secondly, the constant-voltage steps are only metastable so that electromagnetic interference can cause spontaneous switching between steps.

5. From DC to AC - programmable Josephson voltage standards

As described in the previous section, conventional Josephson voltage standards are operated very successfully for dc applications. The increasing interest in rapidly switching arrays and in highly precise ac voltages stimulated research activities in the mid 1990s to develop measurement tools based on Josephson junctions to meet these requirements. Different attempts have been suggested and partly realized. The main important ones are programmable voltage standards based on binary-divided arrays (cf. 5.1), pulse-driven arrays (cf. 5.3), and a d/a converter based on the dynamic logic of processing single flux quanta (SFQ) (cf. Semenov & Polyakov, 2001). In the following, the first two versions are described in more detail, as most research activities are presently focused on these two, and promising results have meanwhile been demonstrated. Both are intended to extend the use of high-precision Josephson voltage standards from dc to ac.

³ Hypres Inc., USA: www.hypres.com and Supracon AG, Germany: www.supracon.com.

5.1 Programmable voltage standards based on binary-divided arrays

The limitations of conventional Josephson voltage standards are mainly due to the overlapping steps resulting from the hysteretic current-voltage characteristic of underdamped Josephson junctions. Therefore, Josephson junctions showing a non-hysteretic current-voltage characteristic have been investigated. Such behaviour is shown by an overdamped Josephson junction. The current-voltage characteristic is non-hysteretic and remains single-valued under microwave irradiation (cf. Fig. 1). The constant-voltage steps are consequently inherently stable and can rapidly be selected by external biasing. All junctions are operated on the same constant-voltage step (typically the first one) in contrast to those of conventional standards, which are operated at the fourth to fifth step as average. The number of junctions necessary to attain a given voltage must be increased correspondingly. The series array of junctions must additionally be divided into segments in order to enable the generation of different voltage levels. The Josephson array is hence operated as a multi-bit digital-to-analogue (d/a) converter based on a series array of overdamped Josephson junctions divided into segments containing numbers of junctions belonging e.g. to a binary sequence of independently biased smaller arrays (cf. Fig. 4). Any integral number of constant-voltage steps permitted by that sequence can consequently be generated by these arrays, often called programmable Josephson voltage standards.

A programmable Josephson voltage standard was suggested and demonstrated for the first time by Hamilton et al (1995). In that case 2,048 junctions of an array containing 8,192 externally shunted SIS junctions were operated at 75 GHz and delivered an output voltage of about 300 mV. As the critical current and consequently the step width are limited to a few hundred microamperes due to design restrictions of externally shunted SIS arrays, and a design for these junctions is rather complex and challenging, other junction types have subsequently been investigated. The final breakthrough of programmable voltage standards was enabled by the implementation of SNS junctions (Benz, 1995), whereupon calculations by Kautz (1995) had given important hints for their realization (S: Superconductor, N: Normal metal).

The first practical 1 V arrays were realized by Benz et al (1997). A total of 32,768 SNS junctions containing PdAu as the normal metal were embedded into the middle of a coplanar waveguide transmission line (CPW) with an impedance of 50 Ω . The width of the constant-voltage steps exceeds 1 mA under microwave operation around 16 GHz. This low microwave frequency gives rise to a drawback of SNS junctions, namely the large number of junctions needed to reach the 1 V (32,000 junctions) or the 10 V level (300,000 junctions).

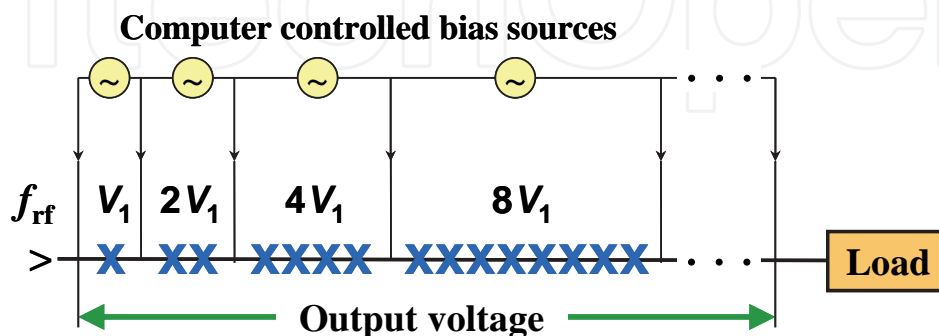

Fig. 4. Schematic design of a programmable Josephson voltage standard based on a binary-divided series array of Josephson junctions shown as X. The array is operated as multi-bit digital-to analogue converter.

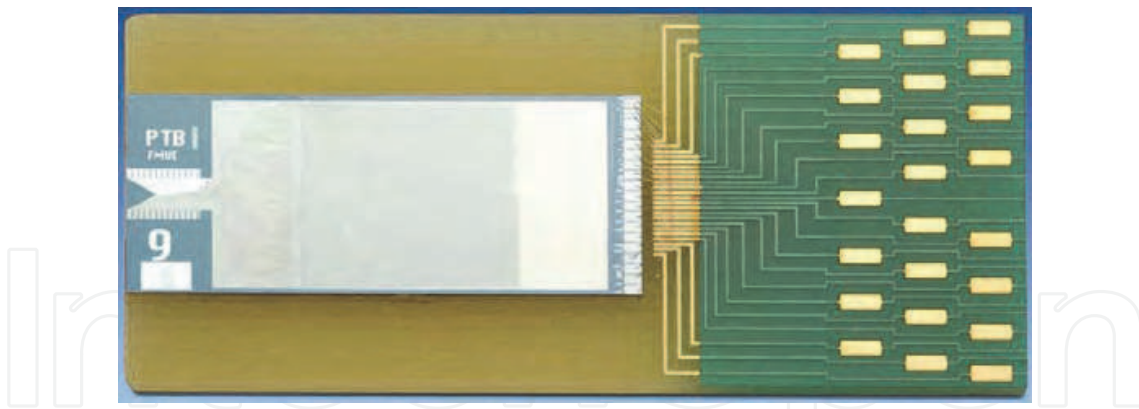

Fig. 5. Photo of a 10 V programmable Josephson junction series array.

This huge number of junctions causes enormous challenges for the microwave design and for the fabrication technology. The use of stacked junctions was subsequently investigated in order to handle this huge number of junctions. For example, arrays of double- and triple-stacked junctions containing MoSi_2 barriers were developed generating voltages up to 3.9 V (Chong et al, 2005).

Other kinds of junctions have therefore been investigated, in order to reach characteristic voltages of about $150 \mu\text{V}$ which allows operation at 70 GHz. A successful development has been SINIS junctions consisting of a multilayer superconductor-insulator-normal metal-insulator-superconductor originally investigated for electronic applications (Maezawa & Shoji, 1997; Sugiyama et al, 1997). The first small series arrays and 1 V arrays were subsequently fabricated (Schulze et al, 1998; Behr et al, 1999). The 1 V arrays contain 8,192 junctions. The first 10 V arrays consisting of 69,120 junctions were also developed shortly afterwards (Schulze et al, 2000) and later significantly improved (Mueller et al, 2007).

In spite of their successful use, a serious drawback of SINIS junctions is their sensitivity to particular steps during fabrication often resulting in a few shorted junctions of a SINIS series array (typically between 0 and 10 of 10,000 junctions) probably due to the very thin insulating oxide barriers (cf. Mueller et al, 2009). The search for more robust barrier materials led to an amorphous silicon layer doped with a metal such as niobium (Baek et al, 2006). The niobium content is tuned to a value near a metal-insulator transition observed at a niobium concentration of about 11.5% (Hertel et al, 1983). This region combining a high resistivity and a sufficient conductivity allows the fabrication of 1 V and 10 V arrays for operation at 70 GHz (Mueller et al, 2009). Fig. 5 shows a photo of a 10 V programmable Josephson junction series array. Measurements showed that a few 10 V arrays consisting of 69,632 junctions had been realized without any shorted junction, which was never achieved using SINIS junctions. Step widths above 1 mA have meanwhile been reached (cf. Fig. 6). This junction type currently enables the most reliable fabrication process.

Series arrays of junctions with an amorphous $\text{Nb}_x\text{Si}_{1-x}$ barrier were originally used for circuits operated around 15 GHz. Burroughs et al (2009a) developed 10 V arrays containing three-junction stacks with 268,800 junctions arranged in 32 parallel branches. Constant-voltage steps at 10 V were generated under microwave irradiation between about 18 GHz and 20 GHz. Tapered CPWs have been used in order to assure a homogeneous microwave power distribution along 8,400 junctions in each branch (Dresselhaus et al, 2009).

Some other kinds of junctions have also been investigated. While most Josephson arrays are operated in liquid helium at 4.2 K, Yamamori et al (2006) developed arrays for operation at

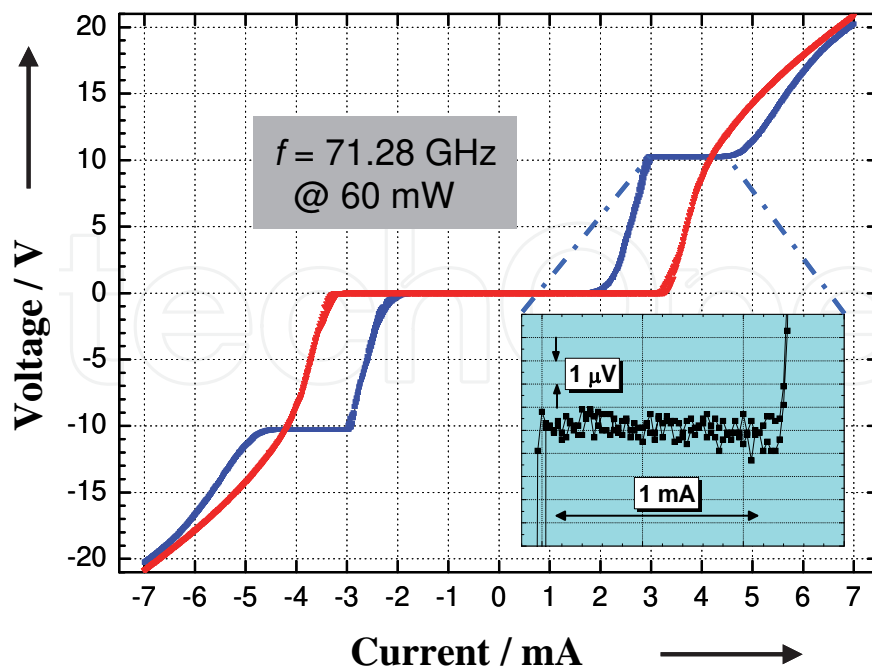

Fig. 6. Current-voltage characteristic of a 10 V programmable Josephson junction series array without (red) and with (blue) 70 GHz microwave irradiation. The inset shows the constant-voltage step at the 10 V level with high resolution.

temperatures around 10 K by using NbN for the superconducting layers and TiN for the barrier. The arrays consisting of more than 500,000 junctions for operation at 16 GHz generate voltages up to 17 V (Yamamori et al, 2008). Another version for 70 GHz operation is based on an improved design of 3315 externally shunted SIS junctions operated on the third-order constant-voltage step (Hassel et al, 2005). Recently 1 V SNIS arrays were developed by Lacquaniti et al (2011) using a slightly oxidized thick Al layer (up to 100 nm) as a barrier.

5.2 Applications using binary-divided programmable Josephson voltage standards

Conventional Josephson voltage standards are used for dc applications, namely to calibrate voltage references e.g. Weston elements or Zener references, and to measure the linearity of voltmeters. The Josephson voltage standards in many countries around the world have been verified by international comparisons. The Bureau International des Poids et Mesures (BIPM) developed a travelling Josephson voltage standard for performing direct comparisons, typically achieving uncertainties of 1 part in 10^{10} (Wood & Solve, 2009). The advantage of programmable Josephson voltage standards over conventional ones is given in the speed required to adjust a precise voltage. In direct comparisons using a null-detector at room temperature, the main uncertainty source is the type-A uncertainty from the null-detector's noise. In speeding up a comparison the uncertainty can be reduced by a factor \sqrt{n} where n is the number of polarity reversals. Using two programmable 10 V Josephson voltage standards, the polarity reversing procedure can be easily automated. This has been demonstrated (Palafox et al, 2009) with a type-A uncertainty of 3 parts in 10^{12} .

Binary-divided Josephson arrays were originally developed aiming at d/a converters with fundamental accuracy as a source for ac calibrations. Fig. 7 shows a step-wise approximated sine wave. It was tested to calibrate thermal transfer standards (Hamilton et al, 1995). The

synthesized waveforms contain small parts of undefined voltages during transients between well-defined quantized voltage levels. To improve achievable uncertainties, the transients have been made faster and faster, from 1 μs (Hamilton et al, 1997) to below 100 ns (Williams et al, 2007). Measurements on thermal transfer standards have shown possible uncertainties better than 1 $\mu\text{V}/\text{V}$ for frequencies below 200 Hz (Behr et al, 2005) but for higher frequencies transients dominate uncertainties. Different error analyses (Lee et al, 2009; Burroughs et al, 2009b) confirm that transients will make it very difficult to further improve the predictability of these quantized voltage sources as the transients depend on too many parameters like applied bias current, microwave power or helium levels in the dewar. The only way for further improvements seems to require specific assumptions for the device under test (Séron et al, 2011).

Due to this fundamental limitation from transients the idea came up of combining the stepwise approximated Josephson waveforms with sampling methods. In a first experiment, a sampling voltmeter was calibrated by sampling the quantized voltage levels (Ihlenfeld et al, 2005). Later stepwise approximated waveforms and sampling were used to demonstrate an ac quantum voltmeter measuring ac voltage differentially (Behr et al, 2007). Both methods are used nowadays to link a power standard directly to a quantum basis (Palafox et al, 2007 & 2009; Rüfenacht et al, 2009). By introducing faster sampling systems and pre-amplifiers for a wide range of ac applications like ac-dc transfer calibrations, this idea has been further improved. As here the Josephson system is acting as a voltage reference, it also allows combining it with an external ac source traced back or locked to the Josephson voltage (Rüfenacht et al, 2011). For certain applications this is favourable as ac sources can drive a current to low-impedance devices. Driving a current from a Josephson voltage standard is very limited as typically step widths are not much larger than 1 mA, accordingly the impedance must be larger than 10 k Ω for 10 V Josephson arrays.

Towards higher frequencies sampling methods are limited due to the bandwidth of a/d converters which are affected by fast voltage edges in stepwise approximated waveforms and a decreasing aperture time for raising frequencies. The frequency limit is determined by the number of samples taken for a period. When using rectangular waveforms, i.e. the

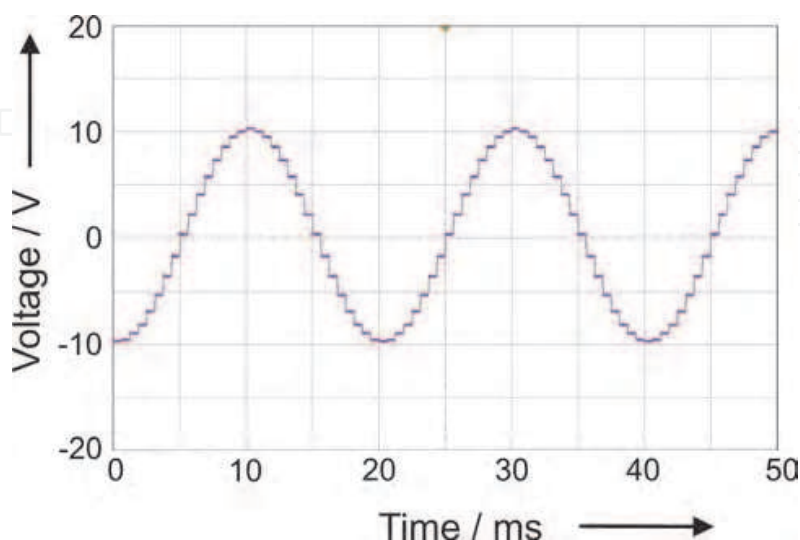

Fig. 7. Synthesis of a step-wise approximated 50 Hz sine wave using a 10 V Josephson junction series array.

minimum number of samples, frequencies up to 6 kHz have been used to calibrate impedance ratios (Lee et al, 2011), while typically 16 to 256 samples reduce the bandwidth to clearly below 1 kHz (Kim et al, 2010).

Another way to minimize the effect of transients is to use the rectangular waveforms and to just look at the fundamental tone of the waveform. Practically this is easy when a lock-in amplifier is used as a null-detector. Internally the lock-in amplifier multiplies the rectangular waveform with a sine wave heavily weighting the quantized plateaus and almost neglecting the transients (Jeanneret et al, 2010). The influence of the transients is suppressed to below parts in 10^8 which is being utilized fully for impedance ratio measurements (Lee et al, 2010).

However, the only way to completely avoid transients at all is to use the so-called pulse-driven Josephson arbitrary waveform synthesizer. This method is described in detail in the next paragraph.

5.3 Pulse-driven arrays

The interest in quantum-accurate ac waveform synthesis led to the development of another version of Josephson voltage standards for ac applications (Benz & Hamilton, 1996). Those Josephson voltage standards described so far are operated by sinusoidal microwaves in order to effect the transfer of flux quanta through Josephson junctions. This works well, if the operating frequency is close to the characteristic frequency of the junctions (cf. chapter 2 and equation (1); Kautz, 1992 & 1995). A modulation of the output voltage by changing the frequency of the irradiated microwaves over a wide frequency range is therefore not possible. Nevertheless, a direct time-dependent manipulation of the flux quanta transfer seems to be very promising for an ac voltage standard, in order to enable the synthesis of spectrally pure waveforms and to avoid those drawbacks related to the multi-bit d/a converter operation of binary-divided arrays.

Indeed, the limitations of sinusoidal operation do not appear, if Josephson junctions are operated by a train of short current pulses as shown first by calculations (Monaco, 1990). The width of the constant-voltage steps is nearly independent of the pulse repetition frequency between zero and the characteristic frequency, if rise and fall time of the pulses are short compared to the characteristic frequency (10 GHz corresponds to 100 ps). The train of pulses then determines the number of flux quanta transferred through the Josephson junctions at any time. The waveform to be generated is encoded in the pulse train. A high pulse repetition rate generates high voltages; the voltage decreases with decreasing pulse repetition rate. Fig. 8 schematically shows the principle of operation. Arbitrary output waveforms can be synthesized by modulating the pulse train using a pulse pattern generator; sometimes this version of pulse-driven Josephson arrays is therefore also called Josephson Arbitrary Waveform Synthesizer (JAWS).

The pulse train is typically created by the use of a second-order sigma-delta (SD) modulation (cf. Benz et al, 1998; Kieler et al, 2009). This procedure shifts the quantization noise to high frequencies; noise contributions are then removed by appropriate filtering. The Josephson junctions act as a quantizer due to the transfer of flux quanta. Spectrally pure waveforms are synthesized that way with higher harmonics suppressed by more than 100 dB (cf. Benz et al, 2009a; Kieler et al, 2009). The easiest way to prove perfect quantization of a synthesized signal is to generate and measure a sine wave, whose spectrum should show a single tone without any additional harmonics.

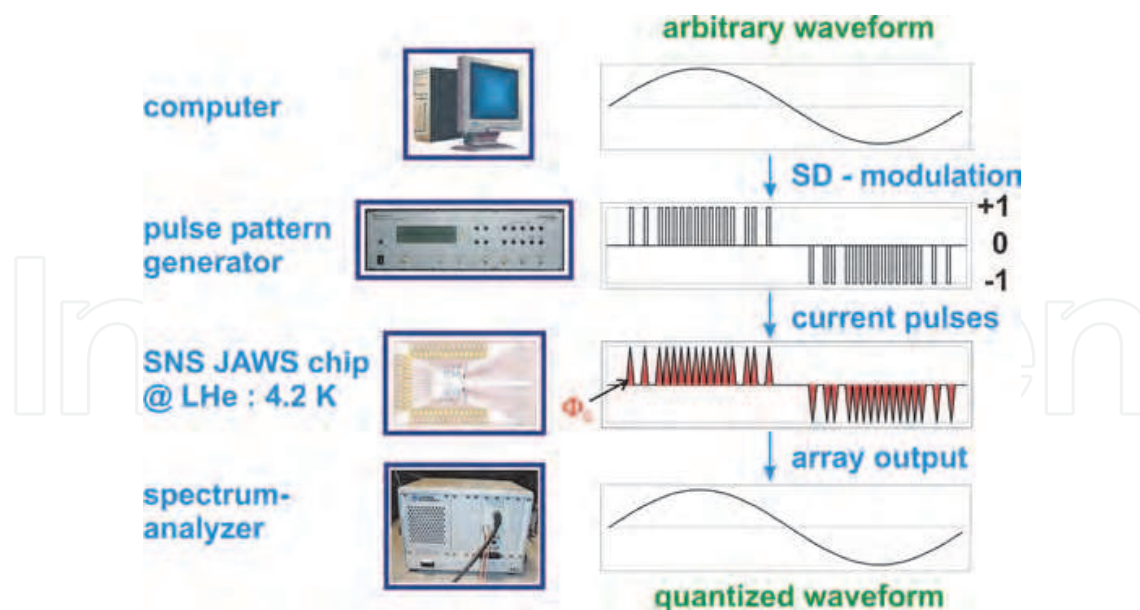

Fig. 8. Schematic of operation for pulse-driven arrays.

Pulse-driven arrays need overdamped Josephson junctions, which have predominantly been realized by SNS junctions. Different materials have been used for the barrier such as e.g. PdAu (Benz et al, 2001), HfTi (Hagedorn et al, 2006) or $\text{Nb}_x\text{Si}_{1-x}$ (Benz et al, 2007). SINIS junctions have also been investigated (Kohlmann et al, 2006).

Pulse-driven arrays were suggested and first demonstrated by Benz and Hamilton (1996). An array of 512 junctions generated constant-voltage steps up to $265 \mu\text{V}$ under operation by unipolar pulses with a repetition frequency up to 250 MHz. Continuous enhancements gradually improved the spectra of the synthesized signals and increased the output voltages. The first important steps ahead have been, amongst others: a code generator allowing a pulse repetition frequency of about 10 GHz (Benz et al, 1998) and the use of a bipolar drive signal (Benz et al, 1999). The overdamped Josephson junctions are embedded into the middle of a coplanar waveguide transmission line (CPW). As the pulses consist of broadband frequency components ranging from dc to about 30 GHz, a complicated microwave assembly is required in order to enable the transmission of these broadband signals.

The broadband pulse drive including dc and low-frequency components causes additional requirements in operation compared to sinusoidal driven arrays. The dc component must be delivered to the array, e.g. by a direct connection to the code generator. A resistive microwave termination at the end of the CPW would produce an unwanted common mode voltage; in order to avoid this common mode voltage, the initially used arrays were designed as lumped elements, whose junction series array are directly grounded. Finally, a simple splitting of the array in parallel microwave paths is not possible.

The configuration as lumped arrays, however, limits the length of the series array, which must be short compared to the wavelength λ of the highest significant frequency. A length of typically $\lambda/8$ ensures a uniform distribution of the high-frequency power comprised in the pulses to all junctions ($\lambda \approx 12 \text{ mm}$ for a frequency of 10 GHz within a CPW on a Si wafer). The number of junctions is therefore restricted to about 2,000 at most using sub- μm junction technology (Hagedorn et al, 2006). A promising suggestion for increasing the number of junctions is their arrangement within a meander-like structure as shown in Fig. 9 (Kieler et al, 2007a). Arrays containing more than 10,000 junctions were realized; the

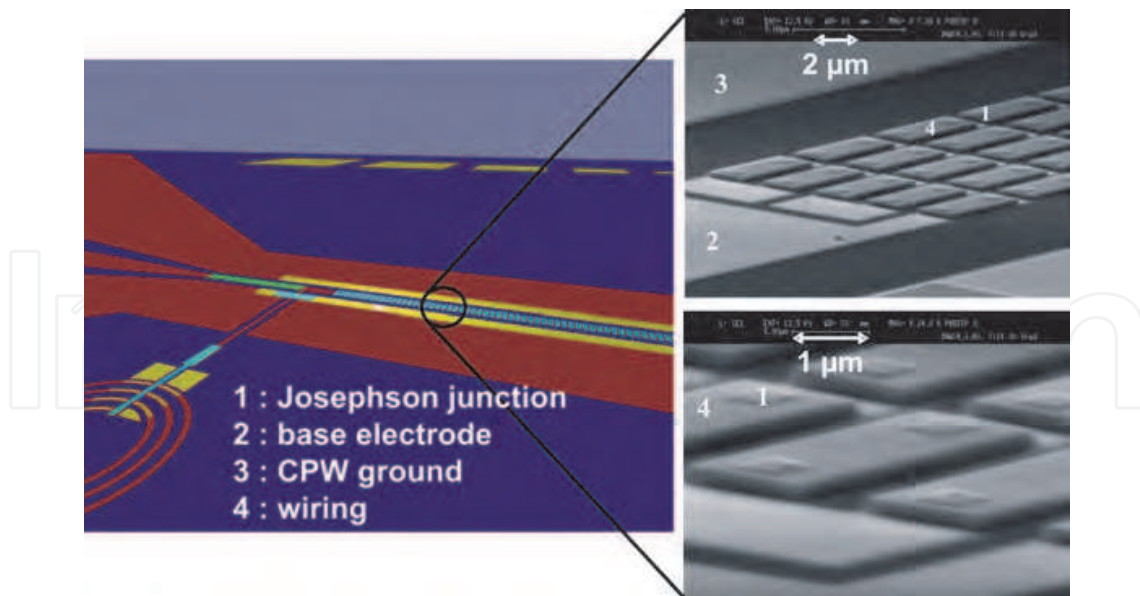

Fig. 9. Design of a Josephson junction series array for pulse drive (left). The scanning electron microscope pictures (right) show a part of the middle of the CPW containing Josephson junctions arranged in a meander-like structure.

synthesis of spectrally pure waveforms with low distortion has, however, been successful only in part so far (Kieler et al, 2007b).

A way of avoiding the limitations related to lumped arrays and of solving the common mode problem is the ac-coupling technique for the operation of Josephson arrays (Benz et al, 2001). Here, the broadband pulse drive is split into high-frequency and low-frequency signals (split around 10 MHz). While the high-frequency signal is capacitively coupled to the series array, the low-frequency part is separately applied by an additional compensation bias. A resistive microwave termination can now be placed at the end of the array without causing common-mode voltages. Therefore, extended series arrays can be used, which consequently enables a significant increase in the number of junctions. Further improvements resulted in output voltages up to 275 mV rms (Benz et al, 2009a). Two arrays containing 6,400 junctions each were simultaneously operated by using the data output and the complementary data output of the code generator, respectively. Higher harmonics are suppressed by more than 110 dB (Benz et al, 2007 & 2009a).

In spite of these very encouraging results the synthesis of voltages at 1 V or more remains very challenging. It will probably require a parallel operation of several arrays using adapted electronics (Benz et al, 1999 & 2009a) or the approach for the operation of multiple arrays that has been suggested by Kohlmann et al (2006). It is based on balanced photodiodes arranged at each array and operated by short optical pulses (Williams et al, 2004). The operation of Josephson arrays by optical pulses has also been investigated by Urano et al (2010).

The pulse train is typically provided by a commercial pulse pattern generator (bitstream generator). Fifteen years ago these generators just delivered unipolar pulses. As bipolar signals are preferred for metrological applications, and the peak-to-peak voltage is simply doubled, ways and means have been investigated to generate bipolar pulse trains even with unipolar pulses. The initially used procedure for this purpose is the suitable superposition of a high-frequency sine wave and a two-level digital signal as first proposed by Benz et al

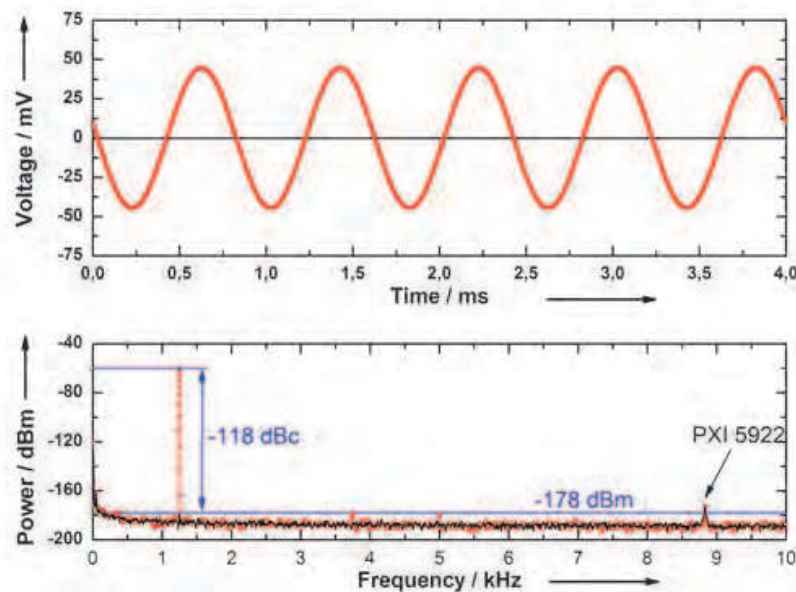

Fig. 10. Synthesized 1.25 kHz sine wave (top) and its frequency spectrum (bottom). Higher harmonics are suppressed by 118 dBc. The small signal at about 8.8 kHz is not related to the synthesized signal, as it is also present at the noise level when no waveform is synthesized.

(1999). Today the direct generation of bipolar pulses using a three-level code generator is easy as corresponding instruments have recently been made available (van den Brom et al, 2008). Now the measurement setup is less complex (cf. Fig. 8) and more temporally stable when this three-level code generator is used (van den Brom et al, 2007 & 2008). Different waveforms were synthesized over a wide frequency range from about 150 Hz to above 100 kHz using arrays containing nearly 4,800 junctions; higher harmonics are suppressed up to 118 dBc (Kieler et al, 2010). In addition, the operation margins of the arrays were significantly improved, and 200 mV (rms) signals at 1 kHz were synthesized by simultaneously operating two arrays containing 5120 junctions each (Houtzager et al, 2009).

A comparison between the output voltages of a pulse-driven and a binary divided Josephson voltage standard at 8 mV showed an excellent agreement of both systems within a relative deviation of $5 \cdot 10^{-7}$ (Kohlmann et al, 2009).

The arbitrary perfect waveforms synthesized by pulse-driven arrays are useful for different metrological applications. First of all, pulse-driven arrays were used as synthesizers for arbitrary waveforms up to 100 kHz with very pure frequency spectra and quantum-accurate voltages (cf. Benz et al, 2009a; Houtzager et al, 2009; Kieler et al, 2009). Then, pulse-driven arrays were utilized for calibrations of thermal converters and transfer standards, which are well-established devices in ac metrology (cf. Lipe et al, 2008; Benz et al, 2009a). Single- or multi-tone signals were, in addition, used for the characterization of electronic components like filters or a/d converters (cf. Toonen and Benz, 2009). The use of pulse-driven arrays was also suggested in combination with a binary-divided array; the spectrum of the pulse-driven array is adjusted to modify the spectrum of the 1 V or 10 V signal generated by the binary divided array (Kohlmann et al, 2007). In addition, pulse-driven arrays provide the opportunity for synthesizing a calculable pseudo-noise waveform consisting of a comb of random-phase harmonics each having identical voltage amplitude. A low-voltage version of this noise source is used in a quantum-based Johnson noise thermometry system to measure the voltage noise of the resistor, and thus its temperature (Benz et al, 2009b).

6. Conclusions

100 years after the discovery of superconductivity and nearly 50 years after the discovery of the Josephson effect, Josephson voltage standards play an essential role in electrical metrology and high-precision voltage measurements. The significant progress of the fabrication technology has been a major prerequisite for the development of large series arrays for Josephson voltage standards containing tens of thousands Josephson junctions. Conventional 10 V Josephson voltage standards are well established for dc measurements and commercially available. Programmable voltage standards opened up the world of ac applications and have, hence, been the next step in the exciting story of the applications of the Josephson effect in metrology. While 1 V arrays are meanwhile fabricated routinely, the first 10 V arrays containing tens or even hundreds of thousands of Josephson junctions are now available. Conventional Josephson voltage standards will be replaced in the future more and more by these programmable Josephson voltage standards, as they are easier to operate and provide exciting additional possibilities and applications. The synthesis of real quantum-based ac voltages is enabled by pulse-driven arrays. Very promising results have been achieved; output voltages of about 275 mV were synthesized with higher harmonics suppressed by about 120 dBc. However, the aim to generate 1 V ac voltages is very challenging due to the complex operation by short current pulses. The value of ac Josephson voltage standards has successfully been demonstrated in initial experiments. Further developments will establish these Josephson voltage standards as a quantum basis for ac metrology.

7. Acknowledgment

The authors would like to thank the Josephson voltage standard team at PTB.

The work within this EURAMET joint research project leading to these results was supported in part by the European Community's Seventh Framework Programme, ERA-NET Plus, under Grant Agreement 217257 (JoSy project).

8. References

- Anders, S.; Blamire, M.G.; Buchholz, F.-Im. et al (2010). European roadmap on superconductive electronics – status and perspectives. *Physica C*, Vol.470, No.23-24, (December 2010) pp. 2079-2126
- Baek, B.; Dresselhaus, P.D. & Benz, S.P. (2006). Co-sputtered amorphous $\text{Nb}_x\text{Si}_{1-x}$ barriers for Josephson-junction circuits. *IEEE Transactions on Applied Superconductivity*, Vol.16, No.4 (December 2006) pp. 1966-1970
- Bardeen, J.; Cooper, L.N. & Schrieffer, J.R. (1957). Theory of Superconductivity. *Physical Review*, Vol. 108, No. 5, (December 1957) pp. 1175-1204
- Barone A. & Paterno G. (1982). Physics and applications of Josephson effect, John Wiley & Sons, ISBN 0-471-01469-9, New York, USA
- Behr, R.; Schulze, H.; Müller, F.; Kohlmann, J. & Niemeyer J. (1999). Josephson arrays at 70 GHz for conventional and programmable voltage standards. *IEEE Transactions on Instrumentation and Measurement*, Vol.48, No.2, (April 1999) pp. 270-273
- Behr, R.; Müller, F. & Kohlmann, J. (2002). Josephson junction arrays for voltage standards, In: *Studies of Josephson junction arrays II: Studies of high temperature superconductors*,

- Vol.40, A.V. Narlikar (Ed.), 155-184, Nova Science Publishers, ISBN 1-59033-204-0, Hauppauge, NY, USA
- Behr, R.; Williams, J.M.; Patel, P.; Janssen, T.J.B.M.; Funck, T. & Klonz, M. (2005). Synthesis of precision AC waveforms using a SINIS Josephson junction array. *IEEE Transactions on Instrumentation and Measurement*, Vol.54, No.2, (April 2005) pp. 612-615
- Behr, R.; Palafox L.; Ramm G.; Moser H. & Melcher, J. (2007). Direct comparison of Josephson waveforms using an AC quantum voltmeter. *IEEE Transactions on Instrumentation and Measurement*, Vol.56, No.2, (April 2007) pp. 235-238
- Benz, S.P. (1995). Superconductor-normal-superconductor junctions for programmable voltage standards. *Applied Physics Letters*, Vol.67, No.18, (October 1995) pp. 2714-2716
- Benz, S.P. & Hamilton, C.A. (1996). A pulse-driven programmable Josephson voltage standard. *Applied Physics Letters*, Vol.68, No.22, (May 1996) pp. 3171-3173
- Benz, S.P.; Hamilton, C.A.; Burroughs, C.J.; Harvey, T.E. & Christian, L.A. (1997). Stable 1-volt programmable voltage standard. *Applied Physics Letters*, Vol.71, No.13, (September 1997) pp. 1866-1868
- Benz, S.P.; Hamilton, C.A.; Burroughs, C.J.; Harvey, T.E.; Christian, L.A. & Przybysz, J.X. (1998). Pulse-driven Josephson digital/analog converter. *IEEE Transactions on Applied Superconductivity*, Vol.8, No.2, (June 1998) pp. 42-47
- Benz, S.P.; Hamilton, C.A.; Burroughs, C.J. & Harvey, T.E. (1999). AC and DC bipolar voltage source using quantized pulses. *IEEE Transactions on Instrumentation and Measurement*, Vol.48, No.2, (April 1999) pp. 266-269
- Benz, S.P.; Burroughs, C.J. & Dresselhaus, P.D. (2001). AC coupling technique for Josephson waveform synthesis. *IEEE Transactions on Applied Superconductivity*, Vol.11, No.1, (March 2001) pp. 612-616
- Benz, S.P. & Hamilton, C.A. (2004). Application of the Josephson effect to voltage metrology. *Proceedings of the IEEE*, Vol.92, No.10, (October 2004) pp. 1617-1629
- Benz, S.P.; Dresselhaus, P.D.; Burroughs, C.J. & Bergren, N.F. (2007). Precision measurements using a 300 mV Josephson arbitrary waveform synthesizer. *IEEE Transactions on Applied Superconductivity*, Vol.17, No.2, (June 2007) pp. 864-869
- Benz, S.P.; Dresselhaus, P.D.; Rüfenacht, A.; Bergren, N.F.; Kinard, J.R. & Landim, R.P. (2009a). Progress toward a 1 V pulse-driven AC Josephson voltage standard. *IEEE Transactions on Instrumentation and Measurement*, Vol.58, No.4, (April 2009) pp. 838-843
- Benz, S.P.; Jifeng Qu; Rogalla, H.; White, D.R.; Dresselhaus, P.D.; Tew, W.L. & Sae Woo Nam (2009b). Improvements in the NIST Johnson noise thermometry system. *IEEE Transactions on Instrumentation and Measurement*, Vol.58, No.4, (April 2009) pp. 884-890
- van den Brom, H.E.; Houtzager, E.; Chevtchenko, O.; Wende, G.; Schubert, M.; May, T.; Meyer, H.-G.; Kieler, O. & Kohlmann, J. (2007). Synthesis of sinusoidal signals with a Josephson arbitrary waveform synthesizer. *Superconductor Science and Technology*, Vol.20, No.5 (May 2007) pp. 413-417
- van den Brom, H.E.; Houtzager, E.; Brinkmeier, B.E.R. & Chevtchenko, O.A. (2008). Bipolar pulse-drive electronics for a Josephson arbitrary waveform synthesizer. *IEEE Transactions on Instrumentation and Measurement*, Vol.57, No.2, (February 2008) pp. 428-431

- Burroughs, C.J.; Rüfenacht, A.; Dresselhaus, P.D.; Benz, S.P. & Elsbury, M.M. (2009a). A 10 Volt “turnkey” programmable Josephson voltage standard for DC and stepwise-approximated waveforms. *NCSLI Measure*, Vol.4, No.3, (September 2009) pp. 70-75
- Burroughs, C.J.; Rüfenacht, A.; Benz, S.P. & Dresselhaus, P.D. (2009b). Systematic error analysis of stepwise-approximated AC waveforms generated by programmable Josephson voltage standards. *IEEE Transactions on Instrumentation and Measurement*, Vol.58, No.2, (April 2009) pp. 761-767
- Chong, Y.; Burroughs, C.J.; Dresselhaus, P.D.; Hadacek, N.; Yamamori, H. & Benz, S.P. (2005). Practical high-resolution programmable Josephson voltage standards using double- and triple-stacked MoSi₂-barrier junctions. *IEEE Transactions on Applied Superconductivity*, Vol.15, No.2, (June 2005) pp. 461-464
- Dresselhaus, P.D.; Elsbury, M.M. & Benz, S.P. (2009). Tapered transmission lines with dissipative junctions. *IEEE Transactions on Applied Superconductivity*, Vol.19, No.3, (June 2009) pp. 993-998
- Gurvitch, M.; Washington, M.A. & Huggins, H.A. (1983). High quality refractory Josephson tunnel junctions utilizing thin aluminum layers. *Applied Physics Letters*, Vol.42, No.5, (March 1983) pp. 472-474
- Hagedorn, D.; Kieler, O.; Dolata, R.; Behr, R.; Müller, F.; Kohlmann, J. & Niemeyer, J. (2006). Modified fabrication of planar sub- μm superconductor-normal metal-superconductor Josephson junctions for use in a Josephson Arbitrary Waveform Synthesizer. *Superconductor Science and Technology*, Vol.19, No.4, (April 2006) pp. 294-298
- Hamilton, C.A.; Burroughs, C.J. & Kautz, R.L. (1995). Josephson D/A converter with fundamental accuracy. *IEEE Transactions on Instrumentation and Measurement*, Vol.44, No.2, (April 1995) pp. 223-225
- Hamilton, C.A.; Burroughs, C.J.; Benz, S.P. & Kinard, J.R. (1996). AC Josephson voltage standard: progress report. *IEEE Transactions on Instrumentation and Measurement*, Vol.46, No.2, (April 1997) pp. 224-228
- Hamilton, C.A. (2000). Josephson voltage standards. *Review of Scientific Instruments*, Vol.71, No.10, (October 2000) pp. 3611-2623
- Hassel, J.; Helistö, P.; Grönberg, L.; Seppä, H.; Nissilä, J. & Kemppinen, A. (2005). Stimulated power generation in ES-SIS junction arrays. *IEEE Transactions on Instrumentation and Measurement*, Vol.54, No.2, (April 2005) pp. 632-635
- Hertel, G.; Bishop, D.J.; Spencer, E.G.; Rowell, J.M. & Dynes, R.C. (1983). Tunneling and transport measurements at the metal-insulator transition of amorphous Nb:Si. *Physical Review Letters*, Vol.50, No.10, (March 1983) pp. 743-746
- Houtzager, E.; Benz, S.P. & van den Brom, H.E. (2009). Operating margins for a pulse-driven Josephson arbitrary waveform synthesizer using a ternary bit-stream generator. *IEEE Transactions on Instrumentation and Measurement*, Vol.58, No.4, (April 2009) pp. 775-780
- Ihlenfeld, W.G.K.; Mohns, E.; Behr, R.; Williams, J.M.; Patel, P.; Ramm G. & Bachmair, H. (2005). Characterization of a high-resolution analogue-to-digital converter with an AC Josephson voltage source. *IEEE Transactions on Instrumentation and Measurement*, Vol.54, No.2, (April 2005) pp. 649-652
- Jeanneret, B. & Benz, S.P. (2009). Applications of the Josephson effect in electrical metrology. *The European Physical Journal Special Topics*, Vol.172, (June 2009) pp. 181-206

- Jeanneret, B.; Overney, F.; Rüfenacht, A. & Nissilä, J. (2010). Strong attenuation of the transients' effect in square waves synthesized with a programmable Josephson voltage standard. *IEEE Transactions on Instrumentation and Measurement*, Vol.59, No.7, (July 2010) pp. 1894-1899
- Josephson, B.D. (1962). Possible new effects in superconducting tunneling. *Physics Letters*, Vol.1, No.7, (July 1962) pp. 251-253
- Josephson, B.D. (1965). Supercurrents through barriers. *Advances in Physics*, Vol.14, No.56, (October 1965) pp. 419-451
- Kadin, A.M. (1999). Introduction to superconducting circuits, Wiley, ISBN 0-471-31432-3, New York, USA
- Kautz, R.L. (1992). Design and operation of series-array Josephson voltage standards, In: *Metrology at the Frontiers of Physics and Technology*, L. Crovini and T.J. Quinn, (Eds.), 259-296, North-Holland, ISBN 0-444-89770-4, Amsterdam, The Netherlands
- Kautz, R.L. (1995). Shapiro steps in large-area metallic-barrier Josephson junctions. *Journal of Applied Physics*, Vol.78, No. 9, (November 1995) pp. 5811-5819
- Kieler, O.F.; Kohlmann, J.; Behr, R.; Müller, F.; Palafox, L. & Niemeyer, J. (2007a) SNS Josephson junction series arrays for the Josephson arbitrary waveform synthesizer. *IEEE Transactions on Applied Superconductivity*, Vol.17, No.2, (June 2007) pp. 187-190
- Kieler, O.F.; Kohlmann, J. & Müller, F. (2007b). Improved design of superconductor/normal conductor/superconductor Josephson junction series arrays for an ac Josephson voltage standard. *Superconductor Science and Technology*, Vol.20, No.11, (November 2007) pp. S318-S322
- Kieler, O.F.; Iuzzolino, R. & Kohlmann, J. (2009). Sub- μm SNS Josephson junction arrays for the Josephson arbitrary waveform synthesizer. *IEEE Transactions on Applied Superconductivity*, Vol.19, No.3, (June 2009) pp. 230-233
- Kieler, O.F.; Schleussner, D.; Kohlmann, J. & Behr, R. (2010). Josephson arbitrary waveform synthesizer for analysis of AC components, In: *2010 Conference on Precision Electromagnetic Measurements (CPEM 2010)*, Yang Sup Song (Ed.), 157-158, Institute of Electrical and Electronic Engineers, ISBN 978-1-4244-6794-5, Piscataway, NJ, USA
- Kim, M.-S.; Kim, K.-T.; Kim, W.S.; Chong, Y. & Kwon, S.-W. (2010). Analog-to-digital conversion for low frequency waveforms based on the Josephson voltage standard. *Measurement Science and Technology*, Vol.21, No.11, (November 2010) 115102 (6 pp.)
- Kohlmann, J.; Behr, R. & Funck, T. (2003). Josephson voltage standards. *Measurement Science and Technology*, Vol.14, No.8, (August 2003) pp. 1216-1228
- Kohlmann, J.; Müller, F.; Behr, R.; Hagedorn, D.; Kieler, O.; Palafox, L. & Niemeyer, J. (2006). Development of Josephson junction series arrays for synthesis of AC voltages and arbitrary waveforms. *Journal of Physics: Conference Series*, Vol.43, No.1, (2006) pp. 1385-1388
- Kohlmann, J.; Müller, F.; Kieler, O.; Behr, R.; Palafox, L.; Kahmann, M. & Niemeyer, J. (2007). Josephson series arrays for programmable 10-V SINIS Josephson voltage standards and for Josephson arbitrary waveform synthesizers based on SNS junctions. *IEEE Transactions on Instrumentation and Measurement*, Vol.56, No.2, (April 2007) pp. 472-475
- Kohlmann, J.; Kieler, O.F.; Iuzzolino, R.; Lee, J.; Behr, R.; Egeling, B. & Müller, F. (2009). Development and investigation of SNS Josephson arrays for the Josephson arbitrary waveform synthesizer.

- trary waveform synthesizer. *IEEE Transactions on Instrumentation and Measurement*, Vol.58, No.4, (April 2009) pp. 797-802
- Lacquaniti, V.; De Leo, N.; Fretto, M.; Sosso, A.; Müller F. & Kohlmann, J. (2011). 1 V programmable voltage standards based on SNIS Josephson junction series arrays. *Superconductor Science and Technology*, Vol.24, No.4, (April 2011) 045004 (4 pp.)
- Lee, J.; Behr, R.; Katkov, A. & Palafox, L. (2009). Error contributions in stepwise synthesized Josephson sine waves. *IEEE Transactions on Instrumentation and Measurement*, Vol.58, No.2, (April 2009) pp. 803-808
- Lee, J.; Schurr, J.; Nissilä, J.; Palafox, L. & Behr, R. (2010). The Josephson two-terminal-pair impedance bridge. *Metrologia* Vol. 47, No.4, (August 2010) pp. 453-459
- Lee, J.; Schurr, J.; Nissilä, J.; Palafox, L.; Behr, R. & Kibble, B. (2011). Impedance measurements with programmable Josephson systems. *IEEE Transactions on Instrumentation and Measurement*, to be published (2011)
- Levinson, M.T.; Chiao, R.Y.; Feldman, M.J. & Tucker, B.A. (1977). An inverse ac Josephson effect voltage standard. *Applied Physics Letters*, Vol.31, No.11, (December 1977) pp. 776-778
- Likharev, K.K. (1986). Dynamics of Josephson junctions and circuits, Gordon & Breach, ISBN 2-881-24042-9, New York, USA
- Lipe, T.E.; Kinard, J.R.; Tang, Y.-H.; Benz, S.P.; Burroughs, C.J. & Dresselhaus, P.D. (2008). Thermal voltage converter calibrations using a quantum ac standard. *Metrologia*, Vol.45, No.3, (June 2008) pp. 275-280
- Maezawa, M. & Shoji, A. (1997). Overdamped Josephson junctions with Nb/AlO_x/Al/AlO_x/Nb structure for integrated circuit application. *Applied Physics Letters*, Vol.70, No.26, (June 1997) pp. 3603-3605
- McCumber, D.E. (1968). Effect of ac impedance on dc voltage-current characteristics of superconductor weak-link junctions. *Journal of Applied Physics*, Vol.39, No. 7, (June 1968) pp. 3113-3118
- Monaco, R. (1990). Enhanced ac Josephson effect. *Journal of Applied Physics*, Vol.68, No.2, (July 1990) pp. 679-687
- Mueller, F.; Behr, R.; Palafox, L.; Kohlmann, J.; Wendisch, R. & Krasnopolin, I. (2007). Improved 10 V SINIS series arrays for applications in AC voltage metrology. *IEEE Transactions on Applied Superconductivity*, Vol.17, No.2, (June 2007) pp. 649-652
- Mueller, F.; Behr, R.; Weimann, T.; Palafox, L.; Olaya, D.; Dresselhaus, P.D. & Benz, S.P. (2009). 1 V and 10 V SNS programmable voltage standards for 70 GHz. *IEEE Transactions on Applied Superconductivity*, Vol.19, No.3, (June 2009) pp. 981-986
- Niemeyer, J.; Hinken, J.H. & Kautz, R.L. (1984). Microwave-induced constant voltage steps at one volt from a series array of Josephson junctions. *Applied Physics Letters*, Vol.45, No.4, (August 1984) pp. 478-480
- Niemeyer, J.; Sakamoto, Y.; Vollmer, E.; Hinken, J.H.; Shoji, A.; Nakagawa, H.; Takada, S. & Kosaka, S. (1986). Nb/Al-oxide/Nb and NbN/MgO/NbN tunnel junctions in large series arrays for voltage standards. *Japanese Journal of Applied Physics*, Vol.25, No.5, (May 1986) pp. L343-L345
- Niemeyer, J. (1998). Josephson voltage standards, In: *Handbook of Applied Superconductivity*, B. Seeber, (Ed.), 1813-1834, Institute of Physics Publishing, ISBN 0-750-30377-8, Bristol, UK

- Palafox, L.; Ramm, G.; Behr, R.; Kürten Ihlenfeld, W.G. & Moser H. (2007). Primary AC power standard based on programmable Josephson arrays. *IEEE Transactions on Instrumentation and Measurement*, Vol.56, No.2, (April 2007) pp. 534-537
- Palafox, L.; Behr, R.; Ihlenfeld, W.G.K.; Müller, F.; Mohns, E.; Seckelmann, M. & Ahlers, F. (2009). The Josephson effect based primary power standard at PTB: progress report. *IEEE Transactions on Instrumentation and Measurement*, Vol.58, No.4, (April 2009) pp. 1049-1053
- Rogalla, H. (1998). Josephson junctions, In: *Handbook of Applied Superconductivity*, B. Seeber, (Ed.), 1759-1775, Institute of Physics Publishing, ISBN 0-750-30377-8, Bristol, UK
- Rüfenacht, A.; Burroughs, C.J.; Benz, S.P.; Dresselhaus, P.D.; Waltrip, B. & Nelson, T.L. (2009). Precision differential sampling measurements of low-frequency synthesized sine waves with an AC programmable Josephson voltage standard. *IEEE Transactions on Instrumentation and Measurement*, Vol.58, No.4, (April 2009) pp. 809-815
- Rüfenacht, A.; Overney, F.; Mortara, A. & Jeanneret, B. (2011). Thermal transfer standard validation of the Josephson-voltage-standard-locked sine wave synthesizer. *IEEE Transactions on Instrumentation and Measurement*, to be published (2011)
- Schubert, M.; Fritsch, L.; Wende, G. & Meyer H.-G. (2001a). SNS junction on Nb-Ti base for microwave circuits. *IEEE Transactions on Applied Superconductivity*, Vol.11, No.1, (March 2001) pp. 1066-1069
- Schubert, M.; May, T.; Wende, G.; Fritsch, L. & Meyer, H.-G. (2001b). Coplanar strips for Josephson voltage standard circuits. *Applied Physics Letters*, Vol.79, No.7, (August 2001) pp. 1009-1011
- Schulze, H.; Behr, R.; Müller, F. & Niemeyer, J. (1998). Nb/Al/AlO_x/Al/AlO_x/Al/Nb Josephson junctions for programmable voltage standards. *Applied Physics Letters*, Vol.73, No.7, (August 1998) pp. 996-998
- Schulze, H.; Müller, F.; Behr, R.; Kohlmann, J.; Niemeyer, J. & Balashov, D. (1999). SINIS Josephson junctions for programmable Josephson voltage standard circuits. *IEEE Transactions on Applied Superconductivity*, Vol.9, No.2, (June 1999) pp. 4241-4244
- Schulze, H.; Behr, R.; Kohlmann, J.; Müller, F. & Niemeyer, J. (2000). Design and fabrication of 10 V SINIS Josephson arrays for programmable voltage standards. *Superconductor Science and Technology*, Vol.13, No.9, (September 2000) pp. 1293-1295
- Semenov, V.K. & Polyakov, Yu.A. (2001). Circuit improvements for a voltage multiplier. *IEEE Transactions on Applied Superconductivity*, Vol.11, No.1, (March 2001) pp. 550-553
- Séron, O.; Budovsky, I.; Djordjevic, S.; Hagen, T.; Behr, R. & Palafox L. (2011). Precision AC-DC transfer measurements with a Josephson waveform synthesizer and a buffer amplifier. *IEEE Transactions on Instrumentation and Measurement*, to be published (2011)
- Shapiro, S. (1963). Josephson currents in superconducting tunneling: The effect of microwaves and other observations. *Physical Review Letters*, Vol.11, No.2, (July 1963) pp. 80-82
- Stewart, W.C. (1968). Current-voltage characteristics of Josephson junctions. *Applied Physics Letters*, Vol.22, No.8, (April 1968) pp. 277-280
- Sugiyama, H.; Yanada A.; Ota, M.; Fujimaki, A. & Hayakawa, H. (1997). Characteristics of Nb/AlO_x/Al/AlO_x/Nb junctions based on the proximity effect. *Japanese Journal of Applied Physics*, Vol.36, No.9A/B (September 1997) pp. L1157-L1160

- Toonen, R.C. & Benz, S.P. (2009). Nonlinear behavior of electronic components characterized with precision multitones from a Josephson arbitrary waveform synthesizer. *IEEE Transactions on Applied Superconductivity*, Vol.19, No.3, (June 2009) pp. 715-718
- Urano, C.; Maruyama, M.; Kaneko, N.; Yamamori, H.; Shoji, A.; Maezawa, M.; Hashimoto, Y.; Suzuki, H.; Nagasawa, S.; Satoh, T.; Hidaka, M. & Kiryu, S. (2010). A new coding technique in serial data transmission and demodulation with Josephson junctions array. *Journal of Physics: Conference Series*, Vol.234, No. 4, (2010) 042037 (5 pp.)
- Williams, J.M.; Janssen, T.J.B.M.; Palafox, L.; Humphreys, D.A.; Behr, R.; Kohlmann, J. & Müller, F. (2004). The simulation and measurement of the response of Josephson junctions to optoelectronically generated short pulses. *Superconductor Science and Technology*, Vol.17, No.6, (June 2004) pp. 815-818
- Williams, J.M.; Henderson, D.; Patel, P.; Behr, R. & Palafox L. (2007). Achieving sub-100 ns switching of programmable Josephson arrays. *IEEE Transactions on Instrumentation and Measurement*, Vol.56, No.2, (April 2007) pp. 651-654
- Wood, B. & Solve, S. (2009). A review of Josephson comparison results. *Metrologia*, Vol.46, No.6, (December 2009) pp. R13-R20
- Yamamori, H.; Ishizaki, M.; Shoji, A.; Dresselhaus, P. D. & Benz, S. P. (2006). 10 V programmable Josephson voltage standard circuits using NbN/TiN_x/NbN/TiN_x/NbN double-junction stacks. *Applied Physics Letters*, Vol.88, No.4, (January 2006) 042503 (3pp.)
- Yamamori, H.; Yamada, T.; Sasaki, H. & Shoji, A. (2008). A 10 V programmable Josephson voltage standard circuit with a maximum output voltage of 20 V. *Superconductor Science and Technology*, Vol.21, No.10, (October 2008) pp. 105007 (6 pp.)
- Yoshida, H. (2000). Application of the ac Josephson effect for precise measurements. *IEICE Transactions on Electronics*, Vol.E83-C, No.1, (January 2000) pp. 20-26

IntechOpen

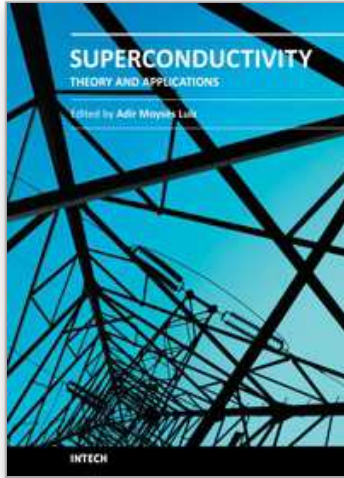

Superconductivity - Theory and Applications

Edited by Dr. Adir Luiz

ISBN 978-953-307-151-0

Hard cover, 346 pages

Publisher InTech

Published online 18, July, 2011

Published in print edition July, 2011

Superconductivity was discovered in 1911 by Kamerlingh Onnes. Since the discovery of an oxide superconductor with critical temperature (T_c) approximately equal to 35 K (by Bednorz and Müller 1986), there are a great number of laboratories all over the world involved in research of superconductors with high T_c values, the so-called “High- T_c superconductors”. This book contains 15 chapters reporting about interesting research about theoretical and experimental aspects of superconductivity. You will find here a great number of works about theories and properties of High- T_c superconductors (materials with $T_c > 30$ K). In a few chapters there are also discussions concerning low- T_c superconductors ($T_c < 30$ K). This book will certainly encourage further experimental and theoretical research in new theories and new superconducting materials.

How to reference

In order to correctly reference this scholarly work, feel free to copy and paste the following:

Johannes Kohlmann and Ralf Behr (2011). Development of Josephson voltage standards, Superconductivity - Theory and Applications, Dr. Adir Luiz (Ed.), ISBN: 978-953-307-151-0, InTech, Available from: <http://www.intechopen.com/books/superconductivity-theory-and-applications/development-of-josephson-voltage-standards>

INTECH
open science | open minds

InTech Europe

University Campus STeP Ri
Slavka Krautzeka 83/A
51000 Rijeka, Croatia
Phone: +385 (51) 770 447
Fax: +385 (51) 686 166
www.intechopen.com

InTech China

Unit 405, Office Block, Hotel Equatorial Shanghai
No.65, Yan An Road (West), Shanghai, 200040, China
中国上海市延安西路65号上海国际贵都大饭店办公楼405单元
Phone: +86-21-62489820
Fax: +86-21-62489821

© 2011 The Author(s). Licensee IntechOpen. This chapter is distributed under the terms of the [Creative Commons Attribution-NonCommercial-ShareAlike-3.0 License](https://creativecommons.org/licenses/by-nc-sa/3.0/), which permits use, distribution and reproduction for non-commercial purposes, provided the original is properly cited and derivative works building on this content are distributed under the same license.

IntechOpen

IntechOpen