

We are IntechOpen, the world's leading publisher of Open Access books Built by scientists, for scientists

5,300

Open access books available

130,000

International authors and editors

155M

Downloads

Our authors are among the

154

Countries delivered to

TOP 1%

most cited scientists

12.2%

Contributors from top 500 universities



WEB OF SCIENCE™

Selection of our books indexed in the Book Citation Index
in Web of Science™ Core Collection (BKCI)

Interested in publishing with us?
Contact book.department@intechopen.com

Numbers displayed above are based on latest data collected.
For more information visit www.intechopen.com



Dendritic Cell Endocytosis Essential for Viruses and Vaccines

Kenneth C. McCullough and Rajni Sharma

Additional information is available at the end of the chapter

<http://dx.doi.org/10.5772/67779>

Abstract

Protective immune defences are dependent upon critical roles played by dendritic cells (DCs), rendering them important targets for both vaccine delivery and virus infection. Studies in these areas led to successful development of targeted vaccine delivery, including synthetic virus-like particle (SVLP) and nanoparticulate RNA vaccines. A major consideration is DC endocytosis, whereby the different endocytic routes influencing the outcome. Rapid clathrin-mediated endocytosis likely favours degradative pathways. Slower processes such as macropinocytosis, caveolar endocytosis and retrograde transport to endoplasmic reticulum relate more to the processing rates leading to antigen presentation by DCs. These pathways are also influential in promoting the initiation of virus replication following infection. DC endocytosis of RNA viruses and RNA vaccines must lead to cytosolic translocation of the RNA for translation, relating to the process of antigen cross-presentation. One can learn from observations on both virus infections and cross-presentation for delivering RNA vaccines. Accordingly, recent advances in nanoparticulate delivery have been applied with self-amplifying replicon RNA (RepRNA), providing efficient delivery to DCs and promoting replicon-encoded antigen translation. Through realising the important relationships between DC endocytic pathways and induction of immune responses, delivery of SVLP and RepRNA vaccines to DCs offers high value for the development of future synthetic vaccine platforms.

Keywords: dendritic cells, endocytosis, virus infection, vaccines, SVLPs, self-amplifying RNA

1. Introduction

While protective immune defences are reliant upon robust antibody-mediated (B-lymphocyte) and concomitant T-lymphocyte response, their development is dependent on antigen delivery leading to processing and presentation by dendritic cells (DCs), a critical player for robust immune defence development, and therefore efficacious vaccination [1–9]. Induction of antibody (humoral) and cell-mediated immune (CMI) defences requires virus or vaccine interaction with the conventional DC (cDC) subsets, the ‘professional antigen presenting cells’ [3, 6–12] (**Figure 1**). The manner by which these cDCs handle the antigen derived from an infection or vaccination defines the characteristics of adaptive immune defence development (**Figure 2**). Considering that many pathogen infections induce both humoral and CMI defences, vaccines inducing both arms of immune defence increase the potential for inducing robust immune defences. Accordingly, live attenuated vaccines should more closely mimic pathogen infection and therefore induce immune defence characteristics more related to convalescent immunity.

Understanding the cell biological elements providing DCs with their functionality has been possible from studies on both effective convalescent immunity and that induced by efficacious vaccination. Whether the studies focussed on virus infection or efficacious vaccine delivery, particular routes of endocytosis were observed to dominate. Through this, the power of DCs as the ‘professional antigen-presenting cell’ was determined [1, 3, 4, 6–8]. Yet, most current vaccines are inactivated or subunit/split vaccines. Being non-replicative, only a limited amount of antigen can be provided, namely that within the vaccine dose, in contrast to the much greater antigen levels produced during infection and from a live vaccine. Such non-replicative vaccines induce more restricted immune defence characteristics, in terms of humoral versus CMI immunity and the robustness (longevity) of that immunity, than observed with convalescent immunity or that induced by a replicating vaccine.

Of course, pathogen infection can induce undesirable clinical symptoms influencing the development of convalescent immune defence, which can be avoided by employing non-pathogenic replicating vaccines. Unfortunately, safe and efficacious live vaccines are not available for the majority of pathogens. Nonetheless, lessons can be learnt from convalescent immunity [9, 13]. A major consideration is the capacity of replicating vaccines to mimic the pathogen infection such as producing several rounds of antigen production, increasing the effective antigen dose, involving different antigen-presentation pathways, promoting different arms of immune responses and thus increasing the efficacy of immune defence induction [9].

Resolution of this situation is showing promise from the more recent application of synthetic biology to create both synthetic virus-like particles (SVLPs) [14–16] and self-amplifying/replicating RNA (replicon or RepRNA) vaccines [9, 13, 17–20], but also from advances in studies on virus infections. It has been observed that the majority of endocytosed material may well traverse rapid clathrin-mediated pathways, which is more likely favouring degradation of the internalised material [9, 21–25] (**Figure 3**, pathway (a)). Slower kinetics of endocytosis would favour the processing required for a particular vaccine to prove efficacious or a virus to initiate its replication. Such outcomes are seen with macropinocytosis and caveolar endocytosis (**Figure 1**; **Figure 3** pathway (b)), as well as endocytosis into sorting endosomes for retrograde

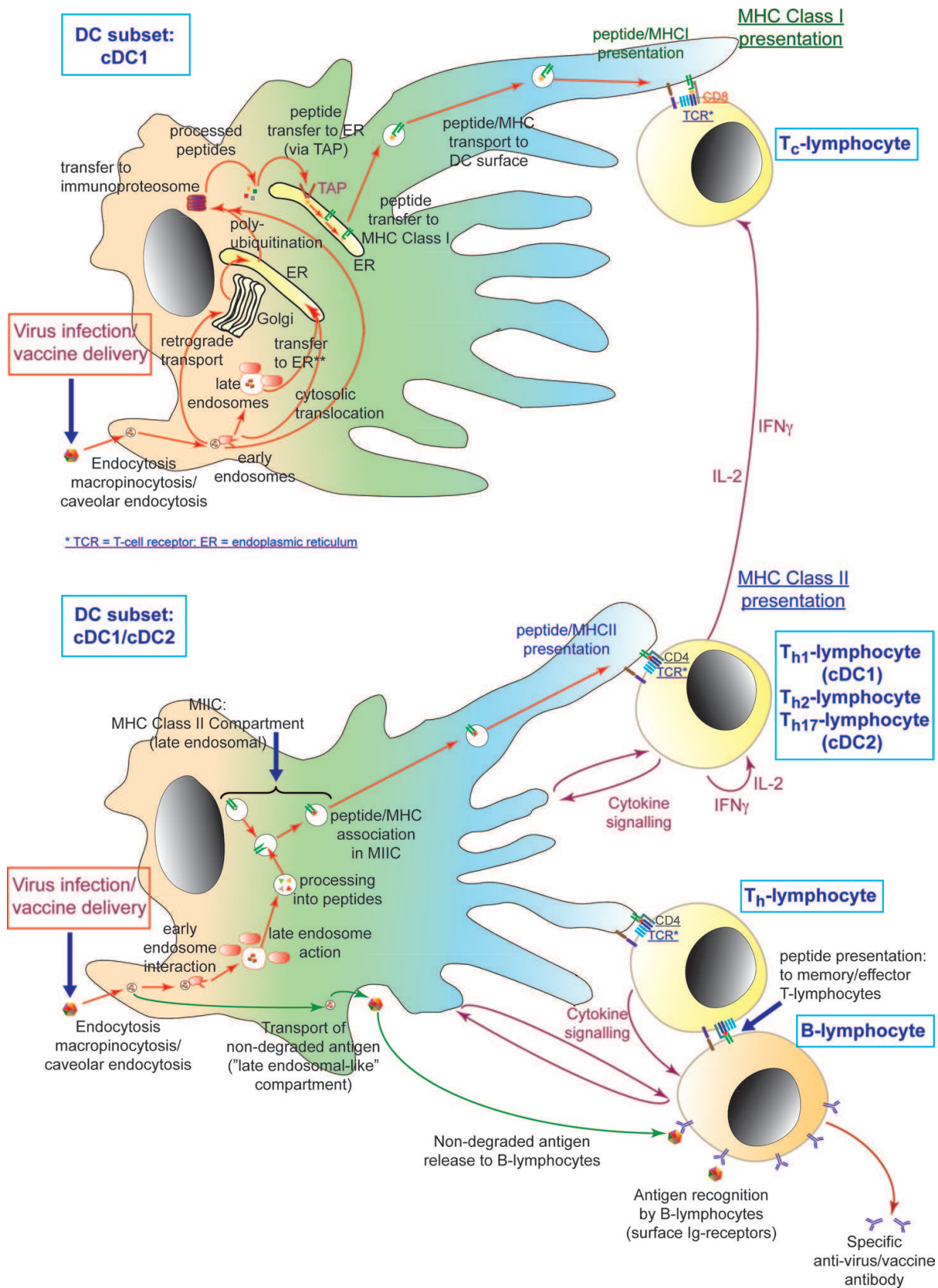

Figure 1. Generalised overview of the two main cDC subsets—cDC1 and cDC2—following endocytosis of virus or vaccine; processing pathways of endocytosed material leading into MHC Class I and MHC Class II presentation of the antigenic peptides to T-lymphocytes; delivery of antigen to B-lymphocytes; resultant initiation of antigen-specific immune defences and antibody production.

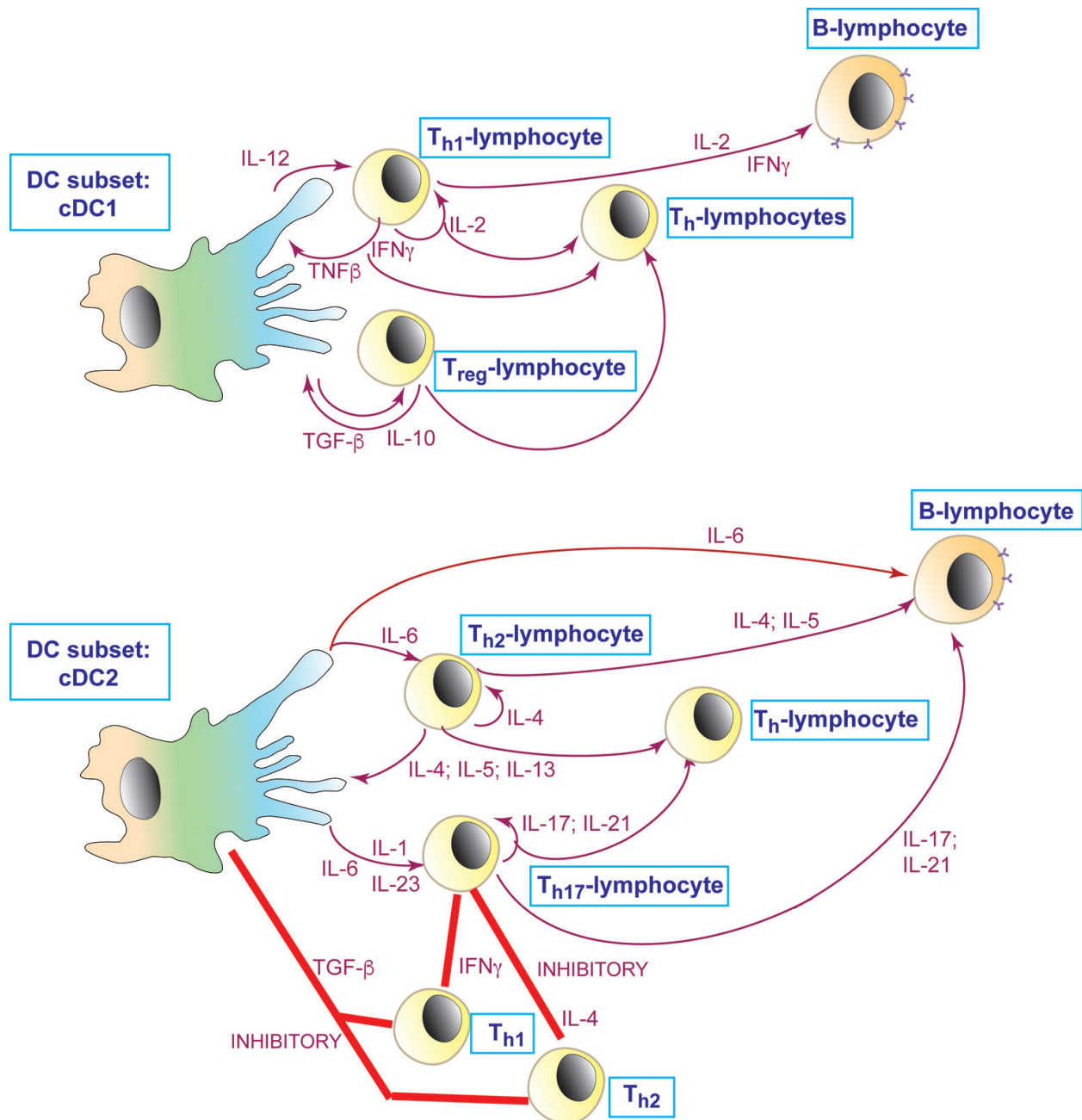

Figure 2. DC subset interaction with different T-lymphocyte subsets. Following processing and presentation of the derived antigen peptides to antigen-specific T_h - or T_{reg} -lymphocytes, the patterns of cytokine communications are shown. These are important for defining the characteristics of the developing immune response. The endocytic processes involved are likely to be clathrin-independent endocytosis such as macropinocytosis, caveolar endocytosis or phagocytosis.

transport through the Golgi complex into the endoplasmic reticulum (ER) (Figure 1; Figure 3 pathway (c)) [9, 26–29].

Further insight into the versatility of DC endocytic process has come from studies on initiation of RNA virus replication [25]. These have identified certain points of convergence with cross-presentation of protein-based vaccines, and thus initiation of RNA vaccine translation of encoded antigens [9]. Importantly, both cross-presentation of antigen and initiation of endocytosed

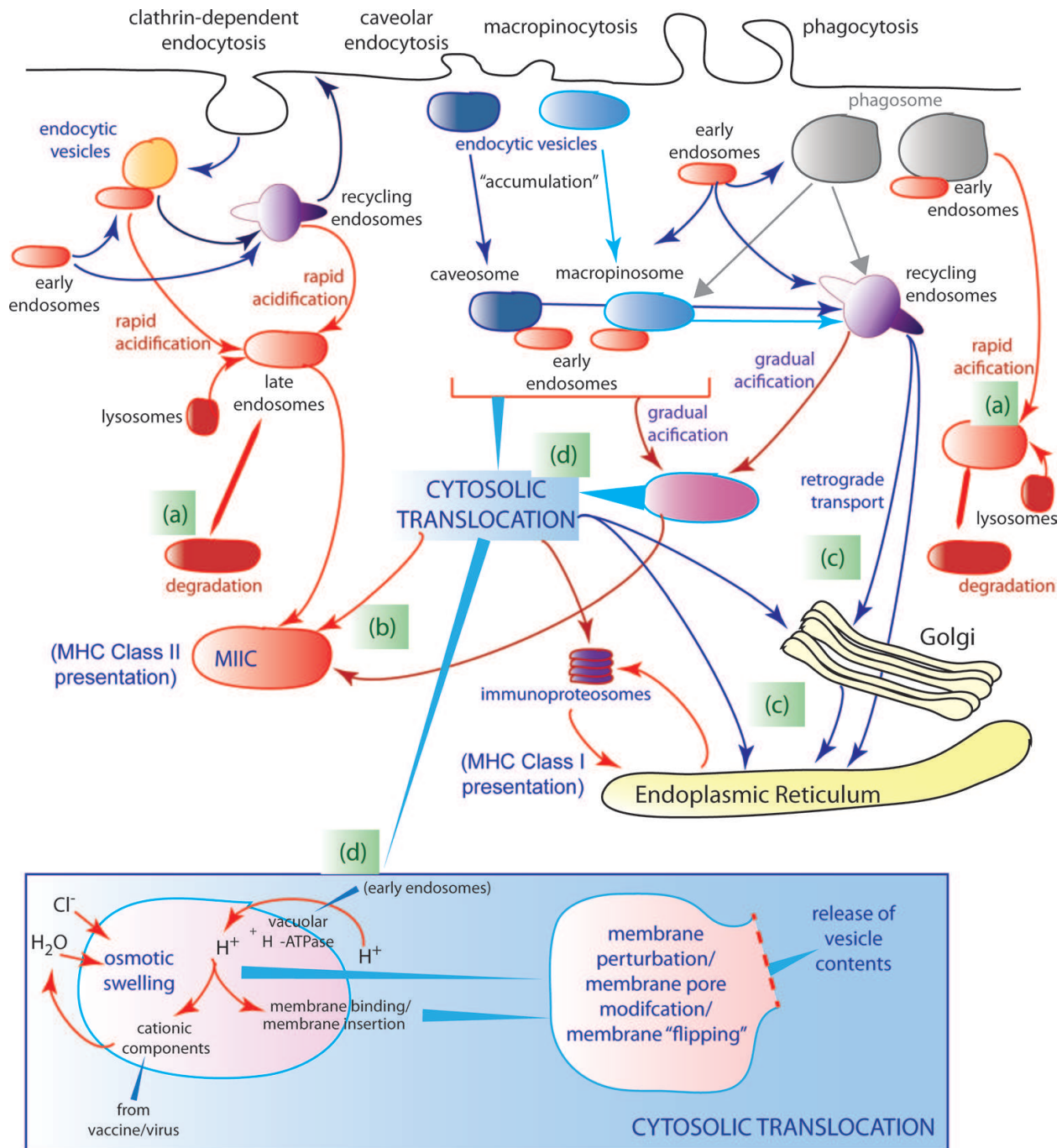

Figure 3. A schematic representation of the main endocytic processes functional within DCs in terms of processing internalised material for (a) degradation, (b) MHC Class II presentation, (c) MHC Class I presentation and (d) cytosolic release for cross-presentation via the immunoproteasome or translation of RepRNA vaccines. The lower portion of the image highlights certain aspects of endosomal release from endocytic vesicles during the early stages after acidification by interaction with early endosomes.

RNA translation require DC endocytosis leading into cytosolic translocation. Endocytosis for cross-presentation delivers exogenous antigen via cytosolic translocation into pathways of polyubiquitination; this directs processing by the immunoproteasome (cross-presentation) for presentation via major histocompatibility complex (MHC) Class I (Figure 1, Figure 3 pathways

(c) and (d)) [9, 30–32]. Similarly, endocytosed vaccine RNA would be delivered by cytosolic translocation into the ribosomal translation sites within the cell for translation of the encoded vaccine antigens [9, 25].

Cationic entities, particularly in a vaccine formulation, have been characterized for their capacity to promote endocytic vesicle perturbation towards cytosolic translocation [9, 13]. Yet, there are other considerations. Initiation of a virus infectious process may involve the viral membrane (with enveloped viruses) or virus surface proteins; thus, cytosolic translocation can be facilitated by membrane fusion and ‘flipping’, or through formation of ion channels and elaborating membrane pores for delivery of the RNA genome [25]. Application of this knowledge has recently been employed with synthetic biodegradable nanoparticulate vehicles for enhancing delivery of self-amplifying/replicating RepRNA vaccines to DCs [9, 13, 17–20, 33–35] (**Figure 3** pathway (d)). Whilst success with this approach has been forthcoming with mRNA vaccine delivery to DCs [9, 36, 37], delivery of the larger replicon RepRNA molecules has required additional considerations. This may be due to the likely increased compaction of these larger RNA molecules by the delivery vehicle, but other events important to the virus genome from which RepRNA is derived must be considered, including the role of cellular micro-RNAs (miRNA) and divalent cations. Nonetheless, nanoparticulate delivery technology has been adapted to deliver RepRNA to DCs (see below), leading to promotion of the replicon-encoded antigen translation *in vitro* and *in vivo* [13, 17–20, 33, 34]. The work identified important relationships between the DC endocytic pathways and ultimate induction of immune responses by the nanoparticle-delivered RepRNA, relating to characteristics observed following virus infection.

2. Dendritic cells: sentinels of immune defence

Dendritic cell (DC) subsets are found in many sites of the body, which determines their roles in developing and regulating immune defences (**Figure 4**) [1–12]. Together with MΦ, tissue and mucosal DCs are in the front line for encounter with and response to a virus or vaccine. These ‘local’ DCs and MΦ initiate the inflammatory response recruiting additional DCs together with monocytes, differentiating into DCs and MΦ, to augment local cell activity (**Figure 4**). Both the receptor repertoire and the endocytic processes employed by DCs and MΦ are closely related. Nonetheless, major distinctions exist, notably the recruitment of lysosomal proteases to the acidifying endocytic pathways is observed earlier and at higher levels in MΦ compared with DCs [38].

Dendritic cells are the central players for effective convalescent immunity, efficacious vaccination and maintenance of tolerance (**Figure 2; Figure 4**) [1, 3, 4, 6–8]. They are capable of both MHC Class II presentation (**Figure 1; Figure 2**), MHC Class I presentation, cross-presentation (**Figure 1**) [30, 32, 39–43] and antigen delivery to B lymphocytes (**Figure 1**) [44, 45], as well as regulating immune responsiveness and immune tolerance (**Figure 2; Figure 4**) [6, 46–53]. Therein lie two important aspects of DC biology—their high capacity for endocytosis together with the diverse network of routes employed (**Figure 3**) and different subsets tend

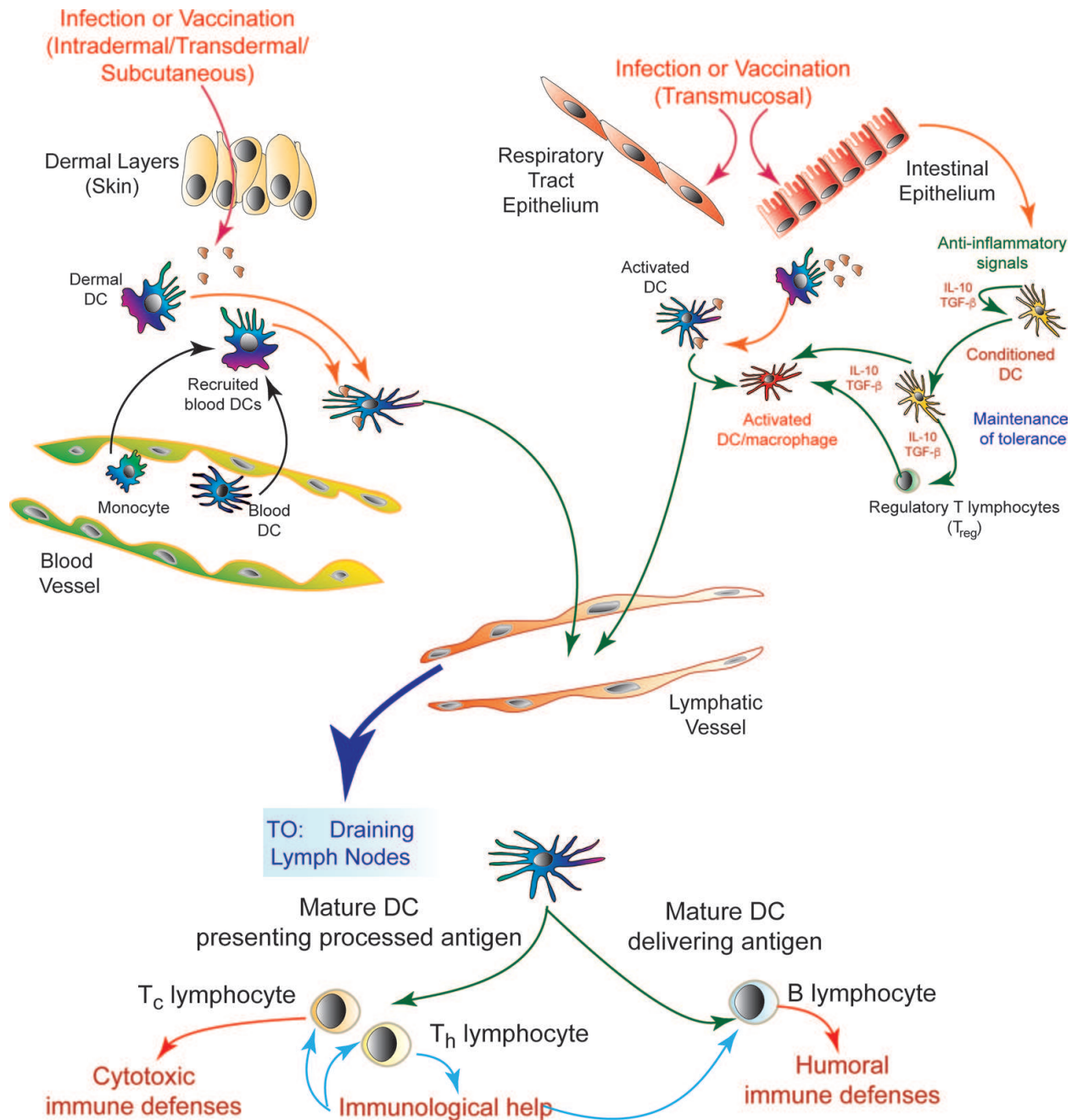

Figure 4. Dendritic cell subsets can be defined with respect to their sites of ‘residence’ in the body, wherein they act as sentinels for sampling the environment, to maintain tolerance and respond to ‘foreign’ material posing a ‘danger’ to the host. This is particularly notable at mucosal surfaces for controlling local tolerance through anti-inflammatory processes, while ensuring responsiveness against pathogenic entities and mucosal vaccines.

to dominate particular processes [3–5, 9, 12, 21–23, 54–56]. Although particular endocytic routes may dominate under certain interactions between DCs and virus or vaccine, more than one endocytic route will often be involved [9, 22, 56]. Indeed, using SVLP vaccines [14, 15], multiple endocytic routes have been identified. While macropinocytosis played a major role, additional endocytic routes were operative, as observed with mature DCs no longer employing macropinocytic activity [14].

3. Application of multiple endocytic pathways

Combining studies on both virus infection of and vaccine delivery to DCs have led to the creation of new vaccine formulations, such as SVLP vaccines [14, 15] and the self-amplifying RepRNA vaccines [9, 17–19, 33]. While clathrin-mediated endocytosis has often been implicated with both virus infection and vaccine delivery [9, 22, 25, 55–57], the rapidity of the process and levels of enzymatic activity therein would favour a more degradative pathway, rather than one promoting antigen processing or RNA-release for translation. Certainly, rapid clathrin-mediated endocytosis would create a detrimental environment to the survival of both RNA viruses and RNA vaccines (**Figure 3**, pathway (a)).

Accordingly, antigen must be processed to reach either the MHC Class I or MHC Class II assembly sites for appropriate antigen presentation (**Figure 3**, pathways (b), to (d)); RNA must be processed to reach the ribosomal translation machinery. Both exogenous antigen and RNA must avoid the degradative capacities of the late endosomes and, in particular, the lysosomes. Antigen being processed through the maturing endosomal system has to target the MHC Class II compartment (MIIC), for MHC Class II presentation, providing processing rather than degradation by lysosomes. With MHC Class I presentation, endocytosed exogenous antigen has to transfer from the endocytic pathway to the cytosol—cytosolic translocation. This facilitates the cross-presentation processing pathway via immunoproteasomes. An important characteristic is that the cytosolic translocation must be effected at a relatively early stage of endosome-mediated acidification of endocytic vesicles (see below). As for RNA, from viruses or vaccines, the cytosolic transfer for translation has to occur before the maturing endosomal system becomes too degradative; that is viral RNA genomes and RNA vaccines must escape the maturing endosomal system while still capable of translating [9, 38, 40, 43, 58].

While these differential processing pathways of DCs are important for ensuring efficient provision of antigen in the correct form for immune defence development, an additional process is essential, namely, endocytosis leading into ‘danger’ signalling. From within the endosomal system, this involves toll-like receptor (TLR)-containing endosome-like structures, which in turn are unlikely to provide antigen presentation and certainly detrimental to RNA release for translation. Following cytosolic translocation of RNA, danger signalling can be effected through cytosolic detectors such as the retinoic acid-inducible gene-I (RIG-I) family of helicases (see below). Accordingly, DCs employ different endocytic mechanisms and pathways to ensure correct processing of antigen, appropriate cytosolic translocation for cross-presentation, cytosolic translocation of RNA for translation, and appropriate delivery of antigen-based or RNA-based entities to the ‘danger’ signalling pathways.

4. Dendritic cell sensing

With DCs being an important sentinel of the immune system, the receptors on these cells play critical roles in different aspects of host environment surveillance (**Figure 5**). On the one side,

particular DC receptors are more involved in pathogen or vaccine uptake. In addition to this, DC handling of material 'foreign' to the host can lead to 'danger' recognition, which effectively determines immune activation as opposed to tolerance induction. Dendritic cell pattern recognition receptors (PRRs) recognise pathogen-associated or danger-associated molecular patterns (PAMPs and DAMPs), playing major roles in this recognition and ultimate signalling of the DCs.

Dendritic cell receptor ligation determines the manner by which DCs endocytose and the outcome of the DC activity. One important consequence of ligating certain receptors is the induction of inflammatory reactions (see **Figure 2** and **Figure 4**), the characteristics of which relate to the receptors involved [5, 59, 60]. While PRRs such as toll-like receptors (TLRs), complement receptors and mannose-binding receptors (**Figure 5**) are important for inflammatory responses, both these and other receptors including other C-type lectins, integrins and CD44 can enhance 'foreign' material binding to and internalisation by the cells into endocytic processing pathways [5, 9, 61–63]. For example, ligation of TLRs, siglecs, galectins and CD14 can promote antigen uptake as well as activating innate defence processes, either alone or in co-operation with C-type lectins or integrins [9, 64, 65]. Moreover, different DC receptors can promote uptake into different endocytic pathways. For example, cholera toxin may be targeted to caveolar endocytic pathways and the ER, whereas autocrine mobility factor associates more with the ER [66]. While simian virus 40 (SV40) also targets to the ER, both this and cholera toxin are observed in recycling endosomes prior to retrograde transport into the Golgi and ER [26–29].

In addition to DC sensing their environment via cell surface PRRs such as TLR2 heterodimers and TLR4, endocytosed material can also be sensed. Vesicular TLR2 can detect lipopeptides

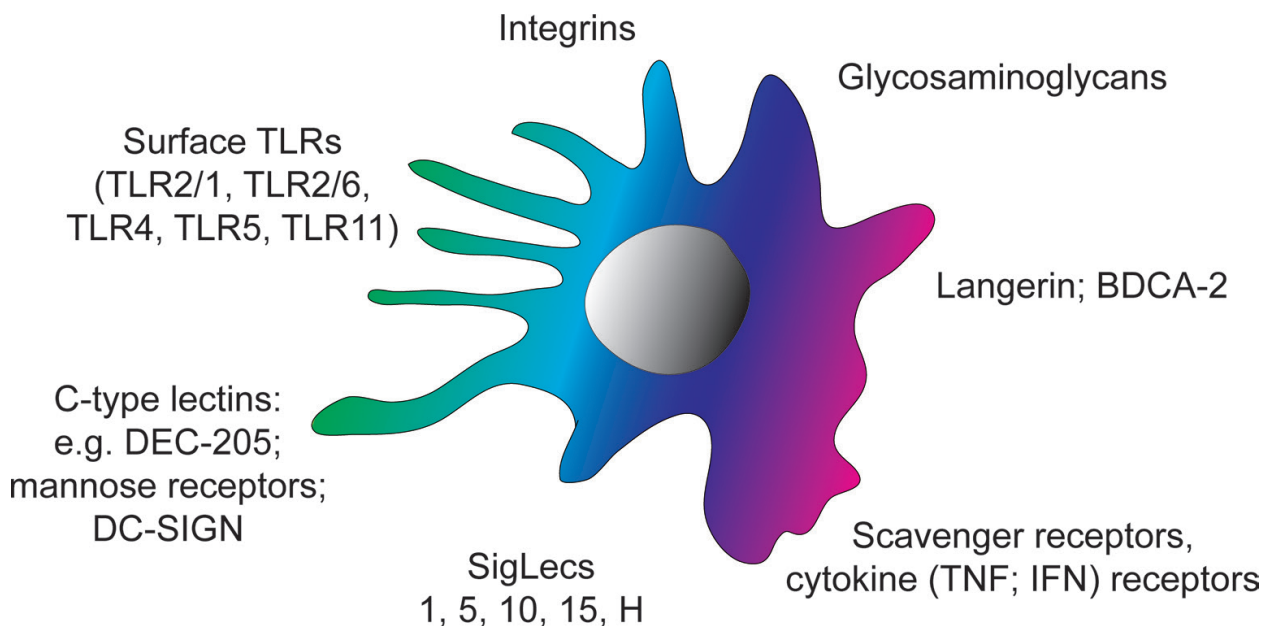

Figure 5. Examples of known DC receptors, demonstrating their wide range of capacities for sampling the host environment. These receptors also offer the potential for targeting vaccines to DC, particularly with the new synthetic vaccines employing nanoparticulate delivery vehicles.

buried deep within bacterial cell walls following endosomal degradation of the latter to expose the lipopeptides. This was proven using SVLPs carrying TLR2 ligands within their hydrophobic cores [15]. By employing such SVLPs, there was no influence of interaction with cell surface TLR2 heterodimers, as is the case with bacteria and yeast particles through the lipoteichoic acid and peptidoglycan moieties in their cell walls.

Additional intracellular PRRs are also involved in detecting 'foreign' RNA—vesicular TLR3 and TLR7, and cytosolic sensors including helicases [67–69]. RNA sensing is an important issue for RNA virus infection and RNA vaccine delivery. Pathogen-associated molecular patterns (PAMPs) associated with 'foreign' RNA are generally formed through RNA modifications or secondary structures not normally found within the cells. TLR3 and TLR7 can respond to dsRNA and ssRNA structures on the 'foreign' RNA, respectively, such PRR activity being linked with processing via the endosomal system. Yet the RNA associated with RNA virus infections as well as with delivery of RNA vaccine can be translocated to the cytosol through action of the virus or vaccine particles (see below). Under these conditions, cytosolic sensors become important for detecting RNA-associated PAMPs.

5. Cytosolic PRR activity

Cytosolic helicases can detect RNA translocated to the cytosol from vesicular structures. The cytosolic helicases of the RIG-I-like receptors (RLRs) family recognise RNA-associated PAMPs through their helicase domain and C-terminal repressor domain (RD); the consequential triggering of intracellular signalling cascades is effected via the caspase-recruitment (CARD) domains [70]. As with the RNA-sensing TLRs, RLRs can recognise PAMPs associated with either ssRNA or dsRNA. The latter come from the dsRNA intermediates derived from replicating viral genomic RNA or RepRNA; single-stranded RNA molecules can also form double-stranded sequences during the hairpin-folding for their secondary structures, the length of which will determine their detection as PAMPs [71]. In addition to such structures, RNA bearing a 5'-triphosphate will also be sensed by helicases.

Within the RLR family, RIG-I responds to both short dsRNA sequences and ssRNA bearing a 5'-triphosphate; MDA-5 responds more to long dsRNA [70]. 5'-triphosphate structures are often required by positive-strand RNA viruses (termed 'positive strand' due to the capacity of the viral genome to function as an mRNA) to ensure ribosomal entry for translation. During the replication of RNA viruses and RepRNA, dsRNA 'replicative intermediates' are formed to generate progeny ssRNA (hence the 'self-amplifying' term associated with RepRNA vaccines). Thus, DCs endocytosing RNA viruses or vaccines capable of self-amplification would respond to dsRNA replicative intermediates, in addition to the double stranded secondary structures in the endocytosed RNA, and 5'-triphosphate if present.

This 'danger' sensing of RNA structures provides a good example of the divergence displayed by different DC subsets, and the influence on the cytokine profiles induced. Plasmacytoid DCs (pDCs) tend more to use TLR3 and TLR7 sensing; other cells will employ the cytosolic sensors of RLRs and oligomerization domain (NOD)-like receptors (NLRs), which also respond to

dsRNA structures [70]. While RLR- and TLR-mediated activation leads to type I interferon and pro-inflammatory cytokine production, dependent on the DC type, NLR-mediated activation favours IL-1 β induction; it is also important to note that dsRNA sensing by NLRs is involved in the regulation of the induced responses [70].

Thus, 'danger' recognition can lead to particular cytokine profiles dependent on the sensing receptor and DC subset involved. The pDC sensing of RNA by TLR3 and TLR7 (and DNA by TLR8/9) leads to the production of notably high levels of IFN- α and TNF, particularly in response to infection. In addition to their anti-viral properties, these cytokines provide the necessary signals to promote appropriate cDC maturation, essential for ensuring that antigen presentation to lymphocytes promotes the development of an antigen-specific adaptive immune response. However, induction of cytokine production by DCs, cDCs and pDCs, will not always prove beneficial in promoting effective immune defence. For example, viruses such as influenza virus and haemorrhagic disease viruses can induce excessive levels of IFN- α and other inflammatory cytokines, leading to the so-called cytokine storm and subsequent immunopathological problems [72–75]. Even viruses not renowned for inducing such events can be prove troublesome. For example, foot-and mouth disease virus infection in pigs can increase IL-10 production by DCs, with a consequential negative influence on antigen presentation and T-lymphocyte activation; in contrast, immune complexes with foot and mouth disease virus are potent inducers of IFN- α by pDCs [76, 77].

Such studies on virus infection of DCs have helped to define conditions beneficial for the host, and therefore what is required for efficacious vaccination. Dendritic cell cytokine induction is certainly critical for inducing maturation of cDCs, an essential requirement for both migration into lymph nodes and efficient presentation of antigen leading to activation of T-lymphocyte responses [2, 7, 10, 62]. Overall, one should consider that targeting slower endocytic processing pathways rather than targeting the more rapid and degradative pathways would prove crucial.

6. Comparative endocytic processes within DCs

The aforementioned differences between M Φ and DCs give an important insight into the characteristics of endocytic processing. Dendritic cells degrade endocytosed material at slower rates, with an overall less acidic phagosomal/endosomal pH than M Φ [38]. These characteristics relate to the different biological roles of the two cell types. On the one hand, DCs are more important for processing and delivering antigen to activate lymphocyte responses. Conversely, M Φ play a more significant role in innate immune cell defence, notably pertinent in the removal and destruction of infectious pathogens, as well as entities presenting a danger to the host, such as damaged or dying cells. Nonetheless, these roles are neither absolute nor mutually exclusive; DCs and M Φ interact during inflammatory responses and the recruitment of cells, including additional DCs, M Φ , T-lymphocytes and NK cells.

The slower endocytic processes noted with DCs would certainly be favourable for efficient antigen processing leading to presentation, as well as cytosolic translocation for cross-presentation

or facilitating RNA translation (see **Figure 3**). Yet, despite the difference in the cellular components and the rate of endocytic processing, both clathrin-dependent and clathrin-independent pathways show a major relationship. Although some employ dynamin while other pathways are dynamin-independent [21–23, 78–80], both processing pathways can lead to interaction with early endosomes (**Figure 3**). This provides acidification by vacuolar H⁺-ATPase activity and enzyme-mediated degradation within the endocytic vesicle. The important difference between the rapid clathrin-dependent endocytosis and slower clathrin-independent routes is the rate at which endosomal interaction and acidification occur [21–23, 55–57]. The clathrin-independent endocytic processes, such as macropinocytosis, lipid raft-dependent and caveolae-mediated endocytosis, are notably active with DCs, facilitating processing of antigen for presentation via MHC Class II [9, 23, 54, 56, 57]. Moreover, slower processes support retention of endocytosed material at the earlier stages of endosomal maturation in DCs for longer periods, increasing the potential for cytosolic translocation. Nonetheless, clathrin-dependent endocytic processes have been employed by viruses to promote initiation of their infectious cycle. Ebola virus, coronaviruses and certain mammalian reoviruses employ clathrin-dependent endocytosis for their infections [81]. Other viruses, such as influenza virus, employ both clathrin-dependent [82] and clathrin-independent pathways, the latter proving also caveolin-independent. Certain bacterial toxins are also endocytosed by clathrin-dependent and clathrin-independent pathways [26–28, 83–85].

6.1. Macropinocytosis in dendritic cells

The clathrin-independent macropinocytosis relates to clathrin-dependent endocytosis in concentrating receptors upon internalisation, although macropinosomes are more heterogeneous in size—up to 5 µm diameter. The function of macropinocytosis also impacts strongly on DCs in their role of antigen processing for presentation to the adaptive immune system. Both DCs and MΦ employ macropinocytosis more efficiently than other cells [86], through their application of aquaporin channels to sample the environment [87], exhibiting fluid phase uptake up to 40% of their cell volume [88]. Macropinocytic activity is also important with respect to the aforementioned maturation of DCs which is essential for efficient antigen presentation to T-lymphocytes. Aquaporins are down-regulated in mature DCs, relating to the observed reduction in macropinocytosis [87]. In contrast, maturation of DCs does not affect other receptor-mediated endocytosis processes.

The fate of macropinosomes is also particular to DCs and MΦ, wherein macropinosomes fuse with early endosomes soon after formation (**Figure 3**). Macropinosomes acquire Rab7, exchanging their membrane content with late endosomes as they are transported to a more perinuclear area [89]. This contrasts with non-immune cells, such as epithelial and fibroblastic cells, wherein macropinosomes tend to remain more isolated from endosomes and lysosomes, fusing back with the plasma membrane to release their content into the extracellular space [90, 91].

Clearly, macropinocytosis is an important component for facilitating antigen capture by DCs and MΦ. In the context of antigen processing and presentation, the macropinocytosed antigens are observed in endocytic vesicles and macropinosome-like structures rich

in MHC Class II molecules (**Figure 3**, pathway (b)) [88, 92]. Antigens endocytosed via macropinocytosis can also be presented on MHC Class I molecules—the cross-presentation pathway following antigen translocation to the cytosol for processing via the immunoproteasome (**Figure 3**, pathway (c)) [93]. Yet, DCs employ other endocytic pathways in addition to macropinocytosis (**Figure 3**). Caveolin-dependent endocytosis is important, as is lipid raft-mediated endocytosis, although the latter can be associated with both macropinocytosis and caveolar endocytosis. Clathrin-independent endocytosis routes in the absence of caveolin may become solely dependent on lipid rafts for intracellular trafficking.

6.2. Processing macropinosomes and other endocytic processes

Following the endocytosis, early endosomes associating with endocytic vesicles are considered key players for cargo sorting (see **Figure 3**). An important bifurcation of endocytic pathways occurs at this stage, channelling into Rab11⁺ recycling endosomes or into intra-luminal vesicles of multi-vesicular endosomes (MVEs; or MVBs for multi-vesicular bodies). Via these latter structures, processing will ultimately lead into late endosomes and lysosomes. Many late endosomes are involved in the degradative pathway resulting in association of lysosomes and degradation of the cargo, but a late endosome-related structure is essential for MHC Class II presentation—the MHC Class II compartment (MIIC). Late endosomes may also be associated with transfer into vesicular structures carrying the internal TLRs. Moreover, the channelling of endocytosed antigen in a relatively intact form for delivery to B-lymphocytes employs late endosome-like structures [44, 45]. Not only macropinocytosis, but also caveolin-dependent endocytosis crosstalk with classical endosomal components [94], including fusion with Rab11⁺ recycling endosomes—caveolin⁺ caveosomes are also seen to be sorted from endosomal compartments [95].

Caveolar endocytosis has been noted with particular entities interacting with cells, including albumin [96], tetanus toxin [97], cholera toxin [98] and both polyomavirus and SV40 [99]. The uptake of cholera toxin [100] is particularly noteworthy, considering the involvement of the recycling endosomes with caveolar endocytosis. The B subunit of the toxin is responsible for cell entry following binding to the monosialotetrahexosylganglioside (GM1) found in lipid rafts and caveolae. Although the CTB subunit can associate with clathrin-dependent endocytic vesicles and clathrin-coated pits [101], and inhibition of clathrin-mediated endocytosis reduces cholera toxin internalisation [98, 102], the toxin activity it is not dependent on clathrin-dependent endocytosis [102]. For this, the cholera toxin must be delivered into Golgi complex, which requires retrograde transport from the recycling endosomes (**Figure 3**) [26–28]. In fact cholera toxin can be endocytosed by different routes, but is ultimately delivered from recycling endosomes to Golgi complex via a clathrin-independent pathway [100, 103], as is shiga toxin [104]. It is also likely that viruses such as polyomavirus and SV40 may require similar routes of entry [105]. Overall, the important lesson from these studies is the capacity of DCs to employ different endocytic routes, some particular to certain antigenic materials, and others being employed in combination. Whether the DCs employ a particular endocytic pathway or a number of different routes, the outcome is dependent on the pathway employed and therefore influences how the DCs handle the endocytosed cargo.

7. Cytosolic translocation in dendritic cells

As mentioned above, retrograde transport from recycling endosomes into the Golgi and ER (see **Figure 3**) is an important pathway for the B subunit of cholera and shiga toxins to promote cytosolic translocation of the A subunit [26–28]. Polyomavirus and SV40 also translocate from the ER for initiation of their replicative cycle [105]. These pathways can be employed by DCs for the cytosolic translocation leading to cross-presentation of exogenous antigen.

Following the retrograde pathway, cytosolic translocation is likely dependent on protein-protein interactions facilitating entry into the cytosol, as observed with the mechanisms employed by cholera and shiga toxins and members of the polyomaviridae. Association of ER membranes with endocytic vesicles can insert the ER dislocon, leading to antigen associated with ER-like structures and subsequent entry into cross-presentation pathways [39, 43].

Yet, DCs can also employ non-retrograde pathways—relatively slow clathrin-dependent endocytosis or the clathrin-independent macropinocytosis—for cytosolic translocation leading into the cross-presentation pathways. This cytosolic translocation displays distinctive characteristics dependent on which of the endocytic routes is employed, but requires interaction with early endosomes. The neutral pH environment of the ER and proteolytic activity therein is clearly distinctive from the events associated with clathrin-dependent and clathrin-independent endocytosis involving endosomal interactions. With the latter, the early endosomes provide membrane vacuolar H⁺-ATPases promoting acidification of the endocytic vesicles, an essential event for facilitating cytosolic translocation from these arms of the endocytic processing pathways.

An important influence on the outcome of endocytic vesicles interacting with early endosomes is the role of cationic elements within virus particles or vaccine delivery vehicles. Cationic entities, associated with peptide, lipid or saccharide structures can provide what has been referred to as the ‘proton sponge’ or ‘pH-buffering’ effect (**Figure 3**, pathway (d)) [106, 107]. The vacuolar H⁺-ATPase activity from early endosomes pumps protons into the endocytic vesicle leading to this proton sponge effect. For example, protonable amines behave as buffering agents by readily accepting protonation [108]. Histidine- and arginine-rich molecules, as well as histidine residues, can also initiate the proton sponge effect through protonation of imidazole rings [106, 107]. By increasing ion and water uptake into the endocytic vesicles, the protonation events increase osmotic pressure leading to vesicular swelling and membrane destabilisation, allowing cytosolic release of the vesicle contents. However, disruption of the endocytic vesicles would prove a relatively destructive process, and are not ideal for the intracellular environment. A more physiologically appropriate process can be seen when analysing histidine- and arginine-rich peptides and polymers, with which cytosolic translocation can be promoted through interaction with the anionic vesicular membrane [107]. This is particularly notable with amphiphilic peptides. Binding at the edge of membrane pores can reduce internal membrane tension, while insertion into the vesicular membrane can reduce chain length to create internal membrane tension [106, 109]. Cationic lipids will also influence cytosolic translocation by ionic pairing with phosphatidylserine in endocytic vesicle membrane [110]. This promotes electrostatic interactions and decreases membrane curvature, potentially with conversion from a lamellar to a non-lamellar phase.

Regardless of which endocytosis pathway is employed by the DC to process internalised cargo, the outcome will be either destruction or processing. For the latter, this can lead through the maturing endosomal system for MHC Class II presentation, or can involve one of the pathways of cytosolic translocation for MHC Class I presentation. With RNA viruses and RNA vaccines, the latter pathways would be more favourable, promoting delivery of the RNA to the ribosomal translation machinery. In the case of RNA vaccines, this translation would provide the antigens for direction into the immunoproteasome from the ER, or probably via autophagy into the endosomal system for delivery to the MIIC.

8. Dendritic cell endocytosis leading to MHC Class I or MHC Class II presentation

As mentioned above, MΦ with DCs employ common endocytic processes for ultimately distinctive outcomes [38]. While MΦ rapidly recruit and activate lysosomal proteases, leading to rapid degradation of endocytic cargo, the lower acidic endosomal pH and slower acidifying process within DCs favour slower degradation of internalized cargoes. DCs also generate reactive oxygen species in endocytic compartments through the activated NOX2 subunit of NADPH-oxidase, which in turn consume protons and modulate the pH. This rate of endosomal acidification is important for the consequences of the processing pathway, and therefore both directing into the MIIC and cytosolic translocation. Although acidification of the endosomal structures is a characteristic of the so-called endosomal maturation leading into the more destructive late endosomes and lysosomes, the early stages of the endosomal acidification play particularly essential roles for cytosolic translocation from the endosomal compartment. Therefore, a more 'regulated' (in terms of rate) endosomal acidification would facilitate the processing events leading to MHC Class I and MHC Class II presentation. Importantly however, once the acidification falls below a certain pH, the potential for translocation to the cytosol becomes less likely, and the endosomal structures become 'cross-presentation incompetent' [38]. This situation relates to the concomitant decrease of pH and ER-derived proteins, with increased proteolytic activity.

It is now clear that exogenous antigen can be processed into the MHC Class I pathway via 'cross-presentation' pathways [40, 43, 57, 58, 111] which is important for activating the Tc lymphocytes of cytotoxic CMI (see **Figure 1**). Consideration of these characteristics has also proven valuable for understanding the requirement of endocytosed RNA and RNA viruses for cytosolic translocation (see **Figure 3**, pathway (d)). Moreover, the division of labour associated with different DC subsets is an important consideration when cytosolic translocation is required. Participation of different DC receptors leading to endocytosis is influential, defining the form of endocytosis and relative role played by retrograde transport into the ER [43].

When the receptor and endocytic targeting deliver into early compartments such as recycling endosomes, both MHC Class I and Class II presentation can ensue; delivery into and interaction with later endosomal compartments lead to a domination of MHC Class II presentation [38, 112]. Yet, transport of the endocytosed material down a particular pathway

favouring MHC Class I or MHC Class II processing is not absolute. For example, material being transported towards an MHC Class I presentation pathway can be transferred into autophagic vesicles for delivery into the MHC Class II presentation pathway.

Overall, it can be considered that processing antigen for association with MHC Class I molecules is a less acidic process compared with the pathway leading to MHC Class II presentation. A good example of this is the aforementioned relative neutral pH of the retrograde pathway through the ER. Another example is seen with cytosolic translocation from early endosomal structures. The initial lowering of endocytic vesicle pH is important, but as mentioned above this is limited by the 'point of no return' within the acidifying endosomal compartment, beyond which the conditions render translocation less likely [38, 43, 113]. Therefore, cytosolic translocation must arise before the more degradative processes of the late endosomes have taken charge.

As mentioned above, not only antigen, but also viruses employ different endocytic pathways to initiate their replicative cycles. While polyomaviruses and SV40 translocate from the ER for this purpose, numerous other viruses require the acidifying endosomal system to initiate their replication. The endosomes provide pH-dependent modifications of viral surface proteins. By such means, endosomal membrane modulation is promoted leading to cytosolic release of the viral genome; in the case of positive strand RNA viruses, the genome functions as a mRNA by interacting directly with the cellular translation machinery; in the case of negative strand viruses, the viral genome is associated with the nucleocapsid carrying the polymerase, the polymerase generating the 'positive strand' to function as an mRNA. Endosomal membrane modulation can result from fusion between the endosomal and viral membranes, as with influenza virus, or re-arrangement of viral proteins to form ion channels and pores in the endosomal membrane, as with picornaviruses and flaviviruses [25]. Related to the former (endosomal membrane fusion), is the work with fusogenic peptides, leading to vesicular membrane destabilisation as the internal pH decreases below 6.0 [107, 109].

These studies on the processes employed by viruses to promote cytosolic translocation have proven useful in the development of processes for the successful delivery of RNA vaccines. In this context, the delivery of self-amplifying replicon RNA is of particular interest, due to its high potential for vaccine development in the future [9, 13, 17–19, 35, 114]. However, these large RNA molecules have particular requirements, which are more stringent or more obligatory than with smaller RNA molecules such as the oligonucleotides of siRNA and mRNA vaccines.

9. Self-amplifying RNA interaction with dendritic cells

Interest in the development of replicating RNA vaccines has increased during the past two decades, notably in the field of self-amplifying RepRNA technology [9, 13, 18, 114–118]. RepRNA are basically viral genomes lacking at least one gene encoding structural proteins, but retaining the genes encoding the viral polymerase (self-amplification/replication) complex (**Figure 6**), hence termed as 'replicon'. This type of construct permits replication of RNA without the risk of progeny virus production and therefore disease; the vaccine element is

introduced by inserting genes encoding vaccine antigens of interest ('genes of interest' or GOI) into the constructs (Figure 6) [9, 13, 18, 20, 114–121]. Development of this technology during the past two decades focussed on packaging the RNA in a virus-like particle or the virus replicon particle (VRP) [9, 115–117]. However, this approach can encounter particular problems such as host immunity against the viral proteins composing the VRP surface structure; production difficulties/expense may also prove an encumbrance due to the requirement for complementing cell lines providing the gene products missing from the replicon so that VRPs will be generated [9]. Replacement of the VRP by biodegradable delivery vehicles would facilitate vaccine production (obviating the need for complementing cells lines), avoid problems of the host immune system neutralising the VRP antigens, and permit more controllable targeting of DCs [9]. This approach was first reported in 2008 (Figure 7) [20], with

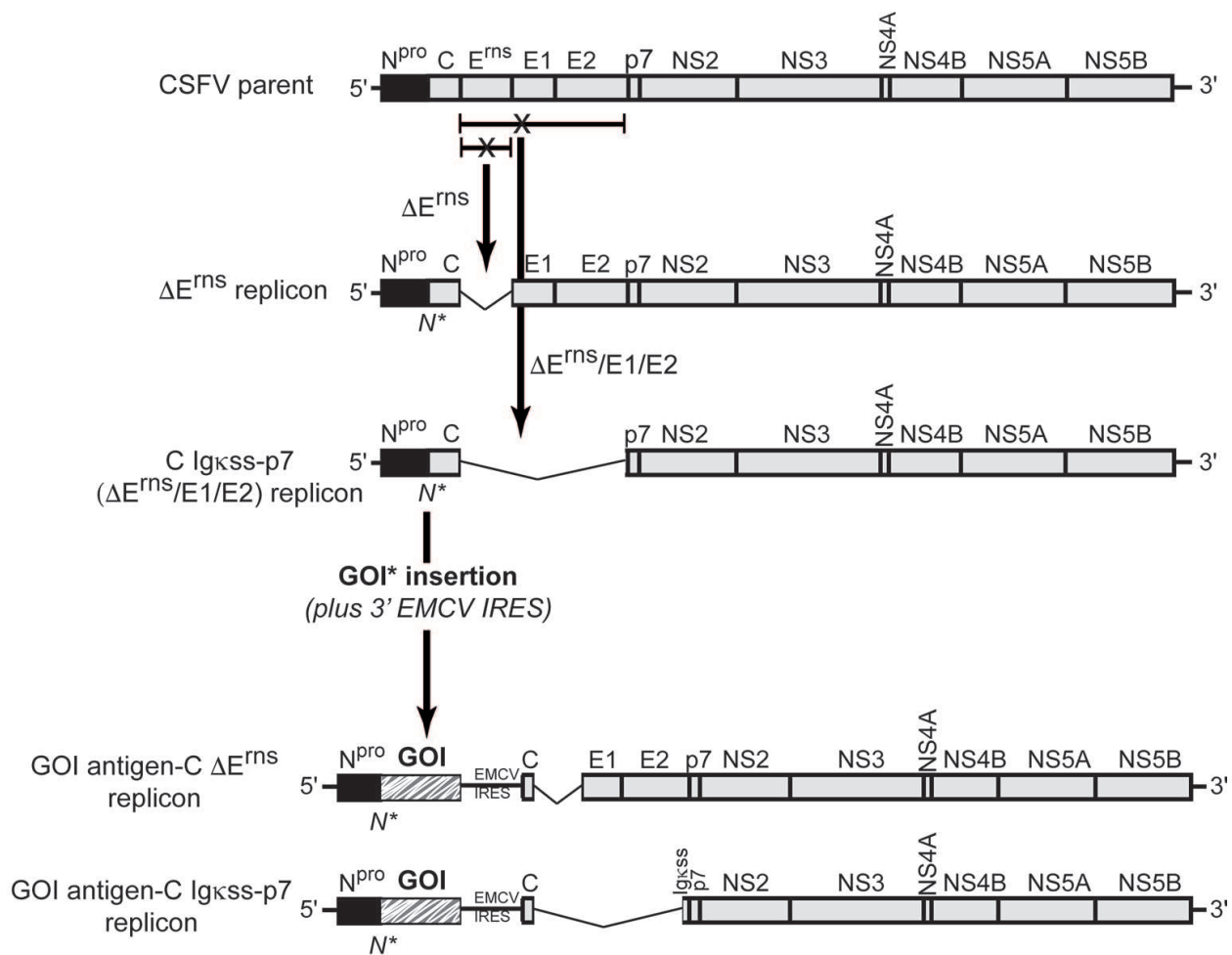

* GOI: gene of interest encoding vaccine antigen

Figure 6. Generation of self-amplifying RepRNA vaccines derived from the CSFV genome, for application with biodegradable nanoparticulate delivery vehicles to target DCs by nanoparticulate vehicles. Two examples are shown: ΔE^{rns} replicon lacking a single (E^{rns}) gene, and C-Ig κ ss-p7 replicon lacking all three structural glycoproteins. NotI endonuclease restriction sites, introduced to facilitate insertion of genes encoding vaccine antigen, are shown at the 3' end of the N^{pro} leader autoprotease as N^* . The site for insertion of the gene of interest (GOI) encoding the vaccine antigen is shown as the hashed box. An additional insertion, an EMCV IRES, is employed to restart the translation which terminates after the GOI.

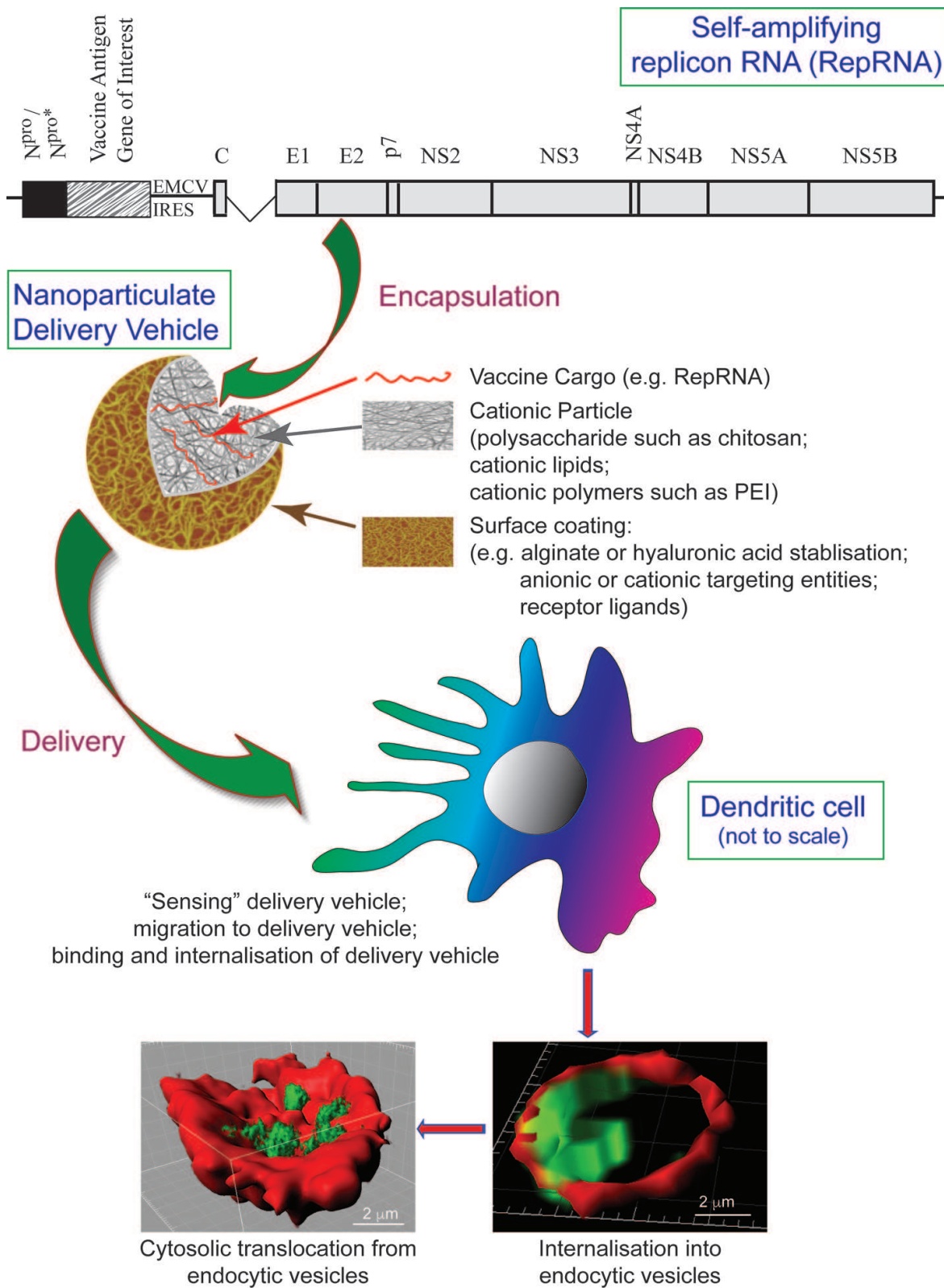

Figure 7. Nanoparticulate delivery of self-amplifying RNA vaccines derived from the CSFV RepRNA. The nanoparticulate delivery vehicle is designed to promote efficient uptake into endocytic vesicles, in which the RepRNA is seen to accumulate. Thereafter, a gradual cytosolic translocation of the RepRNA is observed—essential for RNA delivery to the intracellular site for translation. Thereby, the RepRNA efficiently translates the encoded vaccine antigen of interest, as well as the polymerase complex for replication of the RNA. Insertion of an internal ribosomal entry site (IRES) from EMC virus ensures that translation of the polymerase complex resumes after translation of the vaccine antigen.

increasing evidence of the potential for this methodology forthcoming in more recent years [9, 13, 17–19, 33–35, 114, 122].

RepRNA show the characteristics of the parent virus genome, providing several rounds of replication to increase the number of RNA templates available for translation. By such means, the antigen dosages available for activating humoral immunity and cytotoxic cell-mediated immunity (CMI), as well as the duration of that availability, are enhanced beyond that possible with a more conventional inactivated vaccine approach (**Figure 8**) [9, 13, 17, 18, 20, 114]. Moreover, being replicative in nature enhances their capacity to induce CMI as well as humoral immunity, a characteristic often lacking with inactivated vaccines. Live, attenuated vaccines offer the same advantage due to their replicative nature. A major benefit of RepRNA vaccines is that they do not suffer from the potential risk of reversion to virulence posed by attenuated vaccines, due to their defective nature being unable to produce progeny viruses (**Figure 6**).

Many studies, primarily using VRPs, have employed alphaviruses [115–117]. However, these viruses and the derived RepRNA are cytopathogenic, killing their host cells. The slow processing and retention of antigen typical of DC functionality with respect to inducing robust immune defences would not be favoured by cell death from a cytopathogenic RepRNA, despite their rapid production of antigen. Although delivery of such replicons to epithelial cells would provide antigen indirectly for the DCs, targeting DCs with cytopathogenic replicons is probably not the most effective of approaches. On the other hand, non-cytopathogenic RepRNA vaccines, such as those derived from classical swine fever virus (CSFV) (**Figure 6**) [20, 118], would have higher potential for targeting DCs with the aim of prolonged presence of antigen in these cells (**Figure 7**). While non-cytopathogenic RepRNA should translate antigen slower than cytopathogenic replicons, lower antigen production levels fit well to the DC requirements for prolonged antigen presentation to the adaptive immune system (**Figure 8**).

One major drawback with RepRNA vaccines in general is their high RNase sensitivity. This can be avoided by employing either VRP for delivery or biodegradable nanoparticulate delivery vehicles (**Figure 7**) [9, 13, 18, 20, 114, 123]. From initial efforts in 2003, the concept of RepRNA delivery by biodegradable nanoparticles was developed [20], showing high potential for delivery to DCs (**Figure 7**; **Figure 8**) [9, 13, 18, 114, 17]. Nonetheless, it is now evident that nanoparticulate technology can lead to compaction of RepRNA (**Figure 7**). This was not so apparent with delivery of smaller RNA molecules, such as siRNA and mRNA, only coming to light with the much larger RepRNA molecules. While compaction with the delivery vehicle could interfere with cytosolic translocation, even after the translocation a lack of decompaction would interfere with ribosomal entry and thus translation. Studies turned to the aforementioned importance of protonation within the endocytic vesicle for cytosolic translocation, which could also influence the degree of RNA compaction by the delivery vehicle.

Application of cationic components in the delivery vehicles for RepRNA, such as chitosan cores, cationic lipids and cationic polyplexes (**Figure 7**), has proven successful for enhancing RepRNA delivery [9, 17–19, 33, 35]. Their cationic nature facilitates interaction with RNA and protection from RNases. In addition, they may favour events leading to cytosolic translocation from the endocytic vesicles during the initial phases of early endosome-mediated acidification. Application of additional cationic entities, such as lipids or peptides, may further favour cytosolic delivery and decompaction for translation, potentially by reducing the levels

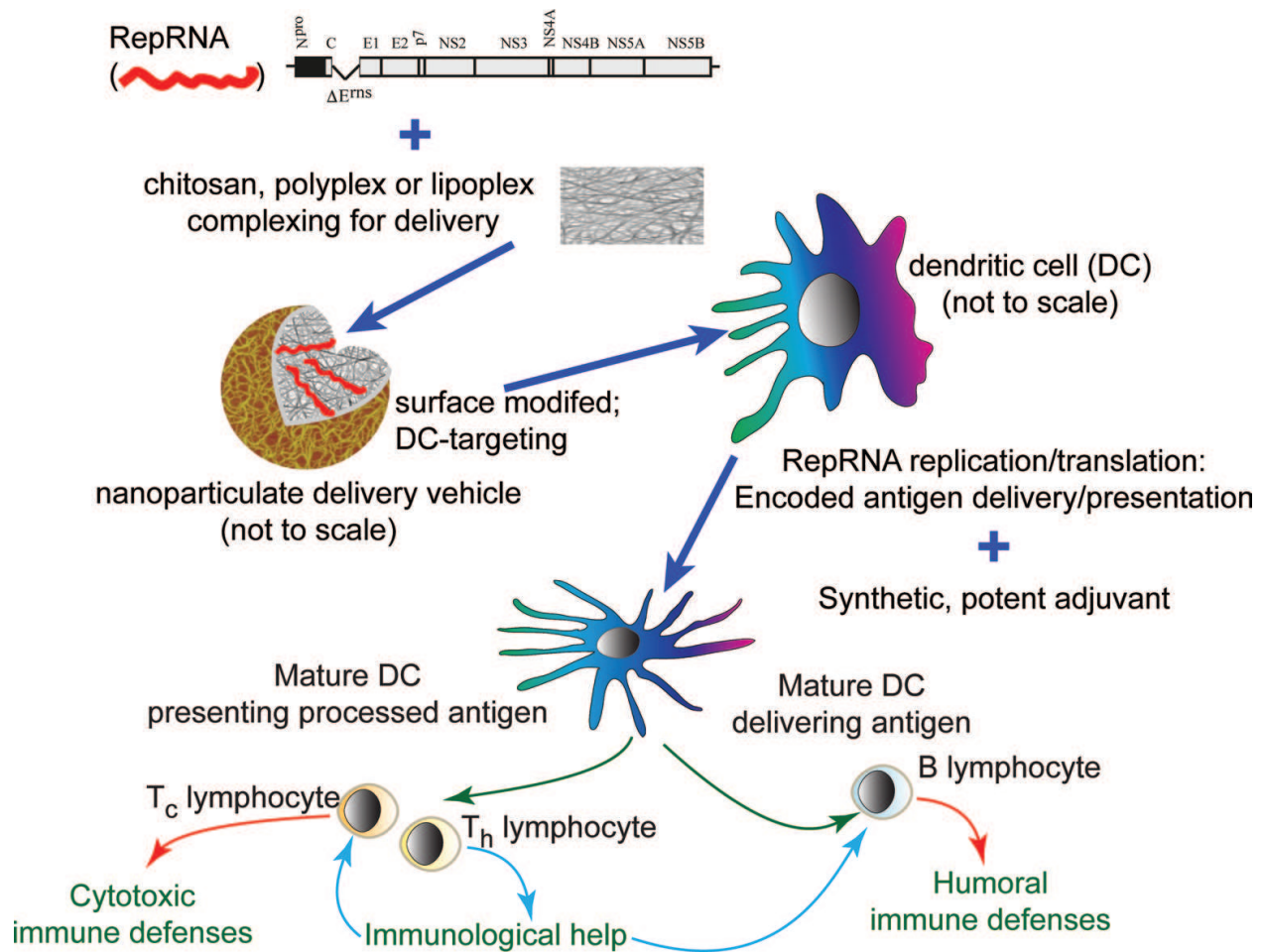

Figure 8. Overview of the procedures for association of RepRNA vaccines with biodegradable nanoparticulate delivery vehicles, targeting DCs to promote induction of both humoral and cytotoxic immune defences.

of compaction obtained by a single cationic entity. Certainly, the presence of cationic lipids in a chitosan-based nanoparticulate delivery vehicle with RepRNA enhanced both the *in vitro* translation of the delivered RNA, and the induction of humoral and CMI immune defences *in vivo* (Figure 7; Figure 8) [18].

10. Conclusion: dendritic cell endocytosis promoting cross-presentation and RNA translation

Dendritic cells, in particular the cDC1 subset, display the capacity for cross-presentation of exogenous antigenic material (Figure 1). Using SVLPs, DCs primarily endocytose these vaccines via macropinocytosis, but an underlying additional endocytic process is also active [14]. While a dominant processing towards MHC Class II presentation is evident, cross-presentation pathways also exist, directing the processing towards MHC Class I presentation [15]. Importantly, these SVLPs do not activate the DC family to promote DC maturation which is essential for efficient induction of adaptive immunity. By modifying the lipopeptide

monomers of the SVLPs to carry TLR2 ligands, certain SVLPs are directed into internal TLR2-containing sites for induction of cytokines that are important for DC maturation [15].

The endocytic processes involved in the cytosolic translocation of endocytosed antigen also relate to the delivery of RNA required for translation. RNA vaccines and the genomes of RNA viruses must translocate from the endosomal system or ER (retrograde transport) following endocytosis, to facilitate delivery into cytosolic sites of ribosomal translation (**Figure 3**). With viruses, this can be promoted by the interaction of viral surface proteins with the endosomal membrane, becoming modified upon acidification by early endosome to create ion channels and/or pores in the membrane for cytosolic transfer of the RNA genomes. RNA vaccines can employ similar strategies, when the RNA is packaged within virus-like particles, which can be seen with self-amplifying replicon RNA vaccine delivery as VRPs. With synthetic RNA vaccines, delivered by synthetic nanoparticulate delivery vehicles rather than VRPs or other virus-like particles (**Figure 7**), translocation must occur as the interaction of the RNA with its delivery vehicle becomes weakened to the point of promoting decompaction. There is a critical point of no return, with cytosolic translocation being vital before late endosomal activity dominates. Therefore, the delivery vehicle formulation must facilitate endosomal membrane modification to permit this cytosolic translocation at the appropriate stage of endosomal maturation.

An important issue pertinent to nanoparticle delivery is the size of the delivery vehicle being endocytosed. Size and ionic potential of particles interacting with cells, particularly DCs and M Φ , influence both the endocytic route and how the cell handles internalised material [43, 58]. The smaller the entity the greater the role played by retrograde transport from endocytic vesicles into the ER [58]. Macropinocytosis and caveolar endocytic delivery to the ER may occur without interaction with early endosomes, or shortly after acidification begins (**Figure 3**). Nonetheless, if the delivery vehicle is designed to promote cytosolic translocation and even decompaction when present in an acidifying environment, then RNA delivery should be directed into macropinosomes and caveolar vesicles interacting with early endosomes.

Overall, self-amplifying RepRNA delivery to DCs has high potential for future vaccine development and application, providing controlled and efficacious vaccine delivery, and thus promoting robust immune defence induction (**Figure 8**). Of particular importance is the appropriate application of nanoparticulate delivery vehicle formulations to enhance cytosolic translocation of RNA vaccines in DC, while reducing compaction to ensure ribosomal entry for translation of the encoded vaccine antigens and self-amplification of the replicon RNA.

Acknowledgements

This work was supported by the following: EU FP7 project UniVax [grant number 601738]; Swiss National Science Foundation (SNF) project Replicon-DC [grant number 310030_150008]; Marie-Curie Action FP7-PEOPLE-2009-IAAP, 'Replixcel' [grant number 251420]; EU FP6 project PANFLUVAC [grant number 044115]; ERA-NET projects HCVAX (EuroNanoMed/Swiss

National Science Foundation) [grant number 31NM30-136034/1] and HCRus (University of Geneva, Switzerland) [grant number ERANetRUS 081]; SNF project NANOVACC [grant number 310000_1198828]. We are also most grateful to Brigitte Herrmann for help with the PBMC work and confocal microscopy, and to Andreas Michel and Hans-Peter Lüthi for animal care and bleeding of donor animals for the PBMCs. We are also most grateful to Arin Ghasparian and John A. Robinson (Department of Chemistry, University of Zürich, and Virometix AG, Zurich, Switzerland) for preparing and providing the SVLPs.

Author details

Kenneth C. McCullough^{1*} and Rajni Sharma²

*Address all correspondence to: kmc.projects1@gmail.com

¹ Immunology Department, Institute of Virology and Immunology, Mittelhäusern, Switzerland

² Immunology-Vaccinology, Faculty of Veterinary Medicine, University of Liège, Liège, Belgium

References

- [1] Steinman RM. The dendritic cell system and its role in immunogenicity. *Annual Review of Immunology*. 1991;**9**:271–296. doi: 10.1146/annurev.iy.09.040191.001415.
- [2] Steinman RM, Pack M, Inaba K. Dendritic cells in the T-cell areas of lymphoid organs. *Immunological Reviews*. 1997;**156**:25–37.
- [3] Banchereau J, Steinman RM. Dendritic cells and the control of immunity. *Nature*. 1998;**392**:245–252. doi: 10.1038/32588.
- [4] Banchereau J, Briere F, Caux C, Davoust J, Lebecque S, Liu YJ, Pulendran B, Palucka K. Immunobiology of dendritic cells. *Annual Review of Immunology*. 2000;**18**:767–811. doi: 10.1146/annurev.immunol.18.1.767.
- [5] Medzhitov R, Janeway C, Jr. Innate immune recognition: mechanisms and pathways. *Immunological Reviews*. 2000;**173**:89–97.
- [6] Mellman I, Steinman RM. Dendritic cells: specialized and regulated antigen processing machines. *Cell*. 2001;**106**:255–258.
- [7] Steinman RM, Pope M. Exploiting dendritic cells to improve vaccine efficacy. *Journal of Clinical Investigation*. 2002;**109**:1519–1526. doi: 10.1172/JCI15962.
- [8] Steinman RM, Banchereau J. Taking dendritic cells into medicine. *Nature*. 2007;**449**:419–426. doi: 10.1038/nature06175.
- [9] McCullough KC, Bassi I, Demoulins T, Thomann-Harwood LJ, Ruggli N. Functional RNA delivery targeted to dendritic cells by synthetic nanoparticles. *Therapeutic Delivery*. 2012;**3**:1077–1099.

- [10] Steinman RM, Hemmi H. Dendritic cells: translating innate to adaptive immunity. *Current Topics in Microbiology and Immunology*. 2006;**311**:17–58.
- [11] Geissmann F, Manz MG, Jung S, Sieweke MH, Merad M, Ley K. Development of monocytes, macrophages and dendritic cells. *Science*. 2010;**327**:656–661.
- [12] Steinman RM. Decisions about dendritic cells: past, present, and future. *Annual Review of Immunology*. 2012;**30**:1–22. doi: 10.1146/annurev-immunol-100311-102839.
- [13] McCullough KC, Milona P, Thomann-Harwood L, Demoulin T, Englezou P, Suter R, Ruggli N. Self-amplifying replicon RNA vaccine delivery to dendritic cells by synthetic nanoparticles. *Vaccines*. 2014;**2**:735–754.
- [14] Sharma R, Ghasparian A, Robinson JA, McCullough KC. Synthetic virus-like particles target dendritic cell lipid rafts for rapid endocytosis primarily but not exclusively by macropinocytosis. *PLoS One*. 2012;**7**:e43248. doi: 10.1371/journal.pone.0043248.
- [15] Sharma R, Ghasparian A, Robinson JA, McCullough KC. Dendritic cell sensing of hydrophobic di- and triacylated lipopeptides self-assembled into synthetic virus-like particles. *Journal of Immunology*. 2017 (under second review).
- [16] Ghasparian A, Riedel T, Koomullil J, Moehle K, Gorba C, Svergun DI, Perriman AW, Mann S, Tamborrini M, Pluschke G, Robinson JA. Engineered synthetic virus-like particles and their use in vaccine delivery. *Chemical Biochemistry*. 2011;**12**:100–109. doi: 10.1002/cbic.201000536.
- [17] Demoulin T, Milona P, Englezou PC, Ebensen T, Schulze K, Suter R, Pichon C, Midoux P, Guzman CA, Ruggli N, McCullough KC. Polyethylenimine-based polyplex delivery of self-replicating RNA vaccines. *Nanomedicine*. 2016;**12**:711–722.
- [18] McCullough KC, Bassi I, Milona P, Suter R, Thomann-Harwood L, Englezou P, Démoulin T, Ruggli N. Self-replicating replicon-RNA delivery to dendritic cells by chitosan-nanoparticles for translation *In vitro* and *in vivo*. *Molecular Therapy Nucleic Acids*. 2014;**3**:e173.
- [19] McCullough KC, Tirelli N. Next generation vaccines; knocking on cell's door. *Pan European Networks: Science and Technology*. 2012;**4**:108–109.
- [20] Tratschin JD, Ruggli N, McCullough KC. Pestivirus replicons providing an RNA-based viral vector system. PCT/EP2009/003892; WO 2009146867; US 2011/0189224. 2008.
- [21] Conner SD, Schmid SL. Regulated portals of entry into the cell. *Nature*. 2003;**422**:37–44. doi: 10.1038/nature01451.
- [22] Kumari S, Mg S, Mayor S. Endocytosis unplugged: multiple ways to enter the cell. *Cell Research*. 2010;**20**:256–275. doi: 10.1038/cr.2010.19.
- [23] Sandvig K, Pust S, Skotland T, van Deurs B. Clathrin-independent endocytosis: mechanisms and function. *Current Opinion in Cell Biology*. 2011;**23**:413–420. doi: 10.1016/j.ceb.2011.03.007.
- [24] Scott CC, Vacca F, Gruenberg J. Endosome maturation, transport and functions. *Seminars in Cell and Developmental Biology*. 2014;**31**:2–10. doi: 10.1016/j.semcd.2014.03.034.

- [25] Vazquez-Calvo A, Saiz JC, McCullough KC, Sobrino F, Martin-Acebes MA. Acid-dependent viral entry. *Virus Research*. 2012;**167**:125–137. doi: 10.1016/j.virusres.2012.05.024.
- [26] Lu L, Hong W. From endosomes to the trans-Golgi network. *Seminars in Cell and Developmental Biology*. 2014;**31**:30–39. doi: 10.1016/j.semcdb.2014.04.024.
- [27] Mallard F, Antony C, Tenza D, Salamero J, Goud B, Johannes L. Direct pathway from early/recycling endosomes to the Golgi apparatus revealed through the study of shiga toxin B-fragment transport. *Journal of Cell Biology*. 1998;**143**:973–990.
- [28] Sandvig K, van Deurs B. Delivery into cells: lessons learned from plant and bacterial toxins. *Gene Therapy*. 2005;**12**:865–872. doi: 10.1038/sj.gt.3302525.
- [29] Soldati T, Schliwa M. Powering membrane traffic in endocytosis and recycling. *Nature Reviews Molecular Cell Biology*. 2006;**7**:897–908. doi: 10.1038/nrm2060.
- [30] Schuette V, Burgdorf S. The ins-and-outs of endosomal antigens for cross-presentation. *Current Opinion in Immunology*. 2014;**26**:63–68. doi: 10.1016/j.coi.2013.11.001.
- [31] Shete HK, Prabhu RH, Patravale VB. Endosomal escape: a bottleneck in intracellular delivery. *The Journal of Nanoscience and Nanotechnology*. 2014;**14**:460–474.
- [32] Zehner M, Burgdorf S. Regulation of antigen transport into the cytosol for cross-presentation by ubiquitination of the mannose receptor. *Molecular Immunology*. 2013;**55**:146–148. doi: 10.1016/j.molimm.2012.10.010.
- [33] Englezou PC, Milona P, Démoulines T, Sapet C, Ebensen T, Guzman C-A, Suter R, Zelphati O, Ruggli N, McCullough K. Cationic lipids efficiently deliver self-amplifying RepRNA for translation in DC and monocytes. *Molecular Therapy*. 2017; submitted for publication.
- [34] McCullough KC, Ruggli N. Inducing Immunity. *International Innovation*. 2013;**June** 2013:90–92.
- [35] Démoulines T, Englezou PC, Milona P, Ruggli N, Tirelli N, Pichon C, Sapet C, Ebensen T, Guzman C-A, McCullough KC. Self-replicating RNA vaccine delivery to dendritic cells. In T. Kramps and K. Elbers (editors). *RNA Vaccines: Methods and Protocols*. Springer Science+Business Media, New York, 2017; vol 1499; pp 37–75.
- [36] Perche F, Benvegna T, Berchel M, Lebegue L, Pichon C, Jaffrès P-A, Midoux P. Enhancement of dendritic cells transfection in vivo and of vaccination against B16F10 melanoma with mannosylated histidylated lipopolyplexes loaded with tumor antigen messenger RNA. *Nanomedicine*. 2011;**7**:445–453.
- [37] Pichon C, Midoux P. Mannosylated and histidylated LPR technology for vaccination with tumor antigen mRNA. *Methods in Molecular Biology*. 2013;**969**:247–274. doi: 10.1007/978-1-62703-260-5_16.
- [38] Amigorena S, Savina A. Intracellular mechanisms of antigen cross presentation in dendritic cells. *Current Opinion in Immunology*. 2010;**22**:109–117.

- [39] Ackerman AL, Kyritsis C, Tampé R, Cresswell P. Access of soluble antigens to the endoplasmic reticulum can explain cross-presentation by dendritic cells. *Nature Immunology*. 2004;**6**:107–113.
- [40] Heath W, Belz G, Behrens GMN, Smith CM, Forehan SP, Parish IA, Davey GM, Wilson NS, Carbone FR, Villadangos JA. Cross-presentation, dendritic cell subsets, and the generation of immunity to cellular antigens. *Immunological Reviews*. 2004;**199**:9–26.
- [41] Ikeuchi N, Futami j, Hosoi A, Noji S, Kurachi M, Ueha S, Fujii S-i, Yamada H, Matsushima K, Moriyasu F, Kakimi K. Efficient cross-presentation of soluble exogenous antigens introduced into dendritic cells using a weak-based amphiphilic peptide. *Biochemical and Biophysical Research Communications*. 2010;**392**(2):217–22 submitted.
- [42] Mant A, Chinnery F, Elliott T, Williams AP. The pathway of cross-presentation is influenced by the particle size of phagocytosed antigen. *Immunology*. 2012;**136**:163–175. doi: 10.1111/j.1365-2567.2012.03558.x.
- [43] Monu N, Trombetta ES. Cross-talk between the endocytic pathway and the endoplasmic reticulum in cross-presentation by MHC class I molecules. *Current Opinion in Immunology*. 2007;**19**:66–72.
- [44] Le Roux D, Le Bon A, Dumas A, Taleb K, Sachse M, Sikora R, Julithe M, Benmerah A, Bismuth G, Niedergang F. Antigen stored in dendritic cells after macropinocytosis is released unprocessed from late endosomes to target B cells. *Blood*. 2011;**119**:95–105.
- [45] Wykes M, Pombo A, Jenkins C, MacPherson GG. Dendritic cells interact directly with naive B lymphocytes to transfer antigen and initiate class switching in a primary T-dependent response. *Journal of Immunology*. 1998;**161**:1313–1319.
- [46] Blankenstein T, Schuler T. Cross-priming versus cross-tolerance: are two signals enough? *Trends in Immunology*. 2002;**23**:171–173.
- [47] Duan W, Croft M. Control of regulatory T cells and airway tolerance by lung macrophages and dendritic cells. *Annals of the American Thoracic Society*. 2014;**11 Suppl 5**:S306-313. doi: 10.1513/AnnalsATS.201401-028AW.
- [48] Lewis KL, Reizis B. Dendritic cells: arbiters of immunity and immunological tolerance. *Cold Spring Harbor Perspectives in Biology*. 2012;**4**:a007401. doi: 10.1101/cshperspect.a007401.
- [49] Lutz MB, Kurts C. Induction of peripheral CD4⁺ T-cell tolerance and CD8⁺ T-cell cross-tolerance by dendritic cells. *European Journal of Immunology*. 2009;**39**:2325–2330. doi: 10.1002/eji.200939548.
- [50] Moser M. Dendritic cells in immunity and tolerance-do they display opposite functions? *Immunity*. 2003;**19**:5–8.
- [51] Quah BJ, O'Neill HC. Maturation of function in dendritic cells for tolerance and immunity. *Journal of Cellular and Molecular Medicine*. 2005;**9**:643–654.
- [52] Rescigno M. Dendritic cells in oral tolerance in the gut. *Cellular Microbiology*. 2011;**13**:1312–1318. doi: 10.1111/j.1462-5822.2011.01626.x.

- [53] Steinman RM. Dendritic cells: understanding immunogenicity. *European Journal of Immunology*. 2007;**37** **Suppl 1**:S53-60. doi: 10.1002/eji.200737400.
- [54] Steinman RM, Swanson J. The endocytic activity of dendritic cells. *Journal of Experimental Medicine*. 1995;**182**:283–288.
- [55] Platta HW, Stenmark H. Endocytosis and signaling. *Current Opinion in Cell Biology*. 2011;**23**:393–403.
- [56] Sorkin A, von Zastrow M. Endocytosis and signalling: intertwining molecular networks. *Nature Reviews Molecular Cell Biology*. 2009;**10**:609–622. doi: 10.1038/nrm2748.
- [57] Burgdorf S, Kurts C. Endocytosis mechanisms and the cell biology of antigen. *Current Opinion in Immunology*. 2008;**20**:89–95.
- [58] Jensen PE. Recent advances in antigen processing and presentation *Nature Immunology*. 2007;**8**:1041–1048.
- [59] Gallucci S, Matzinger P. Danger signals: SOS to the immune system. *Current Opinion in Immunology*. 2001;**13**:114–119.
- [60] Wagner JG, Roth RA. Neutrophil migration mechanisms, with an emphasis on the pulmonary vasculature. *Pharmacological Reviews*. 2000;**52**:349–374.
- [61] Medzhitov R, Janeway C, Jr. The Toll receptor family and microbial recognition. *Trends in Microbiology*. 2000;**8**:452–456.
- [62] Pulendran B, Ahmed R. Translating innate immunity into immunological memory: Implications for vaccine development. *Cell*. 2006;**124**:849–863.
- [63] Rossi D, Zlotnik A. The biology of chemokines and their receptors. *Annual Review of Immunology*. 2000;**18**:217–242. doi: 10.1146/annurev.immunol.18.1.217.
- [64] Dzopalic T, Rajkovic I, Dragicevic A, Colic M. The response of human dendritic cells to co-ligation of pattern-recognition receptors. *Immunologic Research*. 2012;**52**:20–33. doi: 10.1007/s12026-012-8279-5.
- [65] Ouasti S, Kingham PJ, Terenghi G, Tirelli N. The CD44/integrins interplay and the significance of receptor binding and re-presentation in the uptake of RGD-functionalized hyaluronic acid. *Biomaterials*. 2011;**33**:1120–34.
- [66] van der Goot FG, Gruenberg J. Oiling the wheels of the endocytic pathway. *Trends in Cell Biology*. 2002;**12**:296–299.
- [67] Kaisho T. Pathogen sensors and chemokine receptors in dendritic cell subsets. *Vaccine*. 2012;**30**:7652–7657. doi: 10.1016/j.vaccine.2012.10.043.
- [68] Kawai T, Akira S. Toll-like receptor and RIG-I-like receptor signaling. *Annals of the New York Academy of Sciences*. 2008;**1143**:1–20. doi: 10.1196/annals.1443.020.
- [69] Watts C, West MA, Zaru R. TLR signalling regulated antigen presentation in dendritic cells. *Current Opinion in Immunology*. 2010;**22**:124–130.

- [70] Takeuchi O, Akira S. Innate immunity to virus infection. *Immunological Reviews*. 2009; **277**:75–86.
- [71] Ceppi M, Ruggli N, Tache V, Gerber H, McCullough KC, Summerfield A. Double-stranded secondary structures on mRNA induce type 1 interferon (IFN α/β) production and maturation of mRNA-transfected monocyte-derived dendritic cells. *Journal of Gene Medicine*. 2005; **7**:452–465.
- [72] Martina BE. Dengue pathogenesis: a disease driven by the host response. *Science Progress*. 2014; **97**:197–214.
- [73] Teijaro JR. The role of cytokine responses during influenza virus pathogenesis and potential therapeutic options. *Current Topics in Microbiology and Immunology*. 2015; **386**:3–22. doi: 10.1007/82_2014_411.
- [74] Tisoncik JR, Korth MJ, Simmons CP, Farrar J, Martin TR, Katze MG. Into the eye of the cytokine storm. *Microbiology and Molecular Biology Reviews*. 2012; **76**:16–32. doi: 10.1128/MMBR.05015-11.
- [75] McCullough KC, Ruggli N, Summerfield A. Dendritic cells—at the front-line of pathogen attack. *Veterinary Immunology and Immunopathology*. 2009; **128**:7–15. doi: 10.1016/j.vetimm.2008.10.290.
- [76] Diaz-San Segundo F, Rodriguez-Calvo T, de Avila A, Sevilla N. Immunosuppression during acute infection with foot-and-mouth disease virus in swine is mediated by IL-10. *PLoS One*. 2009; **4**:e5659. doi: 10.1371/journal.pone.0005659.
- [77] Summerfield A, Guzylack-Piriou L, Harwood L, McCullough KC. Innate immune responses against foot-and-mouth disease virus: current understanding and future directions. *Veterinary Immunology and Immunopathology*. 2009; **128**:205–210. doi: 10.1016/j.vetimm.2008.10.296.
- [78] Pelkmans L, Helenius A. Endocytosis via caveolae. *Traffic*. 2002; **3**:311–320.
- [79] Bonifacino JS, Lippincott-Schwartz J. Coat proteins: shaping membrane transport. *Nature Reviews Molecular Cell Biology*. 2003; **4**:409–414. doi: 10.1038/nrm1099.
- [80] Kirchhausen T. Clathrin. *Annual Review of Biochemistry*. 2000; **69**:699–727. doi: 10.1146/annurev.biochem.69.1.699.
- [81] Marsh M, Helenius A. Virus entry: open sesame. *Cell*. 2006; **124**:729–740. doi: S0092-8674(06)00182-6 [pii], 10.1016/j.cell.2006.02.007.
- [82] Rust MJ, Lakadamyali M, Zhang F, Zhuang X. Assembly of endocytic machinery around individual influenza viruses during viral entry. *Nature Structural & Molecular Biology*. 2004; **11**:567–573. doi: 10.1038/nsmb769, nsmb769 [pii].
- [83] Sandvig K, Olsnes S, Brown JE, Petersen OW, van Deurs B. Endocytosis from coated pits of Shiga toxin: a glycolipid-binding protein from *Shigella dysenteriae* 1. *Journal of Cell Biology*. 1989; **108**:1331–1343.

- [84] Morris RE, Gerstein AS, Bonventre PF, Saelinger CB. Receptor-mediated entry of diphtheria toxin into monkey kidney (Vero) cells: electron microscopic evaluation. *Infection and Immunity*. 1985;**50**:721–727.
- [85] Abrami L, Bischofberger M, Kunz B, Groux R, van der Goot FG. Endocytosis of the anthrax toxin is mediated by clathrin, actin and unconventional adaptors. *PLoS Pathogens*. 2010;**6**:e1000792. doi: 10.1371/journal.ppat.1000792.
- [86] Watts C. Capture and processing of exogenous antigens for presentation on MHC molecules. *Annual Review of Immunology*. 1997;**15**:821–850. doi: 10.1146/annurev.immunol.15.1.821.
- [87] de Baey A, Lanzavecchia A. The role of aquaporins in dendritic cell macropinocytosis. *Journal of Experimental Medicine*. 2000;**191**:743–748.
- [88] Sallusto F, Cella M, Danieli C, Lanzavecchia A. Dendritic cells use macropinocytosis and the mannose receptor to concentrate macromolecules in the major histocompatibility complex class II compartment: downregulation by cytokines and bacterial products. *Journal of Experimental Medicine*. 1995;**182**:389–400.
- [89] Racoosin EL, Swanson JA. Macropinosome maturation and fusion with tubular lysosomes in macrophages. *Journal of Cell Biology*. 1993;**121**:1011–1020.
- [90] Hewlett LJ, Prescott AR, Watts C. The coated pit and macropinocytic pathways serve distinct endosome populations. *Journal of Cell Biology*. 1994;**124**:689–703.
- [91] Schnatwinkel C, Christoforidis S, Lindsay MR, Uttenweiler-Joseph S, Wilm M, Parton RG, Zerial M. The Rab5 effector Rabankyrin-5 regulates and coordinates different endocytic mechanisms. *PLoS Biology*. 2004;**2**:E261. doi: 10.1371/journal.pbio.0020261.
- [92] Lutz MB, Rovere P, Kleijmeer MJ, Rescigno M, Assmann CU, Oorschot VM, Geuze HJ, Trucy J, Demandolx D, Davoust J, Ricciardi-Castagnoli P. Intracellular routes and selective retention of antigens in mildly acidic cathepsin D/lysosome-associated membrane protein-1/MHC class II-positive vesicles in immature dendritic cells. *Journal of Immunology*. 1997;**159**:3707–3716.
- [93] Falnes PO, Sandvig K. Penetration of protein toxins into cells. *Current Opinion in Cell Biology*. 2000;**12**:407–413. doi: S0955-0674(00)00109-5 [pii].
- [94] Lamaze C, Dujeancourt A, Baba T, Lo CG, Benmerah A, Dautry-Varsat A. Interleukin 2 receptors and detergent-resistant membrane domains define a clathrin-independent endocytic pathway. *Molecular Cell*. 2001;**7**:661–671. doi: S1097-2765(01)00212-X [pii].
- [95] Pelkmans L, Burli T, Zerial M, Helenius A. Caveolin-stabilized membrane domains as multifunctional transport and sorting devices in endocytic membrane traffic. *Cell*. 2004;**118**:767–780. doi: 10.1016/j.cell.2004.09.003, S0092867404008335 [pii].
- [96] Schnitzer JE, Oh P, Pinney E, Allard J. Filipin-sensitive caveolae-mediated transport in endothelium: reduced transcytosis, scavenger endocytosis, and capillary permeability of select macromolecules. *Journal of Cell Biology*. 1994;**127**:1217–1232.

- [97] Herreros J, Ng T, Schiavo G. Lipid rafts act as specialized domains for tetanus toxin binding and internalization into neurons. *Molecular Biology of the Cell*. 2001;12:2947–2960.
- [98] Shogomori H, Futerman AH. Cholera toxin is found in detergent-insoluble rafts/ domains at the cell surface of hippocampal neurons but is internalized via a raft-independent mechanism. *Journal of Biological Chemistry*. 2001;276:9182–9188. doi: 10.1074/jbc.M009414200, M009414200 [pii].
- [99] Anderson HA, Chen Y, Norkin LC. Bound simian virus 40 translocates to caveolin-enriched membrane domains, and its entry is inhibited by drugs that selectively disrupt caveolae. *Molecular Biology of the Cell*. 1996;7:1825–1834.
- [100] Lencer WI, Hirst TR, Holmes RK. Membrane traffic and the cellular uptake of cholera toxin. *Biochimica et Biophysica Acta*. 1999;1450:177–190. doi: S0167-4889(99)00070-1 [pii].
- [101] Tran D, Carpentier JL, Sawano F, Gorden P, Orci L. Ligands internalized through coated or noncoated invaginations follow a common intracellular pathway. *Proceedings of the National Academy of Sciences of the United States of America*. 1987;84:7957–7961.
- [102] Orlandi PA, Fishman PH. Filipin-dependent inhibition of cholera toxin: evidence for toxin internalization and activation through caveolae-like domains. *Journal of Cell Biology*. 1998;141:905–915.
- [103] Nichols BJ, Lippincott-Schwartz J. Endocytosis without clathrin coats. *Trends in Cell Biology*. 2001;11:406–412. doi: S0962-8924(01)02107-9 [pii].
- [104] Falguières T, Mallard F, Baron C, Hanau D, Lingwood C, Goud B, Salamero J, Johannes L. Targeting of Shiga toxin B-subunit to retrograde transport route in association with detergent-resistant membranes. *Molecular Biology of the Cell*. 2001;12:2453–2468.
- [105] Pelkmans L, Kartenbeck J, Helenius A. Caveolar endocytosis of simian virus 40 reveals a new two-step vesicular-transport pathway to the ER. *Nature Cell Biology*. 2001;3:473–483. doi: 10.1038/35074539.
- [106] Midoux P, Pichon C, Yaouanc J-J, Jaffrès P-A. Chemical vectors for gene delivery: a current review on polymers, peptides and lipids containing histidine or imidazole as nucleic acids carriers. *British Journal of Pharmacology*. 2009;157:166–178.
- [107] Varkouhi AK, Scholte M, Storm G, Haisma HJ. Endosomal escape pathways for delivery of biologicals. *Journal of Controlled Release*. 2011;151:220–228.
- [108] Won Y-W, Lim KS, Kim Y-H. Intracellular organelle-targeted non-viral gene delivery systems. *Journal of Controlled Release*. 2011;152:99–109.
- [109] Nakase I, Kobayashi S, Futaki S. Endosome-disruptive peptides for improving cytosolic delivery of bioactive macromolecules. *Biopolymers: Peptide Science*. 2010;94:763–770.

- [110] Wasungu L, Hoekstra D. Cationic lipids, lipoplexes and intracellular delivery of genes. *Journal of Controlled Release*. 2006;116:255–264.
- [111] Vyas JM, Van der Veen AG, Ploegh HL. The known unknowns of antigen processing and presentation. *Nature Reviews Immunology*. 2008;8:607–618.
- [112] Belizaire R, Unanue ER. Targeting proteins to distinct subcellular compartments reveals unique requirements for MHC class I and II presentation. *Proceedings of the National Academy of Sciences*. 2009;106:17463–17468.
- [113] Neefjes J, Jongsma ML, Paul P, Bakke O. Towards a systems understanding of MHC class I and MHC class II antigen presentation. *Nature Reviews Immunology*. 2011;11:823–836. doi: 10.1038/nri3084.
- [114] McCullough KC, Milona P, Démoulin T, Englezou P, Ruggli N. Dendritic Cell Targets for Self-Replicating RNA Vaccines. *Journal of Blood and Lymph*. 2015;5:132. epub 10.4172/2165-7831.1000132. doi: 10.4172/2165-7831.1000132.
- [115] Atkins GJ, Fleeton MN, Sheahan BJ. Therapeutic and prophylactic applications of alphavirus vectors. *Expert Reviews in Molecular Medicine*. 2008;10:e33. doi: 10.1017/S1462399408000859.
- [116] Khromykh AA. Replicon-based vectors of positive strand RNA viruses. *Current Opinion in Molecular Therapy*. 2000;2:555–569.
- [117] Rayner JO, Dryga SA, Kamrud KI. Alphavirus vectors and vaccination. *Reviews in Medical Virology*. 2002;12:279–296. doi: 10.1002/rmv.360.
- [118] Suter R, Summerfield A, Thomann-Harwood LJ, McCullough KC, Tratschin JD, Ruggli N. Immunogenic and replicative properties of classical swine fever virus replicon particles modified to induce IFN- α / β and carry foreign genes. *Vaccine*. 2011;29:1491–1503. doi: 10.1016/j.vaccine.2010.12.026.
- [119] Lundstrom K. Alphavirus-based vaccines. *Current Opinion in Molecular Therapy*. 2002;4:28–34.
- [120] Pijlman GP, Suhrbier A, Khromykh AA. Kunjin virus replicons: an RNA-based, non-cytopathic viral vector system for protein production, vaccine and gene therapy applications. *Expert Opinion on Biological Therapy*. 2006;6:135–145. doi: 10.1517/14712598.6.2.135.
- [121] Ljungberg K, Liljestrom P. Self-replicating alphavirus RNA vaccines. *Expert Review Vaccines*. 2015;14:177–194. doi: 10.1586/14760584.2015.965690.
- [122] McCullough KC. Combatting disease. pan European networks: Science and Technology. 2014;11:168–169.
- [123] Demoulin T, Bassi I, Thomann-Harwood L, Jandus C, Kaeuper P, Simon HU, von Gunten S, McCullough KC. Alginate-coated chitosan nanogel capacity to modulate the effect of TLR ligands on blood dendritic cells. *Nanomedicine*. 2013;9:806–817. doi: 10.1016/j.nano.2013.01.002.